

A SYSTEMATIC APPROACH TO ANALYZING PRE-CLOSURE OPERATIONAL  
PERFORMANCE OF THE PROPOSED REPOSITORY FOR HIGH-LEVEL  
NUCLEAR WASTE AT YUCCA MOUNTAIN, NV

By

Leah Spradley

Dissertation

Submitted to the Faculty of the  
Graduate School of Vanderbilt University  
in partial fulfillment of the requirements

for the degree of

DOCTOR OF PHILOSOPHY

In

Interdisciplinary Studies: Environmental Management

May, 2008

Nashville, Tennessee

Approved:

Professor Mark Abkowitz

Professor James H. Clarke

Professor David S. Kosson,

Professor Frank L. Parker

Professor Michael G. Stabin

Dr. B. John Garrick

Dr. Michael T. Ryan

This work is dedicated to my loving mother,  
who has given me the strength and courage to pursue my dreams,  
and in memory of my father,  
who encouraged me to lived life to its fullest.

## ACKNOWLEDGEMENT

The information presented in this report is based in part on work supported by the U.S. Department of Energy, under Cooperative Agreement Number DE-FC01-06EW07053, entitled ‘The Consortium for Risk Evaluation with Stakeholder Participation III’, awarded to Vanderbilt University. The opinions, findings, conclusions, or recommendations expressed herein are those of the author(s) and do not necessarily represent the views of the Department of Energy or Vanderbilt University.

I acknowledge the support of the National Science Foundation, through an Integrated Graduate Education Research and Training (IGERT) grant, and of Bridgestone Firestone of Americas, through the Bridgestone of Americas Fellowship. I thank my Dissertation Advisers, Dr. Mark Abkowitz and Dr. James H. Clarke, and the remainder of my Committee, including Dr. B. John Garrick, Dr. David S. Kosson, Dr. Frank L. Parker, Dr. Michael T. Ryan, and Dr. Michael G. Stabin, for their advice and guidance. I also acknowledge the assistance offered by members and staff of the Nuclear Waste Technical Review Board, including Gene Rowe, Dr. Bruce Kirstein, and Dr. John Pye. In addition, data support provided by John Thorpe, a DOE contractor, as well as Dr. Tina Gosh, Albert Wong, and John Buckley from the Nuclear Regulatory Commission, is much appreciated.

This report was prepared as an account of work sponsored by an Agency of the United States Government. Neither the United States Government nor any agency thereof, nor any of their employees, makes any warranty, express or implied, or assumes any legal liability or responsibility for the accuracy, completeness, or usefulness of any

information apparatus, product, or process disclosed, or represents that its use would not infringe privately owned rights. Reference herein to any specific commercial product, process, or service by trade name, trademark, manufacturer, or otherwise does not necessarily constitute or imply its endorsement, recommendation, or favoring by the United States Government or any agency thereof.

# TABLE OF CONTENTS

|   | Page |
|---|------|
| ACKNOWLEDGEMENT .....   | iii  |
| LIST OF TABLES .....  | vii  |
| LIST OF FIGURES .....   | viii |
| LIST OF ABBREVIATIONS.....  | x    |
| Chapter   |      |
| I. INTRODUCTION .....   | 1    |
| Current State of Commercial Spent Nuclear Fuel in the United States ..... | 1    |
| Yucca Mountain Legislative History .....                                  | 8    |
| Yucca Mountain Repository Design History .....                            | 12   |
| Problem Statement .....   | 16   |
| Research Objectives.....  | 19   |
| Organization and Content of Dissertation.....                             | 20   |
| II. EVALUATING PRE-CLOSURE OPERATING STRATEGIES .....                     | 24   |
| Abstract .....  | 24   |
| Introduction.....   | 25   |
| Research Objectives.....  | 33   |
| Analysis Methodology .....  | 34   |
| Discussion of Results .....   | 54   |
| Conclusions and Recommendations .....                                     | 66   |
| III. SAFETY CONSIDERATIONS.....   | 67   |
| Abstract .....  | 67   |
| Introduction.....   | 69   |
| Research Objectives.....  | 74   |
| Review of Pre-Closure Preliminary Hazards Analysis.....                   | 75   |
| Analysis Methodology .....  | 90   |
| Discussion of Results.....  | 97   |
| Conclusions and Recommendations .....                                     | 110  |

|   |     |
|---|-----|
| IV. SURFACE FACILITY THROUGHPUT WASTE STREAM VARIATIONS.. | 113 |
| Abstract.....   | 113 |
| Introduction.....   | 114 |
| Research Objectives.....                                  | 118 |
| Review of DOE Surface Facility Criteria .....             | 118 |
| Analysis Methodology .....                                | 129 |
| Discussion of Results.....                                | 132 |
| Conclusions and Recommendations .....                     | 148 |
| V. SUMMARY .....  | 156 |
| Conclusions.....  | 157 |
| Recommendations For Future Research .....                 | 160 |
| VI. REFERENCES .....                                      | 163 |
| Appendix  |     |
| A. MODEL DESCRIPTION .....                                | A-1 |
| B. T-TEST RESULTS .....                                   | B-1 |
| C. SURFACE FACILITY TRANSFERS.....                        | C-1 |
| D. WM2008 CONFERENCE PAPER.....                           | D-1 |
| E. THERMAL POWER DATA TABLES .....                        | E-1 |
| F. MODEL OUTPUT DATA TABLES .....                         | F-1 |

## LIST OF TABLES

| Table  | Page |
|--|------|
| 1. Line Load Waste Package Sequence .....  | 30   |
| 2. Spent Fuel Annual Capacity and Acceptance Priority Ranking Summary.....             | 41   |
| 3. Independent Variable Values.....  | 47   |
| 4. Scenario Definitions.....   | 48   |
| 5. Total Effective Dose Equivalent (TEDE) Regulatory Limits.....                       | 73   |
| 6. DOE Alternative Waste Stream Comparisons.....                                       | 79   |
| 7. Expected Waste Stream Quantities.....   | 80   |
| 8. Number of Transfers per Item at Surface Facilities.....                             | 85   |
| 9. Expected Number of Drops in 50-year Pre-Closure Period.....                         | 86   |
| 10. Dose Consequence per Event.....  | 89   |
| 11. Comparison of Approaches for Generating Waste Streams .....                        | 91   |
| 12. Independent Deterministic Variable Values .....                                    | 94   |
| 13. Scenario Definition .....  | 95   |
| 14. Scenarios Resulting in Minimum and Maximum Number of Transfers.....                | 102  |
| 15. Range in Number of Transfers.....  | 103  |
| 16. Number of Events Needed to Occur in a Single Year to Exceed Category 1 Limits..... | 109  |
| 17. Receipt Rate for Yucca Mountain.....   | 117  |
| 18. Initial Surface Facility Performance Requirements for TAD Concept.....             | 121  |
| 19. New Surface Facility Performance Requirements for TAD Concept.....                 | 126  |
| 20. Proposed Alternative Annual Throughput Criteria Design .....                       | 154  |

## LIST OF FIGURES

| Figure   | Page |
|--|------|
| 1. Logic flow diagram for packaging waste into dry storage at utility sites before YM opens. ....  | 38   |
| 2. Process flow for distribution of allocations for shipments. ....  | 43   |
| 3. Yucca Mountain repository surface facilities process flow logic.....  | 50   |
| 4. Cumulative number of dry storage containers loaded before 2030 (also shown as percentage of total capacity, or 7,500 TADs, to be emplaced in YM). ....  | 56   |
| 5. Effect of trading allocations (yes or no) on expected aggregate demand for storage at the waste generation sites in the year that YM reaches current legal capacity in terms of number of 21-PWR or 44-BWR sized containers for each subscenario (R1-R9), showing the range of values and the means. .... | 59   |
| 6. Effect of trading allocations (yes or no) on the number of pools sending shipments in a given year for each subscenario (R1-R9), showing the range of values and the means.....   | 61   |
| 7. Impact of thermal emplacement limit on the above-ground aging requirements at YM. Cell means and ranges of the OFF, YFF10 and YFF5 scenarios are shown for each year. ....  | 63   |
| 8. Effect of trading allocations (yes or no) on demand for the Aging Facility at YM for each subscenario (R1-R9), showing the range of values and the means.....   | 65   |
| 9. Variability in the number of item transfers under different scenarios for design and operating conditions: (a) TAD, (b) DPC, and (c) bare-fuel assembly. ....   | 99   |
| 10. Expected number of occurrences of a drop over the 50-year pre-closure period assuming a crane drop failure rate of $1 \times 10^{-5}$ : (a) TAD, (b) DPC, and (c) bare-fuel assembly. ....   | 105  |
| 11. Expected number of occurrences of a drop over the 50-year pre-closure period assuming a crane drop failure rate of $6 \times 10^{-5}$ : (a) TAD, (b) DPC, and (c) bare-fuel assembly. Note the change in x-axis in (c). ....   | 106  |



|     |  |     |
|-----|--|-----|
| 12. | Annual demand and standard deviation in annual demand for the CRCF grouped by scenario subset and waste selection order.....                 | 134 |
| 13. | Annual demand and standard deviation in annual demand for the RF grouped by scenario subset and waste selection order.....                   | 136 |
| 14. | Annual demand and standard deviation in annual demand for the Aging Facility grouped by scenario subset and waste selection order. ....      | 137 |
| 15. | Annual demand and standard deviation in annual demand for DPCs in the WHF grouped by scenario subset and waste selection order.....          | 139 |
| 16. | Annual demand and standard deviation in demand for bare-fuel assemblies in the WHF grouped by scenario subset and waste selection order..... | 140 |
| 17. | Percentage of time facility is over capacity for the CRCF, RF, and WHF.....  | 142 |
| 18. | Percentage of TADs above the thermal emplacement limit of 11.8 kW .....  | 144 |
| 19. | Annual demand for the (a) CRCF and (b) RF according to waste selection order. ....   | 146 |
| 20. | Sum of demand for the CRCF and the RF assuming a thermal emplacement limit of 11.8 kW.....   | 147 |

## LIST OF ABBREVIATIONS

|         |  |
|---------|--|
| APR/ACR | Allocation Priority Ranking and Annual Capacity Report |
| AF      | Aging Facility   |
| BWR     | Boiling Water Reactor                                  |
| CRWMS   | Civilian Radioactive Waste Management System           |
| CSNF    | Commercial Spent Nuclear Fuel                          |
| CALVIN  | CRWMS Analysis and Logistics Visually Interactive      |
| CRCF    | Canister Receipt and Closure Facility                  |
| DCS     | Delivery Commitment Schedule                           |
| DOE     | U.S. Department of Energy                              |
| DPC     | Dual-Purpose Canister                                  |
| EIS     | Environmental Impact Statement                         |
| IHF     | Initial Handling Facility                              |
| ISFSI   | Independent Spent Fuel Storage Installation            |
| ITS     | Important to Safety                                    |
| LA      | License Application                                    |
| MTHM    | Metric Tons of Heavy Metal                             |
| NAS     | National Academy of Sciences                           |
| NRC     | U.S. Nuclear Regulatory Commission                     |
| NWPA    | Nuclear Waste Policy Act                               |
| NWTRB   | Nuclear Waste Technical Review Board                   |
| OFF     | Oldest Fuel First                                      |
| OWS     | 2002 Operational Waste Stream                          |
| PWR     | Pressurized Water Reactor                              |
| RF      | Receipt Facility                                       |
| RMEI    | Reasonably Maximally Exposed Individual                |
| SNF     | Spent Nuclear Fuel                                     |
| SPC     | Single-purpose Cask                                    |
| TAD     | Transport, Aging, and Disposal Canister                |
| TSLCC   | Total System Life Cycle Cost Waste Stream              |
| TSM     | Total System Model                                     |
| TSMPP   | Total System Model Pre-Processor                       |
| TSPA    | Total System Performance Assessment                    |
| WHF     | Wet Handling Facility                                  |
| WP      | Waste Package  |
| YFF     | Youngest Fuel First                                    |
| YM      | Yucca Mountain   |

# CHAPTER I

## INTRODUCTION

### **Current State of Commercial Spent Nuclear Fuel in the United States**

#### *Description of Commercial Spent Nuclear Fuel*

Radioactive waste has accumulated due to government operations, including nuclear weapons production, the commercial generation of nuclear power, as well as the medical and industrial application of radioisotopes. The Nuclear Waste Policy Act (NWPA) of 1982 § 2(12) defines high-level waste as the byproducts of irradiated spent nuclear fuel (42 USC § 10101 (2008)). Commercial spent nuclear fuel (CSNF), representing the vast quantity of spent fuel, is fuel that has been irradiated in a commercial nuclear power reactor to the point that it is no longer economically efficient for use. When fuel assemblies reach this point, they are discharged from the reactor core and stored under water at the reactor site in spent fuel pools.

It is important to isolate CSNF from humans and the environment because it is highly radioactive and potentially harmful. When first discharged, an assembly typically generates tens of kilowatts of heat from decaying radionuclides. As the shorter-lived radionuclides decay, the heat produced drops by a factor of 100 for the first year, and by another factor of 5 by the end of the 5<sup>th</sup> year (NAS 2006b). Ten years after it has been removed, the radiation dose rate from standing one meter away from a typical spent fuel assembly exceeds 200 Sv (20,000 rem) per hour (NRC 2002). While radioactivity

diminishes rapidly in the first few years as the shorter-lived radionuclides decay, many of the radioactive elements in spent fuel have long half-lives and remain potentially harmful for long periods of time (e.g., plutonium-239 has a half-life of 24,000 years). Therefore, it must be safely isolated for thousands of years. However, the spent nuclear fuel pools, where the majority of the waste is housed, are only considered temporary storage solutions.

The pool at each commercial reactor was not designed to hold all the spent fuel generated by the reactor over its lifetime. The original intention was to temporarily store the CSNF until it could be sent for reprocessing. However, due to proliferation concern and the inexpensive cost of uranium, the nation's waste management strategy moved away from reprocessing. Only one commercial reprocessing facility had been built in West Valley, NY and this facility ceased operations in 1972 (Salvatori 1996). The suspension of reprocessing was lifted under the Reagan Administration, but no new commercial reprocessing facilities have been built, mostly for economic reasons. To alleviate the load on spent fuel pools, some utilities have implemented on-site and off-site dry cask storage. Although removal of assemblies after only one year is legally permitted, standard industry practice is to leave the assemblies in the pool for at least 5 years before moving them to dry storage (NAS 2006b).

As of 2007, the United States had generated approximately 56,000 MTHM (metric tons of heavy metal) of CSNF from its 100 plus currently operating reactors. Reactors are licensed to operate for 40 years, with an option to apply for a 20-year license extension. Assumptions regarding projected energy trends and the number of license renewals must be made in order to estimate future inventories of commercial spent

nuclear fuel. One projection for total discharges that assumes all of the currently operating reactors are granted the 20-year extensions and run for 60 years, estimates there will be approximately 129,400 MTHM of spent nuclear fuel (BSAIC 2003). The United States (U.S.) inventory of spent fuel may increase beyond this estimate, depending on construction of new reactors. Although there has not been an order for a new plant in 30 years, the nuclear industry is currently preparing to build new reactors. Four applications for combined construction and operating licenses were submitted in 2007, and more are expected in coming years (NEI 2008).

Currently, approximately 15% of the nation's CSNF is in dry storage. The remaining 85% is in spent fuel pools. Storage in spent fuel pools is implemented at the 65 operating reactor sites as well as 8 sites where reactors are no longer operating. While dry storage currently exists at only 22 operating reactor sites and 6 non-operating reactor sites, it is estimated that over the next 17 years, approximately 3 to 4 pools will reach full capacity each year (NAS 2006b).

### ***Dry Cask Storage of Commercial Spent Nuclear Fuel***

When fuel is taken out of the pool, it can be placed in a variety of dry storage containers, referred to as casks. Dry casks are made of steel or concrete and can be categorized as bare-fuel or canistered-fuel systems. The difference in these terms has to do with how fuel assemblies are loaded into the casks. In a bare-fuel system, the basket in which the spent fuel assemblies are placed is integrated into the outer wall of the cask. The lid of a bare-fuel cask is bolted closed. In a canistered system, the assemblies are

placed inside a thin-walled canister which is then welded shut and placed inside an overpack with a bolted lid for storage or transportation (NAS 2006a).

Single Purpose Casks (SPCs) are usually of the bare-fuel category, and are licensed either for storage *or* transport, whereas Dual-Purpose Canisters (DPCs) are licensed for storage *and* transport. Casks used for transportation must be licensed under 10 CFR § 71, while casks used for storage are licensed under 10 CFR § 72. The containers are initially licensed for a 20-year period, but with Nuclear Regulatory Commission (NRC) approval, the license could be renewed for another 20 to 40 years. While casks vary in size and capacity, they generally hold up to 10-15 MTHM, which is equivalent to about 32 pressurized water reactor (PWR) assemblies or 68 boiling water reactors (BWR) assemblies (NAS 2006b). Criteria for each assembly that is loaded in dry casks, such as a maximum limit for thermal power output and burnup, are defined for each cask variety. Decay heat limits are typically lower for transportation than for storage.

In addition to the cask itself being licensed by the NRC, a waste generator must have a license to store dry casks on-site. The Spent Fuel Projects Office within the NRC offers two types of licenses for storing fuel: one that is applicable to all reactors that have a general license under 10 CFR § 50 (2008), and one that is referred to as a “site-specific” license in 10 CFR § 72.6 (2008). All away-from-reactor storage sites, referred to as Independent Spent Fuel Storage Facilities (ISFSI), must have a site-specific license (10 CFR § 72.6 (2008)). If the spent fuel is on-site, the waste generator can use a general license as long as it meets the requirements for fuel storage (10 CFR § 72 (2008)). If these conditions are met, the waste generator does not need to apply for a site-specific license (10 CFR § 72.6 (2008)).

### ***Waste Confidence Rulemaking***

The NRC has verified that current systems for storage are safe for an extended length of time (NRC 1984) . However, there is consensus among experts that the best solution for *permanently* storing the waste is deep, geologic disposal as is determined in the National Academy of Sciences *Report on the Disposal of Radioactive Waste on Land* (NAS/NRC 1957) and more recently affirmed in the *Environmental Impact Statement, Management of Commercially Generated Radioactive Waste* (DOE 1980).

In 1984, NRC held a rulemaking, referred to as the Waste Confidence Rulemaking, to determine the Commission's confidence in the safe permanent disposal of waste, the timing of when a disposal facility would be available, and whether waste could be stored safely in the meantime. The Commission concluded that sufficient repository capacity would be available by the years 2007-2009, and that waste could be stored safely, without significant environmental impacts for at least 30 years beyond the expiration of a reactor's operating license (NRC 1984).

The Waste Confidence decision was updated in 1990 to state that CSNF can be stored safely without significant environmental impact for at least 100 years, and that there is reasonable assurance that at least one deep geologic repository would be available by 2025 (NRC 1990). In 2005, in response to a petition filed by the State of Nevada, the NRC reaffirmed that there is reasonable assurance that a repository will be available by 2025, and that sufficient capacity would be made available for safely storing waste on-site or off-site without significant environmental impact for an extended period of time (NRC 2005).

Although waste can be stored safely for an extended period of time above ground, the U.S. federal government, through the Department of Energy (DOE), has been pursuing the use of a deep, geologic repository for permanent disposal of the nation's high-level nuclear waste. The availability of a repository will reduce the demand for on-site dry storage, but projections show that most commercial plants will run out of space in their pools before a repository is in operation (NAS 2006b). Thus, in coming years, dry cask storage will be necessary at many of the utility sites.

One option for storage that has been considered in conjunction with a repository, to accommodate waste in the meantime, is one or more centralized, federal storage sites. A 1984, National Research Council study recognized that attention should be given to the managerial and socioeconomic impacts of storing spent fuel above ground at reactors or at away-from-reactor sites, and that there was an incomplete body of knowledge that could help decision makers implement radioactive waste management systems. Among the findings was the need for further research to better determine the "above-ground" impacts (i.e., cost and equity) involved with various waste management strategies (NAS/NRC 1984).

The benefits and costs of federal interim storage, referred to as Monitored Retrievable Storage (MRS), were analyzed by a federally appointed commission in 1989. Results of this study indicated that a small capacity, interim storage facility would be useful, but not a large-volume one. The Commission found no safety advantage over the MRS alternative, and that no single factor favored the use of an MRS. The Commission, however, did recommend authorization of a 2,000 metric ton capacity federal emergency storage facility, and privately funded storage facility with a capacity of 5,000 metric tons.



The Commission also suggested that Congress re-examine the interim storage subject by the year 2000, noting that federal interim storage might become more economical if the repository were delayed (Radin et. al. 1989). Private consolidated interim storage sites, such as the project led by Private Fuel Storage, LLC (a consortium of eight electric utility companies) and the Skull Valley Band of Goshute Indians in Skull Valley, Utah, have also been pursued, but none are in operation today (PFS 2001). This is mostly due to political opposition from local, state, and Native American tribal governments at the sites and along transportation routes (NAS 2006a).

Today, there is talk of reconsidering consolidated interim storage, but no legislation has been passed. The rationale for this is to solve the “waste confidence” issue, to stop the litigation between DOE and the utilities resulting from DOE’s failure to take title to the waste as it was supposed to do no later than 1998, and to expedite the decommissioning of shut-down reactors so as to reduce the expenses associated with prolonged decommissioning.

However, once again, an evaluation of interim storage showed no sufficient advantages unless the repository is delayed. As noted, there are no “substantive safety or security reasons...no compelling cost savings unless Yucca Mountain is delayed”, and there is “sufficient space” at the sites where waste is currently stored (APS 2007). Whether or not consolidated interim storage will be economical in the future is not clear. After all, the 1989 study predicted that there may be economic benefit to interim storage if Yucca Mountain were delayed, but the 2007 study found no cost savings even though YM has been delayed well beyond its expected opening date of 1998. Still, the 2007 technical and programmatic assessment of consolidated storage asserts that consolidated

storage may facilitate decommissioning, as well as diminish a potential obstacle to licensing new nuclear power plants (APS 2007).

### ***Reprocessing***

In addition to direct geologic disposal, the federal government (through the DOE) and some commercial entities are considering reprocessing spent nuclear fuel. DOE has been researching reprocessing technologies under its Advanced Fuel Cycle Initiative for several years, and recently the agency proposed a fairly aggressive timeline for commercial-scale production of reprocessing facilities under the Global Nuclear Energy Program (GNEP) (DOE 2006c). Development of such facilities would decrease the volume and radiotoxicity of the final high-level waste product, but there would still be a need for a geologic repository to dispose of the reprocessed waste. Thus, even though there are alternative options for managing the waste in the interim, the U.S. government is actively pursuing deep geologic disposition, with the option for retrieving the waste, as a way to dispose of the waste.

## **Yucca Mountain Legislative History**

### ***Nuclear Waste Policy Act***

The NWPA tasked DOE with siting, building, and operating one or more deep geologic repositories for the country's spent nuclear fuel and high-level nuclear waste (42 USC § 10101 (2008)). Section 304 established the Office of Civilian Radioactive Waste

Management as a part of DOE and a process was developed for investigating and approving potential repository sites. The Nuclear Waste Fund was also established in §302. Waste generators pay into the Nuclear Waste Fund at the rate of a mil per kWhr in exchange for DOE taking title to the waste.

In 1984, DOE issued draft environmental impact statements for nine potential repository sites it had identified (DOE 2002). The sites, comprised of a variety of geologic formations and geographical locations, were: (1) Hanford, Washington, (2) Yucca Mountain, Nevada, (3) Deaf Smith County, Texas, (4) Davis Canyon, Utah, (5) Richton Dome, Mississippi, (6) Cypress Creek Dome, Mississippi, (7) Lavender Canyon, Utah, (8) Vachene Dome, Louisiana, and (9) Swisher Site, Texas (DOE 2002).

In 1986, Secretary of Energy Herrington nominated five of the nine sites (1-5). Three of those sites (Hanford, WA, Yucca Mountain, NV, and Deaf Smith County, TX) were recommended to President Reagan, who approved a full characterization of the three sites (Abraham 2002). In 1987, Congress amended the NWPA and mandated that DOE focus efforts exclusively on Yucca Mountain, NV (YM) (NWPA § 160(a), 42 USC § 10101 (2008)). In February, 2002 Secretary Abraham recommended the site to President George W. Bush, after which he approved the site (Abraham 2002). Although the State of Nevada vetoed the President's approval, Congress overrode the veto. The final legislative vote confirming the suitability of a repository at YM was cast on July 9, 2002. Subsequently, President Bush signed House Joint Resolution 87, approving the site (H.J. Res. 87, 107<sup>th</sup> Cong. (2002)).

### ***Licensing Process***

The licensing of YM is carried out in three separate phases: authorization for construction, approval of a license to receive the waste, and then an approval of an amendment to the license in order to decommission and permanently close the disposal facility (42 USC 10101 § 405 (2008)). The procedures for licensing (i.e., initial acceptance review, extensive technical review, opportunity for public comment, and public hearings) remain the same for each phase of the process. For example, before DOE can begin constructing the repository, it must be granted authorization for construction by the NRC. DOE has stated that it expects to submit a License Application (LA) sometime in 2008 (Sproat 2007). The primary technical document in the LA is a safety analysis report, which must demonstrate that the repository will be built and operated to adequately protect public and worker health and safety, as well as to be designed to preserve the local environment. Once submitted, NRC will determine if the application is suitable for performing a detailed technical review. If the LA is deemed sufficiently complete, NRC will docket the application and commence an extensive technical review. The technical review will determine if the repository will meet the regulations in 10 CFR § 63.

During this time, there will be opportunities for affected parties to file contentions having to do with the repository and to participate in hearings. Hearings will be conducted by a panel appointed by NRC, referred to as the Atomic Safety and Licensing Board. After NRC completes its review, and the Board finishes processing contentions, hearings will take place. After all contentions and responses have been heard, the Board will issue its decision regarding construction. If the decision is favorable, and is not

overturned by the NRC Commissioners or the appellate court, construction can begin. Once construction of the repository is nearly complete, the second phase of licensing YM will begin with DOE's request for a license to receive waste. Because the license review and hearings are expected to take several years, the earliest estimate for opening the repository is 2017 (Williams 2006).

### ***Standard Contract***

The NWPA authorized the Secretary of Energy to develop an agreement with the owners and generators of spent fuel (10 CFR § 961 (2008)). The guidelines set forth in the *Standard Contract* for the acquisition of spent nuclear fuel and its transportation to the repository have potential to impact repository design. The *Standard Contract* requires spent fuel to be at least five years old to qualify to be sent to YM, but is not as specific about the particular timeline of shipments.

For every year after the repository starts accepting waste, there is a specified allocation, measured in metric tons, which each waste generator, called "Purchaser", is expected to send. The term Purchaser is used because spent fuel generators have been purchasing the services of DOE by paying into the Nuclear Waste Fund. A single Purchaser may own one or more reactor facilities, depending on the size of the Purchaser's corporation. Allocations given to each waste generator are detailed in the *Acceptance Priority Ranking (APR) and Annual Capacity Report (ACR)* (DOE 2004). The queuing order is based on the date spent nuclear fuel was permanently discharged, giving priority to the oldest spent nuclear fuel on an industry-wide basis. This order is

combined with the annual rate of acceptance for YM to calculate yearly allocations for each Purchaser (DOE 2004).

Allocations in the *APR/ACR Report* are not contractually binding on either DOE or the Purchasers. Instead, they are meant to assist Purchasers' planning and submittal of Delivery Commitment Schedules (DCS), which specify what fuel they intend to send and the delivery dates for shipments. Legal requirements of the DCS allow for negotiations between Purchasers and DOE, as outlined in Article V of the *Standard Contract*, until six months before the date of delivery. Purchasers are also permitted to *exchange* allocations with other Purchasers, as long as DOE approves of the exchange (10 CFR § 961 (2008))

Unfortunately, because the allocations for waste shipments do not obligate Purchasers to send their oldest fuel first, and there is opportunity for altering schedules up to six months before the delivery date, it is difficult for DOE to accurately predict the age of the fuel that will be sent at the time when it is designing the repository. Uncertainty regarding the age of fuel assemblies that are shipped is important to the thermal management strategy for repository design during the "pre-closure" phase of Yucca Mountain, the operational phase of the repository during which waste is transported to and emplaced in the repository, but kept retrievable. Post-closure involves repository behavior after the emplacement drifts have been closed.

### **Yucca Mountain Repository Design History**

The Final Environmental Impact Statement (FEIS) for YM discusses design alternatives regarding a number of factors for pre-closure operations and the layout of the

repository, including packaging, transportation, ventilation, and emplacement drift spacing. Of the designs, two packaging alternatives for pre-closure were considered by DOE in the FEIS: (1) the waste would be mostly canistered in DPCs and (2) the waste would be mostly uncanistered in bare-fuel transportation casks. In both alternatives, DOE would have had to handle *all* assemblies as bare-fuel at the YM surface facilities in order to load them into final waste packages since DPCs are not designed for long-term disposal (DOE 2002).

In order to reduce the number of bare-fuel handlings required at YM, DOE announced a change in design, requiring the operators of facilities in possession of spent nuclear fuel to use a Transport, Aging and Disposal (TAD) canister to transport CSNF to YM (DOE 2006b). Even with the TAD design, spent fuel assemblies arriving at YM in DPCs will need to be repackaged into TADs.

### ***Licensing and Design of the TAD***

Since the TAD will be used in a variety of applications, it will be governed by several regulations. For example, a TAD loaded at a nuclear power plant will be governed by 10 CFR § 50. If the TAD is placed in an ISFSI for interim storage, it will be regulated under 10 CFR § 72. A TAD placed in a certified overpack and transported is licensed under 10 CFR § 71, while a TAD placed in an overpack for aging at YM will fall under 10 CFR § 63. To ensure that the TAD is developed according to the requirements of 10 CFR § 63, DOE, as opposed to the vendors, specifies the design of the canister. This is important because it implies that DOE has considerable influence over the design of the TAD. The design specifications for the TAD, released by DOE in 2007, are intended to guide

vendors as they prepare license applications for the TAD under 10 CFR § 71 (transportation) and 10 CFR § 72 (storage) (Shah 2006).

The design specifications released by DOE do not stipulate a specific thermal limit for transportation or storage, but rather provide cladding temperature determination for total thermal outputs of 11.8 kW, 18 kW or 25 kW. Once the TAD is licensed under 10 CFR § 71 and § 72, utilities can begin using it for storage and transportation. DOE will submit a license application under 10 CFR § 63, which will describe the use of the TAD in overall repository design. NRC will determine if the TAD is important to safety in its review of the LA. Specifically, the agency will determine if there are attributes of the TAD that are important to waste isolation, and also if there are attributes of the design that have a detrimental effect on post-closure performance (Shah 2006).

### ***Motivation for the TAD Decision***

The decision to use the TAD is motivated by the fact that utilities have more experience in handling and packaging CSNF, and that the number of handlings of bare-fuel assemblies at YM would be reduced considerably. In preliminary dose calculations for the surface facility where assemblies would have been transferred (Dry Transfer Facility), the ALARA<sup>1</sup> goal of 5 mSv (500 mrem) per year for normal operations was not met for the cask waste/receipt operator and the health physics worker. Specifically, cask waste/receipt operators and health physics technicians were estimated to receive a total effective dose equivalent (TEDE) of 18 mSv (1800 mrem) per year, and 8 mSv (800

---

<sup>1</sup> All worker and public exposures to ionizing radiation must be kept as low as reasonably achievable (ALARA) (10 CFR § 20.0011(2008))



mrem) per year, respectively, due to direct radiation from contained sources (BSAIC 2004a).

Furthermore, because of the large number of assembly handlings, the drop of an assembly had a rate of 0.5 events/yr and 9.7 expected drops<sup>2</sup> over the 50-year pre-closure period of operations (BSAIC 2005a). The consequence analysis conservatively assumed that 100 percent of the fuel rod cladding is breached in the event of a drop, and that each CSNF assembly would undergo four (4) transfers. The expected aggregated dose from normal operations and the drop events that were expected to occur at least once during the 50-year pre-closure period was 0.022 Sv (2.2 rem)/yr (BSAIC 2005c). This dose is within the regulatory limit of 0.05 Sv (5 rem), but the design was reconsidered to reduce the number of assembly transfers.

Usage of the TAD will lower the cost of DOE facilities, reduce low-level waste production, decrease risk of worker dose at DOE facilities, and simplify DOE operations (Kouts 2006b). Still, there is uncertainty as to the ultimate impact of the TAD decision since the canister is yet to be commercially deployed and adopted for use by the utilities. Some speculate that the advantages may not counterbalance the operational inefficiencies of a smaller and potentially costlier container. After all, a similar concept involving a multi-purpose canister was proposed in 1992 and then dismissed in 1995 because it was considered too costly (DOE 1996). The cost of the surface facilities at the repository may

---

<sup>2</sup> Based on 221,000 total assemblies over pre-closure, at a maximum rate of 12,628 assemblies/year and a drop rate of  $10^{-5}$  drops per transfer. A conservative factor of 1.1 is included and each assembly is assumed to be transferred 2 times.

be lowered, but the TAD canister itself is expected to be more expensive than the casks currently in use.<sup>3</sup>

Assuming DOE does not pay for the TAD, using it would impose additional cost on the utilities. Under the *Standard Contract*, paying for on-site storage remains the responsibility of the utilities until DOE takes title to the waste (10 CFR § 961 (2008)). Contracts would need to be renegotiated if DOE is to cover the costs of the TAD. Renegotiations may be complicated since several utilities are currently in litigation with DOE over its failure to take title to the waste by the 1998 deadline. As of 2006, 60 cases were still pending before the courts (NAS 2006b). Even though the perspectives of the utilities vary, the Nuclear Energy Institute (NEI), an industry policy organization, has expressed that there is a general desire to facilitate success of the TAD concept since it is viewed as pivotal to assuring progress on Yucca Mountain (McCullum 2006).

## **Problem Statement**

### ***Safety Considerations***

While use of the TAD would most likely reduce dose risk for workers at YM, the extent that dose risk is reduced for DOE workers depends heavily on the percentage of fuel that arrives in TADs. Dose risk is expected to decrease for YM workers with the use of the TAD because the number of uncanistered CSNF assembly crane lifts is reduced.

---

<sup>3</sup> Personal communication with Adam Levin, Director Spent Fuel and Decommissioning Strategy, Exelon Generation Company. December, 2006.

Assuming that 90% of spent fuel arrives in TADs, the number of lifts is reduced by a factor of 20 (Tooker and Dunn 2006). Utilities will not desire to repackage the waste that is already in DPCs because it would expose their workers to additional risk. The safety case and overall effectiveness of the TAD rests with the assumption that 90% of the 63,000 metric tons of CSNF to be emplaced in YM will arrive in TADs (DOE 2006d). As stated, approximately 15% of CSNF is already in on-site dry cask storage, either in DPCs or SPCs.

### ***Surface Facility Throughput Considerations***

Use of the TAD also creates a potential problem in terms of surface facility throughput. Before any final disposal package, referred to as a Waste Package (WP), can be emplaced in YM, its total thermal power output (kW) must fall below a specified thermal emplacement limit. The thermal emplacement limit for each WP is defined as 11.8 kW in YM design documents, but ongoing studies are exploring the possibility of easing this constraint up to 18 kW, or even higher (BSAIC 2005d). Any packages not meeting the specified limit must be stored above ground at YM until the contents cool to a value below the thermal emplacement limit.

The Nuclear Waste Technical Review Board (NWTRB) has expressed concern that the decision to use the TAD canister may impact the thermal management strategy of pre-closure operations, mainly due to the fact that the utilities, as opposed to DOE, will now decide how to blend fuel assemblies into the *final* disposition canisters. The utilities' discretion to blend fuel to their preferences greatly reduces DOE's control over the

thermal power outputs of the packages as they are being prepared for emplacement in the mountain (NWTRB 2006).

There are potential inefficiencies in the existing method for allocating shipments that stem from use of the TAD. The existing method, as stipulated in the *Standard Contract*, was developed prior to the TAD decision, and therefore does not adequately consider the ability of the utilities to co-mingle hot and cold assemblies according to DOE's thermal management strategy. This critical decision introduces uncertainty regarding the thermal power output of the WPs, causing potential for a highly variable need for aging at YM.

The amount of waste aging above ground at YM is likely to be a contentious issue during the LA hearing process. The Nuclear Waste Policy Act, as amended, prohibits selecting Nevada as the site of a Monitored Retrievable Storage (MRS) facility. The NWPA §145(g) states that, "no monitored retrievable storage facility authorized pursuant to §142(b) may be constructed in the State of Nevada." If the aging pad falls under the legal definition of an MRS, then it could be argued that DOE, in designating Yucca Mountain as the site for it, has failed to follow the site selection criteria for a proposed MRS (NWPA, as amended, §145(g) -§142(b) , 42 USC § 10101 (2008)).

If the aging pad does not fall under the definition of an MRS, it could be argued that it is an ISFSI. ISFISI's, as defined under 10 CFR § 72.3, require a stand-alone Environmental Impact Statement (EIS) for construction. In this case, DOE's failure to provide an EIS for the aging pad could be construed as neglecting the requirements of the National Environmental Policy Act of 1969 (42 USC § 4332(c) (2008); 40 CFR §1508.27 (2008)).

The aging pad could be interpreted as part of geologic repository operations, causing it to be governed under 10 CFR § 63. The NWPA § 2(18) defines "repository" as including incidental areas for "handling activities" (42 USC § 10101 (2008)). Long-term aging of the waste may or may not be considered a "handling activity". This legal question is still to be determined. The critical determination that will be played out in the hearings is whether cooling of the spent fuel on a large scale is integral to the operation of the repository.

Ideally, through careful planning, DOE could design the surface buildings such that operations of YM are facilitated and the needs of the waste generators are met in a safe and efficient manner. While DOE is refining its studies to accomplish such objectives, the approaching LA submittal may limit DOE in terms of time and resource constraints. Analyses may be influenced by the tendency to grandfather past studies, assumptions, and models in long-lived, large-scale projects. There is potential benefit from a renewed approach to analyzing the impact on process flow and storage requirements of pre-closure design and operating decisions. This brings motivation for an independent analysis of various pre-closure scenarios that may improve operations with regard to surface facility aging and throughput.

### **Research Objectives**

This research seeks to compare relative "operational performance" of the pre-closure waste management system under various design and implementation approaches regarding utility selection of assemblies for dry storage loading, transportation, aging, and emplacement in relation to the proposed geologic repository for high-level waste at

Yucca Mountain, Nevada. The term operational performance is specific to this dissertation and should not be misinterpreted as the way “pre-closure performance objectives” are defined in 10 CFR § 63.111.

In general, desired operational performance is defined as an approximately steady-rate flow of waste from utility sites to the repository with an appropriate thermal output for emplacement during operating years. More specifically, desired operational performance of the waste management system includes: reducing dry storage requirements at the utility reactor sites, improving the efficiency of the transportation movements, reducing the number of shipment origin locations per year, meeting the receipt-rate goals for YM, and reducing the number of material handlings at the surface facilities. A “scenarios” approach is applied that focuses on key uncertainties, providing a framework for anticipating multiple pre-closure outcomes.

Therefore, objectives of this research are to explore the following:

- What is the relationship between the thermal characteristics of the waste packages and various design and operating conditions?
- Which scenarios result in adverse conditions, e.g., delays in waste acceptance, increased aging requirements, etc.?
- Which scenarios result in improved operational performance, e.g., more efficient packaging and fewer handlings of spent fuel over time?

## **Organization and Content of Dissertation**

Chapters 2, 3, and 4 of this dissertation consist of a series of research papers. Each of these papers either has been or soon will be submitted to a refereed journal for

publication consideration. Although the papers consecutively build upon each other, they can be read as stand-alone documents. For this reason, portions of the background material may be replicated in the respective introduction sections of each chapter. This format may burden the more knowledgeable reader with repeated introductory material, but it may also be useful to readers that prefer to review chapters as stand-alone papers. An overview of the contents of each chapter is provided in the following paragraphs.

Chapter 2 introduces the framework for characterizing YM pre-closure as an integrated system comprised of input assumptions and quantifiable, performance metrics as outputs. The paper describes the modeling tool that was developed for this research and its application to identify scenarios that might improve overall performance. A total of 81 scenarios were explored in this application (see Appendix F for resulting data). These included a method for trading allocations, prioritizing the allocations based on least remaining capacity in the spent nuclear fuel pools at the utility sites. Results indicate that this type of prioritization reduces demands for dry storage at the waste generation sites without adversely impacting the amount of aging required under the youngest fuel first scenarios. Future research is suggested to account for surface facility safety implications and throughput constraints associated with various scenarios.

Chapter 3 and Chapter 4 are a two part series that employ the model to generate waste streams for 162 pre-closure scenarios (see Appendix F for resulting data). The scenarios are characterized with similar parameters to those introduced in Chapter 2, except utility trading of allocations based on least remaining capacity is not carried forward so that results for the expected frequency of a drop and surface facility throughput can be more readily compared with those in DOE safety and throughput design documents.

Allocation trading is still permitted in some scenarios, but only that which is based on age. New functional capability is incorporated into the model that allows for prioritization of waste removal from the dry storage pads at waste generation sites before the spent nuclear fuel pools. The enhanced model is also capable of prioritizing shipments of DPCs before TADs or vice versa when removing waste from the dry storage pads at the generation sites, since utilities that are in possession of both DPCs and TADs will have the opportunity to make such a decision, and it is not obvious how they will behave.

Chapter 3 focuses on the safety implications specific to material handlings of various waste streams by accounting for the expected number of transfers in each scenario. Comparisons are made of the resulting frequency of dropping a TAD, DPC, or bare-fuel assembly to the estimated frequency in DOE's *Preliminary Hazards Analysis*. Results show that DOE's estimate for the frequency of a drop is within the range of likely frequencies but does not conservatively bound the generated results. A probabilistic approach for estimating the frequency of drop events is recommended that could help communicate the risk and contribute to pre-closure analyses.

Chapter 4 focuses on how waste stream variations affect surface facility throughput, namely the rate at which packages are prepared for aging or emplacement in the surface facilities at YM. Annual demand at the surface facilities is estimated under each of the 162 scenarios by applying a simplified process flow scheme to surface operations. The basis for surface facility design and throughput requirements is reviewed by evaluating the current design subject to various waste stream scenarios. The surface design goals of the system are evaluated as to the capability to meet annual demand. Results indicate that



the capacity for the Wet Handling Facility (WHF) may need to be increased in order to efficiently process waste that does not arrive in TADs, unless DOE is able to effectively limit the number of Dual-Purpose canisters and bare-fuel cask shipments. A critique of the current design reveals that there may be benefit derived from systematically accounting for the overlap of transfer capability in the Canister Receipt and Closure Facility (CRCF) and the Receipt Facility (RF). An alternative set of throughput requirements for the surface facilities is proposed.

Chapter 5 provides a summary of major findings from this research. It also discusses some of the broader insights of managing the design of long-lived and large-scale engineering projects such as YM. Additionally, recommendations for future research using the modeling tool that was developed are suggested.

## CHAPTER II

### EVALUATING PRE-CLOSURE OPERATING STRATEGIES

#### **Abstract**

This chapter describes the development and preliminary use of an integrated model to explore the impact of design parameters and operational decisions on storage and transportation aspects of pre-closure activity period for the potential repository at Yucca Mountain (YM), NV. The model provides an opportunity to perform analyses of various YM pre-closure “scenarios”. Storage and transportation aspects of the pre-closure system are evaluated with the goal of identifying important design parameters and understanding system interactions, thereby providing a tool to recognize trade-offs and dependencies between storage demands at the waste generation sites and the repository.

This application of the model explores changes in assumptions regarding the following parameters: (1) year the TAD becomes available, (2) year that YM opens, (3) thermal limit for emplacement, (4) thermal limit for transportation, (5) utility approaches to selecting assemblies for dry storage loading, and (6) capacity of Yucca Mountain.

The response variables measured are the total counts of: (1) dry storage containers loaded due to lack of capacity in the spent nuclear fuel pools, (2) TADs that could potentially be loaded before YM opens assuming utilities begin using the TAD as soon as it is commercially available, (3) pools making shipments to YM each year, (4) years the Aging Facility at YM is required, and (5) containers in the Aging Facility each year.

Analysis results indicate that allowing utilities to trade allocations, prioritizing the trading based on least remaining capacity in the spent nuclear fuel pools, will reduce dry storage demands at the utility sites, decrease the number of pools making shipments each year, and increase the efficiency of the transportation system. This type of prioritization for allocations can provide these improvements without adversely impacting the required aging above ground at YM in the case that younger fuel is sent first. Consequently, there may be incentive for utilities to negotiate the trading of allocations if they wish to reduce their expected dry storage demands. Results also indicate that DOE could reduce above aging at YM by enforcing a lower transportation limit or relaxing the emplacement limit.

## **Introduction**

### ***Yucca Mountain Waste Management System***

For several decades, the U.S. Department of Energy (DOE) has pursued the use of an underground geologic repository at Yucca Mountain (YM), Nevada for permanent disposal of the nation's spent fuel and high-level nuclear waste. The YM project consists of two temporal phases: (1) pre-closure, which may last as long as 300 years of repository operation, and (2) post-closure, which is associated with containment of radionuclides potentially out to one-million years (NAS 1995). Pre-closure operations can be thought of as a "waste management system" defined as all components, facilities, and activities that collectively manage the waste as it is packaged at the generation sites, transported to

the repository, received and processed at the YM surface facilities, and emplaced in the repository.

In the following discussion of the waste management system, the terms canister, cask, container, and waste package will hold specific meanings. Canister is defined as a metal vessel for holding spent nuclear fuel assemblies. A transport, aging, and disposal canister (TAD) is suitable for storage when within an aging overpack or shipping when within a transportation overpack. It is also suitable for disposal when within a corrosion-resistant disposal overpack, in which case it is referred to as a Waste Package (WP). A Dual-Purpose canister (DPC) is suitable for storage when within an aging overpack or shipping when within a transportation overpack, but is not considered to be suitable for disposal. Transportation cask is defined as a vessel for transportation that holds either bare-fuel assemblies or a canister containing bare-fuel assemblies. Dry storage container is defined as a vessel suitable for dry storage of the spent nuclear fuel. A dry storage container may be a TAD in an aging overpack, a DPC within an aging overpack, or a single-purpose container that holds bare-fuel assemblies appropriate for storage but not transportation. The author will refer to a TAD or a DPC within a transportation or aging overpack as simply TAD or DPC when it is clear that the TAD or DPC is being shipped or stored.

Since YM is still in the planning stages, there are many feasible “scenarios” comprised of design and operating assumptions for the waste management system. In the pre-closure phase, temperature is controlled through a thermal management strategy based on the thermal power output (kW) of the fuel at time of emplacement and ventilation of the emplacement drifts.

While much attention has been devoted to subsurface repository behavior, it is becoming clear that additional analysis is needed to address emerging pre-closure matters that are inextricably linked to the thermal power output (kW) of the fuel at time of emplacement, such as waste shipment transportation schedules, dry storage loading practices, and above-ground dry storage capability at YM. The thermal management strategy for the repository rests with the flexibility to select waste packages with the appropriate thermal power output, from those on the surface aging pad, in order to maintain a midpillar region below the boiling point of water (DOE 2002).

The thermal characteristics of the inventory above ground at YM are related to pre-closure operating decisions for package loading and waste acceptance. Numerous studies have been conducted concerning waste emplacement, waste package sequencing and ventilation to achieve the thermal management goals (Ryman 2001; Yang 1999). However, a good understanding of the relationship between thermal requirements for waste emplacement and subsurface and surface storage needs, both above ground at YM and at the waste generation sites, during pre-closure operations has not been demonstrated. Consequently, there is a need for a better understanding of how pre-closure operations and design variables impact these aspects of the pre-closure system.

### ***Thermal Management Strategy***

In order to ensure that the repository behaves as expected in the post-closure environment, criteria for the thermal loading of the repository have been established. There are four maximum thermal criteria: (1) 350°C cladding of the WP, (2) 300°C on the surface of the WP, (3) 200°C on the surface of the drift wall, and (4) 96°C in the

pillars between the drifts. The main factors affecting the initial thermal loading of the repository are: (1) characteristics of spent nuclear fuel such as burnup, enrichment and years out-of-reactor, (2) physical properties and layout of the repository, and (3) operational timing - such as ventilation duration, as well as waste package loading, sequencing and spacing (DOE 2002). Assumptions regarding these factors are fed into thermal hydrological models characterizing the flow of heat, moisture and air during pre-closure and post-closure in the emplacement drift (BSAIC 2005b).

One critical assumption regarding operational timing is the aggregate thermal power of the consecutively placed waste packages averaged over some distance within the repository drifts, referred to as the average thermal line-load. The average line-load at emplacement, currently defined as 1.45 kW, is based on an idealized sequence of seven (7) WPs within the drifts (BSAIC 2005b). This sequence alternates WPs that are expected to have hotter initial heat loads with those that are expected to be cooler upon emplacement in order to control the average thermal load over some distance.

The initial thermal power load is derived from the thermal power given off by six (6) WPs and one-half of the thermal power output of the WP at either end (Table 1). (The designation of one-half of each package at either end should not be misinterpreted as a half-loaded package; the packages are fully loaded, but only half of the thermal load is attributed to the single sequence). The *Monitored Geologic Repository Project Description Document* states there should be a 10 cm spacing between WPs and limits the maximum linear heat load, averaged over a fully loaded emplacement drift at the time of completion of loading an entire drift, to 1.5 kW/m (DOE 2000). Applying a spacing of 0.1 m between each WP in Table 1 causes the total length of the WP sequence to be

approximately 35 meters. Summing the thermal output and dividing by the total WP sequence length results in an average line-load of 1.45 kW/m.

The fuel assemblies in each WP in this sequence are assumed to have cooled for about 25 years out of the reactor at time of emplacement (BSAIC 2005b). The thermal energies at time of emplacement corresponding to this sequence of WPs are used to produce an average thermal decay curve that can be used in models characterizing repository heat load (BSAIC 2005b).

The current thermal management strategy for the repository requires each WP to be below a thermal limit of 11.8 kW, which corresponds to the maximum initial thermal power output required at the time it is emplaced (see Table 1). On-going studies are exploring potential higher values for the emplacement limit (BSAIC 2005d). Above-ground aging at YM is necessary because DOE is unable to ensure that spent fuel arriving at the repository will be cool enough such that it can be directly emplaced. However, if spent fuel could be at or near the emplacement limit upon arrival, aging of a large portion of the fuel would not need to take place *at the repository site*.

DOE has more control over some of the factors that affect thermal loading of the repository (e.g., duration of ventilation) than others (e.g., rock properties). However, it is debatable how much control DOE will exhibit over the age of the fuel when it arrives, and which individual fuel assemblies will be blended into the final waste packages. This apparent lack of control may be a result of the method used to establish waste shipping order and the decision to use a multi-purpose canister for transport, aging (storage), and disposal (TAD).

Table 1

Line Load Waste Package Sequence

| WP Design             | Approximate thermal power output per WP (kW) |
|-----------------------|--|
| ½ 21 PWR <sup>a</sup> | 5.76   |
| 5 HLW Long            | 0.99   |
| 21 PWR                | 11.8   |
| 44 BWR                | 7.38   |
| 44 BWR                | 7.10   |
| 5 HLW Short           | 2.98   |
| 21 PWR                | 11.5   |
| ½ 44 BWR <sup>a</sup> | 3.69   |

See Ref. (BSAIC 2005b)

<sup>a</sup>one-half of the total estimated thermal power output for these WPs are counted as contributing to the waste package sequence



The *Standard Contract* between DOE and the waste generators establishes the order in which DOE will accept spent fuel from the utilities, referred to as “Purchasers” (10 CFR § 961.3 (2008)). The Act specifies that the order be based on the order in which fuel was discharged, but does not specify the actual age of the spent fuel that is to be shipped (10 CFR § 961.11 Article V (2008)). Prior to the TAD concept, spent fuel assemblies were to arrive at YM in transportation casks carrying uncanistered spent fuel assemblies or DPCs. Since assemblies were to be repackaged at YM prior to this decision, the combination of assemblies in a single shipment from any given Purchaser was less important. There is a need to explore potential impacts resulting from the decision to use the TAD, but DOE’s existing analysis tools may be limited in accomplishing this task as described in the following section.

### ***Previous Research***

DOE is currently using and refining a simulation model for assessing pre-closure risk called the Total System Model (TSM). This model was developed by DOE to simulate alternative scenarios of waste management system design and operation. The purpose of TSM is to enable DOE to understand how alternative operational scenarios impact system throughput, cost, and potential dose. TSM is viewed as having considerable potential for more robust analysis (Kouts 2006a).

Unfortunately, DOE may be limited in its ability to fully utilize TSM in addressing important design and operational considerations. This may be in part due to time constraints as well as constraints imposed by the model construct. TSM uses “grandfathered” logic and databases, as well as a number of disparate software programs.

The portion of the model that develops the schedule for waste shipments, called the Total System Model Pre-Processor (TSMPP), is separate from the simulation of transportation and surface facility operation (BSAIC 2004b).

TSMPP is based on previous methods in CRWMS (Civilian Radioactive Waste Management System) Analysis and Logistics Visually Interactive (CALVIN) Model, and thus retains some of the structures and functions no longer necessary for present purposes. While the unused structures or functions most likely do not hinder the accuracy of analyses, they may decrease the efficiency, transparency, or ease of use of the tool itself (BSAIC 2004b).

The output of TSMPP is fed into TSM as a static spreadsheet, impeding the incorporation of feedback from TSM to TSMPP. This structure does not allow for parameters in TSM regarding surface facility activity to affect the shipment schedule. The disconnect between TSMPP and TSM decreases the capability to recognize potential improvements in latter parts of the shipment schedule that could be gained from understanding the dynamics in storage demands at the utility sites and at YM due to decisions regarding packaging and transportation in earlier portions of the shipment schedule (BSAIC 2004b).

DOE's analysis of the pre-closure waste management system using TSM is isolated from its subsurface repository and emplacement drift modeling. For assessing repository performance, DOE is using a tool called Total System Performance Assessment (TSPA), developed with the GoldSim software platform. The pre-closure scenarios that are explored by DOE are somewhat restricted by the parameter values that are a part of the TSPA modeling assumptions. The time constraints imposed in order to complete the

License Application (LA) may require that certain parameter assumptions in TSPA be static. Maximum thermal loading of waste packages before emplacement (currently limited to 11.8 kW) might be one of the fixed design criteria.

Potential pre-closure scenarios should be evaluated in a way that recognizes tradeoffs between the preferences of waste generators and the desired characteristics for repository operation. Use of an integrated approach that reveals trade-offs and dependencies can accomplish this objective. In its 2005 Report to Congress, the Nuclear Waste Technical Review Board (NWTRB) highlighted the importance of a pre-closure operations model that includes all components of the waste management system, including waste acceptance, transportation, aging, and emplacement. While, the NWTRB recognizes the potential for the TAD to improve facility operations at YM, the TAD also introduces challenges that must be overcome before its potential benefit can be fully realized. Specifically, the Board pointed to the timing of the availability of the TAD for dry storage use at the utility sites, as well as the relationship between the TAD and the thermal management strategy, including the amount of aging required at the surface of the repository (NWTRB 2006).

### **Research Objectives**

In response to these needs, the author has developed an integrated tool, designed around the latest critical TAD decision. The model can be used to better understand operational parameters that affect the timing and thermal characteristics of TADs arriving at the repository. Results from a previous analysis highlighted the potential inefficiencies of the allocation queue that stem from the TAD concept (Spradley, Abkowitz and Clarke

2008; Appendix D). That finding provided motivation to explore possible benefits achieved through additional variations in the allocation queue. The reader is referred to this study for a description of the tool and initial findings. The remainder of this chapter will provide a brief overview of the model, additional functionality incorporated since its prior application, and results stemming from further analyses.

The specific objectives of this analysis are to:

- Illustrate the importance of the timing of commercial availability of the TAD with regard to the number of TADs that may need to be loaded with fuel that will already be in dry storage at the utility sites.
- Identify the impact of thermal limits for transportation and emplacement on the amount of waste that is required to be aged at YM.
- Analyze the effect of allowing utilities to trade allocations based on least remaining capacity in their spent nuclear fuel pools on: storage requirements at the utility sites, efficiency of the use of dedicated train capacity, average number of pools from which waste is shipped each year, and aging requirements at YM.

### **Analysis Methodology**

An overview of the model that was developed for this research is provided in this section. For a more complete description of the model, see Appendix A.

### *Software Resources*

The model for this research was developed using GoldSim, a commercially available simulation software package that incorporates optimization and sensitivity analysis functions. GoldSim is appropriate for this type of analysis because of its capability to simulate both discrete and continuous processes simultaneously. This ability allows the incorporation of shipment schedules that are triggered by real-time characteristics of the system (Goldsim 2007).

Each commercial reactor is implemented as a set of elements that model characteristics of CSNF inventories as well as reactor discharge and loading schedules. GoldSim Array Elements are defined to track which assemblies have been placed in dry storage containers and which are remaining in the pool. The Allocator Element within GoldSim is utilized to create a dynamic shipment schedule, allocating shipments from waste generation facilities based on pre-defined priorities, such as the age of the fuel or the available capacity for storage in the spent nuclear fuel pools at the waste generation sites. Shipments to the repository are triggered by the Allocator Element within GoldSim and are modeled as discrete transactions on a yearly basis.

GoldSim Elements tracking the cumulative amount of waste above and below the thermal emplacement limit are also defined. In this sense, the model is an integration of the aforementioned TSMPP and TSM capabilities. The simulation in this analysis is carried out for the emplacement phase of the pre-closure period to gain a better understanding of repository surface operations. GoldSim is not used in this application to calculate temperatures associated with the subsurface of the repository (e.g., midpillar,

cladding, waste package, and drift wall), which is considered outside the scope of this analysis.

### ***Available Data***

Since approximately 90%, or 63,000 metric tons uranium (MTHM), of 70,000 MTHM destined for Yucca Mountain will be commercial spent nuclear fuel (CSNF) as opposed to DOE SNF or high-level waste, this analysis was limited to commercial spent nuclear fuel. The DOE SNF and HLW canisters will likely have a lower thermal energy output and are therefore not expected to be a driving factor in the amount of aging that will need to take place above ground. CSNF inventory data was taken from the RW-859 2002 Database, supplied by the Energy Information Administration (EIA 2002). The final burnup (GW-d/MTHM), initial enrichment (in weight percent), mass at initial loading (kg of uranium), and date of discharge were available for each assembly that has been permanently discharged from every reactor (EIA 2002).

Projections of fuel discharges are estimated assuming trends in burnup and license renewals. All currently operating reactors that have not yet received license extensions are granted 20-year extensions so that they are operated for a total of 60 years. An annual fractional increase in burnup of 0.01 is assumed until a maximum of 57 GWd/MTHM or 62 GWd/MTHM is reached for pressurized water reactors and boiling water reactors, respectively (BSAIC 2002). Thermal values are calculated using tables (Appendix E) developed by DOE that provide the thermal output for final burnup, initial enrichment, and years out of reactor. Thermal powers are interpolated linearly between burnup and enrichment values and logarithmically between years out-of-reactor (BSAIC 1999).

### *System Constraints*

The Yucca Mountain pre-closure waste management system is defined by a set of constraints that determine how the waste is packaged at the utilities, transported, and processed at the surface facilities. In addition to rules that govern the flow of waste after the repository has opened, assumptions are also applied regarding how the facilities manage their pool inventories before YM begins to accept waste. Fig. 1 describes the model logic for packaging waste into dry storage before the repository opens.

The simulation begins in the year 2002 since that is the year the available inventory was updated. From the year 2002 until the repository opens, each year the SNF pools are checked to see if they have reached the licensed capacity provided in the EIA database. It is recognized that although it is not legally required, it is common practice for most facilities to leave a full core reserve in their pools. Therefore, results are expected to err on the side of estimating less containers being loaded than may actually be loaded. Facilities load dry storage only when demand for their pools exceeds capacity. Assemblies removed from the pool are loaded into DPCs until the TAD is available for use. Before the TAD is available, it is anticipated that facilities will load fuel into a generic container that is the same size as the TAD (21-PWR or 44-BWR assemblies).

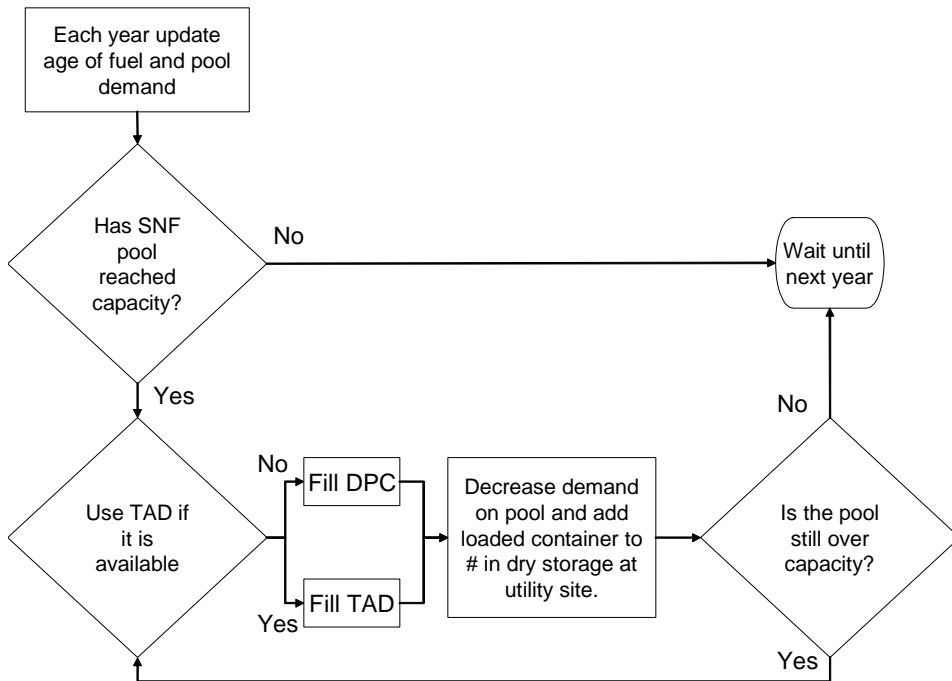

Fig. 1. Logic flow diagram for packaging waste into dry storage at utility sites before YM opens.



In reality, the type of DPC or SPC used at each facility is highly individualized, depending on specific vendor contracts and site licenses. However, due to unavailable data, and to facilitate viewing results in units that are comparable, assumption of a generic container is necessary. TADs or DPCs loaded before the repository opens are assumed to remain in dry storage at the utility sites until the end of the shipping campaign unless there are not enough cool assemblies remaining in the pool to fulfill a scheduled shipment. This is assumed because it is expected that the utilities will generally desire to remove waste from their spent nuclear fuel pools prior to removing dry storage containers.<sup>4</sup> Future enhancements of the modeling tool will incorporate the flexibility to send dry storage containers prior to removing waste from the pool.

This analysis investigates the effect of varying the year the TAD is in use from 2012 to 2020 and the year the repository opens from 2020 to 2030. The final design specifications for the TAD were released in 2007, and it is expected to take at least five (5) years for the TAD to be licensed for commercial use. The earliest estimate for commercial availability for the TAD is 2012 (Kouts 2006b). An upper bound of 2020 for the availability is considered because that is the earliest date assumed for the repository opening in this analysis. DOE plans to submit a License Application (LA) to the U.S. Nuclear Regulatory Commission (NRC) in 2008 for construction authorization. Construction on Yucca Mountain can begin once the authorization is granted, and the earliest estimate for opening the repository is 2017 (Williams 2006). An earliest date of 2020 is applied instead of 2017 since delays may occur in the licensing and development

---

<sup>4</sup> Personal communication with Adam Levin, Spent Fuel and Decommissioning, Exelon Generation Company. December, 2006.

stages and the simulation begins with a full steady-state receipt rate, after the construction of the processing facilities is complete.

The draft SEIS for YM describes the repository as accommodating 63,000 MTHM of CSNF (or approximately 7,500 TADs), and for shipping to be completed in about 25 years, which equates to about 300 TADs per year (DOE 2006b). Therefore, each year after the repository is open, 300 TADs of allocations, dictating the amount that each facility loads, are assigned. As shown in Table 2, the shipping campaign planned for Yucca Mountain will not reach the full rate until the fifth year. This simulation commences at the full rate, and is limited to only CSNF shipments, for simplification purposes.

Most of the early shipments are expected to be non-commercial, which are estimated to have a lower thermal output than commercial shipments. Because these shipments will have a lower thermal output, and the ramp-up time is short relative to the complete lifetime of operations, the limitation of this simulation to CNSF shipped at a steady-state rate is not expected to greatly impact the resulting demand for aging above ground at YM. TADs will continue to be loaded according to the allocation schedule until the end of the shipping campaign, which is set to one of two durations. In one case, shipments are stopped after 7,500 TADs (approximately 63,000 MTHM) have been loaded. In the second case, the entire projected inventory of waste created from the reactor fleet is sent, roughly doubling the current capacity of Yucca Mountain.

Table 2

Spent Fuel Annual Capacity and Acceptance Priority Ranking Summary

| Year of Operation <sup>a</sup> | Quantity of SNF Shipped (MTHM) | Number of Purchasers With Allocations <sup>b</sup> | Range of Allocation Quantities (MTHM) <sup>c</sup> |
|--------------------------------|--------------------------------|--|--|
| 1                              | 400                            | 16   | 0.1 – 145  |
| 2                              | 600                            | 23   | 0.1 – 72   |
| 3                              | 1200                           | 26   | 0.1 – 251  |
| 4                              | 2000                           | 37   | 0.1 – 467  |
| 5                              | 3000                           | 39   | 0.1 – 488  |
| 6                              | 3000                           | 39   | 0.1 – 452  |
| 7                              | 3000                           | 43   | 0.1 – 420  |
| 8                              | 3000                           | 47   | 0.1 – 375  |
| 9                              | 3000                           | 50   | 0.1 – 524  |
| 10                             | 3000                           | 46   | 0.1 – 444  |

<sup>a</sup> Years after Yucca Mountain is opened.

<sup>b</sup> The number of Purchasers with allocations for shipping commercial spent fuel. In some cases, Purchasers may have multiple allocations in a given year that are consolidated into one amount.

<sup>c</sup> The minimum and maximum allocated quantities of spent fuel to a single Purchaser that year (NAS 2006a).

The assignment of allocations is modeled by applying an incoming signal of 300 TADs each year to the GoldSim Allocator Element, which then splits the signal among the waste generation sites, applying pre-defined demands and priorities. In this way, a discrete event triggers each shipping transaction. Fig. 2 shows the high level logic for how Purchasers assign or trade allocations to each of their pools. If Purchasers are allowed to trade allocations, all pools are considered in the same Allocator Element which distributes 300 allocations per year. If Purchasers are not allowed to trade allocations, a separate Allocator Element is used for each Purchaser that is only linked to that Purchaser's pools. The incoming allocations for these separate Allocator Elements are based on the *Allocation Priority Ranking and Annual Capacity Report (APR/ACR)*, with a few adjustments to facilitate the TAD concept (DOE 2004).

The APR/ACR assigns allocations in MTHM to Purchasers based on the order that fuel was discharged (DOE 2004). Mergers and acquisitions have taken place since the APR/ACR was established in 2004, and it is not clear if Purchasers will adjust their contracts accordingly. In an attempt to account for allocation sharing that might be facilitated by owner/operator consolidations since 2004, the "Purchasers" have been altered to reflect current corporate ownership.

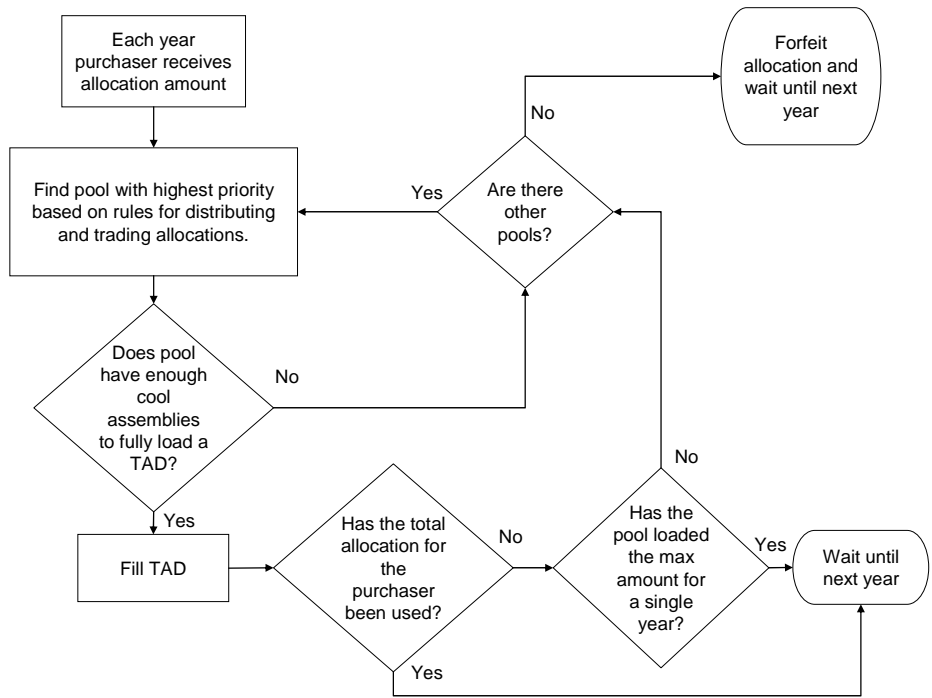

Fig. 2. Process flow for distribution of allocations for shipments.

Table 2 describes the number of Purchasers with allocations, and the range of individual allocation quantities, for the first ten years of the shipping campaign for YM. As shown, many of the allocations are smaller than the amount needed to fully load a TAD. Because it is uneconomical to ship TADs that are not fully loaded, the allocations are assigned in units of TADs (as opposed to MTHM). Allocations are still assigned based on order that fuel was discharged from the reactor, only the order is based on the date that each equivalent of a full TAD had been discharged, as opposed to individual assembly weight, rounded to a tenth of a metric ton.

The APR/ACR implies that Purchasers will distribute allocations to their pools (DOE 2004). However, the report does not specify *how* allocations must be prioritized. Purchasers may distribute their allocations according to the age of the fuel in their inventory. However, they might choose to distribute allocations giving priority to the facility with the least remaining capacity in its pool in order to avoid dry storage costs. This will depend on the economic circumstances of the transaction.<sup>5</sup> A further variation of the APR/ACR method is to allow utilities to *exchange* allocations with other Purchasers in possession of even younger fuel, or with less remaining capacity in their pools.

Table 3 summarizes the parameters varied in this analysis and the values explored for each parameter, as well as the 81 scenarios that were considered. Eight sub-scenarios were created by manipulating four variables (year TAD becomes available, year YM opens, transportation thermal limit, and emplacement thermal limit) from their high to

---

<sup>5</sup> Personal communication with Everett Redmond, Used Fuel Storage and Transportation, Nuclear Energy Institute, June 27, 2007.

low values while holding all others at their central value). A ninth sub-scenario was defined holding each variable at its central value. These *nine* sub-scenarios were considered in combination with *three* utility assembly selection loading behaviors, creating 27 combinations of sub-scenarios with assembly selection orders. This set of 27 scenarios was repeated 3 times: assuming that Purchasers did not trade allocations with a capacity of 7,500 TADs for YM, assuming Purchasers could trade allocations based on age with an expanded capacity of YM, and assuming that Purchasers could trade allocations based on least remaining capacity in the spent nuclear fuel pools with a capacity of 7,500 TADs.

As shown in Table 3, the loading of spent fuel assemblies from a facility's pool into dry storage containers follows one of three algorithms: (1) oldest fuel first (OFF), (2) youngest fuel first at least five years old (YFF5), or (3) youngest fuel first at least ten years old (YFF10). The YFF5 and YFF10 algorithms load the youngest assembly that still meets the per-assembly heat limit, meaning that if the per-assembly limit is very low, then fuel that is five or ten years old may be too hot to qualify for shipping.

The PWR and BWR TADs are expected to accommodate zone loading, meaning that TAD canisters are loaded with relatively hotter assemblies in the center and cooler assemblies around the outer perimeter to improve shielding and reduce risk of worker dose. It is recognized that an opposite configuration with hotter fuel on the outside as opposed to the center is also applied in some cases in order to improve thermal heat transfer properties of the canister.<sup>6</sup> The particular configuration is not as important as the fact that hotter and cooler assemblies with different relative decay curves will be co-

---

<sup>6</sup> Personal communication with Kris Cummings, Manager DOE Programs, Holtec. July 25, 2007.

mingled in the same TAD canister. The 21-PWR and 44-BWR TADs will most likely be designed to hold 9/12, or 20/24 hot/cold assemblies, respectively. The per-assembly thermal power output limit for the hotter zone is designed to be twice that of the cooler zone. For example, the per-assembly limit for a 25 kW, 21-PWR TAD is 1.67 kW for each of the 9 hotter assemblies and 0.83 kW for each of the 12 colder assemblies.<sup>6</sup> The transportation limit for the TAD is assumed to range from 18 kW to 25 kW since these are the ranges considered in the performance specifications released by DOE (DOE 2007).



Table 3

Independent Variable Values

| Parameter Name                         | Level 1                  | Level 2  | Level 3           |
|--|--------------------------|--|-------------------|
| Year TAD in Use                        | 2012                     | 2016   | 2020              |
| Year Repository Opens                  | 2020                     | 2025   | 2030              |
| Transportation Thermal Limit           | 18 kW                    | 21.5 kW  | 22 kW             |
| Emplacement Thermal Limit              | 11.8 kW                  | 14.9 kW  | 18 kW             |
| Utility Assembly Selection for Loading | YFF at least 5 years old | YFF at least 10 years old                              | Oldest fuel first |
| Allocation Trading                     | Assigned to Purchasers   | Traded based on least remaining capacity in the pools. |                   |
| YM CSNF Capacity                       | 7,500                    | Approximately 14,000 TADs                              |                   |

Table 4

Scenario Definitions

| Sub Scenario Parameter Adjusted | Subscenario ID | Value   |         |
|---------------------------------|----------------|---------|---------|
| Year TAD in Use                 | R1             | High    | 2020    |
|                                 | R2             | Low     | 2012    |
| Year TAD in Use                 | R3             | High    | 2030    |
|                                 | R4             | Low     | 2020    |
| Transportation Thermal Limit    | R5             | High    | 25 kW   |
|                                 | R6             | Low     | 18 kW   |
| Emplacement Thermal Limit       | R7             | High    | 18 kW   |
|                                 | R8             | Low     | 11.8 kW |
| All Subscenario Parameters      | R9             | Central |         |

| YM CSNF Capacity | Allocation Trading             | Assembly Selection | Subscenarios Explored |
|------------------|--------------------------------|--------------------|-----------------------|
| 7,500 TADs       | No                             | OFF                | R1-R9                 |
|                  |                                | YFF10              | R1-R9                 |
|                  |                                | YFF5               | R1-R9                 |
|                  | Based on capacity in SNF pools | OFF                | R1-R9                 |
|                  |                                | YFF10              | R1-R9                 |
|                  |                                | YFF5               | R1-R9                 |
| 14,000 TADs      | Based on age of SNF            | OFF                | R1-R9                 |
|                  |                                | YFF10              | R1-R9                 |
|                  |                                | YFF5               | R1-R9                 |

Each facility is permitted to send a maximum of ten TADs per year, which is considered a reasonable upper limit to load at a specific facility in a given year<sup>7</sup>, without placing undue stress on resources. Currently, facilities load about six to eight dry storage containers approximately every two years to accommodate core off-load, but loading campaigns are likely to increase once shipments to Yucca Mountain commence. This limit also corresponds to the number of TADs that could be accommodated by two dedicated trains, assuming each carries five TADs. The Supplemental Environmental Impact Statement (SEIS) analyzes the impacts of sending as many as five transportation casks on a single dedicated train (DOE 2002).

Fig. 3 illustrates the flow of packages upon arrival at YM that is assumed in this study. In this particular analysis, flow through the surface facilities is constrained *only* by the thermal limitation on emplacement. Each year, the surface facilities are assumed to process and emplace all packages arriving, or in the Aging Facility, that meet the thermal criteria. In reality, processing capacities will also be a constraining factor, but it is important to *isolate* delays due to thermal constraints from delays due to capacity constraints.

---

<sup>7</sup> Personal communication with Steve Edwards, Spent Fuel Management Progress Energy. June 20, 2007.

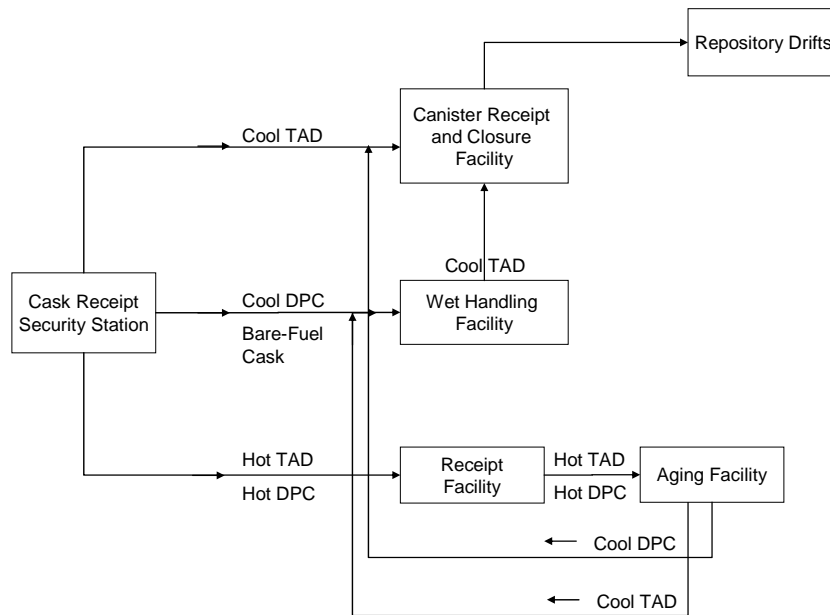

Fig. 3. Yucca Mountain repository surface facilities process flow logic assumed in this analysis.

As discussed previously, the thermal emplacement limit currently documented is 11.8 kW per TAD. Scenarios in which the emplacement limit is defined as 18 kW are analyzed in this study to understand the potential impact on above-ground aging requirements at YM of changing the emplacement limit. Although it has not yet been shown if this emplacement limit will allow the repository to stay within the thermal management criteria, the NWTRB is encouraging DOE to explore the potential for easing this constraint (NWTRB 2006).

Upon arrival at the repository, TADs that are below the emplacement heat limit are routed to the Canister Receipt and Closure Facility (CRCF) before being emplaced. Canisters above the emplacement limit are sent to the Aging Facility, via the Receipt Facility (RF), where the TAD or DPC is placed in an aging overpack. When DPCs meet the thermal emplacement limit, they are taken to the WHF. When TADs meet the thermal emplacement requirement, they are removed from the Aging Facility and sent to the CRCF before being emplaced.

Process flow in this study is slightly simplified from that described in the SEIS. In the SEIS, the design calls for most of the hot canisters to be processed in the RF, but the CRCF will also have the capability, if necessary, to place canisters in aging overpacks to be sent to the Aging Facility. The process flow described in Fig. 3 is different from the SEIS because it does not route TADs from the CRCF or the WHF to the AF, or from the RF to the CRCF. It also does not route DPCs to the CRCF (DOE 2006b).

Yucca Mountain design documents stipulate that there may be up to three CRCFs constructed, each capable of processing 450 MTHM/year of TADs for direct emplacement and 200 MTHM/year of TADs for transfer to the Aging Facility (BSAIC

2007c). The RF will be designed to process up to 1,000 MTHM/year of TADs and 150 MTHM/year of DPCs (BSAIC 2007d). The Aging Facility will accommodate 2,500 TADs and is expected to be necessary for 50 years, after which all the waste will have been emplaced (DOE 2006b).

It is important to emphasize that the model does not simulate emplacement sequencing or ventilation within the repository drifts. The model calculates the thermal power output of each individual CSNF package, but does not attempt to estimate line loads within the emplacement drift. The modeling of subsurface repository behavior is considered outside the scope of this study. Instead, the focus of this analysis is on the storage requirements of the waste generators, the efficiency of allocation of transportation shipments, and the above-ground aging needs at YM.

### ***Overview of Major Assumptions***

This section highlights major assumptions made in the development of system constraints. The rationale for these assumptions was addressed in the previous section along with the system constraints.

Major assumptions include:

- Facilities load dry storage only when demand for their pools exceeds licensed capacity.
- Facilities simultaneously and unanimously adopt the use of the TAD when it is commercially available.

- TADs accommodate zone loading of 9/12 and 20/24 configurations with the hotter assemblies having approximately twice the thermal limit than the outer assemblies.
- TADs and DPCs loaded before the repository opens remain on the dry storage pads until there are not enough cool assemblies in the pool to fulfill the allocation.
- TADs and DPCs loaded before the repository opens will eventually be sent to YM to be repacked in the WHF.
- Purchasers are updated to reflect current ownership of facilities.
- Allocations are assigned to Purchasers in units of TADs instead of MTHM.
- The amount of 10 TADs per year is a reasonable maximum limit for a single pool to load and send to YM in a given year.
- Surface facilities process and emplace all packages above the thermal emplacement limit each year.

### *System Performance*

The model estimates operational performance of the waste management system by measuring response variables associated with characteristics of the system.

Dependent response variables are measured as cumulative counts each year of:

- Assemblies in wet storage at utility sites
- Dry storage canisters loaded and placed in storage at utility sites
- Pools loading dry storage for shipments to YM

- TADS and DPCs shipped to YM
- TADs or DPCs at YM that are above the emplacement limit
- TADs at YM that are below the emplacement limit

Scenarios are examined to determine which, if any, result in adverse effects (e.g., delays in waste acceptance beyond the receipt rate, aging requirements above the planned capacity for the Aging Facility, etc.), and which improve operational performance (e.g., more efficient use of transportation movements and reduced storage requirements relative to other scenarios). Variables are evaluated in terms of their relative importance to the performance of the system (e.g., which variables have the most influence over the expected dry storage demands or aging requirements).

## **Discussion of Results**

### ***Utility Storage Demands***

Storage demands at the utility sites can be described as: (1) DPCs destined for Yucca Mountain, (2) TADs destined for YM, and (3) storage for waste in addition to what will eventually be sent to YM. The current 70,000 MTHM capacity will not accommodate the projected volume of spent fuel assemblies in excess of pool storage capabilities. Unless more than 70,000 MTHM is permitted to be sent to YM, or a second repository is opened, facilities may need to load dry storage containers that will not be sent off-site. Since the utilities may view the burden of these storage categories differently in terms of economic, legal or health and safety implications, treating them separately has merit.



### Storage of DPCs Loaded Before YM Opens

As of 2002, about 4,200 MTHM of CSNF had been loaded into dry storage. Assuming nine MTHM per TAD-sized container, this amount is approximately equivalent to 460 TAD-sized containers.<sup>8</sup> Fig. 4 shows that as many as 2,000 containers of this size will need to be loaded before a potential opening of YM in 2020. This number increases to 3,750 containers if YM is delayed until 2030. Depending on when the TAD is in use, more or less of these containers will be DPCs as opposed to TAD canisters. Referring to Fig. 4, one can measure the percentage of containers destined for YM that are expected to be in non-TAD form, assuming that all facilities use the TAD as soon as it is available. The percentage ranges from 12% to 28% assuming that TADs are in use by 2012 or 2020, respectively.

The YM pre-closure safety analysis assumes that a significant majority (~90%) of the waste sent to YM will be in TADs, so a delay in the TAD will have implications on the surface facility operations unless utilities repackage waste into TADs (DOE 2006e). The safety benefits of using the TAD will largely rely on the percentage of waste loaded into DPCs or SPCs at the time that YM opens. In order to fully realize the safety benefits of the TAD design, the number of DPCs/SPCs that need to be repackaged should be limited to close to 10% of the total waste stream sent to YM. Since the percentage of TADs that may need to be loaded with waste that was previously in DPCs/SPCs more than doubles from 2012 to 2020, it is important to commercialize the TAD by 2012.

---

<sup>8</sup> Assuming 425kg per PWR assembly, a 21-PWR container is 8.9 MTHM. Assuming 175kg per BWR container, a 44-BWR container is 7.7 MTHM. The amount of 460 DPCs or single-purpose containers is an estimate of the *equivalent number of TADs* that were in dry storage as of 2002, and does not represent the precise number of DPCs or single-purpose containers actually loaded since there are several different sized containers in use.

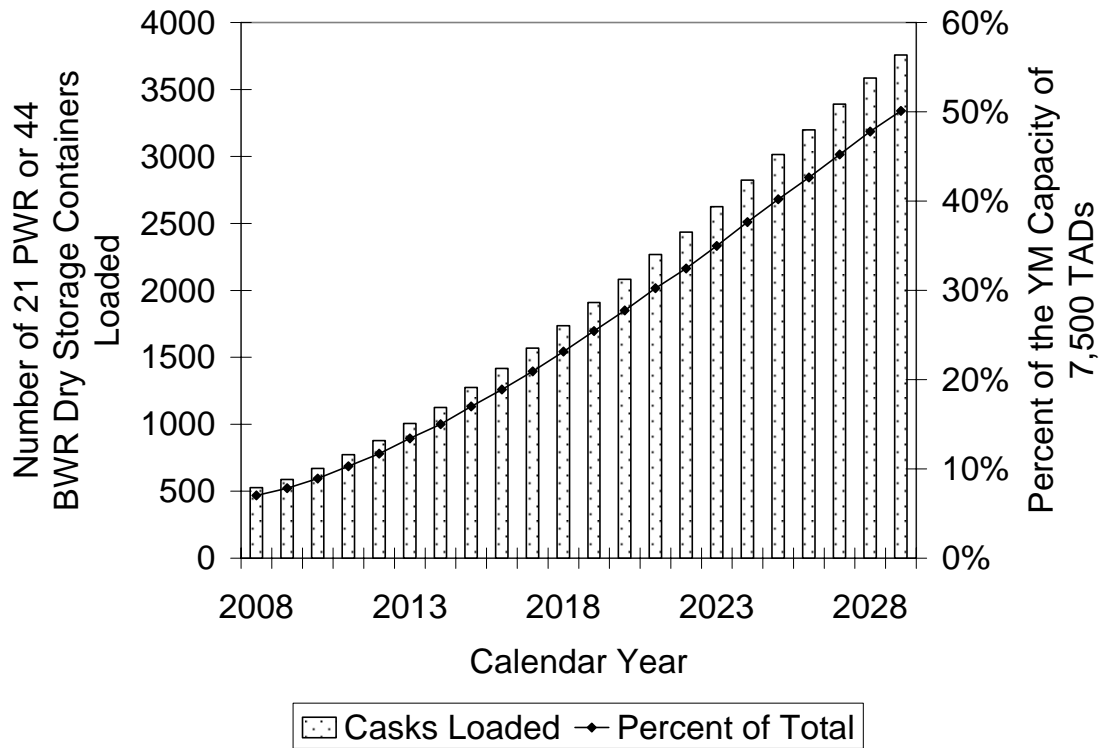

Fig. 4. Cumulative number of dry storage containers loaded before 2030 due to lack of capacity in the SNF pools (also shown as percentage of total capacity, or 7,500 TADs, to be replaced in YM).

### Storage of TADs

Before the repository opens, the number of TADs that utilities will need to store is entirely dependent on the year the TAD is in use and the year the repository opens. As shown in Fig. 4, this number could vary considerably. Also, in cases where a facility needs to load dry storage *after* YM is open, but the facility does not have a shipment scheduled, the TAD(s) will be placed on the dry storage pad at the utility site instead of being shipped directly to YM.

It is expected that utilities may prefer to free up capacity in the pool over removing containers from the dry storage pad.<sup>9</sup> Therefore, TADs placed on storage pads at the utility sites are assumed to remain there until the end of the shipping campaign or until a facility does not have enough cool assemblies in its pool to fulfill an allocation. Because the majority of TADs that need to be stored at the utilities are loaded *before* the repository opens, the maximum number of TADs stored on the utility sites' pads is not impacted by the assembly selection assumptions, but rather by the year the TAD is in use and the year YM starts accepting waste. Fig. 4 shows that as many as 1,900 out of the 3,750 containers loaded before 2030 could be TADs if it is in use by 2012. This is approximately one quarter of the 7,500 TADs that will eventually be emplaced.

### Additional Storage Requirements

An additional category of demand at the utility sites is that needed for waste beyond what will be sent to YM under the current legal capacity limit. This performance metric

---

<sup>9</sup> Personal communication with Everett Redmond, Used Fuel Storage and Transportation, Nuclear Energy Institute, June 27, 2007.

is sensitive to the year that YM starts receiving waste and the allocation trading rules that are enforced.

Fig. 5 shows the impact of trading allocations on this category of storage. The scenario categories are listed along the x-axis. “Trading within Subscenario” represents whether or not trading was assumed (Yes or No), and the subscenario conditions R1 – R9 (Table 4). As expected, allowing Purchasers to trade allocations based on least remaining capacity in the reactor site spent nuclear fuel pool decreases the overall expected dry storage remaining at the sites when YM reaches capacity. The tradeoff is that more fuel will remain in the reactor site pools. A paired t-test with an alpha level of 0.05 (Appendix B) shows that the difference in dry storage demands at the utility sites between scenarios that allow trading based on least remaining capacity and those that do not is significant. This is true irrespective of the subscenario R1-R9 assumptions.

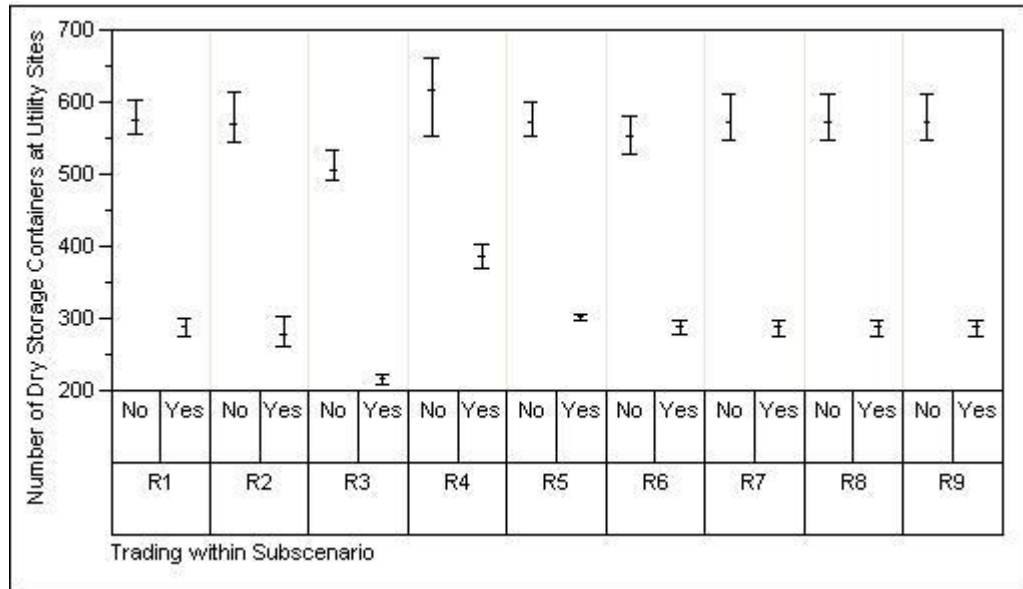

Fig. 5. Effect of trading allocations (yes or no) on expected aggregate demand for storage at the waste generation sites in the year that YM reaches current legal capacity in terms of number of 21-PWR or 44-BWR sized containers for each subscenario (R1-R9), showing the range of values and the means.

## ***Transportation***

In terms of transportation, it is desirable to avoid delays in the shipping campaign, but also to maximize the use of each transportation movement (using dedicated trains) for efficiency. These two goals are potentially competing if dedicated trains are held at a specific site until the maximum number of packages that can be sent on a single train have been allocated and loaded. Therefore, it is anticipated that scenarios which increase the efficiency of dedicated trains without delaying the shipping campaign will be preferred. A prior analysis concluded that variations in transportation limits and loading rules did not significantly impede the rate of shipments under the current YM capacity but that lowering the transportation limit could disrupt shipment schedules if the capacity of YM was greatly increased (Spradley, Abkowitz and Clarke 2008; Appendix D).

This study shows that variations in the waste acceptance rules can improve the efficiency of using dedicated trains for shipments. Scenarios in which Purchasers are permitted to trade allocations result in more efficient use of dedicated trains because the same amount of waste is shipped to YM each year, but from a fewer number of facilities (Fig. 6). Prohibiting trade between Purchasers prevents the most efficient use of trains because, in most cases, the total allocation is not evenly divisible by the maximum limit for each train. Trading allocations decreases the number of facilities making shipments because allocations are consolidated so that facilities send ten TADs per year more frequently. A paired t-test (Appendix B) shows that the difference in number of pools making shipments is significant with an alpha level of 0.05. This is true irrespective of the subscenario R1-R9 assumptions.

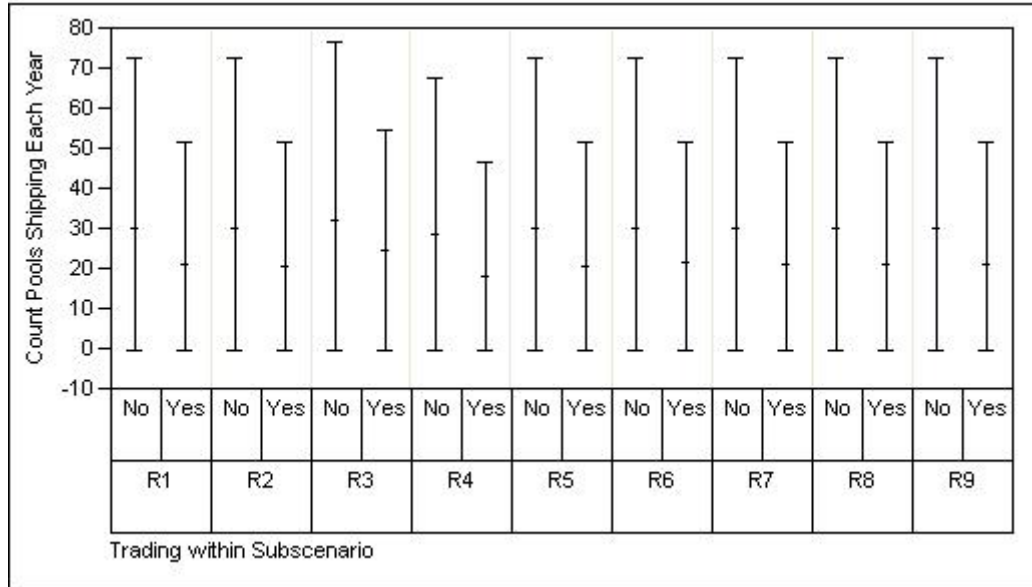

Fig. 6. Effect of trading allocations (yes or no) on the number of pools sending shipments in a given year for each subscenario (R1-R9), showing the range of values and the means.

### ***Aging Above Ground at Yucca Mountain***

Demand for aging above ground at YM is measured by the amount of waste aging above ground over time and the length of time the Aging Facility is required. A prior analysis established that the thermal limits for transportation and emplacement are important variables with respect to peak required capacity of the Aging Facility at YM, especially if younger fuel is sent first (Spradley, Abkowitz and Clarke 2008; Appendix D). This analysis provides the opportunity to describe the influence of the waste acceptance assumptions and emplacement limit on above ground aging requirements in greater detail.

Sending oldest fuel, and allowing 18 kW packages to be emplaced, requires the least amount of aging. The most aging is required when the youngest fuel is sent first and the emplacement limit is kept at 11.8 kW. Purchasers are not likely to distribute allocations so that the youngest fuel (at least five years old) from *all* of their facilities is sent each year, because there is no known incentive to do so. However, there is nothing in the *Standard Contract* preventing this from occurring, so it is important to consider the implications of such a scenario (10 CFR § 961 (2008)).

In the case that youngest fuel is sent first to YM starting in 2025, and the emplacement limit is kept at 11.8 kW (shown as the maximum range in Fig. 7 (c)), the number of TADs aging in a given year could reach over 3,500. This is an approximate 40% increase over the planned 2,500 spaces currently in the Aging Facility design, and almost one-half of the assumed 70,000 MTHM to eventually be emplaced. Still, if the emplacement limit is increased to 14.9 kW (Fig. 7 (b)) or 18 kW (Fig. 7 (a)), the required aging is drastically reduced, even if youngest fuel is sent first.



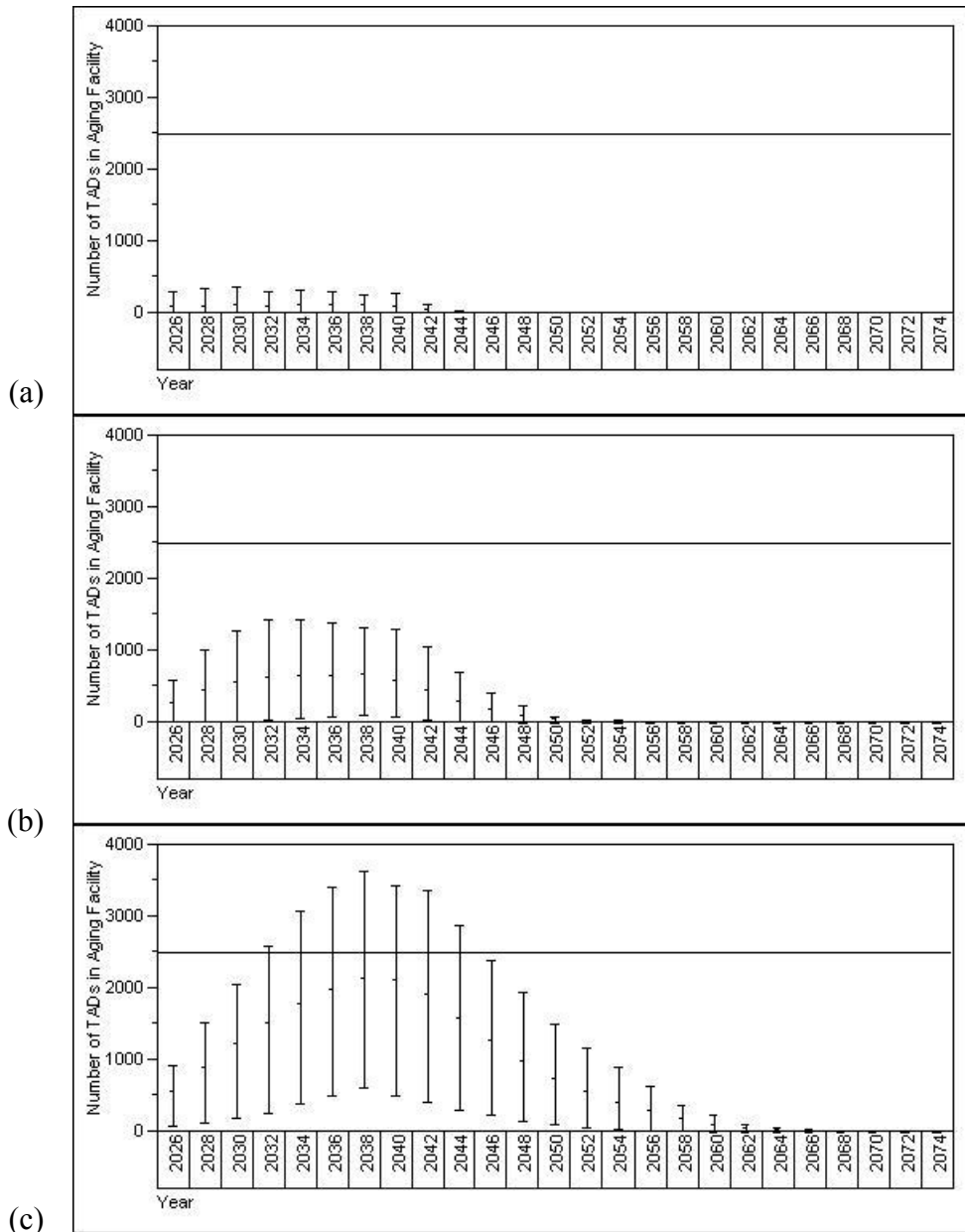

Fig. 7. Impact of thermal emplacement limit on the above-ground aging requirements at YM. Cell means and ranges of the OFF, YFF10, and YFF5 scenarios are shown for each year.

- (a) 18 kW emplacement limit (R7)
- (b) 14.9 kW emplacement limit (R9)
- (c) 11.8 kW emplacement limit (R8)

Demand on the Aging Facility is also illustrated in Fig. 8 (a) and (b). These charts compare the number of containers aging and the length of time the Aging Facility is occupied under various scenarios for utility selection of assemblies for loading and rules for trading allocations. Allowing Purchasers to trade does not greatly increase the number of canisters in the Aging Facility in the scenarios *when younger fuel is sent first*. While a paired t-test with an alpha of 0.05 (Appendix B) shows that the difference in the *average duration* of the aging facility is significant, the difference in the *maximum duration* (indicated by the top of the range bar) is small under most subscenarios. The paired t-test also shows that the difference between the number of canisters aging is significantly greater for the scenarios that allow trading in the case that oldest fuel is sent first. However, for the younger fuel scenarios, the difference between the trading and non-trading scenarios is not significant.

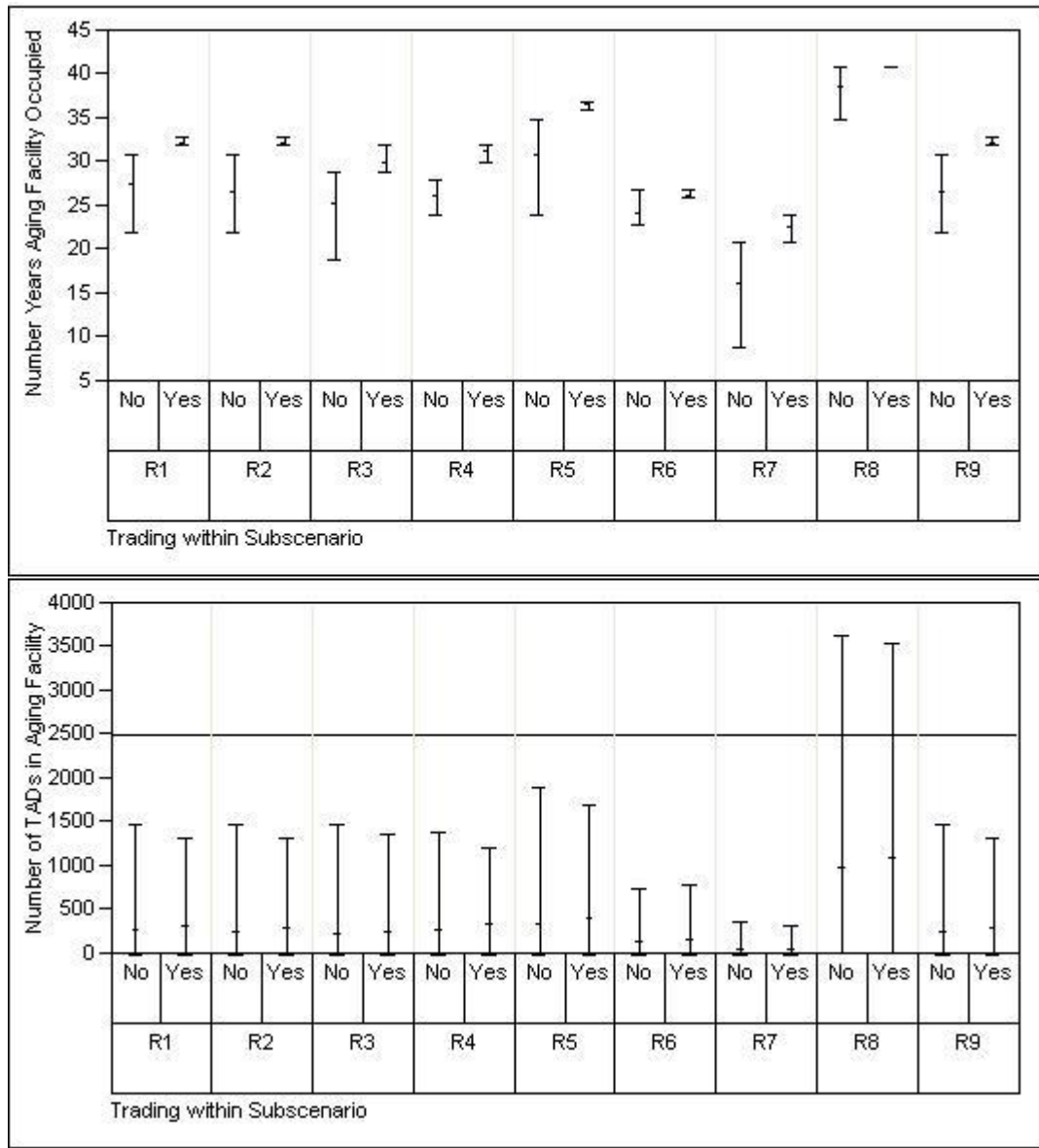

Fig. 8. Effect of trading allocations (yes or no) on demand for the Aging Facility at YM for each subscenario (R1-R9), showing the range of values and the means.  
 (a) duration Aging Facility is occupied  
 (b) number of containers aging each year and a reference line indicating the design capacity

## Conclusions and Recommendations

This chapter describes the development and application of a model to explore the impact of waste management system design and operations on storage demands at the utility sites, efficiency of transportation movements, and aging requirements at YM. The model provides an opportunity to perform analyses of various Yucca Mountain pre-closure operating scenarios with the goal of understanding system interactions, offering the potential to recognize trade-offs and dependencies.

Response indicators are associated with characteristics of waste acceptance, transportation, and surface facility operations. Overall, scenarios are evaluated for their potential to result in desirable characteristics in all three areas of the waste management system. The results indicate that allowing Purchasers to trade allocations, prioritizing the trades based on least remaining capacity in the reactor site spent nuclear fuel pools, reduces the dry storage demands at the utility sites and the average number of pools making shipments in a given year, while increasing the efficiency of the dedicated trains. While this type of prioritization for allocations does impact the amount of aging if oldest fuel is sent first, it does not under the YFF5 and YFF10 scenarios.

In the next chapters a discussion is provided of the use of the tool to explore the impact on *safety* of various waste streams as well as address the ability of the surface facilities to process likely demand. Canisters that need to be aged due to thermal or capacity constraints will require more crane transfers than those that are not aged. The safety implications will depend on the crane reliability assumed as well as the number of handlings required under the various scenarios.

## CHAPTER III

### SAFETY CONSIDERATIONS

#### Abstract

This chapter focuses on the safety implications of an assumed waste stream. The analysis employs a model developed over the course of this research for predicting the packaging and thermal characteristics of the waste stream arriving at Yucca Mountain. The model generates waste streams for commercial spent nuclear fuel (CSNF) as a function of repository design parameters and operating strategies, accounting for the expected number of material crane transfers.

This application of the model explores changes in assumptions regarding the following parameters: (1) year the TAD becomes available, (2) year that YM opens, (3) thermal limit for emplacement, (4) thermal limit for transportation, (5) utility approach to selection of assemblies from the SNF pool for dry storage loading, and (6) utility approach to selection of dry storage containers for shipment to YM.

The response variables measured are the counts of: (1) dry storage containers loaded due to lack of capacity in the spent nuclear fuel pools before YM starts to receive waste, (2) TADs that could potentially be loaded assuming that utilities begin using the TAD as soon as it is commercially available, (3) packages arriving above or below the emplacement limit each year, (4) packages in the Aging Facility at YM each year, (5) packages in the Aging Facility that are thermally cool enough to be removed from the Aging Facility each year, and (6) material transfers at the surface facilities.

Through application of a simplified routing scheme for waste processing at surface facilities, packages that are above or below the emplacement limit each year are used to determine material transfers. The likelihood of the number of occurrences during the 50-year pre-closure operational period of three internal events involving crane transfers are estimated: (1) drop of a bare-fuel assembly, (2) drop of a transport, aging, and disposal canister (TAD), and (3) drop of a Dual-Purpose canister (DPC). The analyses indicate that scenarios requiring more canisters to be aged at YM, as well as scenarios that include more DPCs, require a greater number of expected total package handlings, and hence result in a higher frequency of a drop.

Results indicate that DOE estimates are within the likely range of frequencies that is generated by this analysis. Also, the consequences of these events are low enough that their frequency will not likely impact the ability to meet regulatory requirements. Still, considering the inconclusiveness surrounding future waste schedule negotiations, DOE could strengthen its preliminary hazards analyses by adopting a probabilistic approach to estimating the frequencies of drop events in evaluating pre-closure safety. This would help to communicate the risk posed by the drop events, and allow for an analysis that is less reliant on deterministic estimates of waste stream quantities and crane drop rates.

## Introduction

### *Yucca Mountain Pre-Closure Waste Management System*

The Nuclear Waste Policy Act of 1982 as Amended, hereafter referred to as NWPA, tasked the U.S. Department of Energy (DOE) with the design, construction, and operation of a geologic repository for the nation's high-level nuclear waste (HLW) at Yucca Mountain (YM), NV (42 USC § 10101 (2008)). The site was deemed suitable by President George W. Bush in 2002, and DOE is in the process of preparing a license application (LA) for construction and operation of the repository. The LA will describe how the repository is expected to operate during the pre-closure and post-closure phases, and demonstrate that expected behavior complies with dose consequence regulations and standards.

Pre-closure operation consists of the components, facilities, and activities at the surface facilities that collectively work to prepare waste for disposal, and emplace it in the repository. Pre-closure also includes the packaging of waste *at the generation sites* and transportation from the generation sites to the YM surface facility, although the potential dose consequence resulting from these activities is outside the scope of the LA. Post-closure evaluations focus on the potential migration of radionuclides through the subsurface to the Reasonably Maximally Exposed Individual (RMEI) at the point of compliance once the repository is closed.

An important constraining parameter of pre-closure operations is *temperature* because the waste must be below a specified thermal energy (kW) before it can be emplaced. The repository design calls for most of the waste to be packaged at the utility

sites in a transport, aging, and disposal canister (TAD), which will be placed inside a transportation overpack and sent to YM. Waste that is not in TADs will arrive at the repository either in transportation casks carrying bare-fuel assemblies or Dual-Purpose canisters (DPC).

Upon arriving at YM, waste will be prepared for emplacement at the surface facilities. The surface facilities at the repository will be used for the following functions:

- The Initial Handling Facility (IHF) will receive DOE HLW and Naval SNF, and prepare it for emplacement.
- The Canister Receipt and Closure Facility (CRCF) will primarily transfer TADs from transportation overpacks to disposal overpacks for emplacement, but it will also be able to transfer TADs or DPCs to aging overpacks to be sent to the Aging Facility. The CRCF is also capable of transferring DOE HLW and SNF canisters to disposal packages. DOE plans to construct as many as three CRCFs in a phased approach.
- The Wet Handling Facility (WHF) will receive DPCs and bare-fuel transportation casks. Each DPC or transportation cask will be placed in a pool and the assemblies within it will be transferred to a TAD. The TAD will then be removed from the pool and sent to the CRCF or placed in an aging overpack and sent to the Aging Facility.
- The Receipt Facility (RF) will primarily function to receive TADs or DPCs containing fuel that is too hot to be emplaced, and transfer the canisters into aging overpacks to be sent to the Aging Facility. However, the RF can also be



used to handle canisters that are cool enough to be emplaced, but nevertheless require aging due to bottlenecks in the CRCF or WHF.

- The Aging Facility is a set of concrete pads where TADs or DPCs that need to be aged are placed.

DOE is in the process of carrying out a pre-closure safety analysis to systematically examine the potential hazards and dose consequences resulting from the activities taking place at the YM surface and subsurface facilities. In its review of the LA, the Nuclear Regulatory Commission will determine if DOE sufficiently demonstrates that it can construct and operate the repository in compliance with regulations and standards developed by NRC and the Environmental Protection Agency (EPA). As of January 2008, EPA had not finalized its public dose compliance standard, but the final decision is not expected to impact the review of *pre-closure* safety.

### ***Regulatory Framework of the YM Pre-Closure Waste Management System***

The following parts of the Code of Federal Regulations apply to the Yucca Mountain Project (DOE 2006e):

- 10 CFR § 63: Energy: Disposal of High-Level Radioactive Wastes in a Proposed Geologic Repository at Yucca Mountain, Nevada
- 10 CFR § 20: Energy: Standards for Protection Against Radiation
- 40 CFR § 197: Protection of Environment: Public Health and Environmental Radiation Protection Standards for Yucca Mountain, Nevada.

These regulations provide the public and worker dose standards and guidance for repository design objectives. The pre-closure safety analysis portion of the LA is

expected to draw on previous analyses documented in DOE's Preliminary Pre-Closure Hazards Analysis (PHA) (DOE 2006e). DOE characterizes "hazards analysis" as an approach used to determine the likelihood of potential radiological hazards (events) that could result in public or worker dose consequences during pre-closure operations. The author refers to this approach as a "risk analysis", but will subsequently use the term hazards analysis, or the abbreviation PHA, to be consistent with DOE's terminology. The PHA evaluates events that are initiated by *external* forces (e.g., earthquake, extreme wind, etc.) as well as generic *internal* events (e.g., drop, collision/crushing, fire, etc.). The main elements of DOE's hazards analysis are event identification, event frequency categorization, and event consequence analysis (e.g., what can happen, how likely it is, and what are the consequences) (Kaplin and Garrick 1981).

The frequency of occurrence for pre-closure events is defined as the likelihood of the event occurring during the entire 50 years of emplacement operations (DOE 2006e). If the expected frequency of occurrence is greater than one, the event is defined as a *Category 1* event sequence. Events that are not expected to occur one or more times, but have at least one chance in 10,000 are defined as *Category 2* event sequences. Any event with less of one chance in 10,000 is considered *Beyond Category 2* (DOE 2006e). The categories exist because the regulatory dose requirements are defined separately for events in each category (Table 5). Dose requirements are not defined for Beyond Category 2 Events.

Table 5

Total Effective Dose Equivalent (TEDE) Regulatory Limits

| Event Type                             | Worker  | On-site Public  | Off-site Public                    |
|--|---|---|------------------------------------|
| Normal Operations or Category 1 Events | 0.05 Sv (5 rem)/yr <sup>a</sup><br>5 mSv (500 mrem)/yr <sup>b</sup> | 1 mSv (100 mrem)/yr <sup>c</sup><br>0.02 mSv (2 mrem)/hr <sup>c</sup> | 0.15 mSv (15 mrem)/yr <sup>d</sup> |
| Category 2 Events                      | N/A <sup>e</sup>  | 0.05 Sv (5 rem)/event <sup>f</sup>                                    | 0.05 Sv (5 rem)/event <sup>f</sup> |

<sup>a</sup>10 CFR § 20.1201 and 10 CFR § 63.111(b)(1)

<sup>b</sup>10 CFR § 20.0011: “All worker and public exposures to ionizing radiation must be kept as low as reasonably achievable (ALARA).”

<sup>c</sup>10 CFR § 20.1301

<sup>d</sup>10 CFR § 63.204

<sup>e</sup> Potential worker dose consequences do not need to be estimated for Category 2 events.

<sup>f</sup>10 CFR § 63.111(b)(2)

## Research Objectives

For certain events involving material transfers (e.g., the drop of a CSNF assembly), the frequency over the pre-closure period can be estimated by applying a reliability rate of equipment to the number of times a specific action using the equipment occurs. Still, estimating the frequency is complicated by uncertainty regarding the *crane drop rate* and the *number of transfers* per item.

While data is available from the many crane lifts that have taken place in industry, the majority of recorded lifts are of fuel assemblies, which are lighter than canisters or transportation casks, and are uniform in shape and size for most facilities. The lifts that will take place at YM will be different in that they will consist of mostly heavy loads of different geometries. Meanwhile, the *number of transfers* will depend on the waste stream (e.g., the quantities of various casks, canisters, and SNF assemblies, as well as their thermal characteristics).

This research aims to gain a better understanding of the safety implications of a drop event through the following objectives:

- Review the crane drop rate and waste stream assumptions made by DOE in estimating the frequency of drop events during the 50-year pre-closure operational period.
- Discuss how the frequency categorization and dose consequence of the pre-closure events relate to the regulatory dose requirements.
- Generate multiple waste streams, as a function of repository design parameters and operating strategies, in order to estimate the range in the

number of material transfers that might be necessary at the surface facilities at YM.

- Use the data generated for the number of transfers to investigate the likelihood of the number of occurrences of a drop during the 50-year pre-closure emplacement period.
- Compare the results to DOE's estimated frequencies in the PHA.

## **Review of Pre-Closure Preliminary Hazards Analysis**

### ***Waste Stream Assumptions***

The quantities assumed by DOE to be processed in the surface facilities stem from a report titled the *2002 Operational Waste Stream and 2003 Total System Life Cycle Cost (TSLCC) Waste Stream Backup Calculation* (DOE 2003). This report documents the use of a model<sup>10</sup> developed by DOE to predict two potential waste streams for YM: (1) 2002 Operational Waste Stream (OWS), and (2) 2003 TSLCC Waste Stream. The study assumes 'allocations'<sup>11</sup> for waste shipments are assigned directly to the facility at which the waste was generated, giving priority to those in possession of the oldest fuel. However, since waste generators are not obligated to select the oldest fuel for shipment, a variety of selection criteria are explored. One such case, referred to as "Case B" in the

---

<sup>10</sup> CALVIN Version 3.1

<sup>11</sup> Allocation is defined as an amount that a waste generator may ship to YM in a given year.

study, assumes that waste generators select their youngest fuel first, as long as it has been out of the reactor for at least 10 years.

DOE derives the 2002 Operational Waste Stream from the existing inventory in the 1998 RW-859 Data Set, including the number of DPCs that had been loaded as of then, as well as projected inventories that assume a certain number of license extensions are granted (DOE 2003). The approach used by DOE to generate these particular waste streams allows for “short-loading” transportation casks (not loading them to full capacity) in order to comply with thermal limits for transportation when loading hotter fuel.

The approach assumes the allocations are used for the specific reactors earning the allocation, and therefore does not account for allocation sharing among facilities owned by the same Purchaser<sup>12</sup>, or allocation trading between Purchasers. The reader is referred to the *Standard Contract* and the *Allocation Priority Ranking and Annual Capacity Report* for a detailed description of the basis for assigning allocations (10 CFR § 961; (DOE 2004). A short description of the basis for this assumption is in the following excerpt from the *2002 Operational Waste Stream and 2003 Total System Life Cycle Cost (TSLCC) Waste Stream Backup Calculation* (DOE 2003):

“CSNF acceptance deliveries are assumed to be from the reactor generating each allocation, with no provisions for allocation trading. Under the *Standard Contract*, each Purchaser has the right to waste selection, and may select CSNF assemblies from any of its reactors up to the total of the MTHM delivery allocation earned by one of its reactors. Different Purchasers also have the right to exchange allocation among themselves for which an approved delivery

---

<sup>12</sup> Purchaser is the term used to refer to an entity that has a contract with DOE for waste removal and may own one or more facilities where waste is generated.

commitment has been issued, subject to DOE approval. However due to the large uncertainty associated with the extent to which allocation trading may occur, it is assumed in this calculation that the reactor earning the delivery allocation also uses that delivery allocation.”<sup>13</sup>

The main difference between the OWS and the 2003 TSLCC Waste Stream is that the OWS assumes that 84 license extensions are granted, while the 2003 TSLCC assumes that only 16 are granted. Case B of these waste streams assumes younger fuel is removed from the pool at a particular site before dry storage is sent, causing the waste stream derived from an inventory with less total fuel (2003 TSLCC) to include more of the older fuel in dry storage (including DPCs) as part of the 70,000 metric tons of heavy metal (MTHM) legal capacity for Yucca Mountain. Approximately 63,000 MTHM of the 70,000 MTHM is to be commercial spent nuclear fuel (DOE 2002). As shown in Table 6, the 2003 TSLCC Waste Stream predicts that more waste is sent in DPCs than the OWS since the 2003 TSLCC includes a larger portion of the older fuel.

Although the report comparing the waste streams originally recommended Case C (strict youngest fuel first) as a bounding scenario, Case B was carried forward because it was considered a more realistic estimate (DOE 2003). It is not clear why variations of the OWS were not *also* carried forward, since doing so would not seemingly require an excessive burden on future analyses, and could have provided a better understanding of the sensitivity of results to the waste stream. Nevertheless, subsequent DOE analyses in the PHA rely on Case B of the OWS.

---

<sup>13</sup> Section 3.0, Assumption 5.0 of DOE. (2003). "2002 Operational Waste Stream and 2003 TSLCC Waste Stream Backup Calculation."ACC:CAL-CRW-SE-000002, Department of Energy Office of Civilian and Radioactive Waste Management, Las Vegas, NV.

The following discussion takes the reader through the assumptions that allow DOE to use the quantities presented in Table 6 to estimate the expected frequency of certain events in the PHA. The entire commercial inventory in the OWS is about 430,700 CSNF assemblies (187,400 PWR and 243,300 BWR). A portion of the full waste stream (103,070 PWR and 102,916 BWR assemblies) is assumed to be included in the 70,000 MTHM legal capacity of YM. Assemblies are categorized as arriving in DPCs, bare-fuel transportation casks, or TADS. Of the 469 DPCs in the waste stream, 55% are assumed to be PWR and 45% BWR. This ratio is based on facilities selecting their youngest assemblies, at least 10 years old, to fulfill allocations. DOE assumes each DPC holds 36 PWR canisters or 74 BWR canisters in order to estimate the number of assemblies arriving in DPCs (BSAIC 2007b).

By subtracting the number of assemblies arriving in DPCs, DOE calculates the number of assemblies that will arrive either in bare-fuel transportation casks or in TADs. Approximately 88% of the assemblies that are not arriving in DPCs are assumed to arrive in TADs, and the remaining 12% are assumed to arrive in bare-fuel transportation casks (BSAIC 2007b). The basis for this proportion of TADs to bare-fuel casks is not given, but the author supposes it to be related to the criteria that no more than 10% of the entire waste stream will be in non-TAD form (BSAIC 2007a). It may also stem from the fact that a few waste generator sites, that do not have the heavy-load crane capacity or rail access necessary to accommodate TADs, will use smaller bare-fuel truck transportation casks.



Table 6

DOE Alternative Waste Stream Comparisons

|                               | Assemblies in<br>Total Inventory | Dual Purpose<br>Canisters (DPCs) |
|-------------------------------|----------------------------------|----------------------------------|
| 2002 Operational Waste Stream | 430,700                          | 469                              |
| 2003 TSLCC Waste Stream       | 335,700                          | 1,637                            |

See Table 9 of Ref.(DOE 2003), Table 12 of Ref.(DOE 2003). The author has chosen to use the same number of significant figures as provided by DOE.

Table 7

Expected Waste Stream Quantities

|  | Item                                       | Expected Quantity |
|--|--|-------------------|
|  | CSNF assemblies shipped in bare-fuel casks | 21,730            |
|  | DPCs                                       | 469               |
|  | Utility TADs (loaded at utilities)         | 5,676             |
|  | Site-specific TADs (loaded in the WHF)     | 1,571             |

See Table 3-1 of Ref.(DOE 2006e), Table 9 Ref. (DOE 2003). The author has chosen to use the same number of significant figures as provided by DOE.

The assemblies arriving in DPCs or in bare-fuel transportation casks are blended into TADs in the WHF. These TADs are referred to as “Site-specific” TADs. Conversely, TADs that were loaded at the utility sites are referred to as Utility TADs. A summary of the quantities of various casks assumed by DOE to be processed in the surface facilities is given in Table VII. DOE uses these waste stream quantities in its PHA to predict the frequency of certain events.

The following sections review how DOE determines the expected frequency of the following three internal events: (1) drop of a TAD canister with breach in air, (2) drop of a DPC with breach in air, (3) drop of a fuel assembly under water. The predicted dose consequences of the events are also discussed to provide a context for potential risk implications on variations in the frequency of these events.

### ***Frequency of Events***

DOE estimates the frequency of an event resulting from a crane failure as

$$x = t * p * c \tag{Eq.(1)}$$

where  $x$  is the number of occurrences of a drop over the 50-year emplacement operational period,  $t$  is the number of transfers over the emplacement period (number of items multiplied by the number of transfers per item),  $p$  is the probability of a drop per transfer, and  $c$  is a conservative factor of 1.1.

## Crane Drop Rate Assumptions

DOE assumes a crane drop rate involved with handling canisters and spent nuclear fuel assemblies to be equal to  $10^{-5}$  drops/transfer. This reliability rate is supported by past data from two surveys collected on nuclear plant lifts.

The first survey used is a data set of heavy load lifts that were at least 30 tons. This survey found a total of three drops out of 54,000 (Lloyd 2003). All three drops involved nylon or Kevlar sling failures. Except for the limited number of a specific type of transportation cask (used with Hi-Star DPCs), the lifts that will take place at YM will *not* incorporate slings. It is anticipated that no more than 70 transportation casks of this type will be handled at YM (DOE 2006e).

DOE uses the data in this survey to estimate the probability of failure as,

$$p = \frac{f}{n} \quad \text{Eq.(2)}$$

where  $p$  is the probability of failure,  $f$  is the number of failures, and  $n$  is the number of trials.

If the sling failures are included, then  $p$  is  $3/54,000 = 6 \times 10^{-5}$ . DOE also calculates the failure rate from the data using a noninformative Bayesian prior distribution (NRC 1983),

$$p = \frac{f + 0.5}{n + 1} \quad \text{Eq.(3)}$$

The noninformative prior distribution is a useful approach when there is little data regarding the prior distribution, because it reduces the relative importance of the prior likelihood compared to the data when estimating the posterior likelihood (NRC 1983). Applying this method, DOE estimates the drop rate without sling failures as  $0.5/54,001 = 9 \times 10^{-6}$  (DOE 2006e). The dilemma in using the data from this study is that all the drops

occurred using slings, and only a small percentage of the total number of transfers at YM are expected to employ the use of slings. If the slings are included, the estimate may be too high; if the slings are not included, the noninformative approach must be employed.

Another study cited by DOE in the PHA is recorded handling incidents of a variety of loads (heavy and light) that were caused by equipment failures and/or human error from 1985 to 1999 (BSAIC 2001). This data includes nine drop events out of 1,199,000 transfers. Applying Eq.(3), the probability of failure is  $8 \times 10^{-6}$ . Note that this is a lower rate of failure than the prior survey, even if the three sling failures are *not* included. But, the data mostly consists of assembly transfers, which are lighter than the canister transfers that will take place at YM.

Taking both the data sets into account, the failure ranges from  $8 \times 10^{-6}$  to  $6 \times 10^{-5}$ . DOE considers  $10^{-5}$  an adequate and conservative failure rate for a number of reasons: the cranes will include safety features; lifting operations will be highly controlled; and the use of slings will be limited.

### Number of Transfers

The number of transfers (T) of an item over the emplacement period depends on whether the item is a TAD or a DPC, and if aging is necessary prior to emplacement. The transfers, during which a breach is possible at each of the facilities, are summarized in Table VIII (also described in more detail in Appendix C). Note that TADs and DPCs going to the Aging Facility from the RF or WHF undergo an additional two (2) transfers when they are placed onto and removed from the aging pad. However, the structures, systems, and components that will be used in order to limit the severity of the drop cause

the event sequence to be Beyond Category 2. It should also be noted that since the design is not yet completed, the transfers described below may not reflect the *final* design.

Taking this into account, Utility TADs can undergo up to 6 transfers when a breach is possible: 3 at the CRCF and an additional 3 at the RF if they need to be aged first. Site-specific TADs undergo 7 transfers: 4 at the WHF and 3 at the CRCF. DPCs undergo at most 7 transfers: 4 at the WHF and an additional 3 at the RF if they need to be aged first. Also, there are up to 4 lid transfers where the lid could fall on a DPC causing its breach: 2 at the WHF and an additional 2 at the RF if aging is required.

In summary, the number of transfers of a particular item can be estimated conservatively assuming *every* canister requires aging or by explicitly counting the canisters that need aging. DOE calculates the expected number of occurrences for the drop events assuming every canister requires aging. The waste stream quantities in Table 7, a crane drop rate of  $10^{-5}$ , and a conservative factor of 1.1 “to provide a margin of conservatism and thus increased confidence that the expected number of drops is not underestimated” are applied (DOE 2006e). The deterministic estimates supplied in the PHA are repeated in Table 9.

Table 8

Number of Transfers per Item at Surface Facilities

|      | Number of Transfers per Item |                |          |
|------|------------------------------|----------------|----------|
|      | TAD <sup>a</sup>             | DPC            | Assembly |
| CRCF | 3                            | N/A            | N/A      |
| RF   | 3                            | 5 <sup>b</sup> | N/A      |
| WHF  | 4                            | 6 <sup>c</sup> | 2        |

<sup>a</sup> The TAD has a shield plug that is credited with absorbing the impact energy of a dropped lid so no lid transfers are included in this column.

<sup>b</sup> Vertical DPCs at the RF undergo 3 transfers, horizontal DPCs at the RF undergo 1 transfer, and there are 2 lifts of lids that could cause a DPC breach so 5 total transfers are assumed.

<sup>c</sup> DPCs undergo 4 transfers at the WHF and there are 2 lifts of lids that could cause a DPC breach so 6 total transfers are assumed.

Table 9

## Expected Number of Drops in 50-year Pre-Closure Period

| Item                                     | Number of Transfers/Item | Number of Items | Expected Number of Drops |
|--|--------------------------|-----------------|--------------------------|
| DPC                                      | 11                       | 469             | $5.7 \times 10^{-2}$     |
| Site-specific TAD                        | 7                        | 1,571           | $5.0 \times 10^{-1}$     |
| Utility TAD                              | 6                        | 5,676           |                          |
| Fuel Assembly shipped in bare-fuel casks | 2                        | 21,730          | $4.8 \times 10^{-1}$     |

See Table A-7, A-9, and A-11 of (DOE 2006e). The author has chosen to use the same number of significant figures as is documented in the PHA.



Based on frequencies derived from the OWS, DOE's PHA conducted in March 2006 found *no* Category 1 event sequences and twenty-two Category 2 event sequences (DOE 2006e). However, note that the number of fuel assemblies listed only includes those transferred from *bare-fuel transportation casks*. If the assemblies transferred from *DPCs* are included, the expected frequency is increased to 1.027, classifying the event as Category 1. This oversight is not expected to impact the overall assessment of this event since the dose consequence for the event is within Category 1 *and* Category 2 limits. However, it is useful to analyze the sensitivity of the expected frequencies to changes in operating scenarios since there is uncertainty surrounding the waste stream quantities.

It may be useful to revisit the waste stream quantities in Table 7 considering that over 690 dry storage containers (including DPCs and single-purpose containers) had been loaded at 30 nuclear sites as of December 2004 (NEI 2007). The volume of waste packaged in DPCs is expected to increase in the coming years as spent nuclear pools reach capacity. It is estimated that 20 reactors at 16 sites will need to load additional dry storage by 2010, and at least 22 more reactor sites will increase dry storage by the end of 2015 (NEI 2007). Furthermore, the utilities have little incentive to repackage fuel assemblies currently in DPCs into TADs.<sup>14</sup>

Since the waste stream determines whether events are Category 1 or Category 2, and hence, the regulatory dose limits for those events, there is merit in evaluating the importance of waste stream variations with respect to frequency estimation. Still, in order to gain perspective of the risk, the consequences of these events should be taken into account in addition to their frequencies.

---

<sup>14</sup> Personal communication with Steve Edwards, Spent Fuel Management Progress Energy. January 9, 2007.

### *Consequences of Events*

The consequences of the three events pertaining to this study, as they are defined in the SEIS by DOE, are listed in Table 10. Doses are provided for the maximally exposed off-site individual<sup>15</sup> and the hypothetical worker near the accident, referred to as the *non-involved* worker.<sup>16</sup> A dose is not provided for the involved worker because the structures, systems and components that protect the involved worker reduce the potential for these events to be Beyond Category 2. The NRC has determined that a 30-day exposure period dose is required in the SEIS as opposed to a full year (NRC 2007). Since the PHA doses are based on a one-year exposure period<sup>17</sup>, they are not in exact agreement with the doses listed in the SEIS. However, the differences in the calculated consequences are minimal.

---

<sup>15</sup> The maximally exposed individual is a hypothetical member of the public at the point on the analyzed land withdrawal area boundary who would receive the largest dose from the assumed accident scenario, which is either about 18.5 kilometers (11 miles) southeast of the repository site or 7.8 kilometers (4.8 miles) east of the site.

<sup>16</sup> This non-involved worker is assumed to be 60 meters (180 feet) from the release point.

<sup>17</sup> See Table B-8, Pg. B-15 of the PHA report

Table 10

Dose Consequence per Event

| Event Description                   | Amount of Material at Risk  | Non-Involved Worker TEDE Dose Sv /event (rem/event) (30-day exposure) | Off-site Public TEDE Dose Sv /event (rem/event) (30-day exposure) |
|-------------------------------------|---|---|---|
| Drop with breach of TAD             | 21 PWR or 44 BWR fuel assemblies                                      | $1.0 \times 10^{-2}$  | $6.4 \times 10^{-5}$  |
|                                     |   | $(1.0 \times 10^0)$   | $(6.4 \times 10^{-3})$  |
| Drop with breach of DPC             | 36 PWR or 74 BWR fuel assemblies                                      | $1.7 \times 10^{-2}$  | $1.1 \times 10^{-4}$  |
|                                     |   | $(1.7 \times 10^0)$   | $(1.1 \times 10^{-2})$  |
| Drop with breach of a fuel assembly | 2 PWR or 2 BWR fuel assembly (one drop of an assembly onto the other) | $2.6 \times 10^{-4}$  | $4.6 \times 10^{-6}$  |
|                                     |   | $(2.6 \times 10^{-2})$  | $(4.6 \times 10^{-4})$  |

See Table E-11 of the SEIS (DOE 2002). Consequence estimates are based on the amount of material at risk.

## **Analysis Methodology**

This section provides a brief overview of methodological assumptions used in this chapter to estimate the uncertainty surrounding the frequency of drop events. This includes methods used to generate waste streams and methods used to estimate the likelihood of the number of drop occurrences during the 50-year pre-closure period.

### ***Method to Generate Waste Streams***

The main differences between the approach used in this study and the assumptions in the OWS are summarized in Table 11. The CSNF inventory data used in this analysis differs slightly from that used by DOE for generating the OWS, in that a more recent inventory (2002 instead of 1998) is used, and a variety of pre-closure scenarios are considered. In using the 2002 versus the 1998 data set, the projections of waste discharges may be more accurate. However, since the 1998 and 2002 data set were not compared, the impact of using the more recent database was not evaluated.

Before the repository opens, utilities are assumed to load dry storage when their spent nuclear fuel pools run out of capacity. The TAD is assumed to be available sometime between the years of 2012 and 2020, after which all utilities adopt it for use. One of three orders for the selecting spent fuel assemblies from a facility's pool is applied: (1) oldest fuel first (OFF), (2) youngest fuel first at least five years old (YFF5), or (3) youngest fuel first at least ten years old (YFF10).

Table 11

Comparison of Approaches for Generating Waste Streams

|                               | DOE's 2002 Operational Waste Stream Case B Assumptions | Alternative Modeling Approach        |
|-------------------------------|--|--------------------------------------|
| Inventory of CSNF             | 1998 RW-859  | 2002 RW-859                          |
| Packages                      | Bare-Fuel Casks and DPCs                               | Bare-Fuel Casks, DPCs, and TADs      |
| Zone Loading                  | No   | Yes                                  |
| Short Loading                 | Yes  | No                                   |
| Allocation Trading            | No   | Yes                                  |
| Waste Removal Priority        | Pool   | Pool or Dry Storage                  |
| Dry Canister Removal Priority | N/A  | TADs, DPCs, or a proportional amount |
| Assembly Selection Algorithm  | YFF10  | OFF, YFF10, or YFF5                  |

TADs, DPCs, and bare-fuel transportation casks are expected to accommodate zone loading, meaning canisters are loaded with relatively hotter assemblies in the center and cooler assemblies around the outer perimeter. The 21-PWR and 44-BWR TADs will most likely be designed to hold 9/12, or 20/24 hot/cold assemblies respectively.<sup>18</sup> The per-assembly thermal power output limit for the hotter zone is designed to be twice that of the cooler zone. For example, the per-assembly limits for a 25 kW 21-PWR TAD are 1.67 kW for each of the 9 hotter assemblies and 0.83 kW for each of the 12 colder assemblies. The transportation heat limit is varied from 18kW to 25kW per cask.

After the repository opens (assumed to be sometime between 2020 and 2030), the equivalent of 250 TADs (as some combination of TADs, DPCs and bare-fuel transportation casks) are sent to the repository each year. This rate of shipment is applied to allow for 7,500 TADs to be shipped to YM over 30 years. A DOE study determined the receipt rate of 3,000 MTHM to be approximately equivalent to 250-300 TADs per year (BSAIC 2005d). The shipping campaign could be completed in approximately 24-30 years (DOE 2002). The author has chosen a shipping rate of 250 TAD-equivalents/yr, instead of 300 per year, so that the throughput results can be compared to DOE analyses that apply a 250 TAD-equivalent/yr processing rate (BSAIC 2007b).

In some scenarios, the facilities are assumed to send assemblies from the pool before sending dry storage. In other cases, TADs and DPCs that have already been loaded are sent before removing assemblies from the pools. Three variations of the order in which dry storage is removed are explored: (1) TADs before DPCs, (2) DPCs before TADs, and (3) proportional amounts of TADs and DPCs (e.g., if there are 10 DPCs and 5 TADs on

---

<sup>18</sup> Personal communication with Kris Cummings, Manager DOE Programs, Holtec. July 25, 2007

the storage pad and the facility has allocations for 6 shipments, 4 DPCs and 2 TADs are sent).

A summary of the independent variables (Table 12) and scenarios (Table 13) are provided. Response variables are defined and tracked as a function of the design and operating conditions defined for each scenario. The response variables are the counts of:

- dry storage containers loaded due to lack of capacity in the spent nuclear fuel pools before YM starts to receive waste
- TADs that could potentially be loaded assuming that utilities begin using the TAD as soon as it is commercially available
- shipments arriving above or below the emplacement limit each year
- canisters in the Aging Facility at YM each year
- canisters in the Aging Facility that are thermally cool enough to be removed from the Aging Facility each year

Table 12

Independent Deterministic Variable Values

| Parameter Name                         | Level 1  | Level 2  | Level 3                               |
|--|--|--|---------------------------------------|
| Year TAD in Use                        | 2012   | 2016   | 2020                                  |
| Year Repository Opens                  | 2020   | 2025   | 2030                                  |
| Transportation Thermal Limit           | 18 kW  | 21.5 kW  | 22 kW                                 |
| Emplacement Thermal Limit              | 11.8 kW  | 14.9 kW  | 18 kW                                 |
| Utility Assembly Selection for Loading | YFF at least 5 years old   | YFF at least 10 years old  | Oldest fuel first                     |
| Waste Removal Priority                 | Remove assemblies from the pool before removing dry storage casks. | Remove dry storage casks before removing assemblies from the pool. |                                       |
| Dry Storage Removal Priority           | TADs before DPCs   | DPCs before TADs   | Proportional amounts of DPCs and TADs |



Table 13  
Scenario Definition

| Parameter Adjusted           | Subscenario ID | Value   |         |
|------------------------------|----------------|---------|---------|
| Year TAD in Use              | R1             | High    | 2020    |
|                              | R2             | Low     | 2012    |
| Year Repository Opens        | R3             | High    | 2030    |
|                              | R4             | Low     | 2020    |
| Transportation Thermal Limit | R5             | High    | 25 kW   |
|                              | R6             | Low     | 18 kW   |
| Emplacement Thermal Limit    | R7             | High    | 18 kW   |
|                              | R8             | Low     | 11.8 kW |
| All Subscenario Parameters   | R9             | Central |         |

| Waste Removal Priority  | Dry Storage Removal Priority         | Assembly Selection | Subscenarios Explored |
|-------------------------|--------------------------------------|--------------------|-----------------------|
| Pool before dry storage | TADs before DPCs                     | OFF                | R1-R9                 |
|                         |                                      | YFF10              | R1-R9                 |
|                         |                                      | YFF5               | R1-R9                 |
|                         | DPCs before TADs                     | OFF                | R1-R9                 |
|                         |                                      | YFF10              | R1-R9                 |
|                         |                                      | YFF5               | R1-R9                 |
|                         | Proportional amount of TADs and DPCs | OFF                | R1-R9                 |
|                         |                                      | YFF10              | R1-R9                 |
|                         |                                      | YFF5               | R1-R9                 |
| Dry storage before pool | TADs before DPCs                     | OFF                | R1-R9                 |
|                         |                                      | YFF10              | R1-R9                 |
|                         |                                      | YFF5               | R1-R9                 |
|                         | DPCs before TADs                     | OFF                | R1-R9                 |
|                         |                                      | YFF10              | R1-R9                 |
|                         |                                      | YFF5               | R1-R9                 |
|                         | Proportional amount of TADs and DPCs | OFF                | R1-R9                 |
|                         |                                      | YFF10              | R1-R9                 |
|                         |                                      | YFF5               | R1-R9                 |

Upon arrival, waste is assumed to be routed according to the following process flows:

- TADs and DPCs above the thermal limit for emplacement are sent to the Receipt Facility (RF).
- DPCs arriving below the emplacement limit or being removed from the Aging Facility, as well as all bare-fuel transportation casks are sent to the Wet Handling Facility (WHF).
- TADs arriving below the emplacement limit, TADs loaded in the WHF, and TADs being removed from the Aging Facility (AF) are routed to the Canister Receipt and Closure Facility (CRCF).

The process flow assumed in this analysis omits certain paths compared to the flow defined in the SEIS for simplification purposes. The routing paths in the SEIS do not follow explicit rules, and therefore would have required a level of complexity that was not considered necessary for this analysis. The paths that have been eliminated are: cool DPCs or TADs are not routed to the RF, and TADs are not routed *from* the RF *to* the CRCF or from the WHF to the AF. Applying these rules for routing, the handlings required for different types of casks at the surface facilities are tracked to evaluate the potential safety implications of different waste streams.

### ***Method to Estimate Frequency of Drop Events***

The event of a crane drop can be described using a binomial distribution, assuming that the crane lifts are statistically independent, and the chance of failure for each lift is constant. In reality the chance of failure will most likely not remain constant for each lift. The reliability of the crane equipment will change over time depending on the age and

maintenance of the equipment. In addition, human errors will likely decrease as familiarity with the task and equipment increases over time. These two influencing factors may or may not counterbalance each other, but an assumption of constant failure probability is necessary to apply the binomial distribution. The number of transfers can be thought of as the number of trials for the crane to fail, and the probability of  $x$  drops out of a total of  $n$  trials can be described by the probability mass function of a binomial distribution as,

$$P(X = x, n | p) = \binom{n}{x} p^x (1-p)^{n-x} \quad x = 0, 1, 2, \dots, n \quad \text{Eq.( 4)}$$

The change in potential likelihood of the drop frequency can be explored through assuming different parameter values for  $p$  and  $n$ . Instead of *deterministically* calculating the event frequency using a point estimate for the drop rate and the number of transfers as in Eq.(1), the potential *likelihood* of the event frequency is estimated using the probability mass function of the binomial distribution.

## **Discussion of Results**

Yucca Mountain pre-closure design parameters and waste acceptance operating strategies will impact waste stream characteristics and, therefore, the expected number of times a drop will occur during pre-closure. Since many design and operating parameters are still uncertain, the following results should be used to provide a better understanding of the range of uncertainty associated with the data that support frequency estimates for these events, and not used as an evaluation of the safety of the final design.

### ***Uncertainty Regarding the Number of Transfers***

The number of transfers of assemblies, DPCs, and TADs is calculated for each of the 162 scenarios. Since the 162 scenarios were designed to test the relative impact of each of the subscenario parameters while holding all others at their central value, the scenarios are not randomly sampled, and therefore it is best to use the results to estimate the *range* in the number of transfers, and the relative impact of the independent parameters on number of transfers, and not the particular *distribution* of transfers resulting from the 162 scenarios.

The relative influence of the design and operating parameters on the number of transfers is illustrated through variability charts (Fig. 9). The results are separated into subscenarios R1 - R9 to illustrate the change as each parameter is manipulated from its high to low value. There are nine data points that contribute to the variation of each range bar: three options for dry storage removal priorities multiplied by three options for assembly selection order.

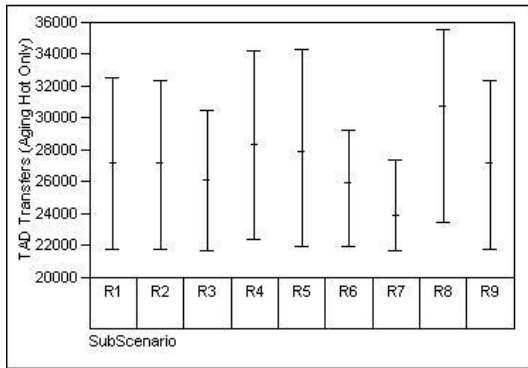

(a)

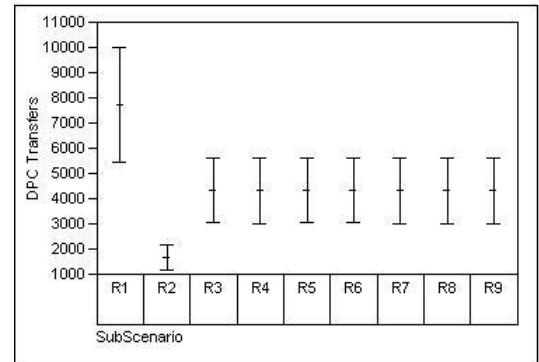

(b)

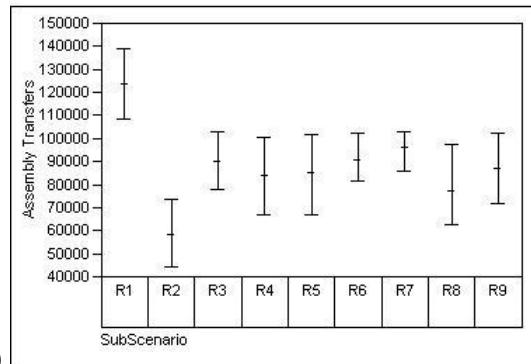

(c)

Fig. 9. Variability in the number of item transfers under different scenarios for design and operating conditions: (a) TAD transfers, (b) DPC transfers, (c) assemblies transferred.

Parameters that affect the amount of aging largely contribute to variation in the number of TAD transfers. For example, there is a relatively large difference in the number of transfers between scenarios R7 and R8 (change in thermal limit for emplacement), than from R1 to R2 (change in the year the TAD is available). On the contrary, variation in the number of DPC transfers is driven by the year the TAD is available.

If facilities prioritize shipments from their spent nuclear fuel pools over dry storage, the number of TAD transfers is slightly reduced for many of the subscenarios. This result is not intuitive since much of the waste already in dry storage is older, colder fuel. This result is primarily due to the assumption in the model that utilities use a consistent loading algorithm before and after the repository is open, starting in the year 2002 and the fact that the dry storage data prior to 2002 is not included.

Therefore when utilities load youngest fuel first, most of the packages in dry storage are still above the emplacement limit at the time YM opens. By removing waste from the pool first, the spent fuel already in dry storage at the utility sites cools *at the sites* as opposed to the Aging Facility *at YM*. Therefore, waste that may have required additional transfers by aging at YM is, instead, cooled on the storage pads at the utility sites. In reality, the decision to send canisters from the dry storage facilities before removing waste from the pool may likely have the opposite impact and *decrease* the amount of aging required at YM because utilities have been loading older fuel into dry storage.

When deciding how to prioritize removal of dry storage containers at the facility site, the model assumes facilities choose to send TADs first, DPCs first, or a proportional amount of TADs and DPCs. (Canisters are chosen for shipment on a first in first out

basis within each category.) Removing TADs before DPCs results in a slightly higher number of transfers since a greater number of TADs are aged at YM as opposed to the utility sites. The effect is less apparent when waste is removed from the pool first since most of the waste in dry storage has already cooled below the emplacement limit by the time it is sent to YM. Since all DPCs will eventually be repackaged into Site-specific TADs that are assumed to require 7 transfers regardless of their thermal characteristics, the thermal power output of DPCs arriving at YM does not affect the number of *TAD transfers*.

An important observation is that the scenario resulting in the minimum or maximum number of *TAD* transfers, also results in the minimum or maximum number of *DPC* transfers. Sending older fuel first, allowing for a higher emplacement limit, and enforcing a lower transportation limit reduce the number of TAD transfers because fewer packages require aging. A later opening of the repository allows more time for the waste to cool, reducing the number of TADs that require aging. An earlier availability of the TAD decreases the number of Site-specific TADs (which require more lifts). The scenarios with the maximum and minimum number of transfers are described in Table 14. The range in transfers is summarized in Table 15.

Table 14

Scenarios Resulting in Minimum and Maximum Number of Transfers

| Parameter                     | Minimum Number of Transfers | Maximum Number of Transfers |
|-------------------------------|-----------------------------|-----------------------------|
| Year TAD in Use               | 2012                        | 2020                        |
| Year Repository Open          | 2030                        | 2020                        |
| Transportation Heat Limit     | 18 kW                       | 25 kW                       |
| Emplacement Heat Limit        | 18 kW                       | 11.8 kW                     |
| Waste Removal Priority        | Pool before Dry Storage     | Dry Storage before Pool     |
| Dry Canister Removal Priority | DPCs before TADs            | TADs before DPCs            |
| Assembly Selection Algorithm  | OFF                         | YFF5                        |



Table 15

## Range in Number of Transfers

| Variable           | Lower Bound | Upper Bound         |
|--------------------|-------------|---------------------|
| TAD Transfers      | 22,000      | 45,000 <sup>a</sup> |
| DPC Transfers      | 1,000       | 10,000              |
| Assembly Transfers | 20,000      | 140,000             |

<sup>a</sup>This range in transfers does not reflect the range shown in Fig. 9 because it incorporates the possibility that *all* canisters might be aged. For example, if 7,500 TADs are emplaced in YM, there could be as many as 45,000 transfers (six per TAD).

### *Uncertainty Regarding the Frequency of Events*

Results in Fig. 10 show that DOE's PHA estimates do not conservatively bound the range of frequencies generated by this study for any of the events. However, DOE's point estimates do fall within the likely area of the distributions. DOE's estimates are not conservatively bounding primarily because the author considered scenarios with more than 469 DPCs. Still, even taking into account the upper range in number of transfers that could occur, the events are likely to be Category 2 or Beyond Category 2. For example, the probability that the number of assembly drops is less than or equal to one using the binomial distribution in Fig. 10(c), is 0.98 in 20,000 transfers and 0.84 in 140,000 transfers.

Additional variation in the event frequency can be explored by changing the crane drop rate assumptions. As seen in Fig. 11, increasing the drop rate to be  $6 \times 10^{-5}$  alters the shape of the distributions for the number of event occurrences. This crane drop rate corresponds to the survey that found 3 failures of the slings in 54,000 trials, and is most likely an overly conservative drop rate since slings will not be used for the most part at YM. While the chances of the events being classified as Category 1 are greater with this increase in the drop rate, one needs to keep in mind the consequences resulting from a single occurrence and how they relate to the regulatory limits.

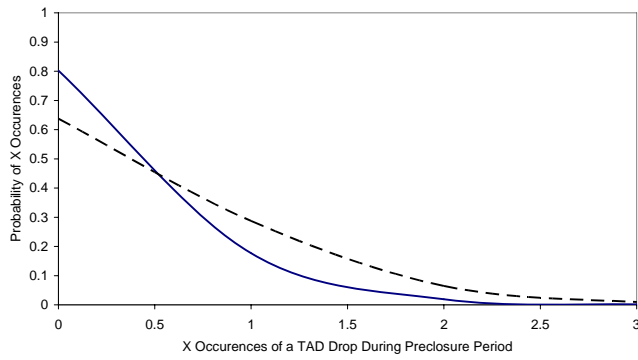

— 22,000 Transfers Drop Rate of  $1e-5$   
 - - 45,000 Transfers Drop Rate of  $1e-5$

(a)

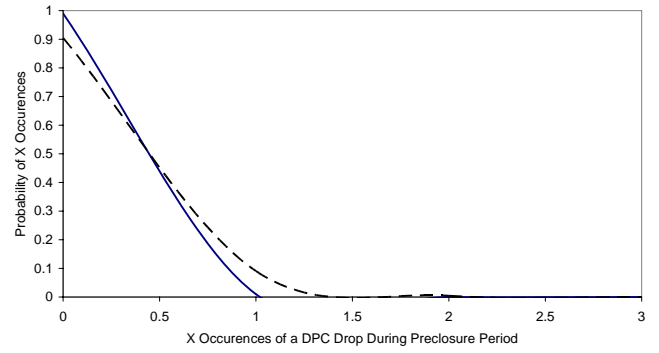

— 1,000 Transfers Drop Rate of  $1e-5$   
 - - 10,000 Transfers Drop Rate of  $1e-5$

(b)

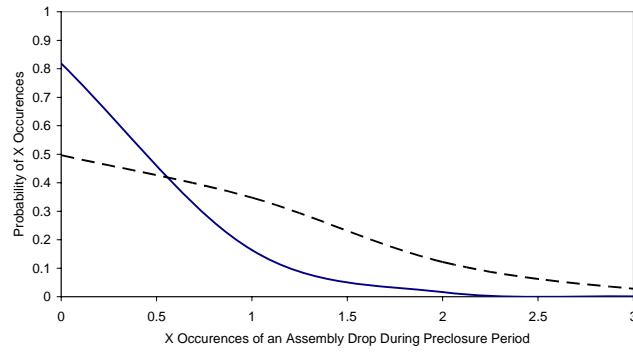

— 20,000 Transfers Drop Rate of  $1e-5$   
 - - 140,000 Transfers Drop Rate of  $1e-5$

(c)

Fig. 10. Expected number of occurrences of a drop over the 50-year pre-closure period assuming a crane drop failure rate of  $1 \times 10^{-5}$ : (a) TAD, (b) DPC, and (c) bare-fuel assembly.

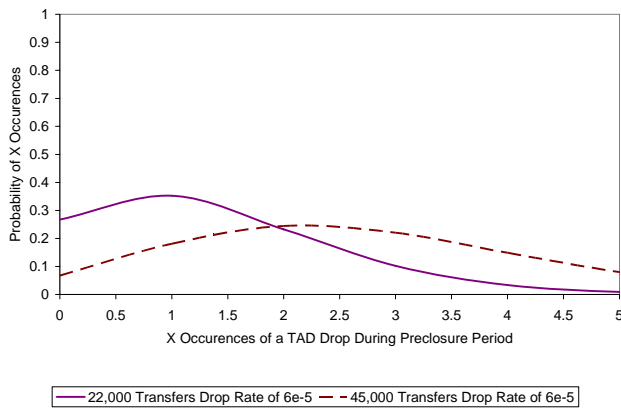

(a)

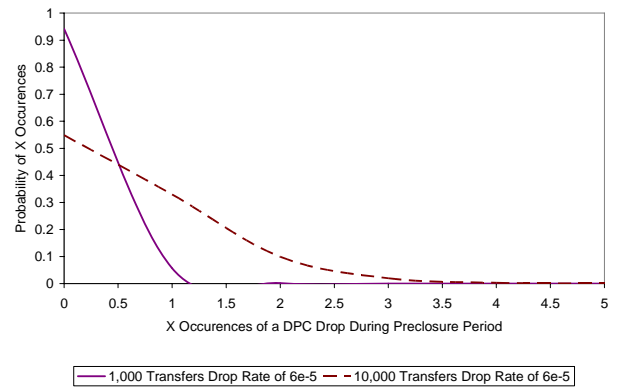

(b)

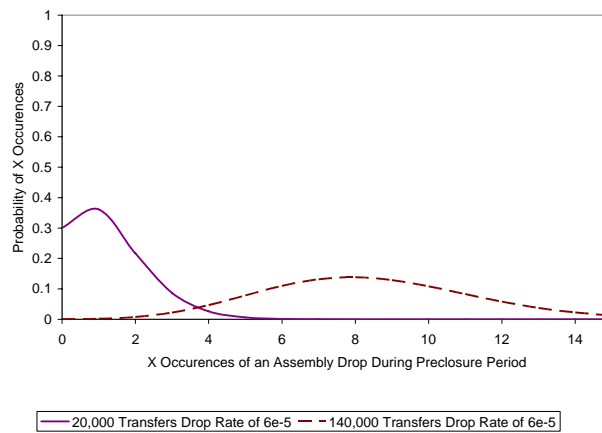

Fig. 11. Expected number of occurrences of a drop over the 50-year pre-closure period assuming a crane drop failure rate of  $6 \times 10^{-5}$ : (a) TAD, (b) DPC, and (c) bare-fuel assembly. Note the change in x-axis in (c).

If these events were determined to be Category 1 (expected frequency  $\geq 1$ ), as opposed to Category 2 (expected frequency  $< 1$  but  $\geq 10^{-4}$ ), DOE would need to show that the dose consequence meets the Category 1 limits of no more than .05 Sv (5 rem)/yr to workers, no more than 0.15 mSv (15 mrem)/yr to the off-site public, and no more than 1 mSv (100 mrem)/yr to the on-site public. It might also be considered that the non-involved worker doses for dropping a single TAD or DPC both exceed the 5 mSv (500 mrem)/yr ALARA goal.

Although the consequences are within Category 1 *and* Category 2 limits for a single occurrence of all three events, one should consider the assumptions that went into determining these doses. For example, there is potential for the breach of a TAD or DPC, if unmitigated, to result in an offsite dose consequence that could exceed the performance requirements of 10 CFR § 63 due to the oxidation of damaged fuel assemblies. Therefore, DOE takes credit for HEPA filters when calculating this dose estimate to ensure that the offsite dose remains within allowable limits (DOE 2006e).

Also, one should consider that the consequences are listed per event and the requirements are in yearly doses. The worker dose consequence of a *single* TAD drop of 0.01 Sv (1 rem) is within the Category 1 dose limit of 0.05 Sv (5 rem)/yr for workers. Also, the public dose consequence for a single TAD drop of  $6.4 \times 10^{-2}$  mSv (6.4 mrem) is within the limit of  $1.5 \times 10^{-1}$  mSv (15 mrem)/yr. It is clear that the consequences for this event do not exceed the dose limits for Category 1, but it is difficult to compare a dose consequence for *one event* with a requirement over the time span of *one year*. For example, since the consequence to off-site public of dropping one TAD is about half the regulatory yearly dose limit, more than two TADs would have to be dropped in a single

year in order to exceed the off-site *public* dose limit. Five or more TADs would have to be dropped in a single year in order for the expected dose consequence to exceed the Category 1 limit for *workers* of 0.05 Sv (5 rem)/yr.

The same calculations can be made regarding the drop of a DPC canister or an assembly. If three or more DPCs are dropped in a single year, the regulatory limit for workers of 0.05 Sv (5 rem)/yr may be exceeded. If more than one DPC is dropped in a single year, the consequence would exceed the Category 1 limit for public. More than approximately 190 assemblies would have to be dropped to exceed the worker limit and more than about 30 assemblies would have to be dropped to exceed the off-site public limit. A summary of the number of events that would need to occur in a single year in order to exceed the Category 1 dose limits is provided in Table 16.

Table 16

Number of Events Needed to Occur in a Single Year for the Dose Consequence to Exceed Category 1 Limits

| Event Description                   | TEDE Dose Consequence Sv /event |                      | Number of Events Needed to Occur in a Single Year for Dose to be $\geq$ Category 1 Limit |                 |
|-------------------------------------|---------------------------------|----------------------|--|-----------------|
|                                     | Non-Involved Worker             | Off-site Public      | Non-Involved Worker  | Off-site Public |
| Drop with breach of TAD             | $1.0 \times 10^{-2}$            | $6.4 \times 10^{-5}$ | 5  | 3               |
| Drop with breach of DPC             | $1.7 \times 10^{-2}$            | $1.1 \times 10^{-4}$ | 3  | 2               |
| Drop with breach of a fuel assembly | $2.6 \times 10^{-4}$            | $4.6 \times 10^{-6}$ | 190  | 30              |

See Table E-11 of the SEIS (DOE 2002) for consequence estimates. Consequence estimates are based on the amount of material at risk.

As stated, at least three TADs would need to be dropped in a single year in order to exceed the Category 1 limit for the *public*; at least five drops would have to occur in a single year in order to exceed the Category 1 limit for *workers*. In a single year, the number of trials for a TAD is in the range of 250-300. The chance of *more* than 3 events occurring  $P(X > 3) = 1 - P(X \leq 3)$ . The probability of less than three TADs dropping in a single year  $P(X \leq 3)$  can be found by integrating the probability mass function, or directly by using the binomial cumulative distribution function. For example, assuming a drop rate of  $6 \times 10^{-5}$  and 300 trials in a single year,  $P(X \leq 3) \approx 1$ , so  $P(X > 2) \approx 0$ . This type of analysis can be also shown for  $x$  occurrences of DPC drops and assembly drops occurring in a single year and is a useful way to communicate the potential frequency of the events.

## **Conclusions and Recommendations**

This chapter reviews the basis for DOE's waste stream assumptions in the *Preliminary Hazards Analysis* for pre-closure operations. The review is an exercise that brings to light the tendency for extensive projects drawn out over long periods of time to grandfather past analyses, assumptions and data, often without considering the benefits that could be gained from a renewed approach. Although a number of possible waste streams were originally generated by DOE, only a single variation of one (Case B of the OWS) was carried forward. After which, point estimates of items contained in the OWS were used to estimate the frequency of three internal pre-closure events.

The following insights can be drawn from this research:

- TADs and DPCs that need to be aged require more crane transfers than those that do not. Therefore, the scenarios that require less casks to be aged (e.g.,



oldest fuel first and/or higher emplacement limit scenarios) also require less expected total package handlings.

- Scenarios that contained fewer DPCs resulted in lower frequencies of dropping a DPC *or* a TAD because TADs that are loaded at YM potentially require more transfers than TADs loaded at the utility site.
- Although DOE applied a conservative approach in assuming every package will require aging, the estimates did not conservatively bound the frequencies generated by this analysis. This is a result of using a single waste stream and crane drop rate in a deterministic function for calculating the number of occurrences.

Since the number of TAD transfers, the number of assembly transfers, and the number of DPC transfers all increase with the number of DPCs and bare-fuel casks, DOE may want to reconsider the number of DPCs assumed in the waste stream. Accurately estimating the number of bare-fuel transportation casks or DPCs in the waste stream is difficult because of the variety of DPC sizes that exist, and the unpredictability regarding which DPCs may be repackaged into TADs at the utility sites. Because DPCs are already on the storage pad of the waste generators, there seems little reason to move them in order to store them *again* at YM. By negotiating agreements that reduce the number of DPCs that need to be aged and repackaged at YM, DOE could reduce the potential frequency of a canister drop.

Still, DOE estimates were within the likely range of frequencies that was generated in this analysis. And, the consequences of these events are low enough that their categorizations will not likely impact the ability to meet regulatory requirements,

(provided that the assumptions regarding the systems structures and components relied upon for the dose estimates, such as the HEPA filter, are reasonable). Considering the inconclusiveness surrounding future waste schedule negotiations, DOE could strengthen its PHA by adopting a probabilistic approach to estimating the frequencies of the drop events. This would help to communicate the risk posed by the events, and allow for an analysis that is less reliant on deterministic estimates for waste stream quantities and crane drop rates.

## CHAPTER IV

### SURFACE FACILITY THROUGHPUT WASTE STREAM VARIATIONS

#### Abstract

This chapter also focuses on the impact of waste stream variations on throughput during pre-closure operations at the proposed repository for high-level waste at Yucca Mountain (YM), NV (Spradley, Abkowitz and Clarke 2008; Appendix D). The objective of the research is to gain a better understanding of how waste stream variations affect surface facility throughput, defined as the rate at which packages are prepared for aging or emplacement in the surface facilities at YM. The basis for, and adequacy of, the current surface facility throughput requirements are reviewed by evaluating throughput performance subject to various waste stream scenarios.

Results indicate that, under most scenarios, DOE's design adequately accommodates the *mean* demand over the operating lifetime for the Canister Receipt and Closure Facility (CRCF) and Receipt Facility (RF), but not the Wet Handling Facility (WHF). Pending future negotiations between the waste generators and DOE, the WHF capacity may need to be increased in order to efficiently handle assemblies arriving in Dual-Purpose canisters (DPCs) or bare-fuel transportation casks. DOE should strive to negotiate schedules that uniformly distribute shipments of DPCs and avoid shipments of very hot DPCs, so the WHF might be able to handle *all* incoming DPCs and bare-fuel casks.

Results also show a high potential for variability in annual throughput demand at the CRCF and RF that might result in system backups. In the event of bottlenecks, underused facilities may need to fulfill functional roles of those that are over-burdened. The over-lap of functional capability confuses design goals for the system. An alternative design is proposed that is based on functional goals of the facilities as opposed to the buildings themselves, along with other recommendations.

## **Introduction**

### ***Yucca Mountain Pre-Closure Waste Management System***

The U.S. Department of Energy (DOE) is currently designing a geologic repository for the nation's high-level nuclear waste (HLW) at Yucca Mountain (YM), NV. The plan for the repository can be categorized into two temporal phases: pre-closure and post-closure. During pre-closure, the waste is transported to YM, processed at the YM surface facilities, and emplaced in the repository. After all the waste has been emplaced, the drifts will remain open and will be monitored for up to 300 years before the repository is to be closed.

Construction of the repository will not be fully complete before shipments of waste commence. Instead, DOE is planning a phased approach to constructing surface facilities and excavating repository drifts. Waste will be shipped over an approximately 25 to 30-year time period and emplacement activities may continue for up to 50 years following the opening of the repository.. Emplacement rate is not expected to keep up with the

shipment arrival rate due to the pace of drift excavation, as well as thermal constraints, which may delay emplacement. The thermal management strategy requires each waste package to be below a specified thermal energy (kW) before it can be emplaced. Waste that does not meet the criteria will be aged above ground at YM until it cools.

A recent design change calls for approximately 90% of the commercial spent nuclear fuel (CSNF) to be packaged at the utility sites in canisters that can be used for transport, aging, and disposal (TAD). This comprises roughly 80% of the entire 70,000 metric tons of heavy metal (MTHM) destined for YM since CSNF makes up 90% of the waste stream. The remaining 10% of CSNF will be shipped either in transportation casks carrying bare-fuel assemblies or in Dual-Purpose casks (DPCs). Upon arriving at YM, waste will be prepared for emplacement or aged at the surface facilities. Under the new design, routing of CSNF at the repository site will be primarily governed by its thermal characteristics, whereas prior to this decision, thermal characteristics were not as critical of a driver. This is because, prior to the design change, DOE had the opportunity to co-mingle hot and cold assemblies to meet thermal limits.

### ***Surface Facility Process Flow***

The surface facilities at the repository will be used for the following functions as defined in the SEIS:

- The Initial Handling Facility (IHF) will receive DOE HLW and Naval spent nuclear fuel, and prepare it for emplacement.
- The Canister Receipt and Closure Facility (CRCF) will transfer TADs from transportation overpacks to disposal overpacks, but will also be able to

transfer TADs or DPCs to aging overpacks to be sent to the Aging Facility. In addition, the CRCF could be used for transferring DOE HLW and SNF canisters to disposal packages. The disposal overpacks that have been loaded with canisters will be welded at the CRCF. DOE plans to construct as many as three CRCFs in a phased approach.

- The Wet Handling Facility (WHF) will receive DPCs and bare-fuel transportation casks. Each DPC or bare-fuel transportation cask will be placed in a pool and the assemblies within it will be transferred to a TAD. Then, the TAD will be removed from the pool, placed in the appropriate overpack, and sent to the CRCF or the Aging Facility.
- The Receipt Facility (RF) primarily will function to receive TADs or DPCs that are too hot to be emplaced and transfer them into aging overpacks to be sent to the Aging Facility. However, the RF also can be used to handle canisters that are cool enough to be emplaced, but nevertheless require storage due to bottlenecks in the CRCF. *(Note that the RF design is very similar to the CRCF absent the capability to weld disposal overpacks.)*

The receipt rate of YM will ramp up during the first 5 years. The initial operating capability (Year 1) commences when the IHF, CRCF-1, and WHF are fully constructed. The RF will come on-line at the start of Year 2, CRCF-2 at the start of Year 4, and CRCF-3 at the start of Year 5 (DOE 2006a). Once the third CRCF is on-line, the repository is expected to have sufficient capacity to handle a steady-state rate of 3,000 MTHM (Table 17). The receipt rate ramp-up assumptions originally formed the basis for surface facility throughput criteria.

Table 17

Receipt Rate for Yucca Mountain

|                          | Year<br>1 | Year<br>2 | Year<br>3 | Year<br>4 | Year<br>5 |
|--------------------------|-----------|-----------|-----------|-----------|-----------|
| Quantity Received (MTHM) | 400       | 600       | 1,200     | 2,000     | 3,000     |
| IHF                      | X         | X         | X         | X         | X         |
| CRCF-1                   | X         | X         | X         | X         | X         |
| CRCF-2                   |           |           |           | X         | X         |
| CRCF-3                   |           |           |           |           | X         |
| WHF                      | X         | X         | X         | X         | X         |
| RF                       |           | X         | X         | X         | X         |

See Ref. (DOE 2006a)

## **Research Objectives**

This research aims to gain a better understanding of the surface facility throughput performance through the following objectives:

- Review the waste stream assumptions made by DOE in the basis for the surface facility throughput capacity.
- Generate multiple waste streams, as a function of repository design parameters and operating strategies, in order to estimate the variability in demand for the surface facilities at YM.
- Evaluate the ability of the current design to meet estimated demand.
- Provide recommendations for possible improvements to the current design.

## **Review of DOE Surface Facility Criteria**

### ***Initial Throughput Criteria***

Initial throughput criteria, in terms of MTHM/yr for each facility, are documented with the TAD-based repository design (BSAIC 2006). As shown in Table 18, the original goals afforded a wide contingency margin by designing the facilities with nearly 100% excess capacity over the steady-state receipt rate.

The basis for these initial requirements was as follows (BSAIC 2006):

- Year 1 is not used as a driving factor because only 400 MTHM are expected.

The sum of waste received during Years 2-4 is used as a starting point for



design since this amount (3,800 MTHM) is close to the steady-state receipt rate.

- CRCF-1 is required to operate alone for the entire 3 years from Year 2-4 even though CRCF-2 will come on-line by Year 4, and the 3,800 MTHM will not be *entirely* commercial waste. Dividing 3,800 MTHM by 3 years equates to 1,267 MTHM/yr for CRCF-1. In the steady-state years, the remainder of 3,000 MTHM minus 1,267 MTHM, or 1,733 MTHM, is split between CRCF-2 and CRCF-3 (867 MTHM/yr each). This requirement could be thought of as inconvenient since it calls for CRCF-2 and CRCF-3 to be a different size than CRCF-1. Furthermore, it could be construed as overly conservative to design the three CRCFs to process 25% more than the steady-state receipt rate when a portion of the 3,000 MTHM is likely to be routed to the RF and WHF.
- The WHF must be capable of processing 10% of the 3,000 MTHM (300 MTHM) that will not arrive in TADs, and instead will arrive either in bare-fuel transportation casks or in DPCs. This is based on the assumption that DOE is able to reach agreements with the utilities regarding what DPCs will be included in the waste stream, ensuring that non-TAD packaging will constitute no more than 10% of all shipments.
- The RF is expected to process fully 90% of the 3,000 MTHM (2,700 MTHM) that is anticipated to arrive within TAD canisters. Again, it could be construed as overly conservative to design the RF to process the entire TAD-waste stream when a portion of TADs are likely to be routed to the CRCF.

The criteria in Table 18 were not adopted because excess capacity during the ramp up and steady-state years was considered unnecessarily large. The study states that “while some design margin in terms of excess capability is desirable and even necessary, this 200% and 100% excess capacity is much more than may be needed.”(BSAIC 2007b) Therefore, new throughput goals were defined to reduce excess capacity to a more reasonable range of 10%-50% (BSAIC 2007b). A study defining new criteria, *Nuclear Facilities Receipt Rate Requirements Analysis Engineering Study*, considers a variety of scenarios, including ranges in thermal characteristics of TAD canisters. Still, the general approach taken isolates each facility as opposed to considering them as an interconnected system. Also, *all* alternative scenarios are based on a *single* case of the 2002 Waste Stream Projections Report, which limits the robustness of the study.

Table 18

Initial Surface Facility Performance Requirements for TAD Concept

|                                  | Year 1 | Year 2 | Year 3 | Year 4 | Year 5 + |
|----------------------------------|--------|--------|--------|--------|----------|
| Quantity Received CSNF (MTHM/yr) | 400    | 600    | 1,200  | 2,000  | 3,000    |
| Processing Capacity              |        |        |        |        |          |
| CRCF-1                           | 1,267  | 1,267  | 1,267  | 1,267  | 1,267    |
| CRCF-2                           | 0      | 0      | 0      | 867    | 867      |
| CRCF-3                           | 0      | 0      | 0      | 0      | 867      |
| WHF                              | 300    | 300    | 300    | 300    | 300      |
| RF                               | 0      | 2,700  | 2,700  | 2,700  | 2,700    |
| Total Capacity                   | 1,567  | 1,567  | 4,267  | 5,134  | 6,000    |

Significant figures are consistent with those provided in DOE documents (BSAIC 2006).

### ***New Throughput Criteria***

The design for steady-state operations recommended by the *Nuclear Facilities Receipt Rate Requirements Analysis Engineering Study* is outlined in Table 19 (BSAIC 2007a). As seen, much of the excess capacity is eliminated, but the logic behind this set of more complicated requirements is debatable. The following discussion takes the reader through DOE's assumptions in developing the new criteria.

The 2002 Operational Waste Stream (OWS) is used in conjunction with the receipt rates for YM as a basis for the new requirements. Since the OWS was defined prior to the TAD design change in 2006, the waste stream did not include TADs. Instead, the OWS consists of bare-fuel rail shipments, legal weight bare-fuel truck shipments, and DPC rail shipments (BSAIC 2003). The bare-fuel rail shipments were assumed to be arriving as TADs, but no other adjustments were made to the OWS in applying it to the new criteria. This implies that DOE assumes that the DPCs and bare-fuel truck casks included in the OWS are not impacted by the decision to use the TAD.

### ***Wet Handling Facility***

In order to define the expected demand on the WHF, DOE looked back at the distribution of annual rates of legal weight bare-fuel truck casks and DPCs documented in "Case B" of the OWS. The 4<sup>th</sup> highest peak from each distribution was chosen as a reasonable design goal for processing bare-fuel truck casks and DPCs. This equates to 140 bare-fuel truck casks (~230 MTHM) and 26 DPCs (~286 MTHM). (Note that the highest peak from each distribution was 167 bare-fuel casks and 36 DPCs, respectively.)

DOE judged 26 DPCs/yr as exorbitant for the WHF because a portion of the DPCs are expected to be too hot to be sent directly to the WHF and must be aged at YM instead.

Since the previously defined criterion for the WHF was only 300 MTHM, the study concludes that the remainder after accounting for the 230 MTHM in bare-fuel truck casks (70 MTHM) was a sufficient DPC capacity for the WHF. The 70 MTHM is rounded up to 77 MTHM to be adequate for processing 7 DPC at 11 MTHM per DPC. The basis for deciding that each DPC is 11 MTHM is not explained. In other studies, DOE has assumed that DPCs contain at most 36 PWR or 74 BWR assemblies and assemblies weigh on average 425 kg (PWR) or 175 kg (BWR). This leads to concluding that larger PWR and BWR DPCs weigh 15 or 13 MTHM, respectively. Applying these same assumptions, DPCs weighing 11 MTHM would carry 25 PWR or 63 BWR assemblies. An estimate of 11 MTHM per DPC may be reasonable, but seems superfluous to add 7 MTHM to the criteria just so it is divisible by 11, considering the uncertainty surrounding the size of DPCs.

### ***Canister Receipt and Closure Facility***

Given that 300 MTHM of the 3,000 MTHM is allocated to the WHF, the remaining 2,700 MTHM is split between three CRCFs and the RF. The method of allocating the remaining 2,700 MTHM among three CRCFs and the RF is derived from the assumption that 50% of the waste will arrive above the thermal emplacement limit of 11.8 kW (referred to as “hot”). One might expect that the entire portion assumed to be arriving in hot TADs ( $0.5 \times 2,700 \text{ MTHM} = 1,350 \text{ MTHM}$ ) would be routed to the RF and the remainder to the CRCFs. However, the study concludes that only 70% of the 1,350

MTHM, or roughly 1,000 MTHM, is routed to the RF. This is because there are three CRCFs and only one RF in the design, and DOE states it would not be rational to set the criteria for *one* RF equal to that of *three* CRCFs.

Requiring three CRCFs poses a “chicken or an egg” type of dilemma. It begs the question of whether the decision for three CRCFs was made *before* the design requirements were established. Why should the design be based on the premise that there will be three CRCFs? Typically, one would demonstrate a *need* for the number of CRCFs to be built by analyzing the expected total CRCF demand and a reasonable capacity for a building like a CRCF. Also, in determining the goals for the CRCFs, DOE neglected to account for use of the RF for transferring TADs into disposal overpacks. The capacity of the RF in relation to the CRCF is especially important after the shipping campaign has ended because the RF will no longer be needed to receive waste. Thus, the RF capacity for transferring canisters could supplement the CRCF capacity.

In addition to the 1,000 MTHM of hot TADs, the RF is required to have capacity for DPCs that are too hot to be routed to the WHF. Following the same rationale used for TADs, approximately one-half of the DPCs would fall into this category. Instead of using the 4<sup>th</sup> highest peak (26 DPCs) of the distribution generated in Case B of the OWS as an upper bound for the number of DPCs arriving in a given year (as was done for the WHF), DOE uses the highest peak of 36 DPCs (396 MTHM).

The same logic used for TADs is also applied for DPCs in that only 70% of the “hot” DPCs are routed to the RF, resulting in a criteria of 140 MTHM (396 MTHM \* 50%\*70%) of DPCs. The goal of 140 MTHM is rounded up to 150 MTHM for reasons

unstated. The incorporation of a 10% buffer is an example of an arbitrary conservatism with little clarification of how it may improve the ability to reach design goals.

TADs that are less than 11.8 kW (1,350 MTHM) are split between the three CRCFs (450 MTHM each). In addition, hot TADs that were *not* routed to the RF are sent to the CRCFs. However, the study adds a 10% buffer, assuming that 40% (as opposed to 30%) of the hot 1,350 MTHM (~600 MTHM) are sent to the CRCFs (200 MTHM each). Applying this logic to DPCs, 40% of hot DPCs are sent to the Aging Facility via one of the CRCFs ( $396 \text{ MTHM} * 50\% * 40\% = 79 \text{ MTHM}$ , rounded up to 90 MTHM, or 30 MTHM for each CRCF). A few of the cooler DPCs (20 MTHM in each CRCF) are added to the expected demand for each CRCF because the RF or WHF are not expected to be able to accommodate them. This yields a total capacity of 50 MTHM in DPCs for each CRCF.

The criteria are summarized in Table 19 in terms of MTHM. The criteria have also been converted to units of TADs, DPCs, or bare-fuel assemblies. This conversion required assuming the ratio of BWR to PWR TADs arriving each year, as well as the size of DPCs that are used. Assuming DPCs carry 36/74 PWR/BWR assemblies and half the containers are PWR while the other half are BWR, facilities should be able to process approximately 420 TADs per year.

Table 19

## New Surface Facility Performance Requirements for TAD Concept

| ITEM                             | WHF  |            |             | 3 CRCFs |              | RF    |              | TOTAL |                  |
|----------------------------------|------|------------|-------------|---------|--------------|-------|--------------|-------|------------------|
|                                  | MTHM | Assemblies | TADs Loaded | MTHM    | TADs or DPCs | MTHM  | TADs or DPCs | MTHM  | TAD - Equivalent |
| Bare CSNF                        | 230  | 770        | 30          | N/A     | N/A          | N/A   | N/A          | 230   | 30               |
| DPCs                             | 77   | 250        | 10          | 150     | 10           | 150   | 10           | 377   | 40 <sup>a</sup>  |
| TADs < Thermal Emplacement Limit | N/A  | N/A        | N/A         | 1,350   | 160          | N/A   | N/A          | 1,350 | 160              |
| TADs > Thermal Emplacement Limit | N/A  | N/A        | N/A         | 600     | 70           | 1,000 | 120          | 1,600 | 190              |
| TOTAL                            | 307  | 1,000      | 40          | 2,100   | 250          | 1,150 | 130          | 3,557 | 420              |

Assumes 50% of the assemblies arrive as PWR and 50% as BWR, significant figures for MTHM are the same as DOE's, number of assemblies and canisters are rounded to the nearest ten.

<sup>a</sup> DPCs are converted to TAD-equivalents, causing the total to be slightly greater than the sum across all columns



### *Analysis of New Criteria*

The rationale behind some of the conjectures in the new design, mainly the routing of DPCs to the CRCF or the RF and the presupposition that 50% of the waste will be below the thermal emplacement limit any given year, merits further investigation.

#### Routing of Dual-Purpose Canisters

The original purpose of the CRCF *does not* include handling DPCs (DOE 2002). DPCs come in a variety of shapes and sizes and some may require special pedestals for movement into the transfer pit of a facility. They are also expected to constitute less than 10% of the entire waste stream (BSAIC 2007e). This provides motivation to *limit the number of facilities that are required to handle DPCs* - not complicate the surface facility design by expecting the RF, WHF, and three CRCFs *all* to be able to process DPCs.

The necessity of aging DPCs at YM is also debatable. It seems redundant to age *any* of the DPCs at the repository surface considering DPCs are *already* on the aging pads at the facilities, and most contain older spent nuclear fuel. Waste generators are expected to send waste from their spent nuclear fuel pools *prior* to removing waste that is already in dry storage containers in order to free up space in the pools, so it is reasonable that they would be amenable to staggering DPC shipments. As is demonstrated in Chapter 3, aging DPCs at YM requires extraneous material transfers that could be avoided.

A better approach may be to design the WHF to accommodate *all* the DPCs arriving each year. This could be achieved if the rate of DPC arrival is somewhat uniformly spread over the entire shipping campaign. That way, the design for the WHF can be kept at a reasonable capacity, while still maintaining the ability to process all DPCs and bare-fuel casks in the WHF immediately upon arrival. The upstream impact of this will

depend on the willingness of the utilities to stagger shipments of their DPCs. If the utilities do not have an urgency to remove all their DPCs from the dry storage pads first, but also do not desire to leave the DPCs until the end of the queue, then it is reasonable that they would stagger the shipments of dry storage with shipments from the pool.

### Thermal Characteristics of Waste Stream

Another major supposition applied by DOE for determining the new throughput design is that a maximum of 50% of TADs will arrive with a thermal power greater than 11.8 kW (BSAIC 2007a). The basis of this assumption is an extrapolation of data generated by a particular case of the OWS (BSAIC 2003). The study acknowledges that the specific thermal outputs of the waste stream are not easily predicted, but rationalizes a 50/50 split since the mean thermal output of the assemblies in the entire waste stream is near the value that would be necessary for 11.8 kW TAD canisters. It also concludes that, even though it would be *possible* for all or none of the waste arriving in a given year to be greater than 11.8 kW, neither of these possibilities is reasonable.

We argue that it is not only reasonable, but quite suitable to consider more or less than 50% of the waste stream arriving at a thermal power greater than 11.8 kW. The number of TADs that arrive above or below the emplacement thermal limit will vary from year to year depending on the order of waste acceptance (e.g., oldest fuel first vs. youngest fuel first) and operating design parameters (e.g., transportation or emplacement heat limit). Also, the OWS was developed prior to the TAD decision, which is likely to impact the thermal characteristics of the waste packages. This provides motivation for analyzing potential throughput under various YM pre-closure scenarios.

The remainder of this chapter describes the method used to estimate potential variations in annual demand at surface facilities, assuming a variety of design and operating scenarios. Conclusions are drawn regarding how waste stream variations impact expected surface facility throughput.

### **Analysis Methodology**

An overview of the data and assumptions applied for this research are provided in this section. CSNF inventory data was taken from the RW-859 2002 Database, supplied by the Energy Information Administration. Dry storage loaded prior to 2002 (approximately 4,200 MTHM) is not included in the inventory because data describing the contents of individual dry storage containers at each site was not available. Because this is a small relative volume compared to 63,000 MTHM, and primarily consists of older fuel, the omission of this data does not preclude the ability to produce meaningful results. However, the reader should take into consideration that the results provided do not include the DPCs or SPCs loaded prior to 2002, and therefore most likely *underestimate* demand on the WHF.

The model generates waste streams following one of three utility waste shipment orders: oldest fuel first (OFF), youngest fuel first at least 10 years old (YFF10), and youngest fuel first at least 5 years old (YFF5). A variation on waste shipment order includes giving priority to dry storage over fuel assemblies in the pool or vice versa. The trading of allocations among waste generators is permitted in order to achieve a better understanding of potential bounding thermal characteristics in the youngest fuel first scenarios. Uncertainty in the following design parameters and time-lines is also explored:

transportation heat limit, emplacement heat limit; the year the TAD is placed into use; and the year of initial steady-state operating capability at YM. Finally, sensitivity analyses are conducted by varying the continuous parameters to their minimum or maximum values from their mean. The independent variables and scenarios defined are the same as those in Chapter 3, and can be reviewed in Table 12 and Table 12.

Annual demand on the surface facilities is estimated according to the following process flows:

- TADs and DPCs arriving above the thermal emplacement limit are sent to the Receipt Facility (RF).
- DPCs arriving below the thermal emplacement limit or cool enough to be removed from the Aging Facility, as well as all bare-fuel transportation casks, are sent to the Wet Handling Facility (WHF).
- TADs arriving below the thermal emplacement limit, TADs loaded in the WHF, and TADs cool enough to be removed from the Aging Facility (AF) are routed to one of the Canister Receipt and Closure Facilities (CRCF).

The process flow assumed in this analysis omits certain paths compared to the flow defined in the SEIS for simplification purposes. Specifically, cool DPCs or TADs are not routed to the RF, and TADs are not routed from the RF to the CRCF. Of course, if the CRCF is overwhelmed, cool packages *could* be routed to the RF and aged instead of being emplaced. Similarly, if bottlenecks occur in the WHF, DPCs that are below the thermal emplacement limit could also be sent to the Aging Facility via the RF. However, this would require additional handling and storage of waste that would not be necessary if the capacity of the surface facilities was designed around the waste stream.

On the other hand, scenarios in which a majority of the waste arriving is *above* the thermal emplacement limit will quickly saturate the RF throughput capacity and leave the CRCF with very little demand. In this case, the CRCF could act as an RF by placing canisters in aging overpacks. Still, this is not necessarily desirable because the CRCF is *primarily* intended to transfer canisters to disposal overpacks and weld them. Hence, utilizing the CRCF for merely transferring canisters to aging overpacks could be considered a misuse of expensive welding capacity. Wet storage capacity in the WHF may also be able to offset backups in the RF by allowing for the co-mingling of assemblies from hotter DPCs with cooler ones. However, this may be difficult since wet storage capacity in the WHF is limited to only 200 fuel assemblies (BSAIC 2007e). DOE's ability to handle very hot DPCs in the WHF will also be constrained by the necessary cooling of DPCs before they can be filled with borated water (BSAIC 2007e).

Even with these conceivable overlapping functions of the surface facilities, the model used in this analysis does not reroute waste. This was necessary for the modeling to be tractable, but is also useful for isolating demand associated with *thermal constraints* so it can be compared with the current design. Applying these rules for process flow, the annual demand at each of the surface facilities is recorded to evaluate the throughput implications of different waste streams.

Response variables include:

- Annual demand in number of canisters for the RF and CRCF.
- Annual demand in number of DPCs and number of assemblies for the WHF.
- Annual variability in demand for all facilities.
- Number of canisters in the Aging Facility each year.

## Discussion of Results

The first question addressed was if DOE's surface facility design capacity was adequate to meet the *mean* demand over all operating years in the scenarios that were explored. Because the model used in this analysis does not re-route waste in the event of an overflow, there were many years in which the RF was over utilized and the CRCF was not used, or vice versa. This absence of re-routing may artificially skew averages of demand distributions because there is uncertainty regarding the extent to which facilities will be used to perform the roles of other facilities. In attempt to understand the implications of facility role substitution on averaging results, results are summarized in two ways: (1) annual demand for the years of operation including years in which the facility is not utilized, and (2) annual demand from this same time period *only* including years in which the facility is utilized. Both summaries of the results are within the design criteria for the CRCF and outside the design criteria for the WHF under most scenarios, so only the latter summary of the results is shown in the figures. Subtle differences in data summaries with respect to the RF are explained further in this discussion.

A variability chart for each facility (Fig. 12 - Fig. 16) gives a sense for the demand in a given scenario. The scenario mean values are connected (jagged horizontal line) and a reference (straight horizontal line) indicating DOE's throughput capacity is drawn so that the mean demand can be easily compared with capacity. The lower portion of each chart reveals which parameter has the largest *impact on the annual variability* of demand by looking at the change between the even and odd scenario numbers.

### *Canister Receipt and Closure Facility*

The average demand at the CRCF is well below DOE's criteria (250 canisters/yr) in all scenarios (Fig. 12). However, data points appear to be grouped at either high or low values instead of the mean, indicating that waste arrives mostly above or below the thermal emplacement limit. Due to the bi-modal nature of the distribution (especially under the OFF and YFF5 scenarios), the mean and median may be deceptive summary statistics. A better indicator for expected demand on the CRCF might be the peak of the greater mode. The greater values are clustered near 200 TADs/yr for most scenarios, which is close to the receipt rate assumed for this study. If the receipt rate was increased to 360 TADs/yr, DOE's capacity may not sufficiently accommodate the expected demand around the greater mode. It is conceivable that the steady-state receipt rate of 3,000 MTHM could be equivalent to as many as 330-390 TADs since PWR and BWR TADs are around 8.9 MTHM or 7.7 MTHM, respectively.<sup>19</sup>

---

<sup>19</sup> This study assumed a rate of 250 TADs/year in order to send 7,500 TADs (an estimate of the total number of TADs that will be emplaced in YM) over the course of 30 years.

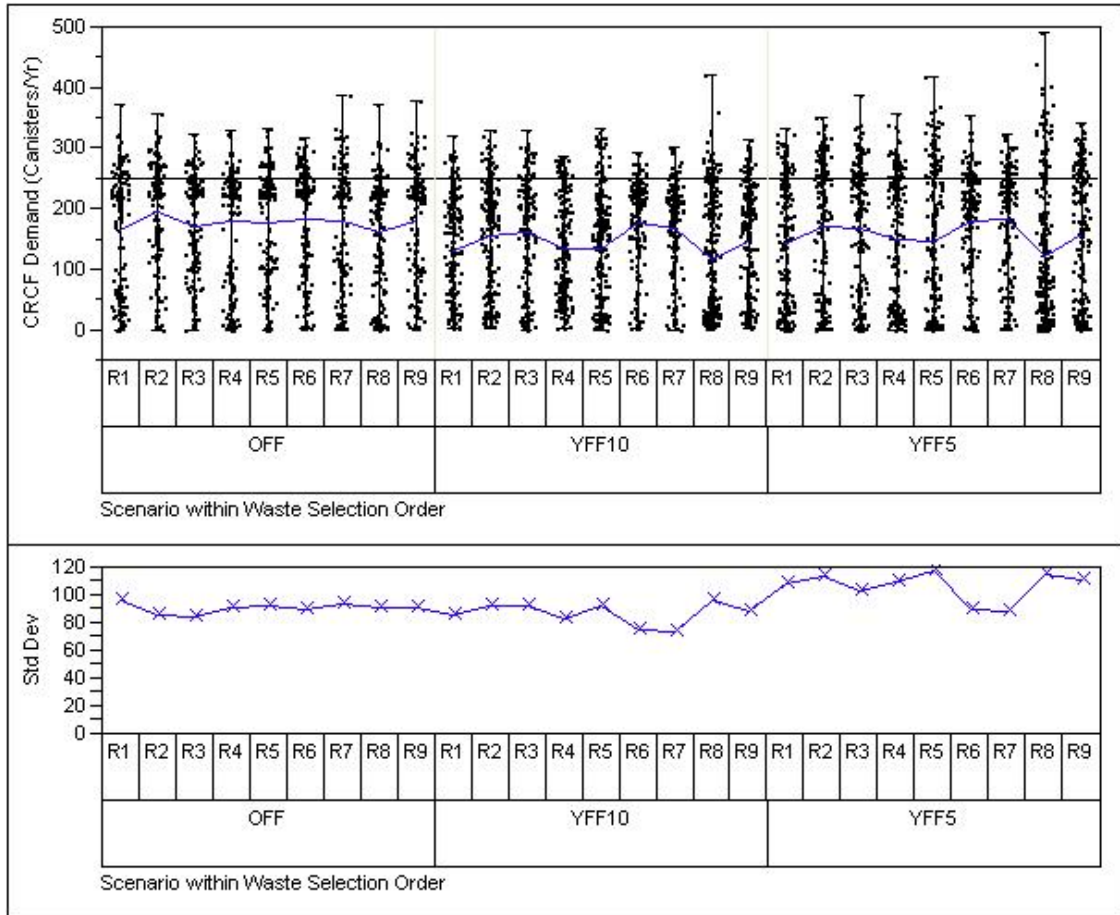

Fig. 12. Annual demand and standard deviation in annual demand for the CRCF grouped by scenario subset and waste selection order. (Scenario means are connected and a reference line at 250 canisters/yr indicating DOE's design capacity is also shown.)



The lower portion of Fig. 12 indicates that variability in demand at the CRCF is not related to waste selection order. Waste selection order does not have a clear impact on demand at the CRCF because waste that arrives too hot will eventually be routed through the CRCF to be prepared for emplacement. Under the YFF strategies, the increase in variability due to enforcing a strict thermal emplacement limit of 11.8 kW is seen in the change from R7 to R8.

### ***Receipt and Aging Facility***

Average annual demand at the RF is less than DOE's criteria of 130 canisters/yr in the OFF and YFF10 scenarios for both summaries of the resulting data (Fig. 13). Under the YFF5 scenarios, the average demand over the years in which the RF is utilized is *greater* than planned capacity in every scenario except for a low transportation limit (R6) or a high thermal emplacement limit (R7). The average demand over years including those in which the RF is not utilized is *less than* capacity in all scenarios (not shown in Fig. 13). This discrepancy is because waste is not routed to the RF after shipping is complete. In this sense, the RF sits idle during the last 20 years of the 50 year emplacement period.

Unlike the CRCF, demand at the RF is highly influenced by the order in which waste is received. The standard deviation chart of the RF shows a sharp increase in variability from R7 to R8 when a strict thermal emplacement limit of 11.8 kW is enforced under the OFF and YFF10 strategies. This is because almost the entire waste stream is routed directly to the CRCF in these scenarios.

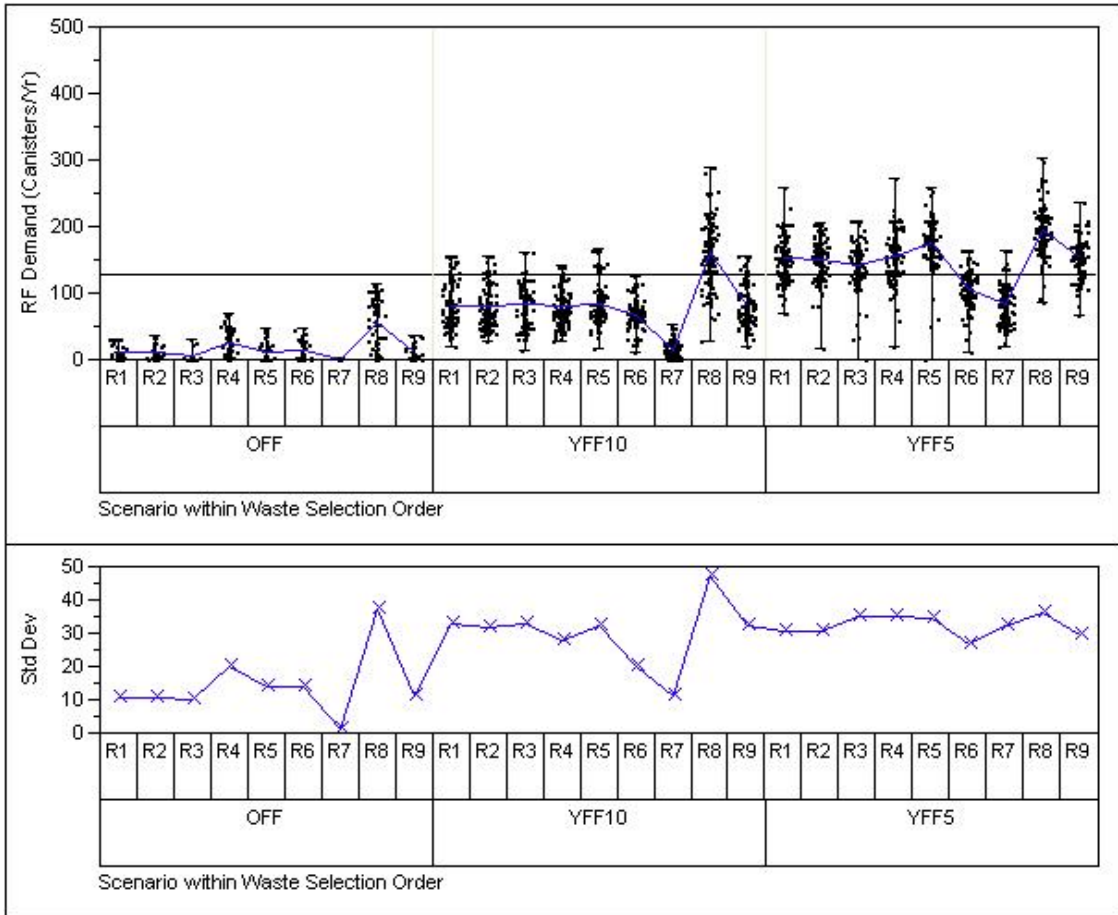

Fig. 13. Annual demand and standard deviation in annual demand for the RF grouped by scenario subset and waste selection order. (Scenario means are connected and a reference line at 130 canisters indicating DOE's design capacity is also shown.)

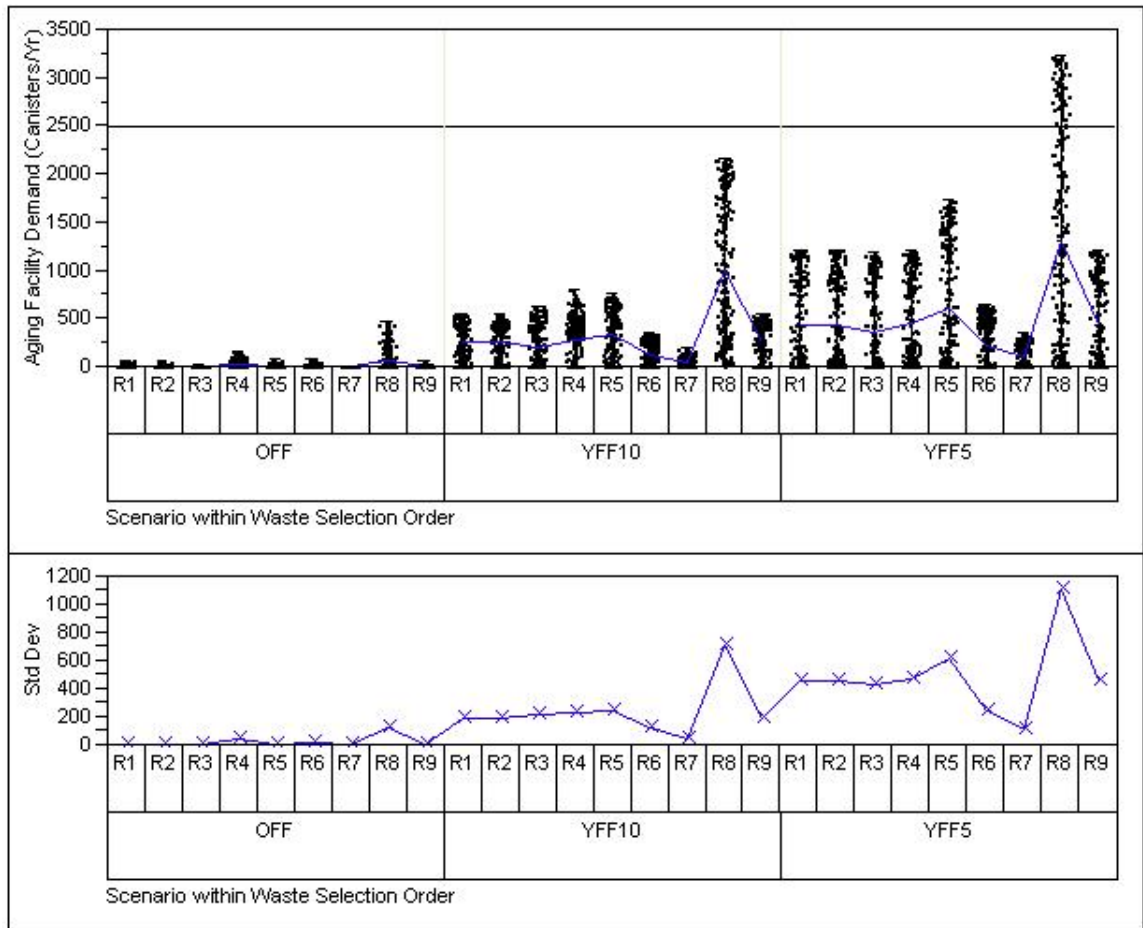

Fig. 14. Annual demand and standard deviation in annual demand for the Aging Facility grouped by scenario subset and waste selection order. (Scenario means are connected and a reference line at 2,500 canisters indicating DOE's design capacity is also shown.)

The number of packages in the Aging Facility in any given year follows a similar pattern to demand at the RF. As seen in Fig. 14, the *peak* capacity is below DOE's planned 2,500 spaces in every scenario except the one that assumes YFF5 and an 11.8 kW thermal emplacement limit.

### ***Wet Handling Facility***

For the WHF, results show that DOE's throughput criteria for DPCs may not be sufficient for the volume of DPCs expected (Fig. 15). Demand for processing *bare-fuel transportation casks* is less than design criteria capacity in most years (Fig. 16). However, due to lack of available data, the DPCs and bare-fuel dry storage casks that were loaded prior to 2002 (approximately 4,200 MTHM) are not included. Therefore, the WHF may be more overwhelmed than results indicate.

The largest impact on variability in annual demand at the WHF is due to the timing of TAD availability (R1-R2). If the TAD is delayed (R1), more DPCs are included in the waste stream, increasing mean demand and variability. The R1 scenarios consider that 20%-30% of the waste stream could arrive either in DPCs or bare-fuel transportation casks. This is compared to DOE's presumed 10% limitation.

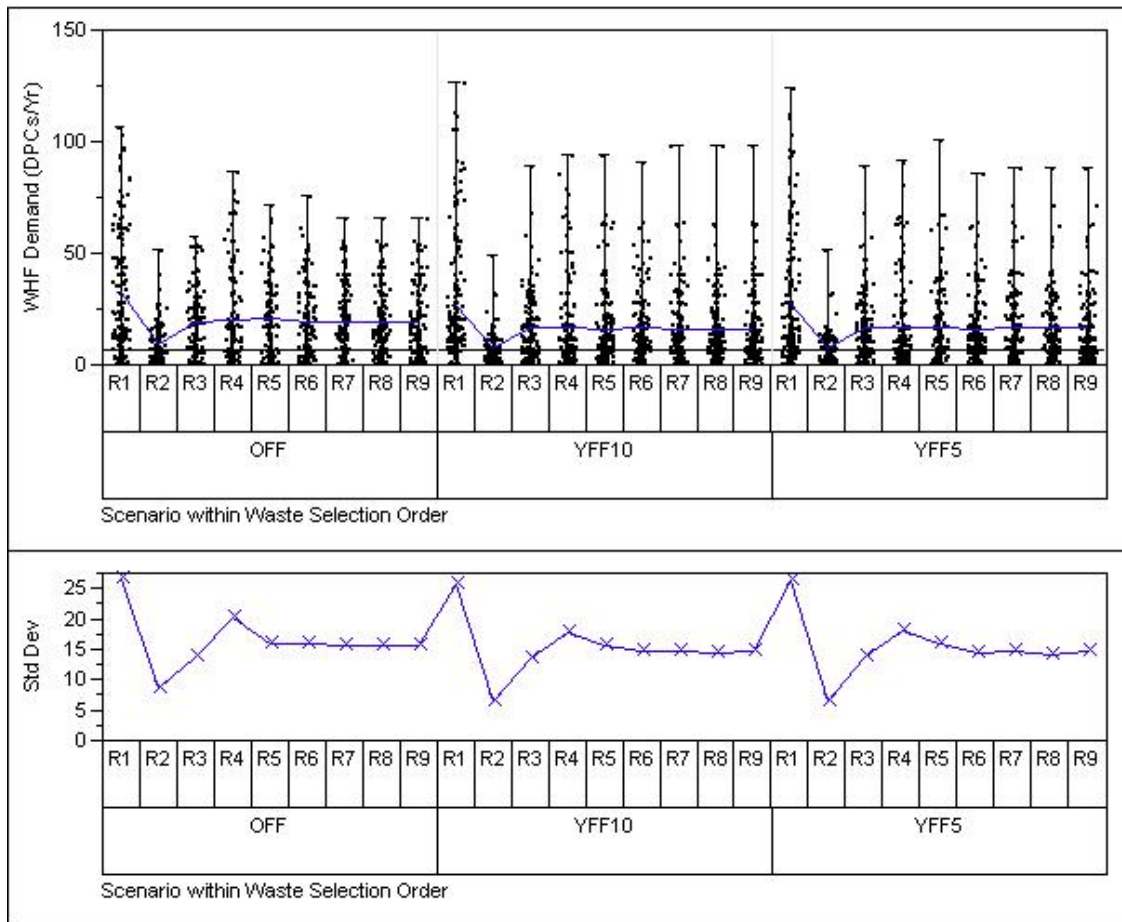

Fig. 15. Annual demand and standard deviation in annual demand for DPCs in the WHF grouped by scenario subset and waste selection order. (Scenario means are connected and a reference line at 7 DPCs indicating DOE's design capacity is also shown.)

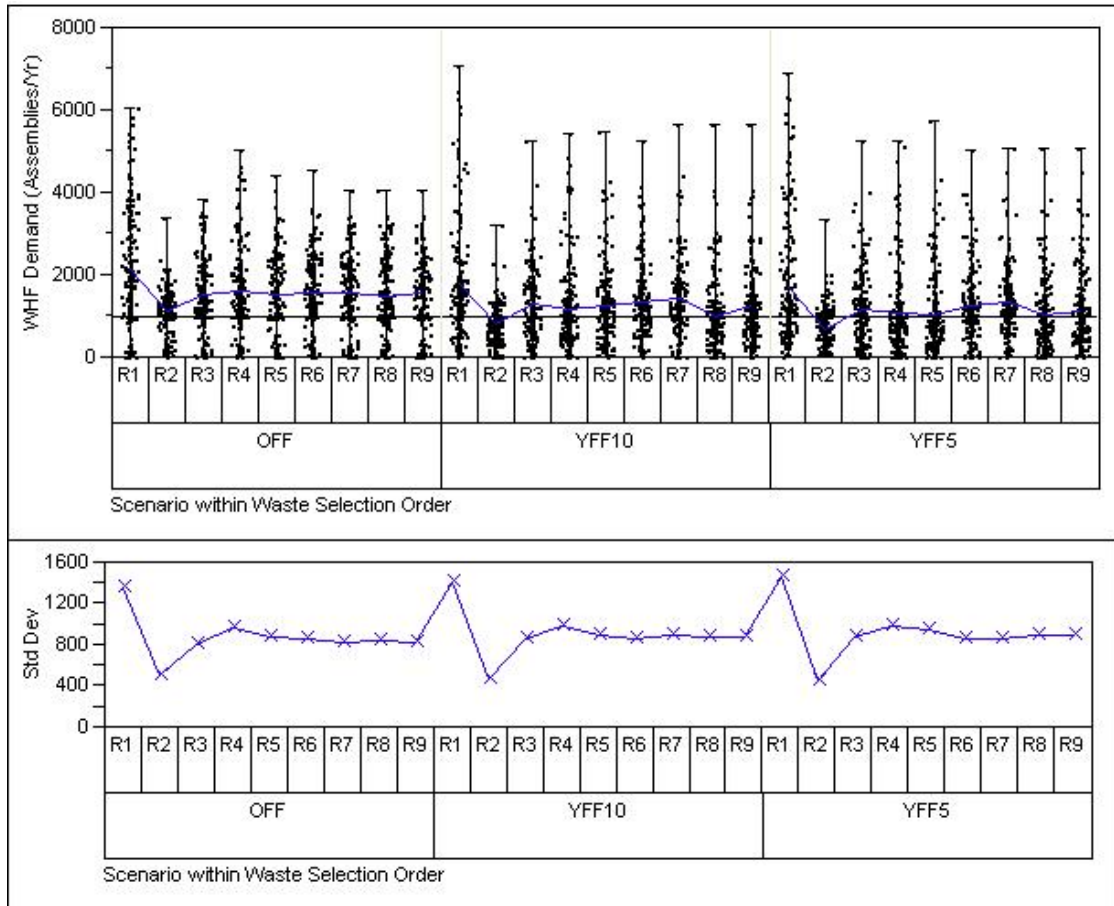

Fig. 16. Annual demand and standard deviation in demand for handling bare-fuel assemblies in the WHF grouped by scenario subset and according to waste selection order. (Scenario means are connected and a reference line at 1,000 assemblies indicating DOE's design capacity is also shown.)

### *Surface Facility Availability*

To provide a summary of the percentage of time each facility might be overburdened under the various scenarios, the number of years in which each facility was over DOE's capacity is tracked. This number is divided by the operating lifetime of the repository – 30 years for the RF and 50 years for the CRCF and WHF. The results, shown in Fig. 17, indicate that demand on WHF is above capacity in over one-half of its operational lifetime for many of the scenarios. This summary, as well as the variability charts in

Fig. 12 - Fig. 16, provide a useful broad perspective for evaluating DOE's design criteria, but they do not address particular assumptions made by DOE. Thus, a closer look at the results follows.

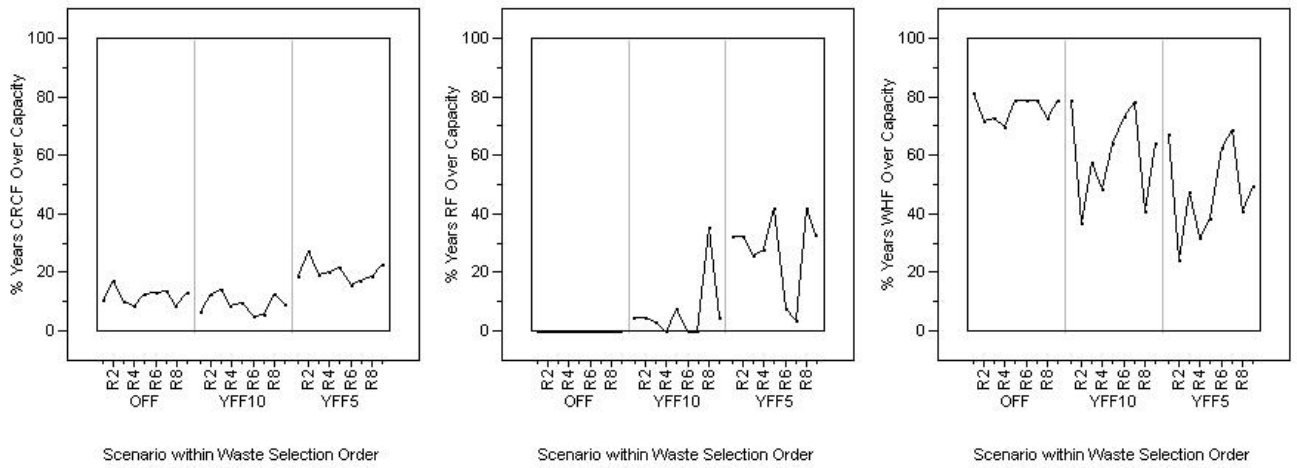

Fig. 17. Percentage of time facility is over capacity for the CRCF, RF, and WHF (from right to left). The CRCF and WHF are assumed to operate for entire 50-year emplacement period while the RF is assumed to operate for only the first 30 years.



### *Evaluation of Major Assumptions*

As described, a major assumption made by DOE in developing the throughput design is that 50% of the waste will arrive hotter than the thermal emplacement limit of 11.8 kW each year. Analysis results indicate this assumption may not be accurate depending on the order in which waste is sent to YM (Fig. 18). If oldest fuel is sent first, the average proportion is only about 10% over the entire operational period, whereas in the younger fuel first scenarios, the average ratio is about 75% for the first half of the shipping campaign, and about 40% for the latter half. Since the CRCF receives all cold TADs, and the RF receives all hot TADS, the percent of hot waste dictates demand on the RF. An inverse relationship between demands at the two facilities is apparent for the first portion of the shipping campaign (Fig. 19). Later in the emplacement period, the relationship is not as clear because the CRCF is receiving TADs that are cool enough to be taken off of the Aging Facility, in addition to newly arriving cool TADs.

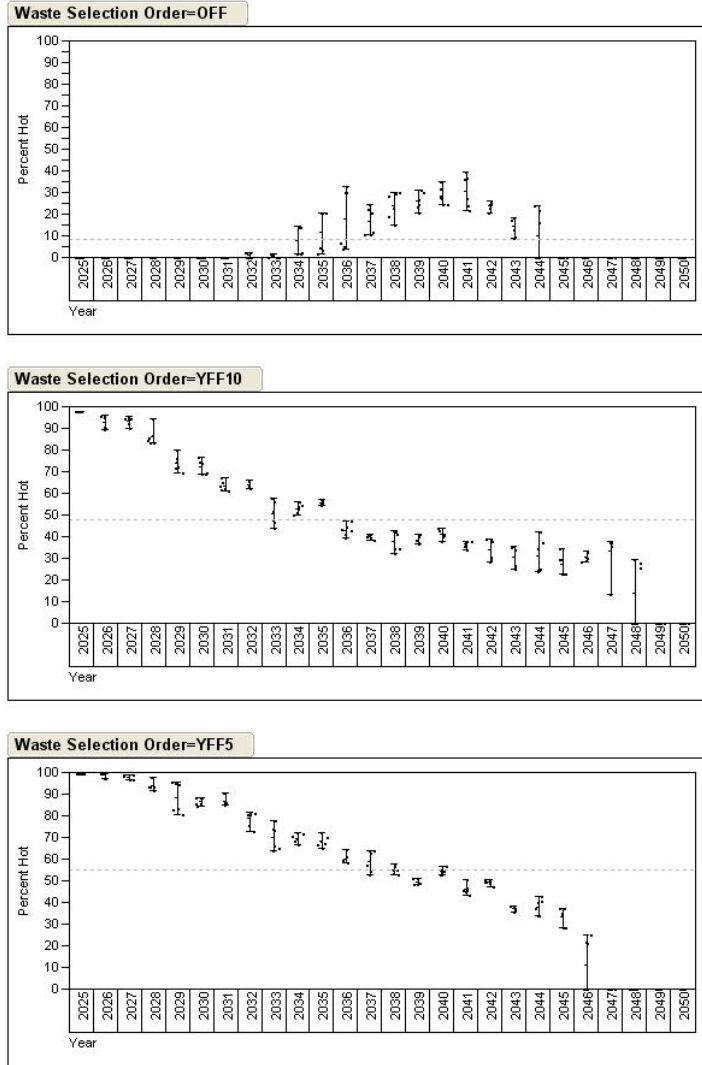
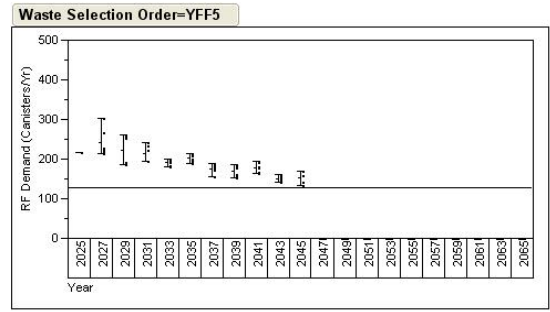
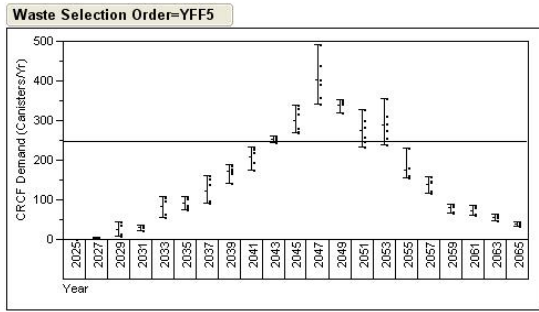
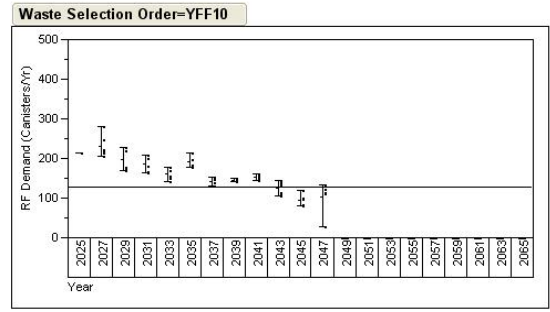
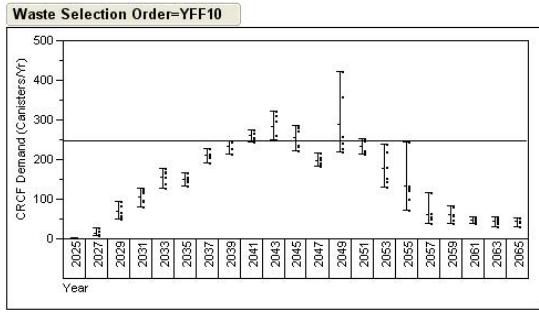
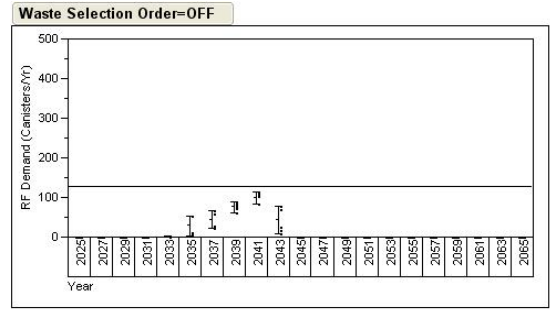
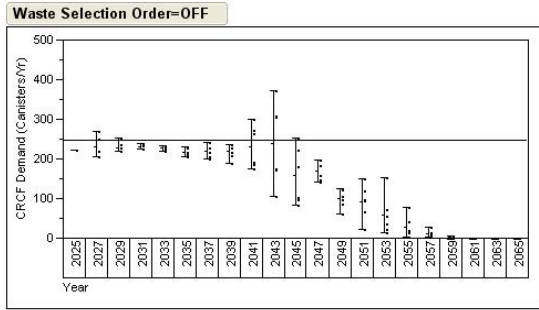

Fig. 18. Percentage of TADs above the thermal emplacement limit of 11.8 kW (out of those that are either newly arriving or cool enough to be removed from the Aging Facility each year) according to waste selection order.

The maximum demand exceeds DOE's combined capacity (250 canisters/year) even when a strict thermal emplacement limit of 11.8 kW is enforced. Interestingly, a capacity of 350 canisters/year would be adequate for 90% of the years assuming YFF5, and at least 97% assuming YFF10 or OFF. Intuitively, one might expect that sending younger fuel would reduce demand on the CRCF since more of the waste would require aging. However, results show that the peak demand is merely delayed and not reduced. This implies that there is an appropriate capacity for the CRCF, regardless of waste selection order. This inference is useful since the final schedules for delivery of waste are still undecided. It is reasonable that a CRCF built with a capacity sufficient for maximum demand could entirely replace the RF in years when the CRCF has a small demand, since RF demand would not exceed the extra capacity in the CRCF. As demonstrated in Fig. 20, the sum of demand on the CRCF and RF is below combined capacity of the facilities (380 canisters/yr) in most years.



(a)

(b)

Fig. 19. Annual demand for the (a) CRCF and (b) RF according to waste selection order. A reference line indicates DOE's design capacity (250 canisters/yr and 130 canisters/yr) for each facility.

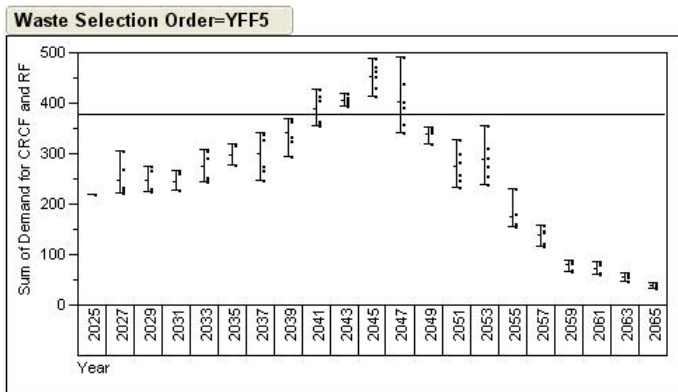
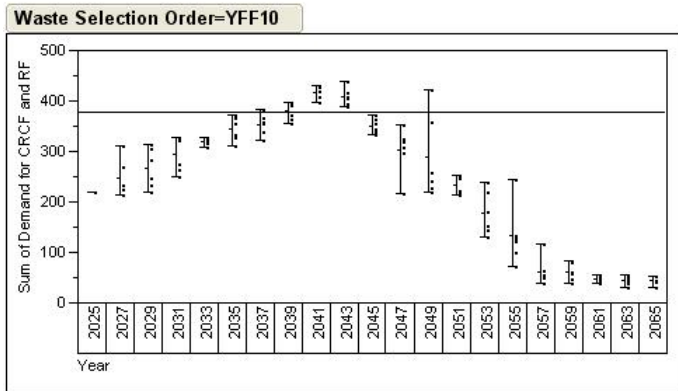
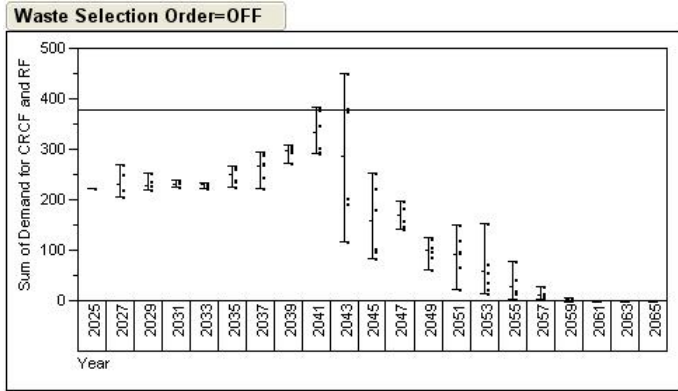

Fig. 20. Sum of demand for the CRCF and the RF assuming a thermal emplacement limit of 11.8 kW. A reference line indicates the sum of the capacity for both facilities (380 canisters/yr).

## Conclusions and Recommendations

This analysis reviewed the evolution of criteria for surface facility throughput of the TAD-based repository design. The original DOE design ignored the ratio of hot to cold canisters arriving, and thus resulted in an overly excessive design capacity. DOE developed a new design with less excess capacity. However, the following disadvantages of the design were observed:

- The design is based on an outdated waste stream study that assumed a single order for waste selection (YFF10).
- In the new design criteria, DOE assumes a 50/50 hot/cold ratio, then conservatively decides to route 70% of the 2,700 MTHM of TADs to three CRCFs instead of 50%.
- The design presumes that there will be three CRCFs without proving the need for three CRCFs.
- It includes an arbitrary 10% buffer, without showing the impact on performance, in assuming 70% of the hot TADs are sent to the RF, while 30% of the hot TADs, plus a 10% buffer, are sent to the CRCF.
- It requires the CRCF and the RF, in addition to the WHF, to handle DPCs.
- It does not account for the opportunity to couple transfer capability of the RF with welding capability of the CRCFs after all the waste has been received.

Results indicate that, under most scenarios, DOE's design adequately accommodates the *mean* demand for the CRCF and RF over the operating lifetime of these facilities. Still, due to the high potential for variability, the CRCF and RF may be used to supplement each other's capacities in the event of bottlenecks. The overlap of functional

capability confuses design goals for the system. Intuitively, a simpler design could be formulated without relying on the OWS, or expecting facilities to carry out functions for which they were not originally intended.

First, DOE could assume that, in a given year, the entire 3,000 MTHM might be CSNF. This is reasonable because CSNF constitutes 90% of the waste stream. Since DOE has stated that 90% of the waste will arrive in TADs, the 10% (300 MTHM) not in TADs should be appropriated to the WHF. Conservatively, the WHF could be designed to accommodate whichever is more demanding: 300 MTHM in bare-fuel truck casks or 300 MTHM in DPCs. Bare-fuel truck casks are smaller, but DPCs must be cut open, so it is not clear which of these is more time consuming.

This proposed design capacity for the WHF should presuppose that agreements will be negotiated between the waste generators and DOE to limit the number of DPCs and bare-fuel casks sent to YM. Before that mutual understanding is in place, it is difficult to develop an *efficient* design for the surface facilities. Accurately predicting demand for DPC processing at the WHF before the contracts are settled is problematic due to the myriad of DPC sizes in use, and uncertainty regarding which, if any, DPCs will be repackaged at utility sites. Pending future negotiations, capacity of the WHF may need to be increased in order to process assemblies that arrive in DPCs or bare-fuel transportation casks.

If information is obtained that implies it will not be reasonable to accomplish a 90% TAD waste stream, the capacity for the WHF may need to be revised. This research has provided a possible range in demand for the WHF that could be used as a starting place for determining an increased capacity. Fig. 16 shows the average annual demand for the

WHF is around 1,500 assemblies in most scenarios, with a standard deviation of approximately 800 assemblies. Assuming about half the assemblies could be PWR and the other half are BWR, 1,500 assemblies is roughly equivalent to 500 MTHM/year. This is a 60% increase above the planned capacity of 300 MTHM/year.

A design could be proposed based on this likely range of assembly demand for the WHF. However, the accuracy of this demand is limited in the underlying assumptions regarding the availability of the TAD and the adoption of its use by the utilities. In reality, the licensing and commercial development of the TAD could be delayed further than assumed, or the utilities could not adopt its use simultaneously. Thus, for the design to be robust, agreements that encourage the use of the TAD and limit the use of DPCs should still be pursued.

There is little reason to move DPCs in order to store them *again* at YM unless a waste generator is motivated to prioritize removal of DPCs over other waste from its site. Considering that DPCs are already on the aging pads at generation sites, it would facilitate YM operations if these were left at the utility site until the WHF has adequate availability. DOE should strive to negotiate schedules that uniformly distribute the shipments of DPCs over the emplacement period and avoid shipments of very hot DPCs, so the WHF might be able to handle *all* incoming DPCs and bare-fuel casks.

Instead of forcing CRCF-1 to accommodate all the waste over Years 2-4 of the ramp-up period as was done in the initial design, or assuming a 50/50 split in hot or cold packages as was done in the new design, DOE could re-frame the goals for the facilities in a way that addresses *functional* needs of the system. Since the CRCF and the RF both have the capability to transfer canisters from one type of overpack (transportation or



aging) to another (aging or disposal), the design goals could be defined in terms of *function* instead of *buildings*. In other words, the transfer design goals of the CRCF facilities could be established independently from the welding capacity design goals. This proposal does not require that the transfer and welding activities of the CRCF be housed in separate buildings. It does require TADs in disposal overpacks to be moved from the RF to the CRCF for welding with relative ease. This is considered a reasonable requirement since the SEIS already allows for this type of movement.

The transfer capability could be guided by the receipt-rate ramp-up period during the first five years, but it should be at least 3,000 MTHM per year during steady-state operations. Minimum welding criteria should match the best-case scenario for emplacement constrained only by thermal limitations. In other words, surface facilities should be capable of welding and emplacing the total 3,000 MTHM each year. If excavation of the drifts cannot possibly accommodate 3,000 MTHM per year, then it is recommended that the receipt-rate be re-evaluated. It is reasonable to expect that almost all the packages arriving will be TADs that are less than the thermal emplacement limit in some years, and thus will be ready to be welded. If welding does not meet the demand for disposal packages thermally ready to be welded in a given year, the design could result in *unnecessary* above-ground aging or storage of the waste.

The welding capability could be built in stages over the ramp-up period, depending on the drift excavation plan and the negotiated schedules that will be set in the future. The first 1,000 MTHM of welding capability could be built in CRCF-1, possibly in increments of 500 MTHM over two years.

The RF could be used for transferring canisters to aging overpacks during Years 2-3. In Year 4, when CRCF-2 is meant to come on-line, the RF could carry out the transferring capability for CRCF-2 by placing canisters into disposal overpacks. Instead of building an entirely new CRCF with transfer *and* welding functions, only additional welding capability would be necessary. The 3<sup>rd</sup> CRCF could be built with both transfer and welding capacity, or more welding capacity alone if that would be sufficient.

A system where CRCF welding capacity is equal to, or greater than, the transfer capacity should be considered for two reasons. First, TADs ready to come off of the Aging Facility and those newly loaded in the WHF – in addition to the newly arriving TADs - will need to be welded at the CRCF. Ideally, the TADs loaded in the WHF could be placed directly in disposal overpacks and welded instead of being aged first. Second, under the current design, there is no need for the RF to receive waste after shipping is complete. Considering that transfers will need to take place after all the waste has arrived, the RF capacity should be utilized for transferring canisters to disposal overpacks in later phases of the operation. In other words, the CRCF should not be expected to carry out all transfers while the RF sits idle.

The proposed alternative criteria are summarized in Table 20. Transfer capability is greater than the receipt rate in each year of the ramp-up phase. Welding capacity is equal to the amount received in the steady-state rate, and it is just under the receipt rate during the ramp-up years. The proposed design has an increased welding capability over DOE's design, but a decreased transfer capability. This is achieved by eliminating the need for the transfer segment of CRCF-2. The design would allow for a steady flow of

emplacement while implementing a uniform approach for incrementally added construction.

The goals presented are not based on a specific waste stream study, or an assumption that any particular ratio of waste will arrive above or below the thermal emplacement limit. The steady-state capacity calls for a total of 360 TAD equivalents per year as compared with DOE's 460 canisters/year. Because the design goals do not provide excess capacity over the steady-state receipt rate, they should be considered as a starting place for defining the final criteria. The ability to meet performance criteria should incorporate a margin of error for facility availability, using what is considered appropriate given factors such as the reliability rate of the equipment.

Table 20

Proposed Alternative Annual Throughput Criteria Design

|                              | Year 1 |      | Year 2 |      | Year 3 |      | Year 4 |      | Year 5 + |      |
|------------------------------|--------|------|--------|------|--------|------|--------|------|----------|------|
|                              | MTHM   | TADs | MTHM   | TADs | MTHM   | TADs | MTHM   | TADs | MTHM     | TADs |
| Total Quantity Received      |        |      |        |      |        |      |        |      |          |      |
|                              | 400    |      | 600    |      | 1,200  |      | 1,200  |      | 3,000    |      |
| Facility Processing Capacity |        |      |        |      |        |      |        |      |          |      |
| CRCF-1<br>Transfer           | 1,000  | 120  | 1,000  | 120  | 1,000  | 120  | 1,000  | 120  | 1,000    | 120  |
| CRCF-1<br>Welding            | 500    | 60   | 1,000  | 120  | 1,000  | 120  | 1,000  | 120  | 1,000    | 120  |
| RF<br>Transfer               | 0      | 0    | 1,000  | 120  | 1,000  | 120  | 1,000  | 120  | 1,000    | 120  |
| CRCF-2<br>Welding            | 0      | 0    | 0      | 0    | 0      | 0    | 500    | 60   | 1,000    | 120  |
| CRCF-3<br>Transfer           | 0      | 0    | 0      | 0    | 0      | 0    | 0      | 0    | 1,000    | 120  |
| CRCF-3<br>Welding            |        | 0    | 0      | 0    | 0      | 0    | 0      | 0    | 1,000    | 120  |
| WHF                          | 300    | 40   | 300    | 40   | 300    | 40   | 300    | 40   | 300      | 40   |
| Total Processing Capacity    |        |      |        |      |        |      |        |      |          |      |
| Canister<br>Transfer         | 1,000  | 120  | 2,000  | 240  | 2,000  | 240  | 2,000  | 240  | 3,000    | 360  |
| TAD<br>Welding               | 500    | 60   | 1,000  | 120  | 1,000  | 120  | 1,500  | 180  | 3,000    | 360  |

CRCF-1 and 3 have transfer and welding capabilities, RF has transfer capabilities, and CRCF-2 has welding capabilities only.

Future studies should revisit data regarding dry storage at the waste generation sites. Inventories of dry storage loaded prior to 2002 that were omitted in this analysis should be investigated to determine the number of DPCs included in this portion of the waste stream and how this might impact demand on the WHF. Variations in the proportion of non-DPC waste arriving as bare-fuel (assumed to be 12% in this study) and the maximum receipt-rate (assumed to be the equivalent of 250 TAD/yr) should be evaluated. Additional waste streams could be developed by treating the minimum age of fuel that is selected in the youngest fuel first scenarios as a random variable (e.g., YFF6-YFF20). The more waste streams that are considered, the better understanding DOE will achieve of uncertainty regarding the likely throughput demands of the facilities.

Future enhancements to the model could support throughput analysis by limiting the number of packages that can be processed each year, including a phased increase for the CRCF capacity. DOE's current design criteria could be measured against the design proposed herein under the various pre-closure scenarios. This will help to predict the timing of the need for the second and third CRCF, as well as define goals for progress on drift excavation.

## **CHAPTER V**

### **SUMMARY**

This research aimed to measure the impact on ‘operational performance’ of multiple scenarios for management of CSNF at Yucca Mountain, NV during the pre-closure emplacement period. The term operational performance, not to be misinterpreted as the “pre-closure performance objectives” defined in 10 CFR § 63.111, is specific to this dissertation. Desired operational performance of the waste management system includes: (1) reducing dry storage requirements at the utility reactor sites, improving the efficiency of the transportation movements, (1) reducing the number of shipment origin locations per year, (3) meeting the receipt-rate goals for YM, and (4) reducing the number of material handlings at the surface facilities.

Research objectives were accomplished by framing the pre-closure emplacement phase of YM operations as an integrated system that includes the waste generation sites and the various surface facilities at YM. A flexible simulation tool was developed for evaluating the relative operational performance of different pre-closure scenarios. Through application of the tool, a better understanding was gained of how thermal characteristics of the CSNF, upon arriving at YM, are dependent on the design assumptions of the system. Design assumptions include: (1) utility behavior regarding dry storage loading, (2) thermal limits for transportation and emplacement, (3) TAD availability, and (4) repository timeline for opening and receipt of shipments. Advantages and disadvantages of certain operating strategies were identified in terms of

multiple performance metrics, notably safety considerations and throughput of surface facilities. This led to an opportunity for recommending scenarios that have potential to result in improved operational performance.

## **Conclusions**

The major conclusions stemming from this research are as follows:

- Allowing Purchasers to trade allocations, prioritizing the trades based on least remaining capacity in the reactor-site spent nuclear fuel pools, reduces the dry storage demands at the utility sites and the average number of pools making shipments in a given year, while increasing the efficiency of transportation (Chapter 2).
- Due to the large number of utilities that will need to increase their dry storage capacity between now and the likely opening of the repository, near-term availability of the TAD is important for reducing the number of DPCs that will potentially be sent to YM for repackaging into TADs. (Chapter 2).
- If younger fuel is sent first and the legal limit of YM remains 70,000 MTHM, above-ground aging demands at YM can be reduced by reducing the thermal transportation limit for the TAD. This is feasible because DOE, as opposed to the vendor, is responsible the design specifications of the TAD. (Chapter 2).
- Relaxing the thermal emplacement limit, if proven to be compatible with the overall thermal management strategy for the repository post-closure, is the most effective way to reduce above-ground aging requirements at YM (Chapter 2).

- Scenarios that required fewer canisters to be aged and scenarios that contained fewer DPCs resulted in lower frequencies of a drop event. DOE should consider negotiating agreements that limit the number of canisters that need to be aged at YM, as well as encourage early adoption of the TAD (Chapter 3).
- Due to the uncertainty surrounding future waste schedules, DOE should consider adopting a probabilistic approach to estimating the frequencies of events in its pre-closure hazards analysis (Chapter 3).
- Pending future agreements between waste generators and DOE, capacity of the Wet Handling Facility may need to be increased in order to efficiently handle assemblies arriving in DPCs and bare-fuel transportation casks (Chapter 4).
- Because design goals for throughput have been defined in terms of surface buildings as opposed to functional needs, there is a redundancy in functional capability of the CRCF and the RF which should be taken into account in order to design a more efficient system. A design based on functional demands of the system would be easier to evaluate in terms of its ability meet performance objectives (Chapter 4).

Pre-closure operational performance of the waste management system of YM depends on the decisions of multiple stakeholders. The commercial utilities, cask vendors, DOE, NRC, and the public (to name a few examples) are all actors with different roles, responsibilities, and risks to manage. Furthermore, the impacts of pre-closure actions and decisions are time-dependent. The timing of events such as commercial development of the TAD, opening of the repository, or availability of a



separate interim storage facility all introduce considerable uncertainty into the potential waste stream for YM.

An important lesson from this research is that less complicated aspects of a system can still considerably impact overall performance. One cannot take for granted that a particular component of a project will be easy to implement just because it is less complex or has been carried out successfully in the past. The fact that less emphasis was placed on pre-closure operations relative to post-closure performance resulted in a disconnection between pre- and post-closure analyses. If pre-closure utility selection for loading assemblies had been thought of as having more potential to impact the amount of aging required above ground at YM, a more appropriate agreement might have been reached when the *Standard Contract* was developed.

Also, it is noted that for these types of projects, proving compliance through application of conservative, deterministic assumptions may not reveal the potential efficiencies that can be gained through parameter trade-offs. In some cases, deterministic, conservative approaches may not have the desired result if the basis for the conservative assumption is not explained. An example lies in the safety and throughput analyses conducted by DOE. These studies made conservative assumptions, but without a contextual understanding of how the assumptions impact the overall ability to achieve design objectives. This type of approach can limit the ability to effectively communicate the uncertainty surrounding the performance of the system. In these cases, a probabilistic approach that does not rely as heavily on conservative assumptions may help strengthen risk communication.

## Recommendations For Future Research

As in any comprehensive research endeavor, opportunities for further enhancement abound. In this instance, the following activities are recommended for continuing research progress:

- Incorporate a complete inventory of assemblies already loaded in DPCs and SPCs into the database to gain a more comprehensive knowledge of the current status. To better predict potential *future* inventories, a survey could be conducted that asks waste generators about their willingness to use the TAD. On-going studies evaluating the ability to directly dispose of DPCs should also be considered.
- Develop an economic response variable that considers both the utility and YM expenses relating to storage. Utility costs include those associated with storing TAD canisters that are potentially more expensive than current dry storage systems and have a smaller capacity, meaning the utilities would have to store a greater number of them to accommodate the same number of assemblies. Meanwhile, expenses at YM will be related to the size of the Aging Facility and the duration of operations for the surface facilities, which is largely driven by the length of time the casks need to be aged above ground.
- Construct additional scenarios using a Latin Hypercube Sampling (LHS) method for the continuous parameters to gain a better understanding of parameter relationships. In addition to the four continuous parameters used in this study, future studies could define the percent of waste arriving in bare-

fuel transportation casks, the steady-state receipt rate, and the minimum age in the youngest fuel first scenarios as random variables.

- Focus the simulation on the five year ramp-up phase, incorporating a shorter time-step, to better determine the appropriate timing for increased capability in the CRCF and to better predict the main drivers for processing delays. The proposed facility capacity constraints could be tested under various scenarios, and delays in the system could be measured.
- Include geographical information as an additional feature for the facilities so that additional metrics involving transportation (e.g., travel time) can be tracked. This would aid in identifying scenarios that take advantage of the ability to collect shipments from multiple facilities on a single dedicated train.
- Utilize the model's capability to dynamically create a waste acceptance schedule for additional objectives (e.g., prioritize allocations to sites in certain geographical regions, sites with specific transportation capabilities, or sites with a specific inventory of loaded TADs/DPC, etc.)
- Finally, explore the potential to frame the research as an optimization problem. To do this, one would have to decide the appropriate design parameters, constraints, and candidate objective functions. For example, one could find the CRCF throughput capacity that minimizes the average of maximum demands on the Aging Facility, constrained by a minimum limit on excess capacity in the CRCF. Or, the model could be used to identify the optimal thermal emplacement limit between the values of 11.8 kW and 18 kW

that keeps the capacity on the Aging Facility at or below 2,500 dry storage containers, given a particular receipt rate and waste stream.

These continued research efforts will help provide a more comprehensive understanding of likely waste streams for YM, and in doing so, enable the design of a more efficient pre-closure waste management system.

## REFERENCES

- Abraham, S. (2002). "Recommendation by the Secretary of Energy Regarding the Suitability of the Yucca Mountain Site for a Repository under the Nuclear Waste Policy Act of 1982." February, 2002. Available at:  
[http://www.osti.gov/bridge/product.biblio.jsp?osti\\_id=883370](http://www.osti.gov/bridge/product.biblio.jsp?osti_id=883370).
- APS. (2007). "Consolidated Interim Storage of Commercial Spent Nuclear Fuel: A Technical and Programmatic Assessment." Nuclear Energy Study Group of the American Physical Society. Available at: <http://www.aps.org/policy/reports/popa-reports/upload/Energy-2007-Report-InterimStorage.pdf>.
- BSAIC. (1999). "Preliminary Design Basis for WP Thermal Analysis." Participant#: MOL.19980203.0529. Bechtel SAIC Company, LLC, Washington, DC.
- BSAIC. (2001). "Waste Package Misload Probability." Participant#: MOL.20011212.0186, Bechtel SAIC Company, LLC, Washington, DC.
- BSAIC. (2002). "Calculation Method for Projection of Future Spent Nuclear Fuel Discharges." Participant#: MOL.20020327.0002, TDR-WAT-NU-000002 REV.01, Bechtel SAIC Company, LLC, Washington, DC.
- BSAIC. (2003). "2002 Waste Stream Projections Report." Participant#: DOC.20031020.002, TDR-CRW-SE-000022 REV 01, Bechtel SAIC Company, LLC, Las Vegas, NV.
- BSAIC. (2004a). "Dry Transfer Facility Worker Dose Assessment." Participant#: ENG.20040923.0001, 110-00C-CD00-00100-000-00B, Bechtel SAIC Company, Las Vegas, NV.
- BSAIC. (2004b). "User Manual for the Total System Preprocessor." Participant#: ALA.20050418.5274, MIS-CRW-MD-00004. Bechtel SAIC Company, LLC, Washington, DC.
- BSAIC. (2005a). "Categorization of Event Sequences for License Application." Participant#: ENG.20050414.0011, 000-00C-MGR0-00800-000-00B, Bechtel SAIC Company, LLC, Washington, DC.
- BSAIC. (2005b). "Multi-Scale Thermal Hydrological Model (MSTHM)." Participant#: DOC. 20050711.001, ANL-EBS-MD-000049 Rev.03, Bechtel SAIC Company, LLC, Washington, DC.
- BSAIC. (2005c). "Preclosure Consequence Analysis for License Application." Participant#: ENG.20050112.0003, 000-00C-MGR0-00900-000-00B, Bechtel SAIC Company, LLC, Washington, DC.

- BSAIC. (2005d). "TSM System Study: Impact of a Canister-Based System on the CRWMS, Phase I." Participant#: MOL.20060801.0132, MIS-CRW-SE-000003 REV00, Bechtel SAIC Company, LLC.
- BSAIC. (2006). "Basis of Design for the TAD Canister-Based Repository Design Concept REV 00." Participant#:ENG.20061023.0002, Bechtel SAIC Company, LLC.
- BSAIC. (2007a). "Basis of Design for the TAD Canister-Based Repository Design Concept REV 01." Participant#:ENG.20071002.0042, DN2002489194, Bechtel SAIC Company, LLC.
- BSAIC. (2007b). "Nuclear Facilities Receipt Rate Requirements Analysis Engineering Study." Participant#: ENG.20071227.0017, Bechtel SAIC Company, LLC.
- BSAIC. (2007c). "Preliminary Throughput Study for the Canister Receipt and Closure Facility." Participant#: ENG.20071227.0017. Bechtel SAIC Company, LLC.
- BSAIC. (2007d). "Preliminary Throughput Study for the Receipt Facility." Participant#:ENG.20070723.0030. Bechtel SAIC Company, LLC.
- BSAIC. (2007e). "Preliminary Wet Handling Facility Throughput Study." Participant#: ENG.20071102.0019, Bechtel SAIC Company, LLC.
- DOE. (1980). "Environmental Impact Statement, Management of Commercially Generated Radioactive Waste." EIS-0046, Department of Energy.
- DOE. (1996). "Annual Report to Congress, FY 1996. Chapter Two: Waste Acceptance, Storage and Transportation." Department of Energy, Office of Civilian Radioactive Waste Management.
- DOE. (2000). "Monitored Geologic Repository Project Description Document." TDR-MGR-SE-000004 REV 01 ICN 01. Department of Energy, Office of Civilian Radioactive Waste Management M&O.
- DOE. (2002). "Final Environmental Impact Statement for a Geologic Repository for the Disposal of Spent Nuclear Fuel and High-Level Radioactive Waste at Yucca Mountain, Nye County, Nevada." Participant#: MOL.20020524.0314 through MOL.20040524.0320, DOE/EIS-0250, Department of Energy, Office of Civilian Radioactive Waste Management, Washington, DC.
- DOE. (2003). "2002 Operational Waste Stream and 2003 TSLCC Waste Stream Backup Calculation." Participant#: DOC.200404120004, CAL-CRW-SE-000002, Department of Energy Office of Civilian and Radioactive Waste Management, Las Vegas, NV.

- DOE. (2004). "Acceptance Priority Ranking and Annual Capacity Report." Participant#: HQO.20041004.0041, DOE/RW-0567, Department of Energy, Office of Civilian Radioactive Waste Management, Washington, DC.
- DOE. (2006a). "Civilian Radioactive Waste Management System Requirements Document." Participant#: DOE.20060509.0008, DOE/RW-0406 Rev 07, Department of Energy Office of Civilian and Radioactive Waste Management, Washington, DC.
- DOE. (2006b). "Draft Supplemental Environmental Impact Statement for a Geologic Repository for the Disposal of Spent Nuclear Fuel and High-Level Radioactive Waste at Yucca Mountain, Nye County, Nevada." DOE/EIS-0250F-S1D. Department of Energy, Office of Civilian Radioactive Waste Management, Washington, D.C.
- DOE. (2006c). "Global Nuclear Energy Partnership Overview." Department of Energy. Available at: <http://www.gnep.energy.gov/pdfs/gnepOverview.pdf>
- DOE. (2006d). "US Department of Energy Responses to the June 14, 2006 Letter from the Nuclear Waste Technical Review Board." US Office of Radioactive Waste Management, Washington, DC.
- DOE. (2006e). "Yucca Mountain Project Critical Decision-1 Preliminary Hazards Analysis." Participant#: ENG.20060505.0009, TDR-MGR-RL-000004 REV 02, Department of Energy Office of Civilian Radioactive Waste Management, Las Vegas, NV.
- DOE. (2007). "Transportation, Aging and Disposal Canister System Performance Specification." WMO-TADCS-000001, Department of Energy, Office of Civilian Radioactive Waste Management. Available at: [http://www.ocrwm.doe.gov/receiving/pdf/tad\\_performance\\_specification\\_rev0.pdf](http://www.ocrwm.doe.gov/receiving/pdf/tad_performance_specification_rev0.pdf).
- EIA. (2002). "RW-859 2002 Access Database and User Manual." Energy Information Administration.
- Goldsim. (2007). "Goldsim Official Website." Available at: [www.goldsim.com](http://www.goldsim.com).
- Kaplin, S. and B.J. Garrick. (1981). "On the quantitative definition of risk." Risk Analysis, 1(1).
- Kouts, C. (2006a). "Total System Model Analyses Supporting the TAD Concept." Nuclear Waste Technical Review Board Meeting. May 2006. Available at: <http://www.nwtrb.gov/meetings/2006/may/kouts%20TAD.pdf>
- Kouts, C. (2006b). "Transportation, Aging and Disposal Canister (TAD) System Development and Implementation." NRC Management Meeting, Pahrump, NV. .December 7, 2006. Available at: <http://www.nrc.gov/waste/hlw-disposal/public-involvement/mtg-archive.html>

- Lloyd, R. L. (2003). "A Survey of Crane Operating Experience of US Nuclear Power Plants from 1968 through 2002." NUREG-1774, Participant#: MOL.200508022.0185, U.S. Nuclear Regulatory Commission.
- McCullum, R. (2006) "Industry Perspectives on Transportation, Aging, and Disposal (TAD) Canisters for Used Nuclear Fuel." Nuclear Waste Technical Review Board Meeting. May 7, 2006. Available at:  
<http://www.nwtrb.gov/meetings/2006/may/mccullum-blee.pdf>
- NAS. (1995). "Technical Basis for Yucca Mountain Standards." National Academies of Science Board on Radioactive Waste Management, Washington, DC.
- NAS. (2006a). "Going the Distance? The Safe Transport of Spent Nuclear Fuel and High-Level Radioactive Waste in the United States." National Academies of Science Committee on Transportation of Radioactive Waste Nuclear and Radiation Studies Board: Transportation Research Board, Washington, DC.
- NAS. (2006b). "Safety and Security of Commercial Spent Nuclear Fuel Storage." Public Report by the National Research Council, Washington, DC.
- NAS/NRC. (1957). "The Disposal of Radioactive Waste on Land." Publication 519 National Academy of Sciences and National Research Council Division of Earth Sciences Committee on Waste Disposal, Washington, DC.
- NAS/NRC. (1984). "Social and Economic Aspects of Radioactive Waste Disposal: Considerations for Institutional Management." National Research Council Panel on Social and Economic Aspects of Radioactive Waste Management, Board on Radioactive Waste Management.
- National Environmental Policy Act of 1969. 42 U.S.C. § 4321-4347.
- NEI. (2007). "Status of Used Nuclear Fuel Storage at U.S. Commercial Nuclear Plants." Available at:  
[www.nei.org/resourcesandstats/nuclear\\_statistics/nuclearwasteamountsandonsitesstorage/](http://www.nei.org/resourcesandstats/nuclear_statistics/nuclearwasteamountsandonsitesstorage/)
- NEI. (2008). "New Nuclear Plant Status." Nuclear Energy Institute, Washington, DC. Available at:  
<http://www.nei.org/keyissues/newnuclearplants/newnuclearplantlicensing/>
- NRC. (1983). "PRA Procedures Guide, A Guide to the Performance of Probabilistic Risk Assessments for Nuclear Power Plants." NUREG/CR-2300, Nuclear Regulatory Commission, Washington, D.C.
- NRC. (1984). "Waste Confidence Decision." 49 FR 34658, 10 CFR Parts 50 and 51, Nuclear Regulatory Commission, Washington, D.C. August 31, 1984



- NRC. (1990). "Waste Confidence Decision Review." 64 FR 68005, 10 CFR Part 51, Nuclear Regulatory Commission, Washington, D.C. September 18, 1990
- NRC. (2002). "Radioactive Waste Production, Storage, and Disposal." NUREG/BR-0216. Rev 02, Nuclear Regulatory Commission, Office of Public Affairs, Washington, D.C.
- NRC. (2005). "State of Nevada; Denial of a Petition for Rulemaking." 70 FR 48329, CFR Part 51, Nuclear Regulatory Commission, Washington, D.C.
- NRC. (2007). "Pre-Closure Safety Analysis Dose Performance Objectives and Radiation Objectives and Radiation Protection Program." HLWRS-ISG-03, Nuclear Regulatory Commission, Washington, D.C.
- NWTRB. (2006). "Report to Congress and the Secretary of Energy." Nuclear Waste Technical Review Board. Available at: <http://www.nwtrb.gov/reports/05report.pdf>
- PFS. (2001). "Final Environmental Impact Statement for the Construction and Operation of an Independent Spent Fuel Storage Installation on the Reservation of the Skull Valley Band of Goshute Indians and the Related Transportation Facility in Tooele County, Utah." NUREG-1714, Vol. 1, Private Fuel Storage, LLC.
- Radin, A., D. Klein, and F. Parker. (1989). "Nuclear Waste: Is There a Need for Federal Interim Storage?" Report of the Monitored Retrievable Storage Review Commission.
- Ryman, J., and M. Anderson. (2001). "Waste Form, Heat Output, and Waste Package Spacing for an Idealized Drift Segment." CAL-EBS-MD-000019 REV00, Participant#: MOL.20010817.0338, Department of Energy Office of Civilian and Radioactive Waste Management.
- Salvatori, L. C. (1996). "Environmental Compliance at the West Valley Demonstration Project: The Vitrification Permitting Program." DE-AC24-81NE44139, West Valley Nuclear Services Company, Inc., West Valley, N.Y.
- Shah, M., R. Lewis, and T. McCartin. (2006) "Regulatory Requirements for Transportation, Storage, Aging, and Disposal Canister." US Nuclear Regulatory Commission NRC/DOE Technical Exchange and Management Meeting on Design Changes Approved Through DOE's Critical Decision-1 Process, Las Vegas, NV. August 29, 2006. Available at: <http://www.nrc.gov/waste/hlw-disposal/public-involvement/mtg-archive.html>.
- Spradley, L., M. Abkowitz, J. Clarke. (2008). "Evaluating the Impact of Using the Transport, Aging, and Disposal (TAD) Canister on Yucca Mountain Pre-Closure Operations." Waste Management February, 2008 Conference Proceedings, Phoenix, AZ.

- Sproat, W. (2007). "Statement of Edward F. Sproat, III, Director of the Office of Civilian Radioactive Waste Management, Department of Energy Before the Full Committee Hearing Examination of the Licensing Process for the Yucca Mountain Repository." Committee on Environment and Public Works. Available at:  
[http://epw.senate.gov/public/index.cfm?FuseAction=Hearings.Hearing&Hearing\\_ID=d447b939-802a-23ad-434f-7596d4a068d7](http://epw.senate.gov/public/index.cfm?FuseAction=Hearings.Hearing&Hearing_ID=d447b939-802a-23ad-434f-7596d4a068d7).
- Standard Contract for Disposal of Spent Nuclear Fuel and/or High-Level Radioactive Waste. 10 CFR Part 961.
- Tooker, D. and T. D. (2006). "Surface Facilities Overview and Canister Receipt and Closure Facility." NRC/DOE Technical Exchange and Management Meeting on Design Changes Approved Through DOE's Critical Decision-1 Process, Las Vegas, NV. August 29, 2006. Available at: <http://www.nrc.gov/waste/hlw-disposal/public-involvement/mtg-archive.html>.
- Williams, M. "Opening Remarks." (2006). NRC/DOE Technical Exchange and Management Meeting on Design Changes Approved Through DOE's Critical Decision-1 Process, Las Vegas, NV. August 29, 2006. Available at: <http://www.nrc.gov/waste/hlw-disposal/public-involvement/mtg-archive.html>.
- Yang, H. (1999). "Repository Subsurface Waste Emplacement and Thermal Management Strategy." Participant#: MOL.19980918.0084, Department of Energy Office of Civilian Radioactive Waste Management M&O.

## APPENDIX A

### DETAILED MODEL DESCRIPTION

#### Model Scope and Objective

The modeling tool developed for this analysis is used to gain a better understanding of repository surface operations. The simulations are carried out from the present time and through the *emplacement phase* of the pre-closure period. The objective is to estimate the thermal power output of packages as they are loaded at the utilities and sent to YM. The model does not calculate temperatures associated with the subsurface of the repository (e.g., midpillar, cladding, waste package, and drift wall), which is considered outside the scope of this analysis.

#### Data

##### *Commercial Spent Nuclear Fuel Inventory*

Raw data is taken from RW-859 database provided by the Energy Information Administration. RW-859 is an MSAccess Database that provides data on irradiated fuel assemblies. The table called tblFuelFresh includes assembly characteristics (burnup, initial loading weight, enrichment, discharge date) for all discharged assemblies. This table also indicates if the assembly was in dry storage or not, but does not indicate which assemblies were in each particular dry storage cask at a specific reactor site. In order to

isolate the spent nuclear fuel assemblies that were still in the pools from those that were not, a new table, called tblFuelFreshWet was created, without the dry storage assemblies loaded into dry storage prior to 2002. Because data regarding how the assemblies in dry storage were loaded into different dry storage containers was not available, the assemblies in dry storage prior to 2002 were not included in the data set.

Projected assembly discharges were calculated using a Microsoft Excel macro created by Department of Energy and documented as an appendix to *Calculation Method for Projection of Future Spent Nuclear Fuel Discharges*.<sup>1</sup> The macro, “FINAL\_UTIL\_SNF\_PROJ\_1998.xls”, projects future fuel discharges based on site closure times, and assumptions regarding trends in burnup and enrichment values.

A table, such as the following, summarizing the discharge cycles 1 to n is created using MSAccess for each pool.

| Cycle | Date discharged | Avg Burnup (GWd/MTU) | Avg Enrichment | Avg Mass per Assembly (kg) | Starting Assembly Count |
|-------|-----------------|----------------------|----------------|----------------------------|-------------------------|
| 1     | 1/1/1979        | 12                   | 3%             | 460                        | 46                      |
| n     | 1/1/2015        | 50                   | 5%             | 425                        | 157                     |

The summary tables for each pool are uploaded into the GoldSim as separate arrays for each column. These elements, along with the capacity of the spent nuclear fuel and the fuel type (PWR or BWR), are held within the “Unique” container for each pool. The capacity used is the licensed capacity provided in the RW-859, which does not include a full core reserve. The capacities could easily be redefined by the user to reflect

---

<sup>1</sup> “Calculation Method for Projection of Future Spent Nuclear Fuel Discharges.” TDR-WAT-NU-000002

a full core reserve. Each year, the GoldSim submodel Heat\_Table is updated to change the average thermal output of each assembly within a discharge cycle, and the remaining assembly count is updated for each discharge cycle for each pool. Negative ages are used to represent future discharge projections.

Variable names as they appear in the code are provided in parentheses. The burnup (Btot), and enrichment (Enrichment) were averaged over the number of assemblies discharged at each historical and projected discharge date (Download\_Date). The discharge date must be imported into GoldSim in the serial value format, so it is converted to a date (Date\_in\_pool). The model calculates the number of years the assembly has cooled out of the reactor (Tc) based on the current year of the model. A submodel is created for each pool that calculates the thermal power each year, called Heat\_Table. FuelTypeID describes if the pool is PWR (0) or BWR (1).

The model uses a different set of lookup tables for PWR and BWR fuel type that contain thermal power estimates for various time cooled, burnup, and enrichment values. Thermal values are interpolated logarithmically between time cooled and linearly between enrichment and burnup values using the GoldSim element "Lookuptable". Data uploaded to the Lookuptable was obtained from Bruce Kirstin, a staff member of the Nuclear Waste Technical Review Board. The data is the same that is used by DOE in a previous study (BSAIC 1999). The thermal decay heat for each cycle discharge cycle is stored in the array Current Heats.

## Utility Dry Storage Loading Before YM Opens

The “Clone” portion of each pool holds the logic for loading dry storage. The variables for each pool have the same logic structure, but different values since they are linked to data elements in the “Unique” container belonging to that pool. Each pool has two arrays assigned to it that are of an adequate length to be able to represent all the dry storage containers that pool would load over its entire lifetime. Every cell in each of the array represents one container.

One array is used to track the heats of the containers that have been loaded (Container\_Heats) and the second array tracks the container type and location (Container\_Location), stored as an integer 1-6 in each cell of the array. The integer represents a combination of container type and location. The container type can either be a DPC or a TAD, and the container location can be at YM or at the utility site. Dry storage containers that were once on the dry storage pad of the utility but have been shipped to YM are stored as a separate integer than dry storage containers that were shipped directly after being loaded from the pool.

The integer assignments for Container Location are:

- 1 if TAD at YM
- 2 if DPC at YM
- 3 if TAD at reactor
- 4 if DPC at reactor
- 5 if at reactor and loaded after YM has reached capacity
- 6 if TAD was once at reactor site and has been moved to YM

Each year, the model checks to see if assemblies should be loaded into dry storage from the pool. Assemblies are loaded if the pool has reached its capacity, or if a shipment to YM is scheduled. If the TAD is available (checked by comparing the

simulation year to the user input variable TAD Year), then the canister is marked as a TAD, if the TAD is not yet available, then the canister is marked as a DPC. The model refers to the fuel type to check for the number of assemblies that should be in the canister. All PWR canisters have 21 assemblies and all BWR canisters have 44 assemblies.

The assemblies in DPCs are originally grouped into 21 and 44 sized sets so that the same logic could be used for loading TADs and DPCs. This was also a useful assumption for determining when the correct number of TAD equivalents would be loaded, triggering that it had reached YM Capacity. The number of DPCs arriving at the surface facilities was adjusted for the difference in size of the DPCs as a part of post-simulation data processing.

The logic for choosing assemblies to load in containers is housed within the “Loading” container in each pool. One of three orders for selecting spent fuel assemblies from a facility’s pool is applied: (1) oldest fuel first (OFF), (2) youngest fuel first at least five years old (YFF5), or (3) youngest fuel first at least ten years old (YFF10).

The loading algorithm can accommodate zone loading or uniform loading, set by the user. For each zone of a dry cask, the minimum cooling time requirement per assembly will be assumed. The heat limit per assembly (Goal) is defined as the hot value for the first 9 or 20 assemblies, depending on the fuel type. The cold value is used for the remaining assemblies. The value is calculated using the transportation heat limit defined by the user.

In the case that not enough assemblies meet the criteria to fill the cask, the utility will wait to load the cask until it has the appropriate number of assemblies that meet the criteria.

The logic for the loading algorithm is as follows:

- For each cask
  - Is this cask a PWR or BWR cask?
    - Set appropriate sizes for zones and decay heat limit per assembly
- For each zone in the dry cask, starting with the cold zone, then going to the hot zone
  - If YFF5 or YFF10: Look for youngest assembly that meets per assembly decay heat requirement
  - Else, OFF: Look for oldest assembly that meets the per assembly decay heat requirement
  - Load assembly
  - If pool is empty, close cask (to ensure last cask is closed even if it is short loaded)
  - Else repeat until zone is full or no more suitable assemblies remain
    - If zone is full or if short loading is allowed
      - End zone and move to next zone
    - Else, wait until more assemblies age and attempt to load again
- Repeat until cask is full, close cask

The logic for assigning assemblies to containers is held within a container (Assign Container) within each pool. Each time an assembly is loaded, a vector (Removed Condition), which is the same length as the number of discharge cycles, is updated. This vector is marked with a 1 in the cell associated with the cycle discharge group from which the assembly was removed. The vector Removed Condition is used as a row corresponding to the current container being loaded in a matrix (Assignment). The matrix is updated each time an assembly is transferred. The next row is populated once the last container is full. The Assignment matrix is used to calculate the total heat of each container by multiplying it with a vector that tracks the average heat of the assembly within each cycle discharge group.



## Assign Thermal Power Output to TADs

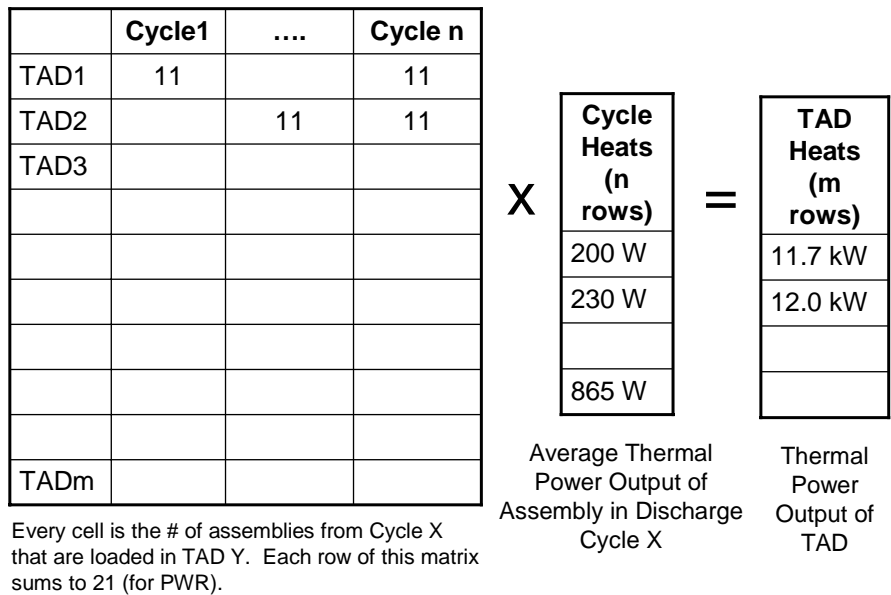

The logic for dry storage loading before the repository opens is summarized in the diagram below. This process continues on an annual basis until the simulation reaches the year that the repository opens, which is defined by the user.

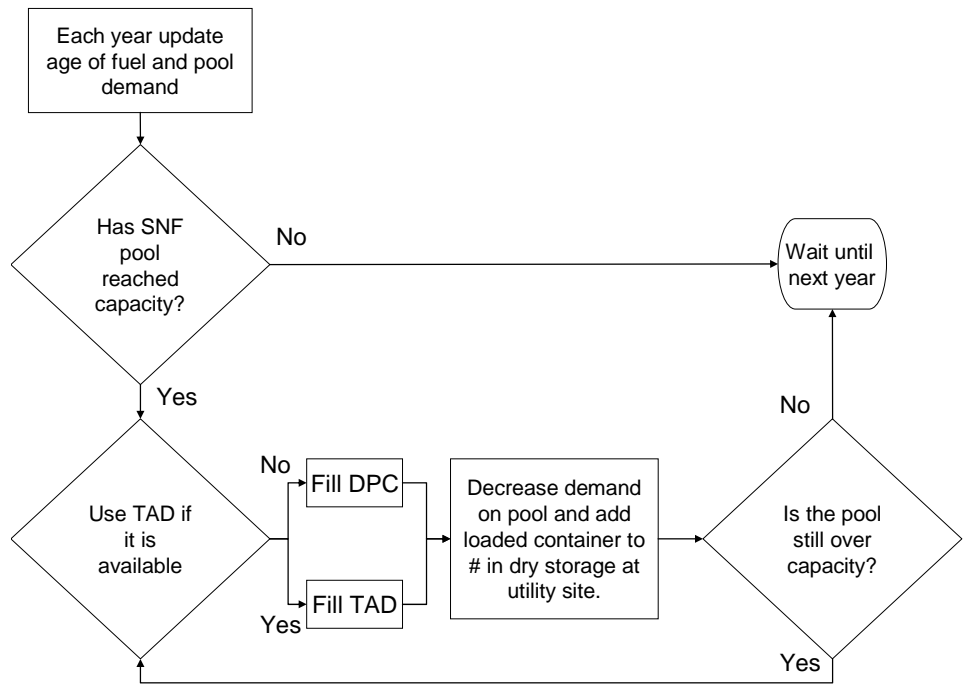

The variable Count Load indicates how many containers should be loaded from each pool each year. Before the repository opens, this value will be the number of containers that the pool is over capacity. The count of containers is according to the fuel type of the pool, 21 for PWR and 44 for BWR, rounded up to the next full container.

### **Shipments to YM**

Once the repository opens, a particular number of shipments (ranging from 0- MaxSendTrain containers) to be sent to YM are assigned to each pool. Shipments to the repository are triggered by the Allocator Element within GoldSim and are modeled as discrete transactions on a yearly basis. The Allocator Element within GoldSim is utilized to create a dynamic shipment schedule, allocating shipments from waste generation facilities based on pre-defined priorities, such as the age of the fuel or the available capacity for storage in the spent nuclear fuels at the waste generation sites. Two separate strategies are implemented for allocations.

One strategy utilizes the Allocator within each operator group (Allocator1). The yearly input to this allocator is pre-determined from an MSAccess table that was created (AllocUtiliyYear) and uploaded into Golsim as separate arrays (AllocationUtility) in the CloneAllocation container of each Purchaser Group which lists the allocations in units of TADs each year for each Purchaser. It was created based on an oldest fuel first order, allocating a total of 300 TADs per year. The Allocator for each Purchaser is only linked to the pools that are owned by the Purchaser. Another strategy uses a single Allocator (AllocatorAll) for all the pools. The input for this allocator is the amount of the entire

receipt-rate for YM in a given year. Allocations continue each year until YM has reached capacity.

Priorities for the allocations can be adjusted as variables. The options include choosing the pool with the: hottest assembly (1), coldest assembly (2), or least remaining capacity (3). The demand of each pool is either the maximum number of shipments in a given year, or the number of shipments left in the pool that are cool enough to send to YM. When the total number of containers that are destined for YM have been loaded, the demand is equal to the containers that are remaining on the dry storage pad that were loaded before YM opened. This ensures that TADs that were loaded *before* YM opens are eventually sent to YM.

Allocation distribution and loading can be described with the following logic:

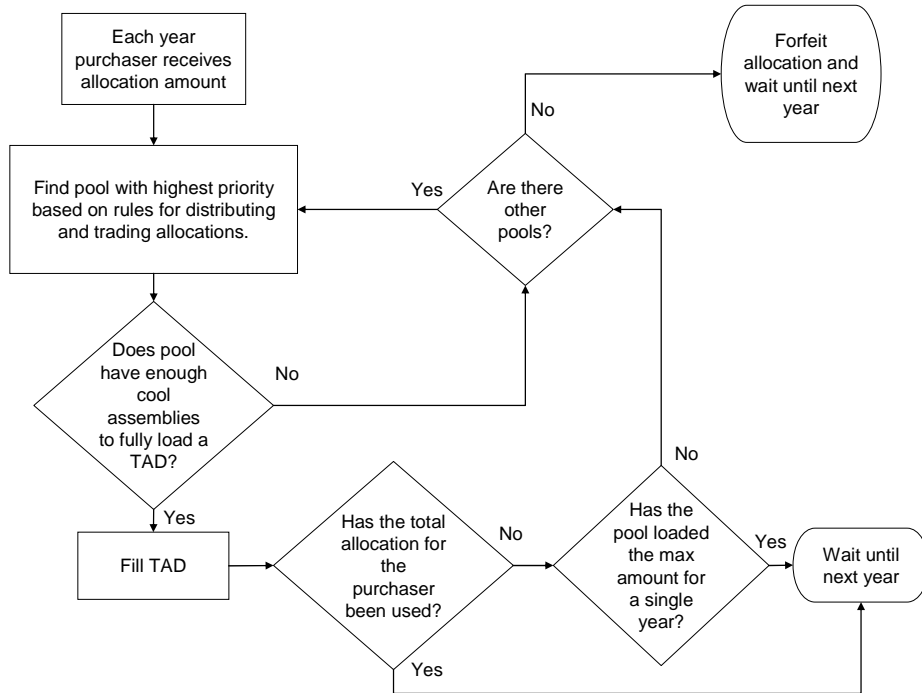

The variable Allocation indicates the amount that has been allocated to a pool each year. It is the minimum of the output of the Allocator Element and the maximum amount a pool can send in a given year (MaxSendTrain).

The variable CountLoad is still used to indicate the number of containers that should be loaded each year after YM opens, however now it is the allocation amount minus both the DPCs that should be sent from dry storage that year (CountSendFromISFISI) and the TADs that should be sent from dry storage that year (CountSendFromISFISI\_1). CountLoad is zero if the capacity of YM has already been reached or if the allocation is zero. If the pool needs to load because it is over capacity, it still does so, but the total amount the pool loads will be the amount it needs to in order to not be over capacity plus the remainder of the allocation after it loads that amount. This

ensures that a pool will not load more than the total allocation, unless the amount it needs to load because it is over capacity is greater than the allocation.

The CountSendFromISFISI (for TADs and DPCs) is a function of the variable that controls if the utility sends dry storage containers before loading from the pool (Pool First) and the preference for removing dry storage containers (SendOrder). If the dry storage pad is to be emptied before the pool, then it will try to fill the entire allocation with dry storage containers of choice. If TADs are sent first, and there are enough to fulfill the entire allocation, then it will send no DPCs. If DPCs are sent first and there are enough TADs left, then it will send zero DPCs. When the top priority container is gone, it will fulfill the allocation with the second priority container. If a proportional amount is to be sent, then it will send a proportional amount of the allocation, depending on how many TADs or DPCs are in storage and the size of the allocation. If the pool is the top priority indicated by PoolFirst, it will only send from the dry storage pad when there are not enough cold assemblies in the pool to fulfill the allocation. The same rules are followed for choosing a container based on SendOrder.

DPCs or TADs are removed in the order in which they were put on the dry storage pads, or first in first out. The variables (NextIndexStorage) and (NextIndexStorage\_1) track the index of the next TAD and DPC that should be taken from the dry storage pad each year.

Allocations continue until YM has reached capacity. When the total number of containers that have been loaded is equal to the limit for YM, then YMCapacity will turn to true. Since some of the containers that were loaded may not have been sent to YM yet, when YMCapacity is true, the TADs and DPCs that were loaded before YM opened and

remain on the dry storage pad are sent to YM. However, the dry storage that was loaded because the pool was over capacity while YM was receiving waste will remain on the storage pad at the utility sites. These are labeled as CountAfterCap packages because they are not included in the total inventory planned for YM.

### **Surface Facility Logic**

GoldSim Elements tracking the cumulative amount of shipments that have been sent to YM and are either above or below the thermal emplacement limit are also defined. These are summations of the containers associated with the pools that are either above or below the emplacement limit and are marked as sent to YM in the Container Location Array.

Since the model categorizes containers as DPC or TAD, a percentage of the assemblies that are not in DPCs are assumed to arrive as bare-fuel casks, and are routed to the WHF each year. The demand in units of DPCs to the WHF is adjusted from a 21 PWR, 44 BWR sized canister to be equal to a 36 PWR or 74 BWR canister.

Demand on the surface facilities is determined based on the following flow model:

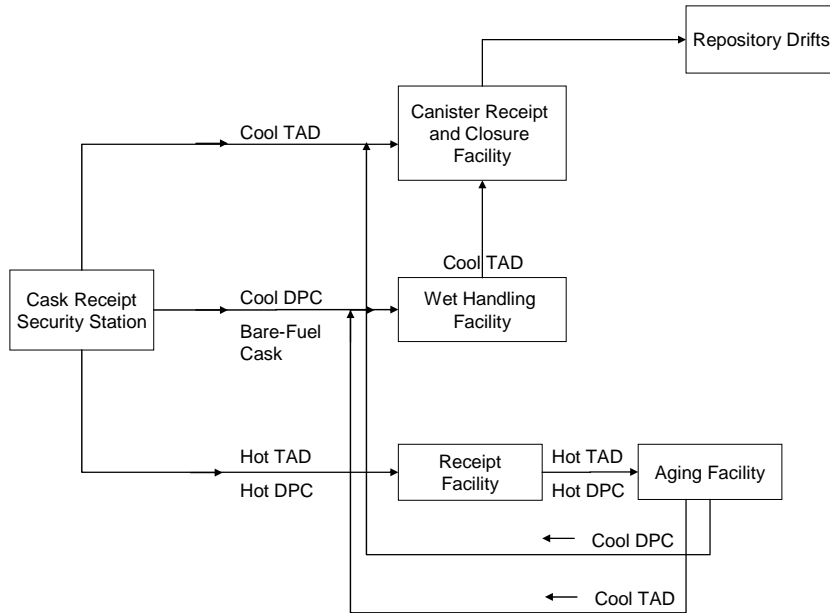

## User Defined Input Variables

| Variable Name                      | Variable Description  | Unit           | Level 1                        | Level 2                                     | Level 3                                       |
|------------------------------------|---|----------------|--------------------------------|---|---|
| TAD Year<br>(Kouts 2006)           | Year TAD becomes available  | Year           | 2012                           | 2016  | 2020  |
| Repository Year<br>(Williams 2006) | Year DOE starts accepting commercial spent nuclear fuel (assumed to begin with the steady-state receipt rate)                 | Year           | 2020                           | 2025  | 2030  |
| Heat Limit<br>Transportation       | The maximum thermal output allowed at time of packaging for storage at utility site   | kW             | 18kW                           | 21.5kW                                      | 25kW  |
| Loading Transport                  | Utility preference for choosing assemblies from the pool to load into dry storage   | N/A<br>(Logic) | YFF at least 5 years old       | YFF at least 10 years old                   | Oldest fuel first                             |
| Send Order                         | Utility preference for removing casks from dry storage  | N/A<br>(Logic) | TAD                            | DPC   | Proportional Amounts                          |
| Pool First                         | Utility preference for removing waste stored on-site  | N/A<br>(Logic) | Pool First                     | Dry Storage Pad First                       |   |
| Trading                            | Allocations are assigned either to specific reactor pools or to purchasers. Purchasers are also allowed to trade allocations. | N/A<br>(Logic) | Assigned to reactor pools      | Assigned to purchasers                      | Purchasers allowed to trade                   |
| Priority Method                    | Purchases may be allowed to trade allocations   | N/A<br>(Logic) | Based on youngest fuel in pool | Based on oldest fuel in pool                | Based on least remaining capacity in the pool |
| Emplacement Limit<br>(BSAIC 2005)  | The maximum thermal output allowed at time of emplacement for a WP  | kW             | 11.8 kW                        | 14.9 kW                                     | 18 kW   |
| YM Cap Number<br>(DOE 2006a)       | Assumed number of TADs to be emplaced in YM.  | Number of TADs | 7,500                          | Large enough to emplace all projected waste |   |
| Receipt-Rate for YM                | The number of TAD-equivalents sent to YM each year.   | Number of TADs | 300                            | 250   |   |
| Max Send Train                     | Maximum number of TADs that can be sent from a single facility in one year  | Number of TADs | 10                             |   |   |



## Response Variables and Data Analysis

Scenarios are carried out by housing the model within an outer model that feeds the input variables for each deterministic realization. As each scenario is carried out, response variables are recorded yearly to a Microsoft Excel workbook; each row is a year of the simulation, and each column represents a different scenario. The response variables, tracked separately for each pool, are located within the container labeled “Expose to Pool”. The variables within this container are exposed to the pool level, meaning they are linked to variables outside of the pool container. This way, the response variables are summed over all the pools to obtain a value for the entire set of pools.

| <b>Response Variable Name</b> | <b>Variable Description</b>  |
|-------------------------------|--|
| Count After Cap               | Casks that are loaded after YM reaches capacity due to lack of capacity in the spent nuclear fuel pools at the utility sites |
| Count Aging DPC               | DPCs that are at YM and above the emplacement limit  |
| Count Aging TAD               | TADs that are at YM and above the emplacement limit  |
| Count At YM                   | Total number of TAD equivalents at YM  |
| Count DPC                     | Total number of DPCs loaded  |
| Count Emplaced DPC            | Canisters marked as DPCs that are below the emplacement limit and sent to the WHF to be reloaded into TADs and emplaced      |
| Count Emplaced TAD            | TADs that are at YM and below the emplacement limit  |
| Count Empty                   | Count of the number of empty pools   |
| Count ISFSI                   | Count of TADs in dry storage at the utility sites  |
| Count Loaded                  | Total count of containers that have been loaded  |
| Count Pools                   | Number of pools sending shipments to YM in a given year  |
| Sum Pool                      | Number of assemblies in wet storage  |

## Scenarios

Scenarios were carried out in a deterministic fashion in order to gain an understanding of the relative importance of each input variable with respect to how it impacted the response variables.

A total of 81 scenarios were considered for the analysis described in Chapter 2. Nine sub-scenarios were created by manipulating four variables (year YM opens, year TAD becomes available, transportation thermal limit, and emplacement thermal limit) from their high to low values while holding all others at their central value. Each of these *nine* sub-scenarios was considered under *three* utility assembly selection loading behaviors (YFF5, YFF10, OFF), creating 27 combinations of sub-scenarios with assembly selection orders. This set of 27 scenarios was repeated 3 times: (1) assuming that purchasers did not trade allocations and a capacity of 7,500 TADs for YM, (2) assuming purchasers did not trade allocations and an expanded capacity of YM, and (3) assuming that purchasers could trade allocations based on least remaining capacity in the spent nuclear fuel pools for the current legal capacity of YM. This created a total of  $9 \times 3 \times 3$ , or 81 scenarios.

| <b>Sub Scenario Parameter Adjusted</b> | <b>Subscenario ID</b> | <b>Value</b> |         |
|--|-----------------------|--------------|---------|
| Year TAD in Use                        | R1                    | High         | 2020    |
|  | R2                    | Low          | 2012    |
| Year Repository Open                   | R3                    | High         | 2030    |
|  | R4                    | Low          | 2020    |
| Transportation Heat Limit              | R5                    | High         | 25 kW   |
|  | R6                    | Low          | 18 kW   |
| Emplacement Heat Limit                 | R7                    | High         | 18 kW   |
|  | R8                    | Low          | 11.8 kW |
| All Subscenario Parameters             | R9                    | Central      |         |

| <b>YM Capacity</b> | <b>Allocation Trading</b>      | <b>Assembly Selection</b> | <b>Subscenarios Explored</b> |
|--------------------|--------------------------------|---------------------------|------------------------------|
| 7500 TADs          | No                             | OFF                       | R1-R9                        |
|                    |                                | YFF10                     | R1-R9                        |
|                    |                                | YFF5                      | R1-R9                        |
|                    | Based on capacity in SNF pools | OFF                       | R1-R9                        |
|                    |                                | YFF10                     | R1-R9                        |
|                    |                                | YFF5                      | R1-R9                        |
| 14000 TADs         | Based on age of SNF            | OFF                       | R1-R9                        |
|                    |                                | YFF10                     | R1-R9                        |
|                    |                                | YFF5                      | R1-R9                        |

A total of 162 scenarios were considered for the analysis reported in Chapter 3 and 4. The subset of 27 scenarios was repeated 6 times, grouped as two sets of three. These sets assume that assemblies were removed from the pool before dry storage is removed and vice versa. The three options within each set follow one of the orders for dry storage removal: (1) TADs first, (2) DPCs first, or (3) a proportional amount. Total receipt rate is limited to 250 TADs per year and total capacity is limited to 7,250 instead of 7,500 so that the model results could be better compared to DOE's assumptions in the Preliminary Hazards Analysis (DOE 2006b). DOE assumes that 1,571 site-specific TADs and 5,676 utility TADs, about 7,250 total TADs, would be processed at YM. Receipt rate is documented to be anywhere from 250-300 TADs per year in the 2005 TSM study (BSAIC 2005).

| <b>Subscenario Parameter Adjusted</b> | <b>Subscenario ID</b>                | <b>Value</b>              |                              |
|---------------------------------------|--------------------------------------|---------------------------|------------------------------|
| Year TAD in Use                       | R1                                   | High                      | 2020                         |
|                                       | R2                                   | Low                       | 2012                         |
| Year Repository Open                  | R3                                   | High                      | 2030                         |
|                                       | R4                                   | Low                       | 2020                         |
| Transportation Heat Limit             | R5                                   | High                      | 25 kW                        |
|                                       | R6                                   | Low                       | 18 kW                        |
| Emplacement Heat Limit                | R7                                   | High                      | 18 kW                        |
|                                       | R8                                   | Low                       | 11.8 kW                      |
| All Subscenario Parameters            | R9                                   | Central                   |                              |
| <b>Waste Removal Priority</b>         | <b>Dry Storage Removal Priority</b>  | <b>Assembly Selection</b> | <b>Subscenarios Explored</b> |
| Pool before Dry Storage               | TADs before DPCs                     | OFF                       | R1-R9                        |
|                                       |                                      | YFF10                     | R1-R9                        |
|                                       |                                      | YFF5                      | R1-R9                        |
|                                       | DPCs before TADs                     | OFF                       | R1-R9                        |
|                                       |                                      | YFF10                     | R1-R9                        |
|                                       |                                      | YFF5                      | R1-R9                        |
|                                       | Proportional Amount of TADs and DPCs | OFF                       | R1-R9                        |
|                                       |                                      | YFF10                     | R1-R9                        |
|                                       |                                      | YFF5                      | R1-R9                        |
| Dry Storage before Pool               | TADs before DPCs                     | OFF                       | R1-R9                        |
|                                       |                                      | YFF10                     | R1-R9                        |
|                                       |                                      | YFF5                      | R1-R9                        |
|                                       | DPCs before TADs                     | OFF                       | R1-R9                        |
|                                       |                                      | YFF10                     | R1-R9                        |
|                                       |                                      | YFF5                      | R1-R9                        |
|                                       | Proportional Amount of TADs and DPCs | OFF                       | R1-R9                        |
|                                       |                                      | YFF10                     | R1-R9                        |
|                                       |                                      | YFF5                      | R1-R9                        |

## **Validation**

Several test cases were performed during model development to ensure that there were no errors in programming. These are described in terms of the different functions performed by the model.

### *Thermal Power Output Calculation*

A sample assembly thermal decay output can be calculated in a Microsoft Excel spreadsheet and compared with the GoldSim output from the Lookup tables stored in the array Current Heats for several values of burnup, enrichment, and years out reactor. This can be performed to ensure that the Lookup Table function is properly interpolating between values.

### *Loading Algorithms*

Several hypothetical pool scenarios can be created to test the three loading algorithms of OFF, YFF10 and YFF5. A test case can be created within a PWR pool. For any hypothetical case, the variable values can be tracked over time by checking the Time History box in the variable dialog. This allows for easily checking the history of the simulation to verify that the model is working correctly.

The following discharge dates and assembly counts should be used, while setting the pool capacity to 230, the repository year to 2020 and the year the TAD is available to 2010.

| Cycle Group | Count Assembly Start | Date Loaded |
|-------------|----------------------|-------------|
| 1           | 21                   | 33602       |
| 2           | 21                   | 33969       |
| 3           | 21                   | 34334       |
| 4           | 21                   | 34699       |
| 5           | 21                   | 35064       |
| 6           | 21                   | 35430       |
| 7           | 21                   | 35795       |
| 8           | 21                   | 36160       |
| 9           | 21                   | 36525       |
| 10          | 21                   | 36891       |
| 11          | 21                   | 37256       |
| 12          | 21                   | 37621       |
| 13          | 21                   | 37986       |
| 14          | 21                   | 38352       |
| 15          | 21                   | 38717       |
| 16          | 21                   | 39082       |
| 17          | 21                   | 39447       |
| 18          | 21                   | 39813       |
| 19          | 21                   | 40178       |
| 20          | 21                   | 40543       |
| 21          | 21                   | 40908       |
| 22          | 21                   | 41274       |
| 23          | 21                   | 41639       |

The burnup and enrichment of the cycle groups should be set to the same values so that the pattern in thermal heat output can easily be recognized over time for all assemblies.

The transportation heat limit should be set to a value that allows a canister to be fully loaded with 5 year old fuel assemblies. This total limit will depend on the enrichment and burnup values chosen for the cycle group, but will be much higher than any realistic value so it could just be set to an extremely large number ( $1 \times 10^6$ ) for this test case. If zone loading is turned off, then the total limit will be the thermal decay limit for

one 5 year old assembly multiplied by the number of assemblies in the canister. For example, a 40 GWd/Mtu burnup and 4% enrichment PWR assembly will be approximately 2,200 kW at 5 years, equal to a total limit of 46,200 kW. If zone loading is turned on, then the thermal decay limit should be high enough to allow the hot assemblies to be 5 years old.

The simulation should be run from the year 2002 to 2015. One container will be loaded each year to keep up with the discharges that occur each year. This will continue until the pool is empty in 2015. In (Container Location), the containers loaded before the TAD are marked as a 4 and the ones that are loaded after 2010 are marked as a 3.

If the Loading Transport variable is set to OFF, the discharge cycle groups will be emptied starting with the first discharge group and working toward the cycle groups that were discharged more recently.

If the algorithm is set to YFF10 or 5, the cycle groups will be emptied starting with the most recent that is at least ten or five years old, respectively. This will be the 6<sup>th</sup> cycle group for YFF5 and the 1<sup>st</sup> group for YFF10 if the data listed above is used. The next TAD will use assemblies from the 7<sup>th</sup> or the 2<sup>nd</sup> cycle group and so on, since the discharge groups are spaced one year apart. The cycle groups that the containers were pulled from can be viewed in Container Matrix.

To test the container loading functions after YM is open, set the capacity equal to  $1 \times 10^6$ . This will prevent any loading before YM opens. The simulation should be run from 2002 to 2025, with the repository set to open in 2020. From 2002 to 2020, no containers will be loaded. From 2020 to 2025, two containers will be loaded each year.

*Balancing Assembly Inputs and Container Outputs*



The count of assemblies within each cycle group at the start of the simulation in the array (Count Assembly Start) can be matched to the sum of the assemblies counted as removed from the cycle group. The sum of each row of the ContainerMatrix for each pool is equal to the total number of assemblies in the container for the fuel type, 21 or 44. ContainerMatrixRow sums the rows, so this final array value can be checked to match 21 or 44 in each cell.

The total number of assemblies discharged, which is the sum of the Count Assembly Start Vector, is checked to be equal to the sum of the number of assemblies loaded, the number of assemblies still in the pool, and the number of assemblies that may have been short loaded in the last canister.

The aggregate number of containers loaded among all the pools in Count Loaded is equal to the sum of Count After Cap, Count Aging DPC, Count Aging TAD, Count ISFSI, Count Emplaced DPC, and Count Emplaced TAD. If the simulation is set so that no containers are loaded, then the aggregate SumPool at a date after which all the assemblies have been discharged will be equal to the sum of the assemblies in the CountAssemblyStart Vectors for each pool.

## REFERENCES

- BSAIC. (1999). "Preliminary Design Basis for WP Thermal Analysis." Participant#: MOL.19980203.0529. Bechtel SAIC Company, LLC, Washington, DC.
- BSAIC. (2005d). "TSM System Study: Impact of a Canister-Based System on the CRWMS, Phase I." Participant#: MOL.20060801.0132, MIS-CRW-SE-000003 REV00, Bechtel SAIC Company, LLC.
- DOE. (2006a). "Draft Supplemental Environmental Impact Statement for a Geologic Repository for the Disposal of Spent Nuclear Fuel and High-Level Radioactive Waste at Yucca Mountain, Nye County, Nevada." DOE/EIS-0250F-S1D. Department of Energy, Office of Civilian Radioactive Waste Management, Washington, D.C.
- DOE. (2006b). "Yucca Mountain Project Critical Decision-1 Preliminary Hazards Analysis." Participant#: ENG.20060505.0009, TDR-MGR-RL-000004 REV 02, Department of Energy Office of Civilian Radioactive Waste Management, Las Vegas, NV.
- Goldsim. (2007). "Goldsim Official Website." Available at: [www.goldsim.com](http://www.goldsim.com).
- Kouts, C. (2006b). "Transportation, Aging and Disposal Canister (TAD) System Development and Implementation." NRC Management Meeting, Pahrump, NV. .December 7, 2006. Available at: <http://www.nrc.gov/waste/hlw-disposal/public-involvement/mtg-archive.html>
- Williams, M. "Opening Remarks." (2006). NRC/DOE Technical Exchange and Management Meeting on Design Changes Approved Through DOE's Critical Decision-1 Process, Las Vegas, NV. August 29, 2006. Available at: <http://www.nrc.gov/waste/hlw-disposal/public-involvement/mtg-archive.html>.

## APPENDIX B

### STATISTICAL TEST RESULTS

#### Chapter 2 Results

##### *Effect of Trading Allocations Based on Least Remaining Capacity in SNF Pools*

##### Description of T-test

The paired t-test is applied to test if there is a significant difference in the mean of the response variable for paired values. Two sets of 9 subscenarios are matched, each with three samples (OFF, YFF, and YFF10), resulting in 27 total samples. The scenarios are identical except in one set of 27, the treatment is to allow trading and in the second one the treatment is to not allow trading. The comparison is blocked by the 9 subscenarios.

The null hypothesis is that the difference between the mean of the values in the population of the scenarios that do allow trading is not significantly different from the mean of the values in the population of scenarios that do not allow trading.

##### Description of T-test Output:<sup>1</sup>

The means comparison method can be thought of as determining if the actual difference in the means is greater than the difference that would be significant. This difference is called the LSD (least significant difference). The LSD term is used both for Student's  $t$  intervals and in context with intervals for other tests. In the comparison circles

---

<sup>1</sup> description taken from JMP Software Statistics and Graphics User Guide, Multiple Comparisons

graph, the distance between the circles' centers represent the actual difference. The LSD is what the distance would be if the circles intersected at right angles.

The top table is the Means Comparisons table, which shows all means comparisons with the differences between each pair. The groups are listed with the differences sorted in descending order. The difference in means in the upper right, the row mean( $i$ ), is farthest above the column mean ( $j$ ). There are zeros along the diagonal where each mean is subtracted from itself.

The bottom table is the difference between the absolute difference and the LSD that would be significantly different. If the values are positive, the difference is judged to be significant. The greatest differences are typically in the upper-right and lower-left corners, and the non-significant differences are generally down the diagonal of the table.

## Effect on Utility Site Storage

Response Variable: Expected aggregate demand for dry storage at the waste generation sites in the year that YM reaches current legal capacity. There are 3 samples for each subscenario, and 9 subscenarios for a total of 27 samples for each treatment of trading or no trading.

Dif=Mean[i]-Mean[j]

|     | No      | Yes    |
|-----|---------|--------|
| No  | 0.00    | 275.67 |
| Yes | -275.67 | 0.00   |

Alpha= 0.05

Comparisons for each pair using Student's t

| t       | Alpha |
|---------|-------|
| 2.01537 | 0.05  |

Abs(Dif)-LSD

|     | No     | Yes    |
|-----|--------|--------|
| No  | -14.12 | 261.55 |
| Yes | 261.55 | -14.12 |

Positive values show pairs of means that are significantly different.

| Level | Mean      |
|-------|-----------|
| No A  | 569.37037 |
| Yes B | 293.70370 |

Levels not connected by same letter are significantly different

Conclusion: Reject null hypothesis. The mean of the populations is significantly different with an alpha of 0.05.

## Effect on Transportation

Response Variable: Average number of pools sending shipments in a given year. There are samples for each year, covering a time span of 40 years, within each scenario. The time span covers a total of 40 years to accommodate for the variation in the opening date of the repository. This results in 40\*3 samples for each subscenario and 9 subscenarios, for a total of 1,080 samples for each treatment of trading and no trading. The test is blocked by subscenario.

| Dif=Mean[i]-Mean[j] |         |        |
|---------------------|---------|--------|
|                     | No      | Yes    |
| No                  | 0.000   | 11.156 |
| Yes                 | -11.156 | 0.000  |

Alpha= 0.05

Comparisons for each pair using Student's t

|  | t       | Alpha |
|--|---------|-------|
|  | 1.96140 | 0.05  |

| Abs(Dif)-LSD |         |         |
|--------------|---------|---------|
|              | No      | Yes     |
| No           | -2.0810 | 9.0680  |
| Yes          | 9.0680  | -2.0949 |

Positive values show pairs of means that are significantly different.

| Level | Mean      |
|-------|-----------|
| No A  | 31.345738 |
| Yes B | 20.189781 |

Levels not connected by same letter are significantly different.

Conclusion: Reject null hypothesis. Therefore, the mean of the populations is significantly different with an alpha of 0.05.

## Effect on Aging at YM

Response Variable: Number of years Aging Facility is occupied, pooling all assembly selection orders. There are 3 samples for each subscenario, and 9 subscenarios for a total of 27 samples for each treatment of trading or no trading.

Dif=Mean[i]-Mean[j]

|     | Yes     | No     |
|-----|---------|--------|
| Yes | 0.0000  | 4.6667 |
| No  | -4.6667 | 0.0000 |

Alpha= 0.05

Comparisons for each pair using Student's t

| t       | Alpha |
|---------|-------|
| 2.01537 | 0.05  |

Abs(Dif)-LSD

|     | Yes     | No      |
|-----|---------|---------|
| Yes | -1.7180 | 2.9486  |
| No  | 2.9486  | -1.7180 |

Positive values show pairs of means that are significantly different.

| Level | Mean      |
|-------|-----------|
| Yes A | 31.666667 |
| No B  | 27.000000 |

Levels not connected by same letter are significantly different.

Conclusion: Reject null hypothesis. Therefore, the mean of the populations is significantly different with an alpha of 0.05.

Response Variable: Number of canisters in Aging Facility, pooling all assembly selection order scenarios. There are samples for each year, covering a time span of 40 years, within each scenario. The time span covers a total of 40 years to accommodate for the variation in the opening date of the repository. This results in 40\*3 samples for each subscenario and 9 subscenarios, for a total of 1,080 samples for each treatment of trading and no trading. The test is blocked by subscenario.

| Dif=Mean[i]-Mean[j] |         |        |
|---------------------|---------|--------|
|                     | Yes     | No     |
| Yes                 | 0.000   | 52.516 |
| No                  | -52.516 | 0.000  |

Alpha= 0.05

Comparisons for each pair using Student's t

|  | t       | Alpha |
|--|---------|-------|
|  | 1.96107 | 0.05  |

| Abs(Dif)-LSD |         |         |
|--------------|---------|---------|
|              | Yes     | No      |
| Yes          | -40.186 | 12.330  |
| No           | 12.330  | -40.186 |

Positive values show pairs of means that are significantly different.

| Level | Mean      |
|-------|-----------|
| Yes A | 363.50185 |
| No B  | 310.98611 |

Levels not connected by same letter are significantly different

Conclusion: Reject null hypothesis. There difference between the mean of the populations is significantly different with an alpha of 0.05.



Response Variable: Number of canisters in Aging Facility assuming oldest fuel is sent first. There are 40 years of samples for each subscenario/assembly selection order combination and 9 subscenarios, for a total of 360 samples for each treatment of trading and no trading. The test is blocked by subscenario.

Dif=Mean[i]-Mean[j]

|     | Yes     | No     |
|-----|---------|--------|
| Yes | 0.000   | 80.973 |
| No  | -80.973 | 0.000  |

Alpha= 0.05

Comparisons for each pair using Student's t

|  | t       | Alpha |
|--|---------|-------|
|  | 1.96323 | 0.05  |

Abs(Dif)-LSD

|     | Yes     | No      |
|-----|---------|---------|
| Yes | -15.428 | 65.545  |
| No  | 65.545  | -15.428 |

Positive values show pairs of means that are significantly different.

| Level | Mean      |
|-------|-----------|
| Yes A | 119.06504 |
| No B  | 38.09214  |

Levels not connected by same letter are significantly different

Conclusion: Reject null hypothesis. Therefore, the mean of the populations is significantly different with an alpha of 0.05.

Response Variable: Number of canisters in Aging Facility assuming youngest fuel at least 10 years old is sent first.

Dif=Mean[i]-Mean[j]

|     | Yes     | No     |
|-----|---------|--------|
| Yes | 0.000   | 38.125 |
| No  | -38.125 | 0.000  |

Alpha= 0.05

Comparisons for each pair using Student's t

| t       | Alpha |
|---------|-------|
| 1.96323 | 0.05  |

Abs(Dif)-LSD

|     | Yes     | No      |
|-----|---------|---------|
| Yes | -48.622 | -10.497 |
| No  | -10.497 | -48.622 |

Positive values show pairs of means that are significantly different.

| Level | Mean      |
|-------|-----------|
| Yes A | 317.65854 |
| No A  | 279.53388 |

Levels not connected by same letter are significantly different

Conclusion: Do not reject null hypothesis. Therefore, the mean of the populations is not significantly different with an alpha of 0.05.

Response Variable: Number of canisters in Aging Facility assuming youngest fuel at least 5 years old is sent first.

Dif=Mean[i]-Mean[j]

|     | Yes     | No     |
|-----|---------|--------|
| Yes | 0.000   | 39.778 |
| No  | -39.778 | 0.000  |

Alpha= 0.05

Comparisons for each pair using Student's t

|  | t       | Alpha |
|--|---------|-------|
|  | 1.96323 | 0.05  |

Abs(Dif)-LSD

|     | Yes     | No      |
|-----|---------|---------|
| Yes | -89.890 | -50.113 |
| No  | -50.113 | -89.890 |

Positive values show pairs of means that are significantly different.

| Level | Mean      |
|-------|-----------|
| Yes A | 603.40650 |
| No A  | 563.62873 |

Levels not connected by same letter are significantly different

Conclusion: Do not reject null hypothesis. Therefore, the mean of the populations is not significantly different with an alpha of 0.05.

## APPENDIX C

### DESCRIPTION OF MATERIAL TRANSFERS

#### Canister Receipt and Closure Facility Transfers

TADs arriving at the CRCF undergo 3 transfers:

- Transfer 1 involves one of the following, depending on the TAD's origin:
  - If the TAD arrives from the utilities, the *transportation overpack* holding the TAD will be loaded into the preparation area.
  - If the TAD is site-specific arriving from the WHF, the *shielded transfer cask* holding the TAD will be transferred from a cask transporter to the preparation area.
  - If the TAD is site-specific arriving from the Aging Facility, the *aging overpack* holding the TAD will be transferred from the cask transporter to the preparation area.
- Transfer 2: the TAD is transferred to the WP.
- Transfer 3: the TAD inside an unsealed WP is installed on the bedplate of the waste package transporter and sent to be emplaced. A trolley moves the WP to the closure cell where the WP is sealed. The WP is then moved with the same trolley to the load-out cell where it is rotated to a horizontal orientation and pushed into the Transport Emplacement Vehicle (TEV) which moves the WP to the underground.

## Wet Handling Facility Transfers

DPCs arriving at the CRCF undergo up to 4 transfers:

- Transfer 1: the transportation cask, shielded transfer cask, or aging overpack holding the DPC is moved from a cask transporter to the preparation area.
- Lid Lift 1: the lid of the transportation cask, shielded transfer cask, or aging overpack is removed *prior* to the DPC transfer.
- Transfer 2: the DPC is transferred from an aging overpack to a shielded transfer cask.
- Transfer 3: the shielded transfer cask holding the DPC is transferred to the cask cooling area.
- Lid Lift 2: the lid of the shielded transfer cask is installed *after* transfer of the DPC.
- Transfer 4: the shielded transfer cask holding the DPC is transferred from the cask cooling area to the pool.

TADs originating in the WHF undergo 4 transfers:

- Transfer 1: the shielded transfer cask holding the TAD is transferred from the pool to the drying/sealing area.
- Transfer 2: the shielded transfer cask holding the TAD is transferred from the drying/sealing area to a loading area.
- Transfer 3: the TAD is transferred from a shielded transfer cask to an aging overpack.
- Transfer 4: the aging overpack is transferred to a cask transporter and sent to the Aging Facility. (DOE conservatively assumes that all TADs originating in the

WHF are aged before they are emplaced because of the uncertainty involved in determining the heats of the TADs coming out of the WHF. If the Site-specific TAD is not aged, there is one less transfer in the WHF because the canister is sent straight to the CRCF in the shielded transfer cask via a cask transporter.)

### **Receipt Facility Transfers**

For vertical DPCs or TADs arriving at the RF:

- Transfer 1: the transportation cask holding the TAD or DPC is moved to the preparation pit.
- Lid Lift 1: the lid of the transportation cask is removed prior to DPC transfer.
- Transfer 2: the TAD or DPC is transported to an aging overpack.
- Lid Lift 2: the lid of the aging overpack is installed after transfer of the DPC.
- Transfer 3: the aging overpack is transferred to a cask transporter. It is likely that the drop height for such a lift would be small, and therefore not conducive to a DPC breach. Still, conservatively, a drop during this transfer is considered to cause a breach.

For horizontal DPCs arriving at the RF:

- Transfer 1: the transportation cask is transferred to a site transporter (in a horizontal orientation), the transporter moves the DPC within the transportation cask to the aging pad, and the DPC is pushed into a horizontal storage module.

**APPENDIX D**

**WM2008 CONFERENCE PAPER**

## **Evaluating the Potential Impact of Using the Transport, Aging and Disposal (TAD) Canister on Yucca Mountain Pre-Closure Operations – 8037**

Authors: Leah Spradley\*, Research Assistant, Civil and Environmental Engineering,  
Vanderbilt University, VU Station B 351831  
2301 Vanderbilt Place  
Nashville, TN 37235-1831

Mark Abkowitz, Professor, Civil and Environmental Engineering,  
Vanderbilt University, and  
James H. Clarke, Professor, Civil and Environmental Engineering,  
Vanderbilt University

### **ABSTRACT**

The development and preliminary use of an integrated model to explore the impact of various operational scenarios of the pre-closure waste management system of Yucca Mountain (YM) is described. The capabilities of the model are illustrated by applying it to a simplified operational scenario using Transport, Aging, and Disposal (TAD) Canisters. The application uses existing data on spent nuclear fuel to model the effect on above ground aging at YM by varying four parameters: (1) utility loading behavior, (2) thermal limit for transportation casks, (3) thermal limit for emplacement, and (4) emplacement capacity at YM. Results show that the thermal limit for emplacement is the most important parameter with respect to above ground aging demands at YM. Transportation heat limit is also important, but less so if the capacity of YM is expanded or if older fuel is sent first. Easing the constraint of the emplacement limit, if feasible, would be a preferable method of reducing aging demands, especially under an expanded emplacement capacity. Consequently, there may be incentive for Department of Energy (DOE) to either specify a lower transportation limit or a higher emplacement limit if it wishes to reduce the potential demands on the Aging Facility at YM.

### **INTRODUCTION**

The pre-closure waste management system of Yucca Mountain (YM) is defined as all components, facilities, and activities that collectively manage the spent fuel as it is packaged at the utilities, transported to the repository, processed at the YM surface facilities, and emplaced in the repository. In order to perform smoothly, this system requires long-term planning and cooperation of the spent fuel generators and the Department of Energy (DOE) among other parties (e.g. transportation and storage cask vendors, local and federal regulatory authorities). One must consider the motivations arising from the perspective of waste generators, as well as DOE, to evaluate the potential outcome of various design and operating scenarios.

---

\* Corresponding author



## **Transport, Aging, and Disposal Canister**

DOE has announced a change to the design of the pre-closure system, requiring the operators of facilities in possession of spent nuclear fuel to use a Transport, Aging and Disposal (TAD) Canister to transport shipments of commercial spent nuclear fuel to YM. Prior to this decision, spent fuel assemblies would have arrived either in bare-fuel transportation casks, or in Dual-Purpose Canisters (DPCs), which can be used for transportation and storage, but not disposal [1].

Since the TAD will be used in a variety of applications, it will be governed by several regulations. For example, a TAD loaded and welded at a nuclear power plant will be governed by 10 CFR 50. If the TAD is placed in an Independent Spent Fuel Storage Installation for interim storage, it will be regulated under 10 CFR 72. A TAD placed in an certified over-pack and transported is licensed under 10 CFR 71, while a TAD placed in an over-pack for aging at YM will fall under 10 CFR 63.

To ensure that the TAD is developed according to the requirements of 10 CFR 63, DOE, as opposed to the vendors, specifies the design of the canister. The final design specifications for the TAD were released in 2007. These design specifications will guide vendors as they prepare license applications for the TAD under 10 CFR 71 (transportation) and 10 CFR 72 (storage). It is important to note that the design specifications do not stipulate a specific thermal limit for transportation or storage, but rather provide cladding temperature determination for total thermal outputs of 11.8 kW, 18 kW, or 25 kW. Once the TAD is licensed under Part 71 and 72, utilities can begin using it for storage and transportation. DOE will submit a license application under Part 63, which will describe their use of TADs in the overall design. NRC will determine if the TAD is important to safety in its review of the license application for YM. Specifically, the agency will determine if there are attributes of the TAD that are important to waste isolation, and conversely, if there are attributes of the design that have a detrimental effect on the post-closure performance [2].

The original YM pre-closure design called for *all* the fuel assemblies to be repackaged at YM. DOE changed the design to reduce the number of bare-fuel assembly handlings that would be necessary. While use of the TAD does reduce the number of expected nuclear material handlings, as well as the expected exposure of bare commercial spent nuclear fuel to a potentially oxidizing environment, it creates a potential problem in terms of thermal management. Before any final disposal package, referred to as a Waste Package (WP), can be emplaced in YM, its total thermal heat decay must fall below a specified emplacement limit. The emplacement limit is defined as 11.8 kW in YM design documents, but ongoing studies are exploring the possibility of easing this constraint up to 18 kW or even higher [1,3]. Any packages not meeting the specified limit must be stored above ground until the contents decay to a value below the emplacement limit.

The Nuclear Waste Technical Review Board has expressed concern that the decision to use the TAD canister may impact the thermal management strategy of pre-closure operations, mainly due to the fact that the utilities, as opposed to DOE, will now decide how to blend the fuel assemblies into the *final* disposition canisters. The utilities' discretion to blend fuel to their preferences reduces DOE's control over the thermal decay heats of the packages as they are being prepared for emplacement in the mountain [4].

### **Spent Fuel Delivery Schedule**

Utilities have a fair amount of freedom as to which individual fuel assemblies they load into TADs for transport (so long as they follow the procedures specified in the license documentation for the TAD canister), but they are guided by the Nuclear Waste Policy Act (NWPA) of 1982 when setting delivery schedules for shipments to YM. The NWPA authorizes the Secretary of Energy to develop a general contract with the owners and generators of the spent fuel [5]. The *Standard Contract for Disposal of Spent Nuclear Fuel and/or High-Level Radioactive Waste* (Standard Contract) provides for the acquisition of title to the spent nuclear fuel, its transportation to Federal facilities, and its subsequent disposal [6].

The Standard Contract states that spent fuel must be at least five years old to qualify to be sent to YM. Also, for every year after the repository starts accepting waste there is a specified allocation, measured in metric tons, which each waste generator is expected to send. The term "Purchaser" is used in the contract to refer to a spent fuel generator that has been paying into the Nuclear Waste Fund. A single Purchaser may own anywhere from one to many facilities, depending on the size of the Purchaser's corporation. Allocations given to each Purchaser are detailed in the Acceptance Priority Ranking (APR) and Annual Capacity Report (ACR) developed by DOE. The queuing order (APR) is based on the date the spent nuclear fuel was permanently discharged, giving priority to the oldest spent nuclear fuel, on an industry-wide basis. This order is combined with the annual rate of acceptance for YM to calculate the annual allocations for each Purchaser [7].

Allocations in the APR/ACR Report are not contractually binding on either DOE or the Purchasers. Instead, they are meant to assist Purchasers' planning and submittal of Delivery Commitment Schedules (DCS), which specify what fuel they intend to send and the delivery dates for the shipments. The legal requirements of the DCS allow for back and forth negotiations between DOE as outlined in Article V of the Standard Contract. Purchasers must submit their schedules five years before the shipments are to be made, and DOE has three months to approve of the first submitted schedule. If DOE disapproves of the proposed schedule, the Purchaser has thirty days to revise the schedule. DOE then has sixty days to decide if the revised schedule is acceptable. If the revised DCS is not acceptable, the parties will negotiate a mutually acceptable contract. Specifically, Purchasers have the right to adjust the quantities of spent nuclear fuel by up to twenty percent and the timing of the delivery by up to two months in the negotiations[6].

Purchasers must submit the final negotiated DCS to DOE at least one year before the delivery date. *Still*, DOE may disapprove of the final schedule within forty five days, and a revised schedule may be submitted thirty days after notice of the disapproval. DOE then has another sixty days to approve of the final revised DCS. If the schedule is still not mutually acceptable, the Standard Contract calls for the parties to negotiate again. Six months before the delivery date, purchasers are permitted to *exchange* delivery committed schedules with other Purchasers as long as DOE approves of the exchange [6]. Clearly, the legal opportunity for extended negotiations opens the potential for delays in the system.

Ideally, through careful planning, the parties could create a schedule that facilitates operations of YM and needs of the waste generators. This brings motivation for analyzing the possible reasons for DOE to disapprove of a schedule. One such reason may be that DOE is unable to accept shipments over a certain thermal threshold because it would cause excessive amounts of packages to be stored above ground at YM. Another hypothetical reason DOE might disapprove a schedule is if YM surface facilities do not have adequate processing capacities to handle the ratio of package types (DPCs vs. TADs). The remainder of this paper describes a methodology that can be applied for systematically analyzing possible shipment schedule scenarios and preliminary insights resulting from its application.

## **DATA, ASSUMPTIONS AND METHODOLOGY**

The model provides an opportunity to perform analyses of various delivery schedules, while also exploring the effects of changing the transportation heat limit, the emplacement heat limit, and the planned capacity of YM. This analysis is meant to be a preliminary screening tool to evaluate the relative importance of these parameters with respect to above ground aging requirements at YM, and is not meant to predict a comprehensive set of all realistic performance outcomes. Simplifying assumptions about national fuel inventory characteristics, TAD availability, and repository operations are described below.

### **Spent Fuel Inventory Characteristics and Projections**

Inventory of spent fuel is taken from the Energy Information Administration RW-859 database from 2002 [8]. Projections of spent fuel after 2002 are assumed according to a methodology developed by DOE that assumes an annual fractional burnup increase of 0.01, up to a maximum burnup of 57 GWd/MTU for boiling water reactors (BWRs) and 62 GWd/MTU for pressurized water reactors (PWRs) [9]. Reactor shutdown dates are also assumed. We presume all reactors that are not currently planned for decommissioning are granted extensions to run for a full 60 years. But, we do not analyze scenarios in which new reactors are constructed. To simplify data requirements, the burnup, enrichment, and mass of assemblies are averaged within the same discharge group. Each year, the thermal decay heat of each assembly discharge group is

interpolated using tables for burnup, enrichment and number of years out of the reactor [10].

### **TAD Availability and Repository Opening**

Before the repository opens nuclear power plants are expected to load dry storage when their pools reach full capacity. Assemblies removed from the pool are loaded into DPCs until the TAD is available for use. At the earliest, the TAD will be available in 2012 but to accommodate for possible delays in the licensing process, and because the utilities may lack economic incentive to adopt its use, it is not assumed to be in use by all the facilities until the year 2016.

Yucca Mountain is assumed to open in 2025. DOE plans to submit a License Application (LA) to the U.S. Nuclear Regulatory Commission (NRC) in 2008. The earliest estimate for opening the repository is 2017, but further delays are expected [11]. The assumption regarding the timing of dry storage campaigns, TAD availability, and the construction of the repository are important because the age of the fuel largely determines its heat output, especially for younger fuel. Under these assumptions, approximately 6,400 metric tons, will be loaded into DPCs before the opening of the repository – the equivalent of about 800 TADs.

### **Allocations for Shipments of Spent Fuel**

Each year after the repository starts accepting waste, approximately 3,000 MTU of allocations, dictating the number of TADs each facility loads, are assigned to the Purchasers. Mergers and acquisitions have taken place since the APR/ACR was established in 2004, and it is not clear if Purchasers will adjust their contracts accordingly. In an attempt to account for allocation trading that might be facilitated by owner/operator consolidations since 2004, the Purchasers have been altered to resemble current corporate ownership. Allocations for waste delivery schedules are assigned to Purchasers according to the date of discharge but are measured in units of TADs (300 TADs/year) as opposed to metric tons since it does not make economical sense to send a TAD that is not fully loaded.

Purchasers are assumed to distribute the allocations among their facilities, giving priority to the oldest fuel (OFF), youngest fuel that is at ten years old (YFF10), or the youngest fuel that is at least 5 years old (YFF5). Each facility loads fuel from the spent nuclear fuel pool according to the same algorithm assumed for prioritizing allocations. As many as 10 TADs are permitted to be shipped from a single facility in a given year, since this is considered a reasonable amount for a facility to load during the shipping campaign. Assemblies are packaged into TADs according to a zone loading scheme, meaning that the assemblies in the center are permitted to have twice the thermal output as the assemblies on the perimeter, as long as the total heat limit remains within the thermal criteria for transport.

## Surface Facility Operations

Upon arrival at the repository, TADs that meet the emplacement limit are assumed to be emplaced immediately. If all 300 TADs arriving in one year were within the emplacement limit, processing constraints of the surface facilities may realistically prevent emplacement of all 300 in a single year. However, this application attempts to gauge the potential range of demand on the Aging Facility so processing constraints were not enforced. Any packages not meeting the emplacement limit are counted as in the Aging Facility. Sensitivity of the results to varying the transportation heat limit from 18 kW to 25 kW, and the emplacement heat limit from 11.8 kW to 18 kW are explored. The capacity of YM is either assumed to be its current 70,000 metric tons (about 7,500 TADs), or to be extended to the amount required for holding the entire spent fuel inventory projected for all the reactors if they run for a total of 60 years.

## RESULTS

Results show that emplacement heat limit is the most important variable with respect to aging above ground at YM in terms of peak aging capacity needed, as well as the length of time fuel remains in the Aging Facility. Transportation heat limit also has a clear influence over above-ground aging at YM. As seen in the Fig. 1, the largest effect is seen when emplacement heat limit is lowered from its central value of 14.9 kW to 11.8 kW, assuming youngest fuel is sent first. Both transportation and emplacement criteria become less important if older fuel is sent in place of younger fuel.

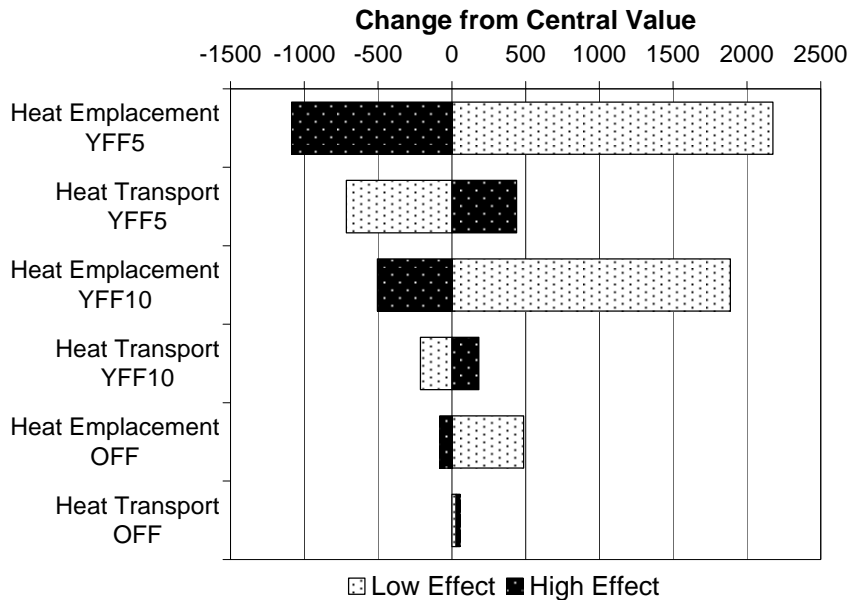

**Fig. 1 Importance chart illustrating the relative change in maximum number of TADs aging above ground due to a change in heat limit for emplacement or transportation under various waste acceptance scenarios.**

Easing the emplacement heat limit constraint is a way to decrease the above-ground aging that does not impact delivery schedules since emplacement criteria drives the routing of packages *after* it arrives at the surface facilities. Transportation heat limit, on the other hand, governs the characteristics of the fuel *before* it is shipped to YM. Therefore, decreasing the transportation heat limit to a value that is lower than what is common (i.e., 18 kW as opposed to 25 kW) should only be considered a practical way of reducing the aging required at YM if it *does not* prohibit facilities from sending shipments that would have been sent under a traditional transportation heat limit.

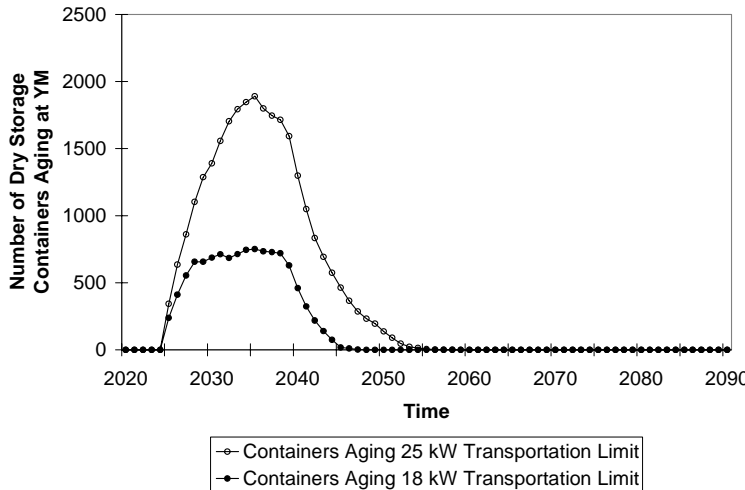

**Fig. 2 Impact on decreasing the transportation heat limit from 25 kW to 18 kW on above-ground aging if youngest fuel is sent first, assuming the current YM Capacity.**

Fig. 2 shows the amount aging above ground as the transportation limit is varied from 18 kW to 25 kW, while holding the emplacement limit at its central value of 21.5 kW. Note how the peak capacity aging above ground is effectively reduced from about 1,800 TADs to 800 TADs and the longevity of the Aging Facility is shortened by about 10 years. The rate of shipments (not shown in Fig. 2) is not changed by altering the transportation limit. This implies that there are enough cool assemblies in the Purchasers' inventories to fulfill a receipt-rate of 300 TADs per year for the entire shipping campaign under the current capacity of YM, even if the transportation heat limit is set to a lower level than what is common. However, the same is not true if the legal capacity of YM is expanded.

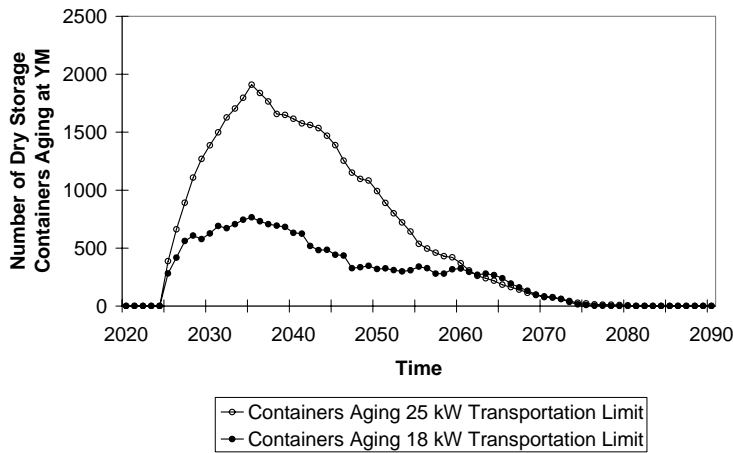

**Fig. 3 Impact on decreasing the transportation heat limit from 25 kW to 18 kW on above-ground aging if youngest fuel is sent first assuming an expanded YM Capacity.**

Fig. 3 shows the same information as Fig. 2 but assumes an expanded capacity of almost 140,000 metric tons. These scenarios shown assume that youngest fuel (at least 5 years old and meeting the per-assembly heat limit) is sent first. The maximum capacity of the Aging Facility is reduced, but the longevity of the Aging Facility is similar in both scenarios, implying that altering the transportation limit is not as effective at reducing the demands on the Aging Facility under an expanded capacity.

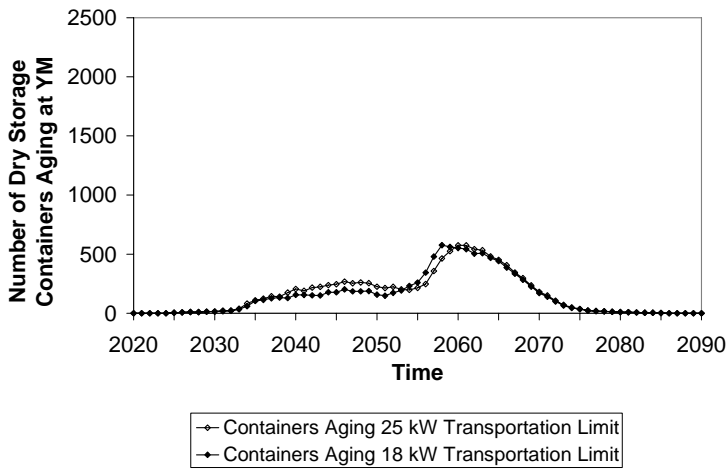

**Fig. 4 Impact on decreasing the transportation heat limit from 25 kW to 18 kW on above-ground aging if oldest fuel is sent first and assuming an expanded YM Capacity.**

Fig. 4 shows an expanded capacity but assumes that oldest fuel is sent first. During the first 10 years, the demands on the Aging Facility are largely similar under both scenarios. Starting around 2035, the curve for the 25 kW transportation limit scenario begins to exceed that of the 18 kW limit. This is because packages are taken from the dry storage pad at the waste generation sites in the 18 kW scenario, whereas in the 25 kW scenario facilities continue to load hotter fuel from the pool. After the first 30 years, there is a large increase in the number of packages that need to be aged, resulting from the fact that

much of the cooler fuel has been depleted from Purchasers' inventories. Assemblies being loaded are those that are newly meeting thermal criteria, and are therefore much hotter. The peak demand on the Aging Facility occurs around 35 years into the shipping campaign. These results suggest that decreasing the transportation limit is not as effective at reducing demands on the Aging Facility under an expanded capacity, especially if older fuel is sent first.

## **SUMMARY AND CONCLUSION**

The analysis described in this paper highlights inefficiencies of the existing allocation queue stemming from a recent decision to use the TAD canister. The existing method of assigning allocations as stipulated in the Standard Contract was developed prior to the TAD decision, and therefore does not adequately consider the ability of the utilities to optimally blend the waste according to Department of Energy's thermal management strategy. The TAD decision introduces uncertainty concerning the heats of *final* waste packages, causing potential for a highly variable capacity of the Aging Facility at the surface of YM.

The demand on the Aging Facility is minimal if the Purchasers send their oldest fuel first under the current capacity. However, Purchasers are not required to send their oldest fuel first and may prefer to send younger fuel depending on their spent fuel management strategy. If younger fuel is sent first, the aging above ground at YM can be reduced by reducing the thermal decay limit for transporting the TAD. If the legal capacity of YM is lifted to accommodate for substantially more spent fuel, however, reducing the transportation limit is less effective at controlling the demand on the Aging Facility.

In a future application of the model, the indicators of operational performance measured each year should be expanded to include the expected amount of dry storage necessary at each waste generation site as well as above ground storage at YM. In addition, the allocation queue should be dynamically created from feedback signals incorporating real-time inventories of the utilities and YM. Using this more comprehensive approach, future research could explore potential benefits achieved through alternative methods for Purchasers to prioritize allocations besides age of the fuel. The potential for Purchasers to trade allocations should also be analyzed, since the Standard Contract implies this is allowed. This will enable DOE and the Purchasers to explore whether a more efficient waste acceptance plan can be achieved.

## **ACKNOWLEDGMENTS**

The authors would like to acknowledge the support of Bridgestone Firestone of Americas and the Consortium for Risk Evaluation with Stakeholder Participation (CRESP) through a grant from the DOE, and the advice offered by members and staff of the Nuclear Waste Technical Review Board including Dr. B. John Garrick, as well as guidance provided by Dr. Frank Parker, Dr. Michael T. Ryan, Dr. Michael Stabin, and Dr. David Kosson.



## REFERENCES

- 1 “Final and Supplemental Environmental Impact Statement for a Geologic Repository for the Disposal of Spent Nuclear Fuel and High-Level Radioactive Waste at Yucca Mountain, Nye County, Nevada.” DOE/EIS-0250. Washington, D.C., U.S. Office of Civilian Radioactive Waste Management. ACC: MOL.20020524.0314 through MOL.20040524.0320. (2002)
- 2 SHAH, M., R. LEWIS, and T. MCCARTIN, “Regulatory Requirements for Transportation, Storage, Aging, and Disposal.” Presented at U.S. Nuclear Regulatory Commission NRC/DOE Technical Exchange and Management Meeting (2006)
- 3 “TSM System Study: Impact of a Canister-Based System on the CRWMS, Phase I.” Bechtel SAIC Company, LLC. MIS-CRW-SE-000003 REV 00. (2005)
- 4 “Report to Congress and the Secretary of Energy.” Nuclear Waste Technical Review Board Report. (2007)
- 5 “Nuclear Waste Policy Act of 1982, as Amended.” Public Law 97-425. January 7, 1983. Available at: <http://www.ocrwm.doe.gov/documents/nwpa/css/nwpa.htm> . (1983)
- 6 “Standard Contract for Disposal of Spent Nuclear Fuel and/or High-Level Radioactive Waste.” Code of Federal Regulations, Title 10, Part 961. (2004)
- 7 “Acceptance Priority Ranking and Annual Capacity Report.” DOE/RW-0567. Washington, D.C: U.S. Office of Civilian Radioactive Waste Management. (2004)
- 8 “RW-859 2002 Access Database and User Manual.” Energy Information Administration. (2004)
- 9 “Calculation Method for Projection of Future Spent Nuclear Fuel Discharges.” TDR-WAT-NU-000002 Rev. 01, Washington, DC: Bechtel SAIC Company, LLC. MOV.20020327.0002. (2002)
- 10 “Preliminary Design Basis for Waste Package Thermal Analysis.” Bechtel SAIC Company, LLC. MOL.19980203.0529. (1998)
- 11 WILLIAMS, M., “Opening Remarks.” Presented at NRC/DOE Technical Exchange and Management Meeting on Design Changes Approved Through DOE’s Critical Decision-1 (CD-1) Process. Las Vegas, Nevada. (2006)

## APPENDIX E

### THERMAL POWER OUTPUT TABLES

#### Description of Data Tables

The following tables contain the estimated thermal power output of a PWR or BWR assembly given: (1) the initial enrichment of the assembly, (2) the number of years the assembly has been out of the reactor, and (3) the final burnup (GW-d/MTU).<sup>1</sup> The mass is assumed to be 200 kg for BWR or 464 kg for BWR. The thermal power tables for PWR assemblies appear first, followed by the thermal power tables for BWR assemblies. Data are organized into tables for each enrichment level. Burnup values are organized into columns, with the rows representing the number of years the assembly has been out of the reactor. Thermal powers are provided in the cells of the table are in units of W/assembly. Thermal powers can be interpolated logarithmically between years out of reactor and linearly between enrichment and burnup values.

---

<sup>1</sup> See *Preliminary Design Basis for WP Thermal Analysis*, Participant #: MOL.19980203.0529. Bechtel SAIC Company, LLC. (1999)

PWR DATA TABLES

|    | A          | B        | C     | D     | E     | F      | G      | H      | I      | J      |
|----|------------|----------|-------|-------|-------|--------|--------|--------|--------|--------|
| 1  | Enrichment |          |       |       |       |        |        |        |        |        |
| 2  | 5.5        | GW-d/MTU |       |       |       |        |        |        |        |        |
| 3  | Year       | 1        | 10    | 20    | 30    | 40     | 50     | 60     | 70     | 75     |
| 4  | 5          | 25       | 244.4 | 487.7 | 739.6 | 1008.7 | 1302.3 | 1636.9 | 2008.2 | 2206.3 |
| 5  | 6          | 20.8     | 207   | 419.5 | 642.5 | 880.8  | 1148.1 | 1445.3 | 1780.4 | 1954.8 |
| 6  | 7          | 18.7     | 186.8 | 379.6 | 584   | 801.7  | 1046.9 | 1321   | 1624.9 | 1795.8 |
| 7  | 8          | 17.4     | 173.8 | 354.1 | 544.9 | 748.3  | 977.4  | 1232.5 | 1520.4 | 1678.9 |
| 8  | 9          | 16.6     | 166   | 336.8 | 517.1 | 710.4  | 925.7  | 1166.9 | 1441   | 1588.9 |
| 9  | 10         | 16       | 159.3 | 322.8 | 495.7 | 680    | 885.5  | 1114.9 | 1375.3 | 1517.9 |
| 10 | 11         | 15.4     | 153.6 | 311.9 | 477.4 | 655    | 851.8  | 1072.6 | 1322.3 | 1459.6 |
| 11 | 12         | 14.9     | 149.1 | 302.2 | 462.5 | 633.4  | 823.7  | 1036.8 | 1276.9 | 1407.9 |
| 12 | 13         | 14.4     | 144.6 | 293.6 | 449.7 | 615.1  | 798.9  | 1005.6 | 1237.1 | 1363.9 |
| 13 | 14         | 14.1     | 140.3 | 285.1 | 438.1 | 599.1  | 777.4  | 977.7  | 1201.7 | 1324.4 |
| 14 | 15         | 13.6     | 136.9 | 278.7 | 426.6 | 584.4  | 758.3  | 951    | 1169.8 | 1288.2 |
| 15 | 16         | 13.3     | 133.7 | 271.5 | 417.2 | 569.9  | 739.4  | 927.9  | 1139.3 | 1254.4 |
| 16 | 17         | 13       | 130.4 | 265.2 | 407.9 | 557.5  | 722.7  | 906.9  | 1112   | 1223   |
| 17 | 18         | 12.6     | 127.2 | 259.1 | 398.7 | 545.4  | 707.3  | 886.2  | 1086   | 1194   |
| 18 | 19         | 12.3     | 124.1 | 253.9 | 390.5 | 534.3  | 692    | 867.7  | 1061.3 | 1166.1 |
| 19 | 20         | 12       | 120.9 | 247.9 | 382.4 | 522.4  | 677.9  | 848.4  | 1037.8 | 1139.5 |
| 20 | 21         | 11.7     | 117.8 | 242.9 | 374.4 | 512.6  | 663.9  | 830.2  | 1015.5 | 1114.1 |
| 21 | 22         | 11.4     | 115.7 | 237.9 | 367.4 | 503    | 651.1  | 813.2  | 993.3  | 1089.9 |
| 22 | 23         | 11.1     | 112.7 | 232.9 | 359.4 | 492.3  | 638.3  | 797.3  | 972.3  | 1066.8 |
| 23 | 24         | 10.9     | 110.3 | 227.9 | 352.5 | 483.8  | 625.7  | 781.6  | 953.4  | 1044.8 |
| 24 | 25         | 10.6     | 108   | 224   | 346.6 | 474.3  | 614.1  | 766.9  | 932.6  | 1023   |
| 25 | 26         | 10.4     | 105.5 | 219   | 339.6 | 465.9  | 602.6  | 751.3  | 914.9  | 1002.3 |
| 26 | 27         | 10.1     | 103.3 | 215.1 | 333.7 | 456.6  | 591.2  | 737.7  | 896.3  | 981.6  |
| 27 | 28         | 9.9      | 101.1 | 211.2 | 326.8 | 448.3  | 580.8  | 723.3  | 878.8  | 962    |
| 28 | 29         | 9.7      | 98.8  | 206.2 | 320.9 | 441    | 570.4  | 709.9  | 862.3  | 942.5  |
| 29 | 30         | 9.4      | 96.8  | 202.4 | 315   | 432.7  | 561.1  | 696.5  | 845.9  | 924.1  |
| 30 | 31         | 9.2      | 94.8  | 198.5 | 310.1 | 424.5  | 549.9  | 684.2  | 829.6  | 905.7  |
| 31 | 32         | 9        | 92.8  | 194.5 | 304.1 | 417.3  | 540.7  | 672    | 814.3  | 888.4  |
| 32 | 33         | 8.8      | 90.8  | 191.6 | 298.2 | 410.2  | 531.5  | 659.7  | 799    | 871.1  |
| 33 | 34         | 8.6      | 88.9  | 187.7 | 293.3 | 403    | 522.3  | 648.5  | 783.7  | 855.9  |
| 34 | 35         | 8.4      | 87    | 183.8 | 288.4 | 396.9  | 513.1  | 636.3  | 769.5  | 838.6  |
| 35 | 36         | 8.2      | 85.3  | 180.8 | 283.4 | 389.8  | 505    | 626.2  | 755.4  | 823.4  |
| 36 | 37         | 8        | 83.5  | 178   | 278.5 | 383.7  | 495.9  | 615    | 742.2  | 808.3  |
| 37 | 38         | 7.8      | 81.9  | 174   | 273.6 | 376.6  | 486.8  | 603.9  | 729.1  | 793.1  |
| 38 | 39         | 7.7      | 80.1  | 171.1 | 268.6 | 370.5  | 479.7  | 593.8  | 715.9  | 779    |
| 39 | 40         | 7.5      | 78.5  | 168.2 | 264.7 | 364.5  | 471.6  | 583.7  | 703.8  | 764.9  |
| 40 | 41         | 7.3      | 76.9  | 165.2 | 259.6 | 359.4  | 463.5  | 573.6  | 691.7  | 751.8  |
| 41 | 42         | 7.1      | 75.4  | 162.3 | 255.7 | 353.4  | 456.5  | 564.6  | 679.6  | 737.7  |
| 42 | 43         | 7        | 73.9  | 159.3 | 251.7 | 347.3  | 448.4  | 555.5  | 667.6  | 725.6  |
| 43 | 44         | 6.8      | 72.4  | 156.4 | 247.7 | 341.3  | 441.4  | 546.4  | 655.5  | 712.5  |
| 44 | 45         | 6.7      | 71    | 153.3 | 243.7 | 336.3  | 435.3  | 537.4  | 644.4  | 700.5  |
| 45 | 46         | 6.5      | 69.7  | 151.4 | 239.7 | 331.2  | 427.3  | 529.3  | 634.4  | 688.4  |
| 46 | 47         | 6.4      | 68.3  | 148.4 | 235.7 | 326.2  | 420.3  | 520.3  | 623.3  | 677.4  |
| 47 | 48         | 6.3      | 66.9  | 145.5 | 231.6 | 320.2  | 415.2  | 512.3  | 613.3  | 664.3  |
| 48 | 49         | 6.1      | 65.5  | 143.5 | 227.6 | 315.2  | 408.2  | 503.2  | 603.3  | 654.3  |
| 49 | 50         | 6        | 64.3  | 140.5 | 224.5 | 311.1  | 401.2  | 496.2  | 593.2  | 643.3  |
| 50 | 51         | 5.9      | 63    | 138.4 | 220.5 | 306.1  | 396.2  | 488.2  | 584.2  | 632.2  |
| 51 | 52         | 5.7      | 61.8  | 136.1 | 217.4 | 301.1  | 390.1  | 480.2  | 575.2  | 622.2  |
| 52 | 53         | 5.6      | 60.6  | 133.8 | 214.4 | 297.1  | 383.1  | 473.2  | 565.2  | 612.2  |
| 53 | 54         | 5.5      | 59.4  | 131.5 | 210.3 | 292.1  | 378.1  | 466.1  | 556.2  | 602.2  |
| 54 | 55         | 5.4      | 58.3  | 129.3 | 207.2 | 288.1  | 372.1  | 459.1  | 548.1  | 592.2  |
| 55 | 56         | 5.2      | 57.3  | 127.2 | 204.2 | 283.1  | 367.1  | 452.1  | 540.1  | 584.1  |
| 56 | 57         | 5.1      | 56.2  | 125.1 | 201.1 | 279.1  | 362.1  | 446.1  | 530.1  | 574.1  |
| 57 | 58         | 5        | 55.2  | 123.1 | 197.9 | 276.1  | 356.1  | 438.1  | 522.1  | 565.1  |
| 58 | 59         | 4.9      | 54.1  | 121   | 194.8 | 272.1  | 351.1  | 432.1  | 515.1  | 557.1  |
| 59 | 60         | 4.8      | 53.1  | 119.1 | 191.7 | 267.1  | 346.1  | 426.1  | 507.1  | 548.1  |
| 60 | 61         | 4.7      | 52.1  | 117.2 | 189.6 | 264    | 341.1  | 420.1  | 499.1  | 540.1  |
| 61 | 62         | 4.6      | 51.2  | 115.3 | 186.5 | 260    | 336.1  | 413.1  | 492.1  | 531.1  |
|    | 63         | 4.5      | 50.2  | 113.5 | 183.4 | 256    | 332.1  | 408.1  | 485.1  | 523.1  |

PWR DATA TABLES

|     | A          | B        | C    | D     | E     | F     | G     | H     | I     | J     |
|-----|------------|----------|------|-------|-------|-------|-------|-------|-------|-------|
| 1   | Enrichment |          |      |       |       |       |       |       |       |       |
| 2   | 5.5        | GW-d/MTU |      |       |       |       |       |       |       |       |
| 62  | 64         | 4.4      | 49.3 | 111.7 | 181.3 | 253   | 327   | 402.1 | 477.1 | 516.1 |
| 63  | 65         | 4.3      | 48.4 | 110   | 178.2 | 250   | 323   | 397.1 | 471.1 | 508.1 |
| 64  | 66         | 4.2      | 47.5 | 108.3 | 176   | 246   | 318   | 391.1 | 464.1 | 500.1 |
| 65  | 67         | 4.1      | 46.6 | 106.5 | 173.4 | 242   | 314   | 386   | 458.1 | 493.1 |
| 66  | 68         | 4        | 45.8 | 105   | 171   | 239   | 310   | 381   | 451.1 | 486.1 |
| 67  | 69         | 4        | 45   | 103.4 | 168.7 | 236   | 306   | 376   | 445.1 | 480.1 |
| 68  | 70         | 3.9      | 44.2 | 101.8 | 166.3 | 233   | 301   | 371   | 439.1 | 473.1 |
| 69  | 71         | 3.8      | 43.4 | 100.3 | 164   | 230   | 298   | 365   | 433   | 466.1 |
| 70  | 72         | 3.7      | 42.7 | 98.7  | 161.8 | 227   | 294   | 360   | 427   | 460.1 |
| 71  | 73         | 3.6      | 41.9 | 97.3  | 159.6 | 224   | 290   | 356   | 421   | 453   |
| 72  | 74         | 3.6      | 41.2 | 95.9  | 157.5 | 221   | 286   | 351   | 416   | 447   |
| 73  | 75         | 3.5      | 40.5 | 94.5  | 155.3 | 219   | 282   | 346   | 410   | 441   |
| 74  | 76         | 3.4      | 39.8 | 93.1  | 153.3 | 215   | 279   | 342   | 404   | 435   |
| 75  | 77         | 3.4      | 39.2 | 91.8  | 151.4 | 212.8 | 275   | 338   | 399   | 430   |
| 76  | 78         | 3.3      | 38.5 | 90.5  | 149.4 | 210.4 | 273   | 333   | 395   | 424   |
| 77  | 79         | 3.2      | 37.8 | 89.2  | 147.5 | 207.1 | 269   | 329   | 389   | 418   |
| 78  | 80         | 3.2      | 37.1 | 87.9  | 145.6 | 204.9 | 265   | 326   | 385   | 412   |
| 79  | 81         | 3.1      | 36.5 | 86.8  | 143.8 | 202.8 | 263   | 322   | 379   | 408   |
| 80  | 82         | 3        | 36   | 85.5  | 141.9 | 199.6 | 259   | 318   | 375   | 402   |
| 81  | 83         | 3        | 35.4 | 84.4  | 140.2 | 197.6 | 257   | 314   | 371   | 398   |
| 82  | 84         | 2.9      | 34.8 | 83.2  | 138.4 | 195.5 | 253   | 310   | 365   | 393   |
| 83  | 85         | 2.9      | 34.3 | 82.1  | 136.7 | 192.6 | 250.7 | 307   | 361   | 387   |
| 84  | 86         | 2.8      | 33.7 | 81    | 135.1 | 190.6 | 247.4 | 303   | 357   | 383   |
| 85  | 87         | 2.7      | 33.2 | 79.9  | 133.5 | 188.8 | 245.1 | 299   | 352   | 378   |
| 86  | 88         | 2.7      | 32.6 | 78.9  | 131.9 | 186.9 | 241.9 | 296   | 348   | 374   |
| 87  | 89         | 2.6      | 32.1 | 77.9  | 130.3 | 184.1 | 238.7 | 293   | 344   | 369   |
| 88  | 90         | 2.6      | 31.6 | 76.8  | 128.9 | 182.4 | 236.6 | 290   | 341   | 365   |
| 89  | 91         | 2.5      | 31.1 | 75.9  | 127.3 | 180.7 | 233.5 | 286.2 | 336   | 361   |
| 90  | 92         | 2.5      | 30.6 | 74.9  | 125.9 | 178   | 231.5 | 282.9 | 332   | 356   |
| 91  | 93         | 2.4      | 30.2 | 74.1  | 124.5 | 176.4 | 228.5 | 279.6 | 329   | 353   |
| 92  | 94         | 2.4      | 29.8 | 73.1  | 123   | 174.8 | 226.6 | 276.4 | 325   | 348   |
| 93  | 95         | 2.4      | 29.3 | 72.2  | 121.7 | 172.2 | 223.7 | 274.2 | 322   | 344   |
| 94  | 96         | 2.3      | 28.8 | 71.4  | 120.4 | 170.7 | 221.9 | 271.1 | 318.4 | 341   |
| 95  | 97         | 2.3      | 28.4 | 70.5  | 119.1 | 169.3 | 219.1 | 268   | 315.1 | 336   |
| 96  | 98         | 2.2      | 28   | 69.6  | 117.8 | 166.8 | 217.4 | 265   | 310.8 | 333   |
| 97  | 99         | 2.2      | 27.6 | 68.8  | 116.5 | 165.4 | 214.7 | 263   | 307.6 | 329.6 |
| 98  | 100        | 2.1      | 27.2 | 68    | 115.3 | 164   | 213   | 260.1 | 304.4 | 326.3 |
| 99  | 110        | 1.8      | 23.7 | 60.9  | 104.3 | 148.9 | 193.4 | 236.1 | 275.3 | 294.1 |
| 100 | 120        | 1.5      | 20.9 | 55.1  | 95.4  | 136.4 | 176.8 | 215.7 | 251.2 | 268.2 |
| 101 | 130        | 1.3      | 18.7 | 50.4  | 88.1  | 126.4 | 163.8 | 199.2 | 231.3 | 246.7 |
| 102 | 140        | 1.1      | 16.8 | 46.6  | 82.1  | 117.9 | 152.6 | 185.9 | 214.9 | 228.8 |
| 103 | 150        | 1        | 15.4 | 43.5  | 77.1  | 110.8 | 144   | 173.4 | 200.5 | 213   |
| 104 | 160        | 0.9      | 14.3 | 40.9  | 72.9  | 104.9 | 135.5 | 164.2 | 188.7 | 199.9 |
| 105 | 170        | 0.8      | 13.4 | 38.9  | 69.4  | 99.9  | 129   | 155.2 | 178.1 | 189.1 |
| 106 | 180        | 0.7      | 12.6 | 37    | 66.4  | 95.5  | 123.3 | 148   | 169.5 | 179.3 |
| 107 | 190        | 0.7      | 12   | 35.6  | 63.8  | 91.7  | 118.1 | 141.4 | 161.7 | 170.3 |
| 108 | 200        | 0.6      | 11.5 | 34.3  | 61.6  | 88.5  | 113.4 | 135.5 | 154.4 | 162.9 |
| 109 | 250        | 0.5      | 9.9  | 30.1  | 53.8  | 76.6  | 97.4  | 115.3 | 129.6 | 135.7 |
| 110 | 300        | 0.5      | 9.1  | 27.5  | 48.8  | 68.8  | 86.6  | 100.7 | 112.8 | 116.9 |
| 111 | 350        | 0.5      | 8.6  | 25.6  | 44.9  | 63    | 78.5  | 90.9  | 100.3 | 104.3 |
| 112 | 400        | 0.5      | 8.2  | 23.9  | 41.8  | 58.2  | 72.1  | 82.9  | 91    | 94.2  |
| 113 | 450        | 0.5      | 7.9  | 22.6  | 39.1  | 54    | 66.6  | 76.2  | 83.4  | 86.1  |
| 114 | 500        | 0.5      | 7.6  | 21.4  | 36.7  | 50.4  | 62    | 70.7  | 76.9  | 79.3  |
| 115 | 550        | 0.5      | 7.3  | 20.2  | 34.5  | 47.3  | 57.9  | 65.8  | 71.5  | 73.7  |
| 116 | 600        | 0.5      | 7.1  | 19.2  | 32.6  | 44.4  | 54.2  | 61.6  | 66.8  | 68.7  |
| 117 | 650        | 0.5      | 6.8  | 18.3  | 30.8  | 41.9  | 51    | 57.8  | 62.6  | 64.4  |
| 118 | 700        | 0.5      | 6.6  | 17.5  | 29.2  | 39.5  | 48    | 54.4  | 58.9  | 60.6  |
| 119 | 750        | 0.5      | 6.4  | 16.7  | 27.7  | 37.4  | 45.4  | 51.3  | 55.5  | 57.1  |
| 120 | 800        | 0.5      | 6.2  | 16    | 26.3  | 35.4  | 42.9  | 48.5  | 52.5  | 54    |
| 121 | 850        | 0.5      | 6.1  | 15.3  | 25.1  | 33.6  | 40.7  | 45.9  | 49.7  | 51.2  |
| 122 | 900        | 0.5      | 5.9  | 14.7  | 23.9  | 32    | 38.6  | 43.6  | 47.2  | 48.6  |
| 123 | 950        | 0.5      | 5.8  | 14.1  | 22.8  | 30.5  | 36.7  | 41.5  | 44.9  | 46.2  |
| 124 | 1000       | 0.5      | 5.6  | 13.6  | 21.9  | 29.1  | 35    | 39.5  | 42.7  | 44    |

PWR DATA TABLES

|    | A          | B        | C     | D     | E     | F      | G      | H      | I      | J      |
|----|------------|----------|-------|-------|-------|--------|--------|--------|--------|--------|
| 1  | Enrichment |          |       |       |       |        |        |        |        |        |
| 2  | 5.0        | GW-d/MTU |       |       |       |        |        |        |        |        |
| 3  | Year       | 1        | 10    | 20    | 30    | 40     | 50     | 60     | 70     | 75     |
| 4  | 5          | 25.1     | 245.6 | 491.7 | 748.8 | 1023.6 | 1333   | 1672.2 | 2060   | 2267.4 |
| 5  | 6          | 20.9     | 208.1 | 422.4 | 648.4 | 892.4  | 1167.4 | 1479.2 | 1819.7 | 2013.3 |
| 6  | 7          | 18.7     | 187.9 | 381.5 | 587.7 | 811    | 1062.7 | 1346.3 | 1671.7 | 1840.7 |
| 7  | 8          | 17.4     | 174.9 | 355.9 | 548.4 | 755.2  | 990.9  | 1256.5 | 1556.7 | 1721.3 |
| 8  | 9          | 16.6     | 166   | 337.4 | 519.4 | 715.2  | 936.9  | 1187.5 | 1472.8 | 1628   |
| 9  | 10         | 15.9     | 159.2 | 324.3 | 497.8 | 684.6  | 895.5  | 1134.2 | 1405.8 | 1554.5 |
| 10 | 11         | 15.4     | 153.6 | 312.4 | 479.5 | 658.4  | 861.6  | 1090.6 | 1350.5 | 1491.9 |
| 11 | 12         | 15       | 149   | 302.7 | 464.4 | 637.6  | 833.2  | 1052.6 | 1303.9 | 1440   |
| 12 | 13         | 14.5     | 144.6 | 294.1 | 451.5 | 619.1  | 807.2  | 1021.1 | 1261.8 | 1393.7 |
| 13 | 14         | 14.1     | 141.2 | 286.6 | 439.8 | 603.1  | 784.5  | 991.9  | 1225.2 | 1351.9 |
| 14 | 15         | 13.7     | 136.8 | 279.2 | 428.2 | 587.2  | 765.3  | 965.3  | 1191.2 | 1313.6 |
| 15 | 16         | 13.3     | 133.5 | 272.9 | 418.8 | 573.6  | 746.2  | 940.9  | 1159.4 | 1279.7 |
| 16 | 17         | 13       | 130.2 | 266.7 | 409.4 | 560.2  | 729.5  | 918.8  | 1131   | 1246.1 |
| 17 | 18         | 12.7     | 127.1 | 260.5 | 400.1 | 547.9  | 714    | 898    | 1103.9 | 1215.9 |
| 18 | 19         | 12.3     | 123.9 | 254.4 | 392   | 536.8  | 697.6  | 877.4  | 1078.1 | 1186.9 |
| 19 | 20         | 12       | 120.7 | 249.3 | 383.8 | 525.8  | 683.4  | 858    | 1053.5 | 1159.2 |
| 20 | 21         | 11.7     | 118.7 | 244.3 | 375.8 | 515    | 669.4  | 839.8  | 1030.1 | 1132.7 |
| 21 | 22         | 11.5     | 115.6 | 239.3 | 368.7 | 505.3  | 656.5  | 822.7  | 1008.8 | 1107.4 |
| 22 | 23         | 11.1     | 113.5 | 234.3 | 361.7 | 495.6  | 643.7  | 805.7  | 986.8  | 1083.2 |
| 23 | 24         | 10.9     | 110.8 | 229.3 | 354.7 | 486    | 631    | 789.9  | 965.8  | 1060.2 |
| 24 | 25         | 10.6     | 108.4 | 224.5 | 347.7 | 476.6  | 618.4  | 774.2  | 945    | 1037.4 |
| 25 | 26         | 10.4     | 106   | 220.5 | 340.8 | 468.1  | 607.8  | 758.6  | 926.2  | 1015.6 |
| 26 | 27         | 10.1     | 103.6 | 215.5 | 334.9 | 459.7  | 596.4  | 745    | 907.6  | 993.9  |
| 27 | 28         | 9.9      | 101.4 | 211.7 | 328.9 | 451.4  | 585    | 729.5  | 889    | 974.3  |
| 28 | 29         | 9.7      | 99.4  | 207.7 | 323   | 443.1  | 574.6  | 716.1  | 872.5  | 953.8  |
| 29 | 30         | 9.4      | 97.3  | 203.9 | 317.1 | 434.9  | 563.3  | 703.7  | 855.1  | 934.3  |
| 30 | 31         | 9.2      | 95.2  | 200   | 311.1 | 427.6  | 554    | 689.4  | 837.7  | 916.9  |
| 31 | 32         | 9        | 93.3  | 196   | 306.2 | 420.4  | 544.8  | 677.1  | 822.4  | 898.6  |
| 32 | 33         | 8.8      | 91.3  | 193.2 | 300.3 | 413.3  | 534.6  | 664.8  | 806.1  | 880.2  |
| 33 | 34         | 8.6      | 89.5  | 189.2 | 295.3 | 406.1  | 525.4  | 653.6  | 791.9  | 864    |
| 34 | 35         | 8.4      | 87.6  | 185.3 | 290.4 | 399    | 516.2  | 642.4  | 776.6  | 847.7  |
| 35 | 36         | 8.2      | 85.8  | 182.3 | 285.5 | 392.9  | 507.1  | 630.2  | 762.4  | 830.5  |
| 36 | 37         | 8        | 84.1  | 179.5 | 280.5 | 386.8  | 498.9  | 620.1  | 748.3  | 814.4  |
| 37 | 38         | 7.8      | 82.5  | 175.5 | 275.5 | 378.7  | 490.8  | 609    | 734.1  | 800.2  |
| 38 | 39         | 7.7      | 80.8  | 172.6 | 271.5 | 372.6  | 482.7  | 598.9  | 721    | 785    |
| 39 | 40         | 7.5      | 79.1  | 169.7 | 266.6 | 367.5  | 474.6  | 587.8  | 707.9  | 769.9  |
| 40 | 41         | 7.3      | 77.6  | 166.7 | 262.5 | 361.5  | 466.6  | 577.7  | 694.8  | 756.8  |
| 41 | 42         | 7.2      | 76    | 163.8 | 257.6 | 355.4  | 458.5  | 568.6  | 683.7  | 742.7  |
| 42 | 43         | 7        | 74.5  | 160.8 | 253.6 | 349.4  | 451.4  | 558.5  | 670.6  | 729.6  |
| 43 | 44         | 6.8      | 73    | 157.9 | 249.5 | 344.3  | 444.4  | 549.5  | 659.5  | 716.6  |
| 44 | 45         | 6.7      | 71.7  | 154.9 | 245.5 | 338.3  | 437.3  | 539.4  | 648.5  | 703.5  |
| 45 | 46         | 6.6      | 70.3  | 152.9 | 241.5 | 333.2  | 430.3  | 531.4  | 637.4  | 691.4  |
| 46 | 47         | 6.4      | 68.9  | 150   | 237.5 | 328.2  | 423.3  | 522.3  | 626.4  | 679.4  |
| 47 | 48         | 6.3      | 67.6  | 147   | 233.4 | 323.2  | 416.2  | 514.3  | 615.3  | 667.4  |
| 48 | 49         | 6.1      | 66.2  | 145   | 230.4 | 318.2  | 411.2  | 506.3  | 605.3  | 656.3  |
| 49 | 50         | 6        | 64.9  | 143.1 | 226.3 | 314.2  | 404.2  | 498.2  | 595.3  | 645.3  |
| 50 | 51         | 5.9      | 63.8  | 140.2 | 223.3 | 308.1  | 398.2  | 491.2  | 586.2  | 634.3  |
| 51 | 52         | 5.7      | 62.5  | 137.9 | 219.2 | 304.1  | 392.2  | 483.2  | 576.2  | 623.2  |
| 52 | 53         | 5.6      | 61.4  | 135.6 | 216.1 | 300.1  | 385.1  | 475.2  | 566.2  | 613.2  |
| 53 | 54         | 5.5      | 60.2  | 133.4 | 213.1 | 294.1  | 381.1  | 468.1  | 558.2  | 603.2  |
| 54 | 55         | 5.4      | 59.1  | 131.1 | 210   | 290.1  | 375.1  | 460.1  | 549.2  | 593.2  |
| 55 | 56         | 5.3      | 58    | 129   | 206.9 | 286.1  | 369.1  | 454.1  | 540.1  | 584.2  |
| 56 | 57         | 5.1      | 56.9  | 127   | 203.8 | 282.1  | 363.1  | 447.1  | 531.1  | 575.1  |
| 57 | 58         | 5        | 55.8  | 124.9 | 200.7 | 278.1  | 359.1  | 440.1  | 523.1  | 565.1  |
| 58 | 59         | 4.9      | 54.8  | 123   | 197.5 | 274.1  | 353.1  | 434.1  | 516.1  | 556.1  |
| 59 | 60         | 4.8      | 53.8  | 121.1 | 194.4 | 270.1  | 348.1  | 427.1  | 507.1  | 547.1  |
| 60 | 61         | 4.7      | 52.8  | 119.2 | 192.3 | 266.1  | 343.1  | 421.1  | 500.1  | 540.1  |
| 61 | 62         | 4.6      | 51.9  | 117.3 | 189.2 | 263    | 339.1  | 415.1  | 492.1  | 531.1  |
| 62 | 63         | 4.5      | 51    | 115.5 | 186.1 | 258    | 334.1  | 409.1  | 485.1  | 523.1  |
| 63 | 64         | 4.4      | 50    | 113.7 | 183.9 | 255    | 329.1  | 403.1  | 478.1  | 515.1  |

PWR DATA TABLES

|     | A          | B        | C    | D     | E     | F     | G     | H     | I     | J     |
|-----|------------|----------|------|-------|-------|-------|-------|-------|-------|-------|
| 1   | Enrichment |          |      |       |       |       |       |       |       |       |
| 2   | 5.0        | GW-d/MTU |      |       |       |       |       |       |       |       |
| 63  | Year       | 1        | 10   | 20    | 30    | 40    | 50    | 60    | 70    | 75    |
| 64  | 65         | 4.3      | 49.2 | 111.9 | 180.8 | 252   | 325   | 398.1 | 471.1 | 507.1 |
| 65  | 66         | 4.2      | 48.3 | 110.3 | 178.6 | 248   | 320   | 393.1 | 464.1 | 500.1 |
| 66  | 67         | 4.2      | 47.5 | 108.6 | 176.1 | 245   | 316   | 386.1 | 457.1 | 492.1 |
| 67  | 68         | 4.1      | 46.6 | 107   | 173.7 | 242   | 312   | 381   | 451.1 | 485.1 |
| 68  | 69         | 4        | 45.8 | 105.4 | 171.4 | 238   | 308   | 376   | 444.1 | 478.1 |
| 69  | 70         | 3.9      | 45   | 103.8 | 169   | 235   | 303   | 371   | 438.1 | 472.1 |
| 70  | 71         | 3.8      | 44.3 | 102.3 | 166.8 | 233   | 300   | 367   | 433.1 | 465.1 |
| 71  | 72         | 3.7      | 43.5 | 100.8 | 164.5 | 229   | 296   | 362   | 426   | 458.1 |
| 72  | 73         | 3.7      | 42.7 | 99.4  | 162.4 | 226   | 292   | 356   | 420   | 451.1 |
| 73  | 74         | 3.6      | 42   | 97.9  | 160.2 | 224   | 289   | 352   | 414   | 445.1 |
| 74  | 75         | 3.5      | 41.3 | 96.6  | 158.2 | 220   | 285   | 347   | 409   | 439   |
| 75  | 76         | 3.4      | 40.6 | 95.2  | 156.1 | 218   | 281   | 343   | 404   | 433   |
| 76  | 77         | 3.4      | 39.9 | 93.9  | 154.1 | 215.6 | 278   | 339   | 398   | 427   |
| 77  | 78         | 3.3      | 39.3 | 92.6  | 152.1 | 212.3 | 274   | 334   | 393   | 421   |
| 78  | 79         | 3.2      | 38.6 | 91.4  | 150.2 | 210   | 270   | 330   | 388   | 417   |
| 79  | 80         | 3.2      | 38   | 90.1  | 148.4 | 207.8 | 268   | 326   | 383   | 411   |
| 80  | 81         | 3.1      | 37.4 | 88.9  | 146.5 | 204.7 | 264   | 322   | 378   | 405   |
| 81  | 82         | 3.1      | 36.8 | 87.7  | 144.8 | 202.6 | 262   | 318   | 374   | 400   |
| 82  | 83         | 3        | 36.2 | 86.5  | 143   | 200.6 | 258   | 314   | 368   | 396   |
| 83  | 84         | 2.9      | 35.6 | 85.4  | 141.2 | 197.6 | 254.7 | 311   | 364   | 390   |
| 84  | 85         | 2.9      | 35   | 84.3  | 139.6 | 195.6 | 252.4 | 307   | 360   | 385   |
| 85  | 86         | 2.8      | 34.5 | 83.1  | 137.9 | 193.7 | 249.1 | 303   | 355   | 381   |
| 86  | 87         | 2.8      | 34   | 82.1  | 136.3 | 190.9 | 246.8 | 300   | 351   | 376   |
| 87  | 88         | 2.7      | 33.5 | 81    | 134.8 | 189   | 243.6 | 296   | 347   | 371   |
| 88  | 89         | 2.7      | 33   | 80.1  | 133.2 | 187.3 | 240.5 | 293   | 343   | 367   |
| 89  | 90         | 2.6      | 32.5 | 79.1  | 131.6 | 184.6 | 238.4 | 290   | 339   | 362   |
| 90  | 91         | 2.6      | 31.9 | 78    | 130.2 | 182.9 | 235.4 | 286.8 | 335   | 358   |
| 91  | 92         | 2.5      | 31.5 | 77.2  | 128.7 | 181.2 | 233.4 | 283.5 | 331   | 353   |
| 92  | 93         | 2.5      | 31   | 76.2  | 127.3 | 178.6 | 230.5 | 280.2 | 327   | 350   |
| 93  | 94         | 2.4      | 30.6 | 75.2  | 126   | 177   | 228.6 | 277   | 324   | 346   |
| 94  | 95         | 2.4      | 30.1 | 74.4  | 124.6 | 175.5 | 225.7 | 273.9 | 320   | 342   |
| 95  | 96         | 2.3      | 29.7 | 73.5  | 123.2 | 173   | 223.9 | 270.8 | 316.9 | 338   |
| 96  | 97         | 2.3      | 29.3 | 72.6  | 122   | 171.5 | 221.1 | 268.8 | 312.6 | 334   |
| 97  | 98         | 2.2      | 28.8 | 71.8  | 120.6 | 170.1 | 218.4 | 265.8 | 309.3 | 330.3 |
| 98  | 99         | 2.2      | 28.4 | 71    | 119.4 | 167.7 | 216.7 | 262.8 | 306.1 | 327   |
| 99  | 100        | 2.2      | 28   | 70.2  | 118.1 | 166.4 | 214.1 | 259.9 | 303   | 323.8 |
| 100 | 110        | 1.8      | 24.6 | 63    | 107.2 | 151.4 | 194.7 | 236.2 | 274.2 | 291.9 |
| 101 | 120        | 1.5      | 21.7 | 57.2  | 98.2  | 139   | 179.3 | 216   | 250.3 | 265.3 |
| 102 | 130        | 1.3      | 19.5 | 52.5  | 90.9  | 128.6 | 165.3 | 199.7 | 229.6 | 244   |
| 103 | 140        | 1.1      | 17.7 | 48.8  | 84.8  | 120.4 | 154.3 | 185.5 | 213.4 | 226.3 |
| 104 | 150        | 1        | 16.3 | 45.6  | 79.7  | 113.3 | 145.7 | 174   | 199.1 | 210.6 |
| 105 | 160        | 0.9      | 15.1 | 43.1  | 75.5  | 107.3 | 137.3 | 164   | 187.4 | 197.6 |
| 106 | 170        | 0.8      | 14.2 | 40.9  | 72    | 102.3 | 130.9 | 155   | 176.9 | 186.8 |
| 107 | 180        | 0.7      | 13.4 | 39.1  | 68.9  | 97.8  | 124.2 | 147.8 | 168.3 | 177   |
| 108 | 190        | 0.7      | 12.8 | 37.6  | 66.4  | 94    | 119   | 141.3 | 160.5 | 168.1 |
| 109 | 200        | 0.7      | 12.3 | 36.3  | 64.1  | 90.7  | 115.3 | 135.4 | 153.3 | 160.8 |
| 110 | 250        | 0.5      | 10.6 | 31.9  | 56    | 78.6  | 98.5  | 115.3 | 128.6 | 133.7 |
| 111 | 300        | 0.5      | 9.8  | 29.2  | 50.9  | 70.6  | 87.6  | 100.7 | 111.8 | 115.9 |
| 112 | 350        | 0.5      | 9.3  | 27.1  | 46.8  | 64.6  | 79.4  | 90.8  | 99.5  | 103.3 |
| 113 | 400        | 0.5      | 8.8  | 25.4  | 43.5  | 59.6  | 72.9  | 82.8  | 90.1  | 93    |
| 114 | 450        | 0.5      | 8.5  | 23.9  | 40.7  | 55.3  | 67.3  | 76.1  | 82.6  | 85.1  |
| 115 | 500        | 0.5      | 8.1  | 22.6  | 38.2  | 51.7  | 62.6  | 70.6  | 76.2  | 78.4  |
| 116 | 550        | 0.5      | 7.8  | 21.4  | 35.9  | 48.4  | 58.4  | 65.7  | 70.8  | 72.8  |
| 117 | 600        | 0.5      | 7.5  | 20.3  | 33.9  | 45.5  | 54.8  | 61.5  | 66.2  | 68    |
| 118 | 650        | 0.5      | 7.3  | 19.3  | 32    | 42.9  | 51.5  | 57.7  | 62.1  | 63.7  |
| 119 | 700        | 0.5      | 7    | 18.4  | 30.3  | 40.5  | 48.5  | 54.3  | 58.4  | 60    |
| 120 | 750        | 0.5      | 6.8  | 17.6  | 28.8  | 38.3  | 45.8  | 51.3  | 55.1  | 56.6  |
| 121 | 800        | 0.5      | 6.6  | 16.8  | 27.3  | 36.3  | 43.4  | 48.5  | 52.1  | 53.5  |
| 122 | 850        | 0.5      | 6.4  | 16.1  | 26    | 34.4  | 41.1  | 46    | 49.4  | 50.7  |
| 123 | 900        | 0.5      | 6.3  | 15.4  | 24.8  | 32.7  | 39    | 43.6  | 46.9  | 48.2  |
| 124 | 950        | 0.5      | 6.1  | 14.8  | 23.7  | 31.2  | 37.1  | 41.5  | 44.6  | 45.9  |
|     | 1000       | 0.5      | 6    | 14.3  | 22.6  | 29.7  | 35.4  | 39.5  | 42.5  | 43.7  |

PWR DATA TABLES

|    | A          | B        | C     | D     | E     | F      | G      | H      | I      | J      |
|----|------------|----------|-------|-------|-------|--------|--------|--------|--------|--------|
| 1  | Enrichment |          |       |       |       |        |        |        |        |        |
| 2  | 4.5        | GW-d/MTU |       |       |       |        |        |        |        |        |
| 3  | Year       | 1        | 10    | 20    | 30    | 40     | 50     | 60     | 70     | 75     |
| 4  | 5          | 25.2     | 248   | 496.3 | 758.1 | 1040.1 | 1359.3 | 1714.1 | 2120.5 | 2325.8 |
| 5  | 6          | 20.9     | 209.5 | 424.8 | 655.5 | 904.4  | 1191.2 | 1508.5 | 1877.4 | 2069.1 |
| 6  | 7          | 18.8     | 188.2 | 383.8 | 593.4 | 820.7  | 1081   | 1378.1 | 1716.8 | 1893.9 |
| 7  | 8          | 17.5     | 175.1 | 358   | 551.8 | 763.6  | 1006.8 | 1283.8 | 1598.4 | 1771.1 |
| 8  | 9          | 16.7     | 167.2 | 339.6 | 522.7 | 723.2  | 951.4  | 1213.4 | 1510.1 | 1671.2 |
| 9  | 10         | 16       | 160.4 | 325.4 | 500.8 | 690.3  | 908.6  | 1156.7 | 1440.6 | 1594.3 |
| 10 | 11         | 15.5     | 154.7 | 313.4 | 482.4 | 663.9  | 873.5  | 1111.8 | 1383   | 1530.4 |
| 11 | 12         | 15       | 149.2 | 303.6 | 467.1 | 642    | 843.8  | 1072.5 | 1334.1 | 1475.1 |
| 12 | 13         | 14.5     | 144.7 | 294.9 | 453.1 | 623.4  | 817.7  | 1038.7 | 1290.7 | 1426.6 |
| 13 | 14         | 14.1     | 141.3 | 287.4 | 441.2 | 606.1  | 794.8  | 1008.5 | 1251.9 | 1383.5 |
| 14 | 15         | 13.7     | 137.8 | 280   | 430.5 | 591.1  | 773.4  | 981.6  | 1215.6 | 1343   |
| 15 | 16         | 13.4     | 133.5 | 273.7 | 420   | 577.4  | 755.3  | 956    | 1183.7 | 1308   |
| 16 | 17         | 13       | 130.3 | 267.5 | 410.6 | 563.9  | 737.4  | 932.8  | 1153.2 | 1273.2 |
| 17 | 18         | 12.7     | 127.1 | 261.3 | 401.2 | 551.5  | 720.7  | 910.9  | 1124.9 | 1240.9 |
| 18 | 19         | 12.4     | 125   | 255.2 | 393   | 540.4  | 705.3  | 891.2  | 1098.9 | 1210.8 |
| 19 | 20         | 12       | 121.8 | 250   | 384.8 | 528.3  | 690    | 870.7  | 1072.2 | 1181   |
| 20 | 21         | 11.7     | 118.7 | 245.1 | 377.6 | 518.4  | 674.9  | 851.4  | 1047.7 | 1154.4 |
| 21 | 22         | 11.5     | 116.6 | 240   | 370.5 | 507.6  | 661.9  | 833.2  | 1024.4 | 1127   |
| 22 | 23         | 11.2     | 113.5 | 235.1 | 362.5 | 497.9  | 649.1  | 816.2  | 1002.3 | 1101.8 |
| 23 | 24         | 10.9     | 111.2 | 230.1 | 356.4 | 488.3  | 636.3  | 799.3  | 980.2  | 1077.7 |
| 24 | 25         | 10.6     | 108.7 | 226.2 | 349.4 | 479.8  | 624.7  | 783.5  | 959.4  | 1053.7 |
| 25 | 26         | 10.4     | 106.4 | 221.2 | 342.5 | 470.3  | 612.1  | 767.9  | 939.6  | 1030.9 |
| 26 | 27         | 10.1     | 104.2 | 217.3 | 336.4 | 461.9  | 600.6  | 753.3  | 919.9  | 1009.2 |
| 27 | 28         | 9.9      | 102   | 213.4 | 330.5 | 453.6  | 589.2  | 738.7  | 901.3  | 987.6  |
| 28 | 29         | 9.7      | 99.9  | 209.5 | 324.5 | 446.3  | 578.8  | 724.3  | 882.8  | 967    |
| 29 | 30         | 9.4      | 97.8  | 205.6 | 318.6 | 438    | 568.4  | 709.9  | 865.3  | 947.5  |
| 30 | 31         | 9.2      | 95.8  | 201.7 | 313.6 | 430.7  | 558.1  | 696.5  | 847.9  | 928.1  |
| 31 | 32         | 9        | 93.8  | 197.8 | 307.7 | 423.5  | 547.9  | 683.2  | 830.6  | 908.7  |
| 32 | 33         | 8.8      | 92    | 193.9 | 302.7 | 415.3  | 538.7  | 672    | 814.3  | 890.4  |
| 33 | 34         | 8.6      | 90    | 191   | 297.8 | 408.2  | 529.5  | 658.7  | 799    | 872.1  |
| 34 | 35         | 8.4      | 88.3  | 187.1 | 291.8 | 402    | 520.3  | 646.5  | 783.7  | 854.8  |
| 35 | 36         | 8.2      | 86.4  | 184.2 | 287.8 | 394.9  | 510.1  | 635.3  | 768.5  | 838.6  |
| 36 | 37         | 8        | 84.8  | 180.2 | 282.8 | 387.8  | 502    | 623.2  | 755.4  | 822.4  |
| 37 | 38         | 7.9      | 83.1  | 177.4 | 277.8 | 381.7  | 492.9  | 613    | 740.2  | 806.3  |
| 38 | 39         | 7.7      | 81.5  | 174.4 | 272.9 | 375.6  | 484.8  | 602.9  | 727    | 792.1  |
| 39 | 40         | 7.5      | 79.8  | 171.5 | 268.8 | 369.6  | 476.7  | 591.8  | 713.9  | 776    |
| 40 | 41         | 7.3      | 78.2  | 168.6 | 263.9 | 363.5  | 469.6  | 581.7  | 700.8  | 761.9  |
| 41 | 42         | 7.2      | 76.8  | 165.6 | 259.8 | 357.4  | 461.5  | 571.6  | 687.7  | 747.8  |
| 42 | 43         | 7        | 75.3  | 162.7 | 255.8 | 352.4  | 454.5  | 562.6  | 675.6  | 733.7  |
| 43 | 44         | 6.9      | 73.8  | 159.7 | 251.8 | 346.3  | 446.4  | 551.5  | 663.6  | 720.6  |
| 44 | 45         | 6.7      | 72.5  | 156.8 | 247.7 | 340.3  | 439.4  | 542.4  | 651.5  | 707.5  |
| 45 | 46         | 6.6      | 71.1  | 154.8 | 243.7 | 336.3  | 432.3  | 533.4  | 640.4  | 695.5  |
| 46 | 47         | 6.4      | 69.7  | 151.8 | 239.7 | 331.2  | 425.3  | 525.3  | 628.4  | 682.4  |
| 47 | 48         | 6.3      | 68.4  | 149.9 | 236.6 | 325.2  | 419.3  | 516.3  | 618.4  | 670.4  |
| 48 | 49         | 6.1      | 67    | 146.9 | 232.5 | 320.2  | 412.2  | 508.3  | 608.3  | 658.3  |
| 49 | 50         | 6        | 65.8  | 144.5 | 229.4 | 315.2  | 407.2  | 500.2  | 598.3  | 647.3  |
| 50 | 51         | 5.9      | 64.6  | 142.1 | 225.3 | 311.1  | 400.2  | 492.2  | 587.3  | 636.3  |
| 51 | 52         | 5.7      | 63.4  | 139.9 | 222.3 | 306.1  | 394.2  | 484.2  | 577.2  | 625.2  |
| 52 | 53         | 5.6      | 62.2  | 137.7 | 219.2 | 301.1  | 388.1  | 476.2  | 567.2  | 614.2  |
| 53 | 54         | 5.5      | 61    | 135.5 | 215.1 | 297.1  | 382.1  | 469.2  | 559.2  | 604.2  |
| 54 | 55         | 5.4      | 59.9  | 133.2 | 212   | 293.1  | 377.1  | 462.1  | 550.2  | 593.2  |
| 55 | 56         | 5.3      | 58.8  | 131.1 | 208.9 | 288.1  | 371.1  | 455.1  | 541.2  | 584.2  |
| 56 | 57         | 5.2      | 57.7  | 129.1 | 205.8 | 284.1  | 365.1  | 448.1  | 532.1  | 575.1  |
| 57 | 58         | 5        | 56.7  | 127   | 203.7 | 281.1  | 360.1  | 441.1  | 524.1  | 565.1  |
| 58 | 59         | 4.9      | 55.7  | 125   | 200.5 | 276.1  | 356.1  | 434.1  | 515.1  | 556.1  |
| 59 | 60         | 4.8      | 54.7  | 123.1 | 197.3 | 273.1  | 350.1  | 429.1  | 508.1  | 547.1  |
| 60 | 61         | 4.7      | 53.7  | 121.3 | 194.2 | 268.1  | 345.1  | 422.1  | 500.1  | 538.1  |
| 61 | 62         | 4.6      | 52.8  | 119.5 | 192.1 | 265.1  | 340.1  | 416.1  | 492.1  | 530.1  |
| 62 | 63         | 4.5      | 51.8  | 117.6 | 188.9 | 262    | 335.1  | 410.1  | 484.1  | 521.1  |
| 63 | 64         | 4.4      | 50.9  | 115.9 | 186.8 | 257    | 330.1  | 404.1  | 477.1  | 513.1  |
| 64 | 65         | 4.3      | 50.1  | 114.2 | 183.7 | 254    | 327.1  | 398.1  | 470.1  | 506.1  |
| 65 | 66         | 4.3      | 49.2  | 112.4 | 181.3 | 251    | 322    | 393.1  | 464.1  | 498.1  |
| 66 | 67         | 4.2      | 48.3  | 110.8 | 178.9 | 247    | 317    | 387.1  | 456.1  | 491.1  |
| 67 | 68         | 4.1      | 47.5  | 109.2 | 176.4 | 244    | 313    | 381.1  | 449.1  | 483.1  |
| 68 | 69         | 4        | 46.7  | 107.6 | 174.1 | 241    | 309    | 377.1  | 443.1  | 476.1  |

PWR DATA TABLES

|     | A          | B        | C    | D     | E     | F     | G     | H     | I     | J     |
|-----|------------|----------|------|-------|-------|-------|-------|-------|-------|-------|
| 1   | Enrichment |          |      |       |       |       |       |       |       |       |
| 2   | 4.5        | GW-d/MTU |      |       |       |       |       |       |       |       |
| 68  | Year       | 1        | 10   | 20    | 30    | 40    | 50    | 60    | 70    | 75    |
| 69  | 70         | 3.9      | 45.9 | 106.1 | 171.8 | 238   | 305   | 372   | 437.1 | 469.1 |
| 70  | 71         | 3.8      | 45.2 | 104.6 | 169.5 | 235   | 301   | 366   | 430.1 | 463.1 |
| 71  | 72         | 3.8      | 44.4 | 103.2 | 167.3 | 231   | 297   | 361   | 424.1 | 455.1 |
| 72  | 73         | 3.7      | 43.7 | 101.7 | 165.1 | 229   | 294   | 357   | 419.1 | 449.1 |
| 73  | 74         | 3.6      | 43   | 100.2 | 163.1 | 226   | 290   | 352   | 413   | 443.1 |
| 74  | 75         | 3.5      | 42.2 | 98.9  | 161   | 223   | 286   | 348   | 408   | 437.1 |
| 75  | 76         | 3.5      | 41.5 | 97.5  | 158.9 | 220.6 | 283   | 342   | 402   | 431.1 |
| 76  | 77         | 3.4      | 40.9 | 96.2  | 156.9 | 217.3 | 279   | 338   | 396   | 425   |
| 77  | 78         | 3.3      | 40.2 | 94.9  | 155   | 215   | 275   | 334   | 392   | 418   |
| 78  | 79         | 3.3      | 39.6 | 93.7  | 153.1 | 212.8 | 272   | 330   | 386   | 413   |
| 79  | 80         | 3.2      | 39   | 92.4  | 151.2 | 209.6 | 269   | 326   | 381   | 408   |
| 80  | 81         | 3.1      | 38.4 | 91.2  | 149.4 | 207.5 | 265   | 322   | 376   | 403   |
| 81  | 82         | 3.1      | 37.8 | 90.1  | 147.6 | 205.4 | 262   | 318   | 371   | 397   |
| 82  | 83         | 3        | 37.2 | 88.9  | 145.8 | 202.4 | 260   | 314   | 367   | 392   |
| 83  | 84         | 2.9      | 36.6 | 87.7  | 144.1 | 200.4 | 256.2 | 311   | 362   | 387   |
| 84  | 85         | 2.9      | 36   | 86.7  | 142.5 | 198.5 | 253.9 | 307   | 358   | 382   |
| 85  | 86         | 2.8      | 35.5 | 85.5  | 140.8 | 195.6 | 250.6 | 303   | 353   | 377   |
| 86  | 87         | 2.8      | 35   | 84.5  | 139.2 | 193.8 | 247.4 | 300   | 349   | 372   |
| 87  | 88         | 2.7      | 34.5 | 83.5  | 137.6 | 191   | 245.3 | 296   | 344   | 368   |
| 88  | 89         | 2.7      | 34   | 82.4  | 136   | 189.3 | 242.2 | 293   | 341   | 364   |
| 89  | 90         | 2.6      | 33.5 | 81.4  | 134.6 | 187.6 | 239.1 | 289.5 | 337   | 359   |
| 90  | 91         | 2.6      | 32.9 | 80.4  | 133.1 | 184.9 | 237.1 | 286.2 | 332   | 354   |
| 91  | 92         | 2.5      | 32.4 | 79.5  | 131.6 | 183.3 | 234.1 | 282.9 | 329   | 350   |
| 92  | 93         | 2.5      | 32   | 78.6  | 130.2 | 181.7 | 232.2 | 279.7 | 325   | 346   |
| 93  | 94         | 2.4      | 31.6 | 77.6  | 128.8 | 179.2 | 229.4 | 276.5 | 321   | 342   |
| 94  | 95         | 2.4      | 31.1 | 76.8  | 127.5 | 177.6 | 226.5 | 273.4 | 317.5 | 338   |
| 95  | 96         | 2.3      | 30.7 | 75.9  | 126.2 | 176.2 | 224.8 | 270.4 | 314.2 | 334   |
| 96  | 97         | 2.3      | 30.2 | 75    | 124.8 | 173.7 | 222   | 268.4 | 310.9 | 330.9 |
| 97  | 98         | 2.3      | 29.8 | 74.2  | 123.5 | 172.3 | 220.3 | 265.4 | 306.7 | 326.6 |
| 98  | 99         | 2.2      | 29.4 | 73.4  | 122.3 | 170.9 | 217.7 | 262.5 | 303.5 | 323.3 |
| 99  | 100        | 2.2      | 29   | 72.6  | 121.1 | 168.6 | 216.1 | 259.6 | 300.4 | 320.1 |
| 100 | 101        | 1.8      | 25.5 | 65.4  | 110.1 | 153.8 | 195.9 | 235.2 | 270.9 | 287.6 |
| 101 | 102        | 1.5      | 22.8 | 59.7  | 101.1 | 141.5 | 180.7 | 215.2 | 247.4 | 262.3 |
| 102 | 103        | 1.3      | 20.5 | 55    | 93.7  | 131.2 | 166.8 | 199   | 227.9 | 240.2 |
| 103 | 104        | 1.2      | 18.7 | 51.1  | 87.6  | 122.5 | 155.9 | 185   | 210.8 | 222.6 |
| 104 | 105        | 1        | 17.3 | 47.9  | 82.6  | 115.6 | 146.4 | 173.7 | 196.7 | 207.1 |
| 105 | 106        | 0.9      | 16.1 | 45.4  | 78.3  | 109.6 | 138.1 | 163.7 | 185   | 194.2 |
| 106 | 107        | 0.8      | 15.2 | 43.2  | 74.7  | 104.4 | 131.7 | 154.7 | 174.6 | 183.5 |
| 107 | 108        | 0.8      | 14.3 | 41.4  | 71.7  | 100   | 126   | 147.6 | 166.1 | 173.8 |
| 108 | 109        | 0.7      | 13.7 | 39.8  | 69    | 96.2  | 120.9 | 141.2 | 158.3 | 165.9 |
| 109 | 110        | 0.7      | 13.2 | 38.5  | 66.7  | 92.8  | 116.3 | 135.2 | 151.2 | 158.6 |
| 110 | 111        | 0.6      | 11.5 | 33.9  | 58.4  | 80.4  | 99.3  | 114.2 | 126.5 | 131.7 |
| 111 | 112        | 0.5      | 10.6 | 31    | 53    | 72.3  | 88.3  | 100.6 | 109.8 | 113.8 |
| 112 | 113        | 0.5      | 10   | 28.9  | 48.8  | 66.1  | 80    | 90.4  | 98.3  | 101.3 |
| 113 | 114        | 0.5      | 9.6  | 27    | 45.3  | 61    | 73.4  | 82.5  | 89.1  | 91.7  |
| 114 | 115        | 0.5      | 9.1  | 25.4  | 42.4  | 56.6  | 67.8  | 75.8  | 81.7  | 83.9  |
| 115 | 116        | 0.5      | 8.8  | 24    | 39.7  | 52.8  | 63    | 70.3  | 75.4  | 77.4  |
| 116 | 117        | 0.5      | 8.4  | 22.7  | 37.4  | 49.5  | 58.9  | 65.5  | 70.1  | 71.9  |
| 117 | 118        | 0.5      | 8.1  | 21.6  | 35.2  | 46.5  | 55.2  | 61.3  | 65.5  | 67.2  |
| 118 | 119        | 0.5      | 7.8  | 20.5  | 33.3  | 43.8  | 51.9  | 57.5  | 61.5  | 63    |
| 119 | 120        | 0.5      | 7.5  | 19.5  | 31.5  | 41.3  | 48.9  | 54.2  | 57.9  | 59.3  |
| 120 | 121        | 0.5      | 7.3  | 18.6  | 29.9  | 39.1  | 46.2  | 51.1  | 54.6  | 56    |
| 121 | 122        | 0.5      | 7.1  | 17.8  | 28.4  | 37    | 43.7  | 48.4  | 51.7  | 53    |
| 122 | 123        | 0.5      | 6.9  | 17    | 27    | 35.2  | 41.4  | 45.9  | 49    | 50.3  |
| 123 | 124        | 0.5      | 6.7  | 16.3  | 25.7  | 33.4  | 39.3  | 43.6  | 46.6  | 47.8  |
|     |            | 0.5      | 6.5  | 15.6  | 24.5  | 31.8  | 37.4  | 41.4  | 44.4  | 45.5  |
|     |            | 0.5      | 6.3  | 15    | 23.5  | 30.3  | 35.7  | 39.5  | 42.3  | 43.4  |



PWR DATA TABLES

|    | A          | B        | C     | D     | E     | F      | G      | H      | I      | J      |
|----|------------|----------|-------|-------|-------|--------|--------|--------|--------|--------|
| 1  | Enrichment |          |       |       |       |        |        |        |        |        |
| 2  | 4.0        | GW-d/MTU |       |       |       |        |        |        |        |        |
| 3  | Year       | 1        | 10    | 20    | 30    | 40     | 50     | 60     | 70     | 75     |
| 4  | 5          | 25.4     | 249.8 | 502.6 | 770.1 | 1061.2 | 1391.2 | 1763.8 | 2179.3 | 2404.7 |
| 5  | 6          | 21.1     | 211.2 | 428.9 | 664   | 920.1  | 1217.5 | 1556.4 | 1932.6 | 2133.3 |
| 6  | 7          | 18.9     | 189.8 | 386.7 | 599.5 | 832.8  | 1104.9 | 1415.4 | 1769.4 | 1955.4 |
| 7  | 8          | 17.6     | 176.7 | 359.9 | 556.6 | 773.4  | 1026.1 | 1317.6 | 1645.3 | 1819   |
| 8  | 9          | 16.7     | 167.7 | 341.3 | 527.2 | 731.6  | 969.3  | 1242.7 | 1554.5 | 1722.7 |
| 9  | 10         | 16.1     | 160.8 | 326.1 | 503   | 697.5  | 924.2  | 1184.6 | 1481.7 | 1641.5 |
| 10 | 11         | 15.5     | 155.1 | 314.9 | 484.4 | 670.8  | 887.8  | 1136.3 | 1420.6 | 1574.1 |
| 11 | 12         | 15       | 149.4 | 305   | 469   | 648.7  | 857.9  | 1096.8 | 1369.4 | 1516.5 |
| 12 | 13         | 14.6     | 146   | 296.3 | 455.7 | 628.8  | 830.3  | 1060.7 | 1323.7 | 1465.6 |
| 13 | 14         | 14.1     | 141.5 | 287.8 | 442.7 | 611.4  | 806.3  | 1030.1 | 1282.7 | 1419.3 |
| 14 | 15         | 13.8     | 138.1 | 281.3 | 431.9 | 595.2  | 784.8  | 1000.1 | 1246.1 | 1378.6 |
| 15 | 16         | 13.4     | 134.8 | 273.9 | 422.1 | 581.4  | 764.4  | 974.3  | 1212.1 | 1339.4 |
| 16 | 17         | 13.1     | 131.6 | 267.6 | 412.6 | 567.7  | 746.4  | 949.9  | 1179.3 | 1303.5 |
| 17 | 18         | 12.7     | 128.4 | 261.5 | 403.2 | 555.3  | 729.6  | 926.9  | 1149.9 | 1269.9 |
| 18 | 19         | 12.4     | 125.1 | 256.3 | 394.8 | 543    | 713.1  | 906    | 1121.9 | 1237.8 |
| 19 | 20         | 12.1     | 122   | 251.2 | 386.4 | 531.9  | 697.7  | 884.4  | 1095   | 1206.8 |
| 20 | 21         | 11.7     | 119   | 246.2 | 379.2 | 521.9  | 683.5  | 866    | 1068.4 | 1178.1 |
| 21 | 22         | 11.4     | 116.8 | 241.2 | 372.1 | 511.1  | 669.5  | 845.8  | 1044   | 1149.6 |
| 22 | 23         | 11.2     | 114.1 | 236.2 | 364.9 | 501.3  | 655.6  | 828.7  | 1020.8 | 1123.3 |
| 23 | 24         | 10.9     | 111.8 | 231.2 | 357.8 | 491.7  | 642.8  | 810.8  | 997.7  | 1097.2 |
| 24 | 25         | 10.7     | 109.4 | 227.3 | 350.7 | 482.1  | 630    | 794.9  | 976.8  | 1072.2 |
| 25 | 26         | 10.4     | 107.1 | 222.4 | 344.7 | 473.6  | 617.4  | 778.2  | 955    | 1049.3 |
| 26 | 27         | 10.2     | 104.8 | 218.5 | 338.7 | 465.2  | 605.9  | 762.6  | 934.2  | 1025.5 |
| 27 | 28         | 9.9      | 102.6 | 214.5 | 332.6 | 456.8  | 594.4  | 747    | 914.6  | 1002.9 |
| 28 | 29         | 9.7      | 100.6 | 210.7 | 326.7 | 447.4  | 584    | 732.5  | 896    | 982.3  |
| 29 | 30         | 9.5      | 98.5  | 206.8 | 320.6 | 440.1  | 572.6  | 718.1  | 876.5  | 960.7  |
| 30 | 31         | 9.2      | 96.5  | 202.9 | 315.6 | 432.9  | 562.3  | 704.7  | 859.1  | 940.3  |
| 31 | 32         | 9        | 94.4  | 199   | 309.7 | 425.7  | 552    | 690.4  | 841.7  | 920.9  |
| 32 | 33         | 8.8      | 92.6  | 196.1 | 304.6 | 417.5  | 542.8  | 678.1  | 824.4  | 901.5  |
| 33 | 34         | 8.6      | 90.8  | 192.2 | 299.7 | 411.3  | 532.6  | 665.8  | 808.1  | 883.2  |
| 34 | 35         | 8.4      | 88.9  | 189.3 | 294.7 | 404.1  | 523.4  | 652.6  | 791.9  | 865    |
| 35 | 36         | 8.2      | 87.3  | 185.4 | 289.7 | 397    | 515.2  | 640.4  | 776.6  | 847.7  |
| 36 | 37         | 8        | 85.4  | 182.5 | 284.6 | 390.9  | 505.1  | 628.3  | 761.4  | 830.5  |
| 37 | 38         | 7.9      | 83.9  | 179.5 | 279.6 | 384.8  | 496.9  | 618.1  | 747.3  | 814.3  |
| 38 | 39         | 7.7      | 82.2  | 175.7 | 275.6 | 377.7  | 488.8  | 607    | 733.1  | 799.2  |
| 39 | 40         | 7.5      | 80.7  | 172.7 | 270.6 | 371.6  | 479.7  | 595.9  | 719    | 783    |
| 40 | 41         | 7.4      | 79    | 169.8 | 266.5 | 365.5  | 472.6  | 584.8  | 705.9  | 767.9  |
| 41 | 42         | 7.2      | 77.6  | 166.8 | 262.5 | 359.5  | 464.6  | 575.7  | 692.8  | 752.8  |
| 42 | 43         | 7        | 76.1  | 164.9 | 258.4 | 354.4  | 457.5  | 565.6  | 679.7  | 738.7  |
| 43 | 44         | 6.9      | 74.7  | 161.9 | 254.4 | 348.4  | 449.4  | 555.5  | 667.6  | 724.6  |
| 44 | 45         | 6.7      | 73.3  | 159   | 250.2 | 343.3  | 442.4  | 546.5  | 655.5  | 711.6  |
| 45 | 46         | 6.6      | 71.9  | 156   | 246.2 | 337.3  | 435.4  | 537.4  | 642.5  | 698.5  |
| 46 | 47         | 6.4      | 70.6  | 154   | 242.1 | 332.3  | 428.3  | 527.4  | 632.4  | 685.4  |
| 47 | 48         | 6.3      | 69.3  | 151.1 | 239.1 | 327.2  | 421.3  | 519.3  | 621.4  | 672.4  |
| 48 | 49         | 6.2      | 68.1  | 149.1 | 235   | 322.2  | 415.2  | 510.3  | 610.3  | 660.4  |
| 49 | 50         | 6        | 66.7  | 146.6 | 231.8 | 318.2  | 409.2  | 502.3  | 599.3  | 649.3  |
| 50 | 51         | 5.9      | 65.5  | 144.3 | 227.7 | 313.2  | 401.2  | 493.2  | 589.3  | 637.3  |
| 51 | 52         | 5.8      | 64.3  | 142.1 | 224.6 | 308.1  | 395.2  | 486.2  | 578.2  | 626.3  |
| 52 | 53         | 5.6      | 63.1  | 139.9 | 221.5 | 303.1  | 389.2  | 478.2  | 569.2  | 615.2  |
| 53 | 54         | 5.5      | 62    | 137.7 | 218.4 | 299.1  | 384.1  | 470.2  | 560.2  | 604.2  |
| 54 | 55         | 5.4      | 60.9  | 135.6 | 215.3 | 294.1  | 378.1  | 463.2  | 550.2  | 594.2  |
| 55 | 56         | 5.3      | 59.8  | 133.4 | 212.2 | 291.1  | 372.1  | 456.1  | 541.2  | 584.2  |
| 56 | 57         | 5.2      | 58.8  | 131.4 | 209   | 287.1  | 367.1  | 448.1  | 532.1  | 574.2  |
| 57 | 58         | 5.1      | 57.8  | 129.3 | 205.9 | 282.1  | 362.1  | 442.1  | 523.1  | 565.1  |
| 58 | 59         | 5        | 56.8  | 127.4 | 202.8 | 279.1  | 356.1  | 435.1  | 515.1  | 555.1  |
| 59 | 60         | 4.9      | 55.8  | 125.5 | 199.5 | 274.1  | 351.1  | 429.1  | 507.1  | 546.1  |
| 60 | 61         | 4.8      | 54.8  | 123.6 | 197.4 | 271.1  | 346.1  | 422.1  | 499.1  | 537.1  |
| 61 | 62         | 4.7      | 53.9  | 121.7 | 194.2 | 267.1  | 341.1  | 416.1  | 491.1  | 528.1  |
| 62 | 63         | 4.6      | 53    | 120   | 192.1 | 263.1  | 336.1  | 410.1  | 483.1  | 520.1  |
|    | 64         | 4.5      | 52.1  | 118.3 | 188.9 | 260    | 332.1  | 404.1  | 476.1  | 512.1  |

PWR DATA TABLES

|     | A          | B        | C    | D     | E     | F     | G     | H     | I     | J     |
|-----|------------|----------|------|-------|-------|-------|-------|-------|-------|-------|
| 1   | Enrichment |          |      |       |       |       |       |       |       |       |
| 2   | 4.0        | GW-d/MTU |      |       |       |       |       |       |       |       |
| 3   | Year       | 1        | 10   | 20    | 30    | 40    | 50    | 60    | 70    | 75    |
| 63  | 65         | 4.4      | 51.2 | 116.5 | 186.5 | 256   | 328.1 | 398.1 | 468.1 | 504.1 |
| 64  | 66         | 4.3      | 50.3 | 114.9 | 184.1 | 253   | 323.1 | 392.1 | 462.1 | 496.1 |
| 65  | 67         | 4.2      | 49.4 | 113.3 | 181.6 | 249   | 319.1 | 387.1 | 455.1 | 488.1 |
| 66  | 68         | 4.1      | 48.6 | 111.7 | 179.2 | 246   | 314   | 381.1 | 448.1 | 480.1 |
| 67  | 69         | 4        | 47.8 | 110.1 | 176.9 | 243   | 310   | 376.1 | 441.1 | 474.1 |
| 68  | 70         | 3.9      | 47   | 108.6 | 174.6 | 240   | 306   | 371.1 | 435.1 | 466.1 |
| 69  | 71         | 3.9      | 46.3 | 107.1 | 172.3 | 237   | 302   | 366.1 | 429.1 | 459.1 |
| 70  | 72         | 3.8      | 45.5 | 105.6 | 170.1 | 234   | 298   | 361   | 423.1 | 453.1 |
| 71  | 73         | 3.7      | 44.8 | 104.1 | 168   | 231   | 294   | 356   | 417.1 | 446.1 |
| 72  | 74         | 3.6      | 44.1 | 102.8 | 165.9 | 228   | 290   | 351   | 411.1 | 440.1 |
| 73  | 75         | 3.5      | 43.4 | 101.4 | 163.8 | 225.3 | 287   | 347   | 405.1 | 434.1 |
| 74  | 76         | 3.5      | 42.7 | 100.1 | 161.7 | 223   | 284   | 342   | 400.1 | 427.1 |
| 75  | 77         | 3.4      | 42.1 | 98.8  | 159.7 | 219.7 | 280   | 338   | 394   | 421.1 |
| 76  | 78         | 3.3      | 41.3 | 97.4  | 157.8 | 217.4 | 276   | 334   | 389   | 415.1 |
| 77  | 79         | 3.3      | 40.7 | 96.3  | 155.9 | 214.3 | 273   | 330   | 383   | 410.1 |
| 78  | 80         | 3.2      | 40.1 | 95    | 154.1 | 212.1 | 270   | 325   | 378   | 404   |
| 79  | 81         | 3.1      | 39.5 | 93.8  | 152.3 | 210.1 | 267   | 321   | 374   | 399   |
| 80  | 82         | 3.1      | 38.9 | 92.7  | 150.5 | 207   | 263   | 317   | 369   | 394   |
| 81  | 83         | 3        | 38.4 | 91.5  | 148.7 | 205   | 259.8 | 313   | 363   | 388   |
| 82  | 84         | 3        | 37.8 | 90.3  | 147   | 202.1 | 257.4 | 309   | 359   | 383   |
| 83  | 85         | 2.9      | 37.3 | 89.2  | 145.4 | 200.2 | 254.2 | 306   | 354   | 378   |
| 84  | 86         | 2.9      | 36.6 | 88.2  | 143.7 | 198.4 | 250.9 | 302   | 350   | 373   |
| 85  | 87         | 2.8      | 36.1 | 87.1  | 142.1 | 195.6 | 248.8 | 299   | 346   | 368   |
| 86  | 88         | 2.7      | 35.6 | 86    | 140.5 | 193.8 | 245.7 | 295   | 341   | 363   |
| 87  | 89         | 2.7      | 35.1 | 85    | 139   | 191.1 | 242.6 | 291.9 | 337   | 359   |
| 88  | 90         | 2.6      | 34.6 | 84.1  | 137.5 | 189.4 | 240.6 | 287.6 | 333   | 355   |
| 89  | 91         | 2.6      | 34.2 | 83.1  | 136.1 | 187.8 | 237.6 | 284.3 | 329   | 350   |
| 90  | 92         | 2.5      | 33.6 | 82.1  | 134.6 | 185.2 | 234.7 | 282.1 | 326   | 346   |
| 91  | 93         | 2.5      | 33.2 | 81.2  | 133.2 | 183.6 | 232.8 | 278.9 | 321   | 342   |
| 92  | 94         | 2.4      | 32.7 | 80.4  | 131.8 | 182.1 | 230   | 275.8 | 317.9 | 338   |
| 93  | 95         | 2.4      | 32.3 | 79.4  | 130.4 | 179.6 | 227.2 | 272.8 | 314.6 | 334   |
| 94  | 96         | 2.4      | 31.9 | 78.6  | 129.1 | 178.2 | 225.4 | 269.7 | 310.3 | 330.3 |
| 95  | 97         | 2.3      | 31.5 | 77.7  | 127.8 | 175.8 | 222.7 | 266.8 | 307.1 | 326   |
| 96  | 98         | 2.3      | 31   | 76.8  | 126.5 | 174.4 | 221.1 | 263.8 | 303.9 | 322.7 |
| 97  | 99         | 2.2      | 30.6 | 76.1  | 125.3 | 173   | 218.5 | 261   | 299.8 | 318.5 |
| 98  | 100        | 2.2      | 30.2 | 75.3  | 124   | 170.7 | 215.9 | 258.1 | 296.7 | 315.3 |
| 99  | 110        | 1.8      | 26.7 | 68.1  | 113   | 156.1 | 196.9 | 234   | 267.6 | 283.2 |
| 100 | 120        | 1.6      | 23.9 | 62.4  | 104.1 | 144   | 180.9 | 214.3 | 243.3 | 257.2 |
| 101 | 130        | 1.4      | 21.7 | 57.7  | 96.8  | 133.8 | 167.3 | 197.3 | 224.1 | 236.3 |
| 102 | 140        | 1.2      | 19.9 | 53.8  | 90.6  | 125.1 | 156.5 | 183.4 | 207.2 | 218   |
| 103 | 150        | 1        | 18.4 | 50.6  | 85.5  | 117.7 | 147.1 | 172.2 | 194.2 | 203.6 |
| 104 | 160        | 0.9      | 17.2 | 47.9  | 81.2  | 111.6 | 138.8 | 162.3 | 181.7 | 190.8 |
| 105 | 170        | 0.9      | 16.2 | 45.7  | 77.6  | 106.5 | 132.5 | 153.5 | 172.3 | 180.2 |
| 106 | 180        | 0.8      | 15.5 | 43.8  | 74.4  | 102   | 125.9 | 146.4 | 163.9 | 170.6 |
| 107 | 190        | 0.7      | 14.8 | 42.3  | 71.7  | 98.1  | 120.8 | 140   | 156.2 | 162.7 |
| 108 | 200        | 0.7      | 14.3 | 41    | 69.4  | 94.7  | 116.1 | 134.1 | 149   | 155.5 |
| 109 | 250        | 0.6      | 12.5 | 36.1  | 60.8  | 82.1  | 99.8  | 113.2 | 124.5 | 129.6 |
| 110 | 300        | 0.6      | 11.6 | 33.1  | 55.2  | 73.8  | 88.7  | 99.9  | 108.8 | 111.8 |
| 111 | 350        | 0.5      | 10.9 | 30.8  | 50.8  | 67.4  | 80.3  | 89.8  | 97    | 99.8  |
| 112 | 400        | 0.5      | 10.4 | 28.8  | 47.2  | 62.2  | 73.7  | 81.9  | 87.9  | 90.3  |
| 113 | 450        | 0.5      | 9.9  | 27.1  | 44.1  | 57.7  | 68.1  | 75.3  | 80.7  | 82.8  |
| 114 | 500        | 0.5      | 9.5  | 25.6  | 41.3  | 53.9  | 63.3  | 69.8  | 74.5  | 76.4  |
| 115 | 550        | 0.5      | 9.1  | 24.2  | 38.9  | 50.5  | 59.1  | 65.1  | 69.3  | 71    |
| 116 | 600        | 0.5      | 8.8  | 22.9  | 36.6  | 47.4  | 55.4  | 60.9  | 64.8  | 66.4  |
| 117 | 650        | 0.5      | 8.4  | 21.7  | 34.6  | 44.6  | 52.1  | 57.2  | 60.9  | 62.4  |
| 118 | 700        | 0.5      | 8.1  | 20.7  | 32.7  | 42.1  | 49.1  | 53.9  | 57.4  | 58.7  |
| 119 | 750        | 0.5      | 7.9  | 19.7  | 31    | 39.9  | 46.4  | 50.9  | 54.2  | 55.5  |
| 120 | 800        | 0.5      | 7.6  | 18.8  | 29.4  | 37.8  | 43.9  | 48.2  | 51.3  | 52.6  |
| 121 | 850        | 0.5      | 7.4  | 18    | 28    | 35.8  | 41.7  | 45.7  | 48.7  | 49.9  |
| 122 | 900        | 0.5      | 7.2  | 17.2  | 26.7  | 34.1  | 39.6  | 43.5  | 46.3  | 47.5  |
| 123 | 950        | 0.5      | 7    | 16.5  | 25.4  | 32.4  | 37.7  | 41.4  | 44.1  | 45.3  |
| 124 | 1000       | 0.5      | 6.8  | 15.9  | 24.3  | 30.9  | 35.9  | 39.4  | 42.1  | 43.2  |



PWR DATA TABLES

|     | A            | B    | C  | D      | E      | F      | G      | H      | I      | J      |
|-----|--------------|------|----|--------|--------|--------|--------|--------|--------|--------|
| 1   | Enrichment   |      |    |        |        |        |        |        |        |        |
| 2   | 3.5 GW-d/MTU |      |    |        |        |        |        |        |        |        |
|     | Year         | 1    | 10 | 20     | 30     | 40     | 50     | 60     | 70     | 75     |
| 68  | 70           | 3.96 | 48 | 111.32 | 177.33 | 242.04 | 307.05 | 889.70 | 432.07 | 463.07 |
| 69  | 71           | 3.88 | 48 | 109.82 | 175.03 | 238.04 | 303.04 | 877.81 | 426.06 | 456.07 |
| 70  | 72           | 3.8  | 47 | 108.32 | 172.93 | 236.03 | 299.04 | 867.12 | 419.06 | 449.07 |
| 71  | 73           | 3.72 | 46 | 107.02 | 170.72 | 233.03 | 295.04 | 855.53 | 413.06 | 442.06 |
| 72  | 74           | 3.65 | 45 | 105.52 | 168.62 | 229.73 | 291.04 | 843.56 | 408.06 | 436.06 |
| 73  | 75           | 3.57 | 45 | 104.11 | 166.62 | 227.43 | 287.04 | 833.77 | 402.06 | 429.06 |
| 74  | 76           | 3.5  | 44 | 102.91 | 164.62 | 224.13 | 283.04 | 822.20 | 396.05 | 423.06 |
| 75  | 77           | 3.43 | 43 | 101.61 | 162.62 | 221.83 | 280.04 | 812.53 | 391.05 | 417.06 |
| 76  | 78           | 3.37 | 43 | 100.31 | 160.72 | 218.63 | 276.04 | 802.07 | 386.05 | 411.06 |
| 77  | 79           | 3.3  | 42 | 99.11  | 158.82 | 216.53 | 273.04 | 792.80 | 380.05 | 405.05 |
| 78  | 80           | 3.24 | 42 | 97.81  | 156.92 | 213.43 | 270.03 | 783.43 | 375.05 | 399.05 |
| 79  | 81           | 3.17 | 41 | 96.61  | 155.12 | 211.43 | 266.03 | 773.36 | 370.05 | 394.05 |
| 80  | 82           | 3.11 | 40 | 95.41  | 153.32 | 208.43 | 263.03 | 763.30 | 365.05 | 389.05 |
| 81  | 83           | 3.05 | 40 | 94.41  | 151.62 | 206.43 | 259.73 | 755.24 | 360.05 | 383.05 |
| 82  | 84           | 2.99 | 39 | 93.21  | 149.92 | 204.53 | 257.43 | 747.08 | 355.05 | 378.05 |
| 83  | 85           | 2.94 | 39 | 92.11  | 148.22 | 201.72 | 254.23 | 738.22 | 351.05 | 373.05 |
| 84  | 86           | 2.88 | 38 | 91.01  | 146.62 | 199.92 | 251.03 | 729.46 | 346.05 | 368.05 |
| 85  | 87           | 2.83 | 38 | 89.91  | 145.02 | 197.12 | 247.93 | 720.81 | 341.05 | 363.05 |
| 86  | 88           | 2.77 | 37 | 89.01  | 143.52 | 195.42 | 245.83 | 713.55 | 338.04 | 359.05 |
| 87  | 89           | 2.72 | 37 | 88.01  | 141.92 | 192.72 | 242.83 | 705.20 | 333.04 | 354.05 |
| 88  | 90           | 2.67 | 36 | 87.01  | 140.52 | 191.12 | 239.83 | 697.15 | 329.04 | 349.05 |
| 89  | 91           | 2.62 | 36 | 86.01  | 139.02 | 189.52 | 237.93 | 691.10 | 325.04 | 345.05 |
| 90  | 92           | 2.57 | 35 | 85.01  | 137.52 | 186.92 | 235.03 | 682.05 | 321.04 | 341.05 |
| 91  | 93           | 2.53 | 35 | 84.11  | 136.12 | 185.42 | 232.23 | 675.41 | 317.14 | 336.05 |
| 92  | 94           | 2.48 | 34 | 83.31  | 134.72 | 182.92 | 230.43 | 667.86 | 313.84 | 333.05 |
| 93  | 95           | 2.44 | 34 | 82.41  | 133.32 | 181.42 | 227.73 | 661.32 | 309.54 | 328.65 |
| 94  | 96           | 2.39 | 33 | 81.51  | 132.02 | 180.02 | 224.93 | 653.87 | 306.34 | 324.25 |
| 95  | 97           | 2.35 | 33 | 80.61  | 130.72 | 177.62 | 223.33 | 647.63 | 303.14 | 320.94 |
| 96  | 98           | 2.31 | 32 | 79.81  | 129.52 | 176.32 | 220.73 | 640.69 | 299.04 | 316.74 |
| 97  | 99           | 2.27 | 32 | 79.01  | 128.22 | 174.92 | 218.13 | 634.55 | 295.94 | 313.54 |
| 98  | 100          | 2.23 | 32 | 78.21  | 127.02 | 172.62 | 216.53 | 628.61 | 292.94 | 309.44 |
| 99  | 110          | 1.88 | 28 | 71.11  | 116.11 | 157.32 | 196.93 | 571.35 | 263.24 | 277.74 |
| 100 | 120          | 1.6  | 25 | 65.31  | 107.11 | 145.32 | 181.13 | 525.47 | 239.24 | 252.04 |
| 101 | 130          | 1.38 | 23 | 60.61  | 99.71  | 135.32 | 167.62 | 487.64 | 220.24 | 231.44 |
| 102 | 140          | 1.21 | 21 | 56.71  | 93.61  | 126.72 | 155.92 | 455.17 | 203.53 | 213.34 |
| 103 | 150          | 1.08 | 20 | 53.53  | 88.41  | 119.32 | 146.72 | 429.06 | 190.63 | 199.03 |
| 104 | 160          | 0.97 | 19 | 50.84  | 84.11  | 112.92 | 139.52 | 407.36 | 178.23 | 186.33 |
| 105 | 170          | 0.89 | 18 | 48.55  | 80.38  | 108.22 | 132.22 | 388.26 | 169.03 | 175.83 |
| 106 | 180          | 0.82 | 17 | 46.68  | 77.19  | 103.64 | 126.68 | 372.01 | 160.63 | 167.33 |
| 107 | 190          | 0.77 | 16 | 45.06  | 74.47  | 99.74  | 121.65 | 357.69 | 152.99 | 158.53 |
| 108 | 200          | 0.73 | 16 | 43.63  | 72.02  | 96.3   | 117.04 | 345.72 | 145.89 | 152.32 |
| 109 | 250          | 0.62 | 14 | 38.64  | 63.31  | 83.54  | 99.87  | 299.98 | 122.44 | 126.58 |
| 110 | 300          | 0.58 | 13 | 35.46  | 57.48  | 74.99  | 88.79  | 270.30 | 106.78 | 109.82 |
| 111 | 350          | 0.57 | 12 | 32.89  | 52.93  | 68.56  | 80.4   | 247.35 | 95.56  | 98.18  |
| 112 | 400          | 0.57 | 11 | 30.83  | 49.15  | 63.26  | 73.78  | 228.59 | 86.71  | 89.01  |
| 113 | 450          | 0.56 | 11 | 28.92  | 45.82  | 58.73  | 68.14  | 213.17 | 79.66  | 81.66  |
| 114 | 500          | 0.56 | 10 | 27.31  | 43.02  | 54.82  | 63.43  | 199.14 | 73.74  | 75.54  |
| 115 | 550          | 0.56 | 10 | 25.81  | 40.41  | 51.32  | 59.22  | 187.32 | 68.63  | 70.34  |
| 116 | 600          | 0.56 | 10 | 24.41  | 38.01  | 48.22  | 55.52  | 176.72 | 64.23  | 65.84  |
| 117 | 650          | 0.55 | 9  | 23.21  | 35.91  | 45.42  | 52.22  | 166.31 | 60.43  | 61.83  |
| 118 | 700          | 0.55 | 9  | 22.01  | 34.01  | 42.92  | 49.22  | 157.71 | 56.93  | 58.33  |
| 119 | 750          | 0.55 | 9  | 21.01  | 32.21  | 40.52  | 46.52  | 149.81 | 53.83  | 55.13  |
| 120 | 800          | 0.55 | 8  | 20.01  | 30.51  | 38.42  | 44.12  | 141.61 | 51.03  | 52.23  |
| 121 | 850          | 0.55 | 8  | 19.11  | 29.01  | 36.52  | 41.82  | 135.01 | 48.43  | 49.63  |
| 122 | 900          | 0.55 | 8  | 18.31  | 27.71  | 34.72  | 39.72  | 129.01 | 46.13  | 47.33  |
| 123 | 950          | 0.55 | 8  | 17.51  | 26.41  | 33.02  | 37.82  | 123.31 | 43.93  | 45.13  |
| 124 | 1000         | 0.55 | 7  | 16.81  | 25.21  | 31.52  | 36.12  | 117.21 | 41.93  | 43.13  |

PWR DATA TABLES

|    | A                          | B     | C      | D      | E      | F       | G       | H       | I       | J       |
|----|----------------------------|-------|--------|--------|--------|---------|---------|---------|---------|---------|
| 1  | Enrichment<br>3.0 GW-d/MTU |       |        |        |        |         |         |         |         |         |
| 2  | Year                       | 1     | 10     | 20     | 30     | 40      | 50      | 60      | 70      | 75      |
| 3  | 5                          | 25.79 | 255.84 | 518.57 | 802.55 | 1116.86 | 1487.49 | 1891.65 | 2336.09 | 2568.16 |
| 4  | 6                          | 21.45 | 214.84 | 439.25 | 686.02 | 963.42  | 1291.19 | 1657.69 | 2071.73 | 2288.17 |
| 5  | 7                          | 19.13 | 192.33 | 394.46 | 616.45 | 867.01  | 1168.24 | 1510.36 | 1890.13 | 2092.05 |
| 6  | 8                          | 17.84 | 178.95 | 365.25 | 570.43 | 802.59  | 1082.44 | 1403.18 | 1760.92 | 1949.35 |
| 7  | 9                          | 16.98 | 168.78 | 345.24 | 537.04 | 755.92  | 1019.53 | 1322.24 | 1661.07 | 1840.01 |
| 8  | 10                         | 16.23 | 161.73 | 329.61 | 512.06 | 719.01  | 969.48  | 1258.32 | 1581.27 | 1752.83 |
| 9  | 11                         | 15.71 | 155.93 | 317.24 | 492.57 | 690.62  | 929.3   | 1205.25 | 1514.45 | 1677.74 |
| 10 | 12                         | 15.2  | 151.2  | 307.12 | 475.47 | 665.84  | 894.66  | 1159.86 | 1457.41 | 1614.44 |
| 11 | 13                         | 14.7  | 146.58 | 298.16 | 461.54 | 644.56  | 865.62  | 1121.19 | 1406.23 | 1557.9  |
| 12 | 14                         | 14.22 | 143.08 | 289.43 | 448.99 | 625.67  | 839.09  | 1085.14 | 1361.58 | 1507.11 |
| 13 | 15                         | 13.85 | 138.68 | 282.88 | 436.68 | 610.14  | 816.95  | 1053.5  | 1319.55 | 1460.94 |
| 14 | 16                         | 13.48 | 135.27 | 275.4  | 426.45 | 593.88  | 794.3   | 1024.34 | 1281.01 | 1417.27 |
| 15 | 17                         | 13.12 | 132.03 | 269.97 | 416.43 | 579.88  | 773.9   | 996.57  | 1245.97 | 1377    |
| 16 | 18                         | 12.78 | 128.76 | 263.76 | 407.61 | 566.2   | 755.87  | 971.16  | 1211.31 | 1338.2  |
| 17 | 19                         | 12.43 | 125.55 | 258.46 | 398.85 | 553.69  | 737     | 947.13  | 1178.92 | 1302.69 |
| 18 | 20                         | 12.09 | 123.48 | 252.36 | 391.24 | 542.38  | 721.4   | 924.25  | 1149.79 | 1268.54 |
| 19 | 21                         | 11.86 | 120.37 | 247.26 | 382.65 | 531.22  | 705     | 901.6   | 1121.01 | 1236.64 |
| 20 | 22                         | 11.53 | 117.89 | 243.22 | 375.17 | 520.21  | 689.78  | 881.18  | 1093.4  | 1205.95 |
| 21 | 23                         | 11.21 | 115.44 | 238.15 | 368.79 | 509.33  | 674.7   | 860.93  | 1067.01 | 1175.48 |
| 22 | 24                         | 10.98 | 113.02 | 233.24 | 361.29 | 499.55  | 660.75  | 841.84  | 1041.78 | 1146.2  |
| 23 | 25                         | 10.69 | 110.64 | 229.28 | 354.76 | 490.87  | 646.93  | 822.88  | 1016.71 | 1119.08 |
| 24 | 26                         | 10.45 | 108.48 | 225.27 | 348.3  | 481.28  | 634.2   | 805.04  | 992.76  | 1091.09 |
| 25 | 27                         | 10.19 | 106.23 | 221.39 | 341.9  | 471.76  | 621.57  | 787.29  | 969.94  | 1066.22 |
| 26 | 28                         | 9.96  | 104.21 | 217.44 | 336.55 | 463.29  | 609.01  | 771.65  | 949.21  | 1040.46 |
| 27 | 29                         | 9.73  | 102.09 | 213.53 | 330.23 | 453.89  | 596.52  | 755.08  | 926.57  | 1016.79 |
| 28 | 30                         | 9.5   | 100.1  | 209.65 | 323.95 | 446.54  | 586.09  | 739.59  | 906.02  | 994.21  |
| 29 | 31                         | 9.28  | 98.11  | 205.78 | 318.72 | 438.23  | 574.71  | 724.15  | 886.54  | 971.71  |
| 30 | 32                         | 9.07  | 96.24  | 201.84 | 313.51 | 430.96  | 564.39  | 709.77  | 867.11  | 950.25  |
| 31 | 33                         | 8.86  | 94.47  | 198.91 | 308.32 | 422.73  | 553.1   | 695.44  | 848.73  | 928.86  |
| 32 | 34                         | 8.66  | 92.62  | 195    | 303.17 | 416.51  | 542.84  | 681.14  | 830.4   | 907.52  |
| 33 | 35                         | 8.46  | 90.97  | 192.1  | 298.03 | 409.34  | 533.62  | 667.88  | 813.11  | 888.21  |
| 34 | 36                         | 8.27  | 89.22  | 189.22 | 292.9  | 402.17  | 523.43  | 654.66  | 795.86  | 868.95  |
| 35 | 37                         | 8.08  | 87.48  | 186.34 | 288.79 | 395.03  | 514.26  | 641.45  | 779.63  | 850.72  |
| 36 | 38                         | 7.91  | 85.95  | 182.38 | 283.7  | 387.91  | 505.11  | 629.29  | 763.44  | 832.52  |
| 37 | 39                         | 7.73  | 84.42  | 179.42 | 279.62 | 382.8   | 495.97  | 618.13  | 747.28  | 815.33  |
| 38 | 40                         | 7.56  | 82.79  | 176.57 | 275.54 | 375.7   | 486.86  | 606     | 733.12  | 798.18  |
| 39 | 41                         | 7.39  | 81.37  | 174.63 | 270.48 | 369.62  | 478.76  | 594.88  | 717.99  | 781.04  |
| 40 | 42                         | 7.23  | 79.85  | 171.69 | 266.42 | 364.55  | 470.67  | 583.78  | 703.88  | 764.92  |
| 41 | 43                         | 7.07  | 78.43  | 168.66 | 262.37 | 358.49  | 462.59  | 573.69  | 690.78  | 749.81  |
| 42 | 44                         | 6.92  | 77.02  | 165.73 | 258.33 | 352.43  | 454.52  | 562.61  | 676.69  | 734.72  |
| 43 | 45                         | 6.77  | 75.7   | 163.8  | 254.29 | 346.38  | 446.46  | 552.54  | 662.61  | 720.64  |
| 44 | 46                         | 6.63  | 74.29  | 160.78 | 250.26 | 341.34  | 440.41  | 542.48  | 650.54  | 705.57  |
| 45 | 47                         | 6.47  | 72.98  | 158.86 | 247.23 | 336.3   | 432.37  | 533.43  | 638.48  | 692.51  |
| 46 | 48                         | 6.33  | 71.77  | 155.84 | 243.1  | 331.27  | 425.33  | 523.38  | 626.43  | 678.45  |
| 47 | 49                         | 6.2   | 70.46  | 153.62 | 239.88 | 326.24  | 418.29  | 514.34  | 614.38  | 665.4   |
| 48 | 50                         | 6.07  | 69.26  | 151.31 | 235.76 | 321.21  | 412.26  | 506.3   | 603.34  | 652.36  |
| 49 | 51                         | 5.94  | 68.15  | 149    | 232.54 | 316.19  | 405.23  | 497.27  | 591.31  | 640.32  |
| 50 | 52                         | 5.81  | 66.95  | 146.79 | 229.33 | 312.17  | 399.21  | 488.24  | 581.27  | 628.29  |
| 51 | 53                         | 5.69  | 65.84  | 144.68 | 226.12 | 307.15  | 392.19  | 480.22  | 571.25  | 617.26  |
| 52 | 54                         | 5.57  | 64.74  | 142.57 | 222.9  | 302.14  | 387.17  | 473.2   | 560.22  | 605.24  |
| 53 | 55                         | 5.45  | 63.63  | 140.46 | 219.79 | 298.12  | 380.15  | 465.18  | 550.2   | 594.21  |
| 54 | 56                         | 5.34  | 62.53  | 138.46 | 216.59 | 294.11  | 375.14  | 456.16  | 541.18  | 583.19  |
| 55 | 57                         | 5.23  | 61.53  | 136.45 | 213.38 | 289.1   | 369.13  | 450.15  | 531.17  | 572.18  |
| 56 | 58                         | 5.12  | 60.52  | 134.45 | 210.17 | 286.09  | 363.11  | 442.14  | 523.15  | 563.16  |
| 57 | 59                         | 5.01  | 59.62  | 132.64 | 207.86 | 281.08  | 358.1   | 435.12  | 513.14  | 552.15  |
| 58 | 60                         | 4.91  | 58.62  | 130.74 | 204.66 | 277.08  | 352.1   | 429.11  | 504.13  | 543.14  |
| 59 | 61                         | 4.8   | 57.72  | 128.94 | 202.45 | 274.07  | 347.09  | 422.11  | 496.12  | 533.13  |
| 60 | 62                         | 4.71  | 56.82  | 127.13 | 199.25 | 270.07  | 343.08  | 415.1   | 488.11  | 524.12  |
| 61 | 63                         | 4.61  | 55.92  | 125.43 | 196.85 | 267.06  | 338.08  | 408.09  | 480.1   | 515.11  |
| 62 | 64                         | 4.52  | 55.01  | 123.73 | 194.24 | 263.06  | 332.07  | 402.08  | 472.1   | 506.1   |

PWR DATA TABLES

|     | A            | B    | C     | D      | E      | F      | G      | H      | I      | J      |
|-----|--------------|------|-------|--------|--------|--------|--------|--------|--------|--------|
| 1   | Enrichment   |      |       |        |        |        |        |        |        |        |
| 2   | 3.0 GW-d/MTU |      |       |        |        |        |        |        |        |        |
| 3   | Year         | 1    | 10    | 20     | 30     | 40     | 50     | 60     | 70     | 75     |
| 63  | 65           | 4.42 | 54.11 | 122.13 | 191.74 | 260.05 | 328.07 | 396.08 | 464.09 | 499.1  |
| 64  | 66           | 4.33 | 53.21 | 120.43 | 189.14 | 256.05 | 323.06 | 390.07 | 457.09 | 490.09 |
| 65  | 67           | 4.25 | 52.41 | 118.92 | 186.84 | 252.05 | 319.06 | 384.07 | 450.08 | 482.09 |
| 66  | 68           | 4.16 | 51.61 | 117.32 | 184.43 | 249.04 | 315.06 | 379.07 | 442.08 | 474.08 |
| 67  | 69           | 4.08 | 50.81 | 115.72 | 182.13 | 246.04 | 311.05 | 373.06 | 436.07 | 467.08 |
| 68  | 70           | 3.99 | 50.01 | 114.32 | 179.83 | 243.04 | 307.05 | 368.06 | 429.07 | 459.08 |
| 69  | 71           | 3.92 | 49.31 | 112.82 | 177.63 | 240.04 | 302.05 | 363.06 | 422.07 | 452.07 |
| 70  | 72           | 3.84 | 48.61 | 111.32 | 175.43 | 237.04 | 298.05 | 358.06 | 416.07 | 445.07 |
| 71  | 73           | 3.76 | 47.91 | 110.02 | 173.23 | 233.74 | 294.05 | 353.05 | 410.06 | 438.07 |
| 72  | 74           | 3.69 | 47.21 | 108.62 | 171.23 | 231.33 | 290.04 | 348.05 | 404.06 | 431.07 |
| 73  | 75           | 3.61 | 46.51 | 107.22 | 169.22 | 228.03 | 286.04 | 343.05 | 397.06 | 424.06 |
| 74  | 76           | 3.54 | 45.81 | 105.92 | 167.22 | 225.83 | 282.04 | 339.05 | 392.06 | 418.06 |
| 75  | 77           | 3.48 | 45.11 | 104.72 | 165.22 | 222.63 | 279.04 | 334.05 | 387.06 | 412.06 |
| 76  | 78           | 3.41 | 44.51 | 103.41 | 163.32 | 220.53 | 276.04 | 330.05 | 381.06 | 406.06 |
| 77  | 79           | 3.34 | 43.91 | 102.11 | 161.52 | 217.43 | 273.04 | 325.05 | 376.05 | 400.06 |
| 78  | 80           | 3.28 | 43.31 | 100.91 | 159.62 | 215.43 | 269.04 | 321.05 | 371.05 | 394.06 |
| 79  | 81           | 3.22 | 42.71 | 99.71  | 157.82 | 212.43 | 265.94 | 316.04 | 365.05 | 389.06 |
| 80  | 82           | 3.15 | 42.11 | 98.51  | 156.12 | 210.43 | 262.64 | 313.04 | 361.05 | 383.06 |
| 81  | 83           | 3.09 | 41.51 | 97.51  | 154.32 | 207.53 | 259.34 | 309.04 | 356.05 | 377.05 |
| 82  | 84           | 3.04 | 40.91 | 96.41  | 152.62 | 205.73 | 256.14 | 304.04 | 351.05 | 372.05 |
| 83  | 85           | 2.98 | 40.41 | 95.31  | 151.02 | 202.93 | 253.03 | 301.04 | 346.05 | 367.05 |
| 84  | 86           | 2.91 | 39.91 | 94.21  | 149.32 | 201.13 | 250.83 | 297.04 | 341.05 | 362.05 |
| 85  | 87           | 2.86 | 39.41 | 93.21  | 147.72 | 198.43 | 247.83 | 294.04 | 337.05 | 358.05 |
| 86  | 88           | 2.81 | 38.81 | 92.11  | 146.22 | 196.73 | 244.83 | 289.74 | 333.05 | 353.05 |
| 87  | 89           | 2.75 | 38.31 | 91.11  | 144.72 | 194.13 | 241.83 | 286.44 | 328.05 | 348.05 |
| 88  | 90           | 2.7  | 37.81 | 90.11  | 143.22 | 192.53 | 239.93 | 283.24 | 324.05 | 344.05 |
| 89  | 91           | 2.66 | 37.41 | 89.21  | 141.72 | 189.93 | 237.03 | 280.14 | 320.05 | 339.05 |
| 90  | 92           | 2.61 | 36.91 | 88.31  | 140.32 | 188.43 | 234.23 | 276.94 | 316.15 | 334.05 |
| 91  | 93           | 2.56 | 36.41 | 87.41  | 138.82 | 186.93 | 231.43 | 273.94 | 312.85 | 331.05 |
| 92  | 94           | 2.51 | 36.01 | 86.51  | 137.52 | 184.42 | 229.63 | 269.94 | 308.55 | 326.65 |
| 93  | 95           | 2.47 | 35.51 | 85.61  | 136.22 | 183.02 | 226.93 | 266.94 | 305.35 | 322.35 |
| 94  | 96           | 2.43 | 35.11 | 84.71  | 134.92 | 180.62 | 224.23 | 264.04 | 301.14 | 319.05 |
| 95  | 97           | 2.38 | 34.71 | 83.91  | 133.62 | 179.32 | 221.63 | 261.14 | 298.04 | 314.85 |
| 96  | 98           | 2.34 | 34.21 | 83.11  | 132.32 | 177.02 | 220.03 | 258.34 | 294.04 | 310.65 |
| 97  | 99           | 2.3  | 33.91 | 82.31  | 131.02 | 175.72 | 217.53 | 255.54 | 290.94 | 307.55 |
| 98  | 100          | 2.26 | 33.51 | 81.51  | 129.92 | 174.42 | 215.03 | 252.74 | 288.04 | 303.45 |
| 99  | 110          | 1.91 | 30.01 | 74.31  | 118.92 | 159.32 | 195.73 | 228.44 | 258.74 | 272.24 |
| 100 | 120          | 1.64 | 27.2  | 68.61  | 109.92 | 146.62 | 180.23 | 209.33 | 235.04 | 246.84 |
| 101 | 130          | 1.42 | 24.98 | 63.91  | 102.62 | 136.72 | 166.93 | 192.73 | 215.34 | 225.54 |
| 102 | 140          | 1.25 | 23.09 | 60.01  | 96.41  | 128.32 | 155.43 | 179.23 | 199.84 | 208.54 |
| 103 | 150          | 1.12 | 21.64 | 56.78  | 91.31  | 121.02 | 146.22 | 168.23 | 186.13 | 193.54 |
| 104 | 160          | 1.01 | 20.46 | 54.03  | 86.92  | 114.62 | 138.22 | 158.53 | 174.83 | 181.94 |
| 105 | 170          | 0.93 | 19.48 | 51.76  | 83.22  | 109.46 | 132.02 | 149.83 | 164.63 | 171.53 |
| 106 | 180          | 0.86 | 18.67 | 49.81  | 79.97  | 104.97 | 125.47 | 142.93 | 156.33 | 163.03 |
| 107 | 190          | 0.81 | 17.89 | 48.1   | 77.17  | 101.01 | 120.48 | 136.66 | 149.78 | 155.33 |
| 108 | 200          | 0.77 | 17.31 | 46.69  | 74.75  | 97.51  | 115.91 | 130.84 | 142.73 | 148.15 |
| 109 | 250          | 0.66 | 15.44 | 41.43  | 65.69  | 84.71  | 99.63  | 111.12 | 120.4  | 123.54 |
| 110 | 300          | 0.62 | 14.34 | 37.96  | 59.67  | 76.08  | 88.58  | 97.88  | 104.77 | 107.81 |
| 111 | 350          | 0.61 | 13.45 | 35.29  | 54.93  | 69.46  | 80.3   | 88.13  | 94.16  | 96.68  |
| 112 | 400          | 0.61 | 12.72 | 33.03  | 51.05  | 64.16  | 73.68  | 80.49  | 85.61  | 87.81  |
| 113 | 450          | 0.6  | 12.11 | 31.02  | 47.62  | 59.53  | 68.14  | 74.15  | 78.76  | 80.66  |
| 114 | 500          | 0.6  | 11.61 | 29.21  | 44.62  | 55.52  | 63.33  | 68.84  | 72.94  | 74.74  |
| 115 | 550          | 0.6  | 11.1  | 27.61  | 41.91  | 52.02  | 59.23  | 64.23  | 68.04  | 69.74  |
| 116 | 600          | 0.6  | 10.6  | 26.11  | 39.41  | 48.92  | 55.62  | 60.23  | 63.73  | 65.34  |
| 117 | 650          | 0.59 | 10.2  | 24.71  | 37.21  | 46.02  | 52.32  | 56.63  | 60.03  | 61.44  |
| 118 | 700          | 0.59 | 9.78  | 23.51  | 35.21  | 43.52  | 49.32  | 53.43  | 56.63  | 58.04  |
| 119 | 750          | 0.59 | 9.41  | 22.41  | 33.41  | 41.12  | 46.62  | 50.53  | 53.53  | 54.93  |
| 120 | 800          | 0.59 | 9.07  | 21.31  | 31.71  | 39.02  | 44.22  | 47.93  | 50.83  | 52.03  |
| 121 | 850          | 0.59 | 8.76  | 20.31  | 30.11  | 37.02  | 41.92  | 45.53  | 48.33  | 49.53  |
| 122 | 900          | 0.58 | 8.47  | 19.41  | 28.61  | 35.22  | 39.92  | 43.33  | 45.93  | 47.13  |
| 123 | 950          | 0.58 | 8.2   | 18.61  | 27.31  | 33.52  | 38.02  | 41.23  | 43.83  | 45.03  |
| 124 | 1000         | 0.58 | 7.96  | 17.81  | 26.11  | 32.02  | 36.22  | 39.43  | 41.93  | 43.03  |

PWR DATA TABLES

|    | A          | B        | C     | D     | E     | F      | G      | H      | I      | J      |
|----|------------|----------|-------|-------|-------|--------|--------|--------|--------|--------|
| 1  | Enrichment |          |       |       |       |        |        |        |        |        |
| 2  | 2.5        | GW-d/MTU |       |       |       |        |        |        |        |        |
| 3  | Year       | 1        | 10    | 20    | 30    | 40     | 50     | 60     | 70     | 75     |
| 4  | 5          | 26       | 260.4 | 529   | 824.2 | 1153.6 | 1534.7 | 1960.7 | 2422.6 | 2658.4 |
| 5  | 6          | 21.6     | 218.3 | 447.3 | 702   | 992.4  | 1339.5 | 1722.9 | 2143.5 | 2363.6 |
| 6  | 7          | 19.4     | 194.5 | 399.1 | 627.6 | 891.2  | 1209.8 | 1568.8 | 1958.2 | 2165.8 |
| 7  | 8          | 18       | 180   | 368.4 | 579   | 823.1  | 1120.3 | 1457   | 1827.4 | 2022.5 |
| 8  | 9          | 17.1     | 170.7 | 347.3 | 545.2 | 773.9  | 1052.8 | 1371.4 | 1722.9 | 1907.7 |
| 9  | 10         | 16.4     | 162.6 | 331.4 | 519   | 735.4  | 1001.3 | 1304   | 1639.6 | 1816.1 |
| 10 | 11         | 15.8     | 156.6 | 318.7 | 498.3 | 705.7  | 958.5  | 1248.4 | 1569.4 | 1738.5 |
| 11 | 12         | 15.3     | 151.8 | 308.4 | 481   | 679.5  | 922.6  | 1199.6 | 1509.1 | 1671.9 |
| 12 | 13         | 14.8     | 147.2 | 299.4 | 465.2 | 657.9  | 891.2  | 1158.7 | 1455.5 | 1612.2 |
| 13 | 14         | 14.4     | 143.6 | 290.4 | 451.6 | 637.7  | 863.3  | 1121.3 | 1407.6 | 1558   |
| 14 | 15         | 14       | 139.2 | 283.6 | 440.5 | 619.9  | 838    | 1087.4 | 1363.3 | 1508.6 |
| 15 | 16         | 13.5     | 135.8 | 277.1 | 429.6 | 603.4  | 814.9  | 1056   | 1322.6 | 1462.7 |
| 16 | 17         | 13.1     | 132.5 | 270.5 | 418.9 | 589.3  | 793.4  | 1026.1 | 1284.4 | 1419.3 |
| 17 | 18         | 12.8     | 129.2 | 264.2 | 410.5 | 574.4  | 774.1  | 999.4  | 1248.5 | 1379.3 |
| 18 | 19         | 12.5     | 127   | 258.9 | 402.2 | 561.8  | 755.1  | 974.2  | 1214.9 | 1341.7 |
| 19 | 20         | 12.2     | 123.9 | 253.7 | 393   | 549.3  | 736.4  | 950.3  | 1181.8 | 1305.4 |
| 20 | 21         | 11.9     | 121.8 | 248.6 | 385.1 | 538.1  | 719.9  | 926.5  | 1151.8 | 1269.4 |
| 21 | 22         | 11.5     | 118.7 | 243.5 | 377.2 | 526.9  | 704.6  | 902.9  | 1123.1 | 1237.6 |
| 22 | 23         | 11.3     | 116.3 | 239.3 | 370.4 | 516    | 688.4  | 881.6  | 1093.6 | 1206.1 |
| 23 | 24         | 11       | 113.9 | 234.4 | 363.8 | 505.1  | 674.3  | 861.4  | 1067.3 | 1174.7 |
| 24 | 25         | 10.7     | 111.6 | 230.4 | 357.2 | 495.4  | 659.4  | 842.4  | 1041.2 | 1145.5 |
| 25 | 26         | 10.5     | 109.4 | 226.3 | 350.7 | 486.7  | 645.7  | 822.5  | 1016.2 | 1117.5 |
| 26 | 27         | 10.2     | 107.3 | 222.4 | 344.2 | 476.1  | 632    | 804.7  | 992.3  | 1089.6 |
| 27 | 28         | 10       | 105.2 | 218.5 | 337.8 | 467.6  | 619.4  | 787    | 968.5  | 1062.8 |
| 28 | 29         | 9.8      | 103.1 | 214.5 | 332.5 | 459.2  | 606.8  | 769.4  | 946.9  | 1038.1 |
| 29 | 30         | 9.5      | 101.2 | 210.6 | 327.2 | 450.8  | 594.4  | 752.9  | 924.3  | 1012.5 |
| 30 | 31         | 9.3      | 99.3  | 207.7 | 319.9 | 442.5  | 583    | 737.4  | 902.8  | 988.9  |
| 31 | 32         | 9.1      | 97.4  | 203.8 | 314.7 | 434.2  | 570.6  | 721    | 882.3  | 966.4  |
| 32 | 33         | 8.9      | 95.6  | 200.8 | 309.5 | 426.9  | 560.3  | 706.6  | 862.9  | 944    |
| 33 | 34         | 8.7      | 93.9  | 196.9 | 304.3 | 419.7  | 549    | 692.3  | 844.6  | 922.7  |
| 34 | 35         | 8.5      | 92.1  | 194   | 300.1 | 412.5  | 538.8  | 677    | 825.2  | 901.3  |
| 35 | 36         | 8.3      | 90.5  | 191.1 | 295   | 405.3  | 528.6  | 663.8  | 807    | 881.1  |
| 36 | 37         | 8.1      | 88.9  | 188.1 | 290.9 | 398.1  | 519.4  | 650.6  | 789.7  | 861.8  |
| 37 | 38         | 7.9      | 87.3  | 184.2 | 285.8 | 392    | 510.2  | 638.4  | 773.5  | 843.6  |
| 38 | 39         | 7.8      | 85.8  | 181.3 | 280.7 | 384.9  | 500.1  | 625.2  | 756.4  | 824.4  |
| 39 | 40         | 7.6      | 84.3  | 179.3 | 276.6 | 378.8  | 491.9  | 613.1  | 741.2  | 806.2  |
| 40 | 41         | 7.4      | 82.8  | 176.4 | 272.5 | 372.7  | 482.8  | 600.9  | 726.1  | 790.1  |
| 41 | 42         | 7.3      | 81.4  | 173.4 | 268.5 | 366.6  | 474.7  | 589.8  | 710.9  | 772    |
| 42 | 43         | 7.1      | 79.9  | 170.5 | 264.4 | 360.5  | 465.6  | 577.7  | 695.8  | 755.9  |
| 43 | 44         | 7        | 78.6  | 168.6 | 259.4 | 354.5  | 457.6  | 566.7  | 681.7  | 740.8  |
| 44 | 45         | 6.8      | 77.2  | 165.5 | 256.3 | 349.4  | 450.5  | 556.6  | 668.6  | 724.7  |
| 45 | 46         | 6.7      | 76    | 163.6 | 252.3 | 343.4  | 442.4  | 546.5  | 655.6  | 709.6  |
| 46 | 47         | 6.5      | 74.7  | 160.6 | 249.3 | 338.3  | 434.4  | 536.5  | 642.5  | 695.5  |
| 47 | 48         | 6.4      | 73.5  | 158.5 | 245.2 | 332.3  | 427.4  | 527.4  | 629.5  | 681.5  |
| 48 | 49         | 6.2      | 72.3  | 156.1 | 241.2 | 327.3  | 420.3  | 517.4  | 616.4  | 667.4  |
| 49 | 50         | 6.1      | 71.1  | 153.8 | 238.2 | 322.2  | 413.3  | 507.3  | 605.4  | 654.4  |
| 50 | 51         | 6        | 69.9  | 151.6 | 235.2 | 317.2  | 406.3  | 499.3  | 594.3  | 642.3  |
| 51 | 52         | 5.9      | 68.8  | 149.4 | 231.1 | 312.2  | 399.2  | 490.3  | 583.3  | 629.3  |
| 52 | 53         | 5.7      | 67.6  | 147.3 | 227.1 | 308.2  | 394.2  | 481.2  | 572.3  | 617.3  |
| 53 | 54         | 5.6      | 66.5  | 145.2 | 225.1 | 304.2  | 387.2  | 473.2  | 561.2  | 605.3  |
| 54 | 55         | 5.5      | 65.4  | 143.2 | 222.1 | 299.1  | 381.2  | 465.2  | 550.2  | 594.2  |
| 55 | 56         | 5.4      | 64.4  | 141.2 | 219.1 | 294.1  | 375.2  | 457.2  | 541.2  | 582.2  |
| 56 | 57         | 5.3      | 63.5  | 139.3 | 215.1 | 290.1  | 370.1  | 449.2  | 531.2  | 572.2  |
| 57 | 58         | 5.2      | 62.5  | 137.4 | 212.1 | 287.1  | 364.1  | 442.1  | 521.2  | 561.2  |
| 58 | 59         | 5        | 61.5  | 135.4 | 210.1 | 282.1  | 359.1  | 435.1  | 512.2  | 551.2  |
| 59 | 60         | 4.9      | 60.6  | 133.6 | 207.1 | 278.1  | 353.1  | 427.1  | 503.1  | 541.1  |
| 60 | 61         | 4.8      | 59.6  | 131.8 | 204.1 | 274.1  | 347.1  | 421.1  | 494.1  | 531.1  |
| 61 | 62         | 4.7      | 58.7  | 130.1 | 201.6 | 271.1  | 342.1  | 414.1  | 486.1  | 522.1  |
| 62 | 63         | 4.6      | 57.8  | 128.3 | 199.2 | 267.1  | 338.1  | 408.1  | 478.1  | 512.1  |
|    | 64         | 4.6      | 57    | 126.7 | 196.8 | 263.1  | 332.1  | 401.1  | 469.1  | 503.1  |

PWR DATA TABLES

|     | A            | B   | C    | D     | E     | F     | G     | H     | I     | J     |
|-----|--------------|-----|------|-------|-------|-------|-------|-------|-------|-------|
| 1   | Enrichment   |     |      |       |       |       |       |       |       |       |
| 2   | 2.5 GW-d/MTU |     |      |       |       |       |       |       |       |       |
| 63  | 65           | 4.5 | 56.1 | 125   | 193.6 | 260.1 | 328.1 | 395.1 | 462.1 | 495.1 |
| 64  | 66           | 4.4 | 55.3 | 123.5 | 191.4 | 256.1 | 323.1 | 389.1 | 454.1 | 486.1 |
| 65  | 67           | 4.3 | 54.5 | 121.9 | 189.3 | 253.1 | 318.1 | 383.1 | 447.1 | 478.1 |
| 66  | 68           | 4.2 | 53.7 | 120.3 | 186.2 | 250   | 314.1 | 376.1 | 439.1 | 470.1 |
| 67  | 69           | 4.1 | 52.9 | 118.9 | 184.2 | 247   | 309.1 | 371.1 | 432.1 | 462.1 |
| 68  | 70           | 4   | 52.1 | 117.4 | 182.1 | 243   | 305.1 | 365.1 | 425.1 | 455.1 |
| 69  | 71           | 4   | 51.4 | 115.9 | 179.8 | 241   | 301.1 | 360.1 | 418.1 | 447.1 |
| 70  | 72           | 3.9 | 50.7 | 114.5 | 177.7 | 237.2 | 297.1 | 355.1 | 412.1 | 440.1 |
| 71  | 73           | 3.8 | 50   | 113.1 | 175.6 | 233.9 | 293   | 350.1 | 406.1 | 433.1 |
| 72  | 74           | 3.7 | 49.3 | 111.8 | 173.5 | 231.6 | 290   | 345.1 | 399.1 | 426.1 |
| 73  | 75           | 3.7 | 48.6 | 110.5 | 171.5 | 228.3 | 285   | 340.1 | 394.1 | 420.1 |
| 74  | 76           | 3.6 | 48   | 109.2 | 169.5 | 226.2 | 281   | 335.1 | 387.1 | 413.1 |
| 75  | 77           | 3.5 | 47.3 | 107.9 | 167.5 | 223   | 278   | 331.1 | 382.1 | 407.1 |
| 76  | 78           | 3.5 | 46.7 | 106.7 | 165.7 | 221   | 274   | 326.1 | 376.1 | 400.1 |
| 77  | 79           | 3.4 | 46   | 105.4 | 163.8 | 217.9 | 271   | 322.1 | 371.1 | 394.1 |
| 78  | 80           | 3.3 | 45.5 | 104.2 | 161.9 | 215   | 267.5 | 318   | 365.1 | 389.1 |
| 79  | 81           | 3.3 | 44.9 | 103.1 | 160.2 | 213   | 264.2 | 313   | 360.1 | 382.1 |
| 80  | 82           | 3.2 | 44.2 | 101.9 | 158.4 | 210.2 | 260.9 | 310   | 356.1 | 377.1 |
| 81  | 83           | 3.1 | 43.7 | 100.8 | 156.8 | 208.3 | 257.7 | 305   | 350.1 | 371.1 |
| 82  | 84           | 3.1 | 43.2 | 99.7  | 155   | 205.5 | 254.6 | 302   | 345.1 | 366.1 |
| 83  | 85           | 3   | 42.6 | 98.6  | 153.5 | 203.8 | 251.5 | 297   | 340.1 | 361.1 |
| 84  | 86           | 3   | 42.1 | 97.6  | 151.8 | 201.1 | 249.4 | 293.7 | 336.1 | 357.1 |
| 85  | 87           | 2.9 | 41.5 | 96.6  | 150.2 | 199.4 | 246.4 | 290.4 | 332.1 | 351.1 |
| 86  | 88           | 2.9 | 41   | 95.5  | 148.7 | 196.8 | 243.4 | 286.1 | 327.1 | 346.1 |
| 87  | 89           | 2.8 | 40.6 | 94.6  | 147.1 | 195.2 | 240.5 | 282.9 | 323.1 | 342.1 |
| 88  | 90           | 2.8 | 40.1 | 93.6  | 145.7 | 192.6 | 237.7 | 279.8 | 318.1 | 337.1 |
| 89  | 91           | 2.7 | 39.7 | 92.7  | 144.2 | 191.1 | 234.8 | 275.7 | 315.1 | 332.1 |
| 90  | 92           | 2.7 | 39.1 | 91.7  | 142.8 | 188.6 | 232.1 | 272.6 | 310.6 | 328.1 |
| 91  | 93           | 2.6 | 38.7 | 90.8  | 141.4 | 187.2 | 230.3 | 269.6 | 306.4 | 324.7 |
| 92  | 94           | 2.6 | 38.3 | 89.9  | 140.1 | 184.7 | 227.6 | 266.6 | 303.2 | 320.4 |
| 93  | 95           | 2.5 | 37.9 | 89.1  | 138.7 | 183.4 | 225   | 263.7 | 299   | 316.1 |
| 94  | 96           | 2.5 | 37.4 | 88.2  | 137.4 | 181   | 222.3 | 260.9 | 295.9 | 311.9 |
| 95  | 97           | 2.4 | 37   | 87.4  | 136.1 | 179.7 | 220.8 | 258   | 291.8 | 308.7 |
| 96  | 98           | 2.4 | 36.6 | 86.6  | 134.9 | 177.4 | 218.2 | 254.3 | 288.8 | 304.6 |
| 97  | 99           | 2.4 | 36.2 | 85.8  | 133.7 | 176.2 | 215.7 | 251.5 | 284.9 | 300.5 |
| 98  | 100          | 2.3 | 35.7 | 85    | 132.4 | 174.9 | 213.2 | 248.8 | 281.9 | 297.5 |
| 99  | 110          | 2   | 32.4 | 78    | 121.6 | 159.2 | 194.3 | 224.9 | 252.1 | 265.6 |
| 100 | 120          | 1.7 | 29.5 | 72.2  | 112.7 | 147.7 | 178.1 | 205.1 | 228.8 | 239.6 |
| 101 | 130          | 1.5 | 27.3 | 67.5  | 105.3 | 137   | 165.1 | 188.8 | 210.3 | 219.5 |
| 102 | 140          | 1.3 | 25.4 | 63.6  | 99.1  | 128.7 | 154.7 | 175.5 | 194   | 202.8 |
| 103 | 150          | 1.2 | 24   | 60.3  | 94    | 121.5 | 144.7 | 164.7 | 181.5 | 188.9 |
| 104 | 160          | 1.1 | 22.7 | 57.6  | 89.6  | 115.3 | 137.8 | 155.1 | 170.3 | 176.4 |
| 105 | 170          | 1   | 21.7 | 55.2  | 85.8  | 110.7 | 130.7 | 147.5 | 161.3 | 167.1 |
| 106 | 180          | 0.9 | 20.8 | 53.3  | 82.5  | 105.8 | 125.2 | 140.7 | 153.1 | 158.7 |
| 107 | 190          | 0.9 | 20.2 | 51.5  | 79.8  | 101.8 | 120.3 | 134.4 | 145.6 | 151.1 |
| 108 | 200          | 0.8 | 19.5 | 50    | 77.3  | 98.4  | 115.8 | 128.7 | 139.6 | 145   |
| 109 | 250          | 0.7 | 17.4 | 44.6  | 68.1  | 85.5  | 99.1  | 109.1 | 117.4 | 121.5 |
| 110 | 300          | 0.7 | 16.1 | 40.9  | 61.8  | 76.9  | 88.2  | 96.7  | 103.8 | 105.8 |
| 111 | 350          | 0.7 | 15.2 | 38    | 56.9  | 70.3  | 80    | 87.2  | 92.9  | 95.3  |
| 112 | 400          | 0.7 | 14.4 | 35.5  | 52.8  | 64.8  | 73.5  | 79.8  | 84.7  | 86.8  |
| 113 | 450          | 0.7 | 13.7 | 33.3  | 49.3  | 60.2  | 68    | 73.7  | 78.1  | 80    |
| 114 | 500          | 0.7 | 13   | 31.4  | 46.1  | 56.2  | 63.3  | 68.4  | 72.4  | 74.1  |
| 115 | 550          | 0.7 | 12.4 | 29.6  | 43.3  | 52.6  | 59.2  | 63.9  | 67.6  | 69.2  |
| 116 | 600          | 0.6 | 11.9 | 28    | 40.8  | 49.5  | 55.6  | 59.9  | 63.4  | 65    |
| 117 | 650          | 0.6 | 11.4 | 26.5  | 38.5  | 46.6  | 52.3  | 56.4  | 59.7  | 61.2  |
| 118 | 700          | 0.6 | 10.9 | 25.2  | 36.4  | 44    | 49.4  | 53.3  | 56.4  | 57.8  |
| 119 | 750          | 0.6 | 10.5 | 23.9  | 34.5  | 41.7  | 46.7  | 50.4  | 53.4  | 54.8  |
| 120 | 800          | 0.6 | 10.1 | 22.8  | 32.7  | 39.5  | 44.3  | 47.8  | 50.7  | 52    |
| 121 | 850          | 0.6 | 9.7  | 21.7  | 31.1  | 37.5  | 42.1  | 45.5  | 48.2  | 49.5  |
| 122 | 900          | 0.6 | 9.4  | 20.7  | 29.6  | 35.7  | 40    | 43.3  | 46    | 47.2  |
| 123 | 950          | 0.6 | 9.1  | 19.8  | 28.3  | 34    | 38.2  | 41.3  | 43.9  | 45.1  |
| 124 | 1000         | 0.6 | 8.8  | 19    | 27    | 32.4  | 36.4  | 39.4  | 42    | 43.1  |



PWR DATA TABLES

|    | A          | B        | C    | D     | E     | F     | G      | H      | I      | J      |
|----|------------|----------|------|-------|-------|-------|--------|--------|--------|--------|
| 1  | Enrichment |          |      |       |       |       |        |        |        |        |
| 2  | 2.0        | GW-d/MTU |      |       |       |       |        |        |        |        |
| 3  | Year       | 1        | 10   | 20    | 30    | 40    | 50     | 60     | 70     | 75     |
| 4  |            | 5        | 26.5 | 266.4 | 543.5 | 852.2 | 1197.3 | 1603.4 | 2039.9 | 2754.5 |
| 5  |            | 6        | 22.1 | 222   | 455.9 | 723   | 1028.1 | 1395.3 | 1798.2 | 2448.9 |
| 6  |            | 7        | 19.7 | 196.9 | 405.2 | 644   | 922.1  | 1258.7 | 1634.3 | 2245.4 |
| 7  |            | 8        | 18.3 | 182.1 | 373   | 591.8 | 849.3  | 1165.4 | 1517.8 | 2099.6 |
| 8  |            | 9        | 17.3 | 171.6 | 350.3 | 556.4 | 796.4  | 1094.4 | 1428.7 | 1982.3 |
| 9  |            | 10       | 16.6 | 164.4 | 334   | 528.6 | 757.5  | 1039.3 | 1356.7 | 1884.2 |
| 10 |            | 11       | 16   | 158.4 | 320.1 | 506.5 | 724.2  | 994    | 1298.7 | 1803.2 |
| 11 |            | 12       | 15.4 | 152.4 | 309.5 | 487.8 | 696.6  | 955.6  | 1247.5 | 1732.3 |
| 12 |            | 13       | 15   | 147.7 | 300.2 | 471.7 | 673.6  | 922.8  | 1203.2 | 1669.2 |
| 13 |            | 14       | 14.5 | 144.1 | 292   | 457.8 | 653.1  | 892.7  | 1163.5 | 1611.9 |
| 14 |            | 15       | 14.1 | 140.6 | 284   | 445.4 | 634.9  | 866    | 1127.3 | 1560.2 |
| 15 |            | 16       | 13.7 | 137.1 | 277.2 | 434.3 | 617.3  | 841.8  | 1092.8 | 1512.1 |
| 16 |            | 17       | 13.3 | 133.8 | 270.6 | 424.4 | 600.9  | 817.9  | 1061.6 | 1465.5 |
| 17 |            | 18       | 12.9 | 130.5 | 265   | 414.7 | 586.8  | 796.5  | 1032.8 | 1423.4 |
| 18 |            | 19       | 12.6 | 127.2 | 259.6 | 405.3 | 573    | 776.4  | 1005.3 | 1382.6 |
| 19 |            | 20       | 12.2 | 125.1 | 254.3 | 397   | 559.4  | 757.5  | 978.3  | 1343.2 |
| 20 |            | 21       | 11.9 | 122.1 | 249   | 388.9 | 547    | 738.8  | 954.4  | 1307.2 |
| 21 |            | 22       | 11.7 | 119.6 | 244.9 | 380.9 | 535.8  | 722.4  | 929.7  | 1272.3 |
| 22 |            | 23       | 11.3 | 117.2 | 239.7 | 373.1 | 524.7  | 705.1  | 906.3  | 1237.6 |
| 23 |            | 24       | 11.1 | 114.8 | 235.6 | 366.3 | 513.7  | 689    | 885    | 1205.2 |
| 24 |            | 25       | 10.8 | 112.6 | 231.5 | 359.7 | 502.9  | 674    | 863.9  | 1174   |
| 25 |            | 26       | 10.5 | 110.5 | 227.5 | 353.1 | 493.2  | 659.1  | 843.9  | 1143.9 |
| 26 |            | 27       | 10.3 | 108.4 | 223.4 | 346.6 | 482.6  | 645.4  | 824.1  | 1114.9 |
| 27 |            | 28       | 10   | 106.3 | 219.5 | 340.2 | 474    | 631.7  | 805.4  | 1087.1 |
| 28 |            | 29       | 9.8  | 104.3 | 215.4 | 334.8 | 464.5  | 618.2  | 786.7  | 1060.3 |
| 29 |            | 30       | 9.6  | 102.5 | 212.5 | 328.4 | 456.1  | 605.7  | 769.1  | 1034.7 |
| 30 |            | 31       | 9.4  | 100.6 | 208.6 | 322.1 | 446.7  | 593.2  | 751.6  | 1009.1 |
| 31 |            | 32       | 9.1  | 98.9  | 205.6 | 316.9 | 439.4  | 580.8  | 735.2  | 983.6  |
| 32 |            | 33       | 8.9  | 97.1  | 201.7 | 312.7 | 431.1  | 569.5  | 719.8  | 960.2  |
| 33 |            | 34       | 8.7  | 95.3  | 198.7 | 307.5 | 422.8  | 558.2  | 703.5  | 937.8  |
| 34 |            | 35       | 8.5  | 93.8  | 195.7 | 301.3 | 415.6  | 546.9  | 688.2  | 916.5  |
| 35 |            | 36       | 8.4  | 92.2  | 192.8 | 297.1 | 408.4  | 536.7  | 674.9  | 894.2  |
| 36 |            | 37       | 8.2  | 90.6  | 189.8 | 293   | 401.3  | 526.5  | 660.7  | 873.9  |
| 37 |            | 38       | 8    | 89    | 186.9 | 286.9 | 394.1  | 516.3  | 646.5  | 853.7  |
| 38 |            | 39       | 7.8  | 87.6  | 183.9 | 282.8 | 388    | 506.2  | 633.3  | 835.5  |
| 39 |            | 40       | 7.6  | 86.2  | 181   | 278.7 | 380.9  | 497    | 620.2  | 816.3  |
| 40 |            | 41       | 7.5  | 84.6  | 177.9 | 273.6 | 374.8  | 487.9  | 608    | 798.2  |
| 41 |            | 42       | 7.3  | 83.3  | 175   | 270.5 | 368.7  | 478.8  | 594.9  | 780    |
| 42 |            | 43       | 7.2  | 82    | 173   | 266.5 | 361.6  | 469.7  | 583.8  | 762.9  |
| 43 |            | 44       | 7    | 80.6  | 170   | 261.4 | 355.5  | 461.6  | 571.7  | 745.8  |
| 44 |            | 45       | 6.9  | 79.3  | 168.1 | 258.4 | 350.5  | 452.5  | 560.6  | 730.7  |
| 45 |            | 46       | 6.7  | 78    | 165.4 | 254.3 | 345.4  | 445.5  | 550.6  | 715.6  |
| 46 |            | 47       | 6.6  | 76.8  | 163   | 250.3 | 339.4  | 437.4  | 539.5  | 699.6  |
| 47 |            | 48       | 6.4  | 75.6  | 160.7 | 247.3 | 333.3  | 429.4  | 529.4  | 685.5  |
| 48 |            | 49       | 6.3  | 74.5  | 158.5 | 243.2 | 328.3  | 422.3  | 520.4  | 671.4  |
| 49 |            | 50       | 6.2  | 73.3  | 156.2 | 239.2 | 323.3  | 415.3  | 510.3  | 656.4  |
| 50 |            | 51       | 6    | 72.1  | 154   | 236.2 | 318.2  | 408.3  | 501.3  | 643.4  |
| 51 |            | 52       | 5.9  | 71.1  | 151.9 | 232.2 | 314.2  | 401.2  | 492.3  | 631.3  |
| 52 |            | 53       | 5.8  | 70    | 149.9 | 229.1 | 309.2  | 395.2  | 482.3  | 617.3  |
| 53 |            | 54       | 5.7  | 68.8  | 147.9 | 227.1 | 304.2  | 388.2  | 473.2  | 605.3  |
| 54 |            | 55       | 5.6  | 67.8  | 145.9 | 223.1 | 300.2  | 381.2  | 466.2  | 594.2  |
| 55 |            | 56       | 5.4  | 66.8  | 144   | 220.1 | 295.1  | 375.2  | 457.2  | 582.2  |
| 56 |            | 57       | 5.3  | 65.9  | 142   | 217.1 | 291.1  | 369.1  | 449.2  | 570.2  |
| 57 |            | 58       | 5.2  | 64.9  | 140.2 | 214.1 | 287.1  | 363.1  | 442.2  | 559.2  |
| 58 |            | 59       | 5.1  | 63.9  | 138.3 | 211.1 | 283.1  | 358.1  | 434.1  | 549.2  |
| 59 |            | 60       | 5    | 63    | 136.6 | 209.1 | 279.1  | 353.1  | 427.1  | 539.2  |
| 60 |            | 61       | 4.9  | 62.1  | 134.7 | 205.6 | 275.1  | 347.1  | 420.1  | 529.1  |
| 61 |            | 62       | 4.8  | 61.2  | 133   | 203.3 | 271.1  | 342.1  | 413.1  | 519.1  |
| 62 |            | 63       | 4.7  | 60.4  | 131.4 | 201   | 267.1  | 337.1  | 406.1  | 509.1  |
| 63 |            | 64       | 4.6  | 59.5  | 129.7 | 197.8 | 264.1  | 332.1  | 399.1  | 500.1  |
| 64 |            | 65       | 4.5  | 58.7  | 128.1 | 195.6 | 260.1  | 326.1  | 393.1  | 491.1  |
| 65 |            | 66       | 4.4  | 57.9  | 126.5 | 193.4 | 257.1  | 322.1  | 386.1  | 482.1  |
| 66 |            | 67       | 4.4  | 57.1  | 125.1 | 190.4 | 253.1  | 317.1  | 381.1  | 474.1  |
| 67 |            | 68       | 4.3  | 56.4  | 123.6 | 188.4 | 249.1  | 313.1  | 374.1  | 466.1  |
| 68 |            | 69       | 4.2  | 55.6  | 122.1 | 186.4 | 247.1  | 308.1  | 369.1  | 458.1  |

PWR DATA TABLES

|     | A            | B   | C    | D     | E     | F     | G     | H     | I     | J     |
|-----|--------------|-----|------|-------|-------|-------|-------|-------|-------|-------|
| 1   | Enrichment   |     |      |       |       |       |       |       |       |       |
| 2   | 2.0 GW-d/MTU |     |      |       |       |       |       |       |       |       |
| 68  | Year         | 1   | 10   | 20    | 30    | 40    | 50    | 60    | 70    | 75    |
| 69  | 70           | 4.1 | 54.8 | 120.6 | 183.5 | 244   | 304.1 | 363.1 | 422.1 | 450.1 |
| 70  | 71           | 4   | 54.1 | 119.2 | 181.6 | 240.2 | 299.1 | 358.1 | 414.1 | 442.1 |
| 71  | 72           | 4   | 53.4 | 117.8 | 179.8 | 236.8 | 295.1 | 352.1 | 407.1 | 435.1 |
| 72  | 73           | 3.9 | 52.7 | 116.5 | 177   | 234.6 | 292.1 | 347.1 | 401.1 | 427.1 |
| 73  | 74           | 3.8 | 52   | 115.1 | 175.2 | 231.4 | 287.1 | 341.1 | 394.1 | 420.1 |
| 74  | 75           | 3.7 | 51.4 | 113.8 | 173.5 | 228.2 | 283.1 | 336.1 | 389.1 | 414.1 |
| 75  | 76           | 3.7 | 50.8 | 112.6 | 171.9 | 225.1 | 280   | 332.1 | 383.1 | 407.1 |
| 76  | 77           | 3.6 | 50.1 | 111.3 | 169.3 | 223.1 | 276   | 327.1 | 376.1 | 401.1 |
| 77  | 78           | 3.5 | 49.5 | 110.1 | 167.7 | 220.1 | 272   | 323.1 | 371.1 | 395.1 |
| 78  | 79           | 3.5 | 48.9 | 108.9 | 166.1 | 217.1 | 268.7 | 318.1 | 365.1 | 388.1 |
| 79  | 80           | 3.4 | 48.3 | 107.7 | 163.6 | 215.2 | 265.4 | 314.1 | 360.1 | 382.1 |
| 80  | 81           | 3.3 | 47.7 | 106.6 | 162.1 | 212.4 | 262.2 | 309.1 | 354.1 | 376.1 |
| 81  | 82           | 3.3 | 47.1 | 105.5 | 160.7 | 210.5 | 259   | 305.1 | 349.1 | 371.1 |
| 82  | 83           | 3.2 | 46.6 | 104.4 | 158.3 | 207.8 | 255.9 | 301.1 | 344.1 | 365.1 |
| 83  | 84           | 3.2 | 46   | 103.3 | 156.9 | 205   | 252.8 | 298.1 | 340.1 | 360.1 |
| 84  | 85           | 3.1 | 45.5 | 102.2 | 155.4 | 203.3 | 249.7 | 293.2 | 335.1 | 354.1 |
| 85  | 86           | 3   | 44.9 | 101.2 | 153.8 | 200.7 | 246.7 | 289.9 | 329.1 | 350.1 |
| 86  | 87           | 3   | 44.4 | 100.2 | 152.2 | 199.1 | 243.8 | 285.6 | 325.1 | 344.1 |
| 87  | 88           | 2.9 | 44   | 99.2  | 150.7 | 196.5 | 240.9 | 282.4 | 320.1 | 339.1 |
| 88  | 89           | 2.9 | 43.5 | 98.2  | 149.2 | 195   | 238.1 | 278.3 | 317.1 | 335.1 |
| 89  | 90           | 2.8 | 43   | 97.3  | 147.8 | 192.5 | 235.2 | 275.2 | 312.8 | 330.1 |
| 90  | 91           | 2.8 | 42.5 | 96.4  | 146.3 | 190   | 232.5 | 272.2 | 308.5 | 326.1 |
| 91  | 92           | 2.7 | 42.1 | 95.4  | 144.9 | 188.6 | 229.8 | 268.2 | 304.2 | 321.5 |
| 92  | 93           | 2.7 | 41.6 | 94.5  | 143.5 | 186.2 | 227.1 | 265.2 | 300   | 317.2 |
| 93  | 94           | 2.6 | 41.2 | 93.7  | 142.2 | 184.8 | 225.4 | 262.3 | 296.9 | 312.9 |
| 94  | 95           | 2.6 | 40.8 | 92.8  | 140.8 | 182.5 | 222.8 | 259.4 | 292.8 | 308.7 |
| 95  | 96           | 2.6 | 40.4 | 92    | 139.5 | 181.2 | 220.3 | 255.6 | 289.7 | 304.6 |
| 96  | 97           | 2.5 | 39.9 | 91.2  | 138.2 | 178.9 | 217.7 | 252.9 | 285.7 | 301.4 |
| 97  | 98           | 2.5 | 39.5 | 90.4  | 137   | 177.6 | 215.2 | 250.1 | 281.7 | 297.4 |
| 98  | 99           | 2.4 | 39.2 | 89.5  | 135.7 | 175.4 | 213.8 | 247.4 | 278.8 | 293.4 |
| 99  | 100          | 2.4 | 38.7 | 88.8  | 134.5 | 174.3 | 211.4 | 244.8 | 276   | 290.4 |
| 100 | 101          | 2.1 | 35.3 | 81.9  | 123.8 | 158.9 | 191.8 | 220.3 | 246.5 | 258.1 |
| 101 | 102          | 1.8 | 32.5 | 76.1  | 114.9 | 147.6 | 176   | 200.8 | 222.5 | 233.3 |
| 102 | 103          | 1.6 | 30.3 | 71.4  | 107.6 | 137.2 | 163.2 | 184.8 | 204.3 | 212.5 |
| 103 | 104          | 1.4 | 28.5 | 67.5  | 101.5 | 129.1 | 152   | 171.7 | 188.2 | 196   |
| 104 | 105          | 1.3 | 26.9 | 64.2  | 96.3  | 122.1 | 143.2 | 161.1 | 175.9 | 182.2 |
| 105 | 106          | 1.2 | 25.6 | 61.5  | 91.9  | 115.9 | 135.3 | 151.6 | 164.9 | 170.9 |
| 106 | 107          | 1.1 | 24.6 | 59.1  | 88.2  | 110.4 | 129.3 | 144.1 | 155.9 | 161.8 |
| 107 | 108          | 1   | 23.7 | 57    | 85    | 106.1 | 123   | 137.4 | 148.8 | 153.4 |
| 108 | 109          | 1   | 22.9 | 55.2  | 82    | 102.3 | 118.1 | 131.2 | 142.3 | 146.9 |
| 109 | 110          | 0.9 | 22.4 | 53.8  | 79.6  | 98.7  | 114.6 | 126.5 | 136.4 | 140.8 |
| 110 | 111          | 0.8 | 20.1 | 48    | 70.2  | 86    | 98.3  | 108   | 115.3 | 118.4 |
| 111 | 112          | 0.8 | 18.6 | 44.1  | 63.8  | 77.5  | 87.7  | 95.5  | 101.7 | 104.8 |
| 112 | 113          | 0.8 | 17.5 | 40.9  | 58.7  | 70.9  | 79.7  | 86.4  | 91.7  | 94    |
| 113 | 114          | 0.7 | 16.5 | 38.2  | 54.5  | 65.4  | 73.3  | 79.2  | 83.9  | 85.9  |
| 114 | 115          | 0.7 | 15.7 | 35.8  | 50.9  | 60.7  | 67.9  | 73.3  | 77.5  | 79.4  |
| 115 | 116          | 0.7 | 14.9 | 33.7  | 47.6  | 56.7  | 63.3  | 68.1  | 72    | 73.7  |
| 116 | 117          | 0.7 | 14.2 | 31.8  | 44.8  | 53.2  | 59.2  | 63.7  | 67.4  | 69    |
| 117 | 118          | 0.7 | 13.6 | 30.1  | 42.2  | 50    | 55.7  | 59.9  | 63.3  | 64.8  |
| 118 | 119          | 0.7 | 13   | 28.5  | 39.8  | 47.1  | 52.5  | 56.4  | 59.7  | 61.1  |
| 119 | 120          | 0.7 | 12.4 | 27    | 37.6  | 44.5  | 49.6  | 53.3  | 56.4  | 57.8  |
| 120 | 121          | 0.7 | 11.9 | 25.6  | 35.6  | 42.2  | 46.9  | 50.5  | 53.5  | 54.8  |
| 121 | 122          | 0.7 | 11.4 | 24.4  | 33.8  | 40    | 44.5  | 47.9  | 50.8  | 52.1  |
| 122 | 123          | 0.7 | 11   | 23.3  | 32.2  | 38    | 42.3  | 45.6  | 48.4  | 49.6  |
| 123 | 124          | 0.7 | 10.6 | 22.2  | 30.6  | 36.2  | 40.3  | 43.4  | 46.1  | 47.4  |
| 124 | 950          | 0.7 | 10.2 | 21.2  | 29.2  | 34.5  | 38.4  | 41.5  | 44.1  | 45.3  |
| 125 | 1000         | 0.7 | 9.9  | 20.3  | 27.9  | 32.9  | 36.7  | 39.6  | 42.2  | 43.3  |

PWR DATA TABLES

|    | A          | B        | C     | D     | E     | F      | G      | H      | I      | J      |
|----|------------|----------|-------|-------|-------|--------|--------|--------|--------|--------|
| 1  | Enrichment |          |       |       |       |        |        |        |        |        |
| 2  | 1.5        | GW-d/MTU |       |       |       |        |        |        |        |        |
| 3  | Year       | 1        | 10    | 20    | 30    | 40     | 50     | 60     | 70     | 75     |
| 4  | 5          | 27.3     | 274.3 | 560.9 | 887.5 | 1248.7 | 1673.4 | 2128   | 2606.3 | 2850.1 |
| 5  | 6          | 22.7     | 227.4 | 467.5 | 749.4 | 1071.4 | 1459.3 | 1881.5 | 2320.6 | 2543.9 |
| 6  | 7          | 20.2     | 200.9 | 412.9 | 665.4 | 959.6  | 1316.8 | 1706.8 | 2124.8 | 2329.8 |
| 7  | 8          | 18.7     | 183.9 | 378   | 610.4 | 884    | 1217.9 | 1584.6 | 1979.9 | 2174.4 |
| 8  | 9          | 17.7     | 173.1 | 354.6 | 571.3 | 827.4  | 1144.1 | 1490.9 | 1863.4 | 2056.6 |
| 9  | 10         | 16.9     | 165.6 | 336.8 | 541.9 | 784.8  | 1084.4 | 1416.4 | 1772.2 | 1959.1 |
| 10 | 11         | 16.3     | 158.4 | 323.3 | 518.3 | 750    | 1036.7 | 1353.9 | 1695.1 | 1865.8 |
| 11 | 12         | 15.7     | 153.4 | 311.2 | 499.1 | 720.9  | 995.8  | 1300.4 | 1627   | 1792.6 |
| 12 | 13         | 15.2     | 148.5 | 301.4 | 481.6 | 695.5  | 960.6  | 1253.7 | 1567.9 | 1730.2 |
| 13 | 14         | 14.7     | 144.8 | 292.9 | 467.4 | 673.6  | 929.1  | 1209.6 | 1513.4 | 1670.6 |
| 14 | 15         | 14.2     | 141.1 | 285.7 | 454.7 | 653.2  | 900.2  | 1171.3 | 1463.7 | 1614.8 |
| 15 | 16         | 13.8     | 137.6 | 278.5 | 442.3 | 635.2  | 872.7  | 1135.4 | 1417.6 | 1562.5 |
| 16 | 17         | 13.4     | 134.2 | 271.6 | 431.1 | 617.7  | 848.6  | 1102   | 1373.9 | 1513.7 |
| 17 | 18         | 13       | 130.9 | 265.9 | 421.2 | 602.3  | 824.9  | 1070.1 | 1333.7 | 1469.4 |
| 18 | 19         | 12.6     | 128.1 | 260.2 | 411.6 | 587.4  | 803.7  | 1040.5 | 1294   | 1426.5 |
| 19 | 20         | 12.4     | 125.4 | 254.7 | 402.2 | 573.5  | 782.6  | 1012.2 | 1258.5 | 1385   |
| 20 | 21         | 12       | 122.9 | 250.3 | 393.9 | 560    | 763.8  | 985.3  | 1223.3 | 1344.8 |
| 21 | 22         | 11.7     | 120.5 | 244.9 | 385.8 | 547.7  | 745.2  | 959.5  | 1190.4 | 1307.9 |
| 22 | 23         | 11.4     | 118.1 | 240.6 | 377.9 | 535.5  | 726.8  | 935.9  | 1157.8 | 1272.2 |
| 23 | 24         | 11.1     | 115.9 | 236.3 | 371   | 524.4  | 709.6  | 911.6  | 1127.4 | 1237.7 |
| 24 | 25         | 10.9     | 113.7 | 232.2 | 363.3 | 512.5  | 693.6  | 888.4  | 1097.1 | 1204.4 |
| 25 | 26         | 10.6     | 111.6 | 228   | 356.6 | 502.7  | 676.7  | 866.4  | 1069   | 1172.2 |
| 26 | 27         | 10.4     | 109.6 | 223.9 | 350.1 | 492    | 661.8  | 845.5  | 1041   | 1141.2 |
| 27 | 28         | 10.1     | 107.6 | 219.8 | 343.6 | 481.4  | 646.1  | 825.7  | 1015.2 | 1112.3 |
| 28 | 29         | 9.9      | 105.7 | 216.7 | 338.1 | 472.9  | 632.5  | 805    | 989.4  | 1083.6 |
| 29 | 30         | 9.6      | 103.9 | 212.7 | 331.8 | 462.4  | 619    | 786.4  | 964.7  | 1055.9 |
| 30 | 31         | 9.4      | 102.1 | 209.6 | 325.4 | 454    | 605.5  | 768.9  | 941.2  | 1029.3 |
| 31 | 32         | 9.2      | 100.4 | 206.5 | 320.1 | 445.6  | 593.1  | 750.4  | 918.7  | 1003.8 |
| 32 | 33         | 9        | 98.8  | 202.5 | 314.9 | 436.3  | 580.7  | 734    | 896.2  | 978.3  |
| 33 | 34         | 8.8      | 97.1  | 199.5 | 309.6 | 429    | 568.4  | 717.6  | 873.8  | 954.9  |
| 34 | 35         | 8.6      | 95.7  | 196.5 | 304.4 | 420.8  | 556.1  | 701.3  | 854.5  | 931.6  |
| 35 | 36         | 8.4      | 94.1  | 193.5 | 299.3 | 413.6  | 545.8  | 686    | 834.2  | 908.3  |
| 36 | 37         | 8.2      | 92.5  | 190.5 | 294.1 | 405.4  | 534.6  | 670.8  | 813.9  | 887    |
| 37 | 38         | 8.1      | 91.1  | 187.5 | 289   | 398.2  | 523.4  | 656.6  | 794.7  | 866.8  |
| 38 | 39         | 7.9      | 89.6  | 185.4 | 284.9 | 391.1  | 513.2  | 642.4  | 776.5  | 845.5  |
| 39 | 40         | 7.7      | 88.2  | 182.4 | 280.8 | 383.9  | 503.1  | 629.2  | 759.3  | 826.4  |
| 40 | 41         | 7.6      | 86.9  | 179.4 | 276.7 | 377.8  | 493    | 615.1  | 742.2  | 807.2  |
| 41 | 42         | 7.4      | 85.5  | 177.4 | 271.6 | 370.7  | 484.9  | 603    | 725    | 788.1  |
| 42 | 43         | 7.2      | 84.3  | 174.4 | 268.5 | 364.7  | 474.8  | 589.8  | 709.9  | 769.9  |
| 43 | 44         | 7.1      | 83.1  | 172.2 | 263.5 | 358.6  | 466.7  | 577.8  | 693.8  | 752.8  |
| 44 | 45         | 6.9      | 81.8  | 169.8 | 259.4 | 352.5  | 457.6  | 566.7  | 678.7  | 736.7  |
| 45 | 46         | 6.8      | 80.5  | 167.5 | 255.4 | 346.5  | 448.5  | 554.6  | 664.6  | 719.7  |
| 46 | 47         | 6.7      | 79.4  | 165.1 | 251.3 | 340.4  | 441.5  | 543.5  | 649.6  | 704.6  |
| 47 | 48         | 6.5      | 78.2  | 162.8 | 248.3 | 335.4  | 433.4  | 533.5  | 636.5  | 688.5  |
| 48 | 49         | 6.4      | 77.2  | 160.6 | 244.3 | 330.3  | 424.4  | 522.4  | 623.5  | 673.5  |
| 49 | 50         | 6.3      | 76    | 158.5 | 241.2 | 325.3  | 417.3  | 512.4  | 610.4  | 659.4  |
| 50 | 51         | 6.1      | 74.9  | 156.3 | 237.2 | 319.3  | 410.3  | 503.3  | 597.4  | 645.4  |
| 51 | 52         | 6        | 73.9  | 154.3 | 234.2 | 314.2  | 403.3  | 493.3  | 585.3  | 632.3  |
| 52 | 53         | 5.9      | 72.9  | 152.2 | 230.2 | 310.2  | 395.2  | 484.3  | 573.3  | 618.3  |
| 53 | 54         | 5.8      | 71.8  | 150.3 | 228.1 | 304.2  | 389.2  | 475.2  | 562.3  | 605.3  |
| 54 | 55         | 5.7      | 70.9  | 148.4 | 224.1 | 300.2  | 382.2  | 466.2  | 550.2  | 593.3  |
| 55 | 56         | 5.5      | 69.8  | 146.4 | 221.1 | 296.2  | 376.2  | 458.2  | 539.2  | 581.2  |
| 56 | 57         | 5.4      | 68.9  | 144.7 | 218.1 | 291.1  | 369.2  | 449.2  | 529.2  | 569.2  |
| 57 | 58         | 5.3      | 67.9  | 142.8 | 216.1 | 287.1  | 364.1  | 441.2  | 519.2  | 558.2  |
| 58 | 59         | 5.2      | 67    | 141.1 | 213.2 | 283.1  | 358.1  | 434.2  | 509.2  | 547.2  |
| 59 | 60         | 5.1      | 66.1  | 139.3 | 209.9 | 279.1  | 352.1  | 425.1  | 500.2  | 536.2  |
| 60 | 61         | 5        | 65.3  | 137.6 | 207.6 | 275.1  | 347.1  | 418.1  | 490.1  | 526.2  |
| 61 | 62         | 4.9      | 64.4  | 135.8 | 204.4 | 271.1  | 340.1  | 410.1  | 481.1  | 515.1  |
| 62 | 63         | 4.8      | 63.6  | 134.2 | 202.2 | 267.1  | 335.1  | 403.1  | 472.1  | 506.1  |
| 63 | 64         | 4.7      | 62.8  | 132.6 | 199.1 | 263.1  | 331.1  | 397.1  | 464.1  | 496.1  |

PWR DATA TABLES

|     | A          | B        | C    | D     | E     | F     | G     | H     | I     | J     |
|-----|------------|----------|------|-------|-------|-------|-------|-------|-------|-------|
| 1   | Enrichment |          |      |       |       |       |       |       |       |       |
| 2   | 1.5        | GW-d/MTU |      |       |       |       |       |       |       |       |
| 3   | Year       | 1        | 10   | 20    | 30    | 40    | 50    | 60    | 70    | 75    |
| 63  | 65         | 4.6      | 62   | 131.1 | 197   | 260.1 | 326.1 | 390.1 | 455.1 | 487.1 |
| 64  | 66         | 4.6      | 61.2 | 129.5 | 195   | 256.1 | 321.1 | 383.1 | 447.1 | 478.1 |
| 65  | 67         | 4.5      | 60.5 | 128   | 192   | 253.1 | 315.1 | 378.1 | 439.1 | 469.1 |
| 66  | 68         | 4.4      | 59.7 | 126.6 | 189.9 | 249.1 | 311.1 | 371.1 | 432.1 | 461.1 |
| 67  | 69         | 4.3      | 59   | 125.2 | 187.1 | 246   | 307.1 | 365.1 | 424.1 | 452.1 |
| 68  | 70         | 4.2      | 58.3 | 123.8 | 185.2 | 242.6 | 302.1 | 360.1 | 416.1 | 444.1 |
| 69  | 71         | 4.1      | 57.6 | 122.4 | 183.4 | 239.4 | 297.1 | 354.1 | 410.1 | 436.1 |
| 70  | 72         | 4.1      | 56.9 | 121.1 | 180.7 | 236.2 | 293.1 | 349.1 | 403.1 | 429.1 |
| 71  | 73         | 4        | 56.2 | 119.7 | 179   | 232.9 | 289.1 | 343.1 | 396.1 | 422.1 |
| 72  | 74         | 3.9      | 55.6 | 118.4 | 176.3 | 230.8 | 285.1 | 338.1 | 389.1 | 414.1 |
| 73  | 75         | 3.9      | 54.9 | 117.1 | 174.7 | 227.7 | 281.1 | 333.1 | 383.1 | 408.1 |
| 74  | 76         | 3.8      | 54.3 | 115.9 | 173.1 | 224.7 | 277.1 | 328.1 | 377.1 | 400.1 |
| 75  | 77         | 3.7      | 53.6 | 114.6 | 170.5 | 221.7 | 274   | 323.1 | 371.1 | 394.1 |
| 76  | 78         | 3.7      | 53.1 | 113.5 | 169   | 218.8 | 269.7 | 318.1 | 365.1 | 388.1 |
| 77  | 79         | 3.6      | 52.5 | 112.3 | 166.5 | 216.9 | 266.4 | 314.1 | 360.1 | 382.1 |
| 78  | 80         | 3.5      | 51.9 | 111.2 | 165.1 | 214.1 | 263.1 | 309.1 | 354.1 | 376.1 |
| 79  | 81         | 3.5      | 51.3 | 110   | 163.7 | 211.3 | 259   | 305.1 | 349.1 | 370.1 |
| 80  | 82         | 3.4      | 50.8 | 108.9 | 161.3 | 208.6 | 255.8 | 300.1 | 343.1 | 364.1 |
| 81  | 83         | 3.3      | 50.3 | 107.9 | 159.9 | 206.9 | 252.8 | 296.9 | 338.1 | 358.1 |
| 82  | 84         | 3.3      | 49.8 | 106.9 | 158.6 | 204.2 | 249.8 | 292.5 | 333.1 | 353.1 |
| 83  | 85         | 3.2      | 49.2 | 105.8 | 156.3 | 201.6 | 246.8 | 288.2 | 328.1 | 347.1 |
| 84  | 86         | 3.2      | 48.7 | 104.8 | 155.1 | 200   | 243.9 | 285   | 323.1 | 342.1 |
| 85  | 87         | 3.1      | 48.2 | 103.8 | 153.9 | 197.5 | 241   | 280.8 | 319.1 | 337.1 |
| 86  | 88         | 3.1      | 47.7 | 102.8 | 151.7 | 194.9 | 237.2 | 276.7 | 315.1 | 332.1 |
| 87  | 89         | 3        | 47.2 | 101.9 | 150.5 | 193.5 | 234.4 | 273.6 | 310.4 | 327.1 |
| 88  | 90         | 3        | 46.8 | 101   | 149.4 | 191   | 231.7 | 269.6 | 306.1 | 323.1 |
| 89  | 91         | 2.9      | 46.3 | 100   | 147.3 | 189.6 | 229   | 266.6 | 301.8 | 318.3 |
| 90  | 92         | 2.9      | 45.9 | 99.1  | 146.2 | 187.2 | 227.3 | 263.7 | 297.6 | 314   |
| 91  | 93         | 2.8      | 45.5 | 98.3  | 145.1 | 184.9 | 224.7 | 259.7 | 293.5 | 309.7 |
| 92  | 94         | 2.8      | 45   | 97.4  | 144.1 | 183.6 | 222.1 | 256.9 | 289.4 | 305.5 |
| 93  | 95         | 2.7      | 44.6 | 96.5  | 142.1 | 181.3 | 219.5 | 254.1 | 286.4 | 301.3 |
| 94  | 96         | 2.7      | 44.2 | 95.7  | 141   | 180.1 | 217   | 250.3 | 282.4 | 297.2 |
| 95  | 97         | 2.7      | 43.7 | 95    | 139.7 | 177.8 | 214.6 | 247.6 | 278.4 | 293.2 |
| 96  | 98         | 2.6      | 43.4 | 94.1  | 138.5 | 176.6 | 212.1 | 244.9 | 275.5 | 289.1 |
| 97  | 99         | 2.6      | 43   | 93.4  | 137.3 | 174.5 | 209.7 | 242.3 | 271.7 | 286.2 |
| 98  | 100        | 2.5      | 42.6 | 92.6  | 136.1 | 173.4 | 208.3 | 239.7 | 268.8 | 282.3 |
| 99  | 110        | 2.2      | 39.2 | 85.8  | 125.4 | 158.4 | 188.3 | 214.6 | 238.9 | 250.4 |
| 100 | 120        | 1.9      | 36.5 | 80.1  | 116.6 | 146.5 | 172.7 | 195.6 | 216.2 | 225.1 |
| 101 | 130        | 1.7      | 34.2 | 75.5  | 109.3 | 136.3 | 160.2 | 179.8 | 197.3 | 205.5 |
| 102 | 140        | 1.5      | 32.4 | 71.5  | 103.4 | 128.4 | 149.3 | 166.9 | 182.5 | 189.2 |
| 103 | 150        | 1.4      | 30.8 | 68.2  | 98.2  | 121.5 | 140.6 | 156.5 | 170.3 | 176.6 |
| 104 | 160        | 1.3      | 29.5 | 65.4  | 93.9  | 115.4 | 132.9 | 148.2 | 160.4 | 165.5 |
| 105 | 170        | 1.2      | 28.5 | 63.1  | 90.1  | 110.1 | 127   | 140.8 | 151.5 | 156.4 |
| 106 | 180        | 1.2      | 27.5 | 61    | 86.9  | 106   | 121.7 | 134.1 | 144.5 | 149.1 |
| 107 | 190        | 1.1      | 26.8 | 59.2  | 84.1  | 102.2 | 116.9 | 128   | 138.1 | 141.6 |
| 108 | 200        | 1.1      | 26   | 57.6  | 81.5  | 98.8  | 112.4 | 123.3 | 132.2 | 136.6 |
| 109 | 250        | 0.9      | 23.5 | 51.6  | 72.1  | 86.3  | 97.4  | 106   | 112.2 | 115.4 |
| 110 | 300        | 0.9      | 21.8 | 47.4  | 65.7  | 77.8  | 87.1  | 94.3  | 100   | 102.8 |
| 111 | 350        | 0.9      | 20.5 | 44    | 60.5  | 71.4  | 79.5  | 85.6  | 90.7  | 92.9  |
| 112 | 400        | 0.9      | 19.4 | 41.1  | 56.1  | 66    | 73.3  | 78.8  | 83.2  | 85.2  |
| 113 | 450        | 0.9      | 18.3 | 38.6  | 52.4  | 61.3  | 67.9  | 73.1  | 77.1  | 78.9  |
| 114 | 500        | 0.9      | 17.4 | 36.3  | 49.1  | 57.3  | 63.4  | 68.1  | 71.8  | 73.5  |
| 115 | 550        | 0.9      | 16.5 | 34.2  | 46.1  | 53.8  | 59.5  | 63.8  | 67.3  | 68.9  |
| 116 | 600        | 0.9      | 15.8 | 32.3  | 43.5  | 50.6  | 55.9  | 60    | 63.3  | 64.9  |
| 117 | 650        | 0.9      | 15   | 30.6  | 41    | 47.7  | 52.7  | 56.6  | 59.8  | 61.2  |
| 118 | 700        | 0.9      | 14.4 | 29    | 38.8  | 45.1  | 49.9  | 53.5  | 56.6  | 58    |
| 119 | 750        | 0.8      | 13.7 | 27.5  | 36.8  | 42.7  | 47.2  | 50.7  | 53.7  | 55    |
| 120 | 800        | 0.8      | 13.2 | 26.2  | 34.9  | 40.6  | 44.9  | 48.2  | 51.1  | 52.4  |
| 121 | 850        | 0.8      | 12.6 | 24.9  | 33.2  | 38.6  | 42.7  | 45.9  | 48.6  | 49.9  |
| 122 | 900        | 0.8      | 12.2 | 23.8  | 31.6  | 36.7  | 40.6  | 43.8  | 46.4  | 47.7  |
| 123 | 950        | 0.8      | 11.7 | 22.7  | 30.1  | 35    | 38.8  | 41.8  | 44.4  | 45.6  |
| 124 | 1000       | 0.8      | 11.3 | 21.7  | 28.8  | 33.4  | 37.1  | 40    | 42.5  | 43.7  |

PWR DATA TABLES

|    | A          | B        | C     | D     | E     | F      | G      | H      | I      | J      |
|----|------------|----------|-------|-------|-------|--------|--------|--------|--------|--------|
| 1  | Enrichment |          |       |       |       |        |        |        |        |        |
| 2  | 1.0        | GW-d/MTU |       |       |       |        |        |        |        |        |
| 3  |            | 1        | 10    | 20    | 30    | 40     | 50     | 60     | 70     | 75     |
| 4  | 5          | 28.6     | 285.1 | 582.2 | 927   | 1306.6 | 1752.5 | 2223   | 2702.5 | 2945.2 |
| 5  | 6          | 23.8     | 233.6 | 481.4 | 781.7 | 1121.2 | 1528.4 | 1958.5 | 2405.7 | 2638.5 |
| 6  | 7          | 21.1     | 204.6 | 422.6 | 692.7 | 1003.4 | 1381   | 1783.1 | 2209.3 | 2413.9 |
| 7  | 8          | 19.5     | 187.1 | 385.7 | 632.8 | 922.9  | 1277.2 | 1656.3 | 2053.8 | 2257   |
| 8  | 9          | 18.3     | 175   | 359.4 | 591.9 | 863.6  | 1198.7 | 1559   | 1939.8 | 2129.7 |
| 9  | 10         | 17.5     | 166.1 | 340.6 | 559.9 | 817.3  | 1136.5 | 1480   | 1846.2 | 2032.9 |
| 10 | 11         | 16.7     | 159.6 | 325.4 | 534.6 | 780    | 1085.3 | 1415.1 | 1765.8 | 1939.2 |
| 11 | 12         | 16       | 154.3 | 313.5 | 513.9 | 750.5  | 1041.9 | 1357.1 | 1691.3 | 1865.7 |
| 12 | 13         | 15.5     | 149.1 | 303.1 | 494.9 | 722.6  | 1003.4 | 1306.1 | 1627.9 | 1790   |
| 13 | 14         | 15       | 144.2 | 294.1 | 480.3 | 698.3  | 969.6  | 1260.8 | 1570.2 | 1728.2 |
| 14 | 15         | 14.5     | 140.5 | 286.3 | 466.2 | 676.6  | 938.3  | 1219.1 | 1517.3 | 1670.2 |
| 15 | 16         | 14       | 136.8 | 278.8 | 453.4 | 657.3  | 909.5  | 1180.1 | 1468   | 1615.7 |
| 16 | 17         | 13.6     | 134.1 | 272.4 | 442   | 638.4  | 882.2  | 1144.5 | 1422.2 | 1564.8 |
| 17 | 18         | 13.2     | 131.1 | 266.2 | 430   | 621.9  | 857.4  | 1110.4 | 1378.8 | 1516.4 |
| 18 | 19         | 12.9     | 128.5 | 260.3 | 420.1 | 605.8  | 833.9  | 1078.6 | 1337.9 | 1470.4 |
| 19 | 20         | 12.5     | 125.8 | 255.4 | 411.5 | 590.8  | 811.7  | 1048.2 | 1298.3 | 1426.7 |
| 20 | 21         | 12.1     | 123.3 | 249.7 | 401.1 | 576.1  | 789.8  | 1019   | 1262.1 | 1384.4 |
| 21 | 22         | 11.9     | 120.9 | 245   | 392.8 | 562.6  | 770.1  | 991.3  | 1226   | 1345.4 |
| 22 | 23         | 11.6     | 118.7 | 240.5 | 384.8 | 549.3  | 750.6  | 964.6  | 1192.4 | 1307.6 |
| 23 | 24         | 11.3     | 116.6 | 236   | 376.8 | 537.2  | 732.3  | 940.2  | 1158.8 | 1271.1 |
| 24 | 25         | 11       | 114.5 | 231.6 | 370   | 525.2  | 714.2  | 915.9  | 1127.5 | 1235.8 |
| 25 | 26         | 10.7     | 112.5 | 228.3 | 362.2 | 513.3  | 697.2  | 891.8  | 1097.3 | 1201.6 |
| 26 | 27         | 10.5     | 110.7 | 223.9 | 354.6 | 502.5  | 680.3  | 868.9  | 1068.3 | 1168.5 |
| 27 | 28         | 10.2     | 108.8 | 220.7 | 348   | 491.8  | 664.5  | 847    | 1040.4 | 1137.6 |
| 28 | 29         | 10       | 107.1 | 216.4 | 342.5 | 482.3  | 648.9  | 826.3  | 1012.7 | 1106.8 |
| 29 | 30         | 9.8      | 105.3 | 213.2 | 336.1 | 471.7  | 634.3  | 805.7  | 986    | 1078.1 |
| 30 | 31         | 9.6      | 103.7 | 210   | 329.7 | 462.3  | 620.7  | 787.1  | 961.4  | 1050.5 |
| 31 | 32         | 9.4      | 102   | 206.9 | 324.4 | 452.9  | 606.3  | 768.6  | 937.8  | 1022.9 |
| 32 | 33         | 9.2      | 100.5 | 203.7 | 318.1 | 443.5  | 592.9  | 750.2  | 913.4  | 996.5  |
| 33 | 34         | 9        | 99    | 200.5 | 312.9 | 435.2  | 579.5  | 731.8  | 891    | 971    |
| 34 | 35         | 8.8      | 97.5  | 197.4 | 307.6 | 427    | 568.2  | 714.5  | 868.6  | 946.7  |
| 35 | 36         | 8.6      | 96    | 194.3 | 302.4 | 417.7  | 555    | 698.2  | 848.3  | 923.4  |
| 36 | 37         | 8.4      | 94.7  | 191.1 | 297.3 | 409.5  | 543.7  | 682.9  | 827    | 900.1  |
| 37 | 38         | 8.2      | 93.3  | 189   | 292.1 | 403.3  | 531.5  | 666.7  | 806.8  | 877.8  |
| 38 | 39         | 8.1      | 92    | 185.9 | 287   | 395.2  | 520.3  | 651.5  | 788.6  | 855.6  |
| 39 | 40         | 7.9      | 90.7  | 182.7 | 282.9 | 388    | 511.2  | 637.3  | 769.4  | 835.4  |
| 40 | 41         | 7.7      | 89.4  | 180.7 | 277.8 | 380.9  | 500    | 623.1  | 751.2  | 816.3  |
| 41 | 42         | 7.6      | 88.2  | 178.2 | 273.7 | 373.8  | 489.9  | 610    | 734.1  | 796.1  |
| 42 | 43         | 7.4      | 87    | 175.6 | 269.6 | 367.7  | 480.8  | 596.9  | 717    | 778    |
| 43 | 44         | 7.3      | 85.8  | 173.3 | 265.5 | 361.6  | 470.7  | 584.8  | 700.9  | 758.9  |
| 44 | 45         | 7.1      | 84.7  | 170.9 | 261.5 | 354.6  | 461.6  | 571.7  | 684.8  | 740.8  |
| 45 | 46         | 7        | 83.5  | 168.6 | 257.4 | 348.5  | 453.6  | 559.6  | 669.7  | 724.7  |
| 46 | 47         | 6.8      | 82.5  | 166.4 | 253.4 | 342.4  | 444.5  | 548.6  | 653.6  | 707.6  |
| 47 | 48         | 6.7      | 81.3  | 164.1 | 250.3 | 336.4  | 435.5  | 536.5  | 639.5  | 691.5  |
| 48 | 49         | 6.6      | 80.2  | 162   | 246.3 | 330.4  | 427.4  | 525.4  | 625.5  | 676.5  |
| 49 | 50         | 6.4      | 79.3  | 159.9 | 242.3 | 326.3  | 419.4  | 515.4  | 611.4  | 661.4  |
| 50 | 51         | 6.3      | 78.2  | 157.9 | 238.2 | 320.3  | 411.3  | 504.4  | 599.4  | 646.4  |
| 51 | 52         | 6.2      | 77.2  | 155.9 | 235.2 | 315.3  | 404.3  | 494.3  | 586.3  | 632.4  |
| 52 | 53         | 6.1      | 76.3  | 153.9 | 232.2 | 309.2  | 397.3  | 484.3  | 573.3  | 618.3  |
| 53 | 54         | 6        | 75.3  | 152   | 228.2 | 305.2  | 390.2  | 475.3  | 561.3  | 605.3  |
| 54 | 55         | 5.8      | 74.4  | 150.2 | 226.2 | 300.2  | 383.2  | 466.2  | 550.3  | 592.3  |
| 55 | 56         | 5.7      | 73.6  | 148.3 | 222.1 | 296.2  | 376.2  | 457.2  | 539.2  | 579.2  |
| 56 | 57         | 5.6      | 72.7  | 146.5 | 218.9 | 291.2  | 369.2  | 448.2  | 528.2  | 567.2  |
| 57 | 58         | 5.5      | 71.7  | 144.8 | 216.5 | 287.1  | 363.2  | 440.2  | 517.2  | 555.2  |
| 58 | 59         | 5.4      | 70.8  | 143.1 | 213.2 | 282.1  | 357.1  | 432.2  | 507.2  | 544.2  |
| 59 | 60         | 5.3      | 70    | 141.3 | 211   | 278.1  | 351.1  | 424.2  | 497.2  | 533.2  |
| 60 | 61         | 5.2      | 69.2  | 139.7 | 207.9 | 273.1  | 345.1  | 416.1  | 487.2  | 523.2  |
| 61 | 62         | 5.1      | 68.4  | 138.1 | 204.7 | 269.1  | 339.1  | 409.1  | 477.1  | 512.1  |
| 62 | 63         | 5.1      | 67.6  | 136.5 | 202.7 | 266.1  | 334.1  | 401.1  | 469.1  | 501.1  |
| 63 | 64         | 5        | 66.8  | 135   | 199.7 | 261.1  | 329.1  | 394.1  | 460.1  | 492.1  |

PWR DATA TABLES

|     | A          | B        | C    | D     | E     | F     | G     | H     | I     | J     |
|-----|------------|----------|------|-------|-------|-------|-------|-------|-------|-------|
| 1   | Enrichment |          |      |       |       |       |       |       |       |       |
| 2   | 1.0        | GW-d/MTU |      |       |       |       |       |       |       |       |
| 3   |            | 1        | 10   | 20    | 30    | 40    | 50    | 60    | 70    | 75    |
| 63  | 65         | 4.9      | 66.1 | 133.3 | 197.7 | 258.1 | 324.1 | 387.1 | 451.1 | 483.1 |
| 64  | 66         | 4.8      | 65.4 | 131.9 | 194.8 | 254.1 | 318.1 | 380.1 | 443.1 | 474.1 |
| 65  | 67         | 4.7      | 64.7 | 130.5 | 192.9 | 251.1 | 313.1 | 374.1 | 434.1 | 464.1 |
| 66  | 68         | 4.6      | 64   | 129   | 190.1 | 247.7 | 308.1 | 368.1 | 426.1 | 455.1 |
| 67  | 69         | 4.5      | 63.3 | 127.7 | 188.3 | 244.5 | 303.1 | 362.1 | 418.1 | 447.1 |
| 68  | 70         | 4.5      | 62.5 | 126.2 | 185.4 | 241.2 | 299.1 | 355.1 | 411.1 | 439.1 |
| 69  | 71         | 4.4      | 61.9 | 125   | 183.7 | 237.1 | 295.1 | 349.1 | 404.1 | 431.1 |
| 70  | 72         | 4.3      | 61.3 | 123.6 | 181.1 | 234   | 290.1 | 344.1 | 397.1 | 422.1 |
| 71  | 73         | 4.2      | 60.6 | 122.4 | 179.4 | 230.9 | 286.1 | 338.1 | 389.1 | 415.1 |
| 72  | 74         | 4.2      | 59.9 | 121.1 | 176.9 | 227.9 | 281.1 | 333.1 | 383.1 | 407.1 |
| 73  | 75         | 4.1      | 59.4 | 119.9 | 175.3 | 225.9 | 277.9 | 328.1 | 377.1 | 401.1 |
| 74  | 76         | 4        | 58.8 | 118.6 | 172.8 | 222.9 | 273.6 | 323.1 | 370.1 | 394.1 |
| 75  | 77         | 4        | 58.2 | 117.5 | 171.3 | 220   | 270.3 | 317.1 | 364.1 | 386.1 |
| 76  | 78         | 3.9      | 57.6 | 116.3 | 168.9 | 217.2 | 266.1 | 313.1 | 358.1 | 380.1 |
| 77  | 79         | 3.8      | 57   | 115.1 | 167.5 | 214.4 | 262.9 | 308.1 | 352.1 | 374.1 |
| 78  | 80         | 3.8      | 56.5 | 114.1 | 165.1 | 211.7 | 258.8 | 304.1 | 347.1 | 368.1 |
| 79  | 81         | 3.7      | 55.9 | 112.9 | 163.8 | 209   | 255.7 | 299.1 | 341.1 | 361.1 |
| 80  | 82         | 3.7      | 55.4 | 111.9 | 162.5 | 206.3 | 252.7 | 294.9 | 336.1 | 355.1 |
| 81  | 83         | 3.6      | 54.9 | 110.8 | 160.2 | 204.7 | 248.7 | 290.6 | 331.1 | 351.1 |
| 82  | 84         | 3.5      | 54.4 | 109.9 | 158.9 | 202.1 | 245.7 | 286.3 | 325.1 | 345.1 |
| 83  | 85         | 3.5      | 53.9 | 108.8 | 156.7 | 199.5 | 242.9 | 282.1 | 321.1 | 339.1 |
| 84  | 86         | 3.4      | 53.5 | 107.9 | 155.5 | 197   | 238.9 | 279   | 315.1 | 334.1 |
| 85  | 87         | 3.4      | 52.9 | 106.9 | 154.4 | 195.5 | 236.1 | 274.9 | 311.1 | 329.1 |
| 86  | 88         | 3.3      | 52.5 | 106   | 152.2 | 193.1 | 233.4 | 270.8 | 306.8 | 324.1 |
| 87  | 89         | 3.3      | 52   | 105   | 151.1 | 190.7 | 230.6 | 267.8 | 302.6 | 319.1 |
| 88  | 90         | 3.2      | 51.6 | 104.2 | 150.1 | 189.3 | 228   | 263.9 | 298.3 | 313.9 |
| 89  | 91         | 3.2      | 51.2 | 103.2 | 148   | 187   | 225.3 | 260   | 294.1 | 309.6 |
| 90  | 92         | 3.1      | 50.7 | 102.4 | 147   | 184.7 | 222.7 | 257.1 | 290   | 305.4 |
| 91  | 93         | 3.1      | 50.3 | 101.5 | 145   | 183.4 | 220.2 | 254.3 | 285.9 | 301.2 |
| 92  | 94         | 3.1      | 49.8 | 100.7 | 144   | 181.1 | 217.6 | 250.5 | 281.9 | 297   |
| 93  | 95         | 3        | 49.5 | 99.8  | 143   | 178.9 | 215.2 | 247.8 | 277.9 | 292.9 |
| 94  | 96         | 3        | 49   | 99.1  | 141.1 | 177.7 | 212.7 | 244.1 | 274   | 288.9 |
| 95  | 97         | 2.9      | 48.7 | 98.3  | 140.2 | 175.6 | 210.3 | 241.4 | 271.1 | 284.9 |
| 96  | 98         | 2.9      | 48.3 | 97.5  | 139.3 | 174.4 | 207.9 | 238.8 | 267.3 | 280.9 |
| 97  | 99         | 2.8      | 47.9 | 96.7  | 137.4 | 172.3 | 205.5 | 236.2 | 263.5 | 277   |
| 98  | 100        | 2.8      | 47.6 | 96    | 136.5 | 170.2 | 203.2 | 232.7 | 260.7 | 273.1 |
| 99  | 110        | 2.5      | 44.2 | 89.3  | 126.2 | 155.7 | 184.6 | 209   | 231.2 | 241.7 |
| 100 | 120        | 2.2      | 41.5 | 83.8  | 117.4 | 144.2 | 168.4 | 189.3 | 209   | 217.8 |
| 101 | 130        | 2        | 39.3 | 79.2  | 110.4 | 134.3 | 156.2 | 174.8 | 190.3 | 197.6 |
| 102 | 140        | 1.8      | 37.5 | 75.4  | 104.4 | 126.6 | 145.5 | 162.1 | 175.7 | 182.4 |
| 103 | 150        | 1.7      | 35.9 | 72.2  | 99.4  | 119.9 | 137   | 151.8 | 163.6 | 170   |
| 104 | 160        | 1.6      | 34.6 | 69.4  | 95.1  | 114   | 130.4 | 143.7 | 153.9 | 159   |
| 105 | 170        | 1.5      | 33.4 | 66.9  | 91.5  | 109.7 | 124.6 | 136.4 | 146.1 | 151   |
| 106 | 180        | 1.4      | 32.5 | 64.9  | 88.3  | 105.2 | 119.4 | 129.8 | 139.2 | 142.9 |
| 107 | 190        | 1.4      | 31.6 | 63.1  | 85.6  | 101.5 | 114.6 | 124.8 | 132.9 | 137.4 |
| 108 | 200        | 1.3      | 30.9 | 61.4  | 83.1  | 98.3  | 110.3 | 120.2 | 128   | 131.4 |
| 109 | 250        | 1.2      | 28.1 | 55.2  | 73.8  | 86.2  | 96.2  | 103.9 | 110.2 | 112.3 |
| 110 | 300        | 1.2      | 26.1 | 50.8  | 67.2  | 78    | 86.5  | 93    | 98.2  | 100.6 |
| 111 | 350        | 1.2      | 24.5 | 47.2  | 62    | 71.8  | 79.2  | 84.9  | 89.6  | 91.6  |
| 112 | 400        | 1.2      | 23.1 | 44.1  | 57.7  | 66.5  | 73.2  | 78.4  | 82.5  | 84.4  |
| 113 | 450        | 1.1      | 21.8 | 41.3  | 53.8  | 61.9  | 68.1  | 72.9  | 76.8  | 78.5  |
| 114 | 500        | 1.1      | 20.7 | 38.9  | 50.5  | 57.9  | 63.7  | 68    | 71.7  | 73.3  |
| 115 | 550        | 1.1      | 19.6 | 36.7  | 47.5  | 54.4  | 59.8  | 63.9  | 67.3  | 68.9  |
| 116 | 600        | 1.1      | 18.6 | 34.6  | 44.7  | 51.2  | 56.3  | 60.2  | 63.4  | 64.9  |
| 117 | 650        | 1.1      | 17.7 | 32.8  | 42.3  | 48.4  | 53.1  | 56.8  | 60    | 61.4  |
| 118 | 700        | 1.1      | 16.9 | 31    | 40    | 45.8  | 50.3  | 53.8  | 56.8  | 58.2  |
| 119 | 750        | 1.1      | 16.2 | 29.5  | 37.9  | 43.4  | 47.7  | 51.1  | 54    | 55.3  |
| 120 | 800        | 1.1      | 15.5 | 28    | 36    | 41.2  | 45.3  | 48.6  | 51.4  | 52.6  |
| 121 | 850        | 1.1      | 14.8 | 26.7  | 34.2  | 39.2  | 43.1  | 46.3  | 49    | 50.2  |
| 122 | 900        | 1.1      | 14.2 | 25.4  | 32.6  | 37.3  | 41.1  | 44.1  | 46.8  | 48    |
| 123 | 950        | 1.1      | 13.7 | 24.3  | 31.1  | 35.6  | 39.3  | 42.2  | 44.7  | 45.9  |
| 124 | 1000       | 1.1      | 13.1 | 23.2  | 29.7  | 34    | 37.5  | 40.4  | 42.9  | 44    |

PWR DATA TABLES

|    | A          | B        | C     | D     | E     | F      | G      | H      | I      | J      |
|----|------------|----------|-------|-------|-------|--------|--------|--------|--------|--------|
| 1  | Enrichment |          |       |       |       |        |        |        |        |        |
| 2  | .07        | GW-d/MTU |       |       |       |        |        |        |        |        |
| 3  |            | 1        | 10    | 20    | 30    | 40     | 50     | 60     | 70     | 75     |
| 4  | 5          | 30       | 292.5 | 594.3 | 954.8 | 1338.6 | 1797.9 | 2266.5 | 2765.2 | 3007.8 |
| 5  | 6          | 24.8     | 237.5 | 489.6 | 803.9 | 1148.6 | 1570.3 | 2007   | 2468.5 | 2691   |
| 6  | 7          | 22       | 206.1 | 427.9 | 711.2 | 1028.2 | 1419.5 | 1829   | 2258.7 | 2466   |
| 7  | 8          | 20.2     | 188.1 | 389.2 | 649.7 | 945.3  | 1313.2 | 1699.8 | 2102.8 | 2306.9 |
| 8  | 9          | 18.9     | 175.7 | 362.2 | 606.3 | 884.6  | 1233.4 | 1599.3 | 1979.6 | 2179.4 |
| 9  | 10         | 18       | 166.7 | 342.8 | 572.9 | 838    | 1169.8 | 1517.9 | 1885.8 | 2072.3 |
| 10 | 11         | 17.2     | 158.9 | 327.1 | 547.2 | 799.3  | 1116.4 | 1449.8 | 1806.2 | 1979.6 |
| 11 | 12         | 16.6     | 153.4 | 314.7 | 525.2 | 766.5  | 1070.7 | 1391.6 | 1724.6 | 1905.8 |
| 12 | 13         | 15.9     | 148.1 | 303.8 | 505.9 | 739.3  | 1031   | 1338.4 | 1663   | 1830   |
| 13 | 14         | 15.3     | 144   | 294.3 | 489.1 | 713.9  | 995    | 1291.9 | 1604.2 | 1768.1 |
| 14 | 15         | 14.8     | 140.2 | 286.2 | 474.7 | 690.9  | 962.5  | 1247.1 | 1550.2 | 1700.9 |
| 15 | 16         | 14.3     | 136.6 | 279.3 | 461.8 | 669.5  | 931.6  | 1207.9 | 1498.7 | 1646.4 |
| 16 | 17         | 13.9     | 133.5 | 272.5 | 449.3 | 651.5  | 903.2  | 1170.3 | 1450.8 | 1594.3 |
| 17 | 18         | 13.4     | 130.5 | 266.2 | 438   | 633.8  | 877.2  | 1135   | 1405.4 | 1543.9 |
| 18 | 19         | 13       | 127.8 | 259.9 | 427   | 616.5  | 852.7  | 1101.2 | 1363.4 | 1496.9 |
| 19 | 20         | 12.7     | 125.2 | 254.8 | 416.3 | 600.5  | 829.3  | 1069.7 | 1322.7 | 1452.1 |
| 20 | 21         | 12.3     | 122.8 | 249.8 | 407.8 | 584.7  | 807.3  | 1039.5 | 1284.4 | 1408.8 |
| 21 | 22         | 12       | 120.5 | 244.9 | 398.5 | 571.1  | 786.6  | 1010.6 | 1246.4 | 1367.8 |
| 22 | 23         | 11.7     | 118.3 | 240.2 | 389.3 | 557.8  | 765    | 984    | 1211.6 | 1327.9 |
| 23 | 24         | 11.4     | 116.3 | 235.5 | 382.3 | 544.6  | 746.7  | 956.5  | 1177.1 | 1290.4 |
| 24 | 25         | 11.1     | 114.3 | 231.9 | 374.4 | 531.5  | 726.5  | 931.2  | 1144.8 | 1254   |
| 25 | 26         | 10.9     | 112.5 | 227.3 | 365.6 | 520.6  | 709.5  | 907.1  | 1113.6 | 1218.7 |
| 26 | 27         | 10.6     | 110.7 | 223.9 | 358.9 | 507.8  | 691.5  | 884.1  | 1083.5 | 1185.7 |
| 27 | 28         | 10.4     | 108.9 | 219.5 | 352.3 | 497.1  | 674.7  | 861.2  | 1054.6 | 1152.7 |
| 28 | 29         | 10.1     | 107.2 | 216.1 | 345.8 | 486.5  | 659    | 839.5  | 1025.8 | 1120.9 |
| 29 | 30         | 9.9      | 105.6 | 212.7 | 338.3 | 475.9  | 644.4  | 817.8  | 999.1  | 1091.2 |
| 30 | 31         | 9.7      | 104   | 209.4 | 332.9 | 465.4  | 628.9  | 797.2  | 973.5  | 1062.6 |
| 31 | 32         | 9.5      | 102.6 | 206   | 325.6 | 457    | 614.4  | 777.7  | 947.9  | 1034   |
| 32 | 33         | 9.3      | 101.1 | 202.8 | 320.3 | 446.7  | 600    | 758.3  | 923.5  | 1007.5 |
| 33 | 34         | 9.1      | 99.7  | 199.6 | 315   | 438.3  | 587.6  | 740.9  | 900    | 980.1  |
| 34 | 35         | 8.9      | 98.3  | 196.3 | 309.7 | 429.1  | 573.3  | 722.5  | 877.7  | 955.7  |
| 35 | 36         | 8.7      | 96.9  | 194.1 | 303.5 | 420.8  | 561    | 706.2  | 855.4  | 931.4  |
| 36 | 37         | 8.5      | 95.6  | 190.8 | 298.4 | 412.6  | 548.8  | 689    | 834.1  | 907.1  |
| 37 | 38         | 8.4      | 94.2  | 188.7 | 294.2 | 404.4  | 536.6  | 672.7  | 813.8  | 884.9  |
| 38 | 39         | 8.2      | 93.1  | 185.5 | 289   | 397.2  | 526.4  | 657.5  | 793.6  | 862.6  |
| 39 | 40         | 8        | 91.8  | 183.1 | 284.9 | 389.1  | 514.2  | 642.3  | 775.4  | 841.5  |
| 40 | 41         | 7.9      | 90.6  | 180.5 | 278.8 | 382    | 504.1  | 628.2  | 755.3  | 820.3  |
| 41 | 42         | 7.7      | 89.4  | 177.9 | 274.7 | 375.9  | 493    | 614    | 738.1  | 801.1  |
| 42 | 43         | 7.6      | 88.3  | 175.6 | 270.6 | 367.8  | 482.9  | 599.9  | 720    | 782    |
| 43 | 44         | 7.4      | 87.2  | 173.2 | 265.6 | 361.7  | 472.8  | 587.8  | 703.9  | 761.9  |
| 44 | 45         | 7.3      | 86.1  | 170.9 | 261.5 | 354.6  | 463.7  | 574.7  | 686.8  | 744.8  |
| 45 | 46         | 7.2      | 85.1  | 168.6 | 257.4 | 349.5  | 454.6  | 561.6  | 671.7  | 726.7  |
| 46 | 47         | 7        | 84.1  | 166.4 | 253.4 | 342.5  | 445.5  | 549.6  | 656.6  | 709.6  |
| 47 | 48         | 6.9      | 83    | 164.3 | 249.3 | 336.4  | 437.5  | 538.5  | 641.5  | 693.6  |
| 48 | 49         | 6.8      | 82    | 162.1 | 246.3 | 330.4  | 428.4  | 526.5  | 627.5  | 677.5  |
| 49 | 50         | 6.6      | 81    | 160   | 243.3 | 325.3  | 420.4  | 515.4  | 613.4  | 661.5  |
| 50 | 51         | 6.5      | 80.1  | 158.1 | 239.2 | 320.3  | 412.3  | 504.4  | 599.4  | 646.4  |
| 51 | 52         | 6.4      | 79.1  | 156.1 | 236.2 | 314.3  | 405.3  | 495.3  | 586.4  | 632.4  |
| 52 | 53         | 6.3      | 78.3  | 154.2 | 232.2 | 309.2  | 397.3  | 485.3  | 574.3  | 618.3  |
| 53 | 54         | 6.2      | 77.3  | 152.2 | 229.2 | 304.2  | 390.2  | 474.3  | 561.3  | 604.3  |
| 54 | 55         | 6.1      | 76.4  | 150.4 | 225.2 | 299.2  | 383.2  | 465.2  | 549.3  | 591.3  |
| 55 | 56         | 6        | 75.7  | 148.7 | 222.8 | 295.2  | 375.2  | 457.2  | 537.2  | 579.2  |
| 56 | 57         | 5.9      | 74.8  | 146.9 | 219.5 | 290.2  | 369.2  | 447.2  | 526.2  | 566.2  |
| 57 | 58         | 5.8      | 74    | 145.1 | 216.3 | 285.1  | 362.2  | 439.2  | 516.2  | 554.2  |
| 58 | 59         | 5.7      | 73.1  | 143.5 | 213.1 | 281.1  | 356.2  | 430.2  | 505.2  | 543.2  |
| 59 | 60         | 5.6      | 72.3  | 141.8 | 210.9 | 276.1  | 350.1  | 422.2  | 495.2  | 531.2  |
| 60 | 61         | 5.5      | 71.5  | 140.2 | 207.8 | 272.1  | 344.1  | 414.1  | 485.2  | 520.2  |
| 61 | 62         | 5.4      | 70.7  | 138.7 | 204.8 | 268.1  | 338.1  | 407.1  | 475.1  | 510.2  |
| 62 | 63         | 5.3      | 70    | 137.1 | 202.8 | 265.1  | 333.1  | 399.1  | 466.1  | 499.1  |
| 63 | 64         | 5.2      | 69.3  | 135.6 | 199.9 | 260.1  | 327.1  | 392.1  | 457.1  | 489.1  |

PWR DATA TABLES

|     | A          | B        | C    | D     | E     | F     | G     | H     | I     | J     |
|-----|------------|----------|------|-------|-------|-------|-------|-------|-------|-------|
| 1   | Enrichment |          |      |       |       |       |       |       |       |       |
| 2   | .07        | GW-d/MTU |      |       |       |       |       |       |       |       |
| 3   |            | 1        | 10   | 20    | 30    | 40    | 50    | 60    | 70    | 75    |
| 63  | 65         | 5.1      | 68.6 | 134.1 | 197   | 257.1 | 322.1 | 385.1 | 448.1 | 479.1 |
| 64  | 66         | 5        | 67.9 | 132.6 | 195.1 | 252.4 | 317.1 | 379.1 | 440.1 | 470.1 |
| 65  | 67         | 5        | 67.2 | 131.1 | 192.3 | 249   | 311.1 | 371.1 | 431.1 | 461.1 |
| 66  | 68         | 4.9      | 66.5 | 129.7 | 189.5 | 245.8 | 306.1 | 365.1 | 423.1 | 452.1 |
| 67  | 69         | 4.8      | 65.8 | 128.3 | 187.8 | 242.6 | 301.1 | 359.1 | 416.1 | 443.1 |
| 68  | 70         | 4.7      | 65.2 | 127.1 | 185.1 | 238.4 | 297.1 | 353.1 | 407.1 | 435.1 |
| 69  | 71         | 4.7      | 64.6 | 125.7 | 183.5 | 235.3 | 292.1 | 347.1 | 400.1 | 426.1 |
| 70  | 72         | 4.6      | 63.9 | 124.4 | 180.8 | 232.3 | 288.1 | 341.1 | 393.1 | 419.1 |
| 71  | 73         | 4.5      | 63.3 | 123.2 | 179.2 | 229.3 | 283.1 | 335.1 | 386.1 | 411.1 |
| 72  | 74         | 4.4      | 62.7 | 122   | 176.7 | 226.4 | 278.9 | 330.1 | 379.1 | 404.1 |
| 73  | 75         | 4.4      | 62.2 | 120.8 | 175.2 | 223.4 | 275.6 | 324.1 | 373.1 | 397.1 |
| 74  | 76         | 4.3      | 61.6 | 119.6 | 172.7 | 220.6 | 271.3 | 320.1 | 367.1 | 389.1 |
| 75  | 77         | 4.2      | 61   | 118.4 | 171.3 | 217.8 | 267.1 | 314.1 | 360.1 | 382.1 |
| 76  | 78         | 4.2      | 60.5 | 117.3 | 168.9 | 215   | 263.9 | 309.1 | 354.1 | 376.1 |
| 77  | 79         | 4.1      | 59.9 | 116.2 | 167.6 | 212.2 | 259.8 | 305.1 | 348.1 | 369.1 |
| 78  | 80         | 4.1      | 59.4 | 115.1 | 165.2 | 209.5 | 256.7 | 300.1 | 342.1 | 363.1 |
| 79  | 81         | 4        | 58.8 | 114.1 | 163.9 | 206.8 | 252.7 | 295.3 | 336.1 | 357.1 |
| 80  | 82         | 4        | 58.4 | 113   | 161.7 | 204.2 | 249.7 | 291   | 332.1 | 351.1 |
| 81  | 83         | 3.9      | 57.9 | 112   | 160.4 | 202.6 | 245.8 | 286.7 | 326.1 | 346.1 |
| 82  | 84         | 3.8      | 57.4 | 110.9 | 158.2 | 200.1 | 242.9 | 282.5 | 321.1 | 340.1 |
| 83  | 85         | 3.8      | 56.9 | 110   | 157.1 | 197.6 | 240   | 278.3 | 316.1 | 334.1 |
| 84  | 86         | 3.7      | 56.4 | 109   | 154.9 | 195.1 | 236.2 | 274.2 | 311.1 | 329.1 |
| 85  | 87         | 3.7      | 56   | 108.1 | 153.8 | 192.7 | 233.5 | 271.2 | 306.5 | 323.1 |
| 86  | 88         | 3.6      | 55.6 | 107.2 | 152.7 | 191.3 | 230.8 | 267.1 | 302.2 | 319.1 |
| 87  | 89         | 3.6      | 55.1 | 106.3 | 150.6 | 189   | 228.1 | 263.2 | 297.9 | 313.7 |
| 88  | 90         | 3.5      | 54.7 | 105.4 | 149.6 | 186.6 | 225.4 | 260.3 | 292.7 | 309.4 |
| 89  | 91         | 3.5      | 54.2 | 104.6 | 147.6 | 184.3 | 221.8 | 256.4 | 288.6 | 305.1 |
| 90  | 92         | 3.4      | 53.8 | 103.7 | 146.6 | 183   | 219.2 | 252.6 | 284.5 | 299.9 |
| 91  | 93         | 3.4      | 53.4 | 102.8 | 145.6 | 180.8 | 216.7 | 249.8 | 280.5 | 295.7 |
| 92  | 94         | 3.4      | 53   | 102.1 | 143.6 | 178.6 | 214.2 | 246   | 276.5 | 291.6 |
| 93  | 95         | 3.3      | 52.6 | 101.2 | 142.7 | 177.4 | 211.7 | 243.3 | 273.5 | 287.5 |
| 94  | 96         | 3.3      | 52.3 | 100.5 | 140.8 | 175.3 | 209.3 | 240.7 | 269.6 | 283.5 |
| 95  | 97         | 3.2      | 51.8 | 99.7  | 139.9 | 174.1 | 206.9 | 237   | 265.8 | 279.5 |
| 96  | 98         | 3.2      | 51.5 | 98.9  | 139.1 | 172   | 204.6 | 234.5 | 262   | 275.6 |
| 97  | 99         | 3.2      | 51.1 | 98.2  | 137.2 | 170   | 202.3 | 231.9 | 259.2 | 271.7 |
| 98  | 100        | 3.1      | 50.8 | 97.4  | 136.4 | 168.9 | 200   | 229.4 | 255.5 | 267.9 |
| 99  | 110        | 2.8      | 47.5 | 91    | 126.1 | 153.7 | 181.6 | 205.1 | 226.3 | 236.8 |
| 100 | 120        | 2.5      | 44.9 | 85.5  | 117.5 | 142.4 | 165.7 | 185.5 | 204.3 | 212   |
| 101 | 130        | 2.3      | 42.7 | 81    | 110.5 | 132.6 | 153.6 | 170.2 | 185.8 | 193   |
| 102 | 140        | 2.2      | 40.8 | 77.3  | 104.7 | 125.1 | 143   | 158.7 | 171.2 | 178   |
| 103 | 150        | 2        | 39.3 | 74.1  | 99.8  | 118.5 | 134.6 | 148.5 | 160.3 | 165.6 |
| 104 | 160        | 1.9      | 38   | 71.3  | 95.6  | 112.7 | 128.1 | 140.4 | 150.6 | 155.7 |
| 105 | 170        | 1.8      | 36.8 | 68.9  | 92    | 108.3 | 122.4 | 133.2 | 142.9 | 146.8 |
| 106 | 180        | 1.8      | 35.8 | 66.9  | 88.8  | 104.3 | 117.2 | 127.7 | 136   | 139.7 |
| 107 | 190        | 1.7      | 34.9 | 65    | 86.1  | 100.7 | 112.5 | 122.6 | 130.7 | 134.3 |
| 108 | 200        | 1.7      | 34.2 | 63.4  | 83.7  | 97.6  | 109.1 | 118   | 125.9 | 129.3 |
| 109 | 250        | 1.6      | 31.2 | 57.2  | 74.5  | 86    | 95.3  | 102.9 | 108.2 | 111.3 |
| 110 | 300        | 1.5      | 29   | 52.6  | 68    | 78    | 86.1  | 92.2  | 97.1  | 99.3  |
| 111 | 350        | 1.5      | 27.2 | 49    | 62.9  | 71.9  | 79    | 84.4  | 88.8  | 90.8  |
| 112 | 400        | 1.5      | 25.6 | 45.7  | 58.6  | 66.7  | 73.2  | 78.1  | 82.1  | 83.9  |
| 113 | 450        | 1.4      | 24.2 | 42.9  | 54.7  | 62.2  | 68.1  | 72.8  | 76.5  | 78.2  |
| 114 | 500        | 1.4      | 22.9 | 40.4  | 51.3  | 58.3  | 63.8  | 68    | 71.6  | 73.2  |
| 115 | 550        | 1.4      | 21.7 | 38    | 48.3  | 54.8  | 60    | 64    | 67.3  | 68.8  |
| 116 | 600        | 1.4      | 20.6 | 35.9  | 45.5  | 51.6  | 56.5  | 60.3  | 63.5  | 65    |
| 117 | 650        | 1.4      | 19.6 | 34    | 43    | 48.7  | 53.4  | 57    | 60.1  | 61.5  |
| 118 | 700        | 1.4      | 18.7 | 32.2  | 40.7  | 46.1  | 50.6  | 54    | 57    | 58.3  |
| 119 | 750        | 1.4      | 17.8 | 30.6  | 38.6  | 43.7  | 48    | 51.3  | 54.1  | 55.4  |
| 120 | 800        | 1.3      | 17   | 29.1  | 36.6  | 41.6  | 45.6  | 48.8  | 51.5  | 52.8  |
| 121 | 850        | 1.3      | 16.3 | 27.7  | 34.9  | 39.5  | 43.4  | 46.5  | 49.2  | 50.4  |
| 122 | 900        | 1.3      | 15.6 | 26.4  | 33.2  | 37.7  | 41.4  | 44.4  | 47    | 48.2  |
| 123 | 950        | 1.3      | 15   | 25.2  | 31.7  | 36    | 39.6  | 42.4  | 45    | 46.1  |
| 124 | 1000       | 1.3      | 14.4 | 24.1  | 30.3  | 34.4  | 37.8  | 40.6  | 43.1  | 44.2  |



# BWR DATA TABLES

|    | A            | B   | C    | D     | E     | F     | G     | H     | I     | J     |
|----|--------------|-----|------|-------|-------|-------|-------|-------|-------|-------|
| 1  | Enrichment   |     |      |       |       |       |       |       |       |       |
| 2  | 5.5 Gw-d/MTU |     |      |       |       |       |       |       |       |       |
| 3  | Year         | 1   | 10   | 20    | 30    | 40    | 50    | 60    | 70    | 75    |
| 4  | 5            | 9.9 | 92.3 | 177.8 | 265   | 356.3 | 455.8 | 565.4 | 690.1 | 756.9 |
| 5  | 6            | 8.2 | 79.8 | 157.5 | 236.8 | 320.7 | 410.6 | 511.1 | 624.6 | 687.3 |
| 6  | 7            | 7.4 | 72.8 | 145.4 | 219.6 | 297.3 | 381.6 | 475   | 580.3 | 637.9 |
| 7  | 8            | 6.9 | 68.5 | 137.3 | 207.4 | 281   | 359.8 | 448   | 547.1 | 601.7 |
| 8  | 9            | 6.6 | 65.5 | 131.2 | 198.4 | 268.7 | 344.1 | 427.1 | 522.1 | 572.6 |
| 9  | 10           | 6.4 | 63.1 | 126.1 | 191.3 | 258.5 | 331.3 | 410.4 | 501.2 | 550.7 |
| 10 | 11           | 6.2 | 61.2 | 123.2 | 185.3 | 250.4 | 319.8 | 396.7 | 483.5 | 530.8 |
| 11 | 12           | 6   | 59.4 | 119.1 | 180.3 | 243.3 | 311.2 | 385.1 | 467.8 | 514.1 |
| 12 | 13           | 5.8 | 57.8 | 116.1 | 175.3 | 237.1 | 302.7 | 374.3 | 455.2 | 499.5 |
| 13 | 14           | 5.7 | 56.3 | 113.1 | 171.4 | 231.1 | 295.2 | 365.1 | 442.7 | 485   |
| 14 | 15           | 5.5 | 54.9 | 110.4 | 166.4 | 225   | 287.8 | 355.9 | 431.2 | 472.5 |
| 15 | 16           | 5.4 | 53.6 | 107.9 | 163.5 | 220   | 281.4 | 347.8 | 420.8 | 460   |
| 16 | 17           | 5.2 | 52.4 | 105.4 | 159.6 | 215.9 | 275   | 339.7 | 410.5 | 449.7 |
| 17 | 18           | 5.1 | 51.2 | 103.2 | 156.6 | 210.9 | 268.6 | 331.7 | 401.2 | 439.4 |
| 18 | 19           | 5   | 50   | 100.9 | 152.7 | 206.9 | 263.3 | 324.7 | 391.9 | 428.1 |
| 19 | 20           | 4.9 | 48.9 | 98.8  | 149.8 | 202.9 | 257.9 | 317.8 | 384.7 | 418.8 |
| 20 | 21           | 4.8 | 47.8 | 96.8  | 146.9 | 198.9 | 252.7 | 311.8 | 375.5 | 410.6 |
| 21 | 22           | 4.6 | 46.7 | 94.7  | 144   | 194.9 | 248.4 | 304.9 | 367.3 | 400.4 |
| 22 | 23           | 4.5 | 45.7 | 92.8  | 141   | 190.9 | 243.1 | 299.1 | 360.2 | 392.2 |
| 23 | 24           | 4.4 | 44.7 | 90.8  | 138.1 | 186.8 | 238.9 | 293.3 | 352   | 384.1 |
| 24 | 25           | 4.3 | 43.7 | 89    | 135.2 | 183.8 | 233.6 | 287.5 | 345.9 | 376   |
| 25 | 26           | 4.2 | 42.7 | 87.3  | 133.3 | 179.8 | 229.3 | 281.7 | 337.8 | 368.8 |
| 26 | 27           | 4.1 | 41.8 | 85.5  | 130.3 | 176.8 | 225   | 275.9 | 331.7 | 360.7 |
| 27 | 28           | 4   | 40.9 | 83.7  | 127.4 | 173.8 | 220.8 | 271.1 | 324.6 | 353.7 |
| 28 | 29           | 3.9 | 40   | 82.1  | 125.5 | 169.7 | 216.5 | 265.5 | 318.5 | 346.6 |
| 29 | 30           | 3.9 | 39.1 | 80.6  | 123.1 | 166.7 | 212.3 | 260.7 | 311.5 | 339.5 |
| 30 | 31           | 3.8 | 38.3 | 78.8  | 120.8 | 163.8 | 209   | 256.1 | 306.4 | 332.5 |
| 31 | 32           | 3.7 | 37.6 | 77.3  | 118.5 | 160.7 | 204.8 | 251.4 | 300.4 | 325.4 |
| 32 | 33           | 3.6 | 36.8 | 75.9  | 116.4 | 157.6 | 201.4 | 246.7 | 294.3 | 319.4 |
| 33 | 34           | 3.5 | 36   | 74.4  | 114.1 | 155.6 | 197.2 | 242.1 | 288.3 | 313.3 |
| 34 | 35           | 3.4 | 35.3 | 72.9  | 112.1 | 152.6 | 194   | 237.4 | 283.3 | 307.3 |
| 35 | 36           | 3.4 | 34.5 | 71.6  | 110   | 149.5 | 190.8 | 232.8 | 278.2 | 301.2 |
| 36 | 37           | 3.3 | 33.8 | 70.2  | 108.1 | 147.4 | 187.6 | 229.3 | 273.2 | 295.2 |
| 37 | 38           | 3.2 | 33.1 | 68.9  | 106.1 | 144.4 | 184.2 | 224.7 | 268.2 | 290.2 |
| 38 | 39           | 3.1 | 32.4 | 67.6  | 104.2 | 142.4 | 181   | 221   | 262.2 | 284.2 |
| 39 | 40           | 3.1 | 31.7 | 66.2  | 102.3 | 139.5 | 177.8 | 217.5 | 257.1 | 279.2 |
| 40 | 41           | 3   | 31.1 | 65.1  | 100.6 | 137.1 | 174.5 | 212.9 | 253.1 | 274.1 |
| 41 | 42           | 2.9 | 30.4 | 63.8  | 98.8  | 134.7 | 171.3 | 209.4 | 248.1 | 268.1 |
| 42 | 43           | 2.9 | 29.8 | 62.6  | 97    | 132.4 | 169.1 | 205.9 | 244.1 | 264.1 |
| 43 | 44           | 2.8 | 29.2 | 61.4  | 95.3  | 130.2 | 165.9 | 202.3 | 239.1 | 259.1 |
| 44 | 45           | 2.7 | 28.7 | 60.3  | 93.6  | 128   | 162.6 | 198.8 | 235.1 | 255.1 |
| 45 | 46           | 2.7 | 28.1 | 59.2  | 92    | 125.7 | 160.4 | 195.3 | 231.1 | 249.1 |
| 46 | 47           | 2.6 | 27.6 | 58.2  | 90.4  | 123.6 | 157.6 | 192.8 | 227.6 | 245.1 |
| 47 | 48           | 2.6 | 27   | 57.1  | 88.9  | 121.6 | 154.9 | 189.3 | 223.7 | 241.1 |
| 48 | 49           | 2.5 | 26.5 | 56.1  | 87.4  | 119.6 | 152.4 | 185.7 | 219.8 | 237.1 |
| 49 | 50           | 2.4 | 25.9 | 55.1  | 85.9  | 117.6 | 150   | 183.3 | 215.9 | 233.1 |
| 50 | 51           | 2.4 | 25.4 | 54.1  | 84.4  | 115.7 | 147.6 | 179.8 | 212   | 229   |
| 51 | 52           | 2.3 | 24.9 | 53.1  | 83    | 113.8 | 145.1 | 177.3 | 208.2 | 225   |
| 52 | 53           | 2.3 | 24.4 | 52.2  | 81.6  | 111.9 | 142.8 | 174   | 205.4 | 221   |
| 53 | 54           | 2.2 | 24   | 51.2  | 80.3  | 110.2 | 140.6 | 171.1 | 201.6 | 217   |
| 54 | 55           | 2.2 | 23.5 | 50.3  | 78.9  | 108.5 | 138.4 | 168.4 | 197.9 | 214   |
| 55 | 56           | 2.1 | 23   | 49.5  | 77.7  | 106.7 | 136.1 | 165.7 | 195.1 | 210   |
| 56 | 57           | 2.1 | 22.6 | 48.6  | 76.4  | 105.1 | 134   | 163.1 | 192.4 | 206   |
| 57 | 58           | 2.1 | 22.2 | 47.8  | 75.2  | 103.4 | 132   | 160.6 | 188.8 | 202.8 |
|    | 59           | 2   | 21.7 | 47    | 73.9  | 101.8 | 130   | 158.1 | 185.7 | 198.9 |

# BWR DATA TABLES

|     | A            | B   | C    | D    | E    | F     | G     | H     | I     | J     |
|-----|--------------|-----|------|------|------|-------|-------|-------|-------|-------|
| 1   | Enrichment   |     |      |      |      |       |       |       |       |       |
| 2   | 5.5 Gw-d/MTU |     |      |      |      |       |       |       |       |       |
| 58  | 60           | 2   | 21.3 | 46.2 | 72.8 | 100.2 | 127.9 | 155.6 | 182.8 | 196.1 |
| 59  | 61           | 1.9 | 20.9 | 45.4 | 71.7 | 98.7  | 126   | 153.2 | 179.9 | 192.9 |
| 60  | 62           | 1.9 | 20.5 | 44.6 | 70.5 | 97.2  | 124.1 | 150.8 | 177.1 | 189.9 |
| 61  | 63           | 1.8 | 20.1 | 43.8 | 69.4 | 95.7  | 122.2 | 148.5 | 174.3 | 186.8 |
| 62  | 64           | 1.8 | 19.8 | 43.1 | 68.3 | 94.3  | 120.4 | 146.3 | 171.6 | 183.9 |
| 63  | 65           | 1.8 | 19.4 | 42.4 | 67.2 | 92.9  | 118.7 | 144.2 | 169   | 181   |
| 64  | 66           | 1.7 | 19   | 41.7 | 66.2 | 91.5  | 116.8 | 142   | 166.3 | 178.1 |
| 65  | 67           | 1.7 | 18.7 | 41   | 65.2 | 90.2  | 115.1 | 139.9 | 163.8 | 175.4 |
| 66  | 68           | 1.7 | 18.3 | 40.3 | 64.2 | 88.7  | 113.5 | 137.9 | 161.4 | 172.7 |
| 67  | 69           | 1.6 | 18   | 39.7 | 63.2 | 87.5  | 111.9 | 135.9 | 158.9 | 170.1 |
| 68  | 70           | 1.6 | 17.7 | 39.1 | 62.3 | 86.2  | 110.3 | 133.9 | 156.6 | 167.5 |
| 69  | 71           | 1.6 | 17.4 | 38.4 | 61.3 | 85    | 108.7 | 132   | 154.3 | 165   |
| 70  | 72           | 1.5 | 17.1 | 37.8 | 60.5 | 83.8  | 107.2 | 130.1 | 152.1 | 162.5 |
| 71  | 73           | 1.5 | 16.8 | 37.2 | 59.5 | 82.6  | 105.7 | 128.3 | 149.8 | 160.1 |
| 72  | 74           | 1.5 | 16.5 | 36.6 | 58.7 | 81.4  | 104.3 | 126.5 | 147.7 | 157.8 |
| 73  | 75           | 1.4 | 16.2 | 36.1 | 57.8 | 80.3  | 102.8 | 124.7 | 145.6 | 155.5 |
| 74  | 76           | 1.4 | 15.8 | 35.5 | 57   | 79.2  | 101.4 | 123   | 143.5 | 153.3 |
| 75  | 77           | 1.4 | 15.5 | 34.9 | 56.2 | 78.1  | 100   | 121.4 | 141.5 | 151   |
| 76  | 78           | 1.3 | 15.3 | 34.4 | 55.4 | 77.1  | 98.7  | 119.8 | 139.5 | 148.9 |
| 77  | 79           | 1.3 | 15   | 33.9 | 54.6 | 76.1  | 97.4  | 118.1 | 137.6 | 146.8 |
| 78  | 80           | 1.3 | 14.7 | 33.4 | 53.9 | 75.1  | 96.1  | 116.5 | 135.7 | 144.8 |
| 79  | 81           | 1.3 | 14.5 | 32.9 | 53.1 | 74.1  | 94.8  | 115   | 133.9 | 142.8 |
| 80  | 82           | 1.2 | 14.2 | 32.3 | 52.4 | 73    | 93.6  | 113.5 | 132.1 | 140.8 |
| 81  | 83           | 1.2 | 14   | 31.9 | 51.7 | 72.1  | 92.4  | 112   | 130.3 | 138.9 |
| 82  | 84           | 1.2 | 13.8 | 31.4 | 51   | 71.1  | 91.2  | 110.6 | 128.6 | 137   |
| 83  | 85           | 1.2 | 13.6 | 31   | 50.3 | 70.2  | 90    | 109.2 | 126.9 | 135.2 |
| 84  | 86           | 1.1 | 13.3 | 30.6 | 49.7 | 69.3  | 88.9  | 107.8 | 125.3 | 133.4 |
| 85  | 87           | 1.1 | 13.1 | 30.1 | 49   | 68.5  | 87.9  | 106.4 | 123.7 | 131.7 |
| 86  | 88           | 1.1 | 12.9 | 29.7 | 48.4 | 67.6  | 86.8  | 105.1 | 122   | 129.9 |
| 87  | 89           | 1.1 | 12.7 | 29.3 | 47.7 | 66.8  | 85.7  | 103.8 | 120.5 | 128.3 |
| 88  | 90           | 1.1 | 12.5 | 28.9 | 47.2 | 66    | 84.6  | 102.5 | 119   | 126.6 |
| 89  | 91           | 1   | 12.3 | 28.5 | 46.5 | 65.2  | 83.6  | 101.2 | 117.5 | 125   |
| 90  | 92           | 1   | 12.1 | 28   | 46   | 64.4  | 82.6  | 100   | 116.1 | 123.4 |
| 91  | 93           | 1   | 11.9 | 27.7 | 45.4 | 63.6  | 81.7  | 98.9  | 114.6 | 121.9 |
| 92  | 94           | 1   | 11.7 | 27.3 | 44.8 | 62.9  | 80.7  | 97.7  | 113.2 | 120.3 |
| 93  | 95           | 1   | 11.5 | 27   | 44.3 | 62.1  | 79.7  | 96.5  | 111.9 | 118.8 |
| 94  | 96           | 0.9 | 11.4 | 26.5 | 43.7 | 61.4  | 78.8  | 95.4  | 110.5 | 117.4 |
| 95  | 97           | 0.9 | 11.2 | 26.2 | 43.2 | 60.7  | 78    | 94.3  | 109.2 | 116   |
| 96  | 98           | 0.9 | 11   | 25.9 | 42.6 | 60    | 77    | 93.2  | 108   | 114.6 |
| 97  | 99           | 0.9 | 10.8 | 25.6 | 42.2 | 59.4  | 76.2  | 92.2  | 106.7 | 113.3 |
| 98  | 100          | 0.9 | 10.7 | 25.3 | 41.7 | 58.7  | 75.4  | 91.1  | 105.4 | 112   |
| 99  | 110          | 0.7 | 9.2  | 22.3 | 37.3 | 52.7  | 67.7  | 81.9  | 94.4  | 100.1 |
| 100 | 120          | 0.6 | 8.1  | 20   | 33.8 | 47.9  | 61.6  | 74.2  | 85.4  | 90.3  |
| 101 | 130          | 0.5 | 7.2  | 18.2 | 30.9 | 43.9  | 56.5  | 68    | 77.9  | 82.3  |
| 102 | 140          | 0.5 | 6.4  | 16.6 | 28.5 | 40.7  | 52.3  | 62.7  | 71.7  | 75.6  |
| 103 | 150          | 0.4 | 5.9  | 15.4 | 26.5 | 38    | 48.7  | 58.4  | 66.6  | 70    |
| 104 | 160          | 0.4 | 5.4  | 14.4 | 24.9 | 35.7  | 45.7  | 54.7  | 62.2  | 65.3  |
| 105 | 170          | 0.3 | 5    | 13.6 | 23.6 | 33.8  | 43.2  | 51.5  | 58.4  | 61.3  |
| 106 | 180          | 0.3 | 4.7  | 12.9 | 22.5 | 32.2  | 41.1  | 48.8  | 55.2  | 57.7  |
| 107 | 190          | 0.3 | 4.5  | 12.3 | 21.5 | 30.7  | 39.2  | 46.5  | 52.3  | 54.8  |
| 108 | 200          | 0.3 | 4.3  | 11.9 | 20.7 | 29.6  | 37.6  | 44.4  | 49.9  | 52.1  |
| 109 | 250          | 0.2 | 3.6  | 10.2 | 17.9 | 25.3  | 31.8  | 37    | 41    | 42.6  |
| 110 | 300          | 0.2 | 3.4  | 9.3  | 16.2 | 22.6  | 28.1  | 32.4  | 35.4  | 36.6  |
| 111 | 350          | 0.2 | 3.2  | 8.7  | 14.9 | 20.7  | 25.5  | 29    | 31.5  | 32.3  |
| 112 | 400          | 0.2 | 3    | 8.1  | 13.8 | 19.1  | 23.3  | 26.4  | 28.4  | 29.1  |
| 113 | 450          | 0.2 | 2.9  | 7.7  | 13   | 17.7  | 21.6  | 24.3  | 26    | 26.6  |
| 114 | 500          | 0.2 | 2.8  | 7.3  | 12.2 | 16.6  | 20.1  | 22.5  | 24    | 24.5  |
| 115 | 550          | 0.2 | 2.7  | 6.9  | 11.5 | 15.6  | 18.8  | 21    | 22.3  | 22.8  |
| 116 | 600          | 0.2 | 2.6  | 6.6  | 10.8 | 14.6  | 17.6  | 19.6  | 20.9  | 21.3  |
| 117 | 650          | 0.2 | 2.5  | 6.3  | 10.3 | 13.8  | 16.6  | 18.5  | 19.6  | 20    |
| 118 | 700          | 0.2 | 2.4  | 6    | 9.8  | 13.1  | 15.7  | 17.4  | 18.5  | 18.9  |
| 119 | 750          | 0.2 | 2.4  | 5.7  | 9.3  | 12.4  | 14.8  | 16.5  | 17.5  | 17.8  |
| 120 | 800          | 0.2 | 2.3  | 5.5  | 8.8  | 11.8  | 14    | 15.6  | 16.6  | 16.9  |
| 121 | 850          | 0.2 | 2.2  | 5.3  | 8.4  | 11.2  | 13.3  | 14.8  | 15.7  | 16.1  |
| 122 | 900          | 0.2 | 2.2  | 5.1  | 8.1  | 10.7  | 12.7  | 14.1  | 15    | 15.3  |
| 123 | 950          | 0.2 | 2.1  | 4.9  | 7.7  | 10.2  | 12.1  | 13.4  | 14.3  | 14.6  |
| 124 | 1000         | 0.2 | 2.1  | 4.7  | 7.4  | 9.7   | 11.5  | 12.8  | 13.7  | 14    |

# BWR DATA TABLES

|    | A            | B   | C    | D     | E     | F     | G     | H     | I     | J     |
|----|--------------|-----|------|-------|-------|-------|-------|-------|-------|-------|
| 1  | Enrichment   |     |      |       |       |       |       |       |       |       |
| 2  | 5.0 Gw-d/MTU |     |      |       |       |       |       |       |       |       |
| 3  | Year         | 1   | 10   | 20    | 30    | 40    | 50    | 60    | 70    | 75    |
| 4  | 5            | 9.9 | 92.7 | 179.6 | 267.8 | 360.8 | 462.8 | 578.2 | 709.1 | 779   |
| 5  | 6            | 8.2 | 80   | 158.3 | 238.4 | 323.1 | 416.3 | 521.8 | 640.4 | 705.2 |
| 6  | 7            | 7.4 | 73   | 146.2 | 220.2 | 299.6 | 386   | 482.6 | 594   | 654.7 |
| 7  | 8            | 6.9 | 68.7 | 137.1 | 208.1 | 282.3 | 363.9 | 455.5 | 559.7 | 617.3 |
| 8  | 9            | 6.6 | 65.6 | 131.9 | 198.9 | 269.9 | 347   | 434.6 | 533.7 | 587.2 |
| 9  | 10           | 6.4 | 63.2 | 126.9 | 191.9 | 259.6 | 334.1 | 417.8 | 511.7 | 563.2 |
| 10 | 11           | 6.2 | 61.3 | 122.9 | 185.9 | 251.4 | 323.3 | 403.1 | 493.9 | 542.3 |
| 11 | 12           | 6   | 59.5 | 118.8 | 179.9 | 244.2 | 313.6 | 389.5 | 477.2 | 525.5 |
| 12 | 13           | 5.8 | 57.9 | 115.8 | 175.9 | 238   | 304.8 | 378.9 | 462.5 | 509.8 |
| 13 | 14           | 5.7 | 56.4 | 112.9 | 170.9 | 231.9 | 297.2 | 369.4 | 451   | 495.3 |
| 14 | 15           | 5.5 | 55   | 110.6 | 166.9 | 225.8 | 289.6 | 360   | 438.5 | 481.7 |
| 15 | 16           | 5.4 | 53.7 | 108.1 | 163   | 220.6 | 283   | 351.7 | 428.1 | 469.3 |
| 16 | 17           | 5.2 | 52.4 | 105.7 | 160   | 216.5 | 276.6 | 343.3 | 417.7 | 457.9 |
| 17 | 18           | 5.1 | 51.2 | 103.3 | 156.1 | 211.5 | 271   | 336   | 407.4 | 446.5 |
| 18 | 19           | 5   | 50   | 101.2 | 153.2 | 207.4 | 264.6 | 328.8 | 398.1 | 436.2 |
| 19 | 20           | 4.9 | 49   | 99    | 150.2 | 203.4 | 259.1 | 321.6 | 389.8 | 426   |
| 20 | 21           | 4.8 | 47.9 | 96.9  | 147.3 | 199.3 | 254.7 | 314.3 | 381.6 | 416.7 |
| 21 | 22           | 4.6 | 46.8 | 94.9  | 144.4 | 195.2 | 249.3 | 308.1 | 373.4 | 407.5 |
| 22 | 23           | 4.5 | 45.8 | 93    | 141.5 | 191.1 | 243.9 | 302.1 | 365.3 | 398.3 |
| 23 | 24           | 4.4 | 44.8 | 91.1  | 138.5 | 188.2 | 239.5 | 296.1 | 357.1 | 390.2 |
| 24 | 25           | 4.3 | 43.8 | 89.3  | 135.6 | 184.1 | 235.1 | 290   | 350   | 381   |
| 25 | 26           | 4.2 | 42.8 | 87.6  | 133.7 | 181   | 230.7 | 284   | 341.9 | 372.9 |
| 26 | 27           | 4.1 | 41.9 | 85.8  | 130.7 | 177   | 226.4 | 278.1 | 334.8 | 364.8 |
| 27 | 28           | 4   | 41   | 84.1  | 128.8 | 174   | 222.1 | 273.2 | 327.7 | 357.7 |
| 28 | 29           | 3.9 | 40.1 | 82.5  | 126   | 170.9 | 217.7 | 268.2 | 321.6 | 350.6 |
| 29 | 30           | 3.8 | 39.3 | 80.9  | 123.6 | 167.8 | 213.4 | 262.3 | 315.5 | 343.5 |
| 30 | 31           | 3.8 | 38.6 | 79.3  | 121.3 | 164.8 | 210   | 257.5 | 308.5 | 336.5 |
| 31 | 32           | 3.7 | 37.7 | 77.7  | 119.1 | 161.7 | 205.7 | 252.7 | 303.4 | 328.4 |
| 32 | 33           | 3.6 | 36.9 | 76.3  | 117   | 158.6 | 202.4 | 247.9 | 296.4 | 322.4 |
| 33 | 34           | 3.5 | 36.2 | 74.8  | 114.7 | 155.6 | 198   | 243.1 | 291.3 | 315.3 |
| 34 | 35           | 3.4 | 35.4 | 73.4  | 112.7 | 153.6 | 194.8 | 239.3 | 285.3 | 310.3 |
| 35 | 36           | 3.4 | 34.7 | 72    | 110.7 | 150.5 | 191.5 | 234.6 | 280.2 | 304.3 |
| 36 | 37           | 3.3 | 34   | 70.7  | 108.7 | 147.4 | 188.2 | 229.9 | 274.2 | 297.2 |
| 37 | 38           | 3.2 | 33.2 | 69.4  | 106.8 | 145.3 | 184.8 | 226.2 | 269.2 | 291.2 |
| 38 | 39           | 3.1 | 32.6 | 68    | 104.9 | 142.6 | 181.5 | 222.5 | 264.2 | 285.2 |
| 39 | 40           | 3.1 | 32   | 66.8  | 103.1 | 140.2 | 178.2 | 217.7 | 260.2 | 281.2 |
| 40 | 41           | 3   | 31.3 | 65.5  | 101.2 | 137.8 | 174.9 | 214   | 254.1 | 275.1 |
| 41 | 42           | 2.9 | 30.7 | 64.3  | 99.5  | 135.5 | 172.7 | 210.4 | 250.1 | 270.1 |
| 42 | 43           | 2.9 | 30.1 | 63.2  | 97.7  | 133.1 | 169.4 | 206.8 | 245.1 | 265.1 |
| 43 | 44           | 2.8 | 29.5 | 62    | 96    | 130.9 | 166.1 | 203.1 | 241.1 | 260.1 |
| 44 | 45           | 2.7 | 28.9 | 60.9  | 94.3  | 128.7 | 163.8 | 199.5 | 237.1 | 255.1 |
| 45 | 46           | 2.7 | 28.3 | 59.8  | 92.7  | 126.5 | 161.5 | 195.9 | 233.1 | 251.1 |
| 46 | 47           | 2.6 | 27.7 | 58.7  | 91.2  | 124.4 | 158.4 | 193.3 | 228.1 | 245.1 |
| 47 | 48           | 2.6 | 27.2 | 57.6  | 89.6  | 122.4 | 155.7 | 189.8 | 224.1 | 241.1 |
| 48 | 49           | 2.5 | 26.7 | 56.6  | 88.1  | 120.4 | 153.1 | 186.1 | 220.1 | 237.1 |
| 49 | 50           | 2.5 | 26.1 | 55.6  | 86.7  | 118.4 | 150.7 | 183.5 | 216.6 | 232.1 |
| 50 | 51           | 2.4 | 25.6 | 54.6  | 85.2  | 116.5 | 148.2 | 180   | 212.5 | 228   |
| 51 | 52           | 2.3 | 25.1 | 53.7  | 83.8  | 114.6 | 145.8 | 177.2 | 208.6 | 224   |
| 52 | 53           | 2.3 | 24.6 | 52.8  | 82.4  | 112.8 | 143.5 | 174.4 | 205.6 | 221   |
| 53 | 54           | 2.2 | 24.2 | 51.9  | 81.1  | 111   | 141.2 | 171.6 | 201.7 | 217   |
| 54 | 55           | 2.2 | 23.7 | 51    | 79.7  | 109.3 | 138.9 | 168.8 | 198.9 | 213   |
| 55 | 56           | 2.2 | 23.2 | 50    | 78.5  | 107.5 | 136.8 | 166.1 | 195   | 210   |
| 56 | 57           | 2.1 | 22.8 | 49.2  | 77.3  | 105.8 | 134.6 | 163.4 | 191.9 | 206   |
| 57 | 58           | 2.1 | 22.4 | 48.3  | 76    | 104.2 | 132.6 | 160.8 | 188.6 | 202   |
|    | 59           | 2   | 21.9 | 47.5  | 74.8  | 102.6 | 130.5 | 158.3 | 185.6 | 198.5 |

# BWR DATA TABLES

|     | A            | B   | C    | D    | E    | F    | G     | H     | I     | J     |
|-----|--------------|-----|------|------|------|------|-------|-------|-------|-------|
| 1   | Enrichment   |     |      |      |      |      |       |       |       |       |
| 2   | 5.0 Gw-d/MTU |     |      |      |      |      |       |       |       |       |
| 58  | 60           | 2   | 21.5 | 46.7 | 73.7 | 101  | 128.6 | 155.9 | 182.6 | 195.7 |
| 59  | 61           | 1.9 | 21.1 | 46   | 72.5 | 99.5 | 126.6 | 153.4 | 179.7 | 192.5 |
| 60  | 62           | 1.9 | 20.7 | 45.2 | 71.4 | 98   | 124.7 | 151   | 176.7 | 189.3 |
| 61  | 63           | 1.9 | 20.4 | 44.5 | 70.2 | 96.6 | 122.8 | 148.8 | 174   | 186.2 |
| 62  | 64           | 1.8 | 20   | 43.8 | 69.2 | 95.1 | 121   | 146.6 | 171.2 | 183.2 |
| 63  | 65           | 1.8 | 19.6 | 43.1 | 68.1 | 93.7 | 119.3 | 144.3 | 168.6 | 180.2 |
| 64  | 66           | 1.7 | 19.3 | 42.4 | 67.1 | 92.3 | 117.5 | 142.2 | 165.9 | 177.4 |
| 65  | 67           | 1.7 | 18.9 | 41.6 | 66.1 | 91   | 115.8 | 140.1 | 163.4 | 174.6 |
| 66  | 68           | 1.7 | 18.6 | 41   | 65.1 | 89.7 | 114.1 | 138   | 160.8 | 171.9 |
| 67  | 69           | 1.6 | 18.3 | 40.3 | 64.2 | 88.4 | 112.5 | 135.9 | 158.4 | 169.2 |
| 68  | 70           | 1.6 | 17.9 | 39.7 | 63.2 | 87.1 | 110.9 | 134   | 156.1 | 166.6 |
| 69  | 71           | 1.6 | 17.6 | 39.1 | 62.3 | 85.9 | 109.4 | 132.1 | 153.7 | 164   |
| 70  | 72           | 1.5 | 17.3 | 38.5 | 61.4 | 84.7 | 107.8 | 130.2 | 151.4 | 161.6 |
| 71  | 73           | 1.5 | 17   | 37.9 | 60.5 | 83.5 | 106.3 | 128.4 | 149.2 | 159.2 |
| 72  | 74           | 1.5 | 16.7 | 37.3 | 59.6 | 82.4 | 104.8 | 126.5 | 147   | 156.7 |
| 73  | 75           | 1.4 | 16.4 | 36.7 | 58.8 | 81.3 | 103.4 | 124.7 | 145   | 154.4 |
| 74  | 76           | 1.4 | 16.1 | 36.2 | 57.9 | 80.1 | 101.9 | 123.1 | 142.8 | 152.2 |
| 75  | 77           | 1.4 | 15.9 | 35.7 | 57.1 | 79   | 100.6 | 121.4 | 140.8 | 150   |
| 76  | 78           | 1.4 | 15.6 | 35.1 | 56.4 | 78   | 99.3  | 119.7 | 138.8 | 147.8 |
| 77  | 79           | 1.3 | 15.3 | 34.5 | 55.5 | 76.9 | 98    | 118.1 | 136.9 | 145.7 |
| 78  | 80           | 1.3 | 15.1 | 34.1 | 54.8 | 75.9 | 96.7  | 116.5 | 134.9 | 143.6 |
| 79  | 81           | 1.3 | 14.8 | 33.6 | 54   | 75   | 95.4  | 115   | 133.1 | 141.6 |
| 80  | 82           | 1.2 | 14.6 | 33.1 | 53.4 | 73.9 | 94.2  | 113.5 | 131.3 | 139.6 |
| 81  | 83           | 1.2 | 14.3 | 32.7 | 52.6 | 73   | 93    | 111.9 | 129.5 | 137.7 |
| 82  | 84           | 1.2 | 14.1 | 32.1 | 52   | 72.1 | 91.8  | 110.5 | 127.8 | 135.8 |
| 83  | 85           | 1.2 | 13.9 | 31.7 | 51.3 | 71.2 | 90.7  | 109.1 | 126   | 133.9 |
| 84  | 86           | 1.1 | 13.6 | 31.3 | 50.6 | 70.3 | 89.4  | 107.8 | 124.5 | 132.1 |
| 85  | 87           | 1.1 | 13.4 | 30.9 | 50   | 69.4 | 88.3  | 106.3 | 122.8 | 130.4 |
| 86  | 88           | 1.1 | 13.2 | 30.3 | 49.3 | 68.6 | 87.3  | 105   | 121.3 | 128.7 |
| 87  | 89           | 1.1 | 13   | 30   | 48.7 | 67.7 | 86.3  | 103.7 | 119.7 | 126.9 |
| 88  | 90           | 1.1 | 12.8 | 29.6 | 48.1 | 66.8 | 85.2  | 102.4 | 118.2 | 125.3 |
| 89  | 91           | 1   | 12.6 | 29.2 | 47.5 | 66.1 | 84.2  | 101.2 | 116.6 | 123.7 |
| 90  | 92           | 1   | 12.4 | 28.8 | 46.9 | 65.3 | 83.2  | 100   | 115.2 | 122.1 |
| 91  | 93           | 1   | 12.2 | 28.4 | 46.3 | 64.5 | 82.2  | 98.8  | 113.8 | 120.6 |
| 92  | 94           | 1   | 12   | 28   | 45.8 | 63.8 | 81.2  | 97.6  | 112.4 | 119   |
| 93  | 95           | 1   | 11.8 | 27.7 | 45.2 | 63.1 | 80.3  | 96.4  | 110.9 | 117.5 |
| 94  | 96           | 0.9 | 11.6 | 27.4 | 44.7 | 62.3 | 79.4  | 95.4  | 109.6 | 116.1 |
| 95  | 97           | 0.9 | 11.5 | 26.9 | 44.1 | 61.6 | 78.4  | 94.3  | 108.3 | 114.7 |
| 96  | 98           | 0.9 | 11.3 | 26.6 | 43.7 | 60.9 | 77.7  | 93.2  | 107.1 | 113.4 |
| 97  | 99           | 0.9 | 11.1 | 26.3 | 43.1 | 60.2 | 76.8  | 92.1  | 105.8 | 111.9 |
| 98  | 100          | 0.9 | 11   | 26   | 42.6 | 59.5 | 75.9  | 91    | 104.6 | 110.6 |
| 99  | 110          | 0.7 | 9.5  | 23   | 38.3 | 53.6 | 68.3  | 81.8  | 93.6  | 98.7  |
| 100 | 120          | 0.6 | 8.4  | 20.8 | 34.7 | 48.8 | 62.1  | 74.2  | 84.6  | 89    |
| 101 | 130          | 0.5 | 7.5  | 18.9 | 31.8 | 44.8 | 57    | 67.9  | 77.1  | 81.1  |
| 102 | 140          | 0.5 | 6.7  | 17.3 | 29.4 | 41.5 | 52.7  | 62.6  | 71    | 74.4  |
| 103 | 150          | 0.4 | 6.2  | 16.1 | 27.5 | 38.8 | 49.2  | 58.4  | 65.8  | 68.9  |
| 104 | 160          | 0.4 | 5.7  | 15.1 | 25.8 | 36.5 | 46.2  | 54.6  | 61.4  | 64.2  |
| 105 | 170          | 0.3 | 5.3  | 14.3 | 24.5 | 34.6 | 43.7  | 51.5  | 57.7  | 60.2  |
| 106 | 180          | 0.3 | 5    | 13.6 | 23.4 | 32.9 | 41.5  | 48.7  | 54.5  | 56.8  |
| 107 | 190          | 0.3 | 4.8  | 13   | 22.4 | 31.5 | 39.7  | 46.4  | 51.7  | 53.8  |
| 108 | 200          | 0.3 | 4.5  | 12.5 | 21.6 | 30.3 | 38    | 44.4  | 49.3  | 51.3  |
| 109 | 250          | 0.2 | 3.9  | 10.9 | 18.6 | 26   | 32.2  | 37    | 40.5  | 41.9  |
| 110 | 300          | 0.2 | 3.6  | 9.9  | 16.9 | 23.2 | 28.4  | 32.3  | 35    | 36    |
| 111 | 350          | 0.2 | 3.4  | 9.2  | 15.6 | 21.2 | 25.7  | 28.9  | 31.1  | 31.8  |
| 112 | 400          | 0.2 | 3.2  | 8.6  | 14.4 | 19.5 | 23.5  | 26.3  | 28    | 28.7  |
| 113 | 450          | 0.2 | 3.1  | 8.1  | 13.5 | 18.2 | 21.8  | 24.2  | 25.7  | 26.2  |
| 114 | 500          | 0.2 | 3    | 7.7  | 12.7 | 17   | 20.2  | 22.4  | 23.7  | 24.2  |
| 115 | 550          | 0.2 | 2.9  | 7.3  | 12   | 15.9 | 18.9  | 20.9  | 22.1  | 22.5  |
| 116 | 600          | 0.2 | 2.8  | 7    | 11.3 | 15   | 17.8  | 19.6  | 20.7  | 21.1  |
| 117 | 650          | 0.2 | 2.7  | 6.6  | 10.7 | 14.2 | 16.7  | 18.4  | 19.4  | 19.8  |
| 118 | 700          | 0.2 | 2.6  | 6.3  | 10.1 | 13.4 | 15.8  | 17.4  | 18.3  | 18.7  |
| 119 | 750          | 0.2 | 2.5  | 6    | 9.6  | 12.7 | 14.9  | 16.4  | 17.3  | 17.7  |
| 120 | 800          | 0.2 | 2.4  | 5.8  | 9.2  | 12   | 14.2  | 15.6  | 16.4  | 16.8  |
| 121 | 850          | 0.2 | 2.4  | 5.6  | 8.8  | 11.5 | 13.5  | 14.8  | 15.6  | 15.9  |
| 122 | 900          | 0.2 | 2.3  | 5.3  | 8.4  | 10.9 | 12.8  | 14.1  | 14.9  | 15.2  |
| 123 | 950          | 0.2 | 2.3  | 5.1  | 8    | 10.4 | 12.2  | 13.4  | 14.2  | 14.5  |
| 124 | 1000         | 0.2 | 2.2  | 5    | 7.7  | 10   | 11.7  | 12.8  | 13.6  | 13.9  |

# BWR DATA TABLES

|    | A            | B   | C    | D     | E     | F     | G     | H     | I     | J     |
|----|--------------|-----|------|-------|-------|-------|-------|-------|-------|-------|
| 1  | Enrichment   |     |      |       |       |       |       |       |       |       |
| 2  | 4.5 Gw-d/MTU |     |      |       |       |       |       |       |       |       |
| 3  | Year         | 1   | 10   | 20    | 30    | 40    | 50    | 60    | 70    | 75    |
| 4  | 5            | 9.9 | 93.1 | 180.5 | 269.8 | 365.2 | 472.4 | 594.2 | 730.1 | 804   |
| 5  | 6            | 8.3 | 80.2 | 159.3 | 240.4 | 327.4 | 423.6 | 533.7 | 659.4 | 728.1 |
| 6  | 7            | 7.4 | 73.2 | 146.1 | 221.2 | 301.8 | 392   | 494.4 | 610.8 | 674.5 |
| 7  | 8            | 6.9 | 68.7 | 138   | 209   | 285.2 | 368.6 | 465.2 | 574.5 | 635.1 |
| 8  | 9            | 6.6 | 65.6 | 131.8 | 199.9 | 271.7 | 351.3 | 442.2 | 547.3 | 604.8 |
| 9  | 10           | 6.4 | 63.3 | 126.8 | 191.7 | 261.3 | 338.2 | 424.3 | 524.3 | 579.7 |
| 10 | 11           | 6.2 | 61.3 | 122.8 | 185.7 | 253   | 326   | 409.5 | 505.4 | 557.8 |
| 11 | 12           | 6   | 59.5 | 119.8 | 180.6 | 245.7 | 316.1 | 396.8 | 488.6 | 538.9 |
| 12 | 13           | 5.8 | 57.9 | 116.7 | 175.6 | 238.4 | 307.2 | 385.3 | 473.9 | 522.2 |
| 13 | 14           | 5.7 | 56.4 | 113.4 | 171.7 | 232.2 | 299.3 | 374.7 | 460.3 | 506.6 |
| 14 | 15           | 5.5 | 55   | 110.7 | 167.6 | 226.9 | 292.6 | 365.3 | 447.8 | 493   |
| 15 | 16           | 5.4 | 53.7 | 108.2 | 163.7 | 221.8 | 285.7 | 355.9 | 436.3 | 480.5 |
| 16 | 17           | 5.2 | 52.5 | 105.8 | 159.7 | 216.6 | 279   | 348.5 | 425.9 | 468.1 |
| 17 | 18           | 5.1 | 51.3 | 103.6 | 156.8 | 212.5 | 272.4 | 339.2 | 415.6 | 456.7 |
| 18 | 19           | 5   | 50.1 | 101.3 | 153.8 | 208.3 | 266.7 | 332   | 405.2 | 445.4 |
| 19 | 20           | 4.9 | 49   | 99.2  | 150.9 | 204.3 | 261.2 | 325.7 | 397   | 435.1 |
| 20 | 21           | 4.8 | 47.9 | 97.1  | 148   | 200.1 | 256.5 | 318.5 | 387.7 | 423.8 |
| 21 | 22           | 4.6 | 46.9 | 95.2  | 145   | 196   | 250.9 | 311.3 | 378.5 | 414.6 |
| 22 | 23           | 4.5 | 45.8 | 93.3  | 142.1 | 191.9 | 246.4 | 305.2 | 370.3 | 405.4 |
| 23 | 24           | 4.4 | 44.9 | 91.5  | 139.1 | 188.8 | 240.9 | 299   | 363.2 | 396.3 |
| 24 | 25           | 4.3 | 43.9 | 89.6  | 136.2 | 184.7 | 236.4 | 292.9 | 354   | 387.1 |
| 25 | 26           | 4.2 | 43   | 87.9  | 134.2 | 181.7 | 231.9 | 286.8 | 346.9 | 379   |
| 26 | 27           | 4.1 | 42.1 | 86.2  | 131.4 | 177.5 | 227.4 | 280.7 | 339.8 | 370.9 |
| 27 | 28           | 4   | 41.2 | 84.5  | 128.3 | 174.4 | 222.9 | 275   | 332.7 | 362.8 |
| 28 | 29           | 3.9 | 40.3 | 82.9  | 126.4 | 171.3 | 218.5 | 269.9 | 325.6 | 354.7 |
| 29 | 30           | 3.9 | 39.5 | 81.3  | 124.2 | 168.2 | 215   | 264.8 | 319.6 | 346.6 |
| 30 | 31           | 3.8 | 38.7 | 79.8  | 121.9 | 165.1 | 210.6 | 259.7 | 312.5 | 340.5 |
| 31 | 32           | 3.7 | 37.9 | 78.2  | 119.6 | 162.1 | 207.1 | 254.7 | 306.4 | 332.5 |
| 32 | 33           | 3.6 | 37.2 | 76.7  | 117.5 | 158.9 | 203.7 | 249.7 | 300.4 | 326.4 |
| 33 | 34           | 3.5 | 36.4 | 75.3  | 115.4 | 156.8 | 199.4 | 244.7 | 293.3 | 319.4 |
| 34 | 35           | 3.4 | 35.6 | 73.8  | 113.3 | 153.7 | 195.9 | 240.8 | 287.3 | 312.3 |
| 35 | 36           | 3.4 | 34.9 | 72.5  | 111.3 | 150.7 | 192.5 | 235.8 | 282.3 | 306.3 |
| 36 | 37           | 3.3 | 34.2 | 71.2  | 109.3 | 148.5 | 189.1 | 232   | 276.2 | 300.2 |
| 37 | 38           | 3.2 | 33.5 | 69.9  | 107.4 | 145.4 | 185.8 | 227.1 | 271.2 | 294.2 |
| 38 | 39           | 3.1 | 32.8 | 68.6  | 105.6 | 143.4 | 182.3 | 223.3 | 266.2 | 288.2 |
| 39 | 40           | 3.1 | 32.1 | 67.3  | 103.7 | 140.9 | 179   | 219.4 | 260.2 | 282.2 |
| 40 | 41           | 3   | 31.5 | 66.1  | 101.9 | 138.5 | 176.6 | 215.6 | 256.1 | 277.2 |
| 41 | 42           | 2.9 | 31   | 64.9  | 100.2 | 136.2 | 173.2 | 211.8 | 251.1 | 271.1 |
| 42 | 43           | 2.9 | 30.3 | 63.7  | 98.5  | 133.9 | 169.9 | 208   | 246.1 | 267.1 |
| 43 | 44           | 2.8 | 29.7 | 62.5  | 96.7  | 131.7 | 167.6 | 204.3 | 242.1 | 261.1 |
| 44 | 45           | 2.7 | 29.2 | 61.5  | 95.1  | 129.5 | 164.2 | 200.5 | 237.1 | 256.1 |
| 45 | 46           | 2.7 | 28.6 | 60.4  | 93.5  | 127.3 | 161.7 | 196.8 | 233.1 | 252.1 |
| 46 | 47           | 2.6 | 28   | 59.3  | 92    | 125.1 | 159   | 193.1 | 229.1 | 247.1 |
| 47 | 48           | 2.6 | 27.5 | 58.3  | 90.4  | 123.1 | 156.4 | 190.4 | 225.1 | 243.1 |
| 48 | 49           | 2.5 | 26.9 | 57.2  | 88.9  | 121.1 | 153.7 | 186.8 | 220.1 | 238.1 |
| 49 | 50           | 2.5 | 26.4 | 56.2  | 87.4  | 119.2 | 151.3 | 184   | 216.1 | 234.1 |
| 50 | 51           | 2.4 | 25.9 | 55.3  | 86    | 117.2 | 148.8 | 180.4 | 213   | 229.1 |
| 51 | 52           | 2.4 | 25.4 | 54.3  | 84.6  | 115.3 | 146.3 | 177.6 | 209   | 225   |
| 52 | 53           | 2.3 | 24.9 | 53.4  | 83.2  | 113.5 | 144   | 174.7 | 205.1 | 220   |
| 53 | 54           | 2.3 | 24.5 | 52.5  | 81.9  | 111.8 | 141.7 | 171.8 | 202   | 217   |
| 54 | 55           | 2.2 | 24   | 51.6  | 80.6  | 110   | 139.5 | 169   | 198   | 213   |
| 55 | 56           | 2.2 | 23.5 | 50.7  | 79.3  | 108.3 | 137.3 | 166.2 | 194.9 | 210   |
| 56 | 57           | 2.1 | 23.1 | 49.9  | 78.1  | 106.6 | 135.2 | 163.5 | 191.7 | 205   |
| 57 | 58           | 2.1 | 22.7 | 49.1  | 76.8  | 105   | 133.1 | 161   | 188.4 | 201.7 |
|    | 59           | 2   | 22.3 | 48.3  | 75.7  | 103.4 | 131   | 158.4 | 185.3 | 198.4 |

# BWR DATA TABLES

|     | A            | B   | C    | D    | E    | F     | G     | H     | I     | J     |
|-----|--------------|-----|------|------|------|-------|-------|-------|-------|-------|
| 1   | Enrichment   |     |      |      |      |       |       |       |       |       |
| 2   | 4.5 Gw-d/MTU |     |      |      |      |       |       |       |       |       |
| 58  | 60           | 2   | 21.8 | 47.5 | 74.5 | 101.8 | 129   | 155.9 | 182.2 | 195.1 |
| 59  | 61           | 1.9 | 21.4 | 46.7 | 73.4 | 100.3 | 127.1 | 153.5 | 179.3 | 191.9 |
| 60  | 62           | 1.9 | 21.1 | 46   | 72.3 | 98.8  | 125.2 | 151.1 | 176.3 | 188.6 |
| 61  | 63           | 1.9 | 20.7 | 45.2 | 71.1 | 97.3  | 123.3 | 148.7 | 173.5 | 185.5 |
| 62  | 64           | 1.8 | 20.3 | 44.5 | 70.1 | 95.9  | 121.4 | 146.4 | 170.7 | 182.4 |
| 63  | 65           | 1.8 | 19.9 | 43.7 | 69   | 94.4  | 119.7 | 144.3 | 168   | 179.4 |
| 64  | 66           | 1.7 | 19.6 | 43.1 | 68   | 93.1  | 117.9 | 142.1 | 165.3 | 176.5 |
| 65  | 67           | 1.7 | 19.2 | 42.4 | 67   | 91.8  | 116.2 | 139.9 | 162.6 | 173.7 |
| 66  | 68           | 1.7 | 18.9 | 41.7 | 66   | 90.5  | 114.6 | 137.8 | 160.2 | 170.9 |
| 67  | 69           | 1.6 | 18.6 | 41.1 | 65.1 | 89.2  | 112.9 | 135.9 | 157.7 | 168.2 |
| 68  | 70           | 1.6 | 18.3 | 40.5 | 64.1 | 87.9  | 111.3 | 133.8 | 155.3 | 165.5 |
| 69  | 71           | 1.6 | 17.9 | 39.8 | 63.2 | 86.7  | 109.8 | 131.9 | 152.9 | 163   |
| 70  | 72           | 1.5 | 17.6 | 39.2 | 62.3 | 85.5  | 108.2 | 130.1 | 150.6 | 160.5 |
| 71  | 73           | 1.5 | 17.3 | 38.6 | 61.5 | 84.3  | 106.7 | 128.1 | 148.3 | 158   |
| 72  | 74           | 1.5 | 17   | 38.1 | 60.5 | 83.2  | 105.2 | 126.3 | 146.1 | 155.6 |
| 73  | 75           | 1.4 | 16.8 | 37.5 | 59.8 | 82.1  | 103.8 | 124.6 | 144   | 153.2 |
| 74  | 76           | 1.4 | 16.5 | 36.9 | 58.9 | 80.9  | 102.4 | 122.8 | 141.8 | 150.9 |
| 75  | 77           | 1.4 | 16.2 | 36.4 | 58.1 | 79.9  | 101   | 121.1 | 139.8 | 148.6 |
| 76  | 78           | 1.4 | 15.9 | 35.9 | 57.3 | 78.8  | 99.7  | 119.5 | 137.8 | 146.4 |
| 77  | 79           | 1.3 | 15.7 | 35.4 | 56.5 | 77.7  | 98.3  | 117.8 | 135.9 | 144.3 |
| 78  | 80           | 1.3 | 15.4 | 34.9 | 55.8 | 76.7  | 97.1  | 116.2 | 134   | 142.2 |
| 79  | 81           | 1.3 | 15.2 | 34.3 | 55   | 75.8  | 95.8  | 114.7 | 132.1 | 140.2 |
| 80  | 82           | 1.3 | 14.9 | 33.9 | 54.3 | 74.8  | 94.6  | 113.2 | 130.3 | 138.2 |
| 81  | 83           | 1.2 | 14.7 | 33.4 | 53.6 | 73.8  | 93.3  | 111.6 | 128.4 | 136.3 |
| 82  | 84           | 1.2 | 14.4 | 33   | 52.9 | 72.9  | 92.2  | 110.3 | 126.7 | 134.4 |
| 83  | 85           | 1.2 | 14.2 | 32.5 | 52.3 | 72    | 91    | 108.8 | 125   | 132.4 |
| 84  | 86           | 1.2 | 14   | 32   | 51.6 | 71.1  | 89.9  | 107.4 | 123.3 | 130.6 |
| 85  | 87           | 1.1 | 13.7 | 31.6 | 50.9 | 70.2  | 88.8  | 106   | 121.7 | 128.9 |
| 86  | 88           | 1.1 | 13.5 | 31.2 | 50.3 | 69.4  | 87.7  | 104.7 | 120.1 | 127.2 |
| 87  | 89           | 1.1 | 13.3 | 30.8 | 49.7 | 68.6  | 86.6  | 103.4 | 118.5 | 125.4 |
| 88  | 90           | 1.1 | 13.1 | 30.3 | 49.1 | 67.8  | 85.6  | 102.1 | 117   | 123.8 |
| 89  | 91           | 1   | 12.9 | 30   | 48.5 | 67    | 84.6  | 100.9 | 115.5 | 122.1 |
| 90  | 92           | 1   | 12.7 | 29.6 | 47.9 | 66.1  | 83.6  | 99.6  | 114   | 120.6 |
| 91  | 93           | 1   | 12.5 | 29.3 | 47.4 | 65.4  | 82.6  | 98.5  | 112.6 | 119.1 |
| 92  | 94           | 1   | 12.4 | 28.8 | 46.8 | 64.6  | 81.6  | 97.3  | 111.2 | 117.5 |
| 93  | 95           | 1   | 12.2 | 28.5 | 46.3 | 63.9  | 80.7  | 96.1  | 109.8 | 116   |
| 94  | 96           | 1   | 12   | 28.1 | 45.7 | 63.2  | 79.8  | 95    | 108.5 | 114.6 |
| 95  | 97           | 0.9 | 11.8 | 27.8 | 45.1 | 62.4  | 78.9  | 93.9  | 107.1 | 113.2 |
| 96  | 98           | 0.9 | 11.6 | 27.4 | 44.7 | 61.7  | 78    | 92.8  | 105.8 | 111.8 |
| 97  | 99           | 0.9 | 11.5 | 27.1 | 44.1 | 61.1  | 77.1  | 91.8  | 104.6 | 110.4 |
| 98  | 100          | 0.9 | 11.3 | 26.8 | 43.6 | 60.4  | 76.3  | 90.7  | 103.3 | 109.1 |
| 99  | 110          | 0.7 | 9.9  | 23.9 | 39.2 | 54.5  | 68.7  | 81.4  | 92.3  | 97.2  |
| 100 | 120          | 0.6 | 8.7  | 21.6 | 35.8 | 49.6  | 62.5  | 73.8  | 83.4  | 87.6  |
| 101 | 130          | 0.5 | 7.8  | 19.7 | 32.8 | 45.6  | 57.4  | 67.5  | 76    | 79.6  |
| 102 | 140          | 0.5 | 7.1  | 18.2 | 30.5 | 42.4  | 53.2  | 62.4  | 69.9  | 73    |
| 103 | 150          | 0.4 | 6.5  | 16.9 | 28.4 | 39.6  | 49.6  | 58    | 64.8  | 67.6  |
| 104 | 160          | 0.4 | 6    | 15.9 | 26.9 | 37.4  | 46.6  | 54.4  | 60.4  | 62.9  |
| 105 | 170          | 0.3 | 5.7  | 15   | 25.5 | 35.4  | 44    | 51.2  | 56.8  | 59.1  |
| 106 | 180          | 0.3 | 5.3  | 14.3 | 24.3 | 33.7  | 41.9  | 48.5  | 53.6  | 55.7  |
| 107 | 190          | 0.3 | 5.1  | 13.8 | 23.3 | 32.3  | 40    | 46.2  | 50.9  | 52.8  |
| 108 | 200          | 0.3 | 4.9  | 13.2 | 22.5 | 31    | 38.3  | 44.1  | 48.5  | 50.2  |
| 109 | 250          | 0.2 | 4.2  | 11.6 | 19.5 | 26.6  | 32.4  | 36.8  | 39.9  | 41.1  |
| 110 | 300          | 0.2 | 3.9  | 10.5 | 17.6 | 23.8  | 28.6  | 32.1  | 34.5  | 35.4  |
| 111 | 350          | 0.2 | 3.7  | 9.8  | 16.3 | 21.7  | 25.9  | 28.7  | 30.6  | 31.4  |
| 112 | 400          | 0.2 | 3.5  | 9.2  | 15   | 20    | 23.7  | 26.1  | 27.7  | 28.3  |
| 113 | 450          | 0.2 | 3.3  | 8.6  | 14.1 | 18.6  | 21.9  | 24    | 25.4  | 25.9  |
| 114 | 500          | 0.2 | 3.2  | 8.2  | 13.2 | 17.4  | 20.4  | 22.3  | 23.5  | 23.9  |
| 115 | 550          | 0.2 | 3.1  | 7.8  | 12.5 | 16.3  | 19    | 20.8  | 21.9  | 22.3  |
| 116 | 600          | 0.2 | 3    | 7.4  | 11.8 | 15.3  | 17.9  | 19.5  | 20.5  | 20.8  |
| 117 | 650          | 0.2 | 2.9  | 7    | 11.1 | 14.5  | 16.8  | 18.3  | 19.2  | 19.6  |
| 118 | 700          | 0.2 | 2.8  | 6.7  | 10.6 | 13.7  | 15.9  | 17.3  | 18.2  | 18.5  |
| 119 | 750          | 0.2 | 2.7  | 6.4  | 10   | 13    | 15    | 16.4  | 17.2  | 17.5  |
| 120 | 800          | 0.2 | 2.6  | 6.1  | 9.5  | 12.3  | 14.3  | 15.5  | 16.3  | 16.7  |
| 121 | 850          | 0.2 | 2.5  | 5.9  | 9.1  | 11.7  | 13.6  | 14.8  | 15.5  | 15.9  |
| 122 | 900          | 0.2 | 2.5  | 5.6  | 8.7  | 11.2  | 12.9  | 14.1  | 14.8  | 15.1  |
| 123 | 950          | 0.2 | 2.4  | 5.4  | 8.3  | 10.6  | 12.3  | 13.4  | 14.1  | 14.5  |
| 124 | 1000         | 0.2 | 2.3  | 5.2  | 8    | 10.2  | 11.8  | 12.8  | 13.5  | 13.8  |

# BWR DATA TABLES

|    | A            | B   | C    | D     | E     | F     | G     | H     | I     | J     |
|----|--------------|-----|------|-------|-------|-------|-------|-------|-------|-------|
| 1  | Enrichment   |     |      |       |       |       |       |       |       |       |
| 2  | 4.5 Gw-d/MTU |     |      |       |       |       |       |       |       |       |
| 3  | Year         | 1   | 10   | 20    | 30    | 40    | 50    | 60    | 70    | 75    |
| 4  | 5            | 9.9 | 93.6 | 181.6 | 273.5 | 371.9 | 483.4 | 611.3 | 755.3 | 831.1 |
| 5  | 6            | 8.3 | 80.6 | 160.4 | 242   | 331.8 | 433   | 548.7 | 681.3 | 752.1 |
| 6  | 7            | 7.4 | 73.4 | 147.2 | 222.6 | 306   | 399.1 | 507.2 | 629.7 | 697.3 |
| 7  | 8            | 6.9 | 68.9 | 138   | 210.4 | 287.2 | 375.2 | 475.9 | 592.2 | 655.8 |
| 8  | 9            | 6.6 | 65.7 | 131.9 | 200.2 | 273.5 | 357.6 | 452.8 | 564   | 623.5 |
| 9  | 10           | 6.4 | 63.3 | 126.9 | 193   | 263   | 343.1 | 434.9 | 539.9 | 597.3 |
| 10 | 11           | 6.2 | 61.4 | 122.9 | 186.9 | 254.5 | 330.7 | 419   | 519.9 | 574.3 |
| 11 | 12           | 6   | 59.5 | 119.8 | 180.9 | 247   | 320.4 | 405.3 | 502   | 555.4 |
| 12 | 13           | 5.8 | 58   | 116.9 | 175.7 | 239.7 | 311.1 | 392.6 | 486.3 | 537.6 |
| 13 | 14           | 5.7 | 56.5 | 113.6 | 171.7 | 234.3 | 302.9 | 382.1 | 472.6 | 521.9 |
| 14 | 15           | 5.5 | 55.1 | 110.9 | 167.8 | 227.9 | 295.8 | 371.6 | 459.1 | 507.3 |
| 15 | 16           | 5.4 | 53.8 | 108.3 | 163.7 | 222.7 | 288.8 | 363.1 | 446.6 | 492.8 |
| 16 | 17           | 5.2 | 52.6 | 106   | 160.7 | 218.4 | 281.8 | 353.7 | 436.1 | 480.3 |
| 17 | 18           | 5.1 | 51.4 | 103.8 | 156.8 | 213.2 | 275.9 | 345.4 | 424.8 | 466.9 |
| 18 | 19           | 5   | 50.2 | 101.5 | 153.8 | 209   | 269   | 337.1 | 414.4 | 456.6 |
| 19 | 20           | 4.9 | 49.1 | 99.5  | 150.9 | 204.7 | 264.2 | 329.9 | 404.1 | 445.2 |
| 20 | 21           | 4.8 | 48   | 97.4  | 147.9 | 200.5 | 258.4 | 322.6 | 394.9 | 434   |
| 21 | 22           | 4.6 | 47   | 95.5  | 145   | 196.3 | 252.6 | 315.4 | 385.6 | 423.7 |
| 22 | 23           | 4.5 | 46   | 93.6  | 142   | 193.2 | 247.9 | 309.3 | 377.4 | 413.5 |
| 23 | 24           | 4.4 | 45   | 91.7  | 139   | 189   | 243.1 | 302.1 | 368.3 | 404.3 |
| 24 | 25           | 4.3 | 44.1 | 89.9  | 137.1 | 185.8 | 238.4 | 297   | 360.1 | 395.2 |
| 25 | 26           | 4.2 | 43.2 | 88.1  | 134.2 | 181.6 | 233.8 | 289.9 | 353   | 386   |
| 26 | 27           | 4.1 | 42.3 | 86.5  | 132.1 | 178.4 | 229.1 | 284.8 | 344.9 | 376.9 |
| 27 | 28           | 4   | 41.4 | 84.8  | 129.3 | 175.3 | 224.5 | 277.7 | 336.8 | 368.8 |
| 28 | 29           | 3.9 | 40.5 | 83.2  | 126.9 | 172.1 | 219.9 | 272.6 | 330.7 | 360.7 |
| 29 | 30           | 3.8 | 39.7 | 81.7  | 124.7 | 169   | 216.3 | 267.5 | 322.6 | 352.6 |
| 30 | 31           | 3.8 | 38.9 | 80.2  | 122.3 | 165.8 | 211.7 | 261.5 | 316.5 | 344.6 |
| 31 | 32           | 3.7 | 38.1 | 78.6  | 120.2 | 162.7 | 208.1 | 256.4 | 310.5 | 337.5 |
| 32 | 33           | 3.6 | 37.3 | 77.1  | 118   | 160.6 | 204.6 | 252.4 | 303.4 | 330.4 |
| 33 | 34           | 3.5 | 36.6 | 75.8  | 116   | 157.4 | 201.1 | 247.2 | 296.4 | 323.4 |
| 34 | 35           | 3.4 | 35.8 | 74.3  | 114   | 154.2 | 196.5 | 242   | 290.3 | 316.3 |
| 35 | 36           | 3.4 | 35.1 | 73    | 111.9 | 152.1 | 193   | 237.9 | 285.3 | 310.3 |
| 36 | 37           | 3.3 | 34.5 | 71.7  | 109.9 | 149   | 189.5 | 233.7 | 279.3 | 303.3 |
| 37 | 38           | 3.2 | 33.8 | 70.5  | 108   | 146.5 | 187.1 | 228.7 | 273.2 | 297.2 |
| 38 | 39           | 3.1 | 33.1 | 69.2  | 106.2 | 144   | 183.5 | 224.7 | 269.2 | 290.2 |
| 39 | 40           | 3.1 | 32.5 | 67.9  | 104.4 | 141.6 | 180.1 | 220.7 | 263.2 | 285.2 |
| 40 | 41           | 3   | 31.8 | 66.7  | 102.6 | 139.1 | 176.6 | 216.6 | 258.2 | 279.2 |
| 41 | 42           | 2.9 | 31.2 | 65.5  | 100.9 | 136.9 | 174.2 | 212.6 | 252.1 | 274.1 |
| 42 | 43           | 2.9 | 30.6 | 64.3  | 99.1  | 134.5 | 170.7 | 208.7 | 248.1 | 268.1 |
| 43 | 44           | 2.8 | 30   | 63.2  | 97.5  | 132.3 | 168.3 | 204.8 | 243.1 | 263.1 |
| 44 | 45           | 2.7 | 29.4 | 62.1  | 95.8  | 130.1 | 165.1 | 200.9 | 239.1 | 258.1 |
| 45 | 46           | 2.7 | 28.8 | 61    | 94.2  | 128   | 162.4 | 198.1 | 234.1 | 253.1 |
| 46 | 47           | 2.6 | 28.4 | 60    | 92.7  | 125.8 | 159.6 | 194.2 | 230.1 | 248.1 |
| 47 | 48           | 2.6 | 27.8 | 58.9  | 91.1  | 123.8 | 156.9 | 190.4 | 225.1 | 243.1 |
| 48 | 49           | 2.5 | 27.3 | 57.9  | 89.7  | 121.7 | 154.3 | 187.6 | 221.1 | 239.1 |
| 49 | 50           | 2.5 | 26.8 | 56.9  | 88.2  | 119.8 | 151.8 | 183.8 | 218.1 | 234.1 |
| 50 | 51           | 2.4 | 26.3 | 56    | 86.9  | 117.9 | 149.3 | 181   | 213.1 | 229.1 |
| 51 | 52           | 2.4 | 25.8 | 55    | 85.4  | 116   | 146.8 | 177.9 | 209   | 225.1 |
| 52 | 53           | 2.3 | 25.3 | 54.1  | 84.1  | 114.2 | 144.4 | 175   | 206   | 221   |
| 53 | 54           | 2.3 | 24.8 | 53.2  | 82.7  | 112.4 | 142.2 | 172   | 202   | 217   |
| 54 | 55           | 2.2 | 24.4 | 52.3  | 81.5  | 110.6 | 139.9 | 169.2 | 198.4 | 213   |
| 55 | 56           | 2.2 | 23.9 | 51.5  | 80.1  | 109   | 137.7 | 166.4 | 194.8 | 209   |
| 56 | 57           | 2.1 | 23.5 | 50.6  | 78.9  | 107.3 | 135.5 | 163.6 | 191.5 | 205.8 |
| 57 | 58           | 2.1 | 23.1 | 49.8  | 77.8  | 105.7 | 133.4 | 161   | 188.2 | 201.4 |
|    | 59           | 2   | 22.6 | 49    | 76.5  | 104   | 131.4 | 158.3 | 184.9 | 198.2 |

# BWR DATA TABLES

|     | A            | B   | C    | D    | E    | F     | G     | H     | I     | J     |
|-----|--------------|-----|------|------|------|-------|-------|-------|-------|-------|
| 1   | Enrichment   |     |      |      |      |       |       |       |       |       |
| 2   | 4.5 Gw-d/MTU |     |      |      |      |       |       |       |       |       |
| 58  | 60           | 2   | 22.2 | 48.3 | 75.4 | 102.5 | 129.4 | 155.8 | 181.8 | 194.9 |
| 59  | 61           | 1.9 | 21.8 | 47.5 | 74.2 | 101   | 127.4 | 153.3 | 178.7 | 191.8 |
| 60  | 62           | 1.9 | 21.4 | 46.8 | 73.1 | 99.5  | 125.5 | 150.9 | 175.8 | 187.6 |
| 61  | 63           | 1.9 | 21.1 | 46   | 72.1 | 98    | 123.6 | 148.5 | 172.8 | 184.8 |
| 62  | 64           | 1.8 | 20.7 | 45.3 | 71   | 96.6  | 121.8 | 146.2 | 170   | 181.7 |
| 63  | 65           | 1.8 | 20.3 | 44.5 | 70   | 95.2  | 120   | 144   | 167.2 | 178.6 |
| 64  | 66           | 1.7 | 20   | 43.9 | 68.9 | 93.8  | 118.2 | 141.8 | 164.5 | 175.6 |
| 65  | 67           | 1.7 | 19.6 | 43.2 | 68   | 92.5  | 116.5 | 139.6 | 161.9 | 172.7 |
| 66  | 68           | 1.7 | 19.3 | 42.6 | 67   | 91.2  | 114.8 | 137.6 | 159.3 | 169.9 |
| 67  | 69           | 1.6 | 19   | 42   | 66   | 89.9  | 113.2 | 135.4 | 156.7 | 167.1 |
| 68  | 70           | 1.6 | 18.7 | 41.3 | 65.1 | 88.7  | 111.6 | 133.4 | 154.4 | 164.4 |
| 69  | 71           | 1.6 | 18.4 | 40.6 | 64.1 | 87.4  | 110   | 131.4 | 151.9 | 161.7 |
| 70  | 72           | 1.5 | 18   | 40.1 | 63.3 | 86.2  | 108.4 | 129.6 | 149.5 | 159.1 |
| 71  | 73           | 1.5 | 17.8 | 39.5 | 62.4 | 85.1  | 106.9 | 127.7 | 147.3 | 156.6 |
| 72  | 74           | 1.5 | 17.5 | 38.9 | 61.5 | 83.9  | 105.4 | 125.9 | 145.1 | 154.2 |
| 73  | 75           | 1.5 | 17.2 | 38.4 | 60.7 | 82.8  | 104   | 124.1 | 142.9 | 151.8 |
| 74  | 76           | 1.4 | 16.8 | 37.8 | 59.9 | 81.6  | 102.6 | 122.3 | 140.7 | 149.5 |
| 75  | 77           | 1.4 | 16.5 | 37.3 | 59   | 80.6  | 101.2 | 120.6 | 138.6 | 147.2 |
| 76  | 78           | 1.4 | 16.3 | 36.8 | 58.3 | 79.5  | 99.9  | 118.9 | 136.7 | 145   |
| 77  | 79           | 1.3 | 16   | 36.3 | 57.5 | 78.5  | 98.5  | 117.3 | 134.6 | 142.8 |
| 78  | 80           | 1.3 | 15.8 | 35.7 | 56.7 | 77.5  | 97.3  | 115.7 | 132.7 | 140.7 |
| 79  | 81           | 1.3 | 15.5 | 35.2 | 56.1 | 76.5  | 96    | 114.2 | 130.8 | 138.6 |
| 80  | 82           | 1.3 | 15.3 | 34.8 | 55.3 | 75.5  | 94.8  | 112.6 | 129   | 136.6 |
| 81  | 83           | 1.2 | 15.1 | 34.3 | 54.6 | 74.6  | 93.5  | 111.1 | 127.1 | 134.6 |
| 82  | 84           | 1.2 | 14.8 | 33.8 | 54   | 73.6  | 92.4  | 109.7 | 125.3 | 132.7 |
| 83  | 85           | 1.2 | 14.6 | 33.4 | 53.2 | 72.8  | 91.2  | 108.2 | 123.7 | 130.9 |
| 84  | 86           | 1.2 | 14.4 | 32.9 | 52.7 | 71.8  | 90.1  | 106.8 | 121.9 | 129   |
| 85  | 87           | 1.1 | 14.2 | 32.5 | 52   | 71    | 88.9  | 105.5 | 120.3 | 127.2 |
| 86  | 88           | 1.1 | 13.9 | 32   | 51.3 | 70.2  | 87.8  | 104.1 | 118.8 | 125.5 |
| 87  | 89           | 1.1 | 13.7 | 31.7 | 50.8 | 69.3  | 86.8  | 102.8 | 117.1 | 123.8 |
| 88  | 90           | 1.1 | 13.5 | 31.3 | 50.1 | 68.5  | 85.8  | 101.5 | 115.6 | 122.1 |
| 89  | 91           | 1.1 | 13.3 | 30.9 | 49.5 | 67.7  | 84.7  | 100.2 | 114   | 120.4 |
| 90  | 92           | 1   | 13.1 | 30.5 | 49   | 67    | 83.7  | 99    | 112.7 | 118.8 |
| 91  | 93           | 1   | 12.9 | 30.1 | 48.4 | 66.1  | 82.8  | 97.8  | 111.2 | 117.3 |
| 92  | 94           | 1   | 12.8 | 29.8 | 47.8 | 65.4  | 81.8  | 96.6  | 109.8 | 115.7 |
| 93  | 95           | 1   | 12.6 | 29.4 | 47.3 | 64.7  | 80.9  | 95.5  | 108.3 | 114.2 |
| 94  | 96           | 1   | 12.4 | 29   | 46.7 | 63.9  | 79.9  | 94.4  | 107   | 112.8 |
| 95  | 97           | 0.9 | 12.2 | 28.7 | 46.2 | 63.2  | 79    | 93.2  | 105.8 | 111.4 |
| 96  | 98           | 0.9 | 12.1 | 28.4 | 45.7 | 62.6  | 78.1  | 92.1  | 104.4 | 110   |
| 97  | 99           | 0.9 | 11.9 | 28   | 45.2 | 61.9  | 77.3  | 91.1  | 103.2 | 108.6 |
| 98  | 100          | 0.9 | 11.7 | 27.7 | 44.7 | 61.2  | 76.4  | 90    | 102   | 107.3 |
| 99  | 110          | 0.8 | 10.3 | 24.8 | 40.3 | 55.3  | 68.9  | 80.8  | 90.9  | 95.4  |
| 100 | 120          | 0.6 | 9.2  | 22.5 | 36.8 | 50.4  | 62.6  | 73.2  | 82.1  | 85.9  |
| 101 | 130          | 0.6 | 8.2  | 20.6 | 33.9 | 46.4  | 57.5  | 67    | 74.7  | 78    |
| 102 | 140          | 0.5 | 7.5  | 19   | 31.5 | 43.1  | 53.3  | 61.9  | 68.7  | 71.5  |
| 103 | 150          | 0.4 | 6.9  | 17.8 | 29.4 | 40.4  | 49.8  | 57.5  | 63.6  | 66.1  |
| 104 | 160          | 0.4 | 6.4  | 16.7 | 27.8 | 38.1  | 46.8  | 53.8  | 59.4  | 61.7  |
| 105 | 170          | 0.3 | 6.1  | 15.9 | 26.4 | 36.1  | 44.3  | 50.8  | 55.7  | 57.9  |
| 106 | 180          | 0.3 | 5.7  | 15.2 | 25.2 | 34.4  | 42.1  | 48.1  | 52.7  | 54.5  |
| 107 | 190          | 0.3 | 5.5  | 14.5 | 24.3 | 32.9  | 40.1  | 45.8  | 50    | 51.7  |
| 108 | 200          | 0.3 | 5.3  | 14   | 23.3 | 31.7  | 38.5  | 43.7  | 47.7  | 49.2  |
| 109 | 250          | 0.2 | 4.6  | 12.3 | 20.3 | 27.2  | 32.6  | 36.5  | 39.3  | 40.3  |
| 110 | 300          | 0.2 | 4.2  | 11.2 | 18.4 | 24.3  | 28.7  | 31.8  | 34    | 34.8  |
| 111 | 350          | 0.2 | 4    | 10.4 | 16.9 | 22.2  | 26    | 28.5  | 30.2  | 30.9  |
| 112 | 400          | 0.2 | 3.8  | 9.8  | 15.7 | 20.4  | 23.7  | 25.9  | 27.4  | 27.9  |
| 113 | 450          | 0.2 | 3.6  | 9.2  | 14.7 | 19    | 22    | 23.8  | 25.1  | 25.6  |
| 114 | 500          | 0.2 | 3.5  | 8.7  | 13.8 | 17.7  | 20.4  | 22.1  | 23.2  | 23.7  |
| 115 | 550          | 0.2 | 3.3  | 8.3  | 13   | 16.6  | 19.1  | 20.6  | 21.7  | 22.1  |
| 116 | 600          | 0.2 | 3.2  | 7.8  | 12.2 | 15.7  | 17.9  | 19.4  | 20.3  | 20.7  |
| 117 | 650          | 0.2 | 3.1  | 7.5  | 11.6 | 14.8  | 16.9  | 18.2  | 19.1  | 19.5  |
| 118 | 700          | 0.2 | 3    | 7.1  | 11   | 14    | 16    | 17.2  | 18.1  | 18.4  |
| 119 | 750          | 0.2 | 2.9  | 6.8  | 10.4 | 13.2  | 15.1  | 16.3  | 17.1  | 17.5  |
| 120 | 800          | 0.2 | 2.8  | 6.5  | 9.9  | 12.6  | 14.3  | 15.5  | 16.3  | 16.6  |
| 121 | 850          | 0.2 | 2.7  | 6.2  | 9.5  | 12    | 13.6  | 14.7  | 15.5  | 15.8  |
| 122 | 900          | 0.2 | 2.6  | 6    | 9    | 11.4  | 13    | 14    | 14.8  | 15.1  |
| 123 | 950          | 0.2 | 2.6  | 5.7  | 8.6  | 10.9  | 12.4  | 13.4  | 14.1  | 14.4  |
| 124 | 1000         | 0.2 | 2.5  | 5.5  | 8.3  | 10.4  | 11.8  | 12.8  | 13.5  | 13.8  |



# BWR DATA TABLES

|    | A            | B   | C    | D     | E     | F     | G     | H     | I     | J     |
|----|--------------|-----|------|-------|-------|-------|-------|-------|-------|-------|
| 1  | Enrichment   |     |      |       |       |       |       |       |       |       |
| 2  | 3.0 Gw-d/MTU |     |      |       |       |       |       |       |       |       |
| 3  | Year         | 1   | 10   | 20    | 30    | 40    | 50    | 60    | 70    | 75    |
| 4  | 5            | 10  | 94.2 | 184.1 | 276.8 | 380.3 | 497.4 | 632.5 | 781.4 | 860.2 |
| 5  | 6            | 8.3 | 81   | 160.7 | 245.1 | 337.8 | 444.8 | 567.7 | 705.3 | 779   |
| 6  | 7            | 7.4 | 73.6 | 147.5 | 224.7 | 310.7 | 408.9 | 523.1 | 652.5 | 722.1 |
| 7  | 8            | 6.9 | 69   | 138.3 | 211.3 | 291.6 | 383.5 | 491.7 | 613   | 678.5 |
| 8  | 9            | 6.6 | 65.8 | 132.2 | 201.1 | 276.8 | 364.4 | 466.5 | 582.6 | 646.1 |
| 9  | 10           | 6.4 | 63.4 | 127.1 | 193.9 | 266   | 349.4 | 446.5 | 557.4 | 617.8 |
| 10 | 11           | 6.2 | 61.4 | 123.1 | 186.7 | 256.2 | 336.5 | 430.6 | 536.4 | 594.7 |
| 11 | 12           | 6   | 59.6 | 120.1 | 181.5 | 248.6 | 325.7 | 415.7 | 518.5 | 573.8 |
| 12 | 13           | 5.8 | 58.1 | 116.1 | 176.4 | 242   | 316.1 | 403   | 501.7 | 554.9 |
| 13 | 14           | 5.7 | 56.5 | 113.6 | 172.3 | 235.5 | 307.5 | 390.4 | 487   | 538.2 |
| 14 | 15           | 5.5 | 55.2 | 110.9 | 168.3 | 230   | 300   | 380.9 | 472.4 | 522.6 |
| 15 | 16           | 5.4 | 53.9 | 108.4 | 164.2 | 224.6 | 292.6 | 370.4 | 459.8 | 508   |
| 16 | 17           | 5.2 | 52.7 | 106.1 | 161.2 | 219.1 | 285.4 | 362   | 448.4 | 493.5 |
| 17 | 18           | 5.1 | 51.5 | 103.9 | 157.2 | 214.7 | 279   | 353.6 | 436   | 481.1 |
| 18 | 19           | 5   | 50.3 | 101.7 | 154.2 | 210.3 | 272.9 | 344.3 | 424.6 | 467.7 |
| 19 | 20           | 4.9 | 49.2 | 99.6  | 151.2 | 206   | 266.7 | 336   | 414.3 | 456.4 |
| 20 | 21           | 4.8 | 48.2 | 97.6  | 148.2 | 201.6 | 261.6 | 328.8 | 404   | 445.1 |
| 21 | 22           | 4.6 | 47.1 | 95.8  | 145.2 | 197.4 | 255.6 | 321.6 | 395.8 | 434.8 |
| 22 | 23           | 4.5 | 46.1 | 93.8  | 142.2 | 194.1 | 250.6 | 314.4 | 385.6 | 423.6 |
| 23 | 24           | 4.4 | 45.2 | 92    | 140.2 | 189.7 | 245.6 | 308.2 | 376.4 | 413.4 |
| 24 | 25           | 4.3 | 44.3 | 90.3  | 137.3 | 186.5 | 240.7 | 301.1 | 368.2 | 403.3 |
| 25 | 26           | 4.2 | 43.3 | 88.5  | 134.3 | 183.3 | 235.8 | 294.9 | 360.1 | 394.1 |
| 26 | 27           | 4.1 | 42.4 | 86.9  | 132.1 | 180   | 230.9 | 287.8 | 350.9 | 385   |
| 27 | 28           | 4   | 41.6 | 85.3  | 129.8 | 175.7 | 227.1 | 282.7 | 343.8 | 375.9 |
| 28 | 29           | 3.9 | 40.8 | 83.6  | 127.4 | 172.5 | 222.3 | 276.6 | 335.7 | 367.8 |
| 29 | 30           | 3.9 | 40   | 82.1  | 125.1 | 170.3 | 218.5 | 270.6 | 328.6 | 359.7 |
| 30 | 31           | 3.8 | 39.1 | 80.6  | 122.9 | 167.1 | 213.7 | 265.5 | 321.6 | 351.6 |
| 31 | 32           | 3.7 | 38.3 | 79.1  | 120.7 | 163.8 | 210   | 259.4 | 314.5 | 343.5 |
| 32 | 33           | 3.6 | 37.6 | 77.7  | 118.5 | 160.6 | 206.2 | 255.4 | 307.4 | 335.5 |
| 33 | 34           | 3.5 | 36.9 | 76.3  | 116.5 | 158.3 | 201.6 | 249.3 | 301.4 | 328.4 |
| 34 | 35           | 3.4 | 36.2 | 74.9  | 114.4 | 155.1 | 197.9 | 245.3 | 294.3 | 321.4 |
| 35 | 36           | 3.4 | 35.4 | 73.6  | 112.5 | 152.9 | 194.2 | 239.3 | 289.3 | 314.3 |
| 36 | 37           | 3.3 | 34.7 | 72.3  | 110.5 | 149.8 | 191.5 | 235.2 | 283.3 | 307.3 |
| 37 | 38           | 3.2 | 34   | 71.1  | 108.7 | 147.2 | 187.9 | 231   | 276.2 | 300.2 |
| 38 | 39           | 3.1 | 33.4 | 69.8  | 106.8 | 144.6 | 184.3 | 226.8 | 271.2 | 295.2 |
| 39 | 40           | 3.1 | 32.8 | 68.5  | 105   | 142.1 | 180.6 | 222.5 | 265.2 | 288.2 |
| 40 | 41           | 3   | 32.2 | 67.4  | 103.2 | 139.7 | 178.1 | 218.2 | 260.2 | 282.2 |
| 41 | 42           | 2.9 | 31.6 | 66.1  | 101.5 | 137.4 | 174.5 | 214.1 | 255.1 | 276.2 |
| 42 | 43           | 2.9 | 30.9 | 65    | 99.9  | 135.2 | 172   | 210   | 250.1 | 271.1 |
| 43 | 44           | 2.8 | 30.4 | 63.8  | 98.3  | 132.9 | 168.6 | 205.9 | 245.1 | 265.1 |
| 44 | 45           | 2.8 | 29.8 | 62.8  | 96.6  | 130.7 | 165.8 | 201.8 | 240.1 | 260.1 |
| 45 | 46           | 2.7 | 29.2 | 61.8  | 94.9  | 128.6 | 162.9 | 198.7 | 236.1 | 254.1 |
| 46 | 47           | 2.6 | 28.7 | 60.7  | 93.4  | 126.5 | 160.2 | 194.7 | 231.1 | 249.1 |
| 47 | 48           | 2.6 | 28.1 | 59.7  | 91.9  | 124.3 | 157.5 | 191.7 | 226.1 | 245.1 |
| 48 | 49           | 2.5 | 27.6 | 58.7  | 90.5  | 122.3 | 154.9 | 187.8 | 222.1 | 240.1 |
| 49 | 50           | 2.5 | 27.1 | 57.7  | 89    | 120.4 | 152.2 | 184.7 | 218.1 | 235.1 |
| 50 | 51           | 2.4 | 26.6 | 56.7  | 87.6  | 118.5 | 149.6 | 181.5 | 214.1 | 230.1 |
| 51 | 52           | 2.4 | 26.1 | 55.8  | 86.2  | 116.6 | 147.2 | 178.2 | 210.1 | 226.1 |
| 52 | 53           | 2.3 | 25.6 | 54.9  | 84.9  | 114.7 | 144.8 | 175.2 | 206   | 221.1 |
| 53 | 54           | 2.3 | 25.3 | 54    | 83.5  | 113   | 142.5 | 172.1 | 201.8 | 218   |
| 54 | 55           | 2.2 | 24.8 | 53.2  | 82.3  | 111.3 | 140.1 | 169.2 | 198.5 | 213   |
| 55 | 56           | 2.2 | 24.4 | 52.3  | 81    | 109.6 | 137.9 | 166.4 | 195.2 | 208.7 |
| 56 | 57           | 2.1 | 23.9 | 51.5  | 79.8  | 107.9 | 135.8 | 163.6 | 191.4 | 205.4 |
| 57 | 58           | 2.1 | 23.5 | 50.7  | 78.6  | 106.2 | 133.7 | 160.9 | 188   | 201.1 |
|    | 59           | 2   | 23.1 | 49.9  | 77.5  | 104.6 | 131.6 | 158.2 | 184.7 | 197.9 |

### BWR DATA TABLES

|     | A          | B        | C   | D    | E    | F    | G     | H     | I     | J     |
|-----|------------|----------|-----|------|------|------|-------|-------|-------|-------|
| 1   | Enrichment |          |     |      |      |      |       |       |       |       |
| 2   | 3.0        | Gw-d/MTU |     |      |      |      |       |       |       |       |
| 58  | Year       | 1        | 10  | 20   | 30   | 40   | 50    | 60    | 70    | 75    |
| 59  |            | 60       | 2   | 22.7 | 49.1 | 76.3 | 103.1 | 129.5 | 155.6 | 181.4 |
| 60  |            | 61       | 2   | 22.3 | 48.4 | 75.1 | 101.6 | 127.5 | 153.1 | 178.3 |
| 61  |            | 62       | 1.9 | 21.9 | 47.7 | 74.1 | 100.1 | 125.6 | 150.6 | 175.2 |
| 62  |            | 63       | 1.9 | 21.5 | 46.9 | 72.9 | 98.6  | 123.7 | 148.2 | 172.3 |
| 63  |            | 64       | 1.8 | 21.2 | 46.2 | 71.9 | 97.1  | 121.8 | 145.9 | 169.3 |
| 64  |            | 65       | 1.8 | 20.8 | 45.5 | 70.9 | 95.8  | 120   | 143.5 | 166.5 |
| 65  |            | 66       | 1.8 | 20.5 | 44.8 | 69.8 | 94.4  | 118.2 | 141.3 | 163.7 |
| 66  |            | 67       | 1.7 | 20.1 | 44.2 | 68.8 | 93    | 116.5 | 139.2 | 161   |
| 67  |            | 68       | 1.7 | 19.8 | 43.5 | 67.9 | 91.8  | 114.8 | 137   | 158.3 |
| 68  |            | 69       | 1.7 | 19.4 | 42.8 | 66.9 | 90.5  | 113.2 | 134.9 | 155.8 |
| 69  |            | 70       | 1.6 | 19   | 42.2 | 66   | 89.2  | 111.6 | 132.9 | 153.3 |
| 70  |            | 71       | 1.6 | 18.7 | 41.6 | 65.2 | 88    | 109.9 | 130.9 | 150.9 |
| 71  |            | 72       | 1.6 | 18.4 | 41.1 | 64.2 | 86.8  | 108.4 | 128.9 | 148.5 |
| 72  |            | 73       | 1.5 | 18.1 | 40.4 | 63.3 | 85.6  | 106.9 | 127.1 | 146.1 |
| 73  |            | 74       | 1.5 | 17.9 | 39.9 | 62.6 | 84.5  | 105.4 | 125.1 | 143.8 |
| 74  |            | 75       | 1.5 | 17.6 | 39.3 | 61.7 | 83.4  | 104   | 123.3 | 141.7 |
| 75  |            | 76       | 1.4 | 17.3 | 38.8 | 60.9 | 82.2  | 102.6 | 121.6 | 139.5 |
| 76  |            | 77       | 1.4 | 17   | 38.3 | 60   | 81.2  | 101.2 | 119.8 | 137.4 |
| 77  |            | 78       | 1.4 | 16.8 | 37.7 | 59.3 | 80.1  | 99.8  | 118.1 | 135.3 |
| 78  |            | 79       | 1.4 | 16.5 | 37.2 | 58.5 | 79.1  | 98.5  | 116.5 | 133.3 |
| 79  |            | 80       | 1.3 | 16.3 | 36.7 | 57.8 | 78.1  | 97.2  | 114.9 | 131.4 |
| 80  |            | 81       | 1.3 | 16   | 36.2 | 57   | 77.1  | 95.9  | 113.4 | 129.4 |
| 81  |            | 82       | 1.3 | 15.8 | 35.7 | 56.4 | 76.1  | 94.6  | 111.8 | 127.5 |
| 82  |            | 83       | 1.3 | 15.5 | 35.3 | 55.6 | 75.2  | 93.5  | 110.3 | 125.7 |
| 83  |            | 84       | 1.2 | 15.3 | 34.9 | 54.9 | 74.3  | 92.3  | 108.7 | 123.9 |
| 84  |            | 85       | 1.2 | 15.1 | 34.3 | 54.3 | 73.3  | 91.1  | 107.3 | 122.2 |
| 85  |            | 86       | 1.2 | 14.9 | 33.9 | 53.6 | 72.5  | 90    | 105.9 | 120.5 |
| 86  |            | 87       | 1.2 | 14.6 | 33.5 | 53   | 71.6  | 88.9  | 104.6 | 118.8 |
| 87  |            | 88       | 1.1 | 14.4 | 33.1 | 52.3 | 70.8  | 87.7  | 103.2 | 117.1 |
| 88  |            | 89       | 1.1 | 14.2 | 32.7 | 51.8 | 70    | 86.7  | 101.9 | 115.6 |
| 89  |            | 90       | 1.1 | 14   | 32.3 | 51.1 | 69.1  | 85.7  | 100.6 | 114   |
| 90  |            | 91       | 1.1 | 13.8 | 31.9 | 50.5 | 68.4  | 84.6  | 99.4  | 112.5 |
| 91  |            | 92       | 1.1 | 13.6 | 31.5 | 50   | 67.5  | 83.7  | 98.1  | 111.1 |
| 92  |            | 93       | 1   | 13.4 | 31.1 | 49.4 | 66.8  | 82.6  | 96.9  | 109.6 |
| 93  |            | 94       | 1   | 13.3 | 30.8 | 48.9 | 66    | 81.7  | 95.8  | 108.2 |
| 94  |            | 95       | 1   | 13.1 | 30.4 | 48.3 | 65.3  | 80.8  | 94.5  | 106.8 |
| 95  |            | 96       | 1   | 12.9 | 30   | 47.8 | 64.6  | 79.8  | 93.5  | 105.4 |
| 96  |            | 97       | 1   | 12.7 | 29.7 | 47.3 | 63.8  | 78.9  | 92.3  | 104.1 |
| 97  |            | 98       | 0.9 | 12.6 | 29.4 | 46.7 | 63.2  | 78.1  | 91.2  | 102.9 |
| 98  |            | 99       | 0.9 | 12.4 | 29   | 46.3 | 62.5  | 77.2  | 90.2  | 101.5 |
| 99  |            | 100      | 0.9 | 12.2 | 28.7 | 45.8 | 61.8  | 76.3  | 89.1  | 100.3 |
| 100 |            | 110      | 0.8 | 10.8 | 25.9 | 41.4 | 56    | 68.8  | 79.9  | 89.4  |
| 101 |            | 120      | 0.7 | 9.7  | 23.5 | 37.8 | 51.1  | 62.6  | 72.4  | 80.5  |
| 102 |            | 130      | 0.6 | 8.8  | 21.6 | 35   | 47.1  | 57.6  | 66.2  | 73.2  |
| 103 |            | 140      | 0.5 | 8    | 20.1 | 32.6 | 43.8  | 53.3  | 61.1  | 67.3  |
| 104 |            | 150      | 0.4 | 7.4  | 18.8 | 30.6 | 41    | 49.7  | 56.8  | 62.3  |
| 105 |            | 160      | 0.4 | 6.9  | 17.8 | 28.8 | 38.7  | 46.8  | 53.2  | 58.2  |
| 106 |            | 170      | 0.4 | 6.6  | 16.9 | 27.5 | 36.8  | 44.2  | 50.1  | 54.6  |
| 107 |            | 180      | 0.3 | 6.2  | 16.2 | 26.3 | 35.1  | 42.1  | 47.5  | 51.6  |
| 108 |            | 190      | 0.3 | 6    | 15.5 | 25.2 | 33.6  | 40.2  | 45.2  | 49    |
| 109 |            | 200      | 0.3 | 5.7  | 15   | 24.3 | 32.2  | 38.5  | 43.2  | 46.7  |
| 110 |            | 250      | 0.3 | 5    | 13.1 | 21.2 | 27.7  | 32.5  | 36.1  | 38.6  |
| 111 |            | 300      | 0.2 | 4.6  | 12   | 19.2 | 24.8  | 28.7  | 31.6  | 33.5  |
| 112 |            | 350      | 0.2 | 4.4  | 11.2 | 17.6 | 22.6  | 26    | 28.3  | 29.9  |
| 113 |            | 400      | 0.2 | 4.2  | 10.5 | 16.4 | 20.8  | 23.8  | 25.7  | 27.1  |
| 114 |            | 450      | 0.2 | 4    | 9.9  | 15.3 | 19.3  | 22    | 23.7  | 24.9  |
| 115 |            | 500      | 0.2 | 3.8  | 9.3  | 14.4 | 18.1  | 20.5  | 22    | 23.1  |
| 116 |            | 550      | 0.2 | 3.6  | 8.8  | 13.5 | 16.9  | 19.1  | 20.5  | 21.5  |
| 117 |            | 600      | 0.2 | 3.5  | 8.4  | 12.7 | 15.9  | 18    | 19.3  | 20.2  |
| 118 |            | 650      | 0.2 | 3.4  | 8    | 12.1 | 15    | 16.9  | 18.2  | 19.1  |
| 119 |            | 700      | 0.2 | 3.2  | 7.6  | 11.4 | 14.2  | 16    | 17.2  | 18    |
| 120 |            | 750      | 0.2 | 3.1  | 7.2  | 10.9 | 13.5  | 15.2  | 16.3  | 17.1  |
| 121 |            | 800      | 0.2 | 3    | 6.9  | 10.3 | 12.8  | 14.4  | 15.5  | 16.3  |
| 122 |            | 850      | 0.2 | 2.9  | 6.6  | 9.8  | 12.2  | 13.7  | 14.7  | 15.5  |
| 123 |            | 900      | 0.2 | 2.9  | 6.3  | 9.4  | 11.6  | 13.1  | 14    | 14.8  |
| 124 |            | 950      | 0.2 | 2.8  | 6.1  | 9    | 11.1  | 12.5  | 13.4  | 14.2  |
| 124 |            | 1000     | 0.2 | 2.7  | 5.8  | 8.6  | 10.6  | 11.9  | 12.8  | 13.6  |

# BWR DATA TABLES

|    | A            | B   | C    | D     | E     | F     | G     | H     | I     | J     |
|----|--------------|-----|------|-------|-------|-------|-------|-------|-------|-------|
| 1  | Enrichment   |     |      |       |       |       |       |       |       |       |
| 2  | 3.0 Gw-d/MTU |     |      |       |       |       |       |       |       |       |
| 3  | Year         | 1   | 10   | 20    | 30    | 40    | 50    | 60    | 70    | 75    |
| 4  | 5            | 10  | 95.1 | 185.9 | 282.2 | 389.9 | 514.7 | 654.8 | 810.5 | 891.1 |
| 5  | 6            | 8.3 | 81.4 | 162.5 | 248.4 | 345   | 458.9 | 587.8 | 732.3 | 807.8 |
| 6  | 7            | 7.4 | 73.8 | 148.2 | 226.8 | 316.5 | 421.4 | 541.1 | 677.4 | 748.9 |
| 7  | 8            | 6.9 | 69.2 | 139   | 213.2 | 296.1 | 394.1 | 507.6 | 636.7 | 704.1 |
| 8  | 9            | 6.6 | 66   | 132.8 | 202.8 | 280.9 | 374   | 482.3 | 604.3 | 669.6 |
| 9  | 10           | 6.4 | 63.4 | 127.8 | 194.5 | 269.8 | 358   | 461.1 | 578   | 641.3 |
| 10 | 11           | 6.2 | 61.5 | 123.7 | 188.2 | 259.8 | 344.2 | 444.1 | 555.9 | 615.2 |
| 11 | 12           | 6   | 59.7 | 119.7 | 182   | 251.8 | 332.4 | 428.2 | 536.9 | 593.2 |
| 12 | 13           | 5.8 | 58.1 | 116.5 | 176.8 | 245   | 323.7 | 414.5 | 519.1 | 574.3 |
| 13 | 14           | 5.7 | 56.6 | 113.7 | 172.6 | 238.2 | 314.2 | 402.8 | 503.3 | 556.5 |
| 14 | 15           | 5.5 | 55.2 | 111   | 168.5 | 232.4 | 305.7 | 392.2 | 488.7 | 539.8 |
| 15 | 16           | 5.4 | 54   | 108.5 | 164.3 | 226.7 | 297.2 | 381.7 | 474.1 | 524.2 |
| 16 | 17           | 5.2 | 52.7 | 106.2 | 161.3 | 221.1 | 290.9 | 372.2 | 461.6 | 509.7 |
| 17 | 18           | 5.1 | 51.6 | 104.1 | 158.2 | 216.5 | 284.3 | 362.9 | 449.1 | 496.3 |
| 18 | 19           | 5   | 50.4 | 101.8 | 154.1 | 212   | 277.7 | 353.5 | 437.8 | 482.9 |
| 19 | 20           | 4.9 | 49.3 | 99.8  | 151.1 | 207.5 | 271.1 | 345.2 | 426.4 | 470.5 |
| 20 | 21           | 4.8 | 48.3 | 97.8  | 149.1 | 203   | 265.7 | 336.9 | 415.1 | 458.2 |
| 21 | 22           | 4.6 | 47.3 | 95.8  | 145.9 | 199.4 | 260.3 | 328.7 | 405.9 | 445.9 |
| 22 | 23           | 4.5 | 46.3 | 94.1  | 142.9 | 195   | 253.9 | 321.5 | 395.7 | 435.7 |
| 23 | 24           | 4.4 | 45.4 | 92.3  | 139.9 | 191.5 | 248.6 | 313.3 | 386.5 | 424.5 |
| 24 | 25           | 4.3 | 44.4 | 90.5  | 137.8 | 188.1 | 243.4 | 307.2 | 377.3 | 414.3 |
| 25 | 26           | 4.2 | 43.6 | 88.9  | 134.9 | 183.7 | 239.2 | 301   | 368.1 | 404.2 |
| 26 | 27           | 4.1 | 42.7 | 87.2  | 132.5 | 180.3 | 234   | 293.9 | 359   | 394   |
| 27 | 28           | 4   | 41.8 | 85.6  | 130.2 | 177   | 228.9 | 286.8 | 351.9 | 383.9 |
| 28 | 29           | 3.9 | 41   | 84.1  | 127.8 | 173.6 | 224.8 | 280.7 | 342.8 | 375.8 |
| 29 | 30           | 3.8 | 40.2 | 82.5  | 125.5 | 171.2 | 220.7 | 275.6 | 335.7 | 366.7 |
| 30 | 31           | 3.8 | 39.5 | 81    | 123.3 | 167.9 | 215.8 | 269.5 | 327.6 | 358.6 |
| 31 | 32           | 3.7 | 38.7 | 79.6  | 121.2 | 164.5 | 211.8 | 263.5 | 320.5 | 350.5 |
| 32 | 33           | 3.6 | 37.9 | 78.2  | 119   | 161.2 | 207.9 | 258.4 | 313.5 | 341.5 |
| 33 | 34           | 3.5 | 37.1 | 76.8  | 116.9 | 158.9 | 203.9 | 253.4 | 306.4 | 333.4 |
| 34 | 35           | 3.4 | 36.5 | 75.4  | 115   | 155.5 | 200   | 248.3 | 299.4 | 326.4 |
| 35 | 36           | 3.4 | 35.8 | 74.2  | 113   | 153.1 | 196.2 | 242.3 | 292.3 | 319.3 |
| 36 | 37           | 3.3 | 35.1 | 72.8  | 111.1 | 150.5 | 192.3 | 238.3 | 287.3 | 312.3 |
| 37 | 38           | 3.2 | 34.4 | 71.7  | 109.1 | 147.9 | 189.5 | 233.2 | 280.3 | 304.3 |
| 38 | 39           | 3.1 | 33.8 | 70.4  | 107.3 | 145.3 | 185.7 | 228.2 | 274.2 | 298.2 |
| 39 | 40           | 3.1 | 33.1 | 69.2  | 105.6 | 142.8 | 181.9 | 224.2 | 269.2 | 291.2 |
| 40 | 41           | 3   | 32.6 | 68.1  | 103.8 | 140.4 | 179.1 | 219.2 | 263.2 | 285.2 |
| 41 | 42           | 2.9 | 32   | 66.9  | 102.1 | 138   | 175.4 | 215.1 | 257.2 | 280.2 |
| 42 | 43           | 2.9 | 31.4 | 65.7  | 100.5 | 135.7 | 172.5 | 211.8 | 252.1 | 273.1 |
| 43 | 44           | 2.8 | 30.8 | 64.6  | 98.8  | 133.5 | 169.4 | 207.5 | 247.1 | 267.1 |
| 44 | 45           | 2.8 | 30.2 | 63.6  | 97.3  | 131.2 | 166.4 | 203.2 | 242.1 | 262.1 |
| 45 | 46           | 2.7 | 29.6 | 62.5  | 95.7  | 129   | 163.6 | 199.9 | 238.1 | 256.1 |
| 46 | 47           | 2.6 | 29.1 | 61.5  | 94.1  | 127   | 160.7 | 195.7 | 233.1 | 251.1 |
| 47 | 48           | 2.6 | 28.6 | 60.5  | 92.6  | 124.9 | 158   | 192.3 | 228.1 | 245.1 |
| 48 | 49           | 2.5 | 28   | 59.5  | 91.1  | 122.8 | 155.3 | 188.8 | 223.1 | 241.1 |
| 49 | 50           | 2.5 | 27.6 | 58.5  | 89.7  | 120.8 | 152.7 | 185.4 | 219.1 | 236.1 |
| 50 | 51           | 2.4 | 27.1 | 57.6  | 88.3  | 118.9 | 150   | 182.1 | 214.1 | 231.1 |
| 51 | 52           | 2.4 | 26.7 | 56.7  | 87    | 117   | 147.5 | 178.7 | 211.1 | 227.1 |
| 52 | 53           | 2.3 | 26.2 | 55.8  | 85.6  | 115.2 | 145.1 | 175.5 | 206.6 | 222.1 |
| 53 | 54           | 2.3 | 25.7 | 54.9  | 84.3  | 113.5 | 142.7 | 172.4 | 202.2 | 218   |
| 54 | 55           | 2.2 | 25.3 | 54.1  | 83.1  | 111.6 | 140.3 | 169.4 | 198.9 | 213.5 |
| 55 | 56           | 2.2 | 24.8 | 53.2  | 81.8  | 110   | 138.1 | 166.5 | 194.7 | 209.2 |
| 56 | 57           | 2.1 | 24.4 | 52.4  | 80.6  | 108.3 | 135.9 | 163.6 | 191.5 | 205.9 |
| 57 | 58           | 2.1 | 24   | 51.6  | 79.4  | 106.7 | 133.7 | 160.8 | 188.4 | 201.7 |
|    | 59           | 2   | 23.6 | 50.9  | 78.3  | 105   | 131.6 | 158.1 | 184.6 | 197.5 |

# BWR DATA TABLES

|      | A          | B        | C    | D    | E    | F     | G     | H     | I     | J     |
|------|------------|----------|------|------|------|-------|-------|-------|-------|-------|
| 1    | Enrichment |          |      |      |      |       |       |       |       |       |
| 2    | 3.0        | Gw-d/MTU |      |      |      |       |       |       |       |       |
| Year | 1          | 10       | 20   | 30   | 40   | 50    | 60    | 70    | 75    |       |
| 58   | 60         | 2        | 23.2 | 50.1 | 77.1 | 103.5 | 129.6 | 155.4 | 181.1 | 194.4 |
| 59   | 61         | 2        | 22.8 | 49.3 | 76   | 102   | 127.5 | 152.8 | 178   | 190.3 |
| 60   | 62         | 1.9      | 22.4 | 48.6 | 74.8 | 100.5 | 125.5 | 150.3 | 174.7 | 187.3 |
| 61   | 63         | 1.9      | 22.1 | 47.9 | 73.8 | 99    | 123.6 | 147.8 | 171.7 | 183.4 |
| 62   | 64         | 1.8      | 21.7 | 47.2 | 72.8 | 97.6  | 121.7 | 145.4 | 168.6 | 180.4 |
| 63   | 65         | 1.8      | 21.3 | 46.5 | 71.7 | 96.2  | 119.9 | 143   | 165.8 | 177   |
| 64   | 66         | 1.8      | 21   | 45.9 | 70.7 | 94.8  | 118.1 | 140.8 | 162.9 | 173.8 |
| 65   | 67         | 1.7      | 20.7 | 45.1 | 69.7 | 93.4  | 116.3 | 138.5 | 160.1 | 170.8 |
| 66   | 68         | 1.7      | 20.3 | 44.5 | 68.8 | 92.1  | 114.6 | 136.3 | 157.5 | 167.8 |
| 67   | 69         | 1.7      | 20   | 43.9 | 67.9 | 90.8  | 113   | 134.2 | 154.8 | 164.9 |
| 68   | 70         | 1.6      | 19.7 | 43.3 | 66.9 | 89.6  | 111.3 | 132.2 | 152.3 | 162.1 |
| 69   | 71         | 1.6      | 19.4 | 42.6 | 66   | 88.4  | 109.7 | 130.1 | 149.7 | 159.2 |
| 70   | 72         | 1.6      | 19.1 | 42.1 | 65.1 | 87.2  | 108.2 | 128.1 | 147.3 | 156.6 |
| 71   | 73         | 1.5      | 18.8 | 41.5 | 64.3 | 86.1  | 106.6 | 126.2 | 144.9 | 154   |
| 72   | 74         | 1.5      | 18.4 | 41   | 63.5 | 84.9  | 105.1 | 124.3 | 142.6 | 151.4 |
| 73   | 75         | 1.5      | 18.1 | 40.4 | 62.6 | 83.8  | 103.7 | 122.4 | 140.3 | 148.9 |
| 74   | 76         | 1.4      | 17.9 | 39.8 | 61.8 | 82.6  | 102.2 | 120.7 | 138.1 | 146.5 |
| 75   | 77         | 1.4      | 17.6 | 39.3 | 61   | 81.6  | 100.9 | 118.9 | 136   | 144.2 |
| 76   | 78         | 1.4      | 17.4 | 38.9 | 60.3 | 80.6  | 99.5  | 117.2 | 133.9 | 141.8 |
| 77   | 79         | 1.4      | 17.1 | 38.3 | 59.5 | 79.5  | 98.1  | 115.5 | 131.8 | 139.6 |
| 78   | 80         | 1.3      | 16.9 | 37.8 | 58.8 | 78.5  | 96.8  | 113.9 | 129.9 | 137.5 |
| 79   | 81         | 1.3      | 16.6 | 37.4 | 58   | 77.5  | 95.6  | 112.3 | 127.8 | 135.3 |
| 80   | 82         | 1.3      | 16.4 | 36.8 | 57.3 | 76.6  | 94.3  | 110.7 | 126   | 133.3 |
| 81   | 83         | 1.3      | 16.1 | 36.4 | 56.6 | 75.6  | 93.1  | 109.2 | 124.1 | 131.3 |
| 82   | 84         | 1.2      | 15.9 | 36   | 56   | 74.7  | 91.9  | 107.8 | 122.4 | 129.3 |
| 83   | 85         | 1.2      | 15.7 | 35.5 | 55.3 | 73.7  | 90.8  | 106.3 | 120.6 | 127.3 |
| 84   | 86         | 1.2      | 15.5 | 35.1 | 54.6 | 72.9  | 89.6  | 104.9 | 118.8 | 125.4 |
| 85   | 87         | 1.2      | 15.3 | 34.7 | 54   | 72    | 88.5  | 103.4 | 117.1 | 123.6 |
| 86   | 88         | 1.2      | 15.1 | 34.2 | 53.3 | 71.2  | 87.4  | 102.1 | 115.5 | 121.8 |
| 87   | 89         | 1.1      | 14.8 | 33.8 | 52.8 | 70.4  | 86.3  | 100.8 | 113.9 | 120   |
| 88   | 90         | 1.1      | 14.6 | 33.4 | 52.2 | 69.5  | 85.3  | 99.4  | 112.3 | 118.3 |
| 89   | 91         | 1.1      | 14.4 | 33.1 | 51.6 | 68.8  | 84.3  | 98.2  | 110.8 | 116.7 |
| 90   | 92         | 1.1      | 14.3 | 32.6 | 51   | 67.9  | 83.2  | 96.9  | 109.3 | 115   |
| 91   | 93         | 1        | 14.1 | 32.3 | 50.4 | 67.2  | 82.3  | 95.7  | 107.8 | 113.5 |
| 92   | 94         | 1        | 13.9 | 32   | 49.9 | 66.4  | 81.3  | 94.6  | 106.4 | 111.9 |
| 93   | 95         | 1        | 13.7 | 31.5 | 49.4 | 65.8  | 80.4  | 93.4  | 105   | 110.4 |
| 94   | 96         | 1        | 13.5 | 31.2 | 48.8 | 65    | 79.4  | 92.3  | 103.7 | 108.9 |
| 95   | 97         | 1        | 13.4 | 30.9 | 48.3 | 64.3  | 78.6  | 91.1  | 102.4 | 107.5 |
| 96   | 98         | 1        | 13.2 | 30.5 | 47.8 | 63.6  | 77.6  | 90.1  | 101.1 | 106.1 |
| 97   | 99         | 0.9      | 13   | 30.2 | 47.3 | 63    | 76.8  | 89    | 99.8  | 104.7 |
| 98   | 100        | 0.9      | 12.9 | 29.9 | 46.8 | 62.3  | 76    | 88    | 98.5  | 103.4 |
| 99   | 110        | 0.8      | 11.4 | 27   | 42.4 | 56.4  | 68.5  | 78.8  | 87.6  | 91.5  |
| 100  | 120        | 0.7      | 10.3 | 24.7 | 38.9 | 51.6  | 62.3  | 71.3  | 78.7  | 82    |
| 101  | 130        | 0.6      | 9.4  | 22.8 | 36   | 47.6  | 57.2  | 65.2  | 71.6  | 74.4  |
| 102  | 140        | 0.5      | 8.6  | 21.3 | 33.6 | 44.3  | 53.1  | 60.1  | 65.8  | 68.1  |
| 103  | 150        | 0.5      | 8    | 20   | 31.7 | 41.5  | 49.5  | 55.8  | 60.9  | 63    |
| 104  | 160        | 0.4      | 7.6  | 19   | 30   | 39.2  | 46.6  | 52.4  | 56.8  | 58.7  |
| 105  | 170        | 0.4      | 7.2  | 18.1 | 28.5 | 37.3  | 44.1  | 49.3  | 53.4  | 55    |
| 106  | 180        | 0.4      | 6.8  | 17.3 | 27.3 | 35.5  | 41.9  | 46.7  | 50.5  | 52    |
| 107  | 190        | 0.3      | 6.6  | 16.6 | 26.2 | 34    | 40    | 44.5  | 47.9  | 49.3  |
| 108  | 200        | 0.3      | 6.3  | 16.1 | 25.4 | 32.8  | 38.4  | 42.6  | 45.7  | 47.1  |
| 109  | 250        | 0.3      | 5.6  | 14.1 | 22.1 | 28.1  | 32.5  | 35.6  | 37.9  | 38.9  |
| 110  | 300        | 0.3      | 5.2  | 13   | 20   | 25.2  | 28.7  | 31.3  | 33.1  | 33.8  |
| 111  | 350        | 0.3      | 4.9  | 12   | 18.3 | 23    | 26    | 28.1  | 29.6  | 30.2  |
| 112  | 400        | 0.3      | 4.6  | 11.3 | 17   | 21.1  | 23.8  | 25.6  | 26.9  | 27.5  |
| 113  | 450        | 0.3      | 4.4  | 10.6 | 15.9 | 19.6  | 22    | 23.6  | 24.8  | 25.3  |
| 114  | 500        | 0.2      | 4.2  | 10   | 14.9 | 18.3  | 20.5  | 21.9  | 23    | 23.5  |
| 115  | 550        | 0.2      | 4    | 9.5  | 14.1 | 17.2  | 19.2  | 20.5  | 21.5  | 22    |
| 116  | 600        | 0.2      | 3.9  | 9    | 13.3 | 16.2  | 18    | 19.2  | 20.2  | 20.6  |
| 117  | 650        | 0.2      | 3.7  | 8.5  | 12.5 | 15.3  | 17    | 18.2  | 19.1  | 19.5  |
| 118  | 700        | 0.2      | 3.6  | 8.1  | 11.9 | 14.5  | 16.1  | 17.2  | 18    | 18.4  |
| 119  | 750        | 0.2      | 3.4  | 7.7  | 11.3 | 13.7  | 15.2  | 16.3  | 17.1  | 17.5  |
| 120  | 800        | 0.2      | 3.3  | 7.4  | 10.7 | 13    | 14.5  | 15.5  | 16.3  | 16.7  |
| 121  | 850        | 0.2      | 3.2  | 7.1  | 10.2 | 12.4  | 13.8  | 14.8  | 15.6  | 15.9  |
| 122  | 900        | 0.2      | 3.1  | 6.8  | 9.8  | 11.8  | 13.1  | 14.1  | 14.9  | 15.2  |
| 123  | 950        | 0.2      | 3    | 6.5  | 9.3  | 11.3  | 12.6  | 13.5  | 14.2  | 14.6  |
| 124  | 1000       | 0.2      | 2.9  | 6.2  | 8.9  | 10.8  | 12    | 12.9  | 13.7  | 14    |

# BWR DATA TABLES

|    | A            | B   | C    | D     | E     | F     | G     | H     | I     | J     |
|----|--------------|-----|------|-------|-------|-------|-------|-------|-------|-------|
| 1  | Enrichment   |     |      |       |       |       |       |       |       |       |
| 2  | 2.5 Gw-d/MTU |     |      |       |       |       |       |       |       |       |
| 3  | Year         | 1   | 10   | 20    | 30    | 40    | 50    | 60    | 70    | 75    |
| 4  | 5            | 10  | 96.2 | 189.3 | 288.1 | 402.6 | 533   | 681   | 840.5 | 924   |
| 5  | 6            | 8.3 | 82   | 163.8 | 253.1 | 355.2 | 474.1 | 610.9 | 760.1 | 838.6 |
| 6  | 7            | 7.5 | 74.2 | 149.5 | 230.2 | 324.2 | 435.5 | 564   | 704.1 | 777.5 |
| 7  | 8            | 7   | 69.4 | 139.3 | 215.5 | 303.3 | 407.1 | 528.4 | 662.4 | 731.7 |
| 8  | 9            | 6.6 | 66.1 | 133   | 203.9 | 287.6 | 385.8 | 501   | 628.8 | 696.1 |
| 9  | 10           | 6.4 | 63.6 | 127.9 | 196.4 | 275   | 368.7 | 479.7 | 601.5 | 665.8 |
| 10 | 11           | 6.2 | 61.5 | 123.8 | 188.9 | 264.6 | 354.8 | 460.7 | 577.3 | 638.6 |
| 11 | 12           | 6   | 59.7 | 119.7 | 183.5 | 256.3 | 342.9 | 443.7 | 556.3 | 616.5 |
| 12 | 13           | 5.8 | 58.1 | 116.6 | 178.2 | 248   | 332.2 | 429.9 | 538.4 | 595.6 |
| 13 | 14           | 5.7 | 56.6 | 113.6 | 173.9 | 241.9 | 322.6 | 417.2 | 521.6 | 575.8 |
| 14 | 15           | 5.5 | 55.3 | 111   | 169.6 | 235.8 | 314   | 404.5 | 505.9 | 559.1 |
| 15 | 16           | 5.4 | 54   | 108.6 | 165.4 | 229.8 | 305.5 | 393   | 491.3 | 542.4 |
| 16 | 17           | 5.2 | 52.8 | 106.2 | 162.2 | 223.9 | 298.1 | 383.5 | 476.8 | 526.9 |
| 17 | 18           | 5.1 | 51.7 | 104   | 158.1 | 219.1 | 290.7 | 373.1 | 464.3 | 512.4 |
| 18 | 19           | 5   | 50.5 | 101.9 | 154.8 | 214.2 | 283.4 | 363.7 | 451.9 | 498   |
| 19 | 20           | 4.9 | 49.5 | 99.8  | 151.7 | 210.4 | 278.1 | 355.4 | 439.6 | 484.6 |
| 20 | 21           | 4.7 | 48.5 | 97.9  | 148.6 | 205.6 | 270.8 | 346.1 | 428.3 | 472.3 |
| 21 | 22           | 4.6 | 47.5 | 96    | 146.4 | 201   | 264.6 | 337.8 | 418   | 459   |
| 22 | 23           | 4.5 | 46.5 | 94.2  | 143.3 | 197.2 | 259.4 | 329.6 | 406.7 | 447.8 |
| 23 | 24           | 4.4 | 45.6 | 92.5  | 140.2 | 193.5 | 253.3 | 322.4 | 396.5 | 436.6 |
| 24 | 25           | 4.3 | 44.7 | 90.8  | 137.9 | 189.9 | 248.7 | 315.2 | 387.4 | 425.4 |
| 25 | 26           | 4.2 | 43.8 | 89.1  | 135.4 | 185.3 | 243.1 | 307.1 | 377.2 | 414.2 |
| 26 | 27           | 4.1 | 42.9 | 87.6  | 133   | 181.7 | 237.6 | 300   | 368   | 404.1 |
| 27 | 28           | 4   | 42.2 | 85.9  | 130.6 | 179.2 | 233.2 | 292.9 | 359.9 | 393.9 |
| 28 | 29           | 3.9 | 41.3 | 84.4  | 128.2 | 175.7 | 227.7 | 286.7 | 350.8 | 384.8 |
| 29 | 30           | 3.8 | 40.5 | 83    | 125.9 | 172.1 | 223.3 | 280.7 | 342.7 | 374.7 |
| 30 | 31           | 3.8 | 39.7 | 81.4  | 123.7 | 168.6 | 219   | 274.6 | 334.6 | 365.6 |
| 31 | 32           | 3.7 | 39.1 | 80    | 121.5 | 166.1 | 214.8 | 269.5 | 326.6 | 356.6 |
| 32 | 33           | 3.6 | 38.3 | 78.7  | 119.5 | 162.6 | 210.5 | 262.5 | 319.5 | 348.5 |
| 33 | 34           | 3.5 | 37.6 | 77.4  | 117.4 | 160.2 | 206.3 | 257.4 | 311.4 | 340.4 |
| 34 | 35           | 3.4 | 36.8 | 75.9  | 115.4 | 156.9 | 202.1 | 251.4 | 305.4 | 332.4 |
| 35 | 36           | 3.4 | 36.2 | 74.7  | 113.4 | 154   | 198   | 246.3 | 297.3 | 324.3 |
| 36 | 37           | 3.3 | 35.6 | 73.4  | 111.6 | 151.3 | 194.9 | 241.3 | 291.3 | 317.3 |
| 37 | 38           | 3.2 | 34.9 | 72.3  | 109.6 | 148.6 | 190.8 | 236.2 | 284.3 | 309.3 |
| 38 | 39           | 3.1 | 34.2 | 71    | 107.8 | 146.1 | 186.8 | 231.2 | 278.2 | 303.2 |
| 39 | 40           | 3.1 | 33.6 | 69.8  | 106.1 | 143.4 | 183.9 | 226.2 | 272.2 | 295.2 |
| 40 | 41           | 3   | 33.1 | 68.8  | 104.3 | 141.1 | 179.9 | 223.2 | 267.2 | 289.2 |
| 41 | 42           | 2.9 | 32.5 | 67.6  | 102.6 | 138.6 | 176.8 | 218.2 | 261.2 | 283.2 |
| 42 | 43           | 2.9 | 31.9 | 66.5  | 100.9 | 136.2 | 173.6 | 213.1 | 255.1 | 276.2 |
| 43 | 44           | 2.8 | 31.3 | 65.3  | 99.4  | 134   | 170.4 | 210.1 | 250.1 | 270.1 |
| 44 | 45           | 2.8 | 30.7 | 64.3  | 97.8  | 131.7 | 167.4 | 205.1 | 244.1 | 265.1 |
| 45 | 46           | 2.7 | 30.2 | 63.3  | 96.3  | 129.6 | 164.4 | 201.6 | 239.1 | 259.1 |
| 46 | 47           | 2.6 | 29.6 | 62.3  | 94.7  | 127.4 | 161.5 | 197.3 | 235.1 | 253.1 |
| 47 | 48           | 2.6 | 29.2 | 61.3  | 93.1  | 125.4 | 158.6 | 193.6 | 229.1 | 247.1 |
| 48 | 49           | 2.5 | 28.7 | 60.4  | 91.7  | 123.4 | 155.8 | 189.9 | 224.1 | 243.1 |
| 49 | 50           | 2.5 | 28.2 | 59.4  | 90.4  | 121.2 | 153.2 | 186.2 | 220.1 | 237.1 |
| 50 | 51           | 2.4 | 27.7 | 58.5  | 89    | 119.3 | 150.6 | 182.8 | 215.1 | 232.1 |
| 51 | 52           | 2.4 | 27.2 | 57.6  | 87.6  | 117.4 | 147.9 | 179.4 | 211.2 | 228.1 |
| 52 | 53           | 2.3 | 26.8 | 56.8  | 86.3  | 115.6 | 145.4 | 176   | 207.9 | 223.1 |
| 53 | 54           | 2.3 | 26.3 | 55.9  | 85    | 113.7 | 142.9 | 172.8 | 203.5 | 218.3 |
| 54 | 55           | 2.2 | 25.9 | 55.1  | 83.7  | 112   | 140.5 | 169.7 | 199.3 | 213.9 |
| 55 | 56           | 2.2 | 25.5 | 54.2  | 82.5  | 110.2 | 138.1 | 166.7 | 195.1 | 209.6 |
| 56 | 57           | 2.1 | 25   | 53.4  | 81.3  | 108.5 | 135.9 | 163.7 | 192   | 205.4 |
| 57 | 58           | 2.1 | 24.6 | 52.6  | 80.1  | 106.9 | 133.7 | 160.7 | 188   | 201.2 |
|    | 59           | 2.1 | 24.2 | 51.9  | 78.9  | 105.3 | 131.5 | 157.9 | 184   | 198.1 |

# BWR DATA TABLES

|     | A          | B        | C    | D    | E    | F     | G     | H     | I     | J     |
|-----|------------|----------|------|------|------|-------|-------|-------|-------|-------|
| 1   | Enrichment |          |      |      |      |       |       |       |       |       |
| 2   | Year       | Gw-d/MTU |      |      |      |       |       |       |       |       |
| 58  | 60         | 2        | 23.8 | 51.1 | 77.8 | 103.7 | 129.5 | 155.2 | 181   | 194.1 |
| 59  | 61         | 2        | 23.5 | 50.4 | 76.7 | 102.2 | 127.4 | 152.6 | 177.6 | 190.1 |
| 60  | 62         | 1.9      | 23.1 | 49.6 | 75.6 | 100.7 | 125.4 | 149.9 | 174.3 | 186.1 |
| 61  | 63         | 1.9      | 22.7 | 48.9 | 74.5 | 99.2  | 123.4 | 147.4 | 171.2 | 183.2 |
| 62  | 64         | 1.9      | 22.4 | 48.2 | 73.5 | 97.7  | 121.5 | 144.9 | 168.1 | 179.3 |
| 63  | 65         | 1.8      | 22   | 47.6 | 72.5 | 96.4  | 119.6 | 142.5 | 165.1 | 176.5 |
| 64  | 66         | 1.8      | 21.7 | 47   | 71.5 | 95    | 117.8 | 140.2 | 162.1 | 173   |
| 65  | 67         | 1.8      | 21.3 | 46.2 | 70.6 | 93.7  | 116   | 137.8 | 159.3 | 169.8 |
| 66  | 68         | 1.7      | 21   | 45.6 | 69.6 | 92.4  | 114.2 | 135.7 | 156.6 | 166.8 |
| 67  | 69         | 1.7      | 20.7 | 45   | 68.7 | 91    | 112.6 | 133.5 | 153.8 | 163.8 |
| 68  | 70         | 1.7      | 20.4 | 44.4 | 67.8 | 89.8  | 110.9 | 131.3 | 151.1 | 160.9 |
| 69  | 71         | 1.6      | 20.1 | 43.8 | 66.9 | 88.5  | 109.3 | 129.2 | 148.6 | 158.1 |
| 70  | 72         | 1.6      | 19.8 | 43.3 | 66   | 87.3  | 107.7 | 127.2 | 146.1 | 155.3 |
| 71  | 73         | 1.6      | 19.5 | 42.7 | 65.1 | 86.2  | 106.1 | 125.2 | 143.6 | 152.6 |
| 72  | 74         | 1.5      | 19.2 | 42.1 | 64.3 | 85.1  | 104.6 | 123.3 | 141.3 | 150.1 |
| 73  | 75         | 1.5      | 19   | 41.6 | 63.5 | 84    | 103.1 | 121.5 | 139   | 147.4 |
| 74  | 76         | 1.5      | 18.7 | 41.1 | 62.7 | 82.8  | 101.7 | 119.7 | 136.8 | 145   |
| 75  | 77         | 1.4      | 18.4 | 40.5 | 61.9 | 81.7  | 100.3 | 117.8 | 134.6 | 142.6 |
| 76  | 78         | 1.4      | 18.1 | 40   | 61.1 | 80.7  | 98.9  | 116.1 | 132.4 | 140.2 |
| 77  | 79         | 1.4      | 17.8 | 39.5 | 60.4 | 79.6  | 97.6  | 114.4 | 130.3 | 137.9 |
| 78  | 80         | 1.4      | 17.6 | 39   | 59.6 | 78.6  | 96.3  | 112.8 | 128.2 | 135.8 |
| 79  | 81         | 1.3      | 17.4 | 38.6 | 58.9 | 77.7  | 95    | 111.1 | 126.3 | 133.5 |
| 80  | 82         | 1.3      | 17.1 | 38.1 | 58.2 | 76.7  | 93.7  | 109.5 | 124.4 | 131.4 |
| 81  | 83         | 1.3      | 16.9 | 37.6 | 57.5 | 75.7  | 92.5  | 108   | 122.5 | 129.4 |
| 82  | 84         | 1.3      | 16.7 | 37.2 | 56.8 | 74.8  | 91.3  | 106.5 | 120.7 | 127.4 |
| 83  | 85         | 1.2      | 16.5 | 36.8 | 56.2 | 74    | 90.1  | 105   | 118.8 | 125.5 |
| 84  | 86         | 1.2      | 16.2 | 36.3 | 55.6 | 73.1  | 89    | 103.6 | 117.1 | 123.6 |
| 85  | 87         | 1.2      | 16   | 35.9 | 54.9 | 72.2  | 87.8  | 102.2 | 115.4 | 121.7 |
| 86  | 88         | 1.2      | 15.8 | 35.5 | 54.3 | 71.4  | 86.7  | 100.8 | 113.7 | 119.8 |
| 87  | 89         | 1.2      | 15.6 | 35.1 | 53.7 | 70.5  | 85.7  | 99.5  | 112.1 | 118.1 |
| 88  | 90         | 1.1      | 15.4 | 34.7 | 53.1 | 69.7  | 84.6  | 98.1  | 110.5 | 116.4 |
| 89  | 91         | 1.1      | 15.2 | 34.3 | 52.5 | 69    | 83.6  | 96.9  | 109   | 114.6 |
| 90  | 92         | 1.1      | 15   | 33.9 | 51.9 | 68.2  | 82.6  | 95.6  | 107.5 | 113.1 |
| 91  | 93         | 1.1      | 14.9 | 33.6 | 51.4 | 67.4  | 81.7  | 94.4  | 106   | 111.4 |
| 92  | 94         | 1.1      | 14.7 | 33.2 | 50.9 | 66.7  | 80.7  | 93.2  | 104.6 | 109.8 |
| 93  | 95         | 1        | 14.5 | 32.8 | 50.4 | 65.9  | 79.7  | 92.1  | 103.2 | 108.3 |
| 94  | 96         | 1        | 14.3 | 32.5 | 49.8 | 65.2  | 78.8  | 90.9  | 101.8 | 106.9 |
| 95  | 97         | 1        | 14.2 | 32.1 | 49.3 | 64.5  | 77.9  | 89.8  | 100.4 | 105.4 |
| 96  | 98         | 1        | 14   | 31.8 | 48.8 | 63.8  | 77    | 88.7  | 99.1  | 104   |
| 97  | 99         | 1        | 13.8 | 31.5 | 48.3 | 63.1  | 76.1  | 87.6  | 97.9  | 102.6 |
| 98  | 100        | 1        | 13.7 | 31.2 | 47.8 | 62.5  | 75.3  | 86.6  | 96.6  | 101.3 |
| 99  | 110        | 0.8      | 12.2 | 28.3 | 43.5 | 56.6  | 67.8  | 77.4  | 85.6  | 89.5  |
| 100 | 120        | 0.7      | 11.1 | 26   | 39.9 | 51.8  | 61.7  | 70    | 76.9  | 80    |
| 101 | 130        | 0.6      | 10.2 | 24.1 | 37.1 | 47.9  | 56.7  | 63.9  | 69.9  | 72.5  |
| 102 | 140        | 0.5      | 9.5  | 22.6 | 34.7 | 44.6  | 52.6  | 59    | 64.1  | 66.4  |
| 103 | 150        | 0.5      | 8.9  | 21.3 | 32.6 | 41.8  | 49.1  | 54.8  | 59.4  | 61.3  |
| 104 | 160        | 0.4      | 8.4  | 20.2 | 31   | 39.6  | 46.2  | 51.4  | 55.4  | 57.2  |
| 105 | 170        | 0.4      | 8    | 19.3 | 29.5 | 37.5  | 43.8  | 48.5  | 52.1  | 53.6  |
| 106 | 180        | 0.4      | 7.6  | 18.5 | 28.3 | 35.9  | 41.6  | 45.9  | 49.3  | 50.7  |
| 107 | 190        | 0.4      | 7.3  | 17.9 | 27.2 | 34.5  | 39.8  | 43.8  | 46.8  | 48.1  |
| 108 | 200        | 0.3      | 7.1  | 17.3 | 26.3 | 33.1  | 38.2  | 41.9  | 44.8  | 45.9  |
| 109 | 250        | 0.3      | 6.3  | 15.3 | 23   | 28.5  | 32.4  | 35.2  | 37.3  | 38.2  |
| 110 | 300        | 0.3      | 5.8  | 14   | 20.7 | 25.5  | 28.6  | 31    | 32.7  | 33.4  |
| 111 | 350        | 0.3      | 5.5  | 13   | 19.1 | 23.3  | 26    | 27.9  | 29.3  | 30    |
| 112 | 400        | 0.3      | 5.2  | 12.2 | 17.7 | 21.4  | 23.8  | 25.4  | 26.7  | 27.3  |
| 113 | 450        | 0.3      | 4.9  | 11.5 | 16.6 | 19.9  | 22    | 23.5  | 24.7  | 25.2  |
| 114 | 500        | 0.3      | 4.7  | 10.8 | 15.5 | 18.6  | 20.5  | 21.9  | 23    | 23.5  |
| 115 | 550        | 0.3      | 4.5  | 10.2 | 14.6 | 17.4  | 19.2  | 20.5  | 21.5  | 22    |
| 116 | 600        | 0.3      | 4.3  | 9.7  | 13.8 | 16.4  | 18.1  | 19.3  | 20.3  | 20.7  |
| 117 | 650        | 0.3      | 4.1  | 9.2  | 13   | 15.5  | 17.1  | 18.2  | 19.1  | 19.6  |
| 118 | 700        | 0.3      | 4    | 8.7  | 12.4 | 14.7  | 16.2  | 17.2  | 18.1  | 18.5  |
| 119 | 750        | 0.3      | 3.8  | 8.3  | 11.7 | 13.9  | 15.3  | 16.4  | 17.2  | 17.6  |
| 120 | 800        | 0.3      | 3.7  | 7.9  | 11.2 | 13.2  | 14.6  | 15.6  | 16.4  | 16.8  |
| 121 | 850        | 0.3      | 3.6  | 7.6  | 10.6 | 12.6  | 13.9  | 14.9  | 15.7  | 16.1  |
| 122 | 900        | 0.3      | 3.4  | 7.3  | 10.1 | 12    | 13.3  | 14.2  | 15    | 15.4  |
| 123 | 950        | 0.3      | 3.3  | 7    | 9.7  | 11.5  | 12.7  | 13.6  | 14.4  | 14.7  |
| 124 | 1000       | 0.3      | 3.2  | 6.7  | 9.3  | 11    | 12.1  | 13    | 13.8  | 14.1  |

# BWR DATA TABLES

|    | A            | B    | C    | D     | E     | F     | G     | H     | I     | J     |
|----|--------------|------|------|-------|-------|-------|-------|-------|-------|-------|
| 1  | Enrichment   |      |      |       |       |       |       |       |       |       |
| 2  | 2.0 Gw-d/MTU |      |      |       |       |       |       |       |       |       |
| 3  | Year         | 1    | 10   | 20    | 30    | 40    | 50    | 60    | 70    | 75    |
| 4  | 5            | 10.1 | 97.6 | 192.6 | 296.4 | 417.3 | 555.4 | 709.2 | 873.3 | 957.7 |
| 5  | 6            | 8.4  | 82.7 | 166   | 258.9 | 367.2 | 493.3 | 637.9 | 790.9 | 870.3 |
| 6  | 7            | 7.5  | 74.6 | 150.6 | 234.7 | 334.4 | 453.5 | 587.9 | 732.8 | 808.1 |
| 7  | 8            | 7    | 69.5 | 140.1 | 218.7 | 311.9 | 423   | 550.2 | 689.9 | 761.2 |
| 8  | 9            | 6.6  | 66.2 | 132.9 | 206.8 | 295.5 | 400.6 | 522.7 | 654.3 | 723.6 |
| 9  | 10           | 6.4  | 63.5 | 127.6 | 198   | 282.4 | 383.4 | 499.3 | 625.9 | 692.1 |
| 10 | 11           | 6.2  | 61.4 | 123.5 | 191.3 | 271.4 | 368.4 | 479.2 | 600.7 | 664.9 |
| 11 | 12           | 6    | 59.7 | 119.6 | 184.7 | 262.6 | 355.5 | 462.2 | 579.6 | 639.8 |
| 12 | 13           | 5.8  | 58.1 | 116.4 | 179.1 | 253.9 | 343.7 | 447.3 | 558.7 | 618.8 |
| 13 | 14           | 5.7  | 56.6 | 113.5 | 174.7 | 247.2 | 333   | 433.5 | 541.9 | 598   |
| 14 | 15           | 5.5  | 55.3 | 110.8 | 170.1 | 240.7 | 323.4 | 419.8 | 525.2 | 579.3 |
| 15 | 16           | 5.4  | 54.1 | 108.4 | 166.8 | 234.3 | 315.8 | 407.2 | 508.5 | 561.6 |
| 16 | 17           | 5.2  | 52.9 | 106.1 | 162.4 | 228.9 | 307.4 | 396.7 | 495   | 545.1 |
| 17 | 18           | 5.1  | 51.8 | 103.9 | 159.1 | 223.6 | 300   | 386.3 | 480.5 | 530.6 |
| 18 | 19           | 5    | 50.7 | 101.8 | 155.8 | 218.4 | 291.6 | 375.9 | 467.1 | 514.1 |
| 19 | 20           | 4.9  | 49.6 | 99.9  | 152.4 | 213.3 | 285.3 | 365.5 | 454.7 | 500.7 |
| 20 | 21           | 4.7  | 48.7 | 97.9  | 149.3 | 209.2 | 279   | 357.2 | 442.4 | 487.4 |
| 21 | 22           | 4.6  | 47.7 | 96.1  | 147   | 204.1 | 272.8 | 348   | 431.1 | 473.1 |
| 22 | 23           | 4.5  | 46.7 | 94.3  | 143.8 | 200.1 | 266.6 | 339.7 | 419.8 | 460.9 |
| 23 | 24           | 4.4  | 45.9 | 92.5  | 141.2 | 196.2 | 260.4 | 331.5 | 408.6 | 448.6 |
| 24 | 25           | 4.3  | 45   | 91    | 138.5 | 192.2 | 254.2 | 323.3 | 398.4 | 436.4 |
| 25 | 26           | 4.2  | 44.1 | 89.3  | 136   | 188.4 | 249.1 | 316.2 | 388.2 | 425.3 |
| 26 | 27           | 4.1  | 43.3 | 87.7  | 133.5 | 184.5 | 242.9 | 308   | 379.1 | 415.1 |
| 27 | 28           | 4    | 42.5 | 86.2  | 131.1 | 180.7 | 237.8 | 300.9 | 369   | 404   |
| 28 | 29           | 3.9  | 41.7 | 84.7  | 128.8 | 176.9 | 232.7 | 293.8 | 359.8 | 393.9 |
| 29 | 30           | 3.9  | 41   | 83.3  | 126.4 | 174.1 | 227.6 | 287.7 | 350.7 | 383.8 |
| 30 | 31           | 3.8  | 40.2 | 81.8  | 124.2 | 170.5 | 222.5 | 280.6 | 342.7 | 373.7 |
| 31 | 32           | 3.7  | 39.4 | 80.4  | 122   | 167.7 | 217.9 | 274.5 | 333.6 | 364.6 |
| 32 | 33           | 3.6  | 38.8 | 79.1  | 119.9 | 164.3 | 214.2 | 268.5 | 326.5 | 355.5 |
| 33 | 34           | 3.5  | 38.1 | 77.7  | 117.9 | 161.2 | 209.8 | 262.4 | 318.5 | 347.5 |
| 34 | 35           | 3.4  | 37.4 | 76.5  | 115.8 | 158.2 | 205.2 | 256.4 | 311.4 | 338.4 |
| 35 | 36           | 3.4  | 36.8 | 75.1  | 113.9 | 155.4 | 200.8 | 250.3 | 303.4 | 330.4 |
| 36 | 37           | 3.3  | 36.1 | 74    | 112   | 152.5 | 197.5 | 245.3 | 296.3 | 323.3 |
| 37 | 38           | 3.2  | 35.5 | 72.8  | 110.2 | 149.7 | 193.1 | 240.3 | 289.3 | 314.3 |
| 38 | 39           | 3.2  | 34.8 | 71.6  | 108.2 | 147.1 | 189.8 | 234.2 | 283.2 | 307.3 |
| 39 | 40           | 3.1  | 34.2 | 70.5  | 106.5 | 144.5 | 185.7 | 230.2 | 276.2 | 300.2 |
| 40 | 41           | 3    | 33.7 | 69.4  | 104.8 | 141.9 | 182.1 | 225.2 | 270.2 | 294.2 |
| 41 | 42           | 3    | 33.1 | 68.3  | 103   | 139.4 | 178.5 | 220.2 | 264.2 | 286.2 |
| 42 | 43           | 2.9  | 32.5 | 67.2  | 101.4 | 137   | 175.2 | 216.1 | 258.2 | 279.2 |
| 43 | 44           | 2.8  | 32   | 66.1  | 99.8  | 134.6 | 171.9 | 211.1 | 252.1 | 273.1 |
| 44 | 45           | 2.8  | 31.4 | 65    | 98.3  | 132.3 | 168.6 | 207.1 | 247.1 | 268.1 |
| 45 | 46           | 2.7  | 31   | 64.1  | 96.7  | 130.1 | 165.5 | 203.3 | 242.1 | 262.1 |
| 46 | 47           | 2.7  | 30.4 | 63.1  | 95.2  | 128   | 162.5 | 199   | 236.1 | 256.1 |
| 47 | 48           | 2.6  | 29.9 | 62.2  | 93.8  | 125.8 | 159.5 | 194.7 | 232.1 | 250.1 |
| 48 | 49           | 2.6  | 29.4 | 61.3  | 92.2  | 123.7 | 156.7 | 191.1 | 226.1 | 245.1 |
| 49 | 50           | 2.5  | 28.9 | 60.2  | 90.8  | 121.7 | 153.9 | 187.4 | 222   | 239.1 |
| 50 | 51           | 2.5  | 28.5 | 59.4  | 89.5  | 119.6 | 151.1 | 183.7 | 217.7 | 234.1 |
| 51 | 52           | 2.4  | 28   | 58.5  | 88    | 117.7 | 148.4 | 180.2 | 212.4 | 229.1 |
| 52 | 53           | 2.4  | 27.6 | 57.7  | 86.8  | 115.8 | 145.8 | 176.7 | 208.1 | 223.9 |
| 53 | 54           | 2.3  | 27.1 | 56.8  | 85.5  | 113.9 | 143.2 | 173.4 | 203.9 | 219.6 |
| 54 | 55           | 2.3  | 26.7 | 56    | 84.3  | 112.2 | 140.8 | 170.1 | 199.7 | 215.4 |
| 55 | 56           | 2.2  | 26.3 | 55.2  | 83    | 110.4 | 138.4 | 166.9 | 195.6 | 210.1 |
| 56 | 57           | 2.2  | 25.8 | 54.5  | 81.8  | 108.7 | 136   | 163.9 | 191.5 | 205.9 |
| 57 | 58           | 2.1  | 25.4 | 53.6  | 80.7  | 107.1 | 133.7 | 160.9 | 188.5 | 201.8 |
|    | 59           | 2.1  | 25.1 | 52.9  | 79.5  | 105.4 | 131.5 | 157.9 | 184.6 | 197.8 |

# BWR DATA TABLES

|     | A                 | B   | C    | D    | E    | F     | G     | H     | I     | J     |
|-----|-------------------|-----|------|------|------|-------|-------|-------|-------|-------|
| 1   | Enrichment<br>2.0 |     |      |      |      |       |       |       |       |       |
| 2   | Year              |     |      |      |      |       |       |       |       |       |
|     | Gw-d/MTU          |     |      |      |      |       |       |       |       |       |
| 58  | 60                | 2   | 24.7 | 52.2 | 78.3 | 103.8 | 129.3 | 155   | 180.7 | 193.8 |
| 59  | 61                | 2   | 24.3 | 51.5 | 77.3 | 102.2 | 127.2 | 152.3 | 177.8 | 189.8 |
| 60  | 62                | 2   | 23.9 | 50.7 | 76.2 | 100.7 | 125.1 | 149.6 | 174   | 185.9 |
| 61  | 63                | 1.9 | 23.6 | 50   | 75.2 | 99.3  | 123.1 | 147   | 170.8 | 182.1 |
| 62  | 64                | 1.9 | 23.2 | 49.4 | 74.1 | 97.8  | 121.1 | 144.5 | 167.5 | 179.3 |
| 63  | 65                | 1.9 | 22.9 | 48.7 | 73.1 | 96.3  | 119.2 | 142   | 164.5 | 175.5 |
| 64  | 66                | 1.8 | 22.6 | 48.1 | 72.1 | 94.9  | 117.3 | 139.5 | 161.4 | 171.8 |
| 65  | 67                | 1.8 | 22.2 | 47.5 | 71.2 | 93.6  | 115.6 | 137.2 | 158.5 | 169   |
| 66  | 68                | 1.7 | 21.9 | 46.9 | 70.2 | 92.3  | 113.8 | 134.9 | 155.6 | 165.8 |
| 67  | 69                | 1.7 | 21.6 | 46.2 | 69.3 | 91    | 112   | 132.6 | 152.8 | 162.7 |
| 68  | 70                | 1.7 | 21.3 | 45.6 | 68.4 | 89.7  | 110.3 | 130.5 | 150.1 | 159.8 |
| 69  | 71                | 1.7 | 21   | 45.1 | 67.5 | 88.5  | 108.7 | 128.4 | 147.5 | 156.8 |
| 70  | 72                | 1.6 | 20.7 | 44.5 | 66.7 | 87.3  | 107.1 | 126.3 | 144.8 | 154   |
| 71  | 73                | 1.6 | 20.5 | 43.9 | 65.8 | 86.1  | 105.5 | 124.2 | 142.4 | 151.3 |
| 72  | 74                | 1.6 | 20.2 | 43.3 | 64.9 | 84.9  | 103.9 | 122.2 | 140   | 148.6 |
| 73  | 75                | 1.5 | 19.9 | 42.8 | 64.1 | 83.9  | 102.5 | 120.4 | 137.6 | 145.9 |
| 74  | 76                | 1.5 | 19.7 | 42.3 | 63.3 | 82.7  | 101   | 118.5 | 135.3 | 143.5 |
| 75  | 77                | 1.5 | 19.4 | 41.8 | 62.6 | 81.6  | 99.6  | 116.7 | 133   | 141   |
| 76  | 78                | 1.4 | 19.2 | 41.3 | 61.8 | 80.6  | 98.1  | 114.9 | 130.9 | 138.6 |
| 77  | 79                | 1.4 | 18.9 | 40.9 | 61.1 | 79.6  | 96.8  | 113.1 | 128.7 | 136.3 |
| 78  | 80                | 1.4 | 18.6 | 40.3 | 60.4 | 78.5  | 95.5  | 111.5 | 126.6 | 134   |
| 79  | 81                | 1.4 | 18.4 | 39.9 | 59.7 | 77.6  | 94.2  | 109.8 | 124.7 | 131.8 |
| 80  | 82                | 1.3 | 18.2 | 39.4 | 59   | 76.6  | 92.9  | 108.2 | 122.7 | 129.6 |
| 81  | 83                | 1.3 | 17.9 | 39   | 58.2 | 75.6  | 91.7  | 106.7 | 120.8 | 127.5 |
| 82  | 84                | 1.3 | 17.7 | 38.6 | 57.6 | 74.7  | 90.4  | 105.1 | 118.9 | 125.5 |
| 83  | 85                | 1.3 | 17.5 | 38.1 | 56.9 | 73.8  | 89.2  | 103.6 | 117   | 123.5 |
| 84  | 86                | 1.3 | 17.3 | 37.7 | 56.3 | 72.9  | 88.1  | 102.2 | 115.2 | 121.5 |
| 85  | 87                | 1.2 | 17.1 | 37.2 | 55.7 | 72.1  | 86.9  | 100.7 | 113.5 | 119.7 |
| 86  | 88                | 1.2 | 16.9 | 36.9 | 55   | 71.3  | 85.9  | 99.3  | 111.9 | 117.9 |
| 87  | 89                | 1.2 | 16.6 | 36.5 | 54.4 | 70.4  | 84.8  | 98    | 110.2 | 116.1 |
| 88  | 90                | 1.2 | 16.5 | 36.1 | 53.9 | 69.6  | 83.7  | 96.6  | 108.6 | 114.3 |
| 89  | 91                | 1.1 | 16.3 | 35.7 | 53.3 | 68.8  | 82.7  | 95.3  | 107.1 | 112.6 |
| 90  | 92                | 1.1 | 16.1 | 35.3 | 52.7 | 68    | 81.6  | 94.1  | 105.5 | 110.9 |
| 91  | 93                | 1.1 | 15.9 | 35   | 52.2 | 67.3  | 80.7  | 92.9  | 104   | 109.3 |
| 92  | 94                | 1.1 | 15.7 | 34.6 | 51.6 | 66.5  | 79.7  | 91.7  | 102.6 | 107.7 |
| 93  | 95                | 1.1 | 15.5 | 34.2 | 51.1 | 65.8  | 78.8  | 90.5  | 101.2 | 106.2 |
| 94  | 96                | 1.1 | 15.4 | 33.9 | 50.6 | 65.1  | 77.8  | 89.4  | 99.8  | 104.7 |
| 95  | 97                | 1   | 15.2 | 33.6 | 50.1 | 64.4  | 76.9  | 88.3  | 98.5  | 103.2 |
| 96  | 98                | 1   | 15   | 33.3 | 49.6 | 63.7  | 76.1  | 87.2  | 97.1  | 101.8 |
| 97  | 99                | 1   | 14.9 | 32.9 | 49.1 | 63    | 75.3  | 86.1  | 95.9  | 100.4 |
| 98  | 100               | 1   | 14.7 | 32.6 | 48.6 | 62.4  | 74.4  | 85.1  | 94.7  | 99.1  |
| 99  | 110               | 0.9 | 13.3 | 29.8 | 44.3 | 56.5  | 66.9  | 75.8  | 83.6  | 87.2  |
| 100 | 120               | 0.7 | 12.2 | 27.5 | 40.9 | 51.8  | 60.8  | 68.4  | 75    | 77.9  |
| 101 | 130               | 0.7 | 11.3 | 25.6 | 38   | 47.9  | 55.9  | 62.5  | 68    | 70.5  |
| 102 | 140               | 0.6 | 10.5 | 24.1 | 35.6 | 44.6  | 51.9  | 57.6  | 62.3  | 64.5  |
| 103 | 150               | 0.5 | 9.9  | 22.7 | 33.6 | 42    | 48.5  | 53.6  | 57.8  | 59.6  |
| 104 | 160               | 0.5 | 9.4  | 21.7 | 31.9 | 39.7  | 45.6  | 50.3  | 53.9  | 55.5  |
| 105 | 170               | 0.5 | 9    | 20.7 | 30.4 | 37.7  | 43.2  | 47.4  | 50.7  | 52.2  |
| 106 | 180               | 0.4 | 8.6  | 20   | 29.2 | 36.1  | 41.2  | 45    | 48    | 49.3  |
| 107 | 190               | 0.4 | 8.4  | 19.3 | 28.2 | 34.6  | 39.3  | 42.9  | 45.7  | 46.8  |
| 108 | 200               | 0.4 | 8.1  | 18.8 | 27.2 | 33.4  | 37.8  | 41.2  | 43.7  | 44.7  |
| 109 | 250               | 0.3 | 7.2  | 16.6 | 23.8 | 28.8  | 32.2  | 34.7  | 36.7  | 37.4  |
| 110 | 300               | 0.3 | 6.7  | 15.2 | 21.5 | 25.8  | 28.6  | 30.7  | 32.3  | 32.9  |
| 111 | 350               | 0.3 | 6.3  | 14.1 | 19.8 | 23.5  | 26    | 27.7  | 29.1  | 29.7  |
| 112 | 400               | 0.3 | 6    | 13.2 | 18.4 | 21.7  | 23.8  | 25.4  | 26.6  | 27.2  |
| 113 | 450               | 0.3 | 5.7  | 12.4 | 17.2 | 20.2  | 22.1  | 23.5  | 24.7  | 25.2  |
| 114 | 500               | 0.3 | 5.4  | 11.7 | 16.1 | 18.8  | 20.6  | 21.9  | 23    | 23.5  |
| 115 | 550               | 0.3 | 5.2  | 11   | 15.2 | 17.7  | 19.3  | 20.6  | 21.6  | 22    |
| 116 | 600               | 0.3 | 4.9  | 10.5 | 14.3 | 16.7  | 18.2  | 19.4  | 20.3  | 20.8  |
| 117 | 650               | 0.3 | 4.7  | 9.9  | 13.5 | 15.7  | 17.2  | 18.3  | 19.2  | 19.7  |
| 118 | 700               | 0.3 | 4.5  | 9.4  | 12.8 | 14.9  | 16.3  | 17.4  | 18.3  | 18.7  |
| 119 | 750               | 0.3 | 4.3  | 9    | 12.2 | 14.2  | 15.5  | 16.5  | 17.4  | 17.8  |
| 120 | 800               | 0.3 | 4.2  | 8.6  | 11.6 | 13.5  | 14.7  | 15.7  | 16.6  | 17    |
| 121 | 850               | 0.3 | 4    | 8.2  | 11   | 12.8  | 14    | 15    | 15.8  | 16.2  |
| 122 | 900               | 0.3 | 3.9  | 7.8  | 10.5 | 12.2  | 13.4  | 14.3  | 15.1  | 15.5  |
| 123 | 950               | 0.3 | 3.8  | 7.5  | 10.1 | 11.7  | 12.8  | 13.7  | 14.5  | 14.9  |
| 124 | 1000              | 0.3 | 3.6  | 7.2  | 9.6  | 11.2  | 12.3  | 13.2  | 13.9  | 14.3  |



# BWR DATA TABLES

|    | A            | B    | C    | D     | E     | F     | G     | H     | I     | J     |
|----|--------------|------|------|-------|-------|-------|-------|-------|-------|-------|
| 1  | Enrichment   |      |      |       |       |       |       |       |       |       |
| 2  | 1.5 Gw-d/MTU |      |      |       |       |       |       |       |       |       |
| 3  | Year         | 1    | 10   | 20    | 30    | 40    | 50    | 60    | 70    | 75    |
| 4  | 5            | 10.2 | 99.5 | 198.2 | 198.2 | 434.6 | 579.7 | 739.2 | 907.1 | 992.4 |
| 5  | 6            | 8.4  | 83.8 | 169.5 | 169.5 | 382.6 | 515.5 | 665.8 | 823.5 | 903.8 |
| 6  | 7            | 7.5  | 75.1 | 151.8 | 151.8 | 347.9 | 473.5 | 614.7 | 763.4 | 840.6 |
| 7  | 8            | 7    | 69.8 | 141.3 | 141.3 | 324.4 | 442.9 | 575.8 | 718.4 | 791.6 |
| 8  | 9            | 6.7  | 66.1 | 133.9 | 133.9 | 306.1 | 419.4 | 546.2 | 681.8 | 751.9 |
| 9  | 10           | 6.4  | 63.5 | 127.5 | 127.5 | 292   | 400.1 | 521.8 | 652.3 | 719.5 |
| 10 | 11           | 6.2  | 61.4 | 123.4 | 123.4 | 280.5 | 384   | 501.6 | 626   | 690.2 |
| 11 | 12           | 6    | 59.6 | 119.6 | 119.6 | 271   | 371   | 482.6 | 602.9 | 665   |
| 12 | 13           | 5.8  | 57.9 | 116.2 | 116.2 | 262.6 | 358.1 | 465.6 | 582   | 642   |
| 13 | 14           | 5.7  | 56.5 | 113.3 | 113.3 | 254.3 | 346.4 | 451.8 | 563.1 | 620.2 |
| 14 | 15           | 5.5  | 55.3 | 110.6 | 110.6 | 247.3 | 336.7 | 437.1 | 545.3 | 601.4 |
| 15 | 16           | 5.4  | 54   | 108.1 | 108.1 | 241.3 | 327.1 | 424.5 | 529.7 | 582.8 |
| 16 | 17           | 5.2  | 52.9 | 105.9 | 105.9 | 235.4 | 318.6 | 412.9 | 513.1 | 565.2 |
| 17 | 18           | 5.1  | 51.8 | 103.7 | 103.7 | 229.6 | 310.2 | 400.5 | 498.6 | 547.7 |
| 18 | 19           | 5    | 50.7 | 101.6 | 101.6 | 224   | 302.8 | 390   | 484.2 | 532.2 |
| 19 | 20           | 4.9  | 49.7 | 99.7  | 99.7  | 218.3 | 295.5 | 379.7 | 470.8 | 516.8 |
| 20 | 21           | 4.7  | 48.8 | 97.7  | 97.7  | 213.8 | 287.2 | 370.3 | 457.5 | 502.5 |
| 21 | 22           | 4.6  | 47.8 | 96    | 96    | 209.3 | 280.9 | 360.1 | 444.2 | 489.2 |
| 22 | 23           | 4.5  | 46.9 | 94.3  | 94.3  | 204.9 | 273.7 | 350.8 | 432.9 | 474.9 |
| 23 | 24           | 4.4  | 46.1 | 92.6  | 92.6  | 200.6 | 267.5 | 342.6 | 421.7 | 462.7 |
| 24 | 25           | 4.3  | 45.2 | 90.9  | 90.9  | 196.2 | 261.3 | 332.4 | 410.5 | 449.5 |
| 25 | 26           | 4.2  | 44.5 | 89.3  | 89.3  | 192   | 255.1 | 325.2 | 399.3 | 437.3 |
| 26 | 27           | 4.1  | 43.6 | 87.8  | 87.8  | 187.8 | 249   | 317.1 | 389.1 | 426.2 |
| 27 | 28           | 4    | 42.8 | 86.4  | 86.4  | 183.7 | 243.9 | 309   | 379   | 414   |
| 28 | 29           | 3.9  | 42.1 | 84.8  | 84.8  | 180.6 | 238.8 | 301.8 | 368.9 | 403.9 |
| 29 | 30           | 3.9  | 41.3 | 83.4  | 83.4  | 176.5 | 233.7 | 294.7 | 359.8 | 393.8 |
| 30 | 31           | 3.8  | 40.7 | 82    | 82    | 173.1 | 228.6 | 287.7 | 351.7 | 383.7 |
| 31 | 32           | 3.7  | 40   | 80.7  | 80.7  | 169.7 | 223.5 | 280.6 | 342.6 | 373.6 |
| 32 | 33           | 3.6  | 39.2 | 79.3  | 79.3  | 166.4 | 218.5 | 274.5 | 333.5 | 363.5 |
| 33 | 34           | 3.5  | 38.7 | 78.1  | 78.1  | 163.3 | 213.4 | 268.4 | 325.5 | 354.5 |
| 34 | 35           | 3.5  | 38   | 76.8  | 76.8  | 160.1 | 209.4 | 262.4 | 317.4 | 345.4 |
| 35 | 36           | 3.4  | 37.4 | 75.6  | 75.6  | 157.1 | 204.5 | 256.4 | 309.4 | 336.4 |
| 36 | 37           | 3.3  | 36.8 | 74.4  | 74.4  | 154.2 | 199.8 | 250.3 | 302.3 | 329.3 |
| 37 | 38           | 3.3  | 36.1 | 73.2  | 73.2  | 151.2 | 196.1 | 244.3 | 294.3 | 320.3 |
| 38 | 39           | 3.2  | 35.6 | 72.1  | 72.1  | 148.4 | 192   | 238.2 | 287.3 | 312.3 |
| 39 | 40           | 3.1  | 35   | 71    | 71    | 145.7 | 188.2 | 234.2 | 280.2 | 305.2 |
| 40 | 41           | 3.1  | 34.3 | 69.9  | 69.9  | 143.1 | 184.4 | 228.2 | 274.2 | 298.2 |
| 41 | 42           | 3    | 33.9 | 68.8  | 68.8  | 140.5 | 180.8 | 223.2 | 268.2 | 291.2 |
| 42 | 43           | 2.9  | 33.3 | 67.8  | 67.8  | 137.9 | 177.1 | 219.2 | 262.2 | 284.2 |
| 43 | 44           | 2.9  | 32.8 | 66.8  | 66.8  | 135.5 | 173.6 | 213.7 | 256.1 | 277.1 |
| 44 | 45           | 2.8  | 32.2 | 65.8  | 65.8  | 133.1 | 170.2 | 209.3 | 250.1 | 270.1 |
| 45 | 46           | 2.7  | 31.8 | 64.8  | 64.8  | 130.8 | 166.9 | 205   | 245.1 | 264.1 |
| 46 | 47           | 2.7  | 31.3 | 63.8  | 63.8  | 128.6 | 163.8 | 200.7 | 239.1 | 258.1 |
| 47 | 48           | 2.6  | 30.8 | 62.9  | 62.9  | 126.4 | 160.7 | 196.5 | 234.1 | 252.1 |
| 48 | 49           | 2.6  | 30.3 | 62    | 62    | 124.2 | 157.6 | 192.4 | 228.4 | 247.1 |
| 49 | 50           | 2.5  | 29.9 | 61    | 61    | 122.1 | 154.7 | 188.3 | 223.1 | 241.1 |
| 50 | 51           | 2.5  | 29.4 | 60.2  | 60.2  | 120.1 | 151.8 | 185.3 | 218.8 | 235.9 |
| 51 | 52           | 2.4  | 29   | 59.4  | 59.4  | 118   | 149.1 | 181.2 | 213.5 | 230.5 |
| 52 | 53           | 2.4  | 28.6 | 58.6  | 58.6  | 116   | 146.3 | 177.6 | 209.4 | 225.2 |
| 53 | 54           | 2.3  | 28.2 | 57.8  | 57.8  | 114.1 | 143.6 | 174.1 | 205.2 | 220   |
| 54 | 55           | 2.3  | 27.8 | 56.9  | 56.9  | 112.3 | 141   | 170.6 | 201.2 | 215.8 |
| 55 | 56           | 2.2  | 27.4 | 56.1  | 56.1  | 110.5 | 138.6 | 167.3 | 196   | 210.5 |
| 56 | 57           | 2.2  | 27   | 55.4  | 55.4  | 108.8 | 136.1 | 164.1 | 192   | 206.5 |
| 57 | 58           | 2.2  | 26.6 | 54.6  | 54.6  | 107   | 133.7 | 161   | 188.1 | 202.4 |
| 58 | 59           | 2.1  | 26.2 | 53.9  | 53.9  | 105.4 | 131.4 | 157.9 | 184.2 | 197.4 |
| 59 | 60           | 2.1  | 25.8 | 53.2  | 53.2  | 103.7 | 129.2 | 155   | 180.4 | 193.5 |

# BWR DATA TABLES

|      | A            | B   | C    | D    | E    | F     | G     | H     | I     | J     |
|------|--------------|-----|------|------|------|-------|-------|-------|-------|-------|
| 1    | Enrichment   |     |      |      |      |       |       |       |       |       |
| 2    | 1.5 Gw-d/MTU |     |      |      |      |       |       |       |       |       |
| Year |              | 1   | 10   | 20   | 30   | 40    | 50    | 60    | 70    | 75    |
| 59   | 61           | 2   | 25.5 | 52.5 | 52.5 | 102.1 | 127   | 152.1 | 177.6 | 189.6 |
| 60   | 62           | 2   | 25.1 | 51.8 | 51.8 | 100.6 | 124.8 | 149.3 | 173.8 | 185.8 |
| 61   | 63           | 2   | 24.8 | 51.2 | 51.2 | 99.1  | 122.8 | 146.6 | 170.3 | 181.9 |
| 62   | 64           | 1.9 | 24.4 | 50.5 | 50.5 | 97.6  | 120.7 | 143.9 | 166.9 | 178.2 |
| 63   | 65           | 1.9 | 24.1 | 49.9 | 49.9 | 96.1  | 118.7 | 141.4 | 163.8 | 174.5 |
| 64   | 66           | 1.9 | 23.8 | 49.2 | 49.2 | 94.7  | 116.8 | 138.9 | 160.6 | 171.8 |
| 65   | 67           | 1.8 | 23.5 | 48.6 | 48.6 | 93.4  | 114.9 | 136.4 | 157.6 | 168.1 |
| 66   | 68           | 1.8 | 23.2 | 48   | 48   | 92    | 113.1 | 134   | 154.6 | 164.8 |
| 67   | 69           | 1.8 | 22.9 | 47.4 | 47.4 | 90.8  | 111.4 | 131.7 | 151.8 | 161.6 |
| 68   | 70           | 1.7 | 22.6 | 46.8 | 46.8 | 89.4  | 109.6 | 129.5 | 149   | 158.6 |
| 69   | 71           | 1.7 | 22.3 | 46.2 | 46.2 | 88.2  | 107.9 | 127.3 | 146.3 | 155.6 |
| 70   | 72           | 1.7 | 22   | 45.7 | 45.7 | 86.9  | 106.2 | 125.1 | 143.6 | 152.6 |
| 71   | 73           | 1.6 | 21.7 | 45.1 | 45.1 | 85.7  | 104.7 | 123.1 | 141.1 | 149.8 |
| 72   | 74           | 1.6 | 21.4 | 44.6 | 44.6 | 84.6  | 103.1 | 121.1 | 138.6 | 147.1 |
| 73   | 75           | 1.6 | 21.1 | 44.1 | 44.1 | 83.4  | 101.6 | 119.1 | 136.1 | 144.5 |
| 74   | 76           | 1.6 | 20.9 | 43.6 | 43.6 | 82.3  | 100.1 | 117.2 | 133.7 | 141.8 |
| 75   | 77           | 1.5 | 20.6 | 43   | 43   | 81.2  | 98.5  | 115.3 | 131.5 | 139.4 |
| 76   | 78           | 1.5 | 20.4 | 42.6 | 42.6 | 80.2  | 97.1  | 113.5 | 129.2 | 136.9 |
| 77   | 79           | 1.5 | 20.2 | 42.2 | 42.2 | 79.1  | 95.8  | 111.7 | 127   | 134.5 |
| 78   | 80           | 1.4 | 19.9 | 41.6 | 41.6 | 78.2  | 94.4  | 110   | 124.9 | 132.2 |
| 79   | 81           | 1.4 | 19.7 | 41.2 | 41.2 | 77.1  | 93.1  | 108.3 | 122.9 | 129.9 |
| 80   | 82           | 1.4 | 19.5 | 40.7 | 40.7 | 76.1  | 91.8  | 106.7 | 120.8 | 127.7 |
| 81   | 83           | 1.4 | 19.3 | 40.3 | 40.3 | 75.2  | 90.5  | 105.1 | 118.9 | 125.5 |
| 82   | 84           | 1.4 | 19   | 39.9 | 39.9 | 74.3  | 89.3  | 103.5 | 117   | 123.4 |
| 83   | 85           | 1.3 | 18.8 | 39.5 | 39.5 | 73.4  | 88.1  | 102   | 115.1 | 121.5 |
| 84   | 86           | 1.3 | 18.6 | 39   | 39   | 72.5  | 87    | 100.5 | 113.3 | 119.5 |
| 85   | 87           | 1.3 | 18.4 | 38.7 | 38.7 | 71.6  | 85.8  | 99.1  | 111.5 | 117.6 |
| 86   | 88           | 1.3 | 18.2 | 38.2 | 38.2 | 70.8  | 84.7  | 97.7  | 109.9 | 115.7 |
| 87   | 89           | 1.2 | 18   | 37.9 | 37.9 | 69.9  | 83.6  | 96.3  | 108.2 | 113.9 |
| 88   | 90           | 1.2 | 17.8 | 37.5 | 37.5 | 69.2  | 82.5  | 95    | 106.6 | 112.1 |
| 89   | 91           | 1.2 | 17.7 | 37.1 | 37.1 | 68.4  | 81.5  | 93.6  | 105   | 110.4 |
| 90   | 92           | 1.2 | 17.4 | 36.7 | 36.7 | 67.6  | 80.5  | 92.4  | 103.5 | 108.7 |
| 91   | 93           | 1.2 | 17.2 | 36.4 | 36.4 | 66.8  | 79.5  | 91.1  | 101.9 | 107.1 |
| 92   | 94           | 1.2 | 17.1 | 36   | 36   | 66.1  | 78.6  | 89.9  | 100.5 | 105.6 |
| 93   | 95           | 1.1 | 16.9 | 35.7 | 35.7 | 65.3  | 77.6  | 88.8  | 99.1  | 103.9 |
| 94   | 96           | 1.1 | 16.8 | 35.3 | 35.3 | 64.6  | 76.7  | 87.6  | 97.7  | 102.5 |
| 95   | 97           | 1.1 | 16.6 | 35   | 35   | 63.9  | 75.8  | 86.5  | 96.4  | 101   |
| 96   | 98           | 1.1 | 16.5 | 34.7 | 34.7 | 63.3  | 74.9  | 85.4  | 95    | 99.5  |
| 97   | 99           | 1.1 | 16.3 | 34.4 | 34.4 | 62.6  | 74.1  | 84.3  | 93.7  | 98.1  |
| 98   | 100          | 1.1 | 16.1 | 34.1 | 34.1 | 61.9  | 73.2  | 83.3  | 92.5  | 96.8  |
| 99   | 110          | 0.9 | 14.7 | 31.4 | 31.4 | 56.2  | 65.7  | 74.1  | 81.5  | 84.9  |
| 100  | 120          | 0.8 | 13.6 | 29   | 29   | 51.5  | 59.7  | 66.8  | 72.9  | 75.7  |
| 101  | 130          | 0.7 | 12.7 | 27.2 | 27.2 | 47.6  | 54.9  | 60.9  | 66    | 68.3  |
| 102  | 140          | 0.7 | 11.9 | 25.6 | 25.6 | 44.5  | 50.9  | 56.1  | 60.5  | 62.4  |
| 103  | 150          | 0.6 | 11.3 | 24.3 | 24.3 | 41.9  | 47.6  | 52.3  | 56    | 57.7  |
| 104  | 160          | 0.6 | 10.8 | 23.2 | 23.2 | 39.6  | 44.8  | 49    | 52.4  | 53.8  |
| 105  | 170          | 0.5 | 10.4 | 22.4 | 22.4 | 37.7  | 42.6  | 46.3  | 49.3  | 50.6  |
| 106  | 180          | 0.5 | 10   | 21.5 | 21.5 | 36.1  | 40.6  | 44    | 46.7  | 47.8  |
| 107  | 190          | 0.5 | 9.7  | 20.9 | 20.9 | 34.7  | 38.8  | 42    | 44.4  | 45.6  |
| 108  | 200          | 0.5 | 9.4  | 20.2 | 20.2 | 33.4  | 37.4  | 40.3  | 42.6  | 43.6  |
| 109  | 250          | 0.4 | 8.5  | 18   | 18   | 29    | 32    | 34.3  | 36    | 36.7  |
| 110  | 300          | 0.4 | 7.9  | 16.5 | 16.5 | 26    | 28.5  | 30.3  | 31.9  | 32.5  |
| 111  | 350          | 0.4 | 7.4  | 15.3 | 15.3 | 23.8  | 26    | 27.6  | 28.9  | 29.5  |
| 112  | 400          | 0.4 | 7    | 14.3 | 14.3 | 21.9  | 23.9  | 25.4  | 26.5  | 27.1  |
| 113  | 450          | 0.4 | 6.6  | 13.5 | 13.5 | 20.4  | 22.2  | 23.6  | 24.7  | 25.2  |
| 114  | 500          | 0.4 | 6.3  | 12.7 | 12.7 | 19.1  | 20.8  | 22    | 23.1  | 23.5  |
| 115  | 550          | 0.4 | 6    | 12   | 12   | 18    | 19.5  | 20.7  | 21.7  | 22.1  |
| 116  | 600          | 0.4 | 5.7  | 11.3 | 11.3 | 16.9  | 18.4  | 19.5  | 20.5  | 20.9  |
| 117  | 650          | 0.4 | 5.5  | 10.7 | 10.7 | 16    | 17.4  | 18.5  | 19.4  | 19.8  |
| 118  | 700          | 0.4 | 5.2  | 10.2 | 10.2 | 15.2  | 16.5  | 17.5  | 18.4  | 18.8  |
| 119  | 750          | 0.4 | 5    | 9.7  | 9.7  | 14.4  | 15.7  | 16.7  | 17.5  | 17.9  |
| 120  | 800          | 0.4 | 4.8  | 9.3  | 9.3  | 13.7  | 14.9  | 15.9  | 16.7  | 17.1  |
| 121  | 850          | 0.4 | 4.6  | 8.8  | 8.8  | 13.1  | 14.2  | 15.2  | 16    | 16.4  |
| 122  | 900          | 0.4 | 4.5  | 8.5  | 8.5  | 12.5  | 13.6  | 14.5  | 15.3  | 15.7  |
| 123  | 950          | 0.4 | 4.3  | 8.1  | 8.1  | 11.9  | 13    | 13.9  | 14.7  | 15.1  |
| 124  | 1000         | 0.4 | 4.2  | 7.8  | 7.8  | 11.4  | 12.5  | 13.4  | 14.1  | 14.5  |

# BWR DATA TABLES

|    | A            | B    | C     | D     | E     | F     | G     | H     | I     | J      |
|----|--------------|------|-------|-------|-------|-------|-------|-------|-------|--------|
| 1  | Enrichment   |      |       |       |       |       |       |       |       |        |
| 2  | 1.0 Gw-d/MTU |      |       |       |       |       |       |       |       |        |
| 3  | Year         | 1    | 10    | 20    | 30    | 40    | 50    | 60    | 70    | 75     |
| 4  | 5            | 10.4 | 102.2 | 204.2 | 320.1 | 455.1 | 605.9 | 771   | 941.7 | 1027.8 |
| 5  | 6            | 8.5  | 85.2  | 173   | 276.4 | 400   | 540.5 | 695.5 | 857.1 | 938.2  |
| 6  | 7            | 7.6  | 75.6  | 155.1 | 249.1 | 364.1 | 496.5 | 642.3 | 794.8 | 873.9  |
| 7  | 8            | 7    | 69.8  | 143.3 | 231.1 | 338.5 | 463.7 | 602.4 | 748.8 | 823    |
| 8  | 9            | 6.7  | 66    | 134.7 | 217.2 | 319   | 440.1 | 571.8 | 711.1 | 782.2  |
| 9  | 10           | 6.4  | 63.2  | 128.5 | 207.4 | 304.8 | 418.7 | 545.3 | 679.6 | 747.7  |
| 10 | 11           | 6.2  | 60.9  | 123.7 | 198.9 | 292.7 | 402.5 | 524   | 652.3 | 718.4  |
| 11 | 12           | 6    | 59.1  | 119.7 | 192.4 | 281.8 | 387.5 | 504.9 | 628.2 | 692.2  |
| 12 | 13           | 5.8  | 57.6  | 116.3 | 186.1 | 272.9 | 374.6 | 486.9 | 606.2 | 666.2  |
| 13 | 14           | 5.6  | 56.1  | 113.2 | 180.9 | 264.2 | 362.7 | 470.1 | 585.3 | 644.3  |
| 14 | 15           | 5.5  | 54.9  | 110.6 | 175.6 | 256.6 | 351   | 456.3 | 567.5 | 623.6  |
| 15 | 16           | 5.3  | 53.7  | 108   | 171.7 | 250   | 341.4 | 442.7 | 549.8 | 603.9  |
| 16 | 17           | 5.2  | 52.5  | 105.6 | 167.7 | 243.5 | 331.9 | 429.1 | 532.2 | 585.3  |
| 17 | 18           | 5.1  | 51.5  | 103.5 | 163.7 | 237.1 | 323.4 | 417.6 | 515.7 | 567.8  |
| 18 | 19           | 5    | 50.5  | 101.5 | 159.8 | 231.7 | 314   | 405.2 | 501.3 | 550.3  |
| 19 | 20           | 4.8  | 49.6  | 99.4  | 156.6 | 225.5 | 305.6 | 393.8 | 487.9 | 533.9  |
| 20 | 21           | 4.7  | 48.6  | 97.5  | 153.4 | 220.4 | 297.3 | 382.5 | 472.5 | 518.5  |
| 21 | 22           | 4.6  | 47.8  | 95.8  | 150.1 | 215.4 | 291   | 373.1 | 459.2 | 504.2  |
| 22 | 23           | 4.5  | 47    | 94.1  | 147.1 | 210.5 | 282.8 | 362.9 | 447   | 490    |
| 23 | 24           | 4.4  | 46.2  | 92.4  | 144.1 | 205.7 | 275.6 | 353.7 | 434.7 | 475.7  |
| 24 | 25           | 4.3  | 45.3  | 90.8  | 141.3 | 201   | 269.4 | 344.5 | 422.5 | 462.5  |
| 25 | 26           | 4.2  | 44.6  | 89.2  | 138.5 | 196.2 | 263.2 | 335.3 | 411.3 | 450.3  |
| 26 | 27           | 4.1  | 43.8  | 87.6  | 135.9 | 192.6 | 257.1 | 326.1 | 400.2 | 438.2  |
| 27 | 28           | 4    | 43.2  | 86.2  | 133.2 | 188.1 | 250.9 | 319   | 389   | 425    |
| 28 | 29           | 4    | 42.5  | 84.8  | 130.8 | 184.2 | 244.8 | 309.9 | 378.9 | 413.9  |
| 29 | 30           | 3.9  | 41.8  | 83.4  | 128.4 | 180.4 | 239.7 | 302.8 | 369.8 | 402.8  |
| 30 | 31           | 3.8  | 41.2  | 82.1  | 126   | 176.7 | 233.6 | 295.7 | 359.7 | 391.7  |
| 31 | 32           | 3.7  | 40.5  | 80.7  | 123.7 | 173   | 228.6 | 288.6 | 349.6 | 381.6  |
| 32 | 33           | 3.6  | 39.9  | 79.4  | 121.5 | 169.5 | 222.5 | 280.5 | 341.5 | 372.6  |
| 33 | 34           | 3.6  | 39.3  | 78.2  | 119.3 | 166   | 218.4 | 273.5 | 332.5 | 362.5  |
| 34 | 35           | 3.5  | 38.6  | 76.9  | 117.2 | 162.7 | 213.4 | 267.4 | 324.4 | 353.4  |
| 35 | 36           | 3.4  | 38.1  | 75.8  | 115.2 | 159.4 | 209.3 | 261.4 | 316.4 | 343.4  |
| 36 | 37           | 3.4  | 37.5  | 74.6  | 113.1 | 156.3 | 203.6 | 255.3 | 308.3 | 335.3  |
| 37 | 38           | 3.3  | 37    | 73.5  | 111.3 | 153.3 | 199.2 | 249.3 | 301.3 | 326.3  |
| 38 | 39           | 3.2  | 36.4  | 72.4  | 109.4 | 150.2 | 194.8 | 243.3 | 293.3 | 317.3  |
| 39 | 40           | 3.2  | 35.8  | 71.2  | 107.5 | 147.4 | 191.2 | 238.2 | 286.2 | 310.2  |
| 40 | 41           | 3.1  | 35.4  | 70.2  | 105.7 | 144.7 | 187.2 | 232.2 | 279.2 | 302.2  |
| 41 | 42           | 3    | 34.8  | 69.2  | 104   | 142   | 183.3 | 227.2 | 272.2 | 294.2  |
| 42 | 43           | 3    | 34.2  | 68.2  | 102.2 | 139.3 | 179.5 | 221.6 | 265.2 | 287.2  |
| 43 | 44           | 2.9  | 33.8  | 67.2  | 100.6 | 136.7 | 175.7 | 217.2 | 260.2 | 281.2  |
| 44 | 45           | 2.9  | 33.3  | 66.3  | 99    | 134.1 | 172.1 | 211.9 | 253.1 | 274.1  |
| 45 | 46           | 2.8  | 32.8  | 65.3  | 97.4  | 131.7 | 168.7 | 207.7 | 248.1 | 267.1  |
| 46 | 47           | 2.8  | 32.4  | 64.4  | 95.9  | 129.3 | 165.3 | 202.5 | 241.1 | 261.1  |
| 47 | 48           | 2.7  | 32    | 63.4  | 94.4  | 127   | 162.1 | 198.4 | 235.8 | 254.1  |
| 48 | 49           | 2.7  | 31.5  | 62.5  | 92.9  | 124.8 | 158.9 | 194.3 | 230.4 | 249.1  |
| 49 | 50           | 2.6  | 31.1  | 61.7  | 91.4  | 122.7 | 155.7 | 190.3 | 225.1 | 242.4  |
| 50 | 51           | 2.6  | 30.6  | 60.8  | 89.9  | 120.6 | 152.7 | 186.3 | 219.9 | 237.1  |
| 51 | 52           | 2.5  | 30.2  | 60    | 88.6  | 118.5 | 149.8 | 182.4 | 215.8 | 231.8  |
| 52 | 53           | 2.5  | 29.8  | 59.2  | 87.3  | 116.3 | 146.9 | 178.5 | 210.6 | 226.5  |
| 53 | 54           | 2.4  | 29.4  | 58.4  | 85.9  | 114.3 | 144.1 | 174.8 | 205.6 | 221.4  |
| 54 | 55           | 2.4  | 29.1  | 57.6  | 84.7  | 112.4 | 141.4 | 171.2 | 201.6 | 216.2  |
| 55 | 56           | 2.3  | 28.7  | 56.9  | 83.4  | 110.6 | 138.7 | 167.7 | 196.5 | 211.2  |
| 56 | 57           | 2.3  | 28.4  | 56.1  | 82.2  | 108.7 | 136.3 | 164.4 | 192.6 | 207    |
| 57 | 58           | 2.2  | 28    | 55.4  | 81    | 107   | 133.7 | 161.1 | 188.7 | 202.1  |
| 58 | 59           | 2.2  | 27.6  | 54.7  | 79.9  | 105.3 | 131.3 | 157.9 | 184.9 | 198.1  |
| 59 | 60           | 2.2  | 27.3  | 54    | 78.8  | 103.5 | 129   | 154.8 | 181.1 | 193.2  |

# BWR DATA TABLES

|     | A            | B   | C    | D    | E    | F     | G     | H     | I     | J     |
|-----|--------------|-----|------|------|------|-------|-------|-------|-------|-------|
| 1   | Enrichment   |     |      |      |      |       |       |       |       |       |
| 2   | 1.0 Gw-d/MTU |     |      |      |      |       |       |       |       |       |
| 59  | 61           | 2.1 | 26.9 | 53.3 | 77.7 | 101.9 | 126.7 | 151.9 | 177.3 | 189.4 |
| 60  | 62           | 2.1 | 26.6 | 52.7 | 76.6 | 100.4 | 124.5 | 149   | 173.6 | 185.6 |
| 61  | 63           | 2.1 | 26.3 | 52   | 75.5 | 98.8  | 122.4 | 146.1 | 170   | 181.9 |
| 62  | 64           | 2   | 26   | 51.4 | 74.5 | 97.3  | 120.2 | 143.4 | 166.4 | 178.1 |
| 63  | 65           | 2   | 25.7 | 50.8 | 73.5 | 95.8  | 118.2 | 140.7 | 163.1 | 174.5 |
| 64  | 66           | 2   | 25.4 | 50.1 | 72.5 | 94.3  | 116.1 | 138.1 | 159.8 | 170.8 |
| 65  | 67           | 1.9 | 25.1 | 49.6 | 71.6 | 92.9  | 114.3 | 135.6 | 156.6 | 167.3 |
| 66  | 68           | 1.9 | 24.7 | 49   | 70.6 | 91.6  | 112.4 | 133.1 | 153.7 | 163.7 |
| 67  | 69           | 1.9 | 24.4 | 48.4 | 69.7 | 90.2  | 110.6 | 130.7 | 150.6 | 160.5 |
| 68  | 70           | 1.8 | 24.1 | 47.8 | 68.8 | 88.9  | 108.7 | 128.4 | 147.8 | 157.3 |
| 69  | 71           | 1.8 | 23.9 | 47.2 | 67.9 | 87.6  | 106.9 | 126.2 | 145   | 154.3 |
| 70  | 72           | 1.8 | 23.6 | 46.8 | 67   | 86.3  | 105.3 | 124   | 142.2 | 151.2 |
| 71  | 73           | 1.7 | 23.3 | 46.2 | 66.3 | 85.1  | 103.6 | 121.8 | 139.6 | 148.4 |
| 72  | 74           | 1.7 | 23.1 | 45.7 | 65.4 | 84    | 102.1 | 119.7 | 137   | 145.5 |
| 73  | 75           | 1.7 | 22.9 | 45.2 | 64.6 | 82.8  | 100.4 | 117.7 | 134.6 | 142.8 |
| 74  | 76           | 1.7 | 22.6 | 44.8 | 63.8 | 81.6  | 98.9  | 115.7 | 132.1 | 140.1 |
| 75  | 77           | 1.6 | 22.4 | 44.2 | 63.1 | 80.6  | 97.5  | 113.9 | 129.8 | 137.6 |
| 76  | 78           | 1.6 | 22.2 | 43.7 | 62.3 | 79.4  | 96    | 111.9 | 127.4 | 135.1 |
| 77  | 79           | 1.6 | 21.8 | 43.3 | 61.6 | 78.4  | 94.5  | 110.1 | 125.2 | 132.6 |
| 78  | 80           | 1.6 | 21.6 | 42.8 | 60.9 | 77.4  | 93.2  | 108.4 | 123.1 | 130.2 |
| 79  | 81           | 1.5 | 21.4 | 42.4 | 60.2 | 76.4  | 91.9  | 106.7 | 121   | 128   |
| 80  | 82           | 1.5 | 21.2 | 42   | 59.5 | 75.5  | 90.5  | 105   | 119   | 125.6 |
| 81  | 83           | 1.5 | 21   | 41.5 | 58.8 | 74.5  | 89.3  | 103.4 | 116.9 | 123.6 |
| 82  | 84           | 1.5 | 20.8 | 41.1 | 58.2 | 73.6  | 88    | 101.8 | 115   | 121.4 |
| 83  | 85           | 1.4 | 20.6 | 40.7 | 57.5 | 72.6  | 86.7  | 100.2 | 113.1 | 119.4 |
| 84  | 86           | 1.4 | 20.3 | 40.3 | 56.9 | 71.7  | 85.6  | 98.8  | 111.3 | 117.4 |
| 85  | 87           | 1.4 | 20.2 | 39.9 | 56.3 | 70.8  | 84.4  | 97.2  | 109.5 | 115.4 |
| 86  | 88           | 1.4 | 20   | 39.6 | 55.7 | 70    | 83.3  | 95.8  | 107.8 | 113.5 |
| 87  | 89           | 1.4 | 19.8 | 39.2 | 55.1 | 69.2  | 82.2  | 94.4  | 106.1 | 111.7 |
| 88  | 90           | 1.3 | 19.6 | 38.8 | 54.5 | 68.3  | 81.2  | 93.1  | 104.4 | 109.8 |
| 89  | 91           | 1.3 | 19.5 | 38.4 | 54   | 67.6  | 80.1  | 91.8  | 102.8 | 108.1 |
| 90  | 92           | 1.3 | 19.3 | 38   | 53.4 | 66.8  | 79.1  | 90.5  | 101.2 | 106.4 |
| 91  | 93           | 1.3 | 19.1 | 37.8 | 52.9 | 66    | 78.1  | 89.3  | 99.7  | 104.8 |
| 92  | 94           | 1.3 | 18.9 | 37.4 | 52.4 | 65.3  | 77.1  | 88    | 98.3  | 103.2 |
| 93  | 95           | 1.3 | 18.8 | 37.1 | 51.8 | 64.5  | 76.2  | 86.8  | 96.8  | 101.6 |
| 94  | 96           | 1.2 | 18.6 | 36.7 | 51.3 | 63.9  | 75.2  | 85.6  | 95.4  | 100.1 |
| 95  | 97           | 1.2 | 18.5 | 36.4 | 50.8 | 63.2  | 74.3  | 84.6  | 94    | 98.6  |
| 96  | 98           | 1.2 | 18.3 | 36.1 | 50.4 | 62.5  | 73.4  | 83.4  | 92.7  | 97.1  |
| 97  | 99           | 1.2 | 18.1 | 35.8 | 49.8 | 61.9  | 72.5  | 82.3  | 91.4  | 95.8  |
| 98  | 100          | 1.2 | 17.9 | 35.5 | 49.4 | 61.3  | 71.7  | 81.3  | 90.1  | 94.4  |
| 99  | 110          | 1   | 16.6 | 32.8 | 45.3 | 55.5  | 64.3  | 72.2  | 79.2  | 82.5  |
| 100 | 120          | 0.9 | 15.6 | 30.6 | 41.9 | 50.9  | 58.4  | 64.8  | 70.6  | 73.2  |
| 101 | 130          | 0.9 | 14.6 | 28.7 | 39.1 | 47.1  | 53.6  | 59.1  | 63.9  | 66.1  |
| 102 | 140          | 0.8 | 13.8 | 27.3 | 36.8 | 44    | 49.7  | 54.5  | 58.5  | 60.3  |
| 103 | 150          | 0.7 | 13.3 | 25.9 | 34.8 | 41.4  | 46.5  | 50.7  | 54.2  | 55.8  |
| 104 | 160          | 0.7 | 12.7 | 24.9 | 33.2 | 39.2  | 43.9  | 47.6  | 50.6  | 52    |
| 105 | 170          | 0.7 | 12.3 | 24   | 31.9 | 37.4  | 41.7  | 45    | 47.7  | 48.8  |
| 106 | 180          | 0.6 | 11.9 | 23.1 | 30.6 | 35.9  | 39.8  | 42.9  | 45.3  | 46.3  |
| 107 | 190          | 0.6 | 11.6 | 22.4 | 29.5 | 34.5  | 38.1  | 41    | 43.2  | 44.2  |
| 108 | 200          | 0.6 | 11.3 | 21.8 | 28.7 | 33.3  | 36.7  | 39.3  | 41.4  | 42.3  |
| 109 | 250          | 0.6 | 10.3 | 19.5 | 25.2 | 29    | 31.6  | 33.7  | 35.3  | 35.9  |
| 110 | 300          | 0.5 | 9.5  | 17.9 | 22.9 | 26.2  | 28.4  | 30.1  | 31.5  | 32    |
| 111 | 350          | 0.5 | 8.9  | 16.6 | 21.1 | 24    | 26    | 27.5  | 28.7  | 29.2  |
| 112 | 400          | 0.5 | 8.4  | 15.5 | 19.6 | 22.2  | 24    | 25.4  | 26.5  | 26.9  |
| 113 | 450          | 0.5 | 8    | 14.6 | 18.4 | 20.7  | 22.4  | 23.6  | 24.7  | 25.1  |
| 114 | 500          | 0.5 | 7.6  | 13.7 | 17.2 | 19.4  | 21    | 22.1  | 23.1  | 23.6  |
| 115 | 550          | 0.5 | 7.2  | 13   | 16.2 | 18.3  | 19.7  | 20.8  | 21.8  | 22.2  |
| 116 | 600          | 0.5 | 6.8  | 12.3 | 15.3 | 17.2  | 18.6  | 19.7  | 20.6  | 21    |
| 117 | 650          | 0.5 | 6.5  | 11.6 | 14.5 | 16.3  | 17.6  | 18.7  | 19.6  | 20    |
| 118 | 700          | 0.5 | 6.2  | 11   | 13.8 | 15.5  | 16.7  | 17.7  | 18.6  | 19    |
| 119 | 750          | 0.5 | 6    | 10.5 | 13.1 | 14.7  | 15.9  | 16.9  | 17.7  | 18.1  |
| 120 | 800          | 0.5 | 5.7  | 10   | 12.5 | 14    | 15.2  | 16.1  | 16.9  | 17.3  |
| 121 | 850          | 0.5 | 5.5  | 9.6  | 11.9 | 13.4  | 14.5  | 15.4  | 16.2  | 16.6  |
| 122 | 900          | 0.5 | 5.3  | 9.1  | 11.3 | 12.8  | 13.8  | 14.7  | 15.5  | 15.9  |
| 123 | 950          | 0.5 | 5.1  | 8.7  | 10.9 | 12.2  | 13.3  | 14.1  | 14.9  | 15.3  |
| 124 | 1000         | 0.5 | 4.9  | 8.4  | 10.4 | 11.7  | 12.7  | 13.6  | 14.3  | 14.7  |

# BWR DATA TABLES

|    | A            | B    | C     | D     | E     | F     | G     | H     | I     | J      |
|----|--------------|------|-------|-------|-------|-------|-------|-------|-------|--------|
| 1  | Enrichment   |      |       |       |       |       |       |       |       |        |
| 2  | 0.7 Gw-d/MTU |      |       |       |       |       |       |       |       |        |
| 3  | Year         | 1    | 10    | 20    | 30    | 40    | 50    | 60    | 70    | 75     |
| 4  | 5            | 10.5 | 104.2 | 208.5 | 328   | 466.9 | 623.5 | 790.5 | 962.9 | 1050.1 |
| 5  | 6            | 8.6  | 86    | 176.1 | 282.7 | 411.7 | 556.1 | 712.9 | 876.3 | 959.4  |
| 6  | 7            | 7.7  | 75.8  | 156.9 | 254.9 | 373.7 | 510.9 | 658.7 | 814   | 893.1  |
| 7  | 8            | 7.1  | 69.7  | 144   | 236.5 | 349   | 478.1 | 618.7 | 766   | 842.1  |
| 8  | 9            | 6.7  | 65.6  | 135.6 | 222.2 | 329.5 | 452.5 | 587   | 728.3 | 800.4  |
| 9  | 10           | 6.4  | 62.7  | 129.3 | 212.1 | 313.2 | 432   | 561.5 | 695.8 | 765.8  |
| 10 | 11           | 6.2  | 60.4  | 124.3 | 203.1 | 300.1 | 413.8 | 537.2 | 668.4 | 734.5  |
| 11 | 12           | 6    | 58.6  | 120.1 | 196.3 | 290.1 | 398.7 | 517.1 | 642.3 | 706.3  |
| 12 | 13           | 5.8  | 57    | 116.6 | 189.7 | 280.2 | 384.8 | 500.1 | 620.3 | 681.3  |
| 13 | 14           | 5.6  | 55.7  | 113.4 | 184.1 | 271.5 | 372.9 | 482.2 | 599.4 | 658.4  |
| 14 | 15           | 5.5  | 54.4  | 110.7 | 178.6 | 262.8 | 360.2 | 467.4 | 579.6 | 636.6  |
| 15 | 16           | 5.3  | 53.3  | 108.1 | 174.3 | 256.2 | 350.6 | 453.8 | 560.9 | 615.9  |
| 16 | 17           | 5.2  | 52.2  | 105.6 | 170.1 | 248.7 | 340   | 439.2 | 544.3 | 597.3  |
| 17 | 18           | 5.1  | 51.1  | 103.5 | 165.9 | 242.2 | 330.5 | 426.7 | 527.8 | 578.8  |
| 18 | 19           | 5    | 50.2  | 101.4 | 162.4 | 236.8 | 322.1 | 414.2 | 511.3 | 562.3  |
| 19 | 20           | 4.8  | 49.4  | 99.5  | 158.7 | 229.5 | 313.7 | 402.8 | 496.9 | 544.9  |
| 20 | 21           | 4.7  | 48.4  | 97.5  | 155.3 | 224.2 | 305.4 | 391.5 | 482.6 | 528.6  |
| 21 | 22           | 4.6  | 47.6  | 95.8  | 152   | 218.9 | 297.1 | 381.2 | 468.2 | 513.3  |
| 22 | 23           | 4.5  | 46.8  | 94    | 148.7 | 213.7 | 288.8 | 370.9 | 456   | 499    |
| 23 | 24           | 4.4  | 46.1  | 92.4  | 145.7 | 209.8 | 281.6 | 360.7 | 442.7 | 484.7  |
| 24 | 25           | 4.3  | 45.4  | 90.7  | 142.7 | 204.7 | 275.4 | 351.5 | 430.5 | 470.5  |
| 25 | 26           | 4.2  | 44.6  | 89.1  | 139.9 | 199.8 | 268.3 | 341.3 | 418.3 | 457.4  |
| 26 | 27           | 4.1  | 44    | 87.6  | 137.1 | 195.8 | 261.1 | 332.2 | 406.2 | 445.2  |
| 27 | 28           | 4.1  | 43.2  | 86.2  | 134.5 | 191.1 | 255   | 324   | 395   | 432.1  |
| 28 | 29           | 4    | 42.6  | 84.7  | 131.9 | 186.9 | 248.9 | 315.9 | 385.9 | 419.9  |
| 29 | 30           | 3.9  | 42    | 83.3  | 129.3 | 182.9 | 243.8 | 307.8 | 374.8 | 408.8  |
| 30 | 31           | 3.8  | 41.2  | 82    | 126.9 | 178.9 | 237.7 | 299.7 | 364.7 | 397.7  |
| 31 | 32           | 3.7  | 40.7  | 80.8  | 124.6 | 175.1 | 231.6 | 292.6 | 355.6 | 387.6  |
| 32 | 33           | 3.7  | 40.1  | 79.4  | 122.3 | 171.5 | 226.5 | 285.5 | 345.6 | 376.6  |
| 33 | 34           | 3.6  | 39.6  | 78.2  | 120   | 167.9 | 221.5 | 278.5 | 336.5 | 366.5  |
| 34 | 35           | 3.5  | 38.9  | 76.9  | 117.8 | 164.4 | 216.4 | 271.4 | 328.4 | 356.4  |
| 35 | 36           | 3.5  | 38.4  | 75.8  | 115.8 | 161   | 211.6 | 264.4 | 319.4 | 347.4  |
| 36 | 37           | 3.4  | 37.8  | 74.7  | 113.6 | 157.9 | 206.1 | 257.3 | 311.3 | 339.3  |
| 37 | 38           | 3.3  | 37.4  | 73.5  | 111.7 | 154.6 | 201.8 | 252.3 | 303.3 | 329.3  |
| 38 | 39           | 3.3  | 36.8  | 72.3  | 109.8 | 151.5 | 197.5 | 246.3 | 295.3 | 321.3  |
| 39 | 40           | 3.2  | 36.4  | 71.3  | 108   | 148.6 | 193.3 | 240.2 | 288.2 | 313.2  |
| 40 | 41           | 3.2  | 35.9  | 70.2  | 106.1 | 145.7 | 189.2 | 234.2 | 282.2 | 305.2  |
| 41 | 42           | 3.1  | 35.3  | 69.3  | 104.2 | 142.9 | 184.8 | 228.9 | 274.2 | 297.2  |
| 42 | 43           | 3    | 34.9  | 68.3  | 102.5 | 140   | 180.9 | 223.6 | 267.2 | 289.2  |
| 43 | 44           | 3    | 34.4  | 67.3  | 100.8 | 137.4 | 177   | 218.2 | 261.2 | 283.2  |
| 44 | 45           | 2.9  | 33.9  | 66.4  | 99.2  | 134.8 | 173.3 | 213.9 | 255.1 | 275.1  |
| 45 | 46           | 2.9  | 33.5  | 65.4  | 97.6  | 132.3 | 169.7 | 208.8 | 249.1 | 268.1  |
| 46 | 47           | 2.8  | 33.1  | 64.6  | 96    | 129.9 | 166.2 | 204.6 | 243.3 | 262.1  |
| 47 | 48           | 2.8  | 32.6  | 63.7  | 94.4  | 127.5 | 162.8 | 199.6 | 237   | 255.1  |
| 48 | 49           | 2.7  | 32.2  | 62.7  | 93    | 125.2 | 159.5 | 195.5 | 231.7 | 250.1  |
| 49 | 50           | 2.7  | 31.8  | 61.9  | 91.5  | 123   | 156.3 | 190.6 | 226.5 | 243.7  |
| 50 | 51           | 2.6  | 31.5  | 61    | 90.1  | 120.8 | 153.2 | 186.6 | 221.3 | 238.4  |
| 51 | 52           | 2.6  | 31.1  | 60.2  | 88.7  | 118.7 | 150.2 | 182.8 | 216.1 | 232.2  |
| 52 | 53           | 2.6  | 30.7  | 59.4  | 87.2  | 116.5 | 147.3 | 178.9 | 211.1 | 227    |
| 53 | 54           | 2.5  | 30.3  | 58.7  | 85.9  | 114.5 | 144.4 | 175.1 | 206   | 221.9  |
| 54 | 55           | 2.5  | 29.9  | 57.9  | 84.7  | 112.4 | 141.5 | 171.6 | 202.1 | 216.8  |
| 55 | 56           | 2.4  | 29.5  | 57.1  | 83.4  | 110.6 | 138.9 | 167.9 | 197.1 | 211.7  |
| 56 | 57           | 2.4  | 29.2  | 56.4  | 82.2  | 108.7 | 136.3 | 164.5 | 193.1 | 206.7  |
| 57 | 58           | 2.3  | 28.8  | 55.7  | 81    | 106.9 | 133.8 | 161.1 | 188.3 | 202.7  |
| 58 | 59           | 2.3  | 28.5  | 55    | 79.8  | 105.1 | 131.2 | 157.9 | 184.5 | 197.8  |
| 59 | 60           | 2.3  | 28.2  | 54.4  | 78.7  | 103.4 | 128.9 | 154.7 | 180.8 | 193.9  |

BWR DATA TABLES

|     | A            | B   | C    | D    | E    | F     | G     | H     | I     | J     |
|-----|--------------|-----|------|------|------|-------|-------|-------|-------|-------|
| 1   | Enrichment   |     |      |      |      |       |       |       |       |       |
| 2   | 0.7 Gw-d/MTU |     |      |      |      |       |       |       |       |       |
|     | Year         | 1   | 10   | 20   | 30   | 40    | 50    | 60    | 70    | 75    |
| 59  | 61           | 2.2 | 27.9 | 53.7 | 77.6 | 101.8 | 126.5 | 151.7 | 177.1 | 189.1 |
| 60  | 62           | 2.2 | 27.5 | 53   | 76.5 | 100.1 | 124.2 | 148.7 | 173.4 | 185.4 |
| 61  | 63           | 2.2 | 27.2 | 52.3 | 75.5 | 98.5  | 122   | 145.7 | 169.8 | 181.6 |
| 62  | 64           | 2.1 | 26.9 | 51.8 | 74.4 | 97    | 119.9 | 142.9 | 166   | 177   |
| 63  | 65           | 2.1 | 26.6 | 51.1 | 73.4 | 95.4  | 117.8 | 140.3 | 162.6 | 173.3 |
| 64  | 66           | 2.1 | 26.4 | 50.5 | 72.4 | 94    | 115.7 | 137.5 | 159.3 | 169.7 |
| 65  | 67           | 2   | 26.1 | 50   | 71.4 | 92.5  | 113.7 | 135   | 156.1 | 166.2 |
| 66  | 68           | 2   | 25.8 | 49.4 | 70.5 | 91.1  | 111.8 | 132.5 | 153   | 163.1 |
| 67  | 69           | 2   | 25.5 | 48.8 | 69.5 | 89.7  | 109.9 | 130.1 | 150   | 159.7 |
| 68  | 70           | 1.9 | 25.3 | 48.2 | 68.6 | 88.5  | 108.1 | 127.7 | 147   | 156.6 |
| 69  | 71           | 1.9 | 24.9 | 47.7 | 67.8 | 87.1  | 106.4 | 125.4 | 144.1 | 153.5 |
| 70  | 72           | 1.9 | 24.7 | 47.2 | 66.9 | 85.9  | 104.6 | 123.2 | 141.4 | 150.4 |
| 71  | 73           | 1.9 | 24.4 | 46.6 | 66.1 | 84.7  | 102.9 | 121   | 138.8 | 147.4 |
| 72  | 74           | 1.8 | 24.2 | 46.2 | 65.3 | 83.4  | 101.3 | 118.9 | 136.1 | 144.6 |
| 73  | 75           | 1.8 | 24   | 45.7 | 64.5 | 82.2  | 99.7  | 116.8 | 133.6 | 141.8 |
| 74  | 76           | 1.8 | 23.7 | 45.2 | 63.7 | 81.1  | 98.1  | 114.8 | 131.1 | 139.1 |
| 75  | 77           | 1.7 | 23.5 | 44.8 | 62.9 | 80    | 96.6  | 112.9 | 128.7 | 136.5 |
| 76  | 78           | 1.7 | 23.3 | 44.3 | 62.2 | 78.9  | 95.2  | 111   | 126.4 | 133.9 |
| 77  | 79           | 1.7 | 23   | 43.8 | 61.4 | 77.8  | 93.7  | 109.2 | 124.2 | 131.4 |
| 78  | 80           | 1.7 | 22.8 | 43.4 | 60.8 | 76.8  | 92.3  | 107.3 | 122   | 129.1 |
| 79  | 81           | 1.7 | 22.6 | 42.9 | 60.1 | 75.8  | 90.9  | 105.6 | 119.8 | 126.8 |
| 80  | 82           | 1.6 | 22.4 | 42.5 | 59.3 | 74.8  | 89.6  | 103.9 | 117.7 | 124.5 |
| 81  | 83           | 1.6 | 22.2 | 42.1 | 58.6 | 73.9  | 88.4  | 102.3 | 115.7 | 122.3 |
| 82  | 84           | 1.6 | 22   | 41.7 | 58.1 | 72.9  | 87.1  | 100.7 | 113.8 | 120.2 |
| 83  | 85           | 1.6 | 21.7 | 41.2 | 57.4 | 72    | 85.9  | 99.1  | 111.8 | 118.1 |
| 84  | 86           | 1.6 | 21.6 | 40.9 | 56.7 | 71.1  | 84.7  | 97.7  | 110   | 116.1 |
| 85  | 87           | 1.5 | 21.4 | 40.5 | 56.2 | 70.2  | 83.5  | 96.1  | 108.2 | 114.1 |
| 86  | 88           | 1.5 | 21.2 | 40.1 | 55.5 | 69.3  | 82.3  | 94.7  | 106.5 | 112.1 |
| 87  | 89           | 1.5 | 21.1 | 39.8 | 55   | 68.6  | 81.2  | 93.3  | 104.7 | 110.3 |
| 88  | 90           | 1.5 | 20.9 | 39.4 | 54.4 | 67.8  | 80.2  | 91.9  | 103.1 | 108.5 |
| 89  | 91           | 1.5 | 20.6 | 39   | 53.9 | 66.9  | 79.1  | 90.6  | 101.5 | 106.7 |
| 90  | 92           | 1.4 | 20.5 | 38.7 | 53.3 | 66.2  | 78    | 89.3  | 99.9  | 105.1 |
| 91  | 93           | 1.4 | 20.3 | 38.3 | 52.8 | 65.4  | 77    | 88.1  | 98.4  | 103.3 |
| 92  | 94           | 1.4 | 20.2 | 38.1 | 52.2 | 64.7  | 76.1  | 86.8  | 96.9  | 101.7 |
| 93  | 95           | 1.4 | 20.1 | 37.7 | 51.7 | 63.9  | 75.2  | 85.6  | 95.5  | 100.2 |
| 94  | 96           | 1.4 | 19.9 | 37.3 | 51.2 | 63.3  | 74.2  | 84.5  | 94    | 98.6  |
| 95  | 97           | 1.4 | 19.7 | 37.1 | 50.7 | 62.5  | 73.3  | 83.3  | 92.7  | 97.2  |
| 96  | 98           | 1.3 | 19.5 | 36.7 | 50.2 | 61.9  | 72.4  | 82.2  | 91.3  | 95.7  |
| 97  | 99           | 1.3 | 19.4 | 36.4 | 49.8 | 61.2  | 71.6  | 81.1  | 90    | 94.3  |
| 98  | 100          | 1.3 | 19.3 | 36.2 | 49.4 | 60.6  | 70.7  | 80.1  | 88.7  | 93    |
| 99  | 110          | 1.2 | 18   | 33.5 | 45.3 | 54.9  | 63.3  | 70.9  | 77.8  | 81    |
| 100 | 120          | 1.1 | 16.9 | 31.3 | 41.9 | 50.4  | 57.4  | 63.7  | 69.2  | 71.8  |
| 101 | 130          | 1   | 16   | 29.5 | 39.1 | 46.6  | 52.7  | 58    | 62.6  | 64.7  |
| 102 | 140          | 0.9 | 15.2 | 28   | 36.9 | 43.6  | 48.9  | 53.4  | 57.3  | 59    |
| 103 | 150          | 0.9 | 14.6 | 26.8 | 35   | 41.1  | 45.8  | 49.8  | 53.1  | 54.5  |
| 104 | 160          | 0.8 | 14.1 | 25.7 | 33.4 | 38.9  | 43.2  | 46.8  | 49.6  | 50.9  |
| 105 | 170          | 0.8 | 13.6 | 24.8 | 32   | 37.1  | 41.1  | 44.2  | 46.7  | 47.9  |
| 106 | 180          | 0.8 | 13.2 | 24   | 30.8 | 35.6  | 39.3  | 42.1  | 44.4  | 45.4  |
| 107 | 190          | 0.8 | 12.9 | 23.3 | 29.8 | 34.3  | 37.7  | 40.3  | 42.4  | 43.3  |
| 108 | 200          | 0.7 | 12.6 | 22.6 | 28.9 | 33.2  | 36.3  | 38.8  | 40.7  | 41.6  |
| 109 | 250          | 0.7 | 11.5 | 20.3 | 25.5 | 29    | 31.4  | 33.3  | 34.8  | 35.4  |
| 110 | 300          | 0.7 | 10.6 | 18.6 | 23.2 | 26.2  | 28.3  | 29.9  | 31.2  | 31.7  |
| 111 | 350          | 0.7 | 10   | 17.3 | 21.4 | 24.1  | 26    | 27.4  | 28.6  | 29.1  |
| 112 | 400          | 0.6 | 9.4  | 16.2 | 20   | 22.3  | 24    | 25.3  | 26.4  | 26.9  |
| 113 | 450          | 0.6 | 8.9  | 15.2 | 18.7 | 20.9  | 22.4  | 23.7  | 24.7  | 25.1  |
| 114 | 500          | 0.6 | 8.4  | 14.3 | 17.6 | 19.6  | 21.1  | 22.2  | 23.2  | 23.6  |
| 115 | 550          | 0.6 | 8    | 13.5 | 16.6 | 18.5  | 19.8  | 20.9  | 21.9  | 22.3  |
| 116 | 600          | 0.6 | 7.6  | 12.8 | 15.6 | 17.4  | 18.7  | 19.8  | 20.7  | 21.1  |
| 117 | 650          | 0.6 | 7.3  | 12.1 | 14.8 | 16.5  | 17.8  | 18.8  | 19.6  | 20    |
| 118 | 700          | 0.6 | 6.9  | 11.5 | 14.1 | 15.7  | 16.9  | 17.8  | 18.7  | 19.1  |
| 119 | 750          | 0.6 | 6.6  | 11   | 13.4 | 14.9  | 16.1  | 17    | 17.8  | 18.2  |
| 120 | 800          | 0.6 | 6.3  | 10.4 | 12.7 | 14.2  | 15.3  | 16.2  | 17    | 17.4  |
| 121 | 850          | 0.6 | 6.1  | 10   | 12.1 | 13.5  | 14.6  | 15.5  | 16.3  | 16.7  |
| 122 | 900          | 0.6 | 5.8  | 9.5  | 11.6 | 12.9  | 14    | 14.9  | 15.6  | 16    |
| 123 | 950          | 0.6 | 5.6  | 9.1  | 11.1 | 12.4  | 13.4  | 14.3  | 15    | 15.4  |
| 124 | 1000         | 0.6 | 5.4  | 8.7  | 10.6 | 11.9  | 12.9  | 13.7  | 14.5  | 14.8  |

## **APPENDIX F**

### **MODEL OUTPUT RESULTS**

#### **Description of Data Tables**

The following tables contain the output data resulting from the analyses carried out for this research. The output from the 81 scenarios explored in Chapter 2 appears first, followed by the output from the 162 scenarios discussed in Chapters 3 and 4. Data is organized into tables for each response variable, with the name of the response variable centered at the top of the table. The scenarios are organized by columns, with each row representing a different calendar year of the simulation.

## Chapter 2 Scenarios

| Scenario ID | Allocation Trading Priority | Transportation Thermal Limit | Emplacement Thermal Limit | Utility Loading | YM Open Year | TAD Year | Allocation Trading | YMCap Number |
|-------------|-----------------------------|------------------------------|---------------------------|-----------------|--------------|----------|--------------------|--------------|
| 1           | Age                         | 21.5                         | 14.9                      | OFF             | 2025         | 2020     | 2                  | 7500         |
| 2           | Age                         | 21.5                         | 14.9                      | OFF             | 2025         | 2012     | 2                  | 7500         |
| 3           | Age                         | 21.5                         | 14.9                      | OFF             | 2030         | 2016     | 2                  | 7500         |
| 4           | Age                         | 21.5                         | 14.9                      | OFF             | 2020         | 2016     | 2                  | 7500         |
| 5           | Age                         | 25                           | 14.9                      | OFF             | 2025         | 2016     | 2                  | 7500         |
| 6           | Age                         | 18                           | 14.9                      | OFF             | 2025         | 2016     | 2                  | 7500         |
| 7           | Age                         | 21.5                         | 18                        | OFF             | 2025         | 2016     | 2                  | 7500         |
| 8           | Age                         | 21.5                         | 11.8                      | OFF             | 2025         | 2016     | 2                  | 7500         |
| 9           | Age                         | 21.5                         | 14.9                      | YFF10           | 2025         | 2016     | 2                  | 7500         |
| 10          | Age                         | 21.5                         | 14.9                      | YFF10           | 2025         | 2020     | 2                  | 7500         |
| 11          | Age                         | 21.5                         | 14.9                      | YFF10           | 2025         | 2012     | 2                  | 7500         |
| 12          | Age                         | 21.5                         | 14.9                      | YFF10           | 2030         | 2016     | 2                  | 7500         |
| 13          | Age                         | 21.5                         | 14.9                      | YFF10           | 2020         | 2016     | 2                  | 7500         |
| 14          | Age                         | 25                           | 14.9                      | YFF10           | 2025         | 2016     | 2                  | 7500         |
| 15          | Age                         | 18                           | 14.9                      | YFF10           | 2025         | 2016     | 2                  | 7500         |
| 16          | Age                         | 21.5                         | 18                        | YFF10           | 2025         | 2016     | 2                  | 7500         |
| 17          | Age                         | 21.5                         | 11.8                      | YFF10           | 2025         | 2016     | 2                  | 7500         |
| 18          | Age                         | 21.5                         | 14.9                      | YFF10           | 2025         | 2016     | 2                  | 7500         |
| 19          | Age                         | 21.5                         | 14.9                      | YFF5            | 2025         | 2020     | 2                  | 7500         |
| 20          | Age                         | 21.5                         | 14.9                      | YFF5            | 2025         | 2012     | 2                  | 7500         |
| 21          | Age                         | 21.5                         | 14.9                      | YFF5            | 2030         | 2016     | 2                  | 7500         |
| 22          | Age                         | 21.5                         | 14.9                      | YFF5            | 2020         | 2016     | 2                  | 7500         |
| 23          | Age                         | 25                           | 14.9                      | YFF5            | 2025         | 2016     | 2                  | 7500         |
| 24          | Age                         | 18                           | 14.9                      | YFF5            | 2025         | 2016     | 2                  | 7500         |
| 25          | Age                         | 21.5                         | 18                        | YFF5            | 2025         | 2016     | 2                  | 7500         |
| 26          | Age                         | 21.5                         | 11.8                      | YFF5            | 2025         | 2016     | 2                  | 7500         |
| 27          | Age                         | 21.5                         | 14.9                      | YFF5            | 2025         | 2016     | 2                  | 7500         |
| 28          | Age                         | 21.5                         | 14.9                      | OFF             | 2025         | 2020     | 3                  | 14000        |
| 29          | Age                         | 21.5                         | 14.9                      | OFF             | 2025         | 2012     | 3                  | 14000        |
| 30          | Age                         | 21.5                         | 14.9                      | OFF             | 2030         | 2016     | 3                  | 14000        |
| 31          | Age                         | 21.5                         | 14.9                      | OFF             | 2020         | 2016     | 3                  | 14000        |
| 32          | Age                         | 25                           | 14.9                      | OFF             | 2025         | 2016     | 3                  | 14000        |
| 33          | Age                         | 18                           | 14.9                      | OFF             | 2025         | 2016     | 3                  | 14000        |
| 34          | Age                         | 21.5                         | 18                        | OFF             | 2025         | 2016     | 3                  | 14000        |
| 35          | Age                         | 21.5                         | 11.8                      | OFF             | 2025         | 2016     | 3                  | 14000        |
| 36          | Age                         | 21.5                         | 14.9                      | YFF10           | 2025         | 2016     | 3                  | 14000        |
| 37          | Age                         | 21.5                         | 14.9                      | YFF10           | 2025         | 2020     | 3                  | 14000        |
| 38          | Age                         | 21.5                         | 14.9                      | YFF10           | 2025         | 2012     | 3                  | 14000        |
| 39          | Age                         | 21.5                         | 14.9                      | YFF10           | 2030         | 2016     | 3                  | 14000        |
| 40          | Age                         | 21.5                         | 14.9                      | YFF10           | 2020         | 2016     | 3                  | 14000        |
| 41          | Age                         | 25                           | 14.9                      | YFF10           | 2025         | 2016     | 3                  | 14000        |
| 42          | Age                         | 18                           | 14.9                      | YFF10           | 2025         | 2016     | 3                  | 14000        |
| 43          | Age                         | 21.5                         | 18                        | YFF10           | 2025         | 2016     | 3                  | 14000        |
| 44          | Age                         | 21.5                         | 11.8                      | YFF10           | 2025         | 2016     | 3                  | 14000        |
| 45          | Age                         | 21.5                         | 14.9                      | YFF10           | 2025         | 2016     | 3                  | 14000        |
| 46          | Age                         | 21.5                         | 14.9                      | YFF5            | 2025         | 2020     | 3                  | 14000        |
| 47          | Age                         | 21.5                         | 14.9                      | YFF5            | 2025         | 2012     | 3                  | 14000        |
| 48          | Age                         | 21.5                         | 14.9                      | YFF5            | 2030         | 2016     | 3                  | 14000        |
| 49          | Age                         | 21.5                         | 14.9                      | YFF5            | 2020         | 2016     | 3                  | 14000        |
| 50          | Age                         | 25                           | 14.9                      | YFF5            | 2025         | 2016     | 3                  | 14000        |
| 51          | Age                         | 18                           | 14.9                      | YFF5            | 2025         | 2016     | 3                  | 14000        |
| 52          | Age                         | 21.5                         | 18                        | YFF5            | 2025         | 2016     | 3                  | 14000        |
| 53          | Age                         | 21.5                         | 11.8                      | YFF5            | 2025         | 2016     | 3                  | 14000        |
| 54          | Age                         | 21.5                         | 14.9                      | YFF5            | 2025         | 2016     | 3                  | 14000        |
| 55          | Capacity                    | 21.5                         | 14.9                      | OFF             | 2025         | 2020     | 3                  | 7500         |
| 56          | Capacity                    | 21.5                         | 14.9                      | OFF             | 2025         | 2012     | 3                  | 7500         |
| 57          | Capacity                    | 21.5                         | 14.9                      | OFF             | 2030         | 2016     | 3                  | 7500         |
| 58          | Capacity                    | 21.5                         | 14.9                      | OFF             | 2020         | 2016     | 3                  | 7500         |
| 59          | Capacity                    | 25                           | 14.9                      | OFF             | 2025         | 2016     | 3                  | 7500         |
| 60          | Capacity                    | 18                           | 14.9                      | OFF             | 2025         | 2016     | 3                  | 7500         |
| 61          | Capacity                    | 21.5                         | 18                        | OFF             | 2025         | 2016     | 3                  | 7500         |
| 62          | Capacity                    | 21.5                         | 11.8                      | OFF             | 2025         | 2016     | 3                  | 7500         |
| 63          | Capacity                    | 21.5                         | 14.9                      | YFF10           | 2025         | 2016     | 3                  | 7500         |



## Chapter 2 Scenarios

| Scenario ID | Allocation Trading Priority | Transportation Thermal Limit | Emplacement Thermal Limit | Utility Loading | YM Open Year | TAD Year | Allocation Trading | YMCap Number |
|-------------|-----------------------------|------------------------------|---------------------------|-----------------|--------------|----------|--------------------|--------------|
| 64          | Capacity                    | 21.5                         | 14.9                      | YFF10           | 2025         | 2020     | 3                  | 7500         |
| 65          | Capacity                    | 21.5                         | 14.9                      | YFF10           | 2025         | 2012     | 3                  | 7500         |
| 66          | Capacity                    | 21.5                         | 14.9                      | YFF10           | 2030         | 2016     | 3                  | 7500         |
| 67          | Capacity                    | 21.5                         | 14.9                      | YFF10           | 2020         | 2016     | 3                  | 7500         |
| 68          | Capacity                    | 25                           | 14.9                      | YFF10           | 2025         | 2016     | 3                  | 7500         |
| 69          | Capacity                    | 18                           | 14.9                      | YFF10           | 2025         | 2016     | 3                  | 7500         |
| 70          | Capacity                    | 21.5                         | 18                        | YFF10           | 2025         | 2016     | 3                  | 7500         |
| 71          | Capacity                    | 21.5                         | 11.8                      | YFF10           | 2025         | 2016     | 3                  | 7500         |
| 72          | Capacity                    | 21.5                         | 14.9                      | YFF10           | 2025         | 2016     | 3                  | 7500         |
| 73          | Capacity                    | 21.5                         | 14.9                      | YFF5            | 2025         | 2020     | 3                  | 7500         |
| 74          | Capacity                    | 21.5                         | 14.9                      | YFF5            | 2025         | 2012     | 3                  | 7500         |
| 75          | Capacity                    | 21.5                         | 14.9                      | YFF5            | 2030         | 2016     | 3                  | 7500         |
| 76          | Capacity                    | 21.5                         | 14.9                      | YFF5            | 2020         | 2016     | 3                  | 7500         |
| 77          | Capacity                    | 25                           | 14.9                      | YFF5            | 2025         | 2016     | 3                  | 7500         |
| 78          | Capacity                    | 18                           | 14.9                      | YFF5            | 2025         | 2016     | 3                  | 7500         |
| 79          | Capacity                    | 21.5                         | 18                        | YFF5            | 2025         | 2016     | 3                  | 7500         |
| 80          | Capacity                    | 21.5                         | 11.8                      | YFF5            | 2025         | 2016     | 3                  | 7500         |
| 81          | Capacity                    | 21.5                         | 14.9                      | YFF5            | 2025         | 2016     | 3                  | 7500         |

| ScenarioID / Year | 1  | 2 | 3 | 4 | 5 | 6 | 7 | 8  | 9 | 10  | 11 |
|-------------------|----|---|---|---|---|---|---|----|---|-----|----|
| 2002              | 0  | 0 | 0 | 0 | 0 | 0 | 0 | 0  | 0 | 0   | 0  |
| 2003              | 0  | 0 | 0 | 0 | 0 | 0 | 0 | 0  | 0 | 0   | 0  |
| 2004              | 0  | 0 | 0 | 0 | 0 | 0 | 0 | 0  | 0 | 0   | 0  |
| 2005              | 0  | 0 | 0 | 0 | 0 | 0 | 0 | 0  | 0 | 0   | 0  |
| 2006              | 0  | 0 | 0 | 0 | 0 | 0 | 0 | 0  | 0 | 6   | 6  |
| 2007              | 0  | 0 | 0 | 0 | 0 | 0 | 0 | 0  | 0 | 6   | 6  |
| 2008              | 0  | 0 | 0 | 0 | 0 | 0 | 0 | 3  | 0 | 16  | 16 |
| 2009              | 0  | 0 | 0 | 0 | 0 | 0 | 0 | 9  | 0 | 25  | 25 |
| 2010              | 0  | 0 | 0 | 0 | 0 | 0 | 0 | 18 | 0 | 45  | 45 |
| 2011              | 0  | 0 | 0 | 0 | 0 | 0 | 0 | 38 | 0 | 61  | 61 |
| 2012              | 1  | 0 | 1 | 1 | 1 | 1 | 0 | 55 | 1 | 69  | 41 |
| 2013              | 0  | 0 | 0 | 0 | 0 | 0 | 0 | 65 | 0 | 94  | 18 |
| 2014              | 7  | 0 | 7 | 7 | 7 | 7 | 0 | 85 | 7 | 89  | 12 |
| 2015              | 5  | 0 | 5 | 5 | 5 | 5 | 0 | 96 | 5 | 125 | 5  |
| 2016              | 9  | 0 | 2 | 2 | 2 | 2 | 0 | 74 | 2 | 120 | 0  |
| 2017              | 10 | 0 | 1 | 1 | 1 | 1 | 0 | 52 | 1 | 139 | 0  |
| 2018              | 8  | 0 | 0 | 0 | 0 | 0 | 0 | 37 | 0 | 184 | 0  |
| 2019              | 9  | 0 | 0 | 0 | 0 | 0 | 0 | 25 | 0 | 188 | 0  |
| 2020              | 8  | 0 | 0 | 0 | 0 | 0 | 0 | 23 | 0 | 121 | 0  |
| 2021              | 0  | 0 | 0 | 0 | 0 | 0 | 0 | 20 | 0 | 67  | 0  |
| 2022              | 0  | 0 | 0 | 0 | 0 | 0 | 0 | 20 | 0 | 32  | 0  |
| 2023              | 0  | 0 | 0 | 0 | 0 | 0 | 0 | 15 | 0 | 11  | 0  |
| 2024              | 0  | 0 | 0 | 0 | 0 | 0 | 0 | 13 | 0 | 7   | 0  |
| 2025              | 0  | 0 | 0 | 0 | 0 | 0 | 0 | 11 | 0 | 5   | 0  |
| 2026              | 0  | 0 | 0 | 0 | 0 | 0 | 0 | 5  | 0 | 0   | 0  |
| 2027              | 0  | 0 | 0 | 0 | 0 | 0 | 0 | 2  | 0 | 0   | 0  |
| 2028              | 0  | 0 | 0 | 0 | 0 | 0 | 0 | 1  | 0 | 0   | 0  |
| 2029              | 0  | 0 | 0 | 0 | 0 | 0 | 0 | 0  | 0 | 0   | 0  |
| 2030              | 0  | 0 | 0 | 0 | 0 | 0 | 0 | 0  | 0 | 0   | 0  |
| 2031              | 0  | 0 | 0 | 0 | 0 | 0 | 0 | 0  | 0 | 0   | 0  |
| 2032              | 0  | 0 | 0 | 0 | 0 | 0 | 0 | 0  | 0 | 0   | 0  |
| 2033              | 0  | 0 | 0 | 0 | 0 | 0 | 0 | 0  | 0 | 0   | 0  |
| 2034              | 0  | 0 | 0 | 0 | 0 | 0 | 0 | 0  | 0 | 0   | 0  |
| 2035              | 0  | 0 | 0 | 0 | 0 | 0 | 0 | 0  | 0 | 0   | 0  |
| 2036              | 0  | 0 | 0 | 0 | 0 | 0 | 0 | 0  | 0 | 0   | 0  |
| 2037              | 0  | 0 | 0 | 0 | 0 | 0 | 0 | 0  | 0 | 0   | 0  |
| 2038              | 0  | 0 | 0 | 0 | 0 | 0 | 0 | 0  | 0 | 0   | 0  |
| 2039              | 0  | 0 | 0 | 0 | 0 | 0 | 0 | 0  | 0 | 0   | 0  |
| 2040              | 0  | 0 | 0 | 0 | 0 | 0 | 0 | 0  | 0 | 0   | 0  |
| 2041              | 0  | 0 | 0 | 0 | 0 | 0 | 0 | 0  | 0 | 0   | 0  |
| 2042              | 0  | 0 | 0 | 0 | 0 | 0 | 0 | 0  | 0 | 0   | 0  |
| 2043              | 0  | 0 | 0 | 0 | 0 | 0 | 0 | 0  | 0 | 0   | 0  |
| 2044              | 0  | 0 | 0 | 0 | 0 | 0 | 0 | 0  | 0 | 0   | 0  |
| 2045              | 0  | 0 | 0 | 0 | 0 | 0 | 0 | 0  | 0 | 0   | 0  |
| 2046              | 0  | 0 | 0 | 0 | 0 | 0 | 0 | 0  | 0 | 0   | 0  |
| 2047              | 0  | 0 | 0 | 0 | 0 | 0 | 0 | 0  | 0 | 0   | 0  |
| 2048              | 0  | 0 | 0 | 0 | 0 | 0 | 0 | 0  | 0 | 0   | 0  |
| 2049              | 0  | 0 | 0 | 0 | 0 | 0 | 0 | 0  | 0 | 0   | 0  |
| 2050              | 0  | 0 | 0 | 0 | 0 | 0 | 0 | 0  | 0 | 0   | 0  |
| 2051              | 0  | 0 | 0 | 0 | 0 | 0 | 0 | 0  | 0 | 0   | 0  |
| 2052              | 0  | 0 | 0 | 0 | 0 | 0 | 0 | 0  | 0 | 0   | 0  |
| 2053              | 0  | 0 | 0 | 0 | 0 | 0 | 0 | 0  | 0 | 0   | 0  |
| 2054              | 0  | 0 | 0 | 0 | 0 | 0 | 0 | 0  | 0 | 0   | 0  |
| 2055              | 0  | 0 | 0 | 0 | 0 | 0 | 0 | 0  | 0 | 0   | 0  |
| 2056              | 0  | 0 | 0 | 0 | 0 | 0 | 0 | 0  | 0 | 0   | 0  |
| 2057              | 0  | 0 | 0 | 0 | 0 | 0 | 0 | 0  | 0 | 0   | 0  |

| ScenarioID /<br>Year | 1 | 2 | 3 | 4 | 5 | 6 | 7 | 8 | 9 | 10 | 11 |
|----------------------|---|---|---|---|---|---|---|---|---|----|----|
| 2058                 | 0 | 0 | 0 | 0 | 0 | 0 | 0 | 0 | 0 | 0  | 0  |
| 2059                 | 0 | 0 | 0 | 0 | 0 | 0 | 0 | 0 | 0 | 0  | 0  |
| 2060                 | 0 | 0 | 0 | 0 | 0 | 0 | 0 | 0 | 0 | 0  | 0  |
| 2061                 | 0 | 0 | 0 | 0 | 0 | 0 | 0 | 0 | 0 | 0  | 0  |
| 2062                 | 0 | 0 | 0 | 0 | 0 | 0 | 0 | 0 | 0 | 0  | 0  |
| 2063                 | 0 | 0 | 0 | 0 | 0 | 0 | 0 | 0 | 0 | 0  | 0  |
| 2064                 | 0 | 0 | 0 | 0 | 0 | 0 | 0 | 0 | 0 | 0  | 0  |
| 2065                 | 0 | 0 | 0 | 0 | 0 | 0 | 0 | 0 | 0 | 0  | 0  |
| 2066                 | 0 | 0 | 0 | 0 | 0 | 0 | 0 | 0 | 0 | 0  | 0  |
| 2067                 | 0 | 0 | 0 | 0 | 0 | 0 | 0 | 0 | 0 | 0  | 0  |
| 2068                 | 0 | 0 | 0 | 0 | 0 | 0 | 0 | 0 | 0 | 0  | 0  |
| 2069                 | 0 | 0 | 0 | 0 | 0 | 0 | 0 | 0 | 0 | 0  | 0  |
| 2070                 | 0 | 0 | 0 | 0 | 0 | 0 | 0 | 0 | 0 | 0  | 0  |
| 2071                 | 0 | 0 | 0 | 0 | 0 | 0 | 0 | 0 | 0 | 0  | 0  |
| 2072                 | 0 | 0 | 0 | 0 | 0 | 0 | 0 | 0 | 0 | 0  | 0  |
| 2073                 | 0 | 0 | 0 | 0 | 0 | 0 | 0 | 0 | 0 | 0  | 0  |
| 2074                 | 0 | 0 | 0 | 0 | 0 | 0 | 0 | 0 | 0 | 0  | 0  |
| 2075                 | 0 | 0 | 0 | 0 | 0 | 0 | 0 | 0 | 0 | 0  | 0  |
| 2076                 | 0 | 0 | 0 | 0 | 0 | 0 | 0 | 0 | 0 | 0  | 0  |
| 2077                 | 0 | 0 | 0 | 0 | 0 | 0 | 0 | 0 | 0 | 0  | 0  |
| 2078                 | 0 | 0 | 0 | 0 | 0 | 0 | 0 | 0 | 0 | 0  | 0  |
| 2079                 | 0 | 0 | 0 | 0 | 0 | 0 | 0 | 0 | 0 | 0  | 0  |
| 2080                 | 0 | 0 | 0 | 0 | 0 | 0 | 0 | 0 | 0 | 0  | 0  |
| 2081                 | 0 | 0 | 0 | 0 | 0 | 0 | 0 | 0 | 0 | 0  | 0  |
| 2082                 | 0 | 0 | 0 | 0 | 0 | 0 | 0 | 0 | 0 | 0  | 0  |
| 2083                 | 0 | 0 | 0 | 0 | 0 | 0 | 0 | 0 | 0 | 0  | 0  |
| 2084                 | 0 | 0 | 0 | 0 | 0 | 0 | 0 | 0 | 0 | 0  | 0  |
| 2085                 | 0 | 0 | 0 | 0 | 0 | 0 | 0 | 0 | 0 | 0  | 0  |
| 2086                 | 0 | 0 | 0 | 0 | 0 | 0 | 0 | 0 | 0 | 0  | 0  |
| 2087                 | 0 | 0 | 0 | 0 | 0 | 0 | 0 | 0 | 0 | 0  | 0  |
| 2088                 | 0 | 0 | 0 | 0 | 0 | 0 | 0 | 0 | 0 | 0  | 0  |
| 2089                 | 0 | 0 | 0 | 0 | 0 | 0 | 0 | 0 | 0 | 0  | 0  |
| 2090                 | 0 | 0 | 0 | 0 | 0 | 0 | 0 | 0 | 0 | 0  | 0  |

| ScenarioID /<br>Year | 12  | 13  | 14  | 15 | 16 | 17  | 18  | 19  | 20  | 21  | 22  |
|----------------------|-----|-----|-----|----|----|-----|-----|-----|-----|-----|-----|
| 2002                 | 0   | 0   | 0   | 0  | 0  | 0   | 0   | 0   | 0   | 0   | 0   |
| 2003                 | 0   | 0   | 0   | 0  | 0  | 0   | 0   | 0   | 0   | 0   | 0   |
| 2004                 | 0   | 0   | 0   | 0  | 0  | 1   | 0   | 1   | 1   | 1   | 1   |
| 2005                 | 0   | 0   | 1   | 0  | 0  | 3   | 0   | 3   | 3   | 3   | 3   |
| 2006                 | 6   | 6   | 5   | 0  | 0  | 14  | 6   | 13  | 13  | 13  | 13  |
| 2007                 | 6   | 6   | 7   | 2  | 0  | 29  | 6   | 29  | 29  | 29  | 29  |
| 2008                 | 16  | 16  | 20  | 4  | 0  | 52  | 16  | 50  | 50  | 50  | 50  |
| 2009                 | 25  | 25  | 44  | 7  | 0  | 88  | 25  | 91  | 91  | 91  | 91  |
| 2010                 | 45  | 45  | 64  | 10 | 0  | 134 | 45  | 133 | 133 | 133 | 133 |
| 2011                 | 61  | 61  | 107 | 20 | 0  | 204 | 61  | 194 | 194 | 194 | 194 |
| 2012                 | 69  | 69  | 131 | 22 | 2  | 271 | 69  | 234 | 168 | 234 | 234 |
| 2013                 | 94  | 94  | 170 | 29 | 2  | 339 | 94  | 262 | 114 | 262 | 262 |
| 2014                 | 89  | 89  | 196 | 43 | 0  | 432 | 89  | 288 | 79  | 288 | 288 |
| 2015                 | 125 | 125 | 248 | 73 | 2  | 537 | 125 | 338 | 52  | 338 | 338 |
| 2016                 | 58  | 58  | 190 | 45 | 0  | 498 | 58  | 362 | 24  | 251 | 251 |
| 2017                 | 35  | 35  | 141 | 31 | 0  | 452 | 35  | 394 | 12  | 191 | 191 |
| 2018                 | 25  | 25  | 86  | 13 | 0  | 405 | 25  | 476 | 7   | 154 | 154 |
| 2019                 | 12  | 12  | 58  | 10 | 0  | 371 | 12  | 505 | 3   | 109 | 109 |
| 2020                 | 7   | 7   | 35  | 9  | 0  | 317 | 7   | 378 | 3   | 43  | 43  |
| 2021                 | 5   | 5   | 21  | 2  | 0  | 276 | 5   | 343 | 3   | 28  | 28  |
| 2022                 | 5   | 5   | 13  | 2  | 0  | 242 | 5   | 259 | 3   | 13  | 13  |
| 2023                 | 0   | 0   | 11  | 0  | 0  | 200 | 0   | 185 | 3   | 11  | 11  |
| 2024                 | 0   | 0   | 3   | 0  | 0  | 172 | 0   | 119 | 2   | 7   | 7   |
| 2025                 | 0   | 0   | 0   | 0  | 0  | 138 | 0   | 54  | 2   | 7   | 7   |
| 2026                 | 0   | 0   | 0   | 0  | 0  | 92  | 0   | 39  | 0   | 3   | 3   |
| 2027                 | 0   | 0   | 0   | 0  | 0  | 50  | 0   | 24  | 0   | 2   | 2   |
| 2028                 | 0   | 0   | 0   | 0  | 0  | 39  | 0   | 5   | 0   | 0   | 0   |
| 2029                 | 0   | 0   | 0   | 0  | 0  | 28  | 0   | 5   | 0   | 0   | 0   |
| 2030                 | 0   | 0   | 0   | 0  | 0  | 12  | 0   | 5   | 0   | 0   | 0   |
| 2031                 | 0   | 0   | 0   | 0  | 0  | 8   | 0   | 3   | 0   | 0   | 0   |
| 2032                 | 0   | 0   | 0   | 0  | 0  | 7   | 0   | 2   | 0   | 0   | 0   |
| 2033                 | 0   | 0   | 0   | 0  | 0  | 5   | 0   | 0   | 0   | 0   | 0   |
| 2034                 | 0   | 0   | 0   | 0  | 0  | 5   | 0   | 0   | 0   | 0   | 0   |
| 2035                 | 0   | 0   | 0   | 0  | 0  | 0   | 0   | 0   | 0   | 0   | 0   |
| 2036                 | 0   | 0   | 0   | 0  | 0  | 0   | 0   | 0   | 0   | 0   | 0   |
| 2037                 | 0   | 0   | 0   | 0  | 0  | 0   | 0   | 0   | 0   | 0   | 0   |
| 2038                 | 0   | 0   | 0   | 0  | 0  | 0   | 0   | 0   | 0   | 0   | 0   |
| 2039                 | 0   | 0   | 0   | 0  | 0  | 0   | 0   | 0   | 0   | 0   | 0   |
| 2040                 | 0   | 0   | 0   | 0  | 0  | 0   | 0   | 0   | 0   | 0   | 0   |
| 2041                 | 0   | 0   | 0   | 0  | 0  | 0   | 0   | 0   | 0   | 0   | 0   |
| 2042                 | 0   | 0   | 0   | 0  | 0  | 0   | 0   | 0   | 0   | 0   | 0   |
| 2043                 | 0   | 0   | 0   | 0  | 0  | 0   | 0   | 0   | 0   | 0   | 0   |
| 2044                 | 0   | 0   | 0   | 0  | 0  | 0   | 0   | 0   | 0   | 0   | 0   |
| 2045                 | 0   | 0   | 0   | 0  | 0  | 0   | 0   | 0   | 0   | 0   | 0   |
| 2046                 | 0   | 0   | 0   | 0  | 0  | 0   | 0   | 0   | 0   | 0   | 0   |
| 2047                 | 0   | 0   | 0   | 0  | 0  | 0   | 0   | 0   | 0   | 0   | 0   |
| 2048                 | 0   | 0   | 0   | 0  | 0  | 0   | 0   | 0   | 0   | 0   | 0   |
| 2049                 | 0   | 0   | 0   | 0  | 0  | 0   | 0   | 0   | 0   | 0   | 0   |
| 2050                 | 0   | 0   | 0   | 0  | 0  | 0   | 0   | 0   | 0   | 0   | 0   |
| 2051                 | 0   | 0   | 0   | 0  | 0  | 0   | 0   | 0   | 0   | 0   | 0   |
| 2052                 | 0   | 0   | 0   | 0  | 0  | 0   | 0   | 0   | 0   | 0   | 0   |
| 2053                 | 0   | 0   | 0   | 0  | 0  | 0   | 0   | 0   | 0   | 0   | 0   |
| 2054                 | 0   | 0   | 0   | 0  | 0  | 0   | 0   | 0   | 0   | 0   | 0   |
| 2055                 | 0   | 0   | 0   | 0  | 0  | 0   | 0   | 0   | 0   | 0   | 0   |
| 2056                 | 0   | 0   | 0   | 0  | 0  | 0   | 0   | 0   | 0   | 0   | 0   |
| 2057                 | 0   | 0   | 0   | 0  | 0  | 0   | 0   | 0   | 0   | 0   | 0   |

| ScenarioID /<br>Year | 12 | 13 | 14 | 15 | 16 | 17 | 18 | 19 | 20 | 21 | 22 |
|----------------------|----|----|----|----|----|----|----|----|----|----|----|
| 2058                 | 0  | 0  | 0  | 0  | 0  | 0  | 0  | 0  | 0  | 0  | 0  |
| 2059                 | 0  | 0  | 0  | 0  | 0  | 0  | 0  | 0  | 0  | 0  | 0  |
| 2060                 | 0  | 0  | 0  | 0  | 0  | 0  | 0  | 0  | 0  | 0  | 0  |
| 2061                 | 0  | 0  | 0  | 0  | 0  | 0  | 0  | 0  | 0  | 0  | 0  |
| 2062                 | 0  | 0  | 0  | 0  | 0  | 0  | 0  | 0  | 0  | 0  | 0  |
| 2063                 | 0  | 0  | 0  | 0  | 0  | 0  | 0  | 0  | 0  | 0  | 0  |
| 2064                 | 0  | 0  | 0  | 0  | 0  | 0  | 0  | 0  | 0  | 0  | 0  |
| 2065                 | 0  | 0  | 0  | 0  | 0  | 0  | 0  | 0  | 0  | 0  | 0  |
| 2066                 | 0  | 0  | 0  | 0  | 0  | 0  | 0  | 0  | 0  | 0  | 0  |
| 2067                 | 0  | 0  | 0  | 0  | 0  | 0  | 0  | 0  | 0  | 0  | 0  |
| 2068                 | 0  | 0  | 0  | 0  | 0  | 0  | 0  | 0  | 0  | 0  | 0  |
| 2069                 | 0  | 0  | 0  | 0  | 0  | 0  | 0  | 0  | 0  | 0  | 0  |
| 2070                 | 0  | 0  | 0  | 0  | 0  | 0  | 0  | 0  | 0  | 0  | 0  |
| 2071                 | 0  | 0  | 0  | 0  | 0  | 0  | 0  | 0  | 0  | 0  | 0  |
| 2072                 | 0  | 0  | 0  | 0  | 0  | 0  | 0  | 0  | 0  | 0  | 0  |
| 2073                 | 0  | 0  | 0  | 0  | 0  | 0  | 0  | 0  | 0  | 0  | 0  |
| 2074                 | 0  | 0  | 0  | 0  | 0  | 0  | 0  | 0  | 0  | 0  | 0  |
| 2075                 | 0  | 0  | 0  | 0  | 0  | 0  | 0  | 0  | 0  | 0  | 0  |
| 2076                 | 0  | 0  | 0  | 0  | 0  | 0  | 0  | 0  | 0  | 0  | 0  |
| 2077                 | 0  | 0  | 0  | 0  | 0  | 0  | 0  | 0  | 0  | 0  | 0  |
| 2078                 | 0  | 0  | 0  | 0  | 0  | 0  | 0  | 0  | 0  | 0  | 0  |
| 2079                 | 0  | 0  | 0  | 0  | 0  | 0  | 0  | 0  | 0  | 0  | 0  |
| 2080                 | 0  | 0  | 0  | 0  | 0  | 0  | 0  | 0  | 0  | 0  | 0  |
| 2081                 | 0  | 0  | 0  | 0  | 0  | 0  | 0  | 0  | 0  | 0  | 0  |
| 2082                 | 0  | 0  | 0  | 0  | 0  | 0  | 0  | 0  | 0  | 0  | 0  |
| 2083                 | 0  | 0  | 0  | 0  | 0  | 0  | 0  | 0  | 0  | 0  | 0  |
| 2084                 | 0  | 0  | 0  | 0  | 0  | 0  | 0  | 0  | 0  | 0  | 0  |
| 2085                 | 0  | 0  | 0  | 0  | 0  | 0  | 0  | 0  | 0  | 0  | 0  |
| 2086                 | 0  | 0  | 0  | 0  | 0  | 0  | 0  | 0  | 0  | 0  | 0  |
| 2087                 | 0  | 0  | 0  | 0  | 0  | 0  | 0  | 0  | 0  | 0  | 0  |
| 2088                 | 0  | 0  | 0  | 0  | 0  | 0  | 0  | 0  | 0  | 0  | 0  |
| 2089                 | 0  | 0  | 0  | 0  | 0  | 0  | 0  | 0  | 0  | 0  | 0  |
| 2090                 | 0  | 0  | 0  | 0  | 0  | 0  | 0  | 0  | 0  | 0  | 0  |

| ScenarioID / Year | 23  | 24  | 25 | 26  | 27  | 28 | 29 | 30 | 31 | 32 | 33 |
|-------------------|-----|-----|----|-----|-----|----|----|----|----|----|----|
| 2002              | 0   | 0   | 0  | 0   | 0   | 0  | 0  | 0  | 0  | 0  | 0  |
| 2003              | 0   | 0   | 0  | 0   | 0   | 0  | 0  | 0  | 0  | 0  | 0  |
| 2004              | 1   | 1   | 0  | 1   | 1   | 0  | 0  | 0  | 0  | 0  | 0  |
| 2005              | 3   | 2   | 1  | 3   | 3   | 0  | 0  | 0  | 0  | 0  | 0  |
| 2006              | 14  | 13  | 1  | 14  | 13  | 0  | 0  | 0  | 0  | 0  | 0  |
| 2007              | 32  | 27  | 12 | 33  | 29  | 0  | 0  | 0  | 0  | 0  | 0  |
| 2008              | 52  | 30  | 23 | 66  | 50  | 0  | 0  | 0  | 0  | 0  | 0  |
| 2009              | 105 | 58  | 36 | 127 | 91  | 0  | 0  | 0  | 0  | 0  | 0  |
| 2010              | 159 | 78  | 32 | 205 | 133 | 0  | 0  | 0  | 0  | 0  | 0  |
| 2011              | 206 | 115 | 54 | 297 | 194 | 0  | 0  | 0  | 0  | 0  | 0  |
| 2012              | 295 | 124 | 52 | 399 | 234 | 1  | 0  | 1  | 1  | 1  | 1  |
| 2013              | 345 | 153 | 63 | 508 | 262 | 0  | 0  | 0  | 0  | 0  | 0  |
| 2014              | 394 | 174 | 61 | 595 | 288 | 7  | 0  | 7  | 7  | 7  | 7  |
| 2015              | 460 | 208 | 89 | 723 | 338 | 5  | 0  | 5  | 5  | 5  | 5  |
| 2016              | 382 | 155 | 24 | 694 | 251 | 9  | 0  | 2  | 2  | 2  | 2  |
| 2017              | 324 | 109 | 10 | 632 | 191 | 10 | 0  | 1  | 1  | 1  | 1  |
| 2018              | 269 | 72  | 5  | 584 | 154 | 8  | 0  | 0  | 0  | 0  | 0  |
| 2019              | 212 | 58  | 3  | 544 | 109 | 9  | 0  | 0  | 0  | 0  | 0  |
| 2020              | 150 | 50  | 2  | 499 | 43  | 8  | 0  | 0  | 0  | 0  | 0  |
| 2021              | 88  | 41  | 0  | 452 | 28  | 0  | 0  | 0  | 0  | 0  | 0  |
| 2022              | 67  | 31  | 0  | 388 | 13  | 0  | 0  | 0  | 0  | 0  | 0  |
| 2023              | 40  | 24  | 0  | 352 | 11  | 0  | 0  | 0  | 0  | 0  | 0  |
| 2024              | 28  | 11  | 0  | 312 | 7   | 0  | 0  | 0  | 0  | 0  | 0  |
| 2025              | 15  | 9   | 0  | 273 | 7   | 0  | 0  | 0  | 0  | 0  | 0  |
| 2026              | 5   | 2   | 0  | 219 | 3   | 0  | 0  | 0  | 0  | 0  | 0  |
| 2027              | 4   | 2   | 0  | 175 | 2   | 0  | 0  | 0  | 0  | 0  | 0  |
| 2028              | 0   | 0   | 0  | 157 | 0   | 0  | 0  | 0  | 0  | 0  | 0  |
| 2029              | 0   | 0   | 0  | 117 | 0   | 0  | 0  | 0  | 0  | 0  | 0  |
| 2030              | 0   | 0   | 0  | 74  | 0   | 0  | 0  | 0  | 0  | 0  | 0  |
| 2031              | 0   | 0   | 0  | 34  | 0   | 0  | 0  | 0  | 0  | 0  | 0  |
| 2032              | 0   | 0   | 0  | 26  | 0   | 0  | 0  | 0  | 0  | 0  | 0  |
| 2033              | 0   | 0   | 0  | 21  | 0   | 0  | 0  | 0  | 0  | 0  | 0  |
| 2034              | 0   | 0   | 0  | 13  | 0   | 0  | 0  | 0  | 0  | 0  | 0  |
| 2035              | 0   | 0   | 0  | 8   | 0   | 0  | 0  | 0  | 0  | 0  | 0  |
| 2036              | 0   | 0   | 0  | 7   | 0   | 0  | 0  | 0  | 0  | 0  | 0  |
| 2037              | 0   | 0   | 0  | 7   | 0   | 0  | 0  | 0  | 0  | 0  | 0  |
| 2038              | 0   | 0   | 0  | 3   | 0   | 0  | 0  | 0  | 0  | 0  | 0  |
| 2039              | 0   | 0   | 0  | 2   | 0   | 0  | 0  | 0  | 0  | 0  | 0  |
| 2040              | 0   | 0   | 0  | 0   | 0   | 0  | 0  | 0  | 0  | 0  | 0  |
| 2041              | 0   | 0   | 0  | 0   | 0   | 0  | 0  | 0  | 0  | 0  | 0  |
| 2042              | 0   | 0   | 0  | 0   | 0   | 0  | 0  | 0  | 0  | 0  | 0  |
| 2043              | 0   | 0   | 0  | 0   | 0   | 0  | 0  | 0  | 0  | 0  | 0  |
| 2044              | 0   | 0   | 0  | 0   | 0   | 0  | 0  | 0  | 0  | 0  | 0  |
| 2045              | 0   | 0   | 0  | 0   | 0   | 0  | 0  | 0  | 0  | 0  | 0  |
| 2046              | 0   | 0   | 0  | 0   | 0   | 0  | 0  | 0  | 0  | 0  | 0  |
| 2047              | 0   | 0   | 0  | 0   | 0   | 0  | 0  | 0  | 0  | 0  | 0  |
| 2048              | 0   | 0   | 0  | 0   | 0   | 0  | 0  | 0  | 0  | 0  | 0  |
| 2049              | 0   | 0   | 0  | 0   | 0   | 0  | 0  | 0  | 0  | 0  | 0  |
| 2050              | 0   | 0   | 0  | 0   | 0   | 0  | 0  | 0  | 0  | 0  | 0  |
| 2051              | 0   | 0   | 0  | 0   | 0   | 0  | 0  | 0  | 0  | 0  | 0  |
| 2052              | 0   | 0   | 0  | 0   | 0   | 0  | 0  | 0  | 0  | 0  | 0  |
| 2053              | 0   | 0   | 0  | 0   | 0   | 0  | 0  | 0  | 0  | 0  | 0  |
| 2054              | 0   | 0   | 0  | 0   | 0   | 0  | 0  | 0  | 0  | 0  | 0  |
| 2055              | 0   | 0   | 0  | 0   | 0   | 0  | 0  | 0  | 0  | 0  | 0  |
| 2056              | 0   | 0   | 0  | 0   | 0   | 0  | 0  | 0  | 0  | 0  | 0  |
| 2057              | 0   | 0   | 0  | 0   | 0   | 0  | 0  | 0  | 0  | 0  | 0  |

| ScenarioID /<br>Year | 23 | 24 | 25 | 26 | 27 | 28 | 29 | 30 | 31 | 32 | 33 |
|----------------------|----|----|----|----|----|----|----|----|----|----|----|
| 2058                 | 0  | 0  | 0  | 0  | 0  | 0  | 0  | 0  | 0  | 0  | 0  |
| 2059                 | 0  | 0  | 0  | 0  | 0  | 0  | 0  | 0  | 0  | 0  | 0  |
| 2060                 | 0  | 0  | 0  | 0  | 0  | 0  | 0  | 0  | 0  | 0  | 0  |
| 2061                 | 0  | 0  | 0  | 0  | 0  | 0  | 0  | 0  | 0  | 0  | 0  |
| 2062                 | 0  | 0  | 0  | 0  | 0  | 0  | 0  | 0  | 0  | 0  | 0  |
| 2063                 | 0  | 0  | 0  | 0  | 0  | 0  | 0  | 0  | 0  | 0  | 0  |
| 2064                 | 0  | 0  | 0  | 0  | 0  | 0  | 0  | 0  | 0  | 0  | 0  |
| 2065                 | 0  | 0  | 0  | 0  | 0  | 0  | 0  | 0  | 0  | 0  | 0  |
| 2066                 | 0  | 0  | 0  | 0  | 0  | 0  | 0  | 0  | 0  | 0  | 0  |
| 2067                 | 0  | 0  | 0  | 0  | 0  | 0  | 0  | 0  | 0  | 0  | 0  |
| 2068                 | 0  | 0  | 0  | 0  | 0  | 0  | 0  | 0  | 0  | 0  | 0  |
| 2069                 | 0  | 0  | 0  | 0  | 0  | 0  | 0  | 0  | 0  | 0  | 0  |
| 2070                 | 0  | 0  | 0  | 0  | 0  | 0  | 0  | 0  | 0  | 0  | 0  |
| 2071                 | 0  | 0  | 0  | 0  | 0  | 0  | 0  | 0  | 0  | 0  | 0  |
| 2072                 | 0  | 0  | 0  | 0  | 0  | 0  | 0  | 0  | 0  | 0  | 0  |
| 2073                 | 0  | 0  | 0  | 0  | 0  | 0  | 0  | 0  | 0  | 0  | 0  |
| 2074                 | 0  | 0  | 0  | 0  | 0  | 0  | 0  | 0  | 0  | 0  | 0  |
| 2075                 | 0  | 0  | 0  | 0  | 0  | 0  | 0  | 0  | 0  | 0  | 0  |
| 2076                 | 0  | 0  | 0  | 0  | 0  | 0  | 0  | 0  | 0  | 0  | 0  |
| 2077                 | 0  | 0  | 0  | 0  | 0  | 0  | 0  | 0  | 0  | 0  | 0  |
| 2078                 | 0  | 0  | 0  | 0  | 0  | 0  | 0  | 0  | 0  | 0  | 0  |
| 2079                 | 0  | 0  | 0  | 0  | 0  | 0  | 0  | 0  | 0  | 0  | 0  |
| 2080                 | 0  | 0  | 0  | 0  | 0  | 0  | 0  | 0  | 0  | 0  | 0  |
| 2081                 | 0  | 0  | 0  | 0  | 0  | 0  | 0  | 0  | 0  | 0  | 0  |
| 2082                 | 0  | 0  | 0  | 0  | 0  | 0  | 0  | 0  | 0  | 0  | 0  |
| 2083                 | 0  | 0  | 0  | 0  | 0  | 0  | 0  | 0  | 0  | 0  | 0  |
| 2084                 | 0  | 0  | 0  | 0  | 0  | 0  | 0  | 0  | 0  | 0  | 0  |
| 2085                 | 0  | 0  | 0  | 0  | 0  | 0  | 0  | 0  | 0  | 0  | 0  |
| 2086                 | 0  | 0  | 0  | 0  | 0  | 0  | 0  | 0  | 0  | 0  | 0  |
| 2087                 | 0  | 0  | 0  | 0  | 0  | 0  | 0  | 0  | 0  | 0  | 0  |
| 2088                 | 0  | 0  | 0  | 0  | 0  | 0  | 0  | 0  | 0  | 0  | 0  |
| 2089                 | 0  | 0  | 0  | 0  | 0  | 0  | 0  | 0  | 0  | 0  | 0  |
| 2090                 | 0  | 0  | 0  | 0  | 0  | 0  | 0  | 0  | 0  | 0  | 0  |

| ScenarioID / Year | 34 | 35 | 36 | 37  | 38 | 39  | 40  | 41  | 42 | 43 | 44  |
|-------------------|----|----|----|-----|----|-----|-----|-----|----|----|-----|
| 2002              | 0  | 0  | 0  | 0   | 0  | 0   | 0   | 0   | 0  | 0  | 0   |
| 2003              | 0  | 0  | 0  | 0   | 0  | 0   | 0   | 0   | 0  | 0  | 0   |
| 2004              | 0  | 0  | 0  | 0   | 0  | 0   | 0   | 0   | 0  | 0  | 1   |
| 2005              | 0  | 0  | 0  | 0   | 0  | 0   | 0   | 1   | 0  | 0  | 3   |
| 2006              | 0  | 0  | 0  | 6   | 6  | 6   | 6   | 5   | 0  | 0  | 14  |
| 2007              | 0  | 0  | 0  | 6   | 6  | 6   | 6   | 7   | 2  | 0  | 29  |
| 2008              | 0  | 3  | 0  | 16  | 16 | 16  | 16  | 20  | 4  | 0  | 52  |
| 2009              | 0  | 9  | 0  | 25  | 25 | 25  | 25  | 44  | 7  | 0  | 88  |
| 2010              | 0  | 18 | 0  | 45  | 45 | 45  | 45  | 64  | 10 | 0  | 134 |
| 2011              | 0  | 38 | 0  | 61  | 61 | 61  | 61  | 107 | 20 | 0  | 204 |
| 2012              | 0  | 55 | 1  | 69  | 41 | 69  | 69  | 131 | 22 | 2  | 271 |
| 2013              | 0  | 65 | 0  | 94  | 18 | 94  | 94  | 170 | 29 | 2  | 339 |
| 2014              | 0  | 85 | 7  | 89  | 12 | 89  | 89  | 196 | 43 | 0  | 432 |
| 2015              | 0  | 96 | 5  | 125 | 5  | 125 | 125 | 248 | 73 | 2  | 537 |
| 2016              | 0  | 74 | 2  | 120 | 0  | 58  | 58  | 190 | 45 | 0  | 498 |
| 2017              | 0  | 52 | 1  | 139 | 0  | 35  | 35  | 141 | 31 | 0  | 452 |
| 2018              | 0  | 37 | 0  | 184 | 0  | 25  | 25  | 86  | 13 | 0  | 405 |
| 2019              | 0  | 25 | 0  | 188 | 0  | 12  | 12  | 58  | 10 | 0  | 371 |
| 2020              | 0  | 23 | 0  | 121 | 0  | 7   | 7   | 35  | 9  | 0  | 317 |
| 2021              | 0  | 20 | 0  | 67  | 0  | 5   | 5   | 21  | 2  | 0  | 276 |
| 2022              | 0  | 20 | 0  | 32  | 0  | 5   | 5   | 13  | 2  | 0  | 242 |
| 2023              | 0  | 15 | 0  | 11  | 0  | 0   | 0   | 11  | 0  | 0  | 200 |
| 2024              | 0  | 13 | 0  | 7   | 0  | 0   | 0   | 3   | 0  | 0  | 172 |
| 2025              | 0  | 11 | 0  | 5   | 0  | 0   | 0   | 0   | 0  | 0  | 138 |
| 2026              | 0  | 5  | 0  | 0   | 0  | 0   | 0   | 0   | 0  | 0  | 92  |
| 2027              | 0  | 2  | 0  | 0   | 0  | 0   | 0   | 0   | 0  | 0  | 50  |
| 2028              | 0  | 1  | 0  | 0   | 0  | 0   | 0   | 0   | 0  | 0  | 39  |
| 2029              | 0  | 0  | 0  | 0   | 0  | 0   | 0   | 0   | 0  | 0  | 28  |
| 2030              | 0  | 0  | 0  | 0   | 0  | 0   | 0   | 0   | 0  | 0  | 12  |
| 2031              | 0  | 0  | 0  | 0   | 0  | 0   | 0   | 0   | 0  | 0  | 8   |
| 2032              | 0  | 0  | 0  | 0   | 0  | 0   | 0   | 0   | 0  | 0  | 7   |
| 2033              | 0  | 0  | 0  | 0   | 0  | 0   | 0   | 0   | 0  | 0  | 5   |
| 2034              | 0  | 0  | 0  | 0   | 0  | 0   | 0   | 0   | 0  | 0  | 5   |
| 2035              | 0  | 0  | 0  | 0   | 0  | 0   | 0   | 0   | 0  | 0  | 0   |
| 2036              | 0  | 0  | 0  | 0   | 0  | 0   | 0   | 0   | 0  | 0  | 0   |
| 2037              | 0  | 0  | 0  | 0   | 0  | 0   | 0   | 0   | 0  | 0  | 0   |
| 2038              | 0  | 0  | 0  | 0   | 0  | 0   | 0   | 0   | 0  | 0  | 0   |
| 2039              | 0  | 0  | 0  | 0   | 0  | 0   | 0   | 0   | 0  | 0  | 0   |
| 2040              | 0  | 0  | 0  | 0   | 0  | 0   | 0   | 0   | 0  | 0  | 0   |
| 2041              | 0  | 0  | 0  | 0   | 0  | 0   | 0   | 0   | 0  | 0  | 0   |
| 2042              | 0  | 0  | 0  | 0   | 0  | 0   | 0   | 0   | 0  | 0  | 0   |
| 2043              | 0  | 0  | 0  | 0   | 0  | 0   | 0   | 0   | 0  | 0  | 0   |
| 2044              | 0  | 0  | 0  | 0   | 0  | 0   | 0   | 0   | 0  | 0  | 0   |
| 2045              | 0  | 0  | 0  | 0   | 0  | 0   | 0   | 0   | 0  | 0  | 0   |
| 2046              | 0  | 0  | 0  | 0   | 0  | 0   | 0   | 0   | 0  | 0  | 0   |
| 2047              | 0  | 0  | 0  | 0   | 0  | 0   | 0   | 0   | 0  | 0  | 0   |
| 2048              | 0  | 0  | 0  | 0   | 0  | 0   | 0   | 0   | 0  | 0  | 0   |
| 2049              | 0  | 0  | 0  | 0   | 0  | 0   | 0   | 0   | 0  | 0  | 0   |
| 2050              | 0  | 0  | 0  | 0   | 0  | 0   | 0   | 0   | 0  | 0  | 0   |
| 2051              | 0  | 0  | 0  | 0   | 0  | 0   | 0   | 0   | 0  | 0  | 0   |
| 2052              | 0  | 0  | 0  | 0   | 0  | 0   | 0   | 0   | 0  | 0  | 0   |
| 2053              | 0  | 0  | 0  | 0   | 0  | 0   | 0   | 0   | 0  | 0  | 0   |
| 2054              | 0  | 0  | 0  | 0   | 0  | 0   | 0   | 0   | 0  | 0  | 0   |
| 2055              | 0  | 0  | 0  | 0   | 0  | 0   | 0   | 0   | 0  | 0  | 0   |
| 2056              | 0  | 0  | 0  | 0   | 0  | 0   | 0   | 0   | 0  | 0  | 0   |
| 2057              | 0  | 0  | 0  | 0   | 0  | 0   | 0   | 0   | 0  | 0  | 0   |



| ScenarioID /<br>Year | 34 | 35 | 36 | 37 | 38 | 39 | 40 | 41 | 42 | 43 | 44 |
|----------------------|----|----|----|----|----|----|----|----|----|----|----|
| 2058                 | 0  | 0  | 0  | 0  | 0  | 0  | 0  | 0  | 0  | 0  | 0  |
| 2059                 | 0  | 0  | 0  | 0  | 0  | 0  | 0  | 0  | 0  | 0  | 0  |
| 2060                 | 0  | 0  | 0  | 0  | 0  | 0  | 0  | 0  | 0  | 0  | 0  |
| 2061                 | 0  | 0  | 0  | 0  | 0  | 0  | 0  | 0  | 0  | 0  | 0  |
| 2062                 | 0  | 0  | 0  | 0  | 0  | 0  | 0  | 0  | 0  | 0  | 0  |
| 2063                 | 0  | 0  | 0  | 0  | 0  | 0  | 0  | 0  | 0  | 0  | 0  |
| 2064                 | 0  | 0  | 0  | 0  | 0  | 0  | 0  | 0  | 0  | 0  | 0  |
| 2065                 | 0  | 0  | 0  | 0  | 0  | 0  | 0  | 0  | 0  | 0  | 0  |
| 2066                 | 0  | 0  | 0  | 0  | 0  | 0  | 0  | 0  | 0  | 0  | 0  |
| 2067                 | 0  | 0  | 0  | 0  | 0  | 0  | 0  | 0  | 0  | 0  | 0  |
| 2068                 | 0  | 0  | 0  | 0  | 0  | 0  | 0  | 0  | 0  | 0  | 0  |
| 2069                 | 0  | 0  | 0  | 0  | 0  | 0  | 0  | 0  | 0  | 0  | 0  |
| 2070                 | 0  | 0  | 0  | 0  | 0  | 0  | 0  | 0  | 0  | 0  | 0  |
| 2071                 | 0  | 0  | 0  | 0  | 0  | 0  | 0  | 0  | 0  | 0  | 0  |
| 2072                 | 0  | 0  | 0  | 0  | 0  | 0  | 0  | 0  | 0  | 0  | 0  |
| 2073                 | 0  | 0  | 0  | 0  | 0  | 0  | 0  | 0  | 0  | 0  | 0  |
| 2074                 | 0  | 0  | 0  | 0  | 0  | 0  | 0  | 0  | 0  | 0  | 0  |
| 2075                 | 0  | 0  | 0  | 0  | 0  | 0  | 0  | 0  | 0  | 0  | 0  |
| 2076                 | 0  | 0  | 0  | 0  | 0  | 0  | 0  | 0  | 0  | 0  | 0  |
| 2077                 | 0  | 0  | 0  | 0  | 0  | 0  | 0  | 0  | 0  | 0  | 0  |
| 2078                 | 0  | 0  | 0  | 0  | 0  | 0  | 0  | 0  | 0  | 0  | 0  |
| 2079                 | 0  | 0  | 0  | 0  | 0  | 0  | 0  | 0  | 0  | 0  | 0  |
| 2080                 | 0  | 0  | 0  | 0  | 0  | 0  | 0  | 0  | 0  | 0  | 0  |
| 2081                 | 0  | 0  | 0  | 0  | 0  | 0  | 0  | 0  | 0  | 0  | 0  |
| 2082                 | 0  | 0  | 0  | 0  | 0  | 0  | 0  | 0  | 0  | 0  | 0  |
| 2083                 | 0  | 0  | 0  | 0  | 0  | 0  | 0  | 0  | 0  | 0  | 0  |
| 2084                 | 0  | 0  | 0  | 0  | 0  | 0  | 0  | 0  | 0  | 0  | 0  |
| 2085                 | 0  | 0  | 0  | 0  | 0  | 0  | 0  | 0  | 0  | 0  | 0  |
| 2086                 | 0  | 0  | 0  | 0  | 0  | 0  | 0  | 0  | 0  | 0  | 0  |
| 2087                 | 0  | 0  | 0  | 0  | 0  | 0  | 0  | 0  | 0  | 0  | 0  |
| 2088                 | 0  | 0  | 0  | 0  | 0  | 0  | 0  | 0  | 0  | 0  | 0  |
| 2089                 | 0  | 0  | 0  | 0  | 0  | 0  | 0  | 0  | 0  | 0  | 0  |
| 2090                 | 0  | 0  | 0  | 0  | 0  | 0  | 0  | 0  | 0  | 0  | 0  |

| ScenarioID / Year | 45  | 46  | 47  | 48  | 49  | 50  | 51  | 52 | 53  | 54  | 55 |
|-------------------|-----|-----|-----|-----|-----|-----|-----|----|-----|-----|----|
| 2002              | 0   | 0   | 0   | 0   | 0   | 0   | 0   | 0  | 0   | 0   | 0  |
| 2003              | 0   | 0   | 0   | 0   | 0   | 0   | 0   | 0  | 0   | 0   | 0  |
| 2004              | 0   | 1   | 1   | 1   | 1   | 1   | 1   | 0  | 1   | 1   | 0  |
| 2005              | 0   | 3   | 3   | 3   | 3   | 3   | 2   | 1  | 3   | 3   | 0  |
| 2006              | 6   | 13  | 13  | 13  | 13  | 14  | 13  | 1  | 14  | 13  | 0  |
| 2007              | 6   | 29  | 29  | 29  | 29  | 32  | 27  | 12 | 33  | 29  | 0  |
| 2008              | 16  | 50  | 50  | 50  | 50  | 52  | 30  | 23 | 66  | 50  | 0  |
| 2009              | 25  | 91  | 91  | 91  | 91  | 105 | 58  | 36 | 127 | 91  | 0  |
| 2010              | 45  | 133 | 133 | 133 | 133 | 159 | 78  | 32 | 205 | 133 | 0  |
| 2011              | 61  | 194 | 194 | 194 | 194 | 206 | 115 | 54 | 297 | 194 | 0  |
| 2012              | 69  | 234 | 168 | 234 | 234 | 295 | 124 | 52 | 399 | 234 | 1  |
| 2013              | 94  | 262 | 114 | 262 | 262 | 345 | 153 | 63 | 508 | 262 | 0  |
| 2014              | 89  | 288 | 79  | 288 | 288 | 394 | 174 | 61 | 595 | 288 | 7  |
| 2015              | 125 | 338 | 52  | 338 | 338 | 460 | 208 | 89 | 723 | 338 | 5  |
| 2016              | 58  | 362 | 24  | 251 | 251 | 382 | 155 | 24 | 694 | 251 | 9  |
| 2017              | 35  | 394 | 12  | 191 | 191 | 324 | 109 | 10 | 632 | 191 | 10 |
| 2018              | 25  | 476 | 7   | 154 | 154 | 269 | 72  | 5  | 584 | 154 | 8  |
| 2019              | 12  | 505 | 3   | 109 | 109 | 212 | 58  | 3  | 544 | 109 | 9  |
| 2020              | 7   | 378 | 3   | 43  | 43  | 150 | 50  | 2  | 499 | 43  | 8  |
| 2021              | 5   | 343 | 3   | 28  | 28  | 88  | 41  | 0  | 452 | 28  | 0  |
| 2022              | 5   | 259 | 3   | 13  | 13  | 67  | 31  | 0  | 388 | 13  | 0  |
| 2023              | 0   | 185 | 3   | 11  | 11  | 40  | 24  | 0  | 352 | 11  | 0  |
| 2024              | 0   | 119 | 2   | 7   | 7   | 28  | 11  | 0  | 312 | 7   | 0  |
| 2025              | 0   | 54  | 2   | 7   | 7   | 15  | 9   | 0  | 273 | 7   | 0  |
| 2026              | 0   | 39  | 0   | 3   | 3   | 5   | 2   | 0  | 219 | 3   | 0  |
| 2027              | 0   | 24  | 0   | 2   | 2   | 4   | 2   | 0  | 175 | 2   | 0  |
| 2028              | 0   | 5   | 0   | 0   | 0   | 0   | 0   | 0  | 157 | 0   | 0  |
| 2029              | 0   | 5   | 0   | 0   | 0   | 0   | 0   | 0  | 117 | 0   | 0  |
| 2030              | 0   | 5   | 0   | 0   | 0   | 0   | 0   | 0  | 74  | 0   | 0  |
| 2031              | 0   | 3   | 0   | 0   | 0   | 0   | 0   | 0  | 34  | 0   | 0  |
| 2032              | 0   | 2   | 0   | 0   | 0   | 0   | 0   | 0  | 26  | 0   | 0  |
| 2033              | 0   | 0   | 0   | 0   | 0   | 0   | 0   | 0  | 21  | 0   | 0  |
| 2034              | 0   | 0   | 0   | 0   | 0   | 0   | 0   | 0  | 13  | 0   | 0  |
| 2035              | 0   | 0   | 0   | 0   | 0   | 0   | 0   | 0  | 8   | 0   | 0  |
| 2036              | 0   | 0   | 0   | 0   | 0   | 0   | 0   | 0  | 7   | 0   | 0  |
| 2037              | 0   | 0   | 0   | 0   | 0   | 0   | 0   | 0  | 7   | 0   | 0  |
| 2038              | 0   | 0   | 0   | 0   | 0   | 0   | 0   | 0  | 3   | 0   | 0  |
| 2039              | 0   | 0   | 0   | 0   | 0   | 0   | 0   | 0  | 2   | 0   | 0  |
| 2040              | 0   | 0   | 0   | 0   | 0   | 0   | 0   | 0  | 0   | 0   | 0  |
| 2041              | 0   | 0   | 0   | 0   | 0   | 0   | 0   | 0  | 0   | 0   | 0  |
| 2042              | 0   | 0   | 0   | 0   | 0   | 0   | 0   | 0  | 0   | 0   | 0  |
| 2043              | 0   | 0   | 0   | 0   | 0   | 0   | 0   | 0  | 0   | 0   | 0  |
| 2044              | 0   | 0   | 0   | 0   | 0   | 0   | 0   | 0  | 0   | 0   | 0  |
| 2045              | 0   | 0   | 0   | 0   | 0   | 0   | 0   | 0  | 0   | 0   | 0  |
| 2046              | 0   | 0   | 0   | 0   | 0   | 0   | 0   | 0  | 0   | 0   | 0  |
| 2047              | 0   | 0   | 0   | 0   | 0   | 0   | 0   | 0  | 0   | 0   | 0  |
| 2048              | 0   | 0   | 0   | 0   | 0   | 0   | 0   | 0  | 0   | 0   | 0  |
| 2049              | 0   | 0   | 0   | 0   | 0   | 0   | 0   | 0  | 0   | 0   | 0  |
| 2050              | 0   | 0   | 0   | 0   | 0   | 0   | 0   | 0  | 0   | 0   | 0  |
| 2051              | 0   | 0   | 0   | 0   | 0   | 0   | 0   | 0  | 0   | 0   | 0  |
| 2052              | 0   | 0   | 0   | 0   | 0   | 0   | 0   | 0  | 0   | 0   | 0  |
| 2053              | 0   | 0   | 0   | 0   | 0   | 0   | 0   | 0  | 0   | 0   | 0  |
| 2054              | 0   | 0   | 0   | 0   | 0   | 0   | 0   | 0  | 0   | 0   | 0  |
| 2055              | 0   | 0   | 0   | 0   | 0   | 0   | 0   | 0  | 0   | 0   | 0  |
| 2056              | 0   | 0   | 0   | 0   | 0   | 0   | 0   | 0  | 0   | 0   | 0  |
| 2057              | 0   | 0   | 0   | 0   | 0   | 0   | 0   | 0  | 0   | 0   | 0  |

| ScenarioID /<br>Year | 45 | 46 | 47 | 48 | 49 | 50 | 51 | 52 | 53 | 54 | 55 |
|----------------------|----|----|----|----|----|----|----|----|----|----|----|
| 2058                 | 0  | 0  | 0  | 0  | 0  | 0  | 0  | 0  | 0  | 0  | 0  |
| 2059                 | 0  | 0  | 0  | 0  | 0  | 0  | 0  | 0  | 0  | 0  | 0  |
| 2060                 | 0  | 0  | 0  | 0  | 0  | 0  | 0  | 0  | 0  | 0  | 0  |
| 2061                 | 0  | 0  | 0  | 0  | 0  | 0  | 0  | 0  | 0  | 0  | 0  |
| 2062                 | 0  | 0  | 0  | 0  | 0  | 0  | 0  | 0  | 0  | 0  | 0  |
| 2063                 | 0  | 0  | 0  | 0  | 0  | 0  | 0  | 0  | 0  | 0  | 0  |
| 2064                 | 0  | 0  | 0  | 0  | 0  | 0  | 0  | 0  | 0  | 0  | 0  |
| 2065                 | 0  | 0  | 0  | 0  | 0  | 0  | 0  | 0  | 0  | 0  | 0  |
| 2066                 | 0  | 0  | 0  | 0  | 0  | 0  | 0  | 0  | 0  | 0  | 0  |
| 2067                 | 0  | 0  | 0  | 0  | 0  | 0  | 0  | 0  | 0  | 0  | 0  |
| 2068                 | 0  | 0  | 0  | 0  | 0  | 0  | 0  | 0  | 0  | 0  | 0  |
| 2069                 | 0  | 0  | 0  | 0  | 0  | 0  | 0  | 0  | 0  | 0  | 0  |
| 2070                 | 0  | 0  | 0  | 0  | 0  | 0  | 0  | 0  | 0  | 0  | 0  |
| 2071                 | 0  | 0  | 0  | 0  | 0  | 0  | 0  | 0  | 0  | 0  | 0  |
| 2072                 | 0  | 0  | 0  | 0  | 0  | 0  | 0  | 0  | 0  | 0  | 0  |
| 2073                 | 0  | 0  | 0  | 0  | 0  | 0  | 0  | 0  | 0  | 0  | 0  |
| 2074                 | 0  | 0  | 0  | 0  | 0  | 0  | 0  | 0  | 0  | 0  | 0  |
| 2075                 | 0  | 0  | 0  | 0  | 0  | 0  | 0  | 0  | 0  | 0  | 0  |
| 2076                 | 0  | 0  | 0  | 0  | 0  | 0  | 0  | 0  | 0  | 0  | 0  |
| 2077                 | 0  | 0  | 0  | 0  | 0  | 0  | 0  | 0  | 0  | 0  | 0  |
| 2078                 | 0  | 0  | 0  | 0  | 0  | 0  | 0  | 0  | 0  | 0  | 0  |
| 2079                 | 0  | 0  | 0  | 0  | 0  | 0  | 0  | 0  | 0  | 0  | 0  |
| 2080                 | 0  | 0  | 0  | 0  | 0  | 0  | 0  | 0  | 0  | 0  | 0  |
| 2081                 | 0  | 0  | 0  | 0  | 0  | 0  | 0  | 0  | 0  | 0  | 0  |
| 2082                 | 0  | 0  | 0  | 0  | 0  | 0  | 0  | 0  | 0  | 0  | 0  |
| 2083                 | 0  | 0  | 0  | 0  | 0  | 0  | 0  | 0  | 0  | 0  | 0  |
| 2084                 | 0  | 0  | 0  | 0  | 0  | 0  | 0  | 0  | 0  | 0  | 0  |
| 2085                 | 0  | 0  | 0  | 0  | 0  | 0  | 0  | 0  | 0  | 0  | 0  |
| 2086                 | 0  | 0  | 0  | 0  | 0  | 0  | 0  | 0  | 0  | 0  | 0  |
| 2087                 | 0  | 0  | 0  | 0  | 0  | 0  | 0  | 0  | 0  | 0  | 0  |
| 2088                 | 0  | 0  | 0  | 0  | 0  | 0  | 0  | 0  | 0  | 0  | 0  |
| 2089                 | 0  | 0  | 0  | 0  | 0  | 0  | 0  | 0  | 0  | 0  | 0  |
| 2090                 | 0  | 0  | 0  | 0  | 0  | 0  | 0  | 0  | 0  | 0  | 0  |

| ScenarioID /<br>Year | 56 | 57 | 58 | 59 | 60 | 61 | 62 | 63 | 64  | 65 | 66  |
|----------------------|----|----|----|----|----|----|----|----|-----|----|-----|
| 2002                 | 0  | 0  | 0  | 0  | 0  | 0  | 0  | 0  | 0   | 0  | 0   |
| 2003                 | 0  | 0  | 0  | 0  | 0  | 0  | 0  | 0  | 0   | 0  | 0   |
| 2004                 | 0  | 0  | 0  | 0  | 0  | 0  | 0  | 0  | 0   | 0  | 0   |
| 2005                 | 0  | 0  | 0  | 0  | 0  | 0  | 0  | 0  | 0   | 0  | 0   |
| 2006                 | 0  | 0  | 0  | 0  | 0  | 0  | 0  | 0  | 6   | 6  | 6   |
| 2007                 | 0  | 0  | 0  | 0  | 0  | 0  | 0  | 0  | 6   | 6  | 6   |
| 2008                 | 0  | 0  | 0  | 0  | 0  | 0  | 3  | 0  | 16  | 16 | 16  |
| 2009                 | 0  | 0  | 0  | 0  | 0  | 0  | 9  | 0  | 25  | 25 | 25  |
| 2010                 | 0  | 0  | 0  | 0  | 0  | 0  | 18 | 0  | 45  | 45 | 45  |
| 2011                 | 0  | 0  | 0  | 0  | 0  | 0  | 38 | 0  | 61  | 61 | 61  |
| 2012                 | 0  | 1  | 1  | 1  | 1  | 0  | 55 | 1  | 69  | 41 | 69  |
| 2013                 | 0  | 0  | 0  | 0  | 0  | 0  | 65 | 0  | 94  | 18 | 94  |
| 2014                 | 0  | 7  | 7  | 7  | 7  | 0  | 85 | 7  | 89  | 12 | 89  |
| 2015                 | 0  | 5  | 5  | 5  | 5  | 0  | 96 | 5  | 125 | 5  | 125 |
| 2016                 | 0  | 2  | 2  | 2  | 2  | 0  | 74 | 2  | 120 | 0  | 58  |
| 2017                 | 0  | 1  | 1  | 1  | 1  | 0  | 52 | 1  | 139 | 0  | 35  |
| 2018                 | 0  | 0  | 0  | 0  | 0  | 0  | 37 | 0  | 184 | 0  | 25  |
| 2019                 | 0  | 0  | 0  | 0  | 0  | 0  | 25 | 0  | 188 | 0  | 12  |
| 2020                 | 0  | 0  | 0  | 0  | 0  | 0  | 23 | 0  | 121 | 0  | 7   |
| 2021                 | 0  | 0  | 0  | 0  | 0  | 0  | 20 | 0  | 67  | 0  | 5   |
| 2022                 | 0  | 0  | 0  | 0  | 0  | 0  | 20 | 0  | 32  | 0  | 5   |
| 2023                 | 0  | 0  | 0  | 0  | 0  | 0  | 15 | 0  | 11  | 0  | 0   |
| 2024                 | 0  | 0  | 0  | 0  | 0  | 0  | 13 | 0  | 7   | 0  | 0   |
| 2025                 | 0  | 0  | 0  | 0  | 0  | 0  | 11 | 0  | 5   | 0  | 0   |
| 2026                 | 0  | 0  | 0  | 0  | 0  | 0  | 5  | 0  | 0   | 0  | 0   |
| 2027                 | 0  | 0  | 0  | 0  | 0  | 0  | 2  | 0  | 0   | 0  | 0   |
| 2028                 | 0  | 0  | 0  | 0  | 0  | 0  | 1  | 0  | 0   | 0  | 0   |
| 2029                 | 0  | 0  | 0  | 0  | 0  | 0  | 0  | 0  | 0   | 0  | 0   |
| 2030                 | 0  | 0  | 0  | 0  | 0  | 0  | 0  | 0  | 0   | 0  | 0   |
| 2031                 | 0  | 0  | 0  | 0  | 0  | 0  | 0  | 0  | 0   | 0  | 0   |
| 2032                 | 0  | 0  | 0  | 0  | 0  | 0  | 0  | 0  | 0   | 0  | 0   |
| 2033                 | 0  | 0  | 0  | 0  | 0  | 0  | 0  | 0  | 0   | 0  | 0   |
| 2034                 | 0  | 0  | 0  | 0  | 0  | 0  | 0  | 0  | 0   | 0  | 0   |
| 2035                 | 0  | 0  | 0  | 0  | 0  | 0  | 0  | 0  | 0   | 0  | 0   |
| 2036                 | 0  | 0  | 0  | 0  | 0  | 0  | 0  | 0  | 0   | 0  | 0   |
| 2037                 | 0  | 0  | 0  | 0  | 0  | 0  | 0  | 0  | 0   | 0  | 0   |
| 2038                 | 0  | 0  | 0  | 0  | 0  | 0  | 0  | 0  | 0   | 0  | 0   |
| 2039                 | 0  | 0  | 0  | 0  | 0  | 0  | 0  | 0  | 0   | 0  | 0   |
| 2040                 | 0  | 0  | 0  | 0  | 0  | 0  | 0  | 0  | 0   | 0  | 0   |
| 2041                 | 0  | 0  | 0  | 0  | 0  | 0  | 0  | 0  | 0   | 0  | 0   |
| 2042                 | 0  | 0  | 0  | 0  | 0  | 0  | 0  | 0  | 0   | 0  | 0   |
| 2043                 | 0  | 0  | 0  | 0  | 0  | 0  | 0  | 0  | 0   | 0  | 0   |
| 2044                 | 0  | 0  | 0  | 0  | 0  | 0  | 0  | 0  | 0   | 0  | 0   |
| 2045                 | 0  | 0  | 0  | 0  | 0  | 0  | 0  | 0  | 0   | 0  | 0   |
| 2046                 | 0  | 0  | 0  | 0  | 0  | 0  | 0  | 0  | 0   | 0  | 0   |
| 2047                 | 0  | 0  | 0  | 0  | 0  | 0  | 0  | 0  | 0   | 0  | 0   |
| 2048                 | 0  | 0  | 0  | 0  | 0  | 0  | 0  | 0  | 0   | 0  | 0   |
| 2049                 | 0  | 0  | 0  | 0  | 0  | 0  | 0  | 0  | 0   | 0  | 0   |
| 2050                 | 0  | 0  | 0  | 0  | 0  | 0  | 0  | 0  | 0   | 0  | 0   |
| 2051                 | 0  | 0  | 0  | 0  | 0  | 0  | 0  | 0  | 0   | 0  | 0   |
| 2052                 | 0  | 0  | 0  | 0  | 0  | 0  | 0  | 0  | 0   | 0  | 0   |
| 2053                 | 0  | 0  | 0  | 0  | 0  | 0  | 0  | 0  | 0   | 0  | 0   |
| 2054                 | 0  | 0  | 0  | 0  | 0  | 0  | 0  | 0  | 0   | 0  | 0   |
| 2055                 | 0  | 0  | 0  | 0  | 0  | 0  | 0  | 0  | 0   | 0  | 0   |
| 2056                 | 0  | 0  | 0  | 0  | 0  | 0  | 0  | 0  | 0   | 0  | 0   |
| 2057                 | 0  | 0  | 0  | 0  | 0  | 0  | 0  | 0  | 0   | 0  | 0   |

| ScenarioID /<br>Year | 56 | 57 | 58 | 59 | 60 | 61 | 62 | 63 | 64 | 65 | 66 |
|----------------------|----|----|----|----|----|----|----|----|----|----|----|
| 2058                 | 0  | 0  | 0  | 0  | 0  | 0  | 0  | 0  | 0  | 0  | 0  |
| 2059                 | 0  | 0  | 0  | 0  | 0  | 0  | 0  | 0  | 0  | 0  | 0  |
| 2060                 | 0  | 0  | 0  | 0  | 0  | 0  | 0  | 0  | 0  | 0  | 0  |
| 2061                 | 0  | 0  | 0  | 0  | 0  | 0  | 0  | 0  | 0  | 0  | 0  |
| 2062                 | 0  | 0  | 0  | 0  | 0  | 0  | 0  | 0  | 0  | 0  | 0  |
| 2063                 | 0  | 0  | 0  | 0  | 0  | 0  | 0  | 0  | 0  | 0  | 0  |
| 2064                 | 0  | 0  | 0  | 0  | 0  | 0  | 0  | 0  | 0  | 0  | 0  |
| 2065                 | 0  | 0  | 0  | 0  | 0  | 0  | 0  | 0  | 0  | 0  | 0  |
| 2066                 | 0  | 0  | 0  | 0  | 0  | 0  | 0  | 0  | 0  | 0  | 0  |
| 2067                 | 0  | 0  | 0  | 0  | 0  | 0  | 0  | 0  | 0  | 0  | 0  |
| 2068                 | 0  | 0  | 0  | 0  | 0  | 0  | 0  | 0  | 0  | 0  | 0  |
| 2069                 | 0  | 0  | 0  | 0  | 0  | 0  | 0  | 0  | 0  | 0  | 0  |
| 2070                 | 0  | 0  | 0  | 0  | 0  | 0  | 0  | 0  | 0  | 0  | 0  |
| 2071                 | 0  | 0  | 0  | 0  | 0  | 0  | 0  | 0  | 0  | 0  | 0  |
| 2072                 | 0  | 0  | 0  | 0  | 0  | 0  | 0  | 0  | 0  | 0  | 0  |
| 2073                 | 0  | 0  | 0  | 0  | 0  | 0  | 0  | 0  | 0  | 0  | 0  |
| 2074                 | 0  | 0  | 0  | 0  | 0  | 0  | 0  | 0  | 0  | 0  | 0  |
| 2075                 | 0  | 0  | 0  | 0  | 0  | 0  | 0  | 0  | 0  | 0  | 0  |
| 2076                 | 0  | 0  | 0  | 0  | 0  | 0  | 0  | 0  | 0  | 0  | 0  |
| 2077                 | 0  | 0  | 0  | 0  | 0  | 0  | 0  | 0  | 0  | 0  | 0  |
| 2078                 | 0  | 0  | 0  | 0  | 0  | 0  | 0  | 0  | 0  | 0  | 0  |
| 2079                 | 0  | 0  | 0  | 0  | 0  | 0  | 0  | 0  | 0  | 0  | 0  |
| 2080                 | 0  | 0  | 0  | 0  | 0  | 0  | 0  | 0  | 0  | 0  | 0  |
| 2081                 | 0  | 0  | 0  | 0  | 0  | 0  | 0  | 0  | 0  | 0  | 0  |
| 2082                 | 0  | 0  | 0  | 0  | 0  | 0  | 0  | 0  | 0  | 0  | 0  |
| 2083                 | 0  | 0  | 0  | 0  | 0  | 0  | 0  | 0  | 0  | 0  | 0  |
| 2084                 | 0  | 0  | 0  | 0  | 0  | 0  | 0  | 0  | 0  | 0  | 0  |
| 2085                 | 0  | 0  | 0  | 0  | 0  | 0  | 0  | 0  | 0  | 0  | 0  |
| 2086                 | 0  | 0  | 0  | 0  | 0  | 0  | 0  | 0  | 0  | 0  | 0  |
| 2087                 | 0  | 0  | 0  | 0  | 0  | 0  | 0  | 0  | 0  | 0  | 0  |
| 2088                 | 0  | 0  | 0  | 0  | 0  | 0  | 0  | 0  | 0  | 0  | 0  |
| 2089                 | 0  | 0  | 0  | 0  | 0  | 0  | 0  | 0  | 0  | 0  | 0  |
| 2090                 | 0  | 0  | 0  | 0  | 0  | 0  | 0  | 0  | 0  | 0  | 0  |

| ScenarioID / Year | 67  | 68  | 69 | 70 |
|-------------------|-----|-----|----|----|
| 2002              | 0   | 0   | 0  | 0  |
| 2003              | 0   | 0   | 0  | 0  |
| 2004              | 0   | 0   | 0  | 0  |
| 2005              | 0   | 1   | 0  | 0  |
| 2006              | 6   | 5   | 0  | 0  |
| 2007              | 6   | 7   | 2  | 0  |
| 2008              | 16  | 20  | 4  | 0  |
| 2009              | 25  | 44  | 7  | 0  |
| 2010              | 45  | 64  | 10 | 0  |
| 2011              | 61  | 107 | 20 | 0  |
| 2012              | 69  | 131 | 22 | 2  |
| 2013              | 94  | 170 | 29 | 2  |
| 2014              | 89  | 196 | 43 | 0  |
| 2015              | 125 | 248 | 73 | 2  |
| 2016              | 58  | 190 | 45 | 0  |
| 2017              | 35  | 141 | 31 | 0  |
| 2018              | 25  | 86  | 13 | 0  |
| 2019              | 12  | 58  | 10 | 0  |
| 2020              | 7   | 35  | 9  | 0  |
| 2021              | 5   | 21  | 2  | 0  |
| 2022              | 5   | 13  | 2  | 0  |
| 2023              | 0   | 11  | 0  | 0  |
| 2024              | 0   | 3   | 0  | 0  |
| 2025              | 0   | 0   | 0  | 0  |
| 2026              | 0   | 0   | 0  | 0  |
| 2027              | 0   | 0   | 0  | 0  |
| 2028              | 0   | 0   | 0  | 0  |
| 2029              | 0   | 0   | 0  | 0  |
| 2030              | 0   | 0   | 0  | 0  |
| 2031              | 0   | 0   | 0  | 0  |
| 2032              | 0   | 0   | 0  | 0  |
| 2033              | 0   | 0   | 0  | 0  |
| 2034              | 0   | 0   | 0  | 0  |
| 2035              | 0   | 0   | 0  | 0  |
| 2036              | 0   | 0   | 0  | 0  |
| 2037              | 0   | 0   | 0  | 0  |
| 2038              | 0   | 0   | 0  | 0  |
| 2039              | 0   | 0   | 0  | 0  |
| 2040              | 0   | 0   | 0  | 0  |
| 2041              | 0   | 0   | 0  | 0  |
| 2042              | 0   | 0   | 0  | 0  |
| 2043              | 0   | 0   | 0  | 0  |
| 2044              | 0   | 0   | 0  | 0  |
| 2045              | 0   | 0   | 0  | 0  |
| 2046              | 0   | 0   | 0  | 0  |
| 2047              | 0   | 0   | 0  | 0  |
| 2048              | 0   | 0   | 0  | 0  |
| 2049              | 0   | 0   | 0  | 0  |
| 2050              | 0   | 0   | 0  | 0  |
| 2051              | 0   | 0   | 0  | 0  |
| 2052              | 0   | 0   | 0  | 0  |
| 2053              | 0   | 0   | 0  | 0  |
| 2054              | 0   | 0   | 0  | 0  |
| 2055              | 0   | 0   | 0  | 0  |
| 2056              | 0   | 0   | 0  | 0  |
| 2057              | 0   | 0   | 0  | 0  |

| ScenarioID /<br>Year | 67 | 68 | 69 | 70 |
|----------------------|----|----|----|----|
| 2058                 | 0  | 0  | 0  | 0  |
| 2059                 | 0  | 0  | 0  | 0  |
| 2060                 | 0  | 0  | 0  | 0  |
| 2061                 | 0  | 0  | 0  | 0  |
| 2062                 | 0  | 0  | 0  | 0  |
| 2063                 | 0  | 0  | 0  | 0  |
| 2064                 | 0  | 0  | 0  | 0  |
| 2065                 | 0  | 0  | 0  | 0  |
| 2066                 | 0  | 0  | 0  | 0  |
| 2067                 | 0  | 0  | 0  | 0  |
| 2068                 | 0  | 0  | 0  | 0  |
| 2069                 | 0  | 0  | 0  | 0  |
| 2070                 | 0  | 0  | 0  | 0  |
| 2071                 | 0  | 0  | 0  | 0  |
| 2072                 | 0  | 0  | 0  | 0  |
| 2073                 | 0  | 0  | 0  | 0  |
| 2074                 | 0  | 0  | 0  | 0  |
| 2075                 | 0  | 0  | 0  | 0  |
| 2076                 | 0  | 0  | 0  | 0  |
| 2077                 | 0  | 0  | 0  | 0  |
| 2078                 | 0  | 0  | 0  | 0  |
| 2079                 | 0  | 0  | 0  | 0  |
| 2080                 | 0  | 0  | 0  | 0  |
| 2081                 | 0  | 0  | 0  | 0  |
| 2082                 | 0  | 0  | 0  | 0  |
| 2083                 | 0  | 0  | 0  | 0  |
| 2084                 | 0  | 0  | 0  | 0  |
| 2085                 | 0  | 0  | 0  | 0  |
| 2086                 | 0  | 0  | 0  | 0  |
| 2087                 | 0  | 0  | 0  | 0  |
| 2088                 | 0  | 0  | 0  | 0  |
| 2089                 | 0  | 0  | 0  | 0  |
| 2090                 | 0  | 0  | 0  | 0  |

| ScenarioID / Year | 71  | 72  | 73  | 74  | 75  | 76  | 77  | 78  | 79 | 80  | 81  |
|-------------------|-----|-----|-----|-----|-----|-----|-----|-----|----|-----|-----|
| 2002              | 0   | 0   | 0   | 0   | 0   | 0   | 0   | 0   | 0  | 0   | 0   |
| 2003              | 0   | 0   | 0   | 0   | 0   | 0   | 0   | 0   | 0  | 0   | 0   |
| 2004              | 1   | 0   | 1   | 1   | 1   | 1   | 1   | 1   | 0  | 1   | 1   |
| 2005              | 3   | 0   | 3   | 3   | 3   | 3   | 3   | 2   | 1  | 3   | 3   |
| 2006              | 14  | 6   | 13  | 13  | 13  | 13  | 14  | 13  | 1  | 14  | 13  |
| 2007              | 29  | 6   | 29  | 29  | 29  | 29  | 32  | 27  | 12 | 33  | 29  |
| 2008              | 52  | 16  | 50  | 50  | 50  | 50  | 52  | 30  | 23 | 66  | 50  |
| 2009              | 88  | 25  | 91  | 91  | 91  | 91  | 105 | 58  | 36 | 127 | 91  |
| 2010              | 134 | 45  | 133 | 133 | 133 | 133 | 159 | 78  | 32 | 205 | 133 |
| 2011              | 204 | 61  | 194 | 194 | 194 | 194 | 206 | 115 | 54 | 297 | 194 |
| 2012              | 271 | 69  | 234 | 168 | 234 | 234 | 295 | 124 | 52 | 399 | 234 |
| 2013              | 339 | 94  | 262 | 114 | 262 | 262 | 345 | 153 | 63 | 508 | 262 |
| 2014              | 432 | 89  | 288 | 79  | 288 | 288 | 394 | 174 | 61 | 595 | 288 |
| 2015              | 537 | 125 | 338 | 52  | 338 | 338 | 460 | 208 | 89 | 723 | 338 |
| 2016              | 498 | 58  | 362 | 24  | 251 | 251 | 382 | 155 | 24 | 694 | 251 |
| 2017              | 452 | 35  | 394 | 12  | 191 | 191 | 324 | 109 | 10 | 632 | 191 |
| 2018              | 405 | 25  | 476 | 7   | 154 | 154 | 269 | 72  | 5  | 584 | 154 |
| 2019              | 371 | 12  | 505 | 3   | 109 | 109 | 212 | 58  | 3  | 544 | 109 |
| 2020              | 317 | 7   | 378 | 3   | 43  | 43  | 150 | 50  | 2  | 499 | 43  |
| 2021              | 276 | 5   | 343 | 3   | 28  | 28  | 88  | 41  | 0  | 452 | 28  |
| 2022              | 242 | 5   | 259 | 3   | 13  | 13  | 67  | 31  | 0  | 388 | 13  |
| 2023              | 200 | 0   | 185 | 3   | 11  | 11  | 40  | 24  | 0  | 352 | 11  |
| 2024              | 172 | 0   | 119 | 2   | 7   | 7   | 28  | 11  | 0  | 312 | 7   |
| 2025              | 138 | 0   | 54  | 2   | 7   | 7   | 15  | 9   | 0  | 273 | 7   |
| 2026              | 92  | 0   | 39  | 0   | 3   | 3   | 5   | 2   | 0  | 219 | 3   |
| 2027              | 50  | 0   | 24  | 0   | 2   | 2   | 4   | 2   | 0  | 175 | 2   |
| 2028              | 39  | 0   | 5   | 0   | 0   | 0   | 0   | 0   | 0  | 157 | 0   |
| 2029              | 28  | 0   | 5   | 0   | 0   | 0   | 0   | 0   | 0  | 117 | 0   |
| 2030              | 12  | 0   | 5   | 0   | 0   | 0   | 0   | 0   | 0  | 74  | 0   |
| 2031              | 8   | 0   | 3   | 0   | 0   | 0   | 0   | 0   | 0  | 34  | 0   |
| 2032              | 7   | 0   | 2   | 0   | 0   | 0   | 0   | 0   | 0  | 26  | 0   |
| 2033              | 5   | 0   | 0   | 0   | 0   | 0   | 0   | 0   | 0  | 21  | 0   |
| 2034              | 5   | 0   | 0   | 0   | 0   | 0   | 0   | 0   | 0  | 13  | 0   |
| 2035              | 0   | 0   | 0   | 0   | 0   | 0   | 0   | 0   | 0  | 8   | 0   |
| 2036              | 0   | 0   | 0   | 0   | 0   | 0   | 0   | 0   | 0  | 7   | 0   |
| 2037              | 0   | 0   | 0   | 0   | 0   | 0   | 0   | 0   | 0  | 7   | 0   |
| 2038              | 0   | 0   | 0   | 0   | 0   | 0   | 0   | 0   | 0  | 3   | 0   |
| 2039              | 0   | 0   | 0   | 0   | 0   | 0   | 0   | 0   | 0  | 2   | 0   |
| 2040              | 0   | 0   | 0   | 0   | 0   | 0   | 0   | 0   | 0  | 0   | 0   |
| 2041              | 0   | 0   | 0   | 0   | 0   | 0   | 0   | 0   | 0  | 0   | 0   |
| 2042              | 0   | 0   | 0   | 0   | 0   | 0   | 0   | 0   | 0  | 0   | 0   |
| 2043              | 0   | 0   | 0   | 0   | 0   | 0   | 0   | 0   | 0  | 0   | 0   |
| 2044              | 0   | 0   | 0   | 0   | 0   | 0   | 0   | 0   | 0  | 0   | 0   |
| 2045              | 0   | 0   | 0   | 0   | 0   | 0   | 0   | 0   | 0  | 0   | 0   |
| 2046              | 0   | 0   | 0   | 0   | 0   | 0   | 0   | 0   | 0  | 0   | 0   |
| 2047              | 0   | 0   | 0   | 0   | 0   | 0   | 0   | 0   | 0  | 0   | 0   |
| 2048              | 0   | 0   | 0   | 0   | 0   | 0   | 0   | 0   | 0  | 0   | 0   |
| 2049              | 0   | 0   | 0   | 0   | 0   | 0   | 0   | 0   | 0  | 0   | 0   |
| 2050              | 0   | 0   | 0   | 0   | 0   | 0   | 0   | 0   | 0  | 0   | 0   |
| 2051              | 0   | 0   | 0   | 0   | 0   | 0   | 0   | 0   | 0  | 0   | 0   |
| 2052              | 0   | 0   | 0   | 0   | 0   | 0   | 0   | 0   | 0  | 0   | 0   |
| 2053              | 0   | 0   | 0   | 0   | 0   | 0   | 0   | 0   | 0  | 0   | 0   |
| 2054              | 0   | 0   | 0   | 0   | 0   | 0   | 0   | 0   | 0  | 0   | 0   |
| 2055              | 0   | 0   | 0   | 0   | 0   | 0   | 0   | 0   | 0  | 0   | 0   |
| 2056              | 0   | 0   | 0   | 0   | 0   | 0   | 0   | 0   | 0  | 0   | 0   |
| 2057              | 0   | 0   | 0   | 0   | 0   | 0   | 0   | 0   | 0  | 0   | 0   |



| ScenarioID /<br>Year | 71 | 72 | 73 | 74 | 75 | 76 | 77 | 78 | 79 | 80 | 81 |
|----------------------|----|----|----|----|----|----|----|----|----|----|----|
| 2058                 | 0  | 0  | 0  | 0  | 0  | 0  | 0  | 0  | 0  | 0  | 0  |
| 2059                 | 0  | 0  | 0  | 0  | 0  | 0  | 0  | 0  | 0  | 0  | 0  |
| 2060                 | 0  | 0  | 0  | 0  | 0  | 0  | 0  | 0  | 0  | 0  | 0  |
| 2061                 | 0  | 0  | 0  | 0  | 0  | 0  | 0  | 0  | 0  | 0  | 0  |
| 2062                 | 0  | 0  | 0  | 0  | 0  | 0  | 0  | 0  | 0  | 0  | 0  |
| 2063                 | 0  | 0  | 0  | 0  | 0  | 0  | 0  | 0  | 0  | 0  | 0  |
| 2064                 | 0  | 0  | 0  | 0  | 0  | 0  | 0  | 0  | 0  | 0  | 0  |
| 2065                 | 0  | 0  | 0  | 0  | 0  | 0  | 0  | 0  | 0  | 0  | 0  |
| 2066                 | 0  | 0  | 0  | 0  | 0  | 0  | 0  | 0  | 0  | 0  | 0  |
| 2067                 | 0  | 0  | 0  | 0  | 0  | 0  | 0  | 0  | 0  | 0  | 0  |
| 2068                 | 0  | 0  | 0  | 0  | 0  | 0  | 0  | 0  | 0  | 0  | 0  |
| 2069                 | 0  | 0  | 0  | 0  | 0  | 0  | 0  | 0  | 0  | 0  | 0  |
| 2070                 | 0  | 0  | 0  | 0  | 0  | 0  | 0  | 0  | 0  | 0  | 0  |
| 2071                 | 0  | 0  | 0  | 0  | 0  | 0  | 0  | 0  | 0  | 0  | 0  |
| 2072                 | 0  | 0  | 0  | 0  | 0  | 0  | 0  | 0  | 0  | 0  | 0  |
| 2073                 | 0  | 0  | 0  | 0  | 0  | 0  | 0  | 0  | 0  | 0  | 0  |
| 2074                 | 0  | 0  | 0  | 0  | 0  | 0  | 0  | 0  | 0  | 0  | 0  |
| 2075                 | 0  | 0  | 0  | 0  | 0  | 0  | 0  | 0  | 0  | 0  | 0  |
| 2076                 | 0  | 0  | 0  | 0  | 0  | 0  | 0  | 0  | 0  | 0  | 0  |
| 2077                 | 0  | 0  | 0  | 0  | 0  | 0  | 0  | 0  | 0  | 0  | 0  |
| 2078                 | 0  | 0  | 0  | 0  | 0  | 0  | 0  | 0  | 0  | 0  | 0  |
| 2079                 | 0  | 0  | 0  | 0  | 0  | 0  | 0  | 0  | 0  | 0  | 0  |
| 2080                 | 0  | 0  | 0  | 0  | 0  | 0  | 0  | 0  | 0  | 0  | 0  |
| 2081                 | 0  | 0  | 0  | 0  | 0  | 0  | 0  | 0  | 0  | 0  | 0  |
| 2082                 | 0  | 0  | 0  | 0  | 0  | 0  | 0  | 0  | 0  | 0  | 0  |
| 2083                 | 0  | 0  | 0  | 0  | 0  | 0  | 0  | 0  | 0  | 0  | 0  |
| 2084                 | 0  | 0  | 0  | 0  | 0  | 0  | 0  | 0  | 0  | 0  | 0  |
| 2085                 | 0  | 0  | 0  | 0  | 0  | 0  | 0  | 0  | 0  | 0  | 0  |
| 2086                 | 0  | 0  | 0  | 0  | 0  | 0  | 0  | 0  | 0  | 0  | 0  |
| 2087                 | 0  | 0  | 0  | 0  | 0  | 0  | 0  | 0  | 0  | 0  | 0  |
| 2088                 | 0  | 0  | 0  | 0  | 0  | 0  | 0  | 0  | 0  | 0  | 0  |
| 2089                 | 0  | 0  | 0  | 0  | 0  | 0  | 0  | 0  | 0  | 0  | 0  |
| 2090                 | 0  | 0  | 0  | 0  | 0  | 0  | 0  | 0  | 0  | 0  | 0  |

| ScenarioID / Year | 1  | 2   | 3  | 4   | 5   | 6  | 7 | 8   | 9  |
|-------------------|----|-----|----|-----|-----|----|---|-----|----|
| 2002              | 0  | 0   | 0  | 0   | 0   | 0  | 0 | 0   | 0  |
| 2003              | 0  | 0   | 0  | 0   | 0   | 0  | 0 | 0   | 0  |
| 2004              | 0  | 0   | 0  | 0   | 0   | 0  | 0 | 0   | 0  |
| 2005              | 0  | 0   | 0  | 0   | 0   | 0  | 0 | 0   | 0  |
| 2006              | 0  | 0   | 0  | 0   | 0   | 0  | 0 | 0   | 0  |
| 2007              | 0  | 0   | 0  | 0   | 0   | 0  | 0 | 0   | 0  |
| 2008              | 0  | 0   | 0  | 0   | 0   | 0  | 0 | 0   | 0  |
| 2009              | 0  | 0   | 0  | 0   | 0   | 0  | 0 | 0   | 0  |
| 2010              | 0  | 0   | 0  | 0   | 0   | 0  | 0 | 0   | 0  |
| 2011              | 0  | 0   | 0  | 0   | 0   | 0  | 0 | 0   | 0  |
| 2012              | 0  | 0   | 0  | 0   | 0   | 0  | 0 | 0   | 0  |
| 2013              | 0  | 0   | 0  | 0   | 0   | 0  | 0 | 0   | 0  |
| 2014              | 0  | 0   | 0  | 0   | 0   | 0  | 0 | 0   | 0  |
| 2015              | 0  | 0   | 0  | 0   | 0   | 0  | 0 | 0   | 0  |
| 2016              | 0  | 0   | 0  | 0   | 0   | 0  | 0 | 0   | 0  |
| 2017              | 0  | 0   | 0  | 0   | 0   | 0  | 0 | 0   | 0  |
| 2018              | 0  | 0   | 0  | 0   | 0   | 0  | 0 | 0   | 0  |
| 2019              | 0  | 0   | 0  | 0   | 0   | 0  | 0 | 0   | 0  |
| 2020              | 0  | 0   | 0  | 5   | 0   | 0  | 0 | 0   | 0  |
| 2021              | 0  | 0   | 0  | 8   | 0   | 0  | 0 | 0   | 0  |
| 2022              | 0  | 0   | 0  | 11  | 0   | 0  | 0 | 0   | 0  |
| 2023              | 0  | 0   | 0  | 10  | 0   | 0  | 0 | 0   | 0  |
| 2024              | 0  | 0   | 0  | 10  | 0   | 0  | 0 | 0   | 0  |
| 2025              | 5  | 5   | 0  | 14  | 5   | 5  | 0 | 43  | 5  |
| 2026              | 8  | 8   | 0  | 10  | 8   | 8  | 0 | 77  | 8  |
| 2027              | 10 | 10  | 0  | 14  | 10  | 10 | 0 | 107 | 10 |
| 2028              | 10 | 10  | 0  | 23  | 10  | 10 | 0 | 125 | 10 |
| 2029              | 13 | 13  | 0  | 27  | 13  | 13 | 0 | 154 | 13 |
| 2030              | 19 | 19  | 4  | 41  | 21  | 21 | 0 | 183 | 19 |
| 2031              | 27 | 27  | 14 | 45  | 24  | 22 | 4 | 205 | 27 |
| 2032              | 34 | 34  | 18 | 65  | 34  | 34 | 4 | 255 | 34 |
| 2033              | 39 | 39  | 24 | 72  | 39  | 39 | 3 | 291 | 39 |
| 2034              | 61 | 61  | 46 | 110 | 61  | 58 | 5 | 379 | 61 |
| 2035              | 69 | 69  | 48 | 139 | 64  | 69 | 3 | 464 | 69 |
| 2036              | 73 | 73  | 45 | 179 | 73  | 74 | 1 | 503 | 73 |
| 2037              | 80 | 87  | 45 | 142 | 88  | 78 | 4 | 578 | 86 |
| 2038              | 99 | 100 | 45 | 107 | 105 | 85 | 8 | 615 | 99 |
| 2039              | 88 | 88  | 53 | 92  | 91  | 86 | 3 | 568 | 87 |
| 2040              | 63 | 67  | 74 | 65  | 68  | 57 | 0 | 508 | 67 |
| 2041              | 48 | 51  | 59 | 51  | 55  | 40 | 0 | 461 | 51 |
| 2042              | 36 | 38  | 47 | 37  | 42  | 28 | 0 | 411 | 38 |
| 2043              | 23 | 27  | 32 | 23  | 30  | 17 | 0 | 363 | 27 |
| 2044              | 16 | 19  | 26 | 13  | 21  | 12 | 0 | 310 | 19 |
| 2045              | 3  | 4   | 14 | 7   | 8   | 4  | 0 | 257 | 4  |
| 2046              | 2  | 3   | 12 | 7   | 7   | 3  | 0 | 231 | 3  |
| 2047              | 0  | 0   | 1  | 2   | 3   | 1  | 0 | 183 | 0  |
| 2048              | 0  | 0   | 1  | 2   | 3   | 1  | 0 | 154 | 0  |
| 2049              | 0  | 0   | 0  | 0   | 0   | 1  | 0 | 126 | 0  |
| 2050              | 0  | 0   | 0  | 0   | 0   | 1  | 0 | 98  | 0  |
| 2051              | 0  | 0   | 0  | 0   | 0   | 1  | 0 | 79  | 0  |

| ScenarioID /<br>Year | 1 | 2 | 3 | 4 | 5 | 6 | 7 | 8  | 9 |
|----------------------|---|---|---|---|---|---|---|----|---|
| 2052                 | 0 | 0 | 0 | 0 | 0 | 0 | 0 | 59 | 0 |
| 2053                 | 0 | 0 | 0 | 0 | 0 | 0 | 0 | 46 | 0 |
| 2054                 | 0 | 0 | 0 | 0 | 0 | 0 | 0 | 37 | 0 |
| 2055                 | 0 | 0 | 0 | 0 | 0 | 0 | 0 | 21 | 0 |
| 2056                 | 0 | 0 | 0 | 0 | 0 | 0 | 0 | 18 | 0 |
| 2057                 | 0 | 0 | 0 | 0 | 0 | 0 | 0 | 5  | 0 |
| 2058                 | 0 | 0 | 0 | 0 | 0 | 0 | 0 | 4  | 0 |
| 2059                 | 0 | 0 | 0 | 0 | 0 | 0 | 0 | 1  | 0 |
| 2060                 | 0 | 0 | 0 | 0 | 0 | 0 | 0 | 0  | 0 |
| 2061                 | 0 | 0 | 0 | 0 | 0 | 0 | 0 | 0  | 0 |
| 2062                 | 0 | 0 | 0 | 0 | 0 | 0 | 0 | 0  | 0 |
| 2063                 | 0 | 0 | 0 | 0 | 0 | 0 | 0 | 0  | 0 |
| 2064                 | 0 | 0 | 0 | 0 | 0 | 0 | 0 | 0  | 0 |
| 2065                 | 0 | 0 | 0 | 0 | 0 | 0 | 0 | 0  | 0 |
| 2066                 | 0 | 0 | 0 | 0 | 0 | 0 | 0 | 0  | 0 |
| 2067                 | 0 | 0 | 0 | 0 | 0 | 0 | 0 | 0  | 0 |
| 2068                 | 0 | 0 | 0 | 0 | 0 | 0 | 0 | 0  | 0 |
| 2069                 | 0 | 0 | 0 | 0 | 0 | 0 | 0 | 0  | 0 |
| 2070                 | 0 | 0 | 0 | 0 | 0 | 0 | 0 | 0  | 0 |
| 2071                 | 0 | 0 | 0 | 0 | 0 | 0 | 0 | 0  | 0 |
| 2072                 | 0 | 0 | 0 | 0 | 0 | 0 | 0 | 0  | 0 |
| 2073                 | 0 | 0 | 0 | 0 | 0 | 0 | 0 | 0  | 0 |
| 2074                 | 0 | 0 | 0 | 0 | 0 | 0 | 0 | 0  | 0 |
| 2075                 | 0 | 0 | 0 | 0 | 0 | 0 | 0 | 0  | 0 |
| 2076                 | 0 | 0 | 0 | 0 | 0 | 0 | 0 | 0  | 0 |
| 2077                 | 0 | 0 | 0 | 0 | 0 | 0 | 0 | 0  | 0 |
| 2078                 | 0 | 0 | 0 | 0 | 0 | 0 | 0 | 0  | 0 |
| 2079                 | 0 | 0 | 0 | 0 | 0 | 0 | 0 | 0  | 0 |
| 2080                 | 0 | 0 | 0 | 0 | 0 | 0 | 0 | 0  | 0 |
| 2081                 | 0 | 0 | 0 | 0 | 0 | 0 | 0 | 0  | 0 |
| 2082                 | 0 | 0 | 0 | 0 | 0 | 0 | 0 | 0  | 0 |
| 2083                 | 0 | 0 | 0 | 0 | 0 | 0 | 0 | 0  | 0 |
| 2084                 | 0 | 0 | 0 | 0 | 0 | 0 | 0 | 0  | 0 |
| 2085                 | 0 | 0 | 0 | 0 | 0 | 0 | 0 | 0  | 0 |
| 2086                 | 0 | 0 | 0 | 0 | 0 | 0 | 0 | 0  | 0 |
| 2087                 | 0 | 0 | 0 | 0 | 0 | 0 | 0 | 0  | 0 |
| 2088                 | 0 | 0 | 0 | 0 | 0 | 0 | 0 | 0  | 0 |
| 2089                 | 0 | 0 | 0 | 0 | 0 | 0 | 0 | 0  | 0 |
| 2090                 | 0 | 0 | 0 | 0 | 0 | 0 | 0 | 0  | 0 |

| ScenarioID /<br>Year | 10  | 11  | 12  | 13  | 14  | 15  | 16 | 17   | 18  |
|----------------------|-----|-----|-----|-----|-----|-----|----|------|-----|
| 2002                 | 0   | 0   | 0   | 0   | 0   | 0   | 0  | 0    | 0   |
| 2003                 | 0   | 0   | 0   | 0   | 0   | 0   | 0  | 0    | 0   |
| 2004                 | 0   | 0   | 0   | 0   | 0   | 0   | 0  | 0    | 0   |
| 2005                 | 0   | 0   | 0   | 0   | 0   | 0   | 0  | 0    | 0   |
| 2006                 | 0   | 0   | 0   | 0   | 0   | 0   | 0  | 0    | 0   |
| 2007                 | 0   | 0   | 0   | 0   | 0   | 0   | 0  | 0    | 0   |
| 2008                 | 0   | 0   | 0   | 0   | 0   | 0   | 0  | 0    | 0   |
| 2009                 | 0   | 0   | 0   | 0   | 0   | 0   | 0  | 0    | 0   |
| 2010                 | 0   | 0   | 0   | 0   | 0   | 0   | 0  | 0    | 0   |
| 2011                 | 0   | 0   | 0   | 0   | 0   | 0   | 0  | 0    | 0   |
| 2012                 | 0   | 0   | 0   | 0   | 0   | 0   | 0  | 0    | 0   |
| 2013                 | 0   | 0   | 0   | 0   | 0   | 0   | 0  | 0    | 0   |
| 2014                 | 0   | 0   | 0   | 0   | 0   | 0   | 0  | 0    | 0   |
| 2015                 | 0   | 0   | 0   | 0   | 0   | 0   | 0  | 0    | 0   |
| 2016                 | 0   | 0   | 0   | 0   | 0   | 0   | 0  | 0    | 0   |
| 2017                 | 0   | 0   | 0   | 0   | 0   | 0   | 0  | 0    | 0   |
| 2018                 | 0   | 0   | 0   | 0   | 0   | 0   | 0  | 0    | 0   |
| 2019                 | 0   | 0   | 0   | 0   | 0   | 0   | 0  | 0    | 0   |
| 2020                 | 0   | 0   | 0   | 145 | 0   | 0   | 0  | 0    | 0   |
| 2021                 | 0   | 0   | 0   | 301 | 0   | 0   | 0  | 0    | 0   |
| 2022                 | 0   | 0   | 0   | 363 | 0   | 0   | 0  | 0    | 0   |
| 2023                 | 0   | 0   | 0   | 379 | 0   | 0   | 0  | 0    | 0   |
| 2024                 | 0   | 0   | 0   | 423 | 0   | 0   | 0  | 0    | 0   |
| 2025                 | 183 | 183 | 0   | 417 | 188 | 85  | 3  | 317  | 183 |
| 2026                 | 310 | 310 | 0   | 448 | 348 | 150 | 8  | 611  | 310 |
| 2027                 | 418 | 411 | 0   | 464 | 450 | 160 | 12 | 867  | 413 |
| 2028                 | 481 | 475 | 0   | 453 | 556 | 186 | 16 | 1141 | 475 |
| 2029                 | 508 | 499 | 0   | 431 | 613 | 219 | 15 | 1382 | 504 |
| 2030                 | 531 | 520 | 187 | 386 | 684 | 280 | 15 | 1607 | 523 |
| 2031                 | 519 | 513 | 342 | 408 | 713 | 300 | 23 | 1776 | 516 |
| 2032                 | 529 | 517 | 424 | 437 | 734 | 294 | 22 | 1949 | 525 |
| 2033                 | 518 | 515 | 492 | 425 | 722 | 285 | 23 | 2081 | 519 |
| 2034                 | 552 | 554 | 576 | 388 | 744 | 282 | 37 | 2214 | 557 |
| 2035                 | 506 | 512 | 571 | 373 | 687 | 313 | 45 | 2327 | 517 |
| 2036                 | 481 | 484 | 605 | 368 | 683 | 313 | 48 | 2342 | 494 |
| 2037                 | 499 | 508 | 594 | 353 | 668 | 331 | 66 | 2409 | 511 |
| 2038                 | 518 | 526 | 620 | 319 | 709 | 327 | 79 | 2459 | 528 |
| 2039                 | 476 | 492 | 617 | 287 | 702 | 344 | 85 | 2381 | 492 |
| 2040                 | 388 | 409 | 577 | 250 | 593 | 259 | 76 | 2153 | 407 |
| 2041                 | 323 | 343 | 564 | 203 | 475 | 193 | 55 | 1858 | 342 |
| 2042                 | 269 | 286 | 479 | 172 | 398 | 143 | 49 | 1618 | 284 |
| 2043                 | 208 | 220 | 401 | 126 | 340 | 95  | 24 | 1436 | 219 |
| 2044                 | 168 | 181 | 332 | 106 | 294 | 59  | 17 | 1276 | 181 |
| 2045                 | 139 | 151 | 277 | 82  | 265 | 34  | 3  | 1116 | 151 |
| 2046                 | 116 | 124 | 197 | 73  | 230 | 24  | 0  | 998  | 126 |
| 2047                 | 86  | 94  | 154 | 62  | 195 | 13  | 0  | 885  | 94  |
| 2048                 | 74  | 80  | 103 | 44  | 162 | 0   | 0  | 752  | 82  |
| 2049                 | 62  | 67  | 74  | 39  | 129 | 0   | 0  | 632  | 69  |
| 2050                 | 49  | 54  | 55  | 20  | 106 | 0   | 0  | 552  | 54  |
| 2051                 | 43  | 45  | 42  | 16  | 92  | 0   | 0  | 467  | 45  |

| ScenarioID /<br>Year | 10 | 11 | 12 | 13 | 14 | 15 | 16 | 17  | 18 |
|----------------------|----|----|----|----|----|----|----|-----|----|
| 2052                 | 29 | 25 | 32 | 1  | 77 | 0  | 0  | 400 | 25 |
| 2053                 | 21 | 17 | 27 | 0  | 62 | 0  | 0  | 346 | 17 |
| 2054                 | 8  | 6  | 20 | 0  | 41 | 0  | 0  | 278 | 6  |
| 2055                 | 1  | 1  | 13 | 0  | 28 | 0  | 0  | 224 | 1  |
| 2056                 | 0  | 0  | 5  | 0  | 17 | 0  | 0  | 198 | 0  |
| 2057                 | 0  | 0  | 1  | 0  | 6  | 0  | 0  | 158 | 0  |
| 2058                 | 0  | 0  | 0  | 0  | 4  | 0  | 0  | 136 | 0  |
| 2059                 | 0  | 0  | 0  | 0  | 1  | 0  | 0  | 104 | 0  |
| 2060                 | 0  | 0  | 0  | 0  | 0  | 0  | 0  | 89  | 0  |
| 2061                 | 0  | 0  | 0  | 0  | 0  | 0  | 0  | 76  | 0  |
| 2062                 | 0  | 0  | 0  | 0  | 0  | 0  | 0  | 62  | 0  |
| 2063                 | 0  | 0  | 0  | 0  | 0  | 0  | 0  | 52  | 0  |
| 2064                 | 0  | 0  | 0  | 0  | 0  | 0  | 0  | 44  | 0  |
| 2065                 | 0  | 0  | 0  | 0  | 0  | 0  | 0  | 23  | 0  |
| 2066                 | 0  | 0  | 0  | 0  | 0  | 0  | 0  | 14  | 0  |
| 2067                 | 0  | 0  | 0  | 0  | 0  | 0  | 0  | 4   | 0  |
| 2068                 | 0  | 0  | 0  | 0  | 0  | 0  | 0  | 1   | 0  |
| 2069                 | 0  | 0  | 0  | 0  | 0  | 0  | 0  | 0   | 0  |
| 2070                 | 0  | 0  | 0  | 0  | 0  | 0  | 0  | 0   | 0  |
| 2071                 | 0  | 0  | 0  | 0  | 0  | 0  | 0  | 0   | 0  |
| 2072                 | 0  | 0  | 0  | 0  | 0  | 0  | 0  | 0   | 0  |
| 2073                 | 0  | 0  | 0  | 0  | 0  | 0  | 0  | 0   | 0  |
| 2074                 | 0  | 0  | 0  | 0  | 0  | 0  | 0  | 0   | 0  |
| 2075                 | 0  | 0  | 0  | 0  | 0  | 0  | 0  | 0   | 0  |
| 2076                 | 0  | 0  | 0  | 0  | 0  | 0  | 0  | 0   | 0  |
| 2077                 | 0  | 0  | 0  | 0  | 0  | 0  | 0  | 0   | 0  |
| 2078                 | 0  | 0  | 0  | 0  | 0  | 0  | 0  | 0   | 0  |
| 2079                 | 0  | 0  | 0  | 0  | 0  | 0  | 0  | 0   | 0  |
| 2080                 | 0  | 0  | 0  | 0  | 0  | 0  | 0  | 0   | 0  |
| 2081                 | 0  | 0  | 0  | 0  | 0  | 0  | 0  | 0   | 0  |
| 2082                 | 0  | 0  | 0  | 0  | 0  | 0  | 0  | 0   | 0  |
| 2083                 | 0  | 0  | 0  | 0  | 0  | 0  | 0  | 0   | 0  |
| 2084                 | 0  | 0  | 0  | 0  | 0  | 0  | 0  | 0   | 0  |
| 2085                 | 0  | 0  | 0  | 0  | 0  | 0  | 0  | 0   | 0  |
| 2086                 | 0  | 0  | 0  | 0  | 0  | 0  | 0  | 0   | 0  |
| 2087                 | 0  | 0  | 0  | 0  | 0  | 0  | 0  | 0   | 0  |
| 2088                 | 0  | 0  | 0  | 0  | 0  | 0  | 0  | 0   | 0  |
| 2089                 | 0  | 0  | 0  | 0  | 0  | 0  | 0  | 0   | 0  |
| 2090                 | 0  | 0  | 0  | 0  | 0  | 0  | 0  | 0   | 0  |

| ScenarioID /<br>Year | 19   | 20   | 21   | 22   | 23   | 24  | 25  | 26   | 27   |
|----------------------|------|------|------|------|------|-----|-----|------|------|
| 2002                 | 0    | 0    | 0    | 0    | 0    | 0   | 0   | 0    | 0    |
| 2003                 | 0    | 0    | 0    | 0    | 0    | 0   | 0   | 0    | 0    |
| 2004                 | 0    | 0    | 0    | 0    | 0    | 0   | 0   | 0    | 0    |
| 2005                 | 0    | 0    | 0    | 0    | 0    | 0   | 0   | 0    | 0    |
| 2006                 | 0    | 0    | 0    | 0    | 0    | 0   | 0   | 0    | 0    |
| 2007                 | 0    | 0    | 0    | 0    | 0    | 0   | 0   | 0    | 0    |
| 2008                 | 0    | 0    | 0    | 0    | 0    | 0   | 0   | 0    | 0    |
| 2009                 | 0    | 0    | 0    | 0    | 0    | 0   | 0   | 0    | 0    |
| 2010                 | 0    | 0    | 0    | 0    | 0    | 0   | 0   | 0    | 0    |
| 2011                 | 0    | 0    | 0    | 0    | 0    | 0   | 0   | 0    | 0    |
| 2012                 | 0    | 0    | 0    | 0    | 0    | 0   | 0   | 0    | 0    |
| 2013                 | 0    | 0    | 0    | 0    | 0    | 0   | 0   | 0    | 0    |
| 2014                 | 0    | 0    | 0    | 0    | 0    | 0   | 0   | 0    | 0    |
| 2015                 | 0    | 0    | 0    | 0    | 0    | 0   | 0   | 0    | 0    |
| 2016                 | 0    | 0    | 0    | 0    | 0    | 0   | 0   | 0    | 0    |
| 2017                 | 0    | 0    | 0    | 0    | 0    | 0   | 0   | 0    | 0    |
| 2018                 | 0    | 0    | 0    | 0    | 0    | 0   | 0   | 0    | 0    |
| 2019                 | 0    | 0    | 0    | 0    | 0    | 0   | 0   | 0    | 0    |
| 2020                 | 0    | 0    | 0    | 274  | 0    | 0   | 0   | 0    | 0    |
| 2021                 | 0    | 0    | 0    | 572  | 0    | 0   | 0   | 0    | 0    |
| 2022                 | 0    | 0    | 0    | 771  | 0    | 0   | 0   | 0    | 0    |
| 2023                 | 0    | 0    | 0    | 963  | 0    | 0   | 0   | 0    | 0    |
| 2024                 | 0    | 0    | 0    | 1105 | 0    | 0   | 0   | 0    | 0    |
| 2025                 | 330  | 330  | 0    | 1264 | 343  | 238 | 193 | 351  | 330  |
| 2026                 | 586  | 586  | 0    | 1349 | 636  | 411 | 291 | 695  | 586  |
| 2027                 | 781  | 778  | 0    | 1382 | 861  | 555 | 328 | 1027 | 781  |
| 2028                 | 1009 | 1001 | 0    | 1370 | 1103 | 656 | 351 | 1360 | 1006 |
| 2029                 | 1149 | 1137 | 0    | 1372 | 1287 | 656 | 360 | 1668 | 1144 |
| 2030                 | 1282 | 1267 | 341  | 1354 | 1390 | 688 | 377 | 1992 | 1273 |
| 2031                 | 1411 | 1397 | 639  | 1341 | 1557 | 712 | 325 | 2295 | 1406 |
| 2032                 | 1439 | 1425 | 858  | 1293 | 1704 | 685 | 303 | 2569 | 1434 |
| 2033                 | 1476 | 1471 | 1023 | 1282 | 1794 | 713 | 283 | 2836 | 1476 |
| 2034                 | 1440 | 1429 | 1147 | 1233 | 1847 | 745 | 327 | 3067 | 1437 |
| 2035                 | 1451 | 1439 | 1338 | 1156 | 1891 | 752 | 290 | 3286 | 1448 |
| 2036                 | 1396 | 1382 | 1383 | 1083 | 1799 | 735 | 279 | 3401 | 1386 |
| 2037                 | 1317 | 1307 | 1462 | 899  | 1746 | 729 | 249 | 3533 | 1306 |
| 2038                 | 1292 | 1282 | 1476 | 711  | 1715 | 720 | 228 | 3639 | 1284 |
| 2039                 | 1132 | 1165 | 1438 | 537  | 1593 | 629 | 206 | 3571 | 1150 |
| 2040                 | 877  | 912  | 1351 | 423  | 1299 | 459 | 116 | 3345 | 899  |
| 2041                 | 683  | 710  | 1224 | 323  | 1049 | 324 | 64  | 3166 | 701  |
| 2042                 | 547  | 570  | 1024 | 264  | 833  | 218 | 12  | 2955 | 558  |
| 2043                 | 435  | 446  | 771  | 205  | 694  | 140 | 2   | 2684 | 440  |
| 2044                 | 339  | 351  | 643  | 158  | 575  | 75  | 0   | 2390 | 344  |
| 2045                 | 242  | 253  | 498  | 91   | 463  | 18  | 0   | 2124 | 249  |
| 2046                 | 191  | 200  | 400  | 66   | 366  | 11  | 0   | 1857 | 196  |
| 2047                 | 136  | 144  | 308  | 37   | 285  | 2   | 0   | 1627 | 140  |
| 2048                 | 58   | 68   | 210  | 23   | 232  | 0   | 0   | 1415 | 62   |
| 2049                 | 26   | 30   | 136  | 21   | 196  | 0   | 0   | 1222 | 28   |
| 2050                 | 11   | 8    | 74   | 12   | 138  | 0   | 0   | 1020 | 8    |
| 2051                 | 8    | 5    | 33   | 8    | 90   | 0   | 0   | 866  | 5    |

| ScenarioID /<br>Year | 19 | 20 | 21 | 22 | 23 | 24 | 25 | 26  | 27 |
|----------------------|----|----|----|----|----|----|----|-----|----|
| 2052                 | 3  | 0  | 11 | 0  | 46 | 0  | 0  | 747 | 0  |
| 2053                 | 2  | 0  | 3  | 0  | 23 | 0  | 0  | 605 | 0  |
| 2054                 | 1  | 0  | 3  | 0  | 14 | 0  | 0  | 507 | 0  |
| 2055                 | 0  | 0  | 1  | 0  | 6  | 0  | 0  | 414 | 0  |
| 2056                 | 0  | 0  | 0  | 0  | 2  | 0  | 0  | 347 | 0  |
| 2057                 | 0  | 0  | 0  | 0  | 1  | 0  | 0  | 258 | 0  |
| 2058                 | 0  | 0  | 0  | 0  | 1  | 0  | 0  | 202 | 0  |
| 2059                 | 0  | 0  | 0  | 0  | 0  | 0  | 0  | 142 | 0  |
| 2060                 | 0  | 0  | 0  | 0  | 0  | 0  | 0  | 71  | 0  |
| 2061                 | 0  | 0  | 0  | 0  | 0  | 0  | 0  | 40  | 0  |
| 2062                 | 0  | 0  | 0  | 0  | 0  | 0  | 0  | 19  | 0  |
| 2063                 | 0  | 0  | 0  | 0  | 0  | 0  | 0  | 7   | 0  |
| 2064                 | 0  | 0  | 0  | 0  | 0  | 0  | 0  | 5   | 0  |
| 2065                 | 0  | 0  | 0  | 0  | 0  | 0  | 0  | 0   | 0  |
| 2066                 | 0  | 0  | 0  | 0  | 0  | 0  | 0  | 0   | 0  |
| 2067                 | 0  | 0  | 0  | 0  | 0  | 0  | 0  | 0   | 0  |
| 2068                 | 0  | 0  | 0  | 0  | 0  | 0  | 0  | 0   | 0  |
| 2069                 | 0  | 0  | 0  | 0  | 0  | 0  | 0  | 0   | 0  |
| 2070                 | 0  | 0  | 0  | 0  | 0  | 0  | 0  | 0   | 0  |
| 2071                 | 0  | 0  | 0  | 0  | 0  | 0  | 0  | 0   | 0  |
| 2072                 | 0  | 0  | 0  | 0  | 0  | 0  | 0  | 0   | 0  |
| 2073                 | 0  | 0  | 0  | 0  | 0  | 0  | 0  | 0   | 0  |
| 2074                 | 0  | 0  | 0  | 0  | 0  | 0  | 0  | 0   | 0  |
| 2075                 | 0  | 0  | 0  | 0  | 0  | 0  | 0  | 0   | 0  |
| 2076                 | 0  | 0  | 0  | 0  | 0  | 0  | 0  | 0   | 0  |
| 2077                 | 0  | 0  | 0  | 0  | 0  | 0  | 0  | 0   | 0  |
| 2078                 | 0  | 0  | 0  | 0  | 0  | 0  | 0  | 0   | 0  |
| 2079                 | 0  | 0  | 0  | 0  | 0  | 0  | 0  | 0   | 0  |
| 2080                 | 0  | 0  | 0  | 0  | 0  | 0  | 0  | 0   | 0  |
| 2081                 | 0  | 0  | 0  | 0  | 0  | 0  | 0  | 0   | 0  |
| 2082                 | 0  | 0  | 0  | 0  | 0  | 0  | 0  | 0   | 0  |
| 2083                 | 0  | 0  | 0  | 0  | 0  | 0  | 0  | 0   | 0  |
| 2084                 | 0  | 0  | 0  | 0  | 0  | 0  | 0  | 0   | 0  |
| 2085                 | 0  | 0  | 0  | 0  | 0  | 0  | 0  | 0   | 0  |
| 2086                 | 0  | 0  | 0  | 0  | 0  | 0  | 0  | 0   | 0  |
| 2087                 | 0  | 0  | 0  | 0  | 0  | 0  | 0  | 0   | 0  |
| 2088                 | 0  | 0  | 0  | 0  | 0  | 0  | 0  | 0   | 0  |
| 2089                 | 0  | 0  | 0  | 0  | 0  | 0  | 0  | 0   | 0  |
| 2090                 | 0  | 0  | 0  | 0  | 0  | 0  | 0  | 0   | 0  |

| ScenarioID /<br>Year | 28  | 29  | 30  | 31  | 32  | 33  | 34 | 35   | 36  |
|----------------------|-----|-----|-----|-----|-----|-----|----|------|-----|
| 2002                 | 0   | 0   | 0   | 0   | 0   | 0   | 0  | 0    | 0   |
| 2003                 | 0   | 0   | 0   | 0   | 0   | 0   | 0  | 0    | 0   |
| 2004                 | 0   | 0   | 0   | 0   | 0   | 0   | 0  | 0    | 0   |
| 2005                 | 0   | 0   | 0   | 0   | 0   | 0   | 0  | 0    | 0   |
| 2006                 | 0   | 0   | 0   | 0   | 0   | 0   | 0  | 0    | 0   |
| 2007                 | 0   | 0   | 0   | 0   | 0   | 0   | 0  | 0    | 0   |
| 2008                 | 0   | 0   | 0   | 0   | 0   | 0   | 0  | 0    | 0   |
| 2009                 | 0   | 0   | 0   | 0   | 0   | 0   | 0  | 0    | 0   |
| 2010                 | 0   | 0   | 0   | 0   | 0   | 0   | 0  | 0    | 0   |
| 2011                 | 0   | 0   | 0   | 0   | 0   | 0   | 0  | 0    | 0   |
| 2012                 | 0   | 0   | 0   | 0   | 0   | 0   | 0  | 0    | 0   |
| 2013                 | 0   | 0   | 0   | 0   | 0   | 0   | 0  | 0    | 0   |
| 2014                 | 0   | 0   | 0   | 0   | 0   | 0   | 0  | 0    | 0   |
| 2015                 | 0   | 0   | 0   | 0   | 0   | 0   | 0  | 0    | 0   |
| 2016                 | 0   | 0   | 0   | 0   | 0   | 0   | 0  | 0    | 0   |
| 2017                 | 0   | 0   | 0   | 0   | 0   | 0   | 0  | 0    | 0   |
| 2018                 | 0   | 0   | 0   | 0   | 0   | 0   | 0  | 0    | 0   |
| 2019                 | 0   | 0   | 0   | 0   | 0   | 0   | 0  | 0    | 0   |
| 2020                 | 0   | 0   | 0   | 5   | 0   | 0   | 0  | 0    | 0   |
| 2021                 | 0   | 0   | 0   | 8   | 0   | 0   | 0  | 0    | 0   |
| 2022                 | 0   | 0   | 0   | 11  | 0   | 0   | 0  | 0    | 0   |
| 2023                 | 0   | 0   | 0   | 10  | 0   | 0   | 0  | 0    | 0   |
| 2024                 | 0   | 0   | 0   | 10  | 0   | 0   | 0  | 0    | 0   |
| 2025                 | 5   | 5   | 0   | 13  | 5   | 5   | 0  | 39   | 5   |
| 2026                 | 8   | 8   | 0   | 10  | 8   | 8   | 0  | 74   | 8   |
| 2027                 | 10  | 10  | 0   | 15  | 10  | 11  | 0  | 104  | 10  |
| 2028                 | 10  | 10  | 0   | 15  | 10  | 10  | 0  | 122  | 10  |
| 2029                 | 13  | 13  | 0   | 34  | 13  | 13  | 0  | 145  | 13  |
| 2030                 | 15  | 15  | 4   | 91  | 15  | 15  | 0  | 182  | 15  |
| 2031                 | 21  | 21  | 14  | 132 | 23  | 17  | 3  | 233  | 21  |
| 2032                 | 22  | 22  | 18  | 172 | 24  | 20  | 1  | 329  | 22  |
| 2033                 | 24  | 24  | 24  | 206 | 38  | 34  | 1  | 403  | 24  |
| 2034                 | 59  | 72  | 40  | 267 | 82  | 59  | 3  | 516  | 72  |
| 2035                 | 88  | 86  | 41  | 286 | 109 | 104 | 5  | 605  | 86  |
| 2036                 | 101 | 137 | 33  | 273 | 123 | 113 | 20 | 689  | 137 |
| 2037                 | 146 | 185 | 32  | 269 | 144 | 127 | 36 | 782  | 186 |
| 2038                 | 185 | 208 | 26  | 256 | 140 | 133 | 35 | 785  | 194 |
| 2039                 | 214 | 231 | 34  | 249 | 175 | 129 | 59 | 848  | 216 |
| 2040                 | 239 | 249 | 60  | 271 | 206 | 156 | 57 | 913  | 231 |
| 2041                 | 219 | 235 | 97  | 268 | 190 | 155 | 55 | 914  | 210 |
| 2042                 | 217 | 225 | 116 | 277 | 217 | 152 | 49 | 933  | 221 |
| 2043                 | 207 | 217 | 138 | 284 | 224 | 151 | 47 | 935  | 219 |
| 2044                 | 213 | 217 | 155 | 280 | 238 | 177 | 44 | 999  | 217 |
| 2045                 | 216 | 216 | 180 | 292 | 246 | 178 | 40 | 1083 | 217 |
| 2046                 | 236 | 236 | 194 | 315 | 267 | 202 | 51 | 1261 | 236 |
| 2047                 | 219 | 225 | 183 | 292 | 254 | 185 | 49 | 1323 | 226 |
| 2048                 | 226 | 232 | 187 | 297 | 260 | 185 | 51 | 1396 | 233 |
| 2049                 | 229 | 229 | 185 | 323 | 255 | 188 | 40 | 1456 | 229 |
| 2050                 | 221 | 216 | 180 | 339 | 225 | 157 | 50 | 1522 | 217 |
| 2051                 | 229 | 214 | 182 | 328 | 213 | 148 | 50 | 1598 | 217 |



| ScenarioID /<br>Year | 28  | 29  | 30  | 31  | 32  | 33  | 34  | 35   | 36  |
|----------------------|-----|-----|-----|-----|-----|-----|-----|------|-----|
| 2052                 | 246 | 225 | 180 | 389 | 224 | 173 | 39  | 1763 | 224 |
| 2053                 | 253 | 203 | 164 | 448 | 202 | 193 | 17  | 1817 | 219 |
| 2054                 | 292 | 227 | 146 | 543 | 198 | 231 | 9   | 1890 | 218 |
| 2055                 | 391 | 250 | 124 | 671 | 214 | 259 | 1   | 1953 | 266 |
| 2056                 | 487 | 331 | 99  | 758 | 247 | 344 | 1   | 2082 | 353 |
| 2057                 | 603 | 432 | 89  | 807 | 357 | 479 | 16  | 2218 | 472 |
| 2058                 | 645 | 527 | 128 | 768 | 464 | 576 | 85  | 2302 | 561 |
| 2059                 | 630 | 550 | 186 | 714 | 526 | 561 | 129 | 2284 | 593 |
| 2060                 | 602 | 548 | 256 | 681 | 575 | 551 | 113 | 2226 | 588 |
| 2061                 | 590 | 545 | 335 | 655 | 574 | 543 | 90  | 2138 | 576 |
| 2062                 | 549 | 528 | 352 | 614 | 543 | 504 | 76  | 2015 | 538 |
| 2063                 | 534 | 523 | 355 | 588 | 534 | 508 | 48  | 1924 | 525 |
| 2064                 | 483 | 472 | 308 | 526 | 481 | 468 | 30  | 1848 | 473 |
| 2065                 | 455 | 450 | 293 | 490 | 452 | 441 | 21  | 1734 | 451 |
| 2066                 | 395 | 400 | 277 | 421 | 407 | 386 | 18  | 1651 | 395 |
| 2067                 | 338 | 351 | 259 | 354 | 345 | 335 | 11  | 1520 | 338 |
| 2068                 | 293 | 296 | 233 | 299 | 296 | 283 | 13  | 1421 | 293 |
| 2069                 | 243 | 241 | 199 | 243 | 236 | 226 | 15  | 1302 | 243 |
| 2070                 | 184 | 184 | 150 | 184 | 181 | 171 | 12  | 1182 | 184 |
| 2071                 | 150 | 150 | 119 | 150 | 150 | 139 | 10  | 1086 | 150 |
| 2072                 | 108 | 108 | 90  | 108 | 107 | 100 | 7   | 988  | 108 |
| 2073                 | 71  | 71  | 66  | 71  | 71  | 65  | 7   | 905  | 71  |
| 2074                 | 49  | 49  | 46  | 49  | 49  | 45  | 4   | 824  | 49  |
| 2075                 | 36  | 36  | 35  | 36  | 36  | 35  | 2   | 728  | 36  |
| 2076                 | 24  | 24  | 24  | 24  | 24  | 22  | 1   | 664  | 24  |
| 2077                 | 19  | 19  | 19  | 19  | 18  | 19  | 0   | 574  | 19  |
| 2078                 | 17  | 17  | 17  | 17  | 16  | 17  | 0   | 500  | 17  |
| 2079                 | 12  | 12  | 12  | 12  | 12  | 12  | 0   | 426  | 12  |
| 2080                 | 10  | 10  | 10  | 10  | 10  | 10  | 0   | 358  | 10  |
| 2081                 | 9   | 9   | 9   | 9   | 9   | 9   | 0   | 301  | 9   |
| 2082                 | 7   | 7   | 7   | 7   | 7   | 7   | 0   | 240  | 7   |
| 2083                 | 5   | 5   | 5   | 5   | 5   | 5   | 0   | 187  | 5   |
| 2084                 | 4   | 4   | 4   | 4   | 4   | 4   | 0   | 150  | 4   |
| 2085                 | 2   | 2   | 2   | 2   | 2   | 2   | 0   | 107  | 2   |
| 2086                 | 0   | 0   | 0   | 0   | 0   | 0   | 0   | 73   | 0   |
| 2087                 | 0   | 0   | 0   | 0   | 0   | 0   | 0   | 52   | 0   |
| 2088                 | 0   | 0   | 0   | 0   | 0   | 0   | 0   | 37   | 0   |
| 2089                 | 0   | 0   | 0   | 0   | 0   | 0   | 0   | 25   | 0   |
| 2090                 | 0   | 0   | 0   | 0   | 0   | 0   | 0   | 19   | 0   |

| ScenarioID /<br>Year | 37  | 38  | 39  | 40  | 41  | 42  | 43  | 44   | 45  |
|----------------------|-----|-----|-----|-----|-----|-----|-----|------|-----|
| 2002                 | 0   | 0   | 0   | 0   | 0   | 0   | 0   | 0    | 0   |
| 2003                 | 0   | 0   | 0   | 0   | 0   | 0   | 0   | 0    | 0   |
| 2004                 | 0   | 0   | 0   | 0   | 0   | 0   | 0   | 0    | 0   |
| 2005                 | 0   | 0   | 0   | 0   | 0   | 0   | 0   | 0    | 0   |
| 2006                 | 0   | 0   | 0   | 0   | 0   | 0   | 0   | 0    | 0   |
| 2007                 | 0   | 0   | 0   | 0   | 0   | 0   | 0   | 0    | 0   |
| 2008                 | 0   | 0   | 0   | 0   | 0   | 0   | 0   | 0    | 0   |
| 2009                 | 0   | 0   | 0   | 0   | 0   | 0   | 0   | 0    | 0   |
| 2010                 | 0   | 0   | 0   | 0   | 0   | 0   | 0   | 0    | 0   |
| 2011                 | 0   | 0   | 0   | 0   | 0   | 0   | 0   | 0    | 0   |
| 2012                 | 0   | 0   | 0   | 0   | 0   | 0   | 0   | 0    | 0   |
| 2013                 | 0   | 0   | 0   | 0   | 0   | 0   | 0   | 0    | 0   |
| 2014                 | 0   | 0   | 0   | 0   | 0   | 0   | 0   | 0    | 0   |
| 2015                 | 0   | 0   | 0   | 0   | 0   | 0   | 0   | 0    | 0   |
| 2016                 | 0   | 0   | 0   | 0   | 0   | 0   | 0   | 0    | 0   |
| 2017                 | 0   | 0   | 0   | 0   | 0   | 0   | 0   | 0    | 0   |
| 2018                 | 0   | 0   | 0   | 0   | 0   | 0   | 0   | 0    | 0   |
| 2019                 | 0   | 0   | 0   | 0   | 0   | 0   | 0   | 0    | 0   |
| 2020                 | 0   | 0   | 0   | 193 | 0   | 0   | 0   | 0    | 0   |
| 2021                 | 0   | 0   | 0   | 336 | 0   | 0   | 0   | 0    | 0   |
| 2022                 | 0   | 0   | 0   | 418 | 0   | 0   | 0   | 0    | 0   |
| 2023                 | 0   | 0   | 0   | 396 | 0   | 0   | 0   | 0    | 0   |
| 2024                 | 0   | 0   | 0   | 407 | 0   | 0   | 0   | 0    | 0   |
| 2025                 | 223 | 223 | 0   | 438 | 226 | 98  | 3   | 361  | 223 |
| 2026                 | 352 | 352 | 0   | 432 | 387 | 147 | 6   | 660  | 352 |
| 2027                 | 465 | 458 | 0   | 470 | 502 | 151 | 12  | 954  | 460 |
| 2028                 | 535 | 521 | 0   | 488 | 634 | 186 | 15  | 1213 | 526 |
| 2029                 | 537 | 528 | 0   | 446 | 684 | 207 | 11  | 1453 | 531 |
| 2030                 | 558 | 563 | 219 | 443 | 770 | 244 | 17  | 1689 | 563 |
| 2031                 | 544 | 542 | 374 | 425 | 771 | 299 | 24  | 1836 | 537 |
| 2032                 | 583 | 567 | 466 | 399 | 780 | 296 | 30  | 2037 | 561 |
| 2033                 | 504 | 512 | 564 | 393 | 691 | 299 | 33  | 2191 | 505 |
| 2034                 | 522 | 529 | 610 | 394 | 679 | 295 | 40  | 2376 | 524 |
| 2035                 | 555 | 559 | 634 | 441 | 652 | 326 | 45  | 2534 | 548 |
| 2036                 | 496 | 527 | 586 | 467 | 645 | 332 | 63  | 2610 | 515 |
| 2037                 | 467 | 516 | 542 | 497 | 642 | 339 | 84  | 2630 | 496 |
| 2038                 | 472 | 496 | 570 | 556 | 629 | 317 | 90  | 2616 | 473 |
| 2039                 | 468 | 497 | 561 | 582 | 672 | 312 | 93  | 2574 | 472 |
| 2040                 | 455 | 496 | 557 | 602 | 692 | 282 | 111 | 2524 | 482 |
| 2041                 | 462 | 469 | 528 | 618 | 711 | 300 | 111 | 2452 | 467 |
| 2042                 | 447 | 457 | 531 | 602 | 737 | 232 | 116 | 2400 | 470 |
| 2043                 | 482 | 482 | 524 | 583 | 803 | 245 | 113 | 2292 | 493 |
| 2044                 | 530 | 487 | 511 | 610 | 847 | 253 | 120 | 2161 | 509 |
| 2045                 | 576 | 515 | 525 | 645 | 846 | 259 | 141 | 2055 | 546 |
| 2046                 | 571 | 504 | 471 | 686 | 874 | 273 | 147 | 1936 | 535 |
| 2047                 | 644 | 526 | 473 | 765 | 898 | 263 | 173 | 1919 | 596 |
| 2048                 | 646 | 563 | 466 | 790 | 877 | 287 | 176 | 1935 | 615 |
| 2049                 | 657 | 601 | 484 | 829 | 881 | 313 | 168 | 1908 | 642 |
| 2050                 | 626 | 613 | 505 | 841 | 874 | 323 | 176 | 1891 | 611 |
| 2051                 | 610 | 608 | 517 | 870 | 843 | 354 | 195 | 1856 | 607 |

| ScenarioID /<br>Year | 37  | 38  | 39  | 40  | 41  | 42  | 43  | 44   | 45  |
|----------------------|-----|-----|-----|-----|-----|-----|-----|------|-----|
| 2052                 | 621 | 623 | 495 | 887 | 867 | 364 | 185 | 1854 | 619 |
| 2053                 | 631 | 606 | 511 | 889 | 847 | 381 | 171 | 1794 | 604 |
| 2054                 | 630 | 620 | 527 | 938 | 807 | 427 | 152 | 1761 | 606 |
| 2055                 | 619 | 625 | 535 | 901 | 774 | 453 | 142 | 1748 | 603 |
| 2056                 | 620 | 602 | 537 | 875 | 746 | 460 | 125 | 1790 | 600 |
| 2057                 | 602 | 560 | 525 | 848 | 711 | 432 | 114 | 1735 | 571 |
| 2058                 | 589 | 550 | 498 | 800 | 719 | 449 | 97  | 1680 | 556 |
| 2059                 | 579 | 527 | 466 | 728 | 681 | 448 | 89  | 1601 | 545 |
| 2060                 | 547 | 477 | 412 | 657 | 608 | 462 | 78  | 1542 | 493 |
| 2061                 | 513 | 452 | 391 | 604 | 573 | 438 | 71  | 1461 | 456 |
| 2062                 | 450 | 406 | 360 | 548 | 519 | 404 | 62  | 1405 | 401 |
| 2063                 | 388 | 363 | 339 | 462 | 473 | 354 | 48  | 1306 | 363 |
| 2064                 | 334 | 309 | 301 | 374 | 422 | 323 | 34  | 1261 | 307 |
| 2065                 | 288 | 264 | 266 | 319 | 348 | 294 | 24  | 1180 | 264 |
| 2066                 | 243 | 233 | 247 | 298 | 304 | 263 | 23  | 1143 | 221 |
| 2067                 | 203 | 193 | 213 | 263 | 234 | 216 | 11  | 1084 | 188 |
| 2068                 | 172 | 159 | 188 | 231 | 173 | 188 | 3   | 1008 | 157 |
| 2069                 | 147 | 131 | 156 | 182 | 128 | 151 | 3   | 950  | 132 |
| 2070                 | 120 | 108 | 126 | 146 | 101 | 119 | 0   | 866  | 113 |
| 2071                 | 113 | 103 | 119 | 123 | 72  | 107 | 0   | 793  | 107 |
| 2072                 | 86  | 77  | 90  | 84  | 58  | 89  | 0   | 714  | 81  |
| 2073                 | 60  | 51  | 63  | 49  | 35  | 48  | 0   | 644  | 57  |
| 2074                 | 39  | 35  | 44  | 32  | 21  | 29  | 0   | 583  | 39  |
| 2075                 | 21  | 20  | 31  | 20  | 15  | 21  | 0   | 512  | 23  |
| 2076                 | 9   | 6   | 16  | 5   | 11  | 8   | 0   | 437  | 9   |
| 2077                 | 4   | 3   | 4   | 2   | 4   | 5   | 0   | 369  | 4   |
| 2078                 | 3   | 3   | 3   | 2   | 4   | 3   | 0   | 314  | 3   |
| 2079                 | 0   | 0   | 0   | 0   | 4   | 0   | 0   | 255  | 0   |
| 2080                 | 0   | 0   | 0   | 0   | 0   | 0   | 0   | 209  | 0   |
| 2081                 | 0   | 0   | 0   | 0   | 0   | 0   | 0   | 177  | 0   |
| 2082                 | 0   | 0   | 0   | 0   | 0   | 0   | 0   | 149  | 0   |
| 2083                 | 0   | 0   | 0   | 0   | 0   | 0   | 0   | 126  | 0   |
| 2084                 | 0   | 0   | 0   | 0   | 0   | 0   | 0   | 106  | 0   |
| 2085                 | 0   | 0   | 0   | 0   | 0   | 0   | 0   | 79   | 0   |
| 2086                 | 0   | 0   | 0   | 0   | 0   | 0   | 0   | 57   | 0   |
| 2087                 | 0   | 0   | 0   | 0   | 0   | 0   | 0   | 42   | 0   |
| 2088                 | 0   | 0   | 0   | 0   | 0   | 0   | 0   | 23   | 0   |
| 2089                 | 0   | 0   | 0   | 0   | 0   | 0   | 0   | 10   | 0   |
| 2090                 | 0   | 0   | 0   | 0   | 0   | 0   | 0   | 4    | 0   |

| ScenarioID /<br>Year | 46   | 47   | 48   | 49   | 50   | 51  | 52  | 53   | 54   |
|----------------------|------|------|------|------|------|-----|-----|------|------|
| 2002                 | 0    | 0    | 0    | 0    | 0    | 0   | 0   | 0    | 0    |
| 2003                 | 0    | 0    | 0    | 0    | 0    | 0   | 0   | 0    | 0    |
| 2004                 | 0    | 0    | 0    | 0    | 0    | 0   | 0   | 0    | 0    |
| 2005                 | 0    | 0    | 0    | 0    | 0    | 0   | 0   | 0    | 0    |
| 2006                 | 0    | 0    | 0    | 0    | 0    | 0   | 0   | 0    | 0    |
| 2007                 | 0    | 0    | 0    | 0    | 0    | 0   | 0   | 0    | 0    |
| 2008                 | 0    | 0    | 0    | 0    | 0    | 0   | 0   | 0    | 0    |
| 2009                 | 0    | 0    | 0    | 0    | 0    | 0   | 0   | 0    | 0    |
| 2010                 | 0    | 0    | 0    | 0    | 0    | 0   | 0   | 0    | 0    |
| 2011                 | 0    | 0    | 0    | 0    | 0    | 0   | 0   | 0    | 0    |
| 2012                 | 0    | 0    | 0    | 0    | 0    | 0   | 0   | 0    | 0    |
| 2013                 | 0    | 0    | 0    | 0    | 0    | 0   | 0   | 0    | 0    |
| 2014                 | 0    | 0    | 0    | 0    | 0    | 0   | 0   | 0    | 0    |
| 2015                 | 0    | 0    | 0    | 0    | 0    | 0   | 0   | 0    | 0    |
| 2016                 | 0    | 0    | 0    | 0    | 0    | 0   | 0   | 0    | 0    |
| 2017                 | 0    | 0    | 0    | 0    | 0    | 0   | 0   | 0    | 0    |
| 2018                 | 0    | 0    | 0    | 0    | 0    | 0   | 0   | 0    | 0    |
| 2019                 | 0    | 0    | 0    | 0    | 0    | 0   | 0   | 0    | 0    |
| 2020                 | 0    | 0    | 0    | 323  | 0    | 0   | 0   | 0    | 0    |
| 2021                 | 0    | 0    | 0    | 610  | 0    | 0   | 0   | 0    | 0    |
| 2022                 | 0    | 0    | 0    | 817  | 0    | 0   | 0   | 0    | 0    |
| 2023                 | 0    | 0    | 0    | 985  | 0    | 0   | 0   | 0    | 0    |
| 2024                 | 0    | 0    | 0    | 1100 | 0    | 0   | 0   | 0    | 0    |
| 2025                 | 376  | 376  | 0    | 1237 | 386  | 281 | 210 | 422  | 376  |
| 2026                 | 610  | 610  | 0    | 1268 | 661  | 417 | 318 | 773  | 610  |
| 2027                 | 800  | 797  | 0    | 1299 | 891  | 560 | 306 | 1131 | 800  |
| 2028                 | 1001 | 990  | 0    | 1308 | 1107 | 607 | 309 | 1447 | 997  |
| 2029                 | 1137 | 1122 | 0    | 1324 | 1269 | 578 | 312 | 1728 | 1128 |
| 2030                 | 1256 | 1229 | 372  | 1290 | 1387 | 626 | 328 | 1997 | 1238 |
| 2031                 | 1365 | 1315 | 655  | 1342 | 1498 | 690 | 280 | 2258 | 1330 |
| 2032                 | 1408 | 1347 | 825  | 1319 | 1626 | 672 | 275 | 2516 | 1372 |
| 2033                 | 1408 | 1353 | 1018 | 1262 | 1703 | 706 | 294 | 2759 | 1390 |
| 2034                 | 1372 | 1335 | 1125 | 1190 | 1796 | 744 | 303 | 2943 | 1363 |
| 2035                 | 1409 | 1383 | 1293 | 1189 | 1910 | 765 | 290 | 3176 | 1408 |
| 2036                 | 1328 | 1323 | 1286 | 1066 | 1837 | 731 | 256 | 3304 | 1341 |
| 2037                 | 1274 | 1289 | 1345 | 1048 | 1765 | 706 | 211 | 3449 | 1290 |
| 2038                 | 1258 | 1276 | 1358 | 980  | 1657 | 693 | 193 | 3502 | 1263 |
| 2039                 | 1225 | 1240 | 1314 | 941  | 1648 | 682 | 205 | 3581 | 1221 |
| 2040                 | 1142 | 1188 | 1310 | 883  | 1615 | 632 | 199 | 3682 | 1157 |
| 2041                 | 1060 | 1083 | 1178 | 877  | 1576 | 625 | 189 | 3728 | 1072 |
| 2042                 | 1002 | 1022 | 1189 | 821  | 1562 | 518 | 168 | 3754 | 1012 |
| 2043                 | 968  | 996  | 1136 | 822  | 1535 | 481 | 153 | 3718 | 990  |
| 2044                 | 937  | 949  | 1101 | 833  | 1469 | 485 | 145 | 3653 | 945  |
| 2045                 | 864  | 894  | 1041 | 729  | 1388 | 442 | 176 | 3574 | 873  |
| 2046                 | 822  | 861  | 1024 | 691  | 1254 | 436 | 161 | 3469 | 828  |
| 2047                 | 762  | 791  | 964  | 648  | 1151 | 326 | 159 | 3352 | 788  |
| 2048                 | 649  | 677  | 834  | 652  | 1097 | 335 | 101 | 3193 | 667  |
| 2049                 | 608  | 631  | 781  | 672  | 1082 | 346 | 112 | 3032 | 626  |
| 2050                 | 559  | 561  | 687  | 715  | 992  | 319 | 115 | 2812 | 573  |
| 2051                 | 505  | 513  | 649  | 716  | 889  | 324 | 139 | 2659 | 510  |

| ScenarioID /<br>Year | 46  | 47  | 48  | 49  | 50  | 51  | 52  | 53   | 54  |
|----------------------|-----|-----|-----|-----|-----|-----|-----|------|-----|
| 2052                 | 511 | 504 | 643 | 673 | 800 | 310 | 134 | 2484 | 514 |
| 2053                 | 513 | 471 | 561 | 710 | 721 | 298 | 155 | 2250 | 515 |
| 2054                 | 516 | 477 | 486 | 736 | 642 | 308 | 140 | 2071 | 516 |
| 2055                 | 490 | 460 | 435 | 746 | 537 | 339 | 133 | 1931 | 500 |
| 2056                 | 449 | 449 | 386 | 722 | 495 | 325 | 105 | 1769 | 468 |
| 2057                 | 433 | 432 | 352 | 668 | 460 | 278 | 107 | 1639 | 453 |
| 2058                 | 447 | 411 | 333 | 625 | 430 | 280 | 98  | 1489 | 438 |
| 2059                 | 441 | 397 | 319 | 612 | 420 | 316 | 94  | 1380 | 426 |
| 2060                 | 386 | 337 | 271 | 548 | 369 | 323 | 86  | 1232 | 377 |
| 2061                 | 353 | 289 | 246 | 518 | 307 | 295 | 76  | 1131 | 346 |
| 2062                 | 316 | 239 | 218 | 444 | 260 | 269 | 74  | 1033 | 319 |
| 2063                 | 288 | 225 | 188 | 398 | 239 | 278 | 61  | 971  | 300 |
| 2064                 | 250 | 193 | 170 | 333 | 218 | 267 | 40  | 915  | 267 |
| 2065                 | 188 | 143 | 142 | 267 | 183 | 239 | 30  | 847  | 215 |
| 2066                 | 174 | 144 | 131 | 245 | 163 | 194 | 29  | 793  | 192 |
| 2067                 | 157 | 124 | 117 | 199 | 141 | 161 | 17  | 733  | 168 |
| 2068                 | 137 | 101 | 101 | 174 | 113 | 132 | 15  | 674  | 143 |
| 2069                 | 115 | 90  | 94  | 152 | 94  | 99  | 13  | 639  | 125 |
| 2070                 | 88  | 75  | 84  | 125 | 84  | 76  | 11  | 603  | 98  |
| 2071                 | 84  | 71  | 76  | 114 | 72  | 76  | 9   | 554  | 89  |
| 2072                 | 69  | 62  | 59  | 86  | 61  | 60  | 7   | 486  | 72  |
| 2073                 | 48  | 47  | 44  | 61  | 44  | 34  | 7   | 433  | 52  |
| 2074                 | 30  | 30  | 32  | 44  | 27  | 14  | 5   | 401  | 41  |
| 2075                 | 29  | 26  | 26  | 30  | 22  | 8   | 2   | 354  | 34  |
| 2076                 | 15  | 18  | 18  | 8   | 14  | 2   | 2   | 326  | 23  |
| 2077                 | 5   | 13  | 16  | 3   | 11  | 2   | 0   | 282  | 19  |
| 2078                 | 3   | 6   | 15  | 3   | 11  | 0   | 0   | 222  | 15  |
| 2079                 | 0   | 1   | 11  | 0   | 8   | 0   | 0   | 199  | 11  |
| 2080                 | 0   | 0   | 8   | 0   | 6   | 0   | 0   | 170  | 9   |
| 2081                 | 0   | 0   | 8   | 0   | 0   | 0   | 0   | 147  | 8   |
| 2082                 | 0   | 0   | 7   | 0   | 0   | 0   | 0   | 126  | 7   |
| 2083                 | 0   | 0   | 5   | 0   | 0   | 0   | 0   | 101  | 5   |
| 2084                 | 0   | 0   | 4   | 0   | 0   | 0   | 0   | 86   | 4   |
| 2085                 | 0   | 0   | 2   | 0   | 0   | 0   | 0   | 72   | 2   |
| 2086                 | 0   | 0   | 0   | 0   | 0   | 0   | 0   | 52   | 0   |
| 2087                 | 0   | 0   | 0   | 0   | 0   | 0   | 0   | 41   | 0   |
| 2088                 | 0   | 0   | 0   | 0   | 0   | 0   | 0   | 34   | 0   |
| 2089                 | 0   | 0   | 0   | 0   | 0   | 0   | 0   | 23   | 0   |
| 2090                 | 0   | 0   | 0   | 0   | 0   | 0   | 0   | 19   | 0   |

| ScenarioID /<br>Year | 55  | 56  | 57  | 58  | 59  | 60  | 61 | 62   | 63  |
|----------------------|-----|-----|-----|-----|-----|-----|----|------|-----|
| 2002                 | 0   | 0   | 0   | 0   | 0   | 0   | 0  | 0    | 0   |
| 2003                 | 0   | 0   | 0   | 0   | 0   | 0   | 0  | 0    | 0   |
| 2004                 | 0   | 0   | 0   | 0   | 0   | 0   | 0  | 0    | 0   |
| 2005                 | 0   | 0   | 0   | 0   | 0   | 0   | 0  | 0    | 0   |
| 2006                 | 0   | 0   | 0   | 0   | 0   | 0   | 0  | 0    | 0   |
| 2007                 | 0   | 0   | 0   | 0   | 0   | 0   | 0  | 0    | 0   |
| 2008                 | 0   | 0   | 0   | 0   | 0   | 0   | 0  | 0    | 0   |
| 2009                 | 0   | 0   | 0   | 0   | 0   | 0   | 0  | 0    | 0   |
| 2010                 | 0   | 0   | 0   | 0   | 0   | 0   | 0  | 0    | 0   |
| 2011                 | 0   | 0   | 0   | 0   | 0   | 0   | 0  | 0    | 0   |
| 2012                 | 0   | 0   | 0   | 0   | 0   | 0   | 0  | 0    | 0   |
| 2013                 | 0   | 0   | 0   | 0   | 0   | 0   | 0  | 0    | 0   |
| 2014                 | 0   | 0   | 0   | 0   | 0   | 0   | 0  | 0    | 0   |
| 2015                 | 0   | 0   | 0   | 0   | 0   | 0   | 0  | 0    | 0   |
| 2016                 | 0   | 0   | 0   | 0   | 0   | 0   | 0  | 0    | 0   |
| 2017                 | 0   | 0   | 0   | 0   | 0   | 0   | 0  | 0    | 0   |
| 2018                 | 0   | 0   | 0   | 0   | 0   | 0   | 0  | 0    | 0   |
| 2019                 | 0   | 0   | 0   | 0   | 0   | 0   | 0  | 0    | 0   |
| 2020                 | 0   | 0   | 0   | 7   | 0   | 0   | 0  | 0    | 0   |
| 2021                 | 0   | 0   | 0   | 17  | 0   | 0   | 0  | 0    | 0   |
| 2022                 | 0   | 0   | 0   | 24  | 0   | 0   | 0  | 0    | 0   |
| 2023                 | 0   | 0   | 0   | 28  | 0   | 0   | 0  | 0    | 0   |
| 2024                 | 0   | 0   | 0   | 44  | 0   | 0   | 0  | 0    | 0   |
| 2025                 | 14  | 14  | 0   | 61  | 14  | 14  | 0  | 82   | 14  |
| 2026                 | 13  | 13  | 0   | 60  | 13  | 13  | 0  | 135  | 13  |
| 2027                 | 19  | 19  | 0   | 72  | 19  | 13  | 5  | 178  | 19  |
| 2028                 | 51  | 51  | 0   | 98  | 51  | 45  | 3  | 249  | 51  |
| 2029                 | 38  | 38  | 0   | 106 | 38  | 37  | 1  | 271  | 38  |
| 2030                 | 58  | 60  | 15  | 135 | 64  | 47  | 5  | 329  | 60  |
| 2031                 | 71  | 73  | 34  | 156 | 80  | 72  | 7  | 379  | 73  |
| 2032                 | 98  | 98  | 31  | 182 | 95  | 71  | 18 | 442  | 98  |
| 2033                 | 117 | 108 | 50  | 191 | 116 | 79  | 16 | 456  | 111 |
| 2034                 | 138 | 140 | 83  | 234 | 145 | 120 | 17 | 531  | 133 |
| 2035                 | 161 | 152 | 79  | 265 | 148 | 119 | 23 | 581  | 146 |
| 2036                 | 182 | 193 | 98  | 288 | 175 | 131 | 48 | 646  | 197 |
| 2037                 | 216 | 213 | 111 | 303 | 235 | 153 | 38 | 701  | 207 |
| 2038                 | 225 | 234 | 113 | 339 | 251 | 175 | 46 | 756  | 238 |
| 2039                 | 276 | 266 | 179 | 394 | 289 | 221 | 44 | 825  | 262 |
| 2040                 | 286 | 281 | 157 | 364 | 285 | 221 | 69 | 904  | 282 |
| 2041                 | 285 | 296 | 212 | 318 | 330 | 223 | 66 | 1014 | 295 |
| 2042                 | 252 | 275 | 201 | 276 | 296 | 221 | 56 | 974  | 274 |
| 2043                 | 220 | 238 | 235 | 237 | 261 | 170 | 39 | 909  | 235 |
| 2044                 | 198 | 212 | 209 | 211 | 235 | 143 | 32 | 830  | 210 |
| 2045                 | 157 | 173 | 171 | 177 | 192 | 107 | 19 | 758  | 172 |
| 2046                 | 132 | 147 | 148 | 151 | 165 | 84  | 13 | 710  | 147 |
| 2047                 | 107 | 122 | 125 | 122 | 140 | 58  | 6  | 629  | 122 |
| 2048                 | 83  | 99  | 102 | 97  | 119 | 37  | 0  | 564  | 99  |
| 2049                 | 70  | 79  | 87  | 76  | 104 | 19  | 0  | 505  | 80  |
| 2050                 | 51  | 59  | 70  | 50  | 85  | 3   | 0  | 443  | 58  |
| 2051                 | 47  | 54  | 62  | 41  | 77  | 1   | 0  | 391  | 53  |

| ScenarioID /<br>Year | 55 | 56 | 57 | 58 | 59 | 60 | 61 | 62  | 63 |
|----------------------|----|----|----|----|----|----|----|-----|----|
| 2052                 | 30 | 36 | 45 | 22 | 56 | 0  | 0  | 352 | 35 |
| 2053                 | 25 | 33 | 37 | 15 | 52 | 0  | 0  | 301 | 32 |
| 2054                 | 14 | 20 | 25 | 5  | 39 | 0  | 0  | 269 | 19 |
| 2055                 | 10 | 14 | 20 | 1  | 33 | 0  | 0  | 231 | 13 |
| 2056                 | 6  | 10 | 16 | 1  | 28 | 0  | 0  | 208 | 9  |
| 2057                 | 0  | 0  | 5  | 0  | 16 | 0  | 0  | 181 | 0  |
| 2058                 | 0  | 0  | 5  | 0  | 15 | 0  | 0  | 157 | 0  |
| 2059                 | 0  | 0  | 0  | 0  | 6  | 0  | 0  | 137 | 0  |
| 2060                 | 0  | 0  | 0  | 0  | 3  | 0  | 0  | 110 | 0  |
| 2061                 | 0  | 0  | 0  | 0  | 2  | 0  | 0  | 92  | 0  |
| 2062                 | 0  | 0  | 0  | 0  | 0  | 0  | 0  | 68  | 0  |
| 2063                 | 0  | 0  | 0  | 0  | 0  | 0  | 0  | 58  | 0  |
| 2064                 | 0  | 0  | 0  | 0  | 0  | 0  | 0  | 48  | 0  |
| 2065                 | 0  | 0  | 0  | 0  | 0  | 0  | 0  | 34  | 0  |
| 2066                 | 0  | 0  | 0  | 0  | 0  | 0  | 0  | 30  | 0  |
| 2067                 | 0  | 0  | 0  | 0  | 0  | 0  | 0  | 15  | 0  |
| 2068                 | 0  | 0  | 0  | 0  | 0  | 0  | 0  | 13  | 0  |
| 2069                 | 0  | 0  | 0  | 0  | 0  | 0  | 0  | 8   | 0  |
| 2070                 | 0  | 0  | 0  | 0  | 0  | 0  | 0  | 0   | 0  |
| 2071                 | 0  | 0  | 0  | 0  | 0  | 0  | 0  | 0   | 0  |
| 2072                 | 0  | 0  | 0  | 0  | 0  | 0  | 0  | 0   | 0  |
| 2073                 | 0  | 0  | 0  | 0  | 0  | 0  | 0  | 0   | 0  |
| 2074                 | 0  | 0  | 0  | 0  | 0  | 0  | 0  | 0   | 0  |
| 2075                 | 0  | 0  | 0  | 0  | 0  | 0  | 0  | 0   | 0  |
| 2076                 | 0  | 0  | 0  | 0  | 0  | 0  | 0  | 0   | 0  |
| 2077                 | 0  | 0  | 0  | 0  | 0  | 0  | 0  | 0   | 0  |
| 2078                 | 0  | 0  | 0  | 0  | 0  | 0  | 0  | 0   | 0  |
| 2079                 | 0  | 0  | 0  | 0  | 0  | 0  | 0  | 0   | 0  |
| 2080                 | 0  | 0  | 0  | 0  | 0  | 0  | 0  | 0   | 0  |
| 2081                 | 0  | 0  | 0  | 0  | 0  | 0  | 0  | 0   | 0  |
| 2082                 | 0  | 0  | 0  | 0  | 0  | 0  | 0  | 0   | 0  |
| 2083                 | 0  | 0  | 0  | 0  | 0  | 0  | 0  | 0   | 0  |
| 2084                 | 0  | 0  | 0  | 0  | 0  | 0  | 0  | 0   | 0  |
| 2085                 | 0  | 0  | 0  | 0  | 0  | 0  | 0  | 0   | 0  |
| 2086                 | 0  | 0  | 0  | 0  | 0  | 0  | 0  | 0   | 0  |
| 2087                 | 0  | 0  | 0  | 0  | 0  | 0  | 0  | 0   | 0  |
| 2088                 | 0  | 0  | 0  | 0  | 0  | 0  | 0  | 0   | 0  |
| 2089                 | 0  | 0  | 0  | 0  | 0  | 0  | 0  | 0   | 0  |
| 2090                 | 0  | 0  | 0  | 0  | 0  | 0  | 0  | 0   | 0  |

| ScenarioID / Year | 64  | 65  | 66  | 67  | 68  | 69  | 70 | 71   | 72  |
|-------------------|-----|-----|-----|-----|-----|-----|----|------|-----|
| 2002              | 0   | 0   | 0   | 0   | 0   | 0   | 0  | 0    | 0   |
| 2003              | 0   | 0   | 0   | 0   | 0   | 0   | 0  | 0    | 0   |
| 2004              | 0   | 0   | 0   | 0   | 0   | 0   | 0  | 0    | 0   |
| 2005              | 0   | 0   | 0   | 0   | 0   | 0   | 0  | 0    | 0   |
| 2006              | 0   | 0   | 0   | 0   | 0   | 0   | 0  | 0    | 0   |
| 2007              | 0   | 0   | 0   | 0   | 0   | 0   | 0  | 0    | 0   |
| 2008              | 0   | 0   | 0   | 0   | 0   | 0   | 0  | 0    | 0   |
| 2009              | 0   | 0   | 0   | 0   | 0   | 0   | 0  | 0    | 0   |
| 2010              | 0   | 0   | 0   | 0   | 0   | 0   | 0  | 0    | 0   |
| 2011              | 0   | 0   | 0   | 0   | 0   | 0   | 0  | 0    | 0   |
| 2012              | 0   | 0   | 0   | 0   | 0   | 0   | 0  | 0    | 0   |
| 2013              | 0   | 0   | 0   | 0   | 0   | 0   | 0  | 0    | 0   |
| 2014              | 0   | 0   | 0   | 0   | 0   | 0   | 0  | 0    | 0   |
| 2015              | 0   | 0   | 0   | 0   | 0   | 0   | 0  | 0    | 0   |
| 2016              | 0   | 0   | 0   | 0   | 0   | 0   | 0  | 0    | 0   |
| 2017              | 0   | 0   | 0   | 0   | 0   | 0   | 0  | 0    | 0   |
| 2018              | 0   | 0   | 0   | 0   | 0   | 0   | 0  | 0    | 0   |
| 2019              | 0   | 0   | 0   | 0   | 0   | 0   | 0  | 0    | 0   |
| 2020              | 0   | 0   | 0   | 146 | 0   | 0   | 0  | 0    | 0   |
| 2021              | 0   | 0   | 0   | 230 | 0   | 0   | 0  | 0    | 0   |
| 2022              | 0   | 0   | 0   | 291 | 0   | 0   | 0  | 0    | 0   |
| 2023              | 0   | 0   | 0   | 278 | 0   | 0   | 0  | 0    | 0   |
| 2024              | 0   | 0   | 0   | 321 | 0   | 0   | 0  | 0    | 0   |
| 2025              | 148 | 148 | 0   | 362 | 156 | 82  | 3  | 263  | 148 |
| 2026              | 258 | 258 | 0   | 354 | 283 | 112 | 5  | 544  | 258 |
| 2027              | 354 | 354 | 0   | 378 | 395 | 128 | 7  | 760  | 354 |
| 2028              | 405 | 401 | 0   | 422 | 454 | 158 | 14 | 986  | 401 |
| 2029              | 450 | 446 | 0   | 443 | 511 | 194 | 10 | 1206 | 446 |
| 2030              | 499 | 495 | 147 | 449 | 594 | 243 | 14 | 1400 | 495 |
| 2031              | 503 | 500 | 258 | 478 | 674 | 270 | 20 | 1562 | 500 |
| 2032              | 532 | 529 | 383 | 500 | 734 | 271 | 19 | 1733 | 533 |
| 2033              | 512 | 504 | 457 | 482 | 718 | 282 | 25 | 1844 | 508 |
| 2034              | 529 | 519 | 522 | 426 | 744 | 268 | 26 | 1978 | 523 |
| 2035              | 518 | 519 | 515 | 439 | 725 | 270 | 22 | 2060 | 515 |
| 2036              | 528 | 536 | 611 | 491 | 748 | 317 | 39 | 2137 | 541 |
| 2037              | 515 | 519 | 599 | 502 | 738 | 389 | 47 | 2202 | 524 |
| 2038              | 528 | 540 | 626 | 523 | 735 | 373 | 51 | 2205 | 543 |
| 2039              | 525 | 567 | 665 | 577 | 746 | 424 | 60 | 2296 | 562 |
| 2040              | 546 | 582 | 682 | 540 | 758 | 418 | 85 | 2320 | 583 |
| 2041              | 522 | 537 | 662 | 452 | 774 | 414 | 75 | 2397 | 540 |
| 2042              | 463 | 501 | 647 | 402 | 643 | 392 | 63 | 2214 | 486 |
| 2043              | 386 | 416 | 594 | 327 | 591 | 311 | 47 | 2016 | 413 |
| 2044              | 316 | 356 | 516 | 266 | 501 | 234 | 39 | 1826 | 343 |
| 2045              | 249 | 281 | 417 | 213 | 420 | 158 | 24 | 1637 | 268 |
| 2046              | 185 | 225 | 330 | 152 | 380 | 98  | 14 | 1487 | 211 |
| 2047              | 145 | 178 | 248 | 113 | 324 | 55  | 7  | 1301 | 165 |
| 2048              | 107 | 151 | 181 | 91  | 271 | 37  | 1  | 1124 | 138 |
| 2049              | 78  | 108 | 148 | 84  | 215 | 17  | 0  | 936  | 95  |
| 2050              | 54  | 79  | 106 | 63  | 182 | 1   | 0  | 834  | 72  |
| 2051              | 38  | 60  | 66  | 54  | 126 | 0   | 0  | 753  | 59  |



| ScenarioID /<br>Year | 64 | 65 | 66 | 67 | 68 | 69 | 70 | 71  | 72 |
|----------------------|----|----|----|----|----|----|----|-----|----|
| 2052                 | 28 | 45 | 51 | 32 | 91 | 0  | 0  | 660 | 44 |
| 2053                 | 25 | 38 | 37 | 21 | 72 | 0  | 0  | 555 | 36 |
| 2054                 | 17 | 27 | 30 | 8  | 51 | 0  | 0  | 473 | 23 |
| 2055                 | 11 | 21 | 26 | 3  | 46 | 0  | 0  | 410 | 14 |
| 2056                 | 8  | 12 | 19 | 1  | 37 | 0  | 0  | 377 | 8  |
| 2057                 | 1  | 2  | 7  | 0  | 25 | 0  | 0  | 284 | 1  |
| 2058                 | 0  | 0  | 4  | 0  | 21 | 0  | 0  | 234 | 0  |
| 2059                 | 0  | 0  | 0  | 0  | 8  | 0  | 0  | 185 | 0  |
| 2060                 | 0  | 0  | 0  | 0  | 7  | 0  | 0  | 150 | 0  |
| 2061                 | 0  | 0  | 0  | 0  | 2  | 0  | 0  | 116 | 0  |
| 2062                 | 0  | 0  | 0  | 0  | 0  | 0  | 0  | 82  | 0  |
| 2063                 | 0  | 0  | 0  | 0  | 0  | 0  | 0  | 62  | 0  |
| 2064                 | 0  | 0  | 0  | 0  | 0  | 0  | 0  | 54  | 0  |
| 2065                 | 0  | 0  | 0  | 0  | 0  | 0  | 0  | 42  | 0  |
| 2066                 | 0  | 0  | 0  | 0  | 0  | 0  | 0  | 34  | 0  |
| 2067                 | 0  | 0  | 0  | 0  | 0  | 0  | 0  | 19  | 0  |
| 2068                 | 0  | 0  | 0  | 0  | 0  | 0  | 0  | 14  | 0  |
| 2069                 | 0  | 0  | 0  | 0  | 0  | 0  | 0  | 8   | 0  |
| 2070                 | 0  | 0  | 0  | 0  | 0  | 0  | 0  | 1   | 0  |
| 2071                 | 0  | 0  | 0  | 0  | 0  | 0  | 0  | 0   | 0  |
| 2072                 | 0  | 0  | 0  | 0  | 0  | 0  | 0  | 0   | 0  |
| 2073                 | 0  | 0  | 0  | 0  | 0  | 0  | 0  | 0   | 0  |
| 2074                 | 0  | 0  | 0  | 0  | 0  | 0  | 0  | 0   | 0  |
| 2075                 | 0  | 0  | 0  | 0  | 0  | 0  | 0  | 0   | 0  |
| 2076                 | 0  | 0  | 0  | 0  | 0  | 0  | 0  | 0   | 0  |
| 2077                 | 0  | 0  | 0  | 0  | 0  | 0  | 0  | 0   | 0  |
| 2078                 | 0  | 0  | 0  | 0  | 0  | 0  | 0  | 0   | 0  |
| 2079                 | 0  | 0  | 0  | 0  | 0  | 0  | 0  | 0   | 0  |
| 2080                 | 0  | 0  | 0  | 0  | 0  | 0  | 0  | 0   | 0  |
| 2081                 | 0  | 0  | 0  | 0  | 0  | 0  | 0  | 0   | 0  |
| 2082                 | 0  | 0  | 0  | 0  | 0  | 0  | 0  | 0   | 0  |
| 2083                 | 0  | 0  | 0  | 0  | 0  | 0  | 0  | 0   | 0  |
| 2084                 | 0  | 0  | 0  | 0  | 0  | 0  | 0  | 0   | 0  |
| 2085                 | 0  | 0  | 0  | 0  | 0  | 0  | 0  | 0   | 0  |
| 2086                 | 0  | 0  | 0  | 0  | 0  | 0  | 0  | 0   | 0  |
| 2087                 | 0  | 0  | 0  | 0  | 0  | 0  | 0  | 0   | 0  |
| 2088                 | 0  | 0  | 0  | 0  | 0  | 0  | 0  | 0   | 0  |
| 2089                 | 0  | 0  | 0  | 0  | 0  | 0  | 0  | 0   | 0  |
| 2090                 | 0  | 0  | 0  | 0  | 0  | 0  | 0  | 0   | 0  |

| ScenarioID /<br>Year | 73   | 74   | 75   | 76   | 77   | 78  | 79  | 80   | 81   |
|----------------------|------|------|------|------|------|-----|-----|------|------|
| 2002                 | 0    | 0    | 0    | 0    | 0    | 0   | 0   | 0    | 0    |
| 2003                 | 0    | 0    | 0    | 0    | 0    | 0   | 0   | 0    | 0    |
| 2004                 | 0    | 0    | 0    | 0    | 0    | 0   | 0   | 0    | 0    |
| 2005                 | 0    | 0    | 0    | 0    | 0    | 0   | 0   | 0    | 0    |
| 2006                 | 0    | 0    | 0    | 0    | 0    | 0   | 0   | 0    | 0    |
| 2007                 | 0    | 0    | 0    | 0    | 0    | 0   | 0   | 0    | 0    |
| 2008                 | 0    | 0    | 0    | 0    | 0    | 0   | 0   | 0    | 0    |
| 2009                 | 0    | 0    | 0    | 0    | 0    | 0   | 0   | 0    | 0    |
| 2010                 | 0    | 0    | 0    | 0    | 0    | 0   | 0   | 0    | 0    |
| 2011                 | 0    | 0    | 0    | 0    | 0    | 0   | 0   | 0    | 0    |
| 2012                 | 0    | 0    | 0    | 0    | 0    | 0   | 0   | 0    | 0    |
| 2013                 | 0    | 0    | 0    | 0    | 0    | 0   | 0   | 0    | 0    |
| 2014                 | 0    | 0    | 0    | 0    | 0    | 0   | 0   | 0    | 0    |
| 2015                 | 0    | 0    | 0    | 0    | 0    | 0   | 0   | 0    | 0    |
| 2016                 | 0    | 0    | 0    | 0    | 0    | 0   | 0   | 0    | 0    |
| 2017                 | 0    | 0    | 0    | 0    | 0    | 0   | 0   | 0    | 0    |
| 2018                 | 0    | 0    | 0    | 0    | 0    | 0   | 0   | 0    | 0    |
| 2019                 | 0    | 0    | 0    | 0    | 0    | 0   | 0   | 0    | 0    |
| 2020                 | 0    | 0    | 0    | 259  | 0    | 0   | 0   | 0    | 0    |
| 2021                 | 0    | 0    | 0    | 469  | 0    | 0   | 0   | 0    | 0    |
| 2022                 | 0    | 0    | 0    | 613  | 0    | 0   | 0   | 0    | 0    |
| 2023                 | 0    | 0    | 0    | 817  | 0    | 0   | 0   | 0    | 0    |
| 2024                 | 0    | 0    | 0    | 924  | 0    | 0   | 0   | 0    | 0    |
| 2025                 | 285  | 285  | 0    | 1041 | 293  | 203 | 149 | 341  | 285  |
| 2026                 | 519  | 519  | 0    | 1075 | 552  | 345 | 250 | 655  | 519  |
| 2027                 | 635  | 635  | 0    | 1113 | 703  | 477 | 285 | 902  | 635  |
| 2028                 | 836  | 830  | 0    | 1191 | 895  | 532 | 280 | 1180 | 836  |
| 2029                 | 980  | 972  | 0    | 1179 | 1060 | 547 | 302 | 1433 | 978  |
| 2030                 | 1077 | 1071 | 296  | 1186 | 1146 | 580 | 324 | 1683 | 1077 |
| 2031                 | 1166 | 1157 | 543  | 1219 | 1290 | 625 | 258 | 1902 | 1161 |
| 2032                 | 1248 | 1235 | 733  | 1220 | 1426 | 671 | 272 | 2142 | 1242 |
| 2033                 | 1270 | 1261 | 854  | 1211 | 1477 | 689 | 281 | 2354 | 1265 |
| 2034                 | 1259 | 1254 | 955  | 1186 | 1574 | 706 | 329 | 2539 | 1258 |
| 2035                 | 1279 | 1276 | 1064 | 1198 | 1573 | 649 | 292 | 2695 | 1280 |
| 2036                 | 1304 | 1304 | 1153 | 1171 | 1618 | 674 | 298 | 2895 | 1309 |
| 2037                 | 1327 | 1323 | 1239 | 1139 | 1652 | 685 | 317 | 3075 | 1330 |
| 2038                 | 1317 | 1311 | 1302 | 1111 | 1675 | 699 | 266 | 3208 | 1316 |
| 2039                 | 1301 | 1295 | 1339 | 1096 | 1697 | 762 | 279 | 3319 | 1295 |
| 2040                 | 1306 | 1320 | 1375 | 914  | 1658 | 769 | 276 | 3444 | 1310 |
| 2041                 | 1238 | 1269 | 1337 | 712  | 1606 | 782 | 246 | 3552 | 1259 |
| 2042                 | 1019 | 1040 | 1354 | 556  | 1368 | 623 | 129 | 3362 | 1048 |
| 2043                 | 810  | 831  | 1264 | 439  | 1156 | 442 | 73  | 3114 | 837  |
| 2044                 | 660  | 679  | 1081 | 363  | 963  | 324 | 20  | 2888 | 689  |
| 2045                 | 488  | 505  | 858  | 268  | 793  | 224 | 8   | 2634 | 510  |
| 2046                 | 383  | 403  | 670  | 218  | 650  | 133 | 6   | 2399 | 404  |
| 2047                 | 321  | 328  | 522  | 164  | 547  | 52  | 3   | 2155 | 318  |
| 2048                 | 233  | 248  | 400  | 111  | 443  | 25  | 0   | 1948 | 229  |
| 2049                 | 149  | 158  | 301  | 54   | 359  | 7   | 0   | 1733 | 146  |
| 2050                 | 79   | 90   | 208  | 27   | 304  | 2   | 0   | 1510 | 78   |
| 2051                 | 36   | 44   | 148  | 19   | 235  | 0   | 0   | 1342 | 43   |

| ScenarioID /<br>Year | 73 | 74 | 75  | 76 | 77  | 78 | 79 | 80   | 81 |
|----------------------|----|----|-----|----|-----|----|----|------|----|
| 2052                 | 15 | 16 | 109 | 9  | 158 | 0  | 0  | 1169 | 20 |
| 2053                 | 10 | 14 | 50  | 7  | 116 | 0  | 0  | 1027 | 17 |
| 2054                 | 6  | 8  | 14  | 3  | 69  | 0  | 0  | 896  | 9  |
| 2055                 | 3  | 3  | 7   | 0  | 43  | 0  | 0  | 751  | 6  |
| 2056                 | 2  | 1  | 4   | 0  | 17  | 0  | 0  | 635  | 5  |
| 2057                 | 0  | 0  | 2   | 0  | 7   | 0  | 0  | 497  | 0  |
| 2058                 | 0  | 0  | 2   | 0  | 7   | 0  | 0  | 376  | 0  |
| 2059                 | 0  | 0  | 0   | 0  | 5   | 0  | 0  | 311  | 0  |
| 2060                 | 0  | 0  | 0   | 0  | 2   | 0  | 0  | 228  | 0  |
| 2061                 | 0  | 0  | 0   | 0  | 0   | 0  | 0  | 168  | 0  |
| 2062                 | 0  | 0  | 0   | 0  | 0   | 0  | 0  | 93   | 0  |
| 2063                 | 0  | 0  | 0   | 0  | 0   | 0  | 0  | 57   | 0  |
| 2064                 | 0  | 0  | 0   | 0  | 0   | 0  | 0  | 29   | 0  |
| 2065                 | 0  | 0  | 0   | 0  | 0   | 0  | 0  | 17   | 0  |
| 2066                 | 0  | 0  | 0   | 0  | 0   | 0  | 0  | 17   | 0  |
| 2067                 | 0  | 0  | 0   | 0  | 0   | 0  | 0  | 8    | 0  |
| 2068                 | 0  | 0  | 0   | 0  | 0   | 0  | 0  | 6    | 0  |
| 2069                 | 0  | 0  | 0   | 0  | 0   | 0  | 0  | 5    | 0  |
| 2070                 | 0  | 0  | 0   | 0  | 0   | 0  | 0  | 0    | 0  |
| 2071                 | 0  | 0  | 0   | 0  | 0   | 0  | 0  | 0    | 0  |
| 2072                 | 0  | 0  | 0   | 0  | 0   | 0  | 0  | 0    | 0  |
| 2073                 | 0  | 0  | 0   | 0  | 0   | 0  | 0  | 0    | 0  |
| 2074                 | 0  | 0  | 0   | 0  | 0   | 0  | 0  | 0    | 0  |
| 2075                 | 0  | 0  | 0   | 0  | 0   | 0  | 0  | 0    | 0  |
| 2076                 | 0  | 0  | 0   | 0  | 0   | 0  | 0  | 0    | 0  |
| 2077                 | 0  | 0  | 0   | 0  | 0   | 0  | 0  | 0    | 0  |
| 2078                 | 0  | 0  | 0   | 0  | 0   | 0  | 0  | 0    | 0  |
| 2079                 | 0  | 0  | 0   | 0  | 0   | 0  | 0  | 0    | 0  |
| 2080                 | 0  | 0  | 0   | 0  | 0   | 0  | 0  | 0    | 0  |
| 2081                 | 0  | 0  | 0   | 0  | 0   | 0  | 0  | 0    | 0  |
| 2082                 | 0  | 0  | 0   | 0  | 0   | 0  | 0  | 0    | 0  |
| 2083                 | 0  | 0  | 0   | 0  | 0   | 0  | 0  | 0    | 0  |
| 2084                 | 0  | 0  | 0   | 0  | 0   | 0  | 0  | 0    | 0  |
| 2085                 | 0  | 0  | 0   | 0  | 0   | 0  | 0  | 0    | 0  |
| 2086                 | 0  | 0  | 0   | 0  | 0   | 0  | 0  | 0    | 0  |
| 2087                 | 0  | 0  | 0   | 0  | 0   | 0  | 0  | 0    | 0  |
| 2088                 | 0  | 0  | 0   | 0  | 0   | 0  | 0  | 0    | 0  |
| 2089                 | 0  | 0  | 0   | 0  | 0   | 0  | 0  | 0    | 0  |
| 2090                 | 0  | 0  | 0   | 0  | 0   | 0  | 0  | 0    | 0  |

| ScenarioID /<br>Year | 1    | 2    | 3    | 4    | 5    | 6    | 7    | 8    | 9    |
|----------------------|------|------|------|------|------|------|------|------|------|
| 2002                 | 0    | 0    | 0    | 0    | 0    | 0    | 0    | 0    | 0    |
| 2003                 | 0    | 0    | 0    | 0    | 0    | 0    | 0    | 0    | 0    |
| 2004                 | 0    | 0    | 0    | 0    | 0    | 0    | 0    | 0    | 0    |
| 2005                 | 0    | 0    | 0    | 0    | 0    | 0    | 0    | 0    | 0    |
| 2006                 | 0    | 0    | 0    | 0    | 0    | 0    | 0    | 0    | 0    |
| 2007                 | 0    | 0    | 0    | 0    | 0    | 0    | 0    | 0    | 0    |
| 2008                 | 0    | 0    | 0    | 0    | 0    | 0    | 0    | 0    | 0    |
| 2009                 | 0    | 0    | 0    | 0    | 0    | 0    | 0    | 0    | 0    |
| 2010                 | 0    | 0    | 0    | 0    | 0    | 0    | 0    | 0    | 0    |
| 2011                 | 0    | 0    | 0    | 0    | 0    | 0    | 0    | 0    | 0    |
| 2012                 | 0    | 0    | 0    | 0    | 0    | 0    | 0    | 0    | 0    |
| 2013                 | 0    | 0    | 0    | 0    | 0    | 0    | 0    | 0    | 0    |
| 2014                 | 0    | 0    | 0    | 0    | 0    | 0    | 0    | 0    | 0    |
| 2015                 | 0    | 0    | 0    | 0    | 0    | 0    | 0    | 0    | 0    |
| 2016                 | 0    | 0    | 0    | 0    | 0    | 0    | 0    | 0    | 0    |
| 2017                 | 0    | 0    | 0    | 0    | 0    | 0    | 0    | 0    | 0    |
| 2018                 | 0    | 0    | 0    | 0    | 0    | 0    | 0    | 0    | 0    |
| 2019                 | 0    | 0    | 0    | 0    | 0    | 0    | 0    | 0    | 0    |
| 2020                 | 0    | 0    | 0    | 388  | 0    | 0    | 0    | 0    | 0    |
| 2021                 | 0    | 0    | 0    | 792  | 0    | 0    | 0    | 0    | 0    |
| 2022                 | 0    | 0    | 0    | 1166 | 0    | 0    | 0    | 0    | 0    |
| 2023                 | 0    | 0    | 0    | 1541 | 0    | 0    | 0    | 0    | 0    |
| 2024                 | 0    | 0    | 0    | 1905 | 0    | 0    | 0    | 0    | 0    |
| 2025                 | 400  | 400  | 0    | 2266 | 400  | 400  | 405  | 362  | 400  |
| 2026                 | 814  | 814  | 0    | 2630 | 811  | 811  | 822  | 745  | 814  |
| 2027                 | 1196 | 1196 | 0    | 2972 | 1193 | 1193 | 1206 | 1099 | 1196 |
| 2028                 | 1596 | 1596 | 0    | 3323 | 1593 | 1598 | 1606 | 1481 | 1596 |
| 2029                 | 1939 | 1939 | 0    | 3662 | 1936 | 1950 | 1952 | 1798 | 1939 |
| 2030                 | 2293 | 2293 | 423  | 4007 | 2288 | 2309 | 2312 | 2129 | 2293 |
| 2031                 | 2660 | 2660 | 838  | 4355 | 2652 | 2683 | 2683 | 2482 | 2660 |
| 2032                 | 3003 | 3003 | 1233 | 4699 | 2990 | 3026 | 3033 | 2782 | 3003 |
| 2033                 | 3359 | 3359 | 1620 | 5028 | 3345 | 3397 | 3395 | 3107 | 3359 |
| 2034                 | 3724 | 3724 | 2007 | 5383 | 3709 | 3772 | 3780 | 3406 | 3724 |
| 2035                 | 4058 | 4058 | 2409 | 5702 | 4050 | 4121 | 4124 | 3663 | 4058 |
| 2036                 | 4419 | 4427 | 2769 | 6003 | 4398 | 4485 | 4499 | 3997 | 4427 |
| 2037                 | 4788 | 4792 | 3141 | 6082 | 4747 | 4851 | 4875 | 4301 | 4793 |
| 2038                 | 5087 | 5101 | 3479 | 6262 | 5052 | 5164 | 5192 | 4585 | 5101 |
| 2039                 | 5177 | 5198 | 3823 | 6466 | 5136 | 5304 | 5284 | 4719 | 5200 |
| 2040                 | 5405 | 5458 | 4134 | 6587 | 5396 | 5571 | 5511 | 5003 | 5444 |
| 2041                 | 5618 | 5724 | 4244 | 6649 | 5646 | 5825 | 5759 | 5298 | 5708 |
| 2042                 | 5803 | 5981 | 4503 | 6663 | 5880 | 6045 | 5958 | 5547 | 5920 |
| 2043                 | 5936 | 6186 | 4798 | 6677 | 6074 | 6240 | 6140 | 5777 | 6113 |
| 2044                 | 6024 | 6383 | 5053 | 6687 | 6276 | 6411 | 6344 | 6034 | 6325 |
| 2045                 | 6059 | 6628 | 5307 | 6693 | 6456 | 6533 | 6476 | 6219 | 6472 |
| 2046                 | 6060 | 6799 | 5545 | 6693 | 6576 | 6636 | 6593 | 6362 | 6590 |
| 2047                 | 6062 | 6967 | 5795 | 6698 | 6661 | 6685 | 6669 | 6486 | 6669 |
| 2048                 | 6062 | 7086 | 5953 | 6698 | 6691 | 6685 | 6692 | 6538 | 6692 |
| 2049                 | 6062 | 7160 | 6153 | 6700 | 6694 | 6685 | 6692 | 6566 | 6692 |
| 2050                 | 6062 | 7192 | 6346 | 6700 | 6694 | 6685 | 6692 | 6594 | 6692 |
| 2051                 | 6062 | 7192 | 6505 | 6700 | 6694 | 6685 | 6692 | 6613 | 6692 |

| ScenarioID /<br>Year | 1    | 2    | 3    | 4    | 5    | 6    | 7    | 8    | 9    |
|----------------------|------|------|------|------|------|------|------|------|------|
| 2052                 | 6062 | 7192 | 6620 | 6700 | 6694 | 6685 | 6692 | 6633 | 6692 |
| 2053                 | 6062 | 7192 | 6670 | 6700 | 6694 | 6701 | 6692 | 6646 | 6692 |
| 2054                 | 6062 | 7192 | 6695 | 6700 | 6694 | 6701 | 6692 | 6655 | 6692 |
| 2055                 | 6062 | 7192 | 6695 | 6700 | 6694 | 6701 | 6692 | 6671 | 6692 |
| 2056                 | 6062 | 7192 | 6695 | 6700 | 6694 | 6701 | 6692 | 6674 | 6692 |
| 2057                 | 6062 | 7192 | 6695 | 6700 | 6694 | 6701 | 6692 | 6687 | 6692 |
| 2058                 | 6062 | 7192 | 6695 | 6700 | 6694 | 6701 | 6692 | 6688 | 6692 |
| 2059                 | 6062 | 7192 | 6695 | 6700 | 6694 | 6701 | 6692 | 6691 | 6692 |
| 2060                 | 6062 | 7192 | 6695 | 6700 | 6694 | 6701 | 6692 | 6692 | 6692 |
| 2061                 | 6062 | 7192 | 6695 | 6700 | 6694 | 6701 | 6692 | 6692 | 6692 |
| 2062                 | 6062 | 7192 | 6695 | 6700 | 6694 | 6701 | 6692 | 6692 | 6692 |
| 2063                 | 6062 | 7192 | 6695 | 6700 | 6694 | 6701 | 6692 | 6692 | 6692 |
| 2064                 | 6062 | 7192 | 6695 | 6700 | 6694 | 6701 | 6692 | 6692 | 6692 |
| 2065                 | 6062 | 7192 | 6695 | 6700 | 6694 | 6701 | 6692 | 6692 | 6692 |
| 2066                 | 6062 | 7192 | 6695 | 6700 | 6694 | 6701 | 6692 | 6692 | 6692 |
| 2067                 | 6062 | 7192 | 6695 | 6700 | 6694 | 6701 | 6692 | 6692 | 6692 |
| 2068                 | 6062 | 7192 | 6695 | 6700 | 6694 | 6701 | 6692 | 6692 | 6692 |
| 2069                 | 6062 | 7192 | 6695 | 6700 | 6694 | 6701 | 6692 | 6692 | 6692 |
| 2070                 | 6062 | 7192 | 6695 | 6700 | 6694 | 6701 | 6692 | 6692 | 6692 |
| 2071                 | 6062 | 7192 | 6695 | 6700 | 6694 | 6701 | 6692 | 6692 | 6692 |
| 2072                 | 6062 | 7192 | 6695 | 6700 | 6694 | 6701 | 6692 | 6692 | 6692 |
| 2073                 | 6062 | 7192 | 6695 | 6700 | 6694 | 6701 | 6692 | 6692 | 6692 |
| 2074                 | 6062 | 7192 | 6695 | 6700 | 6694 | 6701 | 6692 | 6692 | 6692 |
| 2075                 | 6062 | 7192 | 6695 | 6700 | 6694 | 6701 | 6692 | 6692 | 6692 |
| 2076                 | 6062 | 7192 | 6695 | 6700 | 6694 | 6701 | 6692 | 6692 | 6692 |
| 2077                 | 6062 | 7192 | 6695 | 6700 | 6694 | 6701 | 6692 | 6692 | 6692 |
| 2078                 | 6062 | 7192 | 6695 | 6700 | 6694 | 6701 | 6692 | 6692 | 6692 |
| 2079                 | 6062 | 7192 | 6695 | 6700 | 6694 | 6701 | 6692 | 6692 | 6692 |
| 2080                 | 6062 | 7192 | 6695 | 6700 | 6694 | 6701 | 6692 | 6692 | 6692 |
| 2081                 | 6062 | 7192 | 6695 | 6700 | 6694 | 6701 | 6692 | 6692 | 6692 |
| 2082                 | 6062 | 7192 | 6695 | 6700 | 6694 | 6701 | 6692 | 6692 | 6692 |
| 2083                 | 6062 | 7192 | 6695 | 6700 | 6694 | 6701 | 6692 | 6692 | 6692 |
| 2084                 | 6062 | 7192 | 6695 | 6700 | 6694 | 6701 | 6692 | 6692 | 6692 |
| 2085                 | 6062 | 7192 | 6695 | 6700 | 6694 | 6701 | 6692 | 6692 | 6692 |
| 2086                 | 6062 | 7192 | 6695 | 6700 | 6694 | 6701 | 6692 | 6692 | 6692 |
| 2087                 | 6062 | 7192 | 6695 | 6700 | 6694 | 6701 | 6692 | 6692 | 6692 |
| 2088                 | 6062 | 7192 | 6695 | 6700 | 6694 | 6701 | 6692 | 6692 | 6692 |
| 2089                 | 6062 | 7192 | 6695 | 6700 | 6694 | 6701 | 6692 | 6692 | 6692 |
| 2090                 | 6062 | 7192 | 6695 | 6700 | 6694 | 6701 | 6692 | 6692 | 6692 |

| ScenarioID /<br>Year | 10   | 11   | 12   | 13   | 14   | 15   | 16   | 17   | 18   |
|----------------------|------|------|------|------|------|------|------|------|------|
| 2002                 | 0    | 0    | 0    | 0    | 0    | 0    | 0    | 0    | 0    |
| 2003                 | 0    | 0    | 0    | 0    | 0    | 0    | 0    | 0    | 0    |
| 2004                 | 0    | 0    | 0    | 0    | 0    | 0    | 0    | 0    | 0    |
| 2005                 | 0    | 0    | 0    | 0    | 0    | 0    | 0    | 0    | 0    |
| 2006                 | 0    | 0    | 0    | 0    | 0    | 0    | 0    | 0    | 0    |
| 2007                 | 0    | 0    | 0    | 0    | 0    | 0    | 0    | 0    | 0    |
| 2008                 | 0    | 0    | 0    | 0    | 0    | 0    | 0    | 0    | 0    |
| 2009                 | 0    | 0    | 0    | 0    | 0    | 0    | 0    | 0    | 0    |
| 2010                 | 0    | 0    | 0    | 0    | 0    | 0    | 0    | 0    | 0    |
| 2011                 | 0    | 0    | 0    | 0    | 0    | 0    | 0    | 0    | 0    |
| 2012                 | 0    | 0    | 0    | 0    | 0    | 0    | 0    | 0    | 0    |
| 2013                 | 0    | 0    | 0    | 0    | 0    | 0    | 0    | 0    | 0    |
| 2014                 | 0    | 0    | 0    | 0    | 0    | 0    | 0    | 0    | 0    |
| 2015                 | 0    | 0    | 0    | 0    | 0    | 0    | 0    | 0    | 0    |
| 2016                 | 0    | 0    | 0    | 0    | 0    | 0    | 0    | 0    | 0    |
| 2017                 | 0    | 0    | 0    | 0    | 0    | 0    | 0    | 0    | 0    |
| 2018                 | 0    | 0    | 0    | 0    | 0    | 0    | 0    | 0    | 0    |
| 2019                 | 0    | 0    | 0    | 0    | 0    | 0    | 0    | 0    | 0    |
| 2020                 | 0    | 0    | 0    | 230  | 0    | 0    | 0    | 0    | 0    |
| 2021                 | 0    | 0    | 0    | 471  | 0    | 0    | 0    | 0    | 0    |
| 2022                 | 0    | 0    | 0    | 772  | 0    | 0    | 0    | 0    | 0    |
| 2023                 | 0    | 0    | 0    | 1145 | 0    | 0    | 0    | 0    | 0    |
| 2024                 | 0    | 0    | 0    | 1459 | 0    | 0    | 0    | 0    | 0    |
| 2025                 | 215  | 215  | 0    | 1839 | 210  | 313  | 395  | 81   | 215  |
| 2026                 | 478  | 478  | 0    | 2169 | 440  | 642  | 780  | 177  | 478  |
| 2027                 | 751  | 758  | 0    | 2520 | 714  | 1017 | 1157 | 302  | 756  |
| 2028                 | 1081 | 1086 | 0    | 2903 | 1002 | 1382 | 1545 | 420  | 1086 |
| 2029                 | 1414 | 1427 | 0    | 3279 | 1308 | 1709 | 1909 | 542  | 1420 |
| 2030                 | 1772 | 1789 | 232  | 3687 | 1621 | 2039 | 2290 | 698  | 1782 |
| 2031                 | 2168 | 2185 | 493  | 4034 | 1978 | 2408 | 2670 | 918  | 2178 |
| 2032                 | 2519 | 2546 | 794  | 4370 | 2321 | 2784 | 3037 | 1110 | 2534 |
| 2033                 | 2922 | 2940 | 1101 | 4722 | 2723 | 3180 | 3430 | 1372 | 2934 |
| 2034                 | 3256 | 3274 | 1399 | 5095 | 3061 | 3544 | 3789 | 1613 | 3269 |
| 2035                 | 3685 | 3704 | 1825 | 5460 | 3484 | 3909 | 4169 | 1887 | 3697 |
| 2036                 | 4035 | 4067 | 2132 | 5766 | 3822 | 4265 | 4503 | 2210 | 4058 |
| 2037                 | 4383 | 4411 | 2497 | 5967 | 4182 | 4622 | 4849 | 2506 | 4404 |
| 2038                 | 4699 | 4723 | 2819 | 6124 | 4471 | 4968 | 5167 | 2789 | 4719 |
| 2039                 | 4892 | 4945 | 3165 | 6331 | 4649 | 5184 | 5353 | 3058 | 4946 |
| 2040                 | 5153 | 5244 | 3535 | 6438 | 4971 | 5478 | 5565 | 3489 | 5234 |
| 2041                 | 5450 | 5589 | 3879 | 6485 | 5354 | 5794 | 5840 | 4037 | 5553 |
| 2042                 | 5644 | 5899 | 4042 | 6516 | 5663 | 6051 | 6070 | 4501 | 5835 |
| 2043                 | 5796 | 6162 | 4363 | 6562 | 5915 | 6261 | 6286 | 4874 | 6091 |
| 2044                 | 5884 | 6404 | 4699 | 6582 | 6123 | 6446 | 6438 | 5179 | 6274 |
| 2045                 | 5913 | 6606 | 5008 | 6605 | 6272 | 6566 | 6557 | 5444 | 6409 |
| 2046                 | 5936 | 6806 | 5340 | 6614 | 6386 | 6633 | 6632 | 5634 | 6506 |
| 2047                 | 5966 | 6944 | 5630 | 6625 | 6467 | 6669 | 6678 | 5793 | 6584 |
| 2048                 | 5978 | 7022 | 5874 | 6643 | 6527 | 6691 | 6697 | 5945 | 6615 |
| 2049                 | 5990 | 7082 | 6063 | 6648 | 6560 | 6691 | 6697 | 6065 | 6628 |
| 2050                 | 6003 | 7125 | 6247 | 6667 | 6583 | 6691 | 6697 | 6145 | 6643 |
| 2051                 | 6009 | 7144 | 6398 | 6671 | 6597 | 6691 | 6697 | 6230 | 6652 |

| ScenarioID /<br>Year | 10   | 11   | 12   | 13   | 14   | 15   | 16   | 17   | 18   |
|----------------------|------|------|------|------|------|------|------|------|------|
| 2052                 | 6023 | 7164 | 6542 | 6686 | 6612 | 6691 | 6697 | 6297 | 6672 |
| 2053                 | 6031 | 7172 | 6624 | 6687 | 6627 | 6691 | 6697 | 6351 | 6680 |
| 2054                 | 6044 | 7183 | 6668 | 6687 | 6648 | 6691 | 6697 | 6419 | 6691 |
| 2055                 | 6051 | 7188 | 6675 | 6687 | 6661 | 6691 | 6697 | 6473 | 6696 |
| 2056                 | 6052 | 7189 | 6683 | 6687 | 6672 | 6691 | 6697 | 6499 | 6697 |
| 2057                 | 6052 | 7189 | 6687 | 6687 | 6683 | 6691 | 6697 | 6539 | 6697 |
| 2058                 | 6052 | 7189 | 6688 | 6687 | 6685 | 6691 | 6697 | 6561 | 6697 |
| 2059                 | 6052 | 7189 | 6688 | 6687 | 6688 | 6691 | 6697 | 6593 | 6697 |
| 2060                 | 6052 | 7189 | 6688 | 6687 | 6689 | 6691 | 6697 | 6608 | 6697 |
| 2061                 | 6052 | 7189 | 6688 | 6687 | 6689 | 6691 | 6697 | 6621 | 6697 |
| 2062                 | 6052 | 7189 | 6688 | 6687 | 6689 | 6691 | 6697 | 6635 | 6697 |
| 2063                 | 6052 | 7189 | 6688 | 6687 | 6689 | 6691 | 6697 | 6645 | 6697 |
| 2064                 | 6052 | 7189 | 6688 | 6687 | 6689 | 6691 | 6697 | 6653 | 6697 |
| 2065                 | 6052 | 7189 | 6688 | 6687 | 6689 | 6691 | 6697 | 6674 | 6697 |
| 2066                 | 6052 | 7189 | 6688 | 6687 | 6689 | 6691 | 6697 | 6683 | 6697 |
| 2067                 | 6052 | 7189 | 6688 | 6687 | 6689 | 6691 | 6697 | 6693 | 6697 |
| 2068                 | 6052 | 7189 | 6688 | 6687 | 6689 | 6691 | 6697 | 6696 | 6697 |
| 2069                 | 6052 | 7189 | 6688 | 6687 | 6689 | 6691 | 6697 | 6697 | 6697 |
| 2070                 | 6052 | 7189 | 6688 | 6687 | 6689 | 6691 | 6697 | 6697 | 6697 |
| 2071                 | 6052 | 7189 | 6688 | 6687 | 6689 | 6691 | 6697 | 6697 | 6697 |
| 2072                 | 6052 | 7189 | 6688 | 6687 | 6689 | 6691 | 6697 | 6697 | 6697 |
| 2073                 | 6052 | 7189 | 6688 | 6687 | 6689 | 6691 | 6697 | 6697 | 6697 |
| 2074                 | 6052 | 7189 | 6688 | 6687 | 6689 | 6691 | 6697 | 6697 | 6697 |
| 2075                 | 6052 | 7189 | 6688 | 6687 | 6689 | 6691 | 6697 | 6697 | 6697 |
| 2076                 | 6052 | 7189 | 6688 | 6687 | 6689 | 6691 | 6697 | 6697 | 6697 |
| 2077                 | 6052 | 7189 | 6688 | 6687 | 6689 | 6691 | 6697 | 6697 | 6697 |
| 2078                 | 6052 | 7189 | 6688 | 6687 | 6689 | 6691 | 6697 | 6697 | 6697 |
| 2079                 | 6052 | 7189 | 6688 | 6687 | 6689 | 6691 | 6697 | 6697 | 6697 |
| 2080                 | 6052 | 7189 | 6688 | 6687 | 6689 | 6691 | 6697 | 6697 | 6697 |
| 2081                 | 6052 | 7189 | 6688 | 6687 | 6689 | 6691 | 6697 | 6697 | 6697 |
| 2082                 | 6052 | 7189 | 6688 | 6687 | 6689 | 6691 | 6697 | 6697 | 6697 |
| 2083                 | 6052 | 7189 | 6688 | 6687 | 6689 | 6691 | 6697 | 6697 | 6697 |
| 2084                 | 6052 | 7189 | 6688 | 6687 | 6689 | 6691 | 6697 | 6697 | 6697 |
| 2085                 | 6052 | 7189 | 6688 | 6687 | 6689 | 6691 | 6697 | 6697 | 6697 |
| 2086                 | 6052 | 7189 | 6688 | 6687 | 6689 | 6691 | 6697 | 6697 | 6697 |
| 2087                 | 6052 | 7189 | 6688 | 6687 | 6689 | 6691 | 6697 | 6697 | 6697 |
| 2088                 | 6052 | 7189 | 6688 | 6687 | 6689 | 6691 | 6697 | 6697 | 6697 |
| 2089                 | 6052 | 7189 | 6688 | 6687 | 6689 | 6691 | 6697 | 6697 | 6697 |
| 2090                 | 6052 | 7189 | 6688 | 6687 | 6689 | 6691 | 6697 | 6697 | 6697 |

| ScenarioID /<br>Year | 19   | 20   | 21   | 22   | 23   | 24   | 25   | 26   | 27   |
|----------------------|------|------|------|------|------|------|------|------|------|
| 2002                 | 0    | 0    | 0    | 0    | 0    | 0    | 0    | 0    | 0    |
| 2003                 | 0    | 0    | 0    | 0    | 0    | 0    | 0    | 0    | 0    |
| 2004                 | 0    | 0    | 0    | 0    | 0    | 0    | 0    | 0    | 0    |
| 2005                 | 0    | 0    | 0    | 0    | 0    | 0    | 0    | 0    | 0    |
| 2006                 | 0    | 0    | 0    | 0    | 0    | 0    | 0    | 0    | 0    |
| 2007                 | 0    | 0    | 0    | 0    | 0    | 0    | 0    | 0    | 0    |
| 2008                 | 0    | 0    | 0    | 0    | 0    | 0    | 0    | 0    | 0    |
| 2009                 | 0    | 0    | 0    | 0    | 0    | 0    | 0    | 0    | 0    |
| 2010                 | 0    | 0    | 0    | 0    | 0    | 0    | 0    | 0    | 0    |
| 2011                 | 0    | 0    | 0    | 0    | 0    | 0    | 0    | 0    | 0    |
| 2012                 | 0    | 0    | 0    | 0    | 0    | 0    | 0    | 0    | 0    |
| 2013                 | 0    | 0    | 0    | 0    | 0    | 0    | 0    | 0    | 0    |
| 2014                 | 0    | 0    | 0    | 0    | 0    | 0    | 0    | 0    | 0    |
| 2015                 | 0    | 0    | 0    | 0    | 0    | 0    | 0    | 0    | 0    |
| 2016                 | 0    | 0    | 0    | 0    | 0    | 0    | 0    | 0    | 0    |
| 2017                 | 0    | 0    | 0    | 0    | 0    | 0    | 0    | 0    | 0    |
| 2018                 | 0    | 0    | 0    | 0    | 0    | 0    | 0    | 0    | 0    |
| 2019                 | 0    | 0    | 0    | 0    | 0    | 0    | 0    | 0    | 0    |
| 2020                 | 0    | 0    | 0    | 101  | 0    | 0    | 0    | 0    | 0    |
| 2021                 | 0    | 0    | 0    | 200  | 0    | 0    | 0    | 0    | 0    |
| 2022                 | 0    | 0    | 0    | 364  | 0    | 0    | 0    | 0    | 0    |
| 2023                 | 0    | 0    | 0    | 561  | 0    | 0    | 0    | 0    | 0    |
| 2024                 | 0    | 0    | 0    | 775  | 0    | 0    | 0    | 0    | 0    |
| 2025                 | 68   | 68   | 0    | 985  | 55   | 160  | 205  | 47   | 68   |
| 2026                 | 202  | 202  | 0    | 1255 | 151  | 378  | 497  | 93   | 202  |
| 2027                 | 385  | 388  | 0    | 1575 | 301  | 616  | 838  | 139  | 385  |
| 2028                 | 549  | 557  | 0    | 1950 | 453  | 904  | 1207 | 198  | 552  |
| 2029                 | 760  | 777  | 0    | 2295 | 623  | 1258 | 1554 | 246  | 770  |
| 2030                 | 1002 | 1024 | 78   | 2685 | 896  | 1603 | 1912 | 297  | 1016 |
| 2031                 | 1255 | 1278 | 189  | 3058 | 1109 | 1969 | 2348 | 378  | 1267 |
| 2032                 | 1585 | 1605 | 352  | 3476 | 1316 | 2362 | 2729 | 463  | 1598 |
| 2033                 | 1916 | 1929 | 562  | 3827 | 1590 | 2719 | 3118 | 565  | 1925 |
| 2034                 | 2326 | 2352 | 820  | 4217 | 1896 | 3051 | 3449 | 709  | 2339 |
| 2035                 | 2706 | 2727 | 1033 | 4654 | 2210 | 3444 | 3871 | 875  | 2713 |
| 2036                 | 3101 | 3124 | 1338 | 5038 | 2625 | 3813 | 4213 | 1091 | 3106 |
| 2037                 | 3523 | 3541 | 1617 | 5299 | 3009 | 4187 | 4586 | 1302 | 3529 |
| 2038                 | 3863 | 3879 | 1940 | 5678 | 3361 | 4536 | 4920 | 1509 | 3864 |
| 2039                 | 4151 | 4192 | 2320 | 6045 | 3672 | 4824 | 5116 | 1752 | 4172 |
| 2040                 | 4593 | 4668 | 2735 | 6253 | 4200 | 5207 | 5425 | 2197 | 4642 |
| 2041                 | 5030 | 5146 | 3132 | 6376 | 4697 | 5582 | 5735 | 2634 | 5098 |
| 2042                 | 5306 | 5543 | 3571 | 6435 | 5164 | 5919 | 6020 | 3077 | 5474 |
| 2043                 | 5535 | 5868 | 4092 | 6494 | 5480 | 6171 | 6210 | 3528 | 5772 |
| 2044                 | 5688 | 6174 | 4471 | 6541 | 5781 | 6377 | 6386 | 3996 | 6042 |
| 2045                 | 5806 | 6434 | 4852 | 6608 | 6047 | 6544 | 6521 | 4397 | 6272 |
| 2046                 | 5860 | 6656 | 5206 | 6633 | 6237 | 6623 | 6612 | 4755 | 6416 |
| 2047                 | 5915 | 6865 | 5531 | 6662 | 6383 | 6665 | 6664 | 5037 | 6524 |
| 2048                 | 5993 | 7032 | 5793 | 6676 | 6457 | 6687 | 6686 | 5271 | 6624 |
| 2049                 | 6025 | 7126 | 6046 | 6678 | 6493 | 6687 | 6686 | 5464 | 6658 |
| 2050                 | 6040 | 7178 | 6277 | 6687 | 6551 | 6687 | 6686 | 5666 | 6678 |
| 2051                 | 6043 | 7199 | 6460 | 6691 | 6599 | 6687 | 6686 | 5820 | 6681 |



| ScenarioID /<br>Year | 19   | 20   | 21   | 22   | 23   | 24   | 25   | 26   | 27   |
|----------------------|------|------|------|------|------|------|------|------|------|
| 2052                 | 6048 | 7204 | 6588 | 6699 | 6643 | 6687 | 6686 | 5939 | 6686 |
| 2053                 | 6049 | 7204 | 6653 | 6699 | 6666 | 6687 | 6686 | 6081 | 6686 |
| 2054                 | 6050 | 7204 | 6681 | 6699 | 6675 | 6687 | 6686 | 6179 | 6686 |
| 2055                 | 6051 | 7204 | 6689 | 6699 | 6683 | 6687 | 6686 | 6272 | 6686 |
| 2056                 | 6051 | 7204 | 6690 | 6699 | 6687 | 6687 | 6686 | 6339 | 6686 |
| 2057                 | 6051 | 7204 | 6690 | 6699 | 6688 | 6687 | 6686 | 6428 | 6686 |
| 2058                 | 6051 | 7204 | 6690 | 6699 | 6688 | 6687 | 6686 | 6484 | 6686 |
| 2059                 | 6051 | 7204 | 6690 | 6699 | 6689 | 6687 | 6686 | 6544 | 6686 |
| 2060                 | 6051 | 7204 | 6690 | 6699 | 6689 | 6687 | 6686 | 6615 | 6686 |
| 2061                 | 6051 | 7204 | 6690 | 6699 | 6689 | 6687 | 6686 | 6646 | 6686 |
| 2062                 | 6051 | 7204 | 6690 | 6699 | 6689 | 6687 | 6686 | 6667 | 6686 |
| 2063                 | 6051 | 7204 | 6690 | 6699 | 6689 | 6687 | 6686 | 6679 | 6686 |
| 2064                 | 6051 | 7204 | 6690 | 6699 | 6689 | 6687 | 6686 | 6681 | 6686 |
| 2065                 | 6051 | 7204 | 6690 | 6699 | 6689 | 6687 | 6686 | 6686 | 6686 |
| 2066                 | 6051 | 7204 | 6690 | 6699 | 6689 | 6687 | 6686 | 6686 | 6686 |
| 2067                 | 6051 | 7204 | 6690 | 6699 | 6689 | 6687 | 6686 | 6686 | 6686 |
| 2068                 | 6051 | 7204 | 6690 | 6699 | 6689 | 6687 | 6686 | 6686 | 6686 |
| 2069                 | 6051 | 7204 | 6690 | 6699 | 6689 | 6687 | 6686 | 6686 | 6686 |
| 2070                 | 6051 | 7204 | 6690 | 6699 | 6689 | 6687 | 6686 | 6686 | 6686 |
| 2071                 | 6051 | 7204 | 6690 | 6699 | 6689 | 6687 | 6686 | 6686 | 6686 |
| 2072                 | 6051 | 7204 | 6690 | 6699 | 6689 | 6687 | 6686 | 6686 | 6686 |
| 2073                 | 6051 | 7204 | 6690 | 6699 | 6689 | 6687 | 6686 | 6686 | 6686 |
| 2074                 | 6051 | 7204 | 6690 | 6699 | 6689 | 6687 | 6686 | 6686 | 6686 |
| 2075                 | 6051 | 7204 | 6690 | 6699 | 6689 | 6687 | 6686 | 6686 | 6686 |
| 2076                 | 6051 | 7204 | 6690 | 6699 | 6689 | 6687 | 6686 | 6686 | 6686 |
| 2077                 | 6051 | 7204 | 6690 | 6699 | 6689 | 6687 | 6686 | 6686 | 6686 |
| 2078                 | 6051 | 7204 | 6690 | 6699 | 6689 | 6687 | 6686 | 6686 | 6686 |
| 2079                 | 6051 | 7204 | 6690 | 6699 | 6689 | 6687 | 6686 | 6686 | 6686 |
| 2080                 | 6051 | 7204 | 6690 | 6699 | 6689 | 6687 | 6686 | 6686 | 6686 |
| 2081                 | 6051 | 7204 | 6690 | 6699 | 6689 | 6687 | 6686 | 6686 | 6686 |
| 2082                 | 6051 | 7204 | 6690 | 6699 | 6689 | 6687 | 6686 | 6686 | 6686 |
| 2083                 | 6051 | 7204 | 6690 | 6699 | 6689 | 6687 | 6686 | 6686 | 6686 |
| 2084                 | 6051 | 7204 | 6690 | 6699 | 6689 | 6687 | 6686 | 6686 | 6686 |
| 2085                 | 6051 | 7204 | 6690 | 6699 | 6689 | 6687 | 6686 | 6686 | 6686 |
| 2086                 | 6051 | 7204 | 6690 | 6699 | 6689 | 6687 | 6686 | 6686 | 6686 |
| 2087                 | 6051 | 7204 | 6690 | 6699 | 6689 | 6687 | 6686 | 6686 | 6686 |
| 2088                 | 6051 | 7204 | 6690 | 6699 | 6689 | 6687 | 6686 | 6686 | 6686 |
| 2089                 | 6051 | 7204 | 6690 | 6699 | 6689 | 6687 | 6686 | 6686 | 6686 |
| 2090                 | 6051 | 7204 | 6690 | 6699 | 6689 | 6687 | 6686 | 6686 | 6686 |

| ScenarioID /<br>Year | 28   | 29    | 30   | 31    | 32   | 33   | 34    | 35   | 36   |
|----------------------|------|-------|------|-------|------|------|-------|------|------|
| 2002                 | 0    | 0     | 0    | 0     | 0    | 0    | 0     | 0    | 0    |
| 2003                 | 0    | 0     | 0    | 0     | 0    | 0    | 0     | 0    | 0    |
| 2004                 | 0    | 0     | 0    | 0     | 0    | 0    | 0     | 0    | 0    |
| 2005                 | 0    | 0     | 0    | 0     | 0    | 0    | 0     | 0    | 0    |
| 2006                 | 0    | 0     | 0    | 0     | 0    | 0    | 0     | 0    | 0    |
| 2007                 | 0    | 0     | 0    | 0     | 0    | 0    | 0     | 0    | 0    |
| 2008                 | 0    | 0     | 0    | 0     | 0    | 0    | 0     | 0    | 0    |
| 2009                 | 0    | 0     | 0    | 0     | 0    | 0    | 0     | 0    | 0    |
| 2010                 | 0    | 0     | 0    | 0     | 0    | 0    | 0     | 0    | 0    |
| 2011                 | 0    | 0     | 0    | 0     | 0    | 0    | 0     | 0    | 0    |
| 2012                 | 0    | 0     | 0    | 0     | 0    | 0    | 0     | 0    | 0    |
| 2013                 | 0    | 0     | 0    | 0     | 0    | 0    | 0     | 0    | 0    |
| 2014                 | 0    | 0     | 0    | 0     | 0    | 0    | 0     | 0    | 0    |
| 2015                 | 0    | 0     | 0    | 0     | 0    | 0    | 0     | 0    | 0    |
| 2016                 | 0    | 0     | 0    | 0     | 0    | 0    | 0     | 0    | 0    |
| 2017                 | 0    | 0     | 0    | 0     | 0    | 0    | 0     | 0    | 0    |
| 2018                 | 0    | 0     | 0    | 0     | 0    | 0    | 0     | 0    | 0    |
| 2019                 | 0    | 0     | 0    | 0     | 0    | 0    | 0     | 0    | 0    |
| 2020                 | 0    | 0     | 0    | 427   | 0    | 0    | 0     | 0    | 0    |
| 2021                 | 0    | 0     | 0    | 850   | 0    | 0    | 0     | 0    | 0    |
| 2022                 | 0    | 0     | 0    | 1251  | 0    | 0    | 0     | 0    | 0    |
| 2023                 | 0    | 0     | 0    | 1670  | 0    | 0    | 0     | 0    | 0    |
| 2024                 | 0    | 0     | 0    | 2086  | 0    | 0    | 0     | 0    | 0    |
| 2025                 | 461  | 461   | 0    | 2488  | 454  | 483  | 466   | 427  | 461  |
| 2026                 | 890  | 890   | 0    | 2911  | 878  | 930  | 898   | 824  | 890  |
| 2027                 | 1323 | 1323  | 0    | 3319  | 1302 | 1379 | 1333  | 1229 | 1323 |
| 2028                 | 1748 | 1748  | 0    | 3717  | 1720 | 1813 | 1758  | 1636 | 1748 |
| 2029                 | 2145 | 2150  | 0    | 4083  | 2113 | 2223 | 2163  | 2018 | 2150 |
| 2030                 | 2565 | 2573  | 476  | 4419  | 2529 | 2664 | 2588  | 2406 | 2573 |
| 2031                 | 2991 | 3012  | 923  | 4737  | 2943 | 3100 | 3030  | 2800 | 3012 |
| 2032                 | 3409 | 3459  | 1359 | 5068  | 3345 | 3532 | 3470  | 3142 | 3449 |
| 2033                 | 3800 | 3868  | 1795 | 5364  | 3727 | 3926 | 3871  | 3469 | 3848 |
| 2034                 | 4209 | 4280  | 2273 | 5674  | 4119 | 4356 | 4314  | 3801 | 4245 |
| 2035                 | 4565 | 4663  | 2710 | 5974  | 4464 | 4689 | 4713  | 4114 | 4632 |
| 2036                 | 4942 | 4993  | 3148 | 6295  | 4779 | 5054 | 5070  | 4402 | 4953 |
| 2037                 | 5259 | 5327  | 3576 | 6577  | 5106 | 5405 | 5435  | 4690 | 5286 |
| 2038                 | 5572 | 5652  | 3983 | 6858  | 5420 | 5742 | 5777  | 5029 | 5620 |
| 2039                 | 5893 | 5992  | 4384 | 7160  | 5716 | 6096 | 6107  | 5320 | 5951 |
| 2040                 | 6214 | 6332  | 4767 | 7464  | 6037 | 6423 | 6452  | 5597 | 6278 |
| 2041                 | 6581 | 6702  | 5141 | 7805  | 6366 | 6774 | 6825  | 5966 | 6670 |
| 2042                 | 6931 | 7102  | 5552 | 8141  | 6673 | 7177 | 7193  | 6309 | 7021 |
| 2043                 | 7268 | 7485  | 5933 | 8462  | 7027 | 7527 | 7539  | 6651 | 7367 |
| 2044                 | 7580 | 7833  | 6292 | 8775  | 7316 | 7861 | 7875  | 6920 | 7702 |
| 2045                 | 7914 | 8173  | 6629 | 9088  | 7626 | 8208 | 8209  | 7167 | 8033 |
| 2046                 | 8219 | 8474  | 6975 | 9382  | 7887 | 8517 | 8526  | 7318 | 8342 |
| 2047                 | 8523 | 8785  | 7292 | 9680  | 8161 | 8823 | 8822  | 7551 | 8647 |
| 2048                 | 8829 | 9092  | 7572 | 9940  | 8416 | 9107 | 9141  | 7798 | 8960 |
| 2049                 | 9114 | 9427  | 7834 | 10167 | 8688 | 9389 | 9471  | 8057 | 9282 |
| 2050                 | 9409 | 9761  | 8116 | 10408 | 8988 | 9684 | 9765  | 8295 | 9598 |
| 2051                 | 9685 | 10085 | 8429 | 10683 | 9291 | 9980 | 10068 | 8520 | 9901 |

| ScenarioID /<br>Year | 28    | 29    | 30    | 31    | 32    | 33    | 34    | 35    | 36    |
|----------------------|-------|-------|-------|-------|-------|-------|-------|-------|-------|
| 2052                 | 9980  | 10424 | 8765  | 10917 | 9612  | 10266 | 10403 | 8679  | 10218 |
| 2053                 | 10303 | 10808 | 9142  | 11167 | 9959  | 10554 | 10764 | 8964  | 10562 |
| 2054                 | 10591 | 11154 | 9541  | 11375 | 10301 | 10837 | 11109 | 9228  | 10900 |
| 2055                 | 10805 | 11466 | 9949  | 11586 | 10661 | 11131 | 11449 | 9497  | 11184 |
| 2056                 | 11017 | 11740 | 10341 | 11799 | 10994 | 11378 | 11781 | 9700  | 11429 |
| 2057                 | 11221 | 11983 | 10730 | 11964 | 11260 | 11588 | 12116 | 9914  | 11660 |
| 2058                 | 11422 | 12247 | 11062 | 12124 | 11553 | 11846 | 12385 | 10168 | 11909 |
| 2059                 | 11576 | 12495 | 11371 | 12257 | 11850 | 12082 | 12579 | 10424 | 12115 |
| 2060                 | 11685 | 12663 | 11662 | 12362 | 12074 | 12236 | 12707 | 10594 | 12232 |
| 2061                 | 11776 | 12805 | 11898 | 12454 | 12258 | 12349 | 12828 | 10780 | 12342 |
| 2062                 | 11881 | 12929 | 12119 | 12556 | 12423 | 12475 | 12925 | 10986 | 12463 |
| 2063                 | 11949 | 13021 | 12301 | 12632 | 12515 | 12552 | 13022 | 11146 | 12545 |
| 2064                 | 12044 | 13129 | 12464 | 12735 | 12623 | 12654 | 13085 | 11267 | 12642 |
| 2065                 | 12135 | 13222 | 12574 | 12814 | 12702 | 12740 | 13156 | 11443 | 12726 |
| 2066                 | 12241 | 13319 | 12679 | 12890 | 12789 | 12835 | 13207 | 11574 | 12830 |
| 2067                 | 12323 | 13414 | 12767 | 12962 | 12894 | 12934 | 13258 | 11749 | 12931 |
| 2068                 | 12384 | 13503 | 12843 | 13020 | 12985 | 13015 | 13289 | 11881 | 13009 |
| 2069                 | 12444 | 13579 | 12933 | 13079 | 13068 | 13078 | 13307 | 12020 | 13079 |
| 2070                 | 12503 | 13639 | 13030 | 13138 | 13137 | 13137 | 13310 | 12140 | 13138 |
| 2071                 | 12537 | 13673 | 13103 | 13172 | 13172 | 13172 | 13312 | 12236 | 13172 |
| 2072                 | 12579 | 13715 | 13175 | 13214 | 13215 | 13214 | 13315 | 12334 | 13214 |
| 2073                 | 12616 | 13752 | 13234 | 13251 | 13251 | 13249 | 13315 | 12417 | 13251 |
| 2074                 | 12638 | 13774 | 13269 | 13273 | 13273 | 13271 | 13318 | 12498 | 13273 |
| 2075                 | 12651 | 13787 | 13284 | 13286 | 13286 | 13284 | 13320 | 12594 | 13286 |
| 2076                 | 12663 | 13799 | 13298 | 13298 | 13298 | 13297 | 13321 | 12658 | 13298 |
| 2077                 | 12668 | 13804 | 13303 | 13303 | 13304 | 13303 | 13322 | 12748 | 13303 |
| 2078                 | 12670 | 13806 | 13305 | 13305 | 13306 | 13305 | 13322 | 12822 | 13305 |
| 2079                 | 12675 | 13811 | 13310 | 13310 | 13310 | 13310 | 13322 | 12896 | 13310 |
| 2080                 | 12677 | 13813 | 13312 | 13312 | 13312 | 13312 | 13322 | 12964 | 13312 |
| 2081                 | 12678 | 13814 | 13313 | 13313 | 13313 | 13313 | 13322 | 13021 | 13313 |
| 2082                 | 12680 | 13816 | 13315 | 13315 | 13315 | 13315 | 13322 | 13082 | 13315 |
| 2083                 | 12682 | 13818 | 13317 | 13317 | 13317 | 13317 | 13322 | 13135 | 13317 |
| 2084                 | 12683 | 13819 | 13318 | 13318 | 13318 | 13318 | 13322 | 13172 | 13318 |
| 2085                 | 12685 | 13821 | 13320 | 13320 | 13320 | 13320 | 13322 | 13215 | 13320 |
| 2086                 | 12687 | 13823 | 13322 | 13322 | 13322 | 13322 | 13322 | 13249 | 13322 |
| 2087                 | 12687 | 13823 | 13322 | 13322 | 13322 | 13322 | 13322 | 13270 | 13322 |
| 2088                 | 12687 | 13823 | 13322 | 13322 | 13322 | 13322 | 13322 | 13285 | 13322 |
| 2089                 | 12687 | 13823 | 13322 | 13322 | 13322 | 13322 | 13322 | 13297 | 13322 |
| 2090                 | 12687 | 13823 | 13322 | 13322 | 13322 | 13322 | 13322 | 13303 | 13322 |

| ScenarioID /<br>Year | 37   | 38   | 39   | 40   | 41   | 42   | 43   | 44   | 45   |
|----------------------|------|------|------|------|------|------|------|------|------|
| 2002                 | 0    | 0    | 0    | 0    | 0    | 0    | 0    | 0    | 0    |
| 2003                 | 0    | 0    | 0    | 0    | 0    | 0    | 0    | 0    | 0    |
| 2004                 | 0    | 0    | 0    | 0    | 0    | 0    | 0    | 0    | 0    |
| 2005                 | 0    | 0    | 0    | 0    | 0    | 0    | 0    | 0    | 0    |
| 2006                 | 0    | 0    | 0    | 0    | 0    | 0    | 0    | 0    | 0    |
| 2007                 | 0    | 0    | 0    | 0    | 0    | 0    | 0    | 0    | 0    |
| 2008                 | 0    | 0    | 0    | 0    | 0    | 0    | 0    | 0    | 0    |
| 2009                 | 0    | 0    | 0    | 0    | 0    | 0    | 0    | 0    | 0    |
| 2010                 | 0    | 0    | 0    | 0    | 0    | 0    | 0    | 0    | 0    |
| 2011                 | 0    | 0    | 0    | 0    | 0    | 0    | 0    | 0    | 0    |
| 2012                 | 0    | 0    | 0    | 0    | 0    | 0    | 0    | 0    | 0    |
| 2013                 | 0    | 0    | 0    | 0    | 0    | 0    | 0    | 0    | 0    |
| 2014                 | 0    | 0    | 0    | 0    | 0    | 0    | 0    | 0    | 0    |
| 2015                 | 0    | 0    | 0    | 0    | 0    | 0    | 0    | 0    | 0    |
| 2016                 | 0    | 0    | 0    | 0    | 0    | 0    | 0    | 0    | 0    |
| 2017                 | 0    | 0    | 0    | 0    | 0    | 0    | 0    | 0    | 0    |
| 2018                 | 0    | 0    | 0    | 0    | 0    | 0    | 0    | 0    | 0    |
| 2019                 | 0    | 0    | 0    | 0    | 0    | 0    | 0    | 0    | 0    |
| 2020                 | 0    | 0    | 0    | 228  | 0    | 0    | 0    | 0    | 0    |
| 2021                 | 0    | 0    | 0    | 511  | 0    | 0    | 0    | 0    | 0    |
| 2022                 | 0    | 0    | 0    | 831  | 0    | 0    | 0    | 0    | 0    |
| 2023                 | 0    | 0    | 0    | 1272 | 0    | 0    | 0    | 0    | 0    |
| 2024                 | 0    | 0    | 0    | 1673 | 0    | 0    | 0    | 0    | 0    |
| 2025                 | 210  | 210  | 0    | 2061 | 207  | 337  | 430  | 72   | 210  |
| 2026                 | 481  | 481  | 0    | 2456 | 446  | 695  | 827  | 173  | 481  |
| 2027                 | 792  | 799  | 0    | 2809 | 750  | 1120 | 1245 | 303  | 797  |
| 2028                 | 1135 | 1149 | 0    | 3165 | 1028 | 1500 | 1652 | 454  | 1141 |
| 2029                 | 1544 | 1568 | 0    | 3580 | 1397 | 1887 | 2069 | 627  | 1549 |
| 2030                 | 1952 | 1970 | 235  | 3983 | 1746 | 2293 | 2500 | 828  | 1954 |
| 2031                 | 2385 | 2412 | 511  | 4380 | 2160 | 2670 | 2912 | 1100 | 2399 |
| 2032                 | 2721 | 2782 | 829  | 4755 | 2532 | 3063 | 3306 | 1299 | 2775 |
| 2033                 | 3192 | 3226 | 1159 | 5112 | 2993 | 3453 | 3684 | 1526 | 3212 |
| 2034                 | 3558 | 3601 | 1566 | 5449 | 3366 | 3848 | 4075 | 1740 | 3591 |
| 2035                 | 3929 | 3972 | 2011 | 5750 | 3795 | 4253 | 4478 | 1990 | 3975 |
| 2036                 | 4316 | 4365 | 2423 | 6022 | 4131 | 4609 | 4809 | 2262 | 4357 |
| 2037                 | 4679 | 4729 | 2873 | 6276 | 4477 | 4974 | 5123 | 2578 | 4712 |
| 2038                 | 4971 | 5051 | 3198 | 6480 | 4780 | 5344 | 5422 | 2897 | 5040 |
| 2039                 | 5263 | 5386 | 3561 | 6702 | 5063 | 5693 | 5727 | 3248 | 5349 |
| 2040                 | 5560 | 5725 | 3898 | 6927 | 5353 | 6012 | 6027 | 3615 | 5657 |
| 2041                 | 5850 | 6064 | 4257 | 7162 | 5641 | 6286 | 6338 | 3998 | 5982 |
| 2042                 | 6133 | 6374 | 4575 | 7413 | 5919 | 6606 | 6625 | 4342 | 6271 |
| 2043                 | 6399 | 6644 | 4911 | 7669 | 6157 | 6858 | 6919 | 4741 | 6540 |
| 2044                 | 6614 | 6914 | 5258 | 7866 | 6408 | 7133 | 7195 | 5156 | 6807 |
| 2045                 | 6824 | 7172 | 5593 | 8049 | 6702 | 7422 | 7458 | 5546 | 7054 |
| 2046                 | 7060 | 7431 | 5945 | 8206 | 6950 | 7671 | 7702 | 5916 | 7316 |
| 2047                 | 7263 | 7671 | 6263 | 8343 | 7220 | 7958 | 7966 | 6225 | 7546 |
| 2048                 | 7527 | 7922 | 6554 | 8539 | 7518 | 8213 | 8258 | 6499 | 7819 |
| 2049                 | 7759 | 8134 | 6778 | 8699 | 7764 | 8458 | 8530 | 6791 | 8056 |
| 2050                 | 8010 | 8353 | 6981 | 8860 | 8023 | 8707 | 8749 | 7034 | 8314 |
| 2051                 | 8217 | 8544 | 7154 | 8981 | 8291 | 8916 | 8941 | 7281 | 8529 |

| ScenarioID /<br>Year | 37    | 38    | 39    | 40    | 41    | 42    | 43    | 44    | 45    |
|----------------------|-------|-------|-------|-------|-------|-------|-------|-------|-------|
| 2052                 | 8423  | 8744  | 7363  | 9124  | 8486  | 9119  | 9163  | 7496  | 8731  |
| 2053                 | 8587  | 8962  | 7558  | 9287  | 8719  | 9311  | 9378  | 7758  | 8946  |
| 2054                 | 8768  | 9164  | 7758  | 9424  | 9007  | 9494  | 9594  | 7989  | 9142  |
| 2055                 | 8981  | 9393  | 7993  | 9651  | 9302  | 9682  | 9829  | 8226  | 9369  |
| 2056                 | 9205  | 9678  | 8271  | 9892  | 9608  | 9916  | 10089 | 8425  | 9614  |
| 2057                 | 9487  | 10003 | 8597  | 10186 | 9923  | 10221 | 10375 | 8754  | 9918  |
| 2058                 | 9809  | 10312 | 8944  | 10520 | 10220 | 10511 | 10684 | 9101  | 10225 |
| 2059                 | 10131 | 10637 | 9282  | 10886 | 10567 | 10823 | 10998 | 9486  | 10542 |
| 2060                 | 10487 | 11007 | 9641  | 11245 | 10961 | 11096 | 11339 | 9875  | 10924 |
| 2061                 | 10808 | 11366 | 9964  | 11563 | 11324 | 11412 | 11675 | 10285 | 11290 |
| 2062                 | 11107 | 11737 | 10334 | 11839 | 11634 | 11703 | 11952 | 10609 | 11613 |
| 2063                 | 11376 | 12060 | 10732 | 12118 | 11902 | 11981 | 12193 | 10935 | 11878 |
| 2064                 | 11627 | 12360 | 11141 | 12380 | 12142 | 12220 | 12416 | 11189 | 12143 |
| 2065                 | 11845 | 12623 | 11495 | 12586 | 12379 | 12426 | 12608 | 11452 | 12368 |
| 2066                 | 12031 | 12857 | 11798 | 12740 | 12570 | 12567 | 12774 | 11654 | 12576 |
| 2067                 | 12165 | 13064 | 12075 | 12845 | 12729 | 12705 | 12908 | 11835 | 12731 |
| 2068                 | 12266 | 13220 | 12307 | 12928 | 12852 | 12804 | 12987 | 11982 | 12833 |
| 2069                 | 12348 | 13322 | 12509 | 13023 | 12951 | 12910 | 13044 | 12097 | 12915 |
| 2070                 | 12423 | 13399 | 12667 | 13083 | 13029 | 13009 | 13102 | 12236 | 12989 |
| 2071                 | 12472 | 13459 | 12755 | 13129 | 13109 | 13070 | 13157 | 12364 | 13050 |
| 2072                 | 12530 | 13537 | 12845 | 13191 | 13171 | 13132 | 13204 | 12490 | 13123 |
| 2073                 | 12589 | 13617 | 12927 | 13248 | 13228 | 13209 | 13243 | 12599 | 13186 |
| 2074                 | 12632 | 13675 | 12998 | 13281 | 13272 | 13251 | 13272 | 12689 | 13233 |
| 2075                 | 12662 | 13729 | 13066 | 13302 | 13295 | 13274 | 13295 | 12783 | 13272 |
| 2076                 | 12678 | 13773 | 13134 | 13317 | 13309 | 13300 | 13310 | 12873 | 13301 |
| 2077                 | 12683 | 13796 | 13196 | 13320 | 13318 | 13304 | 13320 | 12951 | 13316 |
| 2078                 | 12684 | 13808 | 13238 | 13320 | 13318 | 13310 | 13322 | 13008 | 13319 |
| 2079                 | 12687 | 13821 | 13281 | 13322 | 13318 | 13314 | 13322 | 13067 | 13322 |
| 2080                 | 12687 | 13823 | 13306 | 13322 | 13322 | 13318 | 13322 | 13113 | 13322 |
| 2081                 | 12687 | 13823 | 13319 | 13322 | 13322 | 13319 | 13322 | 13145 | 13322 |
| 2082                 | 12687 | 13823 | 13322 | 13322 | 13322 | 13320 | 13322 | 13173 | 13322 |
| 2083                 | 12687 | 13823 | 13322 | 13322 | 13322 | 13322 | 13322 | 13196 | 13322 |
| 2084                 | 12687 | 13823 | 13322 | 13322 | 13322 | 13322 | 13322 | 13216 | 13322 |
| 2085                 | 12687 | 13823 | 13322 | 13322 | 13322 | 13322 | 13322 | 13243 | 13322 |
| 2086                 | 12687 | 13823 | 13322 | 13322 | 13322 | 13322 | 13322 | 13265 | 13322 |
| 2087                 | 12687 | 13823 | 13322 | 13322 | 13322 | 13322 | 13322 | 13280 | 13322 |
| 2088                 | 12687 | 13823 | 13322 | 13322 | 13322 | 13322 | 13322 | 13299 | 13322 |
| 2089                 | 12687 | 13823 | 13322 | 13322 | 13322 | 13322 | 13322 | 13312 | 13322 |
| 2090                 | 12687 | 13823 | 13322 | 13322 | 13322 | 13322 | 13322 | 13318 | 13322 |

| ScenarioID /<br>Year | 46   | 47   | 48   | 49    | 50   | 51   | 52   | 53   | 54   |
|----------------------|------|------|------|-------|------|------|------|------|------|
| 2002                 | 0    | 0    | 0    | 0     | 0    | 0    | 0    | 0    | 0    |
| 2003                 | 0    | 0    | 0    | 0     | 0    | 0    | 0    | 0    | 0    |
| 2004                 | 0    | 0    | 0    | 0     | 0    | 0    | 0    | 0    | 0    |
| 2005                 | 0    | 0    | 0    | 0     | 0    | 0    | 0    | 0    | 0    |
| 2006                 | 0    | 0    | 0    | 0     | 0    | 0    | 0    | 0    | 0    |
| 2007                 | 0    | 0    | 0    | 0     | 0    | 0    | 0    | 0    | 0    |
| 2008                 | 0    | 0    | 0    | 0     | 0    | 0    | 0    | 0    | 0    |
| 2009                 | 0    | 0    | 0    | 0     | 0    | 0    | 0    | 0    | 0    |
| 2010                 | 0    | 0    | 0    | 0     | 0    | 0    | 0    | 0    | 0    |
| 2011                 | 0    | 0    | 0    | 0     | 0    | 0    | 0    | 0    | 0    |
| 2012                 | 0    | 0    | 0    | 0     | 0    | 0    | 0    | 0    | 0    |
| 2013                 | 0    | 0    | 0    | 0     | 0    | 0    | 0    | 0    | 0    |
| 2014                 | 0    | 0    | 0    | 0     | 0    | 0    | 0    | 0    | 0    |
| 2015                 | 0    | 0    | 0    | 0     | 0    | 0    | 0    | 0    | 0    |
| 2016                 | 0    | 0    | 0    | 0     | 0    | 0    | 0    | 0    | 0    |
| 2017                 | 0    | 0    | 0    | 0     | 0    | 0    | 0    | 0    | 0    |
| 2018                 | 0    | 0    | 0    | 0     | 0    | 0    | 0    | 0    | 0    |
| 2019                 | 0    | 0    | 0    | 0     | 0    | 0    | 0    | 0    | 0    |
| 2020                 | 0    | 0    | 0    | 90    | 0    | 0    | 0    | 0    | 0    |
| 2021                 | 0    | 0    | 0    | 229   | 0    | 0    | 0    | 0    | 0    |
| 2022                 | 0    | 0    | 0    | 424   | 0    | 0    | 0    | 0    | 0    |
| 2023                 | 0    | 0    | 0    | 679   | 0    | 0    | 0    | 0    | 0    |
| 2024                 | 0    | 0    | 0    | 975   | 0    | 0    | 0    | 0    | 0    |
| 2025                 | 57   | 57   | 0    | 1258  | 47   | 159  | 223  | 11   | 57   |
| 2026                 | 225  | 225  | 0    | 1634  | 172  | 432  | 517  | 62   | 225  |
| 2027                 | 457  | 460  | 0    | 2007  | 361  | 716  | 951  | 126  | 457  |
| 2028                 | 666  | 680  | 0    | 2382  | 558  | 1087 | 1361 | 223  | 673  |
| 2029                 | 945  | 969  | 0    | 2737  | 808  | 1530 | 1776 | 360  | 960  |
| 2030                 | 1264 | 1304 | 81   | 3172  | 1122 | 1920 | 2197 | 528  | 1287 |
| 2031                 | 1562 | 1625 | 227  | 3493  | 1420 | 2274 | 2657 | 679  | 1607 |
| 2032                 | 1902 | 1992 | 464  | 3862  | 1689 | 2680 | 3061 | 820  | 1964 |
| 2033                 | 2274 | 2390 | 699  | 4282  | 1994 | 3046 | 3447 | 982  | 2351 |
| 2034                 | 2682 | 2794 | 1036 | 4699  | 2271 | 3398 | 3808 | 1168 | 2748 |
| 2035                 | 3053 | 3156 | 1323 | 5082  | 2554 | 3800 | 4233 | 1347 | 3115 |
| 2036                 | 3486 | 3568 | 1698 | 5521  | 2960 | 4204 | 4622 | 1574 | 3537 |
| 2037                 | 3905 | 3980 | 2050 | 5851  | 3376 | 4609 | 5042 | 1805 | 3964 |
| 2038                 | 4240 | 4333 | 2426 | 6191  | 3806 | 4972 | 5394 | 2085 | 4324 |
| 2039                 | 4614 | 4725 | 2846 | 6537  | 4153 | 5339 | 5726 | 2350 | 4710 |
| 2040                 | 5024 | 5122 | 3215 | 6887  | 4516 | 5729 | 6080 | 2597 | 5122 |
| 2041                 | 5438 | 5574 | 3703 | 7186  | 4882 | 6071 | 6433 | 2894 | 5550 |
| 2042                 | 5822 | 5962 | 4056 | 7535  | 5206 | 6503 | 6778 | 3192 | 5934 |
| 2043                 | 6187 | 6336 | 4459 | 7816  | 5551 | 6884 | 7136 | 3571 | 6299 |
| 2044                 | 6546 | 6735 | 4833 | 8085  | 5935 | 7201 | 7486 | 3978 | 6686 |
| 2045                 | 6925 | 7127 | 5248 | 8463  | 6336 | 7568 | 7783 | 4385 | 7086 |
| 2046                 | 7253 | 7499 | 5589 | 8776  | 6776 | 7884 | 8116 | 4809 | 7450 |
| 2047                 | 7593 | 7890 | 5981 | 9081  | 7172 | 8293 | 8410 | 5219 | 7782 |
| 2048                 | 7994 | 8296 | 6433 | 9354  | 7520 | 8573 | 8746 | 5655 | 8180 |
| 2049                 | 8307 | 8631 | 6767 | 9613  | 7838 | 8865 | 9003 | 6084 | 8490 |
| 2050                 | 8640 | 8998 | 7173 | 9832  | 8228 | 9190 | 9270 | 6573 | 8812 |
| 2051                 | 8980 | 9355 | 7525 | 10122 | 8638 | 9494 | 9526 | 7007 | 9156 |

| ScenarioID /<br>Year | 46    | 47    | 48    | 49    | 50    | 51    | 52    | 53    | 54    |
|----------------------|-------|-------|-------|-------|-------|-------|-------|-------|-------|
| 2052                 | 9277  | 9665  | 7857  | 10458 | 9026  | 9814  | 9829  | 7479  | 9449  |
| 2053                 | 9576  | 10006 | 8261  | 10709 | 9392  | 10138 | 10111 | 8016  | 9751  |
| 2054                 | 9885  | 10312 | 8640  | 10971 | 9769  | 10441 | 10428 | 8497  | 10052 |
| 2055                 | 10207 | 10655 | 8999  | 11247 | 10180 | 10719 | 10755 | 8957  | 10388 |
| 2056                 | 10547 | 10986 | 9369  | 11562 | 10555 | 11046 | 11099 | 9435  | 10736 |
| 2057                 | 10868 | 11345 | 9703  | 11839 | 10933 | 11397 | 11413 | 9881  | 11067 |
| 2058                 | 11149 | 11692 | 10057 | 12065 | 11294 | 11658 | 11733 | 10342 | 11393 |
| 2059                 | 11411 | 12028 | 10423 | 12208 | 11613 | 11872 | 12060 | 10774 | 11728 |
| 2060                 | 11673 | 12355 | 10843 | 12353 | 11930 | 12064 | 12316 | 11170 | 12025 |
| 2061                 | 11856 | 12639 | 11219 | 12485 | 12221 | 12255 | 12542 | 11487 | 12272 |
| 2062                 | 11982 | 12866 | 11581 | 12641 | 12452 | 12410 | 12700 | 11741 | 12455 |
| 2063                 | 12082 | 13027 | 11899 | 12757 | 12619 | 12525 | 12828 | 11918 | 12589 |
| 2064                 | 12192 | 13169 | 12160 | 12880 | 12714 | 12622 | 12924 | 12049 | 12697 |
| 2065                 | 12320 | 13290 | 12401 | 12979 | 12805 | 12736 | 13005 | 12188 | 12820 |
| 2066                 | 12399 | 13369 | 12586 | 13039 | 12879 | 12854 | 13069 | 12305 | 12906 |
| 2067                 | 12460 | 13451 | 12722 | 13100 | 12953 | 12940 | 13134 | 12418 | 12983 |
| 2068                 | 12510 | 13530 | 12809 | 13128 | 13032 | 13009 | 13190 | 12531 | 13062 |
| 2069                 | 12547 | 13592 | 12874 | 13154 | 13101 | 13072 | 13235 | 12609 | 13123 |
| 2070                 | 12579 | 13648 | 12937 | 13182 | 13160 | 13113 | 13267 | 12675 | 13180 |
| 2071                 | 12589 | 13683 | 13001 | 13197 | 13215 | 13133 | 13290 | 12745 | 13210 |
| 2072                 | 12605 | 13713 | 13072 | 13226 | 13246 | 13181 | 13312 | 12833 | 13247 |
| 2073                 | 12630 | 13751 | 13137 | 13255 | 13276 | 13229 | 13315 | 12889 | 13270 |
| 2074                 | 12649 | 13781 | 13199 | 13273 | 13295 | 13270 | 13317 | 12921 | 13281 |
| 2075                 | 12654 | 13790 | 13245 | 13292 | 13300 | 13288 | 13320 | 12968 | 13288 |
| 2076                 | 12669 | 13800 | 13283 | 13314 | 13308 | 13299 | 13320 | 12996 | 13299 |
| 2077                 | 12680 | 13806 | 13303 | 13319 | 13311 | 13300 | 13322 | 13040 | 13303 |
| 2078                 | 12684 | 13817 | 13307 | 13319 | 13311 | 13306 | 13322 | 13100 | 13307 |
| 2079                 | 12687 | 13822 | 13311 | 13322 | 13314 | 13307 | 13322 | 13123 | 13311 |
| 2080                 | 12687 | 13823 | 13314 | 13322 | 13316 | 13311 | 13322 | 13152 | 13313 |
| 2081                 | 12687 | 13823 | 13314 | 13322 | 13322 | 13312 | 13322 | 13175 | 13314 |
| 2082                 | 12687 | 13823 | 13315 | 13322 | 13322 | 13313 | 13322 | 13196 | 13315 |
| 2083                 | 12687 | 13823 | 13317 | 13322 | 13322 | 13316 | 13322 | 13221 | 13317 |
| 2084                 | 12687 | 13823 | 13318 | 13322 | 13322 | 13317 | 13322 | 13236 | 13318 |
| 2085                 | 12687 | 13823 | 13320 | 13322 | 13322 | 13322 | 13322 | 13250 | 13320 |
| 2086                 | 12687 | 13823 | 13322 | 13322 | 13322 | 13322 | 13322 | 13270 | 13322 |
| 2087                 | 12687 | 13823 | 13322 | 13322 | 13322 | 13322 | 13322 | 13281 | 13322 |
| 2088                 | 12687 | 13823 | 13322 | 13322 | 13322 | 13322 | 13322 | 13288 | 13322 |
| 2089                 | 12687 | 13823 | 13322 | 13322 | 13322 | 13322 | 13322 | 13299 | 13322 |
| 2090                 | 12687 | 13823 | 13322 | 13322 | 13322 | 13322 | 13322 | 13303 | 13322 |

| ScenarioID /<br>Year | 55   | 56   | 57   | 58   | 59   | 60   | 61   | 62   | 63   |
|----------------------|------|------|------|------|------|------|------|------|------|
| 2002                 | 0    | 0    | 0    | 0    | 0    | 0    | 0    | 0    | 0    |
| 2003                 | 0    | 0    | 0    | 0    | 0    | 0    | 0    | 0    | 0    |
| 2004                 | 0    | 0    | 0    | 0    | 0    | 0    | 0    | 0    | 0    |
| 2005                 | 0    | 0    | 0    | 0    | 0    | 0    | 0    | 0    | 0    |
| 2006                 | 0    | 0    | 0    | 0    | 0    | 0    | 0    | 0    | 0    |
| 2007                 | 0    | 0    | 0    | 0    | 0    | 0    | 0    | 0    | 0    |
| 2008                 | 0    | 0    | 0    | 0    | 0    | 0    | 0    | 0    | 0    |
| 2009                 | 0    | 0    | 0    | 0    | 0    | 0    | 0    | 0    | 0    |
| 2010                 | 0    | 0    | 0    | 0    | 0    | 0    | 0    | 0    | 0    |
| 2011                 | 0    | 0    | 0    | 0    | 0    | 0    | 0    | 0    | 0    |
| 2012                 | 0    | 0    | 0    | 0    | 0    | 0    | 0    | 0    | 0    |
| 2013                 | 0    | 0    | 0    | 0    | 0    | 0    | 0    | 0    | 0    |
| 2014                 | 0    | 0    | 0    | 0    | 0    | 0    | 0    | 0    | 0    |
| 2015                 | 0    | 0    | 0    | 0    | 0    | 0    | 0    | 0    | 0    |
| 2016                 | 0    | 0    | 0    | 0    | 0    | 0    | 0    | 0    | 0    |
| 2017                 | 0    | 0    | 0    | 0    | 0    | 0    | 0    | 0    | 0    |
| 2018                 | 0    | 0    | 0    | 0    | 0    | 0    | 0    | 0    | 0    |
| 2019                 | 0    | 0    | 0    | 0    | 0    | 0    | 0    | 0    | 0    |
| 2020                 | 0    | 0    | 0    | 333  | 0    | 0    | 0    | 0    | 0    |
| 2021                 | 0    | 0    | 0    | 644  | 0    | 0    | 0    | 0    | 0    |
| 2022                 | 0    | 0    | 0    | 950  | 0    | 0    | 0    | 0    | 0    |
| 2023                 | 0    | 0    | 0    | 1247 | 0    | 0    | 0    | 0    | 0    |
| 2024                 | 0    | 0    | 0    | 1537 | 0    | 0    | 0    | 0    | 0    |
| 2025                 | 342  | 342  | 0    | 1834 | 342  | 342  | 356  | 274  | 342  |
| 2026                 | 660  | 660  | 0    | 2138 | 663  | 673  | 673  | 538  | 660  |
| 2027                 | 978  | 978  | 0    | 2433 | 962  | 972  | 992  | 819  | 978  |
| 2028                 | 1258 | 1258 | 0    | 2713 | 1235 | 1249 | 1306 | 1060 | 1258 |
| 2029                 | 1580 | 1580 | 0    | 3023 | 1551 | 1571 | 1617 | 1347 | 1580 |
| 2030                 | 1873 | 1871 | 350  | 3306 | 1831 | 1865 | 1926 | 1602 | 1871 |
| 2031                 | 2170 | 2167 | 667  | 3595 | 2124 | 2141 | 2233 | 1861 | 2167 |
| 2032                 | 2453 | 2451 | 987  | 3885 | 2429 | 2477 | 2531 | 2107 | 2451 |
| 2033                 | 2745 | 2753 | 1286 | 4182 | 2711 | 2792 | 2844 | 2404 | 2749 |
| 2034                 | 3029 | 3025 | 1561 | 4451 | 2991 | 3063 | 3147 | 2633 | 3031 |
| 2035                 | 3324 | 3333 | 1882 | 4730 | 3292 | 3405 | 3464 | 2906 | 3341 |
| 2036                 | 3606 | 3590 | 2189 | 5007 | 3568 | 3698 | 3736 | 3139 | 3588 |
| 2037                 | 3880 | 3886 | 2507 | 5294 | 3815 | 4013 | 4062 | 3400 | 3894 |
| 2038                 | 4187 | 4184 | 2817 | 5552 | 4105 | 4325 | 4368 | 3658 | 4176 |
| 2039                 | 4459 | 4476 | 3068 | 5820 | 4373 | 4595 | 4695 | 3914 | 4477 |
| 2040                 | 4765 | 4785 | 3404 | 5923 | 4686 | 4914 | 4986 | 4151 | 4773 |
| 2041                 | 5082 | 5082 | 3652 | 6104 | 4936 | 5228 | 5318 | 4371 | 5090 |
| 2042                 | 5316 | 5255 | 4007 | 6332 | 5209 | 5386 | 5420 | 4503 | 5203 |
| 2043                 | 5606 | 5491 | 4250 | 6382 | 5534 | 5666 | 5649 | 4780 | 5454 |
| 2044                 | 5693 | 5777 | 4560 | 6467 | 5776 | 5943 | 5891 | 5094 | 5713 |
| 2045                 | 5860 | 6033 | 4888 | 6503 | 5988 | 6140 | 6088 | 5350 | 5935 |
| 2046                 | 5886 | 6253 | 5157 | 6529 | 6213 | 6374 | 6308 | 5612 | 6174 |
| 2047                 | 5937 | 6507 | 5394 | 6558 | 6419 | 6531 | 6505 | 5883 | 6389 |
| 2048                 | 5971 | 6737 | 5644 | 6583 | 6485 | 6592 | 6591 | 6028 | 6492 |
| 2049                 | 5984 | 6909 | 5856 | 6604 | 6550 | 6655 | 6649 | 6145 | 6569 |
| 2050                 | 6003 | 7023 | 6097 | 6630 | 6592 | 6677 | 6671 | 6229 | 6613 |
| 2051                 | 6007 | 7081 | 6302 | 6639 | 6611 | 6683 | 6681 | 6291 | 6628 |



| ScenarioID /<br>Year | 55   | 56   | 57   | 58   | 59   | 60   | 61   | 62   | 63   |
|----------------------|------|------|------|------|------|------|------|------|------|
| 2052                 | 6024 | 7129 | 6448 | 6658 | 6632 | 6684 | 6681 | 6330 | 6646 |
| 2053                 | 6029 | 7152 | 6549 | 6665 | 6636 | 6684 | 6681 | 6381 | 6649 |
| 2054                 | 6040 | 7177 | 6616 | 6675 | 6649 | 6684 | 6681 | 6412 | 6662 |
| 2055                 | 6044 | 7183 | 6659 | 6679 | 6655 | 6684 | 6681 | 6450 | 6668 |
| 2056                 | 6048 | 7187 | 6679 | 6679 | 6660 | 6684 | 6681 | 6473 | 6672 |
| 2057                 | 6054 | 7197 | 6690 | 6680 | 6672 | 6684 | 6681 | 6500 | 6681 |
| 2058                 | 6054 | 7197 | 6690 | 6680 | 6673 | 6684 | 6681 | 6524 | 6681 |
| 2059                 | 6054 | 7197 | 6695 | 6680 | 6682 | 6684 | 6681 | 6544 | 6681 |
| 2060                 | 6054 | 7197 | 6695 | 6680 | 6685 | 6684 | 6681 | 6571 | 6681 |
| 2061                 | 6054 | 7197 | 6695 | 6680 | 6686 | 6684 | 6681 | 6589 | 6681 |
| 2062                 | 6054 | 7197 | 6695 | 6680 | 6688 | 6684 | 6681 | 6613 | 6681 |
| 2063                 | 6054 | 7197 | 6695 | 6680 | 6688 | 6684 | 6681 | 6623 | 6681 |
| 2064                 | 6054 | 7197 | 6695 | 6680 | 6688 | 6684 | 6681 | 6633 | 6681 |
| 2065                 | 6054 | 7197 | 6695 | 6680 | 6688 | 6684 | 6681 | 6647 | 6681 |
| 2066                 | 6054 | 7197 | 6695 | 6680 | 6688 | 6684 | 6681 | 6651 | 6681 |
| 2067                 | 6054 | 7197 | 6695 | 6680 | 6688 | 6684 | 6681 | 6666 | 6681 |
| 2068                 | 6054 | 7197 | 6695 | 6680 | 6688 | 6684 | 6681 | 6668 | 6681 |
| 2069                 | 6054 | 7197 | 6695 | 6680 | 6688 | 6684 | 6681 | 6673 | 6681 |
| 2070                 | 6054 | 7197 | 6695 | 6680 | 6688 | 6684 | 6681 | 6681 | 6681 |
| 2071                 | 6054 | 7197 | 6695 | 6680 | 6688 | 6684 | 6681 | 6681 | 6681 |
| 2072                 | 6054 | 7197 | 6695 | 6680 | 6688 | 6684 | 6681 | 6681 | 6681 |
| 2073                 | 6054 | 7197 | 6695 | 6680 | 6688 | 6684 | 6681 | 6681 | 6681 |
| 2074                 | 6054 | 7197 | 6695 | 6680 | 6688 | 6684 | 6681 | 6681 | 6681 |
| 2075                 | 6054 | 7197 | 6695 | 6680 | 6688 | 6684 | 6681 | 6681 | 6681 |
| 2076                 | 6054 | 7197 | 6695 | 6680 | 6688 | 6684 | 6681 | 6681 | 6681 |
| 2077                 | 6054 | 7197 | 6695 | 6680 | 6688 | 6684 | 6681 | 6681 | 6681 |
| 2078                 | 6054 | 7197 | 6695 | 6680 | 6688 | 6684 | 6681 | 6681 | 6681 |
| 2079                 | 6054 | 7197 | 6695 | 6680 | 6688 | 6684 | 6681 | 6681 | 6681 |
| 2080                 | 6054 | 7197 | 6695 | 6680 | 6688 | 6684 | 6681 | 6681 | 6681 |
| 2081                 | 6054 | 7197 | 6695 | 6680 | 6688 | 6684 | 6681 | 6681 | 6681 |
| 2082                 | 6054 | 7197 | 6695 | 6680 | 6688 | 6684 | 6681 | 6681 | 6681 |
| 2083                 | 6054 | 7197 | 6695 | 6680 | 6688 | 6684 | 6681 | 6681 | 6681 |
| 2084                 | 6054 | 7197 | 6695 | 6680 | 6688 | 6684 | 6681 | 6681 | 6681 |
| 2085                 | 6054 | 7197 | 6695 | 6680 | 6688 | 6684 | 6681 | 6681 | 6681 |
| 2086                 | 6054 | 7197 | 6695 | 6680 | 6688 | 6684 | 6681 | 6681 | 6681 |
| 2087                 | 6054 | 7197 | 6695 | 6680 | 6688 | 6684 | 6681 | 6681 | 6681 |
| 2088                 | 6054 | 7197 | 6695 | 6680 | 6688 | 6684 | 6681 | 6681 | 6681 |
| 2089                 | 6054 | 7197 | 6695 | 6680 | 6688 | 6684 | 6681 | 6681 | 6681 |
| 2090                 | 6054 | 7197 | 6695 | 6680 | 6688 | 6684 | 6681 | 6681 | 6681 |

| ScenarioID /<br>Year | 64   | 65   | 66   | 67   | 68   | 69   | 70   | 71   | 72   |
|----------------------|------|------|------|------|------|------|------|------|------|
| 2002                 | 0    | 0    | 0    | 0    | 0    | 0    | 0    | 0    | 0    |
| 2003                 | 0    | 0    | 0    | 0    | 0    | 0    | 0    | 0    | 0    |
| 2004                 | 0    | 0    | 0    | 0    | 0    | 0    | 0    | 0    | 0    |
| 2005                 | 0    | 0    | 0    | 0    | 0    | 0    | 0    | 0    | 0    |
| 2006                 | 0    | 0    | 0    | 0    | 0    | 0    | 0    | 0    | 0    |
| 2007                 | 0    | 0    | 0    | 0    | 0    | 0    | 0    | 0    | 0    |
| 2008                 | 0    | 0    | 0    | 0    | 0    | 0    | 0    | 0    | 0    |
| 2009                 | 0    | 0    | 0    | 0    | 0    | 0    | 0    | 0    | 0    |
| 2010                 | 0    | 0    | 0    | 0    | 0    | 0    | 0    | 0    | 0    |
| 2011                 | 0    | 0    | 0    | 0    | 0    | 0    | 0    | 0    | 0    |
| 2012                 | 0    | 0    | 0    | 0    | 0    | 0    | 0    | 0    | 0    |
| 2013                 | 0    | 0    | 0    | 0    | 0    | 0    | 0    | 0    | 0    |
| 2014                 | 0    | 0    | 0    | 0    | 0    | 0    | 0    | 0    | 0    |
| 2015                 | 0    | 0    | 0    | 0    | 0    | 0    | 0    | 0    | 0    |
| 2016                 | 0    | 0    | 0    | 0    | 0    | 0    | 0    | 0    | 0    |
| 2017                 | 0    | 0    | 0    | 0    | 0    | 0    | 0    | 0    | 0    |
| 2018                 | 0    | 0    | 0    | 0    | 0    | 0    | 0    | 0    | 0    |
| 2019                 | 0    | 0    | 0    | 0    | 0    | 0    | 0    | 0    | 0    |
| 2020                 | 0    | 0    | 0    | 194  | 0    | 0    | 0    | 0    | 0    |
| 2021                 | 0    | 0    | 0    | 427  | 0    | 0    | 0    | 0    | 0    |
| 2022                 | 0    | 0    | 0    | 675  | 0    | 0    | 0    | 0    | 0    |
| 2023                 | 0    | 0    | 0    | 989  | 0    | 0    | 0    | 0    | 0    |
| 2024                 | 0    | 0    | 0    | 1257 | 0    | 0    | 0    | 0    | 0    |
| 2025                 | 208  | 208  | 0    | 1519 | 200  | 274  | 353  | 93   | 208  |
| 2026                 | 415  | 415  | 0    | 1837 | 389  | 565  | 668  | 129  | 415  |
| 2027                 | 626  | 626  | 0    | 2118 | 582  | 860  | 973  | 220  | 626  |
| 2028                 | 882  | 886  | 0    | 2392 | 828  | 1144 | 1273 | 301  | 886  |
| 2029                 | 1149 | 1153 | 0    | 2678 | 1076 | 1415 | 1589 | 393  | 1153 |
| 2030                 | 1404 | 1408 | 218  | 2980 | 1296 | 1678 | 1889 | 503  | 1408 |
| 2031                 | 1706 | 1708 | 441  | 3264 | 1526 | 1964 | 2188 | 646  | 1708 |
| 2032                 | 1992 | 1994 | 630  | 3555 | 1774 | 2274 | 2504 | 790  | 1990 |
| 2033                 | 2324 | 2333 | 863  | 3883 | 2094 | 2577 | 2811 | 992  | 2328 |
| 2034                 | 2610 | 2621 | 1114 | 4251 | 2382 | 2911 | 3114 | 1162 | 2617 |
| 2035                 | 2931 | 2931 | 1437 | 4532 | 2705 | 3231 | 3428 | 1390 | 2935 |
| 2036                 | 3232 | 3232 | 1652 | 4772 | 2993 | 3481 | 3726 | 1629 | 3224 |
| 2037                 | 3544 | 3567 | 1982 | 5059 | 3324 | 3737 | 4034 | 1880 | 3558 |
| 2038                 | 3825 | 3849 | 2260 | 5319 | 3637 | 4056 | 4337 | 2183 | 3845 |
| 2039                 | 4128 | 4134 | 2529 | 5546 | 3926 | 4303 | 4640 | 2404 | 4138 |
| 2040                 | 4411 | 4431 | 2831 | 5694 | 4220 | 4598 | 4934 | 2700 | 4436 |
| 2041                 | 4730 | 4763 | 3151 | 5912 | 4474 | 4894 | 5242 | 2921 | 4777 |
| 2042                 | 4865 | 4947 | 3510 | 6174 | 4829 | 5090 | 5332 | 3182 | 4910 |
| 2043                 | 5129 | 5250 | 3797 | 6285 | 5176 | 5372 | 5565 | 3597 | 5199 |
| 2044                 | 5388 | 5587 | 4151 | 6404 | 5486 | 5717 | 5820 | 4034 | 5516 |
| 2045                 | 5622 | 5893 | 4527 | 6458 | 5752 | 5979 | 6033 | 4421 | 5789 |
| 2046                 | 5745 | 6168 | 4862 | 6519 | 5976 | 6253 | 6245 | 4773 | 6048 |
| 2047                 | 5875 | 6414 | 5160 | 6558 | 6209 | 6485 | 6443 | 5150 | 6285 |
| 2048                 | 5927 | 6646 | 5444 | 6580 | 6325 | 6564 | 6575 | 5453 | 6438 |
| 2049                 | 5980 | 6862 | 5704 | 6587 | 6433 | 6635 | 6634 | 5699 | 6539 |
| 2050                 | 6004 | 6991 | 5956 | 6608 | 6491 | 6680 | 6672 | 5839 | 6600 |
| 2051                 | 6020 | 7054 | 6217 | 6617 | 6560 | 6700 | 6694 | 5942 | 6635 |

| ScenarioID /<br>Year | 64   | 65   | 66   | 67   | 68   | 69   | 70   | 71   | 72   |
|----------------------|------|------|------|------|------|------|------|------|------|
| 2052                 | 6030 | 7099 | 6384 | 6639 | 6595 | 6700 | 6694 | 6035 | 6650 |
| 2053                 | 6033 | 7136 | 6506 | 6650 | 6614 | 6700 | 6694 | 6139 | 6658 |
| 2054                 | 6041 | 7163 | 6596 | 6663 | 6635 | 6700 | 6694 | 6221 | 6671 |
| 2055                 | 6047 | 7169 | 6635 | 6668 | 6640 | 6700 | 6694 | 6284 | 6680 |
| 2056                 | 6050 | 7178 | 6655 | 6670 | 6649 | 6700 | 6694 | 6317 | 6686 |
| 2057                 | 6057 | 7188 | 6677 | 6671 | 6661 | 6700 | 6694 | 6410 | 6693 |
| 2058                 | 6058 | 7190 | 6680 | 6671 | 6665 | 6700 | 6694 | 6460 | 6694 |
| 2059                 | 6058 | 7190 | 6684 | 6671 | 6678 | 6700 | 6694 | 6509 | 6694 |
| 2060                 | 6058 | 7190 | 6684 | 6671 | 6679 | 6700 | 6694 | 6544 | 6694 |
| 2061                 | 6058 | 7190 | 6684 | 6671 | 6684 | 6700 | 6694 | 6578 | 6694 |
| 2062                 | 6058 | 7190 | 6684 | 6671 | 6686 | 6700 | 6694 | 6612 | 6694 |
| 2063                 | 6058 | 7190 | 6684 | 6671 | 6686 | 6700 | 6694 | 6632 | 6694 |
| 2064                 | 6058 | 7190 | 6684 | 6671 | 6686 | 6700 | 6694 | 6640 | 6694 |
| 2065                 | 6058 | 7190 | 6684 | 6671 | 6686 | 6700 | 6694 | 6652 | 6694 |
| 2066                 | 6058 | 7190 | 6684 | 6671 | 6686 | 6700 | 6694 | 6660 | 6694 |
| 2067                 | 6058 | 7190 | 6684 | 6671 | 6686 | 6700 | 6694 | 6675 | 6694 |
| 2068                 | 6058 | 7190 | 6684 | 6671 | 6686 | 6700 | 6694 | 6680 | 6694 |
| 2069                 | 6058 | 7190 | 6684 | 6671 | 6686 | 6700 | 6694 | 6686 | 6694 |
| 2070                 | 6058 | 7190 | 6684 | 6671 | 6686 | 6700 | 6694 | 6693 | 6694 |
| 2071                 | 6058 | 7190 | 6684 | 6671 | 6686 | 6700 | 6694 | 6694 | 6694 |
| 2072                 | 6058 | 7190 | 6684 | 6671 | 6686 | 6700 | 6694 | 6694 | 6694 |
| 2073                 | 6058 | 7190 | 6684 | 6671 | 6686 | 6700 | 6694 | 6694 | 6694 |
| 2074                 | 6058 | 7190 | 6684 | 6671 | 6686 | 6700 | 6694 | 6694 | 6694 |
| 2075                 | 6058 | 7190 | 6684 | 6671 | 6686 | 6700 | 6694 | 6694 | 6694 |
| 2076                 | 6058 | 7190 | 6684 | 6671 | 6686 | 6700 | 6694 | 6694 | 6694 |
| 2077                 | 6058 | 7190 | 6684 | 6671 | 6686 | 6700 | 6694 | 6694 | 6694 |
| 2078                 | 6058 | 7190 | 6684 | 6671 | 6686 | 6700 | 6694 | 6694 | 6694 |
| 2079                 | 6058 | 7190 | 6684 | 6671 | 6686 | 6700 | 6694 | 6694 | 6694 |
| 2080                 | 6058 | 7190 | 6684 | 6671 | 6686 | 6700 | 6694 | 6694 | 6694 |
| 2081                 | 6058 | 7190 | 6684 | 6671 | 6686 | 6700 | 6694 | 6694 | 6694 |
| 2082                 | 6058 | 7190 | 6684 | 6671 | 6686 | 6700 | 6694 | 6694 | 6694 |
| 2083                 | 6058 | 7190 | 6684 | 6671 | 6686 | 6700 | 6694 | 6694 | 6694 |
| 2084                 | 6058 | 7190 | 6684 | 6671 | 6686 | 6700 | 6694 | 6694 | 6694 |
| 2085                 | 6058 | 7190 | 6684 | 6671 | 6686 | 6700 | 6694 | 6694 | 6694 |
| 2086                 | 6058 | 7190 | 6684 | 6671 | 6686 | 6700 | 6694 | 6694 | 6694 |
| 2087                 | 6058 | 7190 | 6684 | 6671 | 6686 | 6700 | 6694 | 6694 | 6694 |
| 2088                 | 6058 | 7190 | 6684 | 6671 | 6686 | 6700 | 6694 | 6694 | 6694 |
| 2089                 | 6058 | 7190 | 6684 | 6671 | 6686 | 6700 | 6694 | 6694 | 6694 |
| 2090                 | 6058 | 7190 | 6684 | 6671 | 6686 | 6700 | 6694 | 6694 | 6694 |

| ScenarioID /<br>Year | 73   | 74   | 75   | 76   | 77   | 78   | 79   | 80   | 81   |
|----------------------|------|------|------|------|------|------|------|------|------|
| 2002                 | 0    | 0    | 0    | 0    | 0    | 0    | 0    | 0    | 0    |
| 2003                 | 0    | 0    | 0    | 0    | 0    | 0    | 0    | 0    | 0    |
| 2004                 | 0    | 0    | 0    | 0    | 0    | 0    | 0    | 0    | 0    |
| 2005                 | 0    | 0    | 0    | 0    | 0    | 0    | 0    | 0    | 0    |
| 2006                 | 0    | 0    | 0    | 0    | 0    | 0    | 0    | 0    | 0    |
| 2007                 | 0    | 0    | 0    | 0    | 0    | 0    | 0    | 0    | 0    |
| 2008                 | 0    | 0    | 0    | 0    | 0    | 0    | 0    | 0    | 0    |
| 2009                 | 0    | 0    | 0    | 0    | 0    | 0    | 0    | 0    | 0    |
| 2010                 | 0    | 0    | 0    | 0    | 0    | 0    | 0    | 0    | 0    |
| 2011                 | 0    | 0    | 0    | 0    | 0    | 0    | 0    | 0    | 0    |
| 2012                 | 0    | 0    | 0    | 0    | 0    | 0    | 0    | 0    | 0    |
| 2013                 | 0    | 0    | 0    | 0    | 0    | 0    | 0    | 0    | 0    |
| 2014                 | 0    | 0    | 0    | 0    | 0    | 0    | 0    | 0    | 0    |
| 2015                 | 0    | 0    | 0    | 0    | 0    | 0    | 0    | 0    | 0    |
| 2016                 | 0    | 0    | 0    | 0    | 0    | 0    | 0    | 0    | 0    |
| 2017                 | 0    | 0    | 0    | 0    | 0    | 0    | 0    | 0    | 0    |
| 2018                 | 0    | 0    | 0    | 0    | 0    | 0    | 0    | 0    | 0    |
| 2019                 | 0    | 0    | 0    | 0    | 0    | 0    | 0    | 0    | 0    |
| 2020                 | 0    | 0    | 0    | 81   | 0    | 0    | 0    | 0    | 0    |
| 2021                 | 0    | 0    | 0    | 184  | 0    | 0    | 0    | 0    | 0    |
| 2022                 | 0    | 0    | 0    | 349  | 0    | 0    | 0    | 0    | 0    |
| 2023                 | 0    | 0    | 0    | 446  | 0    | 0    | 0    | 0    | 0    |
| 2024                 | 0    | 0    | 0    | 639  | 0    | 0    | 0    | 0    | 0    |
| 2025                 | 71   | 71   | 0    | 828  | 63   | 153  | 207  | 15   | 71   |
| 2026                 | 155  | 155  | 0    | 1096 | 120  | 330  | 424  | 19   | 155  |
| 2027                 | 344  | 344  | 0    | 1364 | 274  | 508  | 694  | 77   | 344  |
| 2028                 | 450  | 456  | 0    | 1589 | 387  | 763  | 1006 | 106  | 450  |
| 2029                 | 609  | 617  | 0    | 1908 | 522  | 1058 | 1287 | 156  | 611  |
| 2030                 | 814  | 820  | 69   | 2201 | 738  | 1331 | 1567 | 208  | 814  |
| 2031                 | 1030 | 1038 | 151  | 2479 | 894  | 1599 | 1937 | 293  | 1034 |
| 2032                 | 1250 | 1262 | 271  | 2788 | 1060 | 1854 | 2225 | 355  | 1255 |
| 2033                 | 1532 | 1541 | 457  | 3107 | 1306 | 2141 | 2520 | 447  | 1536 |
| 2034                 | 1854 | 1856 | 661  | 3441 | 1512 | 2443 | 2783 | 573  | 1854 |
| 2035                 | 2136 | 2143 | 854  | 3733 | 1820 | 2813 | 3130 | 727  | 2142 |
| 2036                 | 2418 | 2422 | 1065 | 4078 | 2081 | 3092 | 3432 | 835  | 2421 |
| 2037                 | 2707 | 2715 | 1285 | 4419 | 2356 | 3402 | 3718 | 960  | 2705 |
| 2038                 | 3023 | 3030 | 1526 | 4753 | 2637 | 3704 | 4083 | 1141 | 3033 |
| 2039                 | 3349 | 3357 | 1790 | 5077 | 2915 | 3951 | 4374 | 1334 | 3358 |
| 2040                 | 3645 | 3641 | 2073 | 5444 | 3272 | 4242 | 4687 | 1519 | 3653 |
| 2041                 | 3984 | 3984 | 2410 | 5899 | 3594 | 4536 | 4998 | 1692 | 3985 |
| 2042                 | 4427 | 4460 | 2704 | 6072 | 4072 | 4782 | 5368 | 2135 | 4449 |
| 2043                 | 4900 | 4969 | 3018 | 6235 | 4582 | 5213 | 5714 | 2673 | 4950 |
| 2044                 | 5153 | 5363 | 3481 | 6311 | 4996 | 5573 | 5998 | 3130 | 5329 |
| 2045                 | 5493 | 5743 | 3996 | 6423 | 5341 | 5866 | 6169 | 3543 | 5667 |
| 2046                 | 5602 | 6049 | 4454 | 6473 | 5661 | 6164 | 6365 | 3972 | 5967 |
| 2047                 | 5717 | 6322 | 4837 | 6527 | 5968 | 6406 | 6542 | 4390 | 6227 |
| 2048                 | 5807 | 6606 | 5167 | 6580 | 6154 | 6538 | 6609 | 4661 | 6380 |
| 2049                 | 5902 | 6835 | 5478 | 6637 | 6282 | 6635 | 6661 | 4928 | 6515 |
| 2050                 | 5972 | 6998 | 5806 | 6664 | 6370 | 6673 | 6678 | 5168 | 6600 |
| 2051                 | 6015 | 7088 | 6087 | 6672 | 6457 | 6690 | 6688 | 5346 | 6645 |

| ScenarioID /<br>Year | 73   | 74   | 75   | 76   | 77   | 78   | 79   | 80   | 81   |
|----------------------|------|------|------|------|------|------|------|------|------|
| 2052                 | 6036 | 7146 | 6276 | 6682 | 6534 | 6690 | 6688 | 5519 | 6668 |
| 2053                 | 6041 | 7168 | 6445 | 6684 | 6576 | 6690 | 6688 | 5661 | 6671 |
| 2054                 | 6045 | 7181 | 6581 | 6688 | 6623 | 6690 | 6688 | 5792 | 6679 |
| 2055                 | 6048 | 7186 | 6645 | 6691 | 6649 | 6690 | 6688 | 5937 | 6682 |
| 2056                 | 6049 | 7188 | 6670 | 6691 | 6675 | 6690 | 6688 | 6053 | 6683 |
| 2057                 | 6051 | 7189 | 6687 | 6691 | 6685 | 6690 | 6688 | 6191 | 6688 |
| 2058                 | 6051 | 7189 | 6687 | 6691 | 6685 | 6690 | 6688 | 6312 | 6688 |
| 2059                 | 6051 | 7189 | 6689 | 6691 | 6687 | 6690 | 6688 | 6377 | 6688 |
| 2060                 | 6051 | 7189 | 6689 | 6691 | 6690 | 6690 | 6688 | 6460 | 6688 |
| 2061                 | 6051 | 7189 | 6689 | 6691 | 6692 | 6690 | 6688 | 6520 | 6688 |
| 2062                 | 6051 | 7189 | 6689 | 6691 | 6692 | 6690 | 6688 | 6595 | 6688 |
| 2063                 | 6051 | 7189 | 6689 | 6691 | 6692 | 6690 | 6688 | 6631 | 6688 |
| 2064                 | 6051 | 7189 | 6689 | 6691 | 6692 | 6690 | 6688 | 6659 | 6688 |
| 2065                 | 6051 | 7189 | 6689 | 6691 | 6692 | 6690 | 6688 | 6671 | 6688 |
| 2066                 | 6051 | 7189 | 6689 | 6691 | 6692 | 6690 | 6688 | 6671 | 6688 |
| 2067                 | 6051 | 7189 | 6689 | 6691 | 6692 | 6690 | 6688 | 6680 | 6688 |
| 2068                 | 6051 | 7189 | 6689 | 6691 | 6692 | 6690 | 6688 | 6682 | 6688 |
| 2069                 | 6051 | 7189 | 6689 | 6691 | 6692 | 6690 | 6688 | 6683 | 6688 |
| 2070                 | 6051 | 7189 | 6689 | 6691 | 6692 | 6690 | 6688 | 6688 | 6688 |
| 2071                 | 6051 | 7189 | 6689 | 6691 | 6692 | 6690 | 6688 | 6688 | 6688 |
| 2072                 | 6051 | 7189 | 6689 | 6691 | 6692 | 6690 | 6688 | 6688 | 6688 |
| 2073                 | 6051 | 7189 | 6689 | 6691 | 6692 | 6690 | 6688 | 6688 | 6688 |
| 2074                 | 6051 | 7189 | 6689 | 6691 | 6692 | 6690 | 6688 | 6688 | 6688 |
| 2075                 | 6051 | 7189 | 6689 | 6691 | 6692 | 6690 | 6688 | 6688 | 6688 |
| 2076                 | 6051 | 7189 | 6689 | 6691 | 6692 | 6690 | 6688 | 6688 | 6688 |
| 2077                 | 6051 | 7189 | 6689 | 6691 | 6692 | 6690 | 6688 | 6688 | 6688 |
| 2078                 | 6051 | 7189 | 6689 | 6691 | 6692 | 6690 | 6688 | 6688 | 6688 |
| 2079                 | 6051 | 7189 | 6689 | 6691 | 6692 | 6690 | 6688 | 6688 | 6688 |
| 2080                 | 6051 | 7189 | 6689 | 6691 | 6692 | 6690 | 6688 | 6688 | 6688 |
| 2081                 | 6051 | 7189 | 6689 | 6691 | 6692 | 6690 | 6688 | 6688 | 6688 |
| 2082                 | 6051 | 7189 | 6689 | 6691 | 6692 | 6690 | 6688 | 6688 | 6688 |
| 2083                 | 6051 | 7189 | 6689 | 6691 | 6692 | 6690 | 6688 | 6688 | 6688 |
| 2084                 | 6051 | 7189 | 6689 | 6691 | 6692 | 6690 | 6688 | 6688 | 6688 |
| 2085                 | 6051 | 7189 | 6689 | 6691 | 6692 | 6690 | 6688 | 6688 | 6688 |
| 2086                 | 6051 | 7189 | 6689 | 6691 | 6692 | 6690 | 6688 | 6688 | 6688 |
| 2087                 | 6051 | 7189 | 6689 | 6691 | 6692 | 6690 | 6688 | 6688 | 6688 |
| 2088                 | 6051 | 7189 | 6689 | 6691 | 6692 | 6690 | 6688 | 6688 | 6688 |
| 2089                 | 6051 | 7189 | 6689 | 6691 | 6692 | 6690 | 6688 | 6688 | 6688 |
| 2090                 | 6051 | 7189 | 6689 | 6691 | 6692 | 6690 | 6688 | 6688 | 6688 |

| ScenarioID /<br>Year | 1   | 2    | 3    | 4   | 5    | 6    | 7    | 8    | 9    |
|----------------------|-----|------|------|-----|------|------|------|------|------|
| 2002                 | 0   | 0    | 0    | 0   | 0    | 0    | 0    | 0    | 0    |
| 2003                 | 0   | 0    | 0    | 0   | 0    | 0    | 0    | 0    | 0    |
| 2004                 | 0   | 0    | 0    | 0   | 0    | 0    | 0    | 0    | 0    |
| 2005                 | 0   | 0    | 0    | 0   | 0    | 0    | 0    | 0    | 0    |
| 2006                 | 0   | 0    | 0    | 0   | 0    | 0    | 0    | 0    | 0    |
| 2007                 | 0   | 0    | 0    | 0   | 0    | 0    | 0    | 0    | 0    |
| 2008                 | 0   | 0    | 0    | 0   | 0    | 0    | 0    | 0    | 0    |
| 2009                 | 0   | 0    | 0    | 0   | 0    | 0    | 0    | 0    | 0    |
| 2010                 | 0   | 0    | 0    | 0   | 0    | 0    | 0    | 0    | 0    |
| 2011                 | 0   | 0    | 0    | 0   | 0    | 0    | 0    | 0    | 0    |
| 2012                 | 0   | 105  | 0    | 0   | 0    | 0    | 0    | 0    | 0    |
| 2013                 | 0   | 234  | 0    | 0   | 0    | 0    | 0    | 0    | 0    |
| 2014                 | 0   | 352  | 0    | 0   | 0    | 0    | 0    | 0    | 0    |
| 2015                 | 0   | 501  | 0    | 0   | 0    | 0    | 0    | 0    | 0    |
| 2016                 | 0   | 644  | 143  | 143 | 143  | 143  | 143  | 143  | 143  |
| 2017                 | 0   | 796  | 295  | 295 | 295  | 295  | 295  | 295  | 295  |
| 2018                 | 0   | 963  | 462  | 462 | 462  | 462  | 462  | 462  | 462  |
| 2019                 | 0   | 1136 | 635  | 635 | 635  | 635  | 635  | 635  | 635  |
| 2020                 | 173 | 1309 | 808  | 635 | 808  | 808  | 808  | 808  | 808  |
| 2021                 | 359 | 1495 | 994  | 632 | 994  | 994  | 994  | 994  | 994  |
| 2022                 | 525 | 1661 | 1160 | 632 | 1160 | 1160 | 1160 | 1160 | 1160 |
| 2023                 | 715 | 1851 | 1350 | 632 | 1350 | 1350 | 1350 | 1350 | 1350 |
| 2024                 | 914 | 2050 | 1549 | 632 | 1549 | 1549 | 1549 | 1549 | 1549 |
| 2025                 | 914 | 2050 | 1741 | 625 | 1549 | 1549 | 1549 | 1549 | 1549 |
| 2026                 | 911 | 2047 | 1924 | 622 | 1549 | 1549 | 1546 | 1546 | 1546 |
| 2027                 | 911 | 2047 | 2117 | 622 | 1549 | 1549 | 1546 | 1546 | 1546 |
| 2028                 | 911 | 2047 | 2311 | 619 | 1549 | 1544 | 1546 | 1546 | 1546 |
| 2029                 | 911 | 2047 | 2483 | 616 | 1549 | 1535 | 1546 | 1546 | 1546 |
| 2030                 | 906 | 2042 | 2483 | 602 | 1549 | 1525 | 1541 | 1541 | 1541 |
| 2031                 | 906 | 2042 | 2483 | 594 | 1549 | 1508 | 1541 | 1541 | 1541 |
| 2032                 | 901 | 2037 | 2483 | 560 | 1549 | 1493 | 1536 | 1536 | 1536 |
| 2033                 | 896 | 2032 | 2483 | 554 | 1546 | 1466 | 1531 | 1531 | 1531 |
| 2034                 | 891 | 2027 | 2483 | 522 | 1542 | 1442 | 1526 | 1526 | 1526 |
| 2035                 | 878 | 2014 | 2476 | 499 | 1537 | 1417 | 1513 | 1513 | 1513 |
| 2036                 | 850 | 1978 | 2469 | 490 | 1516 | 1381 | 1477 | 1477 | 1477 |
| 2037                 | 828 | 1950 | 2459 | 479 | 1509 | 1362 | 1449 | 1449 | 1449 |
| 2038                 | 822 | 1940 | 2439 | 334 | 1483 | 1334 | 1436 | 1436 | 1436 |
| 2039                 | 800 | 1911 | 2430 | 145 | 1469 | 1311 | 1407 | 1407 | 1407 |
| 2040                 | 597 | 1672 | 2426 | 51  | 1232 | 1073 | 1183 | 1183 | 1183 |
| 2041                 | 399 | 1422 | 2403 | 3   | 995  | 836  | 935  | 935  | 935  |
| 2042                 | 226 | 1178 | 2156 | 3   | 774  | 628  | 736  | 736  | 736  |
| 2043                 | 106 | 984  | 1876 | 3   | 592  | 444  | 554  | 554  | 554  |
| 2044                 | 25  | 795  | 1627 | 3   | 399  | 278  | 350  | 350  | 350  |
| 2045                 | 3   | 565  | 1385 | 3   | 232  | 165  | 218  | 218  | 218  |
| 2046                 | 3   | 395  | 1149 | 3   | 113  | 63   | 101  | 101  | 101  |
| 2047                 | 3   | 230  | 910  | 3   | 32   | 16   | 25   | 25   | 25   |
| 2048                 | 3   | 111  | 752  | 3   | 2    | 16   | 2    | 2    | 2    |
| 2049                 | 3   | 37   | 553  | 3   | 2    | 16   | 2    | 2    | 2    |
| 2050                 | 3   | 5    | 360  | 3   | 2    | 16   | 2    | 2    | 2    |
| 2051                 | 3   | 5    | 201  | 3   | 2    | 16   | 2    | 2    | 2    |

| ScenarioID /<br>Year | 1 | 2 | 3  | 4 | 5 | 6  | 7 | 8 | 9 |
|----------------------|---|---|----|---|---|----|---|---|---|
| 2052                 | 3 | 5 | 86 | 3 | 2 | 16 | 2 | 2 | 2 |
| 2053                 | 3 | 5 | 36 | 3 | 2 | 0  | 2 | 2 | 2 |
| 2054                 | 3 | 5 | 11 | 3 | 2 | 0  | 2 | 2 | 2 |
| 2055                 | 3 | 5 | 11 | 3 | 2 | 0  | 2 | 2 | 2 |
| 2056                 | 3 | 5 | 11 | 3 | 2 | 0  | 2 | 2 | 2 |
| 2057                 | 3 | 5 | 11 | 3 | 2 | 0  | 2 | 2 | 2 |
| 2058                 | 3 | 5 | 11 | 3 | 2 | 0  | 2 | 2 | 2 |
| 2059                 | 3 | 5 | 11 | 3 | 2 | 0  | 2 | 2 | 2 |
| 2060                 | 3 | 5 | 11 | 3 | 2 | 0  | 2 | 2 | 2 |
| 2061                 | 3 | 5 | 11 | 3 | 2 | 0  | 2 | 2 | 2 |
| 2062                 | 3 | 5 | 11 | 3 | 2 | 0  | 2 | 2 | 2 |
| 2063                 | 3 | 5 | 11 | 3 | 2 | 0  | 2 | 2 | 2 |
| 2064                 | 3 | 5 | 11 | 3 | 2 | 0  | 2 | 2 | 2 |
| 2065                 | 3 | 5 | 11 | 3 | 2 | 0  | 2 | 2 | 2 |
| 2066                 | 3 | 5 | 11 | 3 | 2 | 0  | 2 | 2 | 2 |
| 2067                 | 3 | 5 | 11 | 3 | 2 | 0  | 2 | 2 | 2 |
| 2068                 | 3 | 5 | 11 | 3 | 2 | 0  | 2 | 2 | 2 |
| 2069                 | 3 | 5 | 11 | 3 | 2 | 0  | 2 | 2 | 2 |
| 2070                 | 3 | 5 | 11 | 3 | 2 | 0  | 2 | 2 | 2 |
| 2071                 | 3 | 5 | 11 | 3 | 2 | 0  | 2 | 2 | 2 |
| 2072                 | 3 | 5 | 11 | 3 | 2 | 0  | 2 | 2 | 2 |
| 2073                 | 3 | 5 | 11 | 3 | 2 | 0  | 2 | 2 | 2 |
| 2074                 | 3 | 5 | 11 | 3 | 2 | 0  | 2 | 2 | 2 |
| 2075                 | 3 | 5 | 11 | 3 | 2 | 0  | 2 | 2 | 2 |
| 2076                 | 3 | 5 | 11 | 3 | 2 | 0  | 2 | 2 | 2 |
| 2077                 | 3 | 5 | 11 | 3 | 2 | 0  | 2 | 2 | 2 |
| 2078                 | 3 | 5 | 11 | 3 | 2 | 0  | 2 | 2 | 2 |
| 2079                 | 3 | 5 | 11 | 3 | 2 | 0  | 2 | 2 | 2 |
| 2080                 | 3 | 5 | 11 | 3 | 2 | 0  | 2 | 2 | 2 |
| 2081                 | 3 | 5 | 11 | 3 | 2 | 0  | 2 | 2 | 2 |
| 2082                 | 3 | 5 | 11 | 3 | 2 | 0  | 2 | 2 | 2 |
| 2083                 | 3 | 5 | 11 | 3 | 2 | 0  | 2 | 2 | 2 |
| 2084                 | 3 | 5 | 11 | 3 | 2 | 0  | 2 | 2 | 2 |
| 2085                 | 3 | 5 | 11 | 3 | 2 | 0  | 2 | 2 | 2 |
| 2086                 | 3 | 5 | 11 | 3 | 2 | 0  | 2 | 2 | 2 |
| 2087                 | 3 | 5 | 11 | 3 | 2 | 0  | 2 | 2 | 2 |
| 2088                 | 3 | 5 | 11 | 3 | 2 | 0  | 2 | 2 | 2 |
| 2089                 | 3 | 5 | 11 | 3 | 2 | 0  | 2 | 2 | 2 |
| 2090                 | 3 | 5 | 11 | 3 | 2 | 0  | 2 | 2 | 2 |

| ScenarioID /<br>Year | 10  | 11   | 12   | 13  | 14   | 15   | 16   | 17   | 18   |
|----------------------|-----|------|------|-----|------|------|------|------|------|
| 2002                 | 0   | 0    | 0    | 0   | 0    | 0    | 0    | 0    | 0    |
| 2003                 | 0   | 0    | 0    | 0   | 0    | 0    | 0    | 0    | 0    |
| 2004                 | 0   | 0    | 0    | 0   | 0    | 0    | 0    | 0    | 0    |
| 2005                 | 0   | 0    | 0    | 0   | 0    | 0    | 0    | 0    | 0    |
| 2006                 | 0   | 0    | 0    | 0   | 0    | 0    | 0    | 0    | 0    |
| 2007                 | 0   | 0    | 0    | 0   | 0    | 0    | 0    | 0    | 0    |
| 2008                 | 0   | 0    | 0    | 0   | 0    | 0    | 0    | 0    | 0    |
| 2009                 | 0   | 0    | 0    | 0   | 0    | 0    | 0    | 0    | 0    |
| 2010                 | 0   | 0    | 0    | 0   | 0    | 0    | 0    | 0    | 0    |
| 2011                 | 0   | 0    | 0    | 0   | 0    | 0    | 0    | 0    | 0    |
| 2012                 | 0   | 105  | 0    | 0   | 0    | 0    | 0    | 0    | 0    |
| 2013                 | 0   | 234  | 0    | 0   | 0    | 0    | 0    | 0    | 0    |
| 2014                 | 0   | 352  | 0    | 0   | 0    | 0    | 0    | 0    | 0    |
| 2015                 | 0   | 501  | 0    | 0   | 0    | 0    | 0    | 0    | 0    |
| 2016                 | 0   | 644  | 143  | 143 | 143  | 143  | 143  | 143  | 143  |
| 2017                 | 0   | 796  | 295  | 295 | 295  | 295  | 295  | 295  | 295  |
| 2018                 | 0   | 963  | 462  | 462 | 462  | 462  | 462  | 462  | 462  |
| 2019                 | 0   | 1136 | 635  | 635 | 635  | 635  | 635  | 635  | 635  |
| 2020                 | 173 | 1309 | 808  | 635 | 808  | 808  | 808  | 808  | 808  |
| 2021                 | 359 | 1495 | 994  | 630 | 994  | 994  | 994  | 994  | 994  |
| 2022                 | 525 | 1661 | 1160 | 630 | 1160 | 1160 | 1160 | 1160 | 1160 |
| 2023                 | 715 | 1851 | 1350 | 630 | 1350 | 1350 | 1350 | 1350 | 1350 |
| 2024                 | 914 | 2050 | 1549 | 622 | 1549 | 1549 | 1549 | 1549 | 1549 |
| 2025                 | 914 | 2050 | 1741 | 606 | 1549 | 1549 | 1549 | 1549 | 1549 |
| 2026                 | 914 | 2050 | 1924 | 599 | 1549 | 1537 | 1549 | 1549 | 1549 |
| 2027                 | 907 | 2043 | 2117 | 581 | 1547 | 1524 | 1542 | 1542 | 1542 |
| 2028                 | 907 | 2043 | 2311 | 569 | 1541 | 1511 | 1542 | 1542 | 1542 |
| 2029                 | 898 | 2027 | 2483 | 556 | 1526 | 1498 | 1528 | 1528 | 1528 |
| 2030                 | 883 | 2010 | 2483 | 539 | 1516 | 1473 | 1513 | 1513 | 1513 |
| 2031                 | 876 | 1995 | 2483 | 518 | 1511 | 1458 | 1498 | 1498 | 1498 |
| 2032                 | 864 | 1969 | 2479 | 504 | 1491 | 1423 | 1474 | 1474 | 1474 |
| 2033                 | 828 | 1927 | 2461 | 494 | 1462 | 1397 | 1436 | 1436 | 1436 |
| 2034                 | 809 | 1902 | 2447 | 482 | 1448 | 1380 | 1416 | 1416 | 1416 |
| 2035                 | 784 | 1869 | 2427 | 466 | 1426 | 1337 | 1389 | 1389 | 1389 |
| 2036                 | 762 | 1839 | 2409 | 433 | 1409 | 1306 | 1356 | 1356 | 1356 |
| 2037                 | 738 | 1811 | 2395 | 379 | 1383 | 1264 | 1328 | 1328 | 1328 |
| 2038                 | 714 | 1774 | 2363 | 256 | 1366 | 1214 | 1289 | 1289 | 1289 |
| 2039                 | 696 | 1752 | 2323 | 81  | 1345 | 1163 | 1264 | 1264 | 1264 |
| 2040                 | 523 | 1536 | 2281 | 11  | 1132 | 954  | 1061 | 1061 | 1061 |
| 2041                 | 291 | 1257 | 2238 | 11  | 867  | 704  | 807  | 807  | 807  |
| 2042                 | 151 | 1004 | 2194 | 11  | 635  | 497  | 583  | 583  | 583  |
| 2043                 | 60  | 807  | 1951 | 11  | 441  | 335  | 392  | 392  | 392  |
| 2044                 | 12  | 604  | 1684 | 11  | 279  | 186  | 247  | 247  | 247  |
| 2045                 | 12  | 432  | 1430 | 11  | 159  | 91   | 142  | 142  | 142  |
| 2046                 | 12  | 259  | 1178 | 11  | 80   | 34   | 70   | 70   | 70   |
| 2047                 | 12  | 151  | 931  | 11  | 33   | 9    | 24   | 24   | 24   |
| 2048                 | 12  | 87   | 738  | 11  | 6    | 0    | 5    | 5    | 5    |
| 2049                 | 12  | 40   | 578  | 11  | 6    | 0    | 5    | 5    | 5    |
| 2050                 | 12  | 10   | 413  | 11  | 6    | 0    | 5    | 5    | 5    |
| 2051                 | 12  | 0    | 275  | 11  | 6    | 0    | 5    | 5    | 5    |



| ScenarioID /<br>Year | 10 | 11 | 12  | 13 | 14 | 15 | 16 | 17 | 18 |
|----------------------|----|----|-----|----|----|----|----|----|----|
| 2052                 | 12 | 0  | 141 | 11 | 6  | 0  | 5  | 5  | 5  |
| 2053                 | 12 | 0  | 64  | 11 | 6  | 0  | 5  | 5  | 5  |
| 2054                 | 12 | 0  | 27  | 11 | 6  | 0  | 5  | 5  | 5  |
| 2055                 | 12 | 0  | 27  | 11 | 6  | 0  | 5  | 5  | 5  |
| 2056                 | 12 | 0  | 27  | 11 | 6  | 0  | 5  | 5  | 5  |
| 2057                 | 12 | 0  | 27  | 11 | 6  | 0  | 5  | 5  | 5  |
| 2058                 | 12 | 0  | 27  | 11 | 6  | 0  | 5  | 5  | 5  |
| 2059                 | 12 | 0  | 27  | 11 | 6  | 0  | 5  | 5  | 5  |
| 2060                 | 12 | 0  | 27  | 11 | 6  | 0  | 5  | 5  | 5  |
| 2061                 | 12 | 0  | 27  | 11 | 6  | 0  | 5  | 5  | 5  |
| 2062                 | 12 | 0  | 27  | 11 | 6  | 0  | 5  | 5  | 5  |
| 2063                 | 12 | 0  | 27  | 11 | 6  | 0  | 5  | 5  | 5  |
| 2064                 | 12 | 0  | 27  | 11 | 6  | 0  | 5  | 5  | 5  |
| 2065                 | 12 | 0  | 27  | 11 | 6  | 0  | 5  | 5  | 5  |
| 2066                 | 12 | 0  | 27  | 11 | 6  | 0  | 5  | 5  | 5  |
| 2067                 | 12 | 0  | 27  | 11 | 6  | 0  | 5  | 5  | 5  |
| 2068                 | 12 | 0  | 27  | 11 | 6  | 0  | 5  | 5  | 5  |
| 2069                 | 12 | 0  | 27  | 11 | 6  | 0  | 5  | 5  | 5  |
| 2070                 | 12 | 0  | 27  | 11 | 6  | 0  | 5  | 5  | 5  |
| 2071                 | 12 | 0  | 27  | 11 | 6  | 0  | 5  | 5  | 5  |
| 2072                 | 12 | 0  | 27  | 11 | 6  | 0  | 5  | 5  | 5  |
| 2073                 | 12 | 0  | 27  | 11 | 6  | 0  | 5  | 5  | 5  |
| 2074                 | 12 | 0  | 27  | 11 | 6  | 0  | 5  | 5  | 5  |
| 2075                 | 12 | 0  | 27  | 11 | 6  | 0  | 5  | 5  | 5  |
| 2076                 | 12 | 0  | 27  | 11 | 6  | 0  | 5  | 5  | 5  |
| 2077                 | 12 | 0  | 27  | 11 | 6  | 0  | 5  | 5  | 5  |
| 2078                 | 12 | 0  | 27  | 11 | 6  | 0  | 5  | 5  | 5  |
| 2079                 | 12 | 0  | 27  | 11 | 6  | 0  | 5  | 5  | 5  |
| 2080                 | 12 | 0  | 27  | 11 | 6  | 0  | 5  | 5  | 5  |
| 2081                 | 12 | 0  | 27  | 11 | 6  | 0  | 5  | 5  | 5  |
| 2082                 | 12 | 0  | 27  | 11 | 6  | 0  | 5  | 5  | 5  |
| 2083                 | 12 | 0  | 27  | 11 | 6  | 0  | 5  | 5  | 5  |
| 2084                 | 12 | 0  | 27  | 11 | 6  | 0  | 5  | 5  | 5  |
| 2085                 | 12 | 0  | 27  | 11 | 6  | 0  | 5  | 5  | 5  |
| 2086                 | 12 | 0  | 27  | 11 | 6  | 0  | 5  | 5  | 5  |
| 2087                 | 12 | 0  | 27  | 11 | 6  | 0  | 5  | 5  | 5  |
| 2088                 | 12 | 0  | 27  | 11 | 6  | 0  | 5  | 5  | 5  |
| 2089                 | 12 | 0  | 27  | 11 | 6  | 0  | 5  | 5  | 5  |
| 2090                 | 12 | 0  | 27  | 11 | 6  | 0  | 5  | 5  | 5  |

| ScenarioID /<br>Year | 19  | 20   | 21   | 22  | 23   | 24   | 25   | 26   | 27   |
|----------------------|-----|------|------|-----|------|------|------|------|------|
| 2002                 | 0   | 0    | 0    | 0   | 0    | 0    | 0    | 0    | 0    |
| 2003                 | 0   | 0    | 0    | 0   | 0    | 0    | 0    | 0    | 0    |
| 2004                 | 0   | 0    | 0    | 0   | 0    | 0    | 0    | 0    | 0    |
| 2005                 | 0   | 0    | 0    | 0   | 0    | 0    | 0    | 0    | 0    |
| 2006                 | 0   | 0    | 0    | 0   | 0    | 0    | 0    | 0    | 0    |
| 2007                 | 0   | 0    | 0    | 0   | 0    | 0    | 0    | 0    | 0    |
| 2008                 | 0   | 0    | 0    | 0   | 0    | 0    | 0    | 0    | 0    |
| 2009                 | 0   | 0    | 0    | 0   | 0    | 0    | 0    | 0    | 0    |
| 2010                 | 0   | 0    | 0    | 0   | 0    | 0    | 0    | 0    | 0    |
| 2011                 | 0   | 0    | 0    | 0   | 0    | 0    | 0    | 0    | 0    |
| 2012                 | 0   | 105  | 0    | 0   | 0    | 0    | 0    | 0    | 0    |
| 2013                 | 0   | 234  | 0    | 0   | 0    | 0    | 0    | 0    | 0    |
| 2014                 | 0   | 352  | 0    | 0   | 0    | 0    | 0    | 0    | 0    |
| 2015                 | 0   | 501  | 0    | 0   | 0    | 0    | 0    | 0    | 0    |
| 2016                 | 0   | 644  | 143  | 143 | 143  | 143  | 143  | 143  | 143  |
| 2017                 | 0   | 796  | 295  | 295 | 295  | 295  | 295  | 295  | 295  |
| 2018                 | 0   | 963  | 462  | 462 | 462  | 462  | 462  | 462  | 462  |
| 2019                 | 0   | 1136 | 635  | 635 | 635  | 635  | 635  | 635  | 635  |
| 2020                 | 173 | 1309 | 808  | 635 | 808  | 808  | 808  | 808  | 808  |
| 2021                 | 359 | 1495 | 994  | 630 | 994  | 994  | 994  | 994  | 994  |
| 2022                 | 525 | 1661 | 1160 | 629 | 1160 | 1160 | 1160 | 1160 | 1160 |
| 2023                 | 715 | 1851 | 1350 | 625 | 1350 | 1350 | 1350 | 1350 | 1350 |
| 2024                 | 914 | 2050 | 1549 | 617 | 1549 | 1549 | 1549 | 1549 | 1549 |
| 2025                 | 914 | 2050 | 1741 | 616 | 1549 | 1549 | 1549 | 1549 | 1549 |
| 2026                 | 912 | 2048 | 1924 | 614 | 1549 | 1544 | 1547 | 1547 | 1547 |
| 2027                 | 907 | 2043 | 2117 | 609 | 1547 | 1535 | 1542 | 1542 | 1542 |
| 2028                 | 903 | 2039 | 2311 | 609 | 1547 | 1530 | 1538 | 1538 | 1538 |
| 2029                 | 892 | 2023 | 2483 | 597 | 1537 | 1512 | 1522 | 1522 | 1522 |
| 2030                 | 891 | 2014 | 2483 | 585 | 1531 | 1500 | 1515 | 1515 | 1515 |
| 2031                 | 891 | 2006 | 2478 | 579 | 1525 | 1485 | 1507 | 1507 | 1507 |
| 2032                 | 887 | 2002 | 2474 | 559 | 1513 | 1466 | 1503 | 1503 | 1503 |
| 2033                 | 870 | 1982 | 2456 | 545 | 1504 | 1433 | 1486 | 1486 | 1486 |
| 2034                 | 863 | 1963 | 2439 | 534 | 1494 | 1418 | 1476 | 1476 | 1476 |
| 2035                 | 835 | 1935 | 2438 | 522 | 1485 | 1367 | 1451 | 1451 | 1451 |
| 2036                 | 820 | 1913 | 2434 | 512 | 1477 | 1344 | 1437 | 1437 | 1437 |
| 2037                 | 809 | 1897 | 2418 | 504 | 1474 | 1321 | 1421 | 1421 | 1421 |
| 2038                 | 787 | 1881 | 2406 | 313 | 1458 | 1284 | 1404 | 1404 | 1404 |
| 2039                 | 768 | 1849 | 2389 | 120 | 1441 | 1240 | 1370 | 1370 | 1370 |
| 2040                 | 581 | 1626 | 2371 | 26  | 1207 | 1027 | 1151 | 1151 | 1151 |
| 2041                 | 338 | 1350 | 2334 | 3   | 960  | 787  | 893  | 893  | 893  |
| 2042                 | 198 | 1093 | 2095 | 3   | 709  | 556  | 660  | 660  | 660  |
| 2043                 | 81  | 892  | 1827 | 3   | 532  | 382  | 480  | 480  | 480  |
| 2044                 | 24  | 681  | 1576 | 3   | 350  | 241  | 306  | 306  | 306  |
| 2045                 | 3   | 519  | 1340 | 3   | 196  | 131  | 171  | 171  | 171  |
| 2046                 | 0   | 350  | 1084 | 3   | 102  | 59   | 80   | 80   | 80   |
| 2047                 | 0   | 197  | 851  | 3   | 37   | 26   | 28   | 28   | 28   |
| 2048                 | 0   | 106  | 687  | 3   | 16   | 6    | 6    | 6    | 6    |
| 2049                 | 0   | 50   | 508  | 3   | 16   | 6    | 6    | 6    | 6    |
| 2050                 | 0   | 20   | 339  | 3   | 16   | 6    | 6    | 6    | 6    |
| 2051                 | 0   | 2    | 197  | 3   | 16   | 6    | 6    | 6    | 6    |

| ScenarioID /<br>Year | 19 | 20 | 21 | 22 | 23 | 24 | 25 | 26 | 27 |
|----------------------|----|----|----|----|----|----|----|----|----|
| 2052                 | 0  | 2  | 91 | 3  | 16 | 6  | 6  | 6  | 6  |
| 2053                 | 0  | 2  | 34 | 3  | 16 | 6  | 6  | 6  | 6  |
| 2054                 | 0  | 2  | 6  | 3  | 16 | 6  | 6  | 6  | 6  |
| 2055                 | 0  | 2  | 0  | 3  | 16 | 6  | 6  | 6  | 6  |
| 2056                 | 0  | 2  | 0  | 3  | 16 | 6  | 6  | 6  | 6  |
| 2057                 | 0  | 2  | 0  | 3  | 16 | 6  | 6  | 6  | 6  |
| 2058                 | 0  | 2  | 0  | 3  | 16 | 6  | 6  | 6  | 6  |
| 2059                 | 0  | 2  | 0  | 3  | 16 | 6  | 6  | 6  | 6  |
| 2060                 | 0  | 2  | 0  | 3  | 16 | 6  | 6  | 6  | 6  |
| 2061                 | 0  | 2  | 0  | 3  | 16 | 6  | 6  | 6  | 6  |
| 2062                 | 0  | 2  | 0  | 3  | 16 | 6  | 6  | 6  | 6  |
| 2063                 | 0  | 2  | 0  | 3  | 16 | 6  | 6  | 6  | 6  |
| 2064                 | 0  | 2  | 0  | 3  | 16 | 6  | 6  | 6  | 6  |
| 2065                 | 0  | 2  | 0  | 3  | 16 | 6  | 6  | 6  | 6  |
| 2066                 | 0  | 2  | 0  | 3  | 16 | 6  | 6  | 6  | 6  |
| 2067                 | 0  | 2  | 0  | 3  | 16 | 6  | 6  | 6  | 6  |
| 2068                 | 0  | 2  | 0  | 3  | 16 | 6  | 6  | 6  | 6  |
| 2069                 | 0  | 2  | 0  | 3  | 16 | 6  | 6  | 6  | 6  |
| 2070                 | 0  | 2  | 0  | 3  | 16 | 6  | 6  | 6  | 6  |
| 2071                 | 0  | 2  | 0  | 3  | 16 | 6  | 6  | 6  | 6  |
| 2072                 | 0  | 2  | 0  | 3  | 16 | 6  | 6  | 6  | 6  |
| 2073                 | 0  | 2  | 0  | 3  | 16 | 6  | 6  | 6  | 6  |
| 2074                 | 0  | 2  | 0  | 3  | 16 | 6  | 6  | 6  | 6  |
| 2075                 | 0  | 2  | 0  | 3  | 16 | 6  | 6  | 6  | 6  |
| 2076                 | 0  | 2  | 0  | 3  | 16 | 6  | 6  | 6  | 6  |
| 2077                 | 0  | 2  | 0  | 3  | 16 | 6  | 6  | 6  | 6  |
| 2078                 | 0  | 2  | 0  | 3  | 16 | 6  | 6  | 6  | 6  |
| 2079                 | 0  | 2  | 0  | 3  | 16 | 6  | 6  | 6  | 6  |
| 2080                 | 0  | 2  | 0  | 3  | 16 | 6  | 6  | 6  | 6  |
| 2081                 | 0  | 2  | 0  | 3  | 16 | 6  | 6  | 6  | 6  |
| 2082                 | 0  | 2  | 0  | 3  | 16 | 6  | 6  | 6  | 6  |
| 2083                 | 0  | 2  | 0  | 3  | 16 | 6  | 6  | 6  | 6  |
| 2084                 | 0  | 2  | 0  | 3  | 16 | 6  | 6  | 6  | 6  |
| 2085                 | 0  | 2  | 0  | 3  | 16 | 6  | 6  | 6  | 6  |
| 2086                 | 0  | 2  | 0  | 3  | 16 | 6  | 6  | 6  | 6  |
| 2087                 | 0  | 2  | 0  | 3  | 16 | 6  | 6  | 6  | 6  |
| 2088                 | 0  | 2  | 0  | 3  | 16 | 6  | 6  | 6  | 6  |
| 2089                 | 0  | 2  | 0  | 3  | 16 | 6  | 6  | 6  | 6  |
| 2090                 | 0  | 2  | 0  | 3  | 16 | 6  | 6  | 6  | 6  |

| ScenarioID / Year | 28  | 29   | 30   | 31  | 32   | 33   | 34   | 35   | 36   |
|-------------------|-----|------|------|-----|------|------|------|------|------|
| 2002              | 0   | 0    | 0    | 0   | 0    | 0    | 0    | 0    | 0    |
| 2003              | 0   | 0    | 0    | 0   | 0    | 0    | 0    | 0    | 0    |
| 2004              | 0   | 0    | 0    | 0   | 0    | 0    | 0    | 0    | 0    |
| 2005              | 0   | 0    | 0    | 0   | 0    | 0    | 0    | 0    | 0    |
| 2006              | 0   | 0    | 0    | 0   | 0    | 0    | 0    | 0    | 0    |
| 2007              | 0   | 0    | 0    | 0   | 0    | 0    | 0    | 0    | 0    |
| 2008              | 0   | 0    | 0    | 0   | 0    | 0    | 0    | 0    | 0    |
| 2009              | 0   | 0    | 0    | 0   | 0    | 0    | 0    | 0    | 0    |
| 2010              | 0   | 0    | 0    | 0   | 0    | 0    | 0    | 0    | 0    |
| 2011              | 0   | 0    | 0    | 0   | 0    | 0    | 0    | 0    | 0    |
| 2012              | 0   | 105  | 0    | 0   | 0    | 0    | 0    | 0    | 0    |
| 2013              | 0   | 234  | 0    | 0   | 0    | 0    | 0    | 0    | 0    |
| 2014              | 0   | 352  | 0    | 0   | 0    | 0    | 0    | 0    | 0    |
| 2015              | 0   | 501  | 0    | 0   | 0    | 0    | 0    | 0    | 0    |
| 2016              | 0   | 644  | 143  | 143 | 143  | 143  | 143  | 143  | 143  |
| 2017              | 0   | 796  | 295  | 295 | 295  | 295  | 295  | 295  | 295  |
| 2018              | 0   | 963  | 462  | 462 | 462  | 462  | 462  | 462  | 462  |
| 2019              | 0   | 1136 | 635  | 635 | 635  | 635  | 635  | 635  | 635  |
| 2020              | 173 | 1309 | 808  | 635 | 808  | 808  | 808  | 808  | 808  |
| 2021              | 359 | 1495 | 994  | 633 | 994  | 994  | 994  | 994  | 994  |
| 2022              | 525 | 1661 | 1160 | 632 | 1160 | 1160 | 1160 | 1160 | 1160 |
| 2023              | 715 | 1851 | 1350 | 627 | 1350 | 1350 | 1350 | 1350 | 1350 |
| 2024              | 914 | 2050 | 1549 | 626 | 1549 | 1549 | 1549 | 1549 | 1549 |
| 2025              | 907 | 2043 | 1741 | 619 | 1549 | 1520 | 1542 | 1542 | 1542 |
| 2026              | 902 | 2038 | 1924 | 598 | 1549 | 1497 | 1537 | 1537 | 1537 |
| 2027              | 892 | 2028 | 2117 | 582 | 1548 | 1470 | 1527 | 1527 | 1527 |
| 2028              | 884 | 2020 | 2311 | 542 | 1547 | 1454 | 1519 | 1519 | 1519 |
| 2029              | 878 | 2009 | 2483 | 499 | 1545 | 1429 | 1508 | 1508 | 1508 |
| 2030              | 871 | 1999 | 2476 | 490 | 1542 | 1383 | 1498 | 1498 | 1498 |
| 2031              | 855 | 1970 | 2461 | 486 | 1540 | 1301 | 1469 | 1469 | 1469 |
| 2032              | 814 | 1904 | 2442 | 459 | 1532 | 1219 | 1413 | 1413 | 1413 |
| 2033              | 758 | 1820 | 2418 | 447 | 1516 | 1171 | 1340 | 1340 | 1340 |
| 2034              | 709 | 1734 | 2391 | 441 | 1468 | 1129 | 1273 | 1273 | 1273 |
| 2035              | 685 | 1693 | 2378 | 439 | 1426 | 1114 | 1233 | 1233 | 1233 |
| 2036              | 646 | 1652 | 2353 | 416 | 1387 | 1074 | 1201 | 1201 | 1201 |
| 2037              | 627 | 1606 | 2314 | 405 | 1344 | 1045 | 1152 | 1152 | 1152 |
| 2038              | 608 | 1565 | 2235 | 391 | 1321 | 1004 | 1117 | 1117 | 1117 |
| 2039              | 599 | 1520 | 2107 | 384 | 1296 | 990  | 1087 | 1087 | 1087 |
| 2040              | 584 | 1471 | 2015 | 370 | 1281 | 972  | 1055 | 1055 | 1055 |
| 2041              | 575 | 1411 | 1939 | 358 | 1259 | 946  | 1006 | 1006 | 1006 |
| 2042              | 565 | 1348 | 1859 | 343 | 1241 | 879  | 988  | 988  | 988  |
| 2043              | 546 | 1295 | 1796 | 328 | 1212 | 841  | 959  | 959  | 959  |
| 2044              | 526 | 1257 | 1738 | 299 | 1188 | 785  | 935  | 935  | 935  |
| 2045              | 508 | 1236 | 1688 | 273 | 1166 | 732  | 923  | 923  | 923  |
| 2046              | 478 | 1222 | 1640 | 234 | 1155 | 681  | 901  | 901  | 901  |
| 2047              | 438 | 1177 | 1613 | 191 | 1141 | 628  | 860  | 860  | 860  |
| 2048              | 390 | 1109 | 1595 | 181 | 1122 | 594  | 787  | 787  | 787  |
| 2049              | 347 | 1021 | 1586 | 170 | 1087 | 558  | 711  | 711  | 711  |
| 2050              | 309 | 954  | 1563 | 157 | 1057 | 525  | 658  | 658  | 658  |
| 2051              | 291 | 895  | 1502 | 151 | 1026 | 504  | 615  | 615  | 615  |

| ScenarioID /<br>Year | 28  | 29  | 30   | 31  | 32  | 33  | 34  | 35  | 36  |
|----------------------|-----|-----|------|-----|-----|-----|-----|-----|-----|
| 2052                 | 270 | 832 | 1455 | 138 | 981 | 484 | 584 | 584 | 584 |
| 2053                 | 238 | 766 | 1395 | 117 | 949 | 478 | 541 | 541 | 541 |
| 2054                 | 198 | 688 | 1311 | 107 | 903 | 463 | 471 | 471 | 471 |
| 2055                 | 178 | 629 | 1215 | 72  | 830 | 445 | 413 | 413 | 413 |
| 2056                 | 160 | 555 | 1138 | 49  | 756 | 408 | 364 | 364 | 364 |
| 2057                 | 111 | 478 | 1040 | 38  | 676 | 364 | 304 | 304 | 304 |
| 2058                 | 79  | 385 | 927  | 29  | 554 | 279 | 226 | 226 | 226 |
| 2059                 | 64  | 281 | 810  | 25  | 403 | 182 | 157 | 157 | 157 |
| 2060                 | 53  | 207 | 649  | 15  | 294 | 137 | 140 | 140 | 140 |
| 2061                 | 53  | 156 | 517  | 14  | 205 | 110 | 120 | 120 | 120 |
| 2062                 | 53  | 137 | 410  | 14  | 144 | 88  | 104 | 104 | 104 |
| 2063                 | 53  | 117 | 323  | 7   | 123 | 82  | 91  | 91  | 91  |
| 2064                 | 53  | 104 | 264  | 0   | 113 | 81  | 90  | 90  | 90  |
| 2065                 | 41  | 89  | 231  | 0   | 109 | 71  | 84  | 84  | 84  |
| 2066                 | 13  | 70  | 205  | 0   | 101 | 55  | 59  | 59  | 59  |
| 2067                 | 3   | 48  | 190  | 0   | 66  | 26  | 30  | 30  | 30  |
| 2068                 | 0   | 17  | 169  | 0   | 33  | 4   | 10  | 10  | 10  |
| 2069                 | 0   | 0   | 142  | 0   | 10  | 0   | 0   | 0   | 0   |
| 2070                 | 0   | 0   | 105  | 0   | 0   | 0   | 0   | 0   | 0   |
| 2071                 | 0   | 0   | 66   | 0   | 0   | 0   | 0   | 0   | 0   |
| 2072                 | 0   | 0   | 36   | 0   | 0   | 0   | 0   | 0   | 0   |
| 2073                 | 0   | 0   | 14   | 0   | 0   | 0   | 0   | 0   | 0   |
| 2074                 | 0   | 0   | 1    | 0   | 0   | 0   | 0   | 0   | 0   |
| 2075                 | 0   | 0   | 0    | 0   | 0   | 0   | 0   | 0   | 0   |
| 2076                 | 0   | 0   | 0    | 0   | 0   | 0   | 0   | 0   | 0   |
| 2077                 | 0   | 0   | 0    | 0   | 0   | 0   | 0   | 0   | 0   |
| 2078                 | 0   | 0   | 0    | 0   | 0   | 0   | 0   | 0   | 0   |
| 2079                 | 0   | 0   | 0    | 0   | 0   | 0   | 0   | 0   | 0   |
| 2080                 | 0   | 0   | 0    | 0   | 0   | 0   | 0   | 0   | 0   |
| 2081                 | 0   | 0   | 0    | 0   | 0   | 0   | 0   | 0   | 0   |
| 2082                 | 0   | 0   | 0    | 0   | 0   | 0   | 0   | 0   | 0   |
| 2083                 | 0   | 0   | 0    | 0   | 0   | 0   | 0   | 0   | 0   |
| 2084                 | 0   | 0   | 0    | 0   | 0   | 0   | 0   | 0   | 0   |
| 2085                 | 0   | 0   | 0    | 0   | 0   | 0   | 0   | 0   | 0   |
| 2086                 | 0   | 0   | 0    | 0   | 0   | 0   | 0   | 0   | 0   |
| 2087                 | 0   | 0   | 0    | 0   | 0   | 0   | 0   | 0   | 0   |
| 2088                 | 0   | 0   | 0    | 0   | 0   | 0   | 0   | 0   | 0   |
| 2089                 | 0   | 0   | 0    | 0   | 0   | 0   | 0   | 0   | 0   |
| 2090                 | 0   | 0   | 0    | 0   | 0   | 0   | 0   | 0   | 0   |

| ScenarioID / Year | 37  | 38   | 39   | 40  | 41   | 42   | 43   | 44   | 45   |
|-------------------|-----|------|------|-----|------|------|------|------|------|
| 2002              | 0   | 0    | 0    | 0   | 0    | 0    | 0    | 0    | 0    |
| 2003              | 0   | 0    | 0    | 0   | 0    | 0    | 0    | 0    | 0    |
| 2004              | 0   | 0    | 0    | 0   | 0    | 0    | 0    | 0    | 0    |
| 2005              | 0   | 0    | 0    | 0   | 0    | 0    | 0    | 0    | 0    |
| 2006              | 0   | 0    | 0    | 0   | 0    | 0    | 0    | 0    | 0    |
| 2007              | 0   | 0    | 0    | 0   | 0    | 0    | 0    | 0    | 0    |
| 2008              | 0   | 0    | 0    | 0   | 0    | 0    | 0    | 0    | 0    |
| 2009              | 0   | 0    | 0    | 0   | 0    | 0    | 0    | 0    | 0    |
| 2010              | 0   | 0    | 0    | 0   | 0    | 0    | 0    | 0    | 0    |
| 2011              | 0   | 0    | 0    | 0   | 0    | 0    | 0    | 0    | 0    |
| 2012              | 0   | 105  | 0    | 0   | 0    | 0    | 0    | 0    | 0    |
| 2013              | 0   | 234  | 0    | 0   | 0    | 0    | 0    | 0    | 0    |
| 2014              | 0   | 352  | 0    | 0   | 0    | 0    | 0    | 0    | 0    |
| 2015              | 0   | 501  | 0    | 0   | 0    | 0    | 0    | 0    | 0    |
| 2016              | 0   | 644  | 143  | 143 | 143  | 143  | 143  | 143  | 143  |
| 2017              | 0   | 796  | 295  | 295 | 295  | 295  | 295  | 295  | 295  |
| 2018              | 0   | 963  | 462  | 462 | 462  | 462  | 462  | 462  | 462  |
| 2019              | 0   | 1136 | 635  | 635 | 635  | 635  | 635  | 635  | 635  |
| 2020              | 173 | 1309 | 808  | 626 | 808  | 808  | 808  | 808  | 808  |
| 2021              | 359 | 1495 | 994  | 621 | 994  | 994  | 994  | 994  | 994  |
| 2022              | 525 | 1661 | 1160 | 619 | 1160 | 1160 | 1160 | 1160 | 1160 |
| 2023              | 715 | 1851 | 1350 | 616 | 1350 | 1350 | 1350 | 1350 | 1350 |
| 2024              | 914 | 2050 | 1549 | 589 | 1549 | 1549 | 1549 | 1549 | 1549 |
| 2025              | 914 | 2050 | 1741 | 557 | 1549 | 1547 | 1549 | 1549 | 1549 |
| 2026              | 914 | 2050 | 1924 | 537 | 1549 | 1533 | 1549 | 1549 | 1549 |
| 2027              | 904 | 2040 | 2117 | 524 | 1544 | 1503 | 1539 | 1539 | 1539 |
| 2028              | 893 | 2026 | 2311 | 516 | 1530 | 1471 | 1525 | 1525 | 1525 |
| 2029              | 853 | 1967 | 2483 | 501 | 1491 | 1419 | 1478 | 1478 | 1478 |
| 2030              | 821 | 1926 | 2482 | 480 | 1438 | 1354 | 1437 | 1437 | 1437 |
| 2031              | 788 | 1858 | 2480 | 449 | 1384 | 1293 | 1372 | 1372 | 1372 |
| 2032              | 764 | 1779 | 2467 | 429 | 1333 | 1249 | 1309 | 1309 | 1309 |
| 2033              | 738 | 1730 | 2443 | 417 | 1306 | 1203 | 1285 | 1285 | 1285 |
| 2034              | 703 | 1687 | 2377 | 406 | 1291 | 1179 | 1238 | 1238 | 1238 |
| 2035              | 681 | 1650 | 2322 | 392 | 1262 | 1149 | 1204 | 1204 | 1204 |
| 2036              | 650 | 1590 | 2264 | 367 | 1230 | 1114 | 1159 | 1159 | 1159 |
| 2037              | 632 | 1539 | 2185 | 348 | 1188 | 1078 | 1126 | 1126 | 1126 |
| 2038              | 623 | 1483 | 2115 | 314 | 1156 | 1035 | 1084 | 1084 | 1084 |
| 2039              | 611 | 1438 | 2043 | 303 | 1127 | 984  | 1059 | 1059 | 1059 |
| 2040              | 587 | 1375 | 1983 | 289 | 1093 | 941  | 1021 | 1021 | 1021 |
| 2041              | 572 | 1344 | 1925 | 263 | 1062 | 885  | 997  | 997  | 997  |
| 2042              | 553 | 1314 | 1868 | 240 | 1041 | 815  | 975  | 975  | 975  |
| 2043              | 522 | 1280 | 1811 | 229 | 1024 | 766  | 941  | 941  | 941  |
| 2044              | 496 | 1244 | 1767 | 228 | 1008 | 699  | 898  | 898  | 898  |
| 2045              | 466 | 1186 | 1728 | 224 | 976  | 651  | 844  | 844  | 844  |
| 2046              | 439 | 1143 | 1696 | 206 | 956  | 614  | 795  | 795  | 795  |
| 2047              | 416 | 1096 | 1656 | 199 | 929  | 586  | 755  | 755  | 755  |
| 2048              | 387 | 1036 | 1598 | 197 | 899  | 565  | 731  | 731  | 731  |
| 2049              | 358 | 993  | 1544 | 192 | 869  | 544  | 696  | 696  | 696  |
| 2050              | 344 | 967  | 1510 | 182 | 824  | 513  | 672  | 672  | 672  |
| 2051              | 342 | 942  | 1474 | 182 | 795  | 495  | 647  | 647  | 647  |

| ScenarioID /<br>Year | 37  | 38  | 39   | 40  | 41  | 42  | 43  | 44  | 45  |
|----------------------|-----|-----|------|-----|-----|-----|-----|-----|-----|
| 2052                 | 332 | 914 | 1436 | 182 | 776 | 484 | 621 | 621 | 621 |
| 2053                 | 332 | 886 | 1368 | 182 | 754 | 473 | 603 | 603 | 603 |
| 2054                 | 331 | 865 | 1325 | 182 | 720 | 460 | 594 | 594 | 594 |
| 2055                 | 326 | 851 | 1298 | 182 | 692 | 450 | 584 | 584 | 584 |
| 2056                 | 326 | 841 | 1272 | 182 | 673 | 433 | 579 | 579 | 579 |
| 2057                 | 324 | 830 | 1233 | 182 | 653 | 405 | 564 | 564 | 564 |
| 2058                 | 305 | 800 | 1198 | 182 | 627 | 389 | 548 | 548 | 548 |
| 2059                 | 276 | 774 | 1174 | 172 | 588 | 360 | 526 | 526 | 526 |
| 2060                 | 238 | 733 | 1143 | 163 | 536 | 355 | 475 | 475 | 475 |
| 2061                 | 208 | 673 | 1113 | 156 | 470 | 355 | 415 | 415 | 415 |
| 2062                 | 200 | 631 | 1034 | 156 | 411 | 355 | 377 | 377 | 377 |
| 2063                 | 196 | 584 | 930  | 153 | 386 | 342 | 361 | 361 | 361 |
| 2064                 | 180 | 541 | 845  | 143 | 363 | 313 | 335 | 335 | 335 |
| 2065                 | 161 | 491 | 781  | 123 | 310 | 257 | 303 | 303 | 303 |
| 2066                 | 132 | 413 | 735  | 74  | 254 | 221 | 254 | 254 | 254 |
| 2067                 | 129 | 347 | 660  | 70  | 221 | 193 | 225 | 225 | 225 |
| 2068                 | 111 | 288 | 546  | 52  | 209 | 162 | 206 | 206 | 206 |
| 2069                 | 96  | 261 | 449  | 37  | 189 | 132 | 189 | 189 | 189 |
| 2070                 | 82  | 241 | 373  | 37  | 165 | 96  | 168 | 168 | 168 |
| 2071                 | 72  | 217 | 342  | 37  | 129 | 74  | 134 | 134 | 134 |
| 2072                 | 52  | 187 | 325  | 33  | 91  | 62  | 99  | 99  | 99  |
| 2073                 | 33  | 149 | 299  | 23  | 59  | 42  | 73  | 73  | 73  |
| 2074                 | 14  | 110 | 269  | 9   | 29  | 22  | 47  | 47  | 47  |
| 2075                 | 4   | 74  | 222  | 0   | 12  | 9   | 27  | 27  | 27  |
| 2076                 | 0   | 44  | 172  | 0   | 2   | 0   | 12  | 12  | 12  |
| 2077                 | 0   | 24  | 122  | 0   | 0   | 0   | 2   | 2   | 2   |
| 2078                 | 0   | 12  | 81   | 0   | 0   | 0   | 0   | 0   | 0   |
| 2079                 | 0   | 2   | 41   | 0   | 0   | 0   | 0   | 0   | 0   |
| 2080                 | 0   | 0   | 16   | 0   | 0   | 0   | 0   | 0   | 0   |
| 2081                 | 0   | 0   | 3    | 0   | 0   | 0   | 0   | 0   | 0   |
| 2082                 | 0   | 0   | 0    | 0   | 0   | 0   | 0   | 0   | 0   |
| 2083                 | 0   | 0   | 0    | 0   | 0   | 0   | 0   | 0   | 0   |
| 2084                 | 0   | 0   | 0    | 0   | 0   | 0   | 0   | 0   | 0   |
| 2085                 | 0   | 0   | 0    | 0   | 0   | 0   | 0   | 0   | 0   |
| 2086                 | 0   | 0   | 0    | 0   | 0   | 0   | 0   | 0   | 0   |
| 2087                 | 0   | 0   | 0    | 0   | 0   | 0   | 0   | 0   | 0   |
| 2088                 | 0   | 0   | 0    | 0   | 0   | 0   | 0   | 0   | 0   |
| 2089                 | 0   | 0   | 0    | 0   | 0   | 0   | 0   | 0   | 0   |
| 2090                 | 0   | 0   | 0    | 0   | 0   | 0   | 0   | 0   | 0   |

| ScenarioID /<br>Year | 46  | 47   | 48   | 49  | 50   | 51   | 52   | 53   | 54   |
|----------------------|-----|------|------|-----|------|------|------|------|------|
| 2002                 | 0   | 0    | 0    | 0   | 0    | 0    | 0    | 0    | 0    |
| 2003                 | 0   | 0    | 0    | 0   | 0    | 0    | 0    | 0    | 0    |
| 2004                 | 0   | 0    | 0    | 0   | 0    | 0    | 0    | 0    | 0    |
| 2005                 | 0   | 0    | 0    | 0   | 0    | 0    | 0    | 0    | 0    |
| 2006                 | 0   | 0    | 0    | 0   | 0    | 0    | 0    | 0    | 0    |
| 2007                 | 0   | 0    | 0    | 0   | 0    | 0    | 0    | 0    | 0    |
| 2008                 | 0   | 0    | 0    | 0   | 0    | 0    | 0    | 0    | 0    |
| 2009                 | 0   | 0    | 0    | 0   | 0    | 0    | 0    | 0    | 0    |
| 2010                 | 0   | 0    | 0    | 0   | 0    | 0    | 0    | 0    | 0    |
| 2011                 | 0   | 0    | 0    | 0   | 0    | 0    | 0    | 0    | 0    |
| 2012                 | 0   | 105  | 0    | 0   | 0    | 0    | 0    | 0    | 0    |
| 2013                 | 0   | 234  | 0    | 0   | 0    | 0    | 0    | 0    | 0    |
| 2014                 | 0   | 352  | 0    | 0   | 0    | 0    | 0    | 0    | 0    |
| 2015                 | 0   | 501  | 0    | 0   | 0    | 0    | 0    | 0    | 0    |
| 2016                 | 0   | 644  | 143  | 143 | 143  | 143  | 143  | 143  | 143  |
| 2017                 | 0   | 796  | 295  | 295 | 295  | 295  | 295  | 295  | 295  |
| 2018                 | 0   | 963  | 462  | 462 | 462  | 462  | 462  | 462  | 462  |
| 2019                 | 0   | 1136 | 635  | 635 | 635  | 635  | 635  | 635  | 635  |
| 2020                 | 173 | 1309 | 808  | 634 | 808  | 808  | 808  | 808  | 808  |
| 2021                 | 359 | 1495 | 994  | 629 | 994  | 994  | 994  | 994  | 994  |
| 2022                 | 525 | 1661 | 1160 | 629 | 1160 | 1160 | 1160 | 1160 | 1160 |
| 2023                 | 715 | 1851 | 1350 | 624 | 1350 | 1350 | 1350 | 1350 | 1350 |
| 2024                 | 914 | 2050 | 1549 | 615 | 1549 | 1549 | 1549 | 1549 | 1549 |
| 2025                 | 914 | 2050 | 1741 | 590 | 1549 | 1542 | 1549 | 1549 | 1549 |
| 2026                 | 912 | 2048 | 1924 | 552 | 1549 | 1529 | 1547 | 1547 | 1547 |
| 2027                 | 907 | 2043 | 2117 | 525 | 1547 | 1508 | 1542 | 1542 | 1542 |
| 2028                 | 896 | 2032 | 2311 | 518 | 1542 | 1478 | 1531 | 1531 | 1531 |
| 2029                 | 882 | 2007 | 2483 | 518 | 1524 | 1447 | 1511 | 1511 | 1511 |
| 2030                 | 854 | 1961 | 2483 | 512 | 1499 | 1402 | 1473 | 1473 | 1473 |
| 2031                 | 815 | 1898 | 2478 | 504 | 1455 | 1350 | 1416 | 1416 | 1416 |
| 2032                 | 781 | 1819 | 2471 | 479 | 1381 | 1299 | 1348 | 1348 | 1348 |
| 2033                 | 772 | 1749 | 2454 | 454 | 1338 | 1248 | 1304 | 1304 | 1304 |
| 2034                 | 763 | 1715 | 2430 | 438 | 1318 | 1224 | 1296 | 1296 | 1296 |
| 2035                 | 748 | 1698 | 2398 | 425 | 1313 | 1203 | 1285 | 1285 | 1285 |
| 2036                 | 716 | 1668 | 2344 | 400 | 1301 | 1158 | 1255 | 1255 | 1255 |
| 2037                 | 692 | 1622 | 2266 | 381 | 1267 | 1122 | 1210 | 1210 | 1210 |
| 2038                 | 669 | 1587 | 2182 | 372 | 1221 | 1085 | 1172 | 1172 | 1172 |
| 2039                 | 653 | 1545 | 2121 | 359 | 1189 | 1045 | 1137 | 1137 | 1137 |
| 2040                 | 635 | 1497 | 2072 | 359 | 1171 | 1013 | 1102 | 1102 | 1102 |
| 2041                 | 609 | 1442 | 2005 | 350 | 1156 | 977  | 1063 | 1063 | 1063 |
| 2042                 | 590 | 1400 | 1936 | 323 | 1141 | 929  | 1039 | 1039 | 1039 |
| 2043                 | 584 | 1367 | 1881 | 293 | 1123 | 879  | 1014 | 1014 | 1014 |
| 2044                 | 565 | 1337 | 1838 | 276 | 1106 | 842  | 991  | 991  | 991  |
| 2045                 | 534 | 1297 | 1798 | 257 | 1091 | 794  | 948  | 948  | 948  |
| 2046                 | 519 | 1243 | 1769 | 237 | 1073 | 753  | 901  | 901  | 901  |
| 2047                 | 495 | 1182 | 1726 | 228 | 1041 | 703  | 860  | 860  | 860  |
| 2048                 | 456 | 1108 | 1677 | 228 | 978  | 666  | 808  | 808  | 808  |
| 2049                 | 432 | 1058 | 1644 | 220 | 906  | 616  | 778  | 778  | 778  |
| 2050                 | 409 | 1008 | 1588 | 212 | 855  | 563  | 751  | 751  | 751  |
| 2051                 | 391 | 975  | 1539 | 193 | 828  | 528  | 723  | 723  | 723  |



| ScenarioID /<br>Year | 46  | 47  | 48   | 49  | 50  | 51  | 52  | 53  | 54  |
|----------------------|-----|-----|------|-----|-----|-----|-----|-----|-----|
| 2052                 | 367 | 953 | 1477 | 185 | 812 | 514 | 699 | 699 | 699 |
| 2053                 | 350 | 914 | 1422 | 185 | 802 | 502 | 665 | 665 | 665 |
| 2054                 | 327 | 874 | 1369 | 185 | 780 | 480 | 635 | 635 | 635 |
| 2055                 | 320 | 827 | 1316 | 185 | 742 | 459 | 600 | 600 | 600 |
| 2056                 | 304 | 782 | 1273 | 182 | 674 | 433 | 575 | 575 | 575 |
| 2057                 | 291 | 720 | 1246 | 133 | 604 | 406 | 542 | 542 | 542 |
| 2058                 | 271 | 670 | 1183 | 102 | 555 | 346 | 517 | 517 | 517 |
| 2059                 | 225 | 613 | 1100 | 95  | 506 | 285 | 453 | 453 | 453 |
| 2060                 | 165 | 538 | 1006 | 95  | 460 | 247 | 379 | 379 | 379 |
| 2061                 | 132 | 452 | 929  | 91  | 387 | 224 | 305 | 305 | 305 |
| 2062                 | 122 | 368 | 859  | 73  | 296 | 212 | 250 | 250 | 250 |
| 2063                 | 121 | 303 | 774  | 42  | 235 | 202 | 218 | 218 | 218 |
| 2064                 | 117 | 273 | 648  | 22  | 217 | 180 | 216 | 216 | 216 |
| 2065                 | 98  | 270 | 518  | 10  | 216 | 149 | 205 | 205 | 205 |
| 2066                 | 67  | 246 | 418  | 0   | 212 | 102 | 180 | 180 | 180 |
| 2067                 | 39  | 212 | 352  | 0   | 193 | 62  | 150 | 150 | 150 |
| 2068                 | 14  | 172 | 332  | 0   | 155 | 29  | 112 | 112 | 112 |
| 2069                 | 4   | 124 | 312  | 0   | 115 | 7   | 74  | 74  | 74  |
| 2070                 | 0   | 84  | 280  | 0   | 68  | 0   | 44  | 44  | 44  |
| 2071                 | 0   | 54  | 240  | 0   | 28  | 0   | 23  | 23  | 23  |
| 2072                 | 0   | 34  | 191  | 0   | 12  | 0   | 3   | 3   | 3   |
| 2073                 | 0   | 14  | 141  | 0   | 2   | 0   | 0   | 0   | 0   |
| 2074                 | 0   | 2   | 91   | 0   | 0   | 0   | 0   | 0   | 0   |
| 2075                 | 0   | 0   | 51   | 0   | 0   | 0   | 0   | 0   | 0   |
| 2076                 | 0   | 0   | 21   | 0   | 0   | 0   | 0   | 0   | 0   |
| 2077                 | 0   | 0   | 3    | 0   | 0   | 0   | 0   | 0   | 0   |
| 2078                 | 0   | 0   | 0    | 0   | 0   | 0   | 0   | 0   | 0   |
| 2079                 | 0   | 0   | 0    | 0   | 0   | 0   | 0   | 0   | 0   |
| 2080                 | 0   | 0   | 0    | 0   | 0   | 0   | 0   | 0   | 0   |
| 2081                 | 0   | 0   | 0    | 0   | 0   | 0   | 0   | 0   | 0   |
| 2082                 | 0   | 0   | 0    | 0   | 0   | 0   | 0   | 0   | 0   |
| 2083                 | 0   | 0   | 0    | 0   | 0   | 0   | 0   | 0   | 0   |
| 2084                 | 0   | 0   | 0    | 0   | 0   | 0   | 0   | 0   | 0   |
| 2085                 | 0   | 0   | 0    | 0   | 0   | 0   | 0   | 0   | 0   |
| 2086                 | 0   | 0   | 0    | 0   | 0   | 0   | 0   | 0   | 0   |
| 2087                 | 0   | 0   | 0    | 0   | 0   | 0   | 0   | 0   | 0   |
| 2088                 | 0   | 0   | 0    | 0   | 0   | 0   | 0   | 0   | 0   |
| 2089                 | 0   | 0   | 0    | 0   | 0   | 0   | 0   | 0   | 0   |
| 2090                 | 0   | 0   | 0    | 0   | 0   | 0   | 0   | 0   | 0   |

| ScenarioID /<br>Year | 55  | 56   | 57   | 58  | 59   | 60   | 61   | 62   | 63   |
|----------------------|-----|------|------|-----|------|------|------|------|------|
| 2002                 | 0   | 0    | 0    | 0   | 0    | 0    | 0    | 0    | 0    |
| 2003                 | 0   | 0    | 0    | 0   | 0    | 0    | 0    | 0    | 0    |
| 2004                 | 0   | 0    | 0    | 0   | 0    | 0    | 0    | 0    | 0    |
| 2005                 | 0   | 0    | 0    | 0   | 0    | 0    | 0    | 0    | 0    |
| 2006                 | 0   | 0    | 0    | 0   | 0    | 0    | 0    | 0    | 0    |
| 2007                 | 0   | 0    | 0    | 0   | 0    | 0    | 0    | 0    | 0    |
| 2008                 | 0   | 0    | 0    | 0   | 0    | 0    | 0    | 0    | 0    |
| 2009                 | 0   | 0    | 0    | 0   | 0    | 0    | 0    | 0    | 0    |
| 2010                 | 0   | 0    | 0    | 0   | 0    | 0    | 0    | 0    | 0    |
| 2011                 | 0   | 0    | 0    | 0   | 0    | 0    | 0    | 0    | 0    |
| 2012                 | 0   | 105  | 0    | 0   | 0    | 0    | 0    | 0    | 0    |
| 2013                 | 0   | 234  | 0    | 0   | 0    | 0    | 0    | 0    | 0    |
| 2014                 | 0   | 352  | 0    | 0   | 0    | 0    | 0    | 0    | 0    |
| 2015                 | 0   | 501  | 0    | 0   | 0    | 0    | 0    | 0    | 0    |
| 2016                 | 0   | 644  | 143  | 143 | 143  | 143  | 143  | 143  | 143  |
| 2017                 | 0   | 796  | 295  | 295 | 295  | 295  | 295  | 295  | 295  |
| 2018                 | 0   | 963  | 462  | 462 | 462  | 462  | 462  | 462  | 462  |
| 2019                 | 0   | 1136 | 635  | 635 | 635  | 635  | 635  | 635  | 635  |
| 2020                 | 173 | 1309 | 808  | 635 | 808  | 808  | 808  | 808  | 808  |
| 2021                 | 359 | 1495 | 994  | 627 | 994  | 994  | 994  | 994  | 994  |
| 2022                 | 525 | 1661 | 1160 | 618 | 1160 | 1160 | 1160 | 1160 | 1160 |
| 2023                 | 715 | 1851 | 1350 | 618 | 1350 | 1350 | 1350 | 1350 | 1350 |
| 2024                 | 914 | 2050 | 1549 | 612 | 1549 | 1549 | 1549 | 1549 | 1549 |
| 2025                 | 914 | 2050 | 1741 | 598 | 1549 | 1549 | 1549 | 1549 | 1549 |
| 2026                 | 913 | 2049 | 1924 | 597 | 1545 | 1535 | 1548 | 1548 | 1548 |
| 2027                 | 894 | 2030 | 2117 | 590 | 1545 | 1535 | 1529 | 1529 | 1529 |
| 2028                 | 883 | 2019 | 2311 | 585 | 1541 | 1527 | 1518 | 1518 | 1518 |
| 2029                 | 874 | 2010 | 2483 | 567 | 1538 | 1508 | 1509 | 1509 | 1509 |
| 2030                 | 859 | 1995 | 2483 | 555 | 1534 | 1497 | 1494 | 1494 | 1494 |
| 2031                 | 846 | 1982 | 2476 | 544 | 1525 | 1477 | 1481 | 1481 | 1481 |
| 2032                 | 833 | 1965 | 2461 | 527 | 1505 | 1427 | 1464 | 1464 | 1464 |
| 2033                 | 824 | 1949 | 2450 | 523 | 1497 | 1400 | 1455 | 1455 | 1455 |
| 2034                 | 818 | 1944 | 2445 | 511 | 1487 | 1375 | 1450 | 1450 | 1450 |
| 2035                 | 797 | 1921 | 2428 | 491 | 1475 | 1323 | 1424 | 1424 | 1424 |
| 2036                 | 786 | 1909 | 2402 | 473 | 1471 | 1298 | 1412 | 1412 | 1412 |
| 2037                 | 778 | 1888 | 2370 | 452 | 1464 | 1229 | 1391 | 1391 | 1391 |
| 2038                 | 761 | 1858 | 2360 | 449 | 1457 | 1175 | 1367 | 1367 | 1367 |
| 2039                 | 735 | 1823 | 2345 | 419 | 1451 | 1155 | 1342 | 1342 | 1342 |
| 2040                 | 719 | 1794 | 2331 | 402 | 1437 | 1131 | 1318 | 1318 | 1318 |
| 2041                 | 690 | 1755 | 2326 | 267 | 1424 | 1103 | 1267 | 1267 | 1267 |
| 2042                 | 489 | 1668 | 2269 | 81  | 1186 | 1080 | 1213 | 1213 | 1213 |
| 2043                 | 231 | 1469 | 2213 | 70  | 896  | 851  | 1001 | 1001 | 1001 |
| 2044                 | 166 | 1208 | 1928 | 11  | 679  | 601  | 766  | 766  | 766  |
| 2045                 | 40  | 991  | 1639 | 9   | 510  | 441  | 582  | 582  | 582  |
| 2046                 | 39  | 797  | 1393 | 9   | 312  | 230  | 368  | 368  | 368  |
| 2047                 | 13  | 568  | 1178 | 9   | 130  | 99   | 178  | 178  | 178  |
| 2048                 | 3   | 361  | 950  | 9   | 85   | 59   | 98   | 98   | 98   |
| 2049                 | 3   | 209  | 753  | 9   | 35   | 14   | 40   | 40   | 40   |
| 2050                 | 3   | 115  | 529  | 9   | 12   | 8    | 18   | 18   | 18   |
| 2051                 | 3   | 62   | 332  | 9   | 1    | 4    | 8    | 8    | 8    |

| ScenarioID /<br>Year | 55 | 56 | 57  | 58 | 59 | 60 | 61 | 62 | 63 |
|----------------------|----|----|-----|----|----|----|----|----|----|
| 2052                 | 3  | 32 | 203 | 9  | 1  | 3  | 8  | 8  | 8  |
| 2053                 | 3  | 12 | 109 | 9  | 1  | 3  | 8  | 8  | 8  |
| 2054                 | 3  | 0  | 54  | 9  | 1  | 3  | 8  | 8  | 8  |
| 2055                 | 3  | 0  | 16  | 9  | 1  | 3  | 8  | 8  | 8  |
| 2056                 | 3  | 0  | 0   | 9  | 1  | 3  | 8  | 8  | 8  |
| 2057                 | 3  | 0  | 0   | 9  | 1  | 3  | 8  | 8  | 8  |
| 2058                 | 3  | 0  | 0   | 9  | 1  | 3  | 8  | 8  | 8  |
| 2059                 | 3  | 0  | 0   | 9  | 1  | 3  | 8  | 8  | 8  |
| 2060                 | 3  | 0  | 0   | 9  | 1  | 3  | 8  | 8  | 8  |
| 2061                 | 3  | 0  | 0   | 9  | 1  | 3  | 8  | 8  | 8  |
| 2062                 | 3  | 0  | 0   | 9  | 1  | 3  | 8  | 8  | 8  |
| 2063                 | 3  | 0  | 0   | 9  | 1  | 3  | 8  | 8  | 8  |
| 2064                 | 3  | 0  | 0   | 9  | 1  | 3  | 8  | 8  | 8  |
| 2065                 | 3  | 0  | 0   | 9  | 1  | 3  | 8  | 8  | 8  |
| 2066                 | 3  | 0  | 0   | 9  | 1  | 3  | 8  | 8  | 8  |
| 2067                 | 3  | 0  | 0   | 9  | 1  | 3  | 8  | 8  | 8  |
| 2068                 | 3  | 0  | 0   | 9  | 1  | 3  | 8  | 8  | 8  |
| 2069                 | 3  | 0  | 0   | 9  | 1  | 3  | 8  | 8  | 8  |
| 2070                 | 3  | 0  | 0   | 9  | 1  | 3  | 8  | 8  | 8  |
| 2071                 | 3  | 0  | 0   | 9  | 1  | 3  | 8  | 8  | 8  |
| 2072                 | 3  | 0  | 0   | 9  | 1  | 3  | 8  | 8  | 8  |
| 2073                 | 3  | 0  | 0   | 9  | 1  | 3  | 8  | 8  | 8  |
| 2074                 | 3  | 0  | 0   | 9  | 1  | 3  | 8  | 8  | 8  |
| 2075                 | 3  | 0  | 0   | 9  | 1  | 3  | 8  | 8  | 8  |
| 2076                 | 3  | 0  | 0   | 9  | 1  | 3  | 8  | 8  | 8  |
| 2077                 | 3  | 0  | 0   | 9  | 1  | 3  | 8  | 8  | 8  |
| 2078                 | 3  | 0  | 0   | 9  | 1  | 3  | 8  | 8  | 8  |
| 2079                 | 3  | 0  | 0   | 9  | 1  | 3  | 8  | 8  | 8  |
| 2080                 | 3  | 0  | 0   | 9  | 1  | 3  | 8  | 8  | 8  |
| 2081                 | 3  | 0  | 0   | 9  | 1  | 3  | 8  | 8  | 8  |
| 2082                 | 3  | 0  | 0   | 9  | 1  | 3  | 8  | 8  | 8  |
| 2083                 | 3  | 0  | 0   | 9  | 1  | 3  | 8  | 8  | 8  |
| 2084                 | 3  | 0  | 0   | 9  | 1  | 3  | 8  | 8  | 8  |
| 2085                 | 3  | 0  | 0   | 9  | 1  | 3  | 8  | 8  | 8  |
| 2086                 | 3  | 0  | 0   | 9  | 1  | 3  | 8  | 8  | 8  |
| 2087                 | 3  | 0  | 0   | 9  | 1  | 3  | 8  | 8  | 8  |
| 2088                 | 3  | 0  | 0   | 9  | 1  | 3  | 8  | 8  | 8  |
| 2089                 | 3  | 0  | 0   | 9  | 1  | 3  | 8  | 8  | 8  |
| 2090                 | 3  | 0  | 0   | 9  | 1  | 3  | 8  | 8  | 8  |

| ScenarioID /<br>Year | 64  | 65   | 66   | 67  | 68   | 69   | 70   | 71   | 72   |
|----------------------|-----|------|------|-----|------|------|------|------|------|
| 2002                 | 0   | 0    | 0    | 0   | 0    | 0    | 0    | 0    | 0    |
| 2003                 | 0   | 0    | 0    | 0   | 0    | 0    | 0    | 0    | 0    |
| 2004                 | 0   | 0    | 0    | 0   | 0    | 0    | 0    | 0    | 0    |
| 2005                 | 0   | 0    | 0    | 0   | 0    | 0    | 0    | 0    | 0    |
| 2006                 | 0   | 0    | 0    | 0   | 0    | 0    | 0    | 0    | 0    |
| 2007                 | 0   | 0    | 0    | 0   | 0    | 0    | 0    | 0    | 0    |
| 2008                 | 0   | 0    | 0    | 0   | 0    | 0    | 0    | 0    | 0    |
| 2009                 | 0   | 0    | 0    | 0   | 0    | 0    | 0    | 0    | 0    |
| 2010                 | 0   | 0    | 0    | 0   | 0    | 0    | 0    | 0    | 0    |
| 2011                 | 0   | 0    | 0    | 0   | 0    | 0    | 0    | 0    | 0    |
| 2012                 | 0   | 105  | 0    | 0   | 0    | 0    | 0    | 0    | 0    |
| 2013                 | 0   | 234  | 0    | 0   | 0    | 0    | 0    | 0    | 0    |
| 2014                 | 0   | 352  | 0    | 0   | 0    | 0    | 0    | 0    | 0    |
| 2015                 | 0   | 501  | 0    | 0   | 0    | 0    | 0    | 0    | 0    |
| 2016                 | 0   | 644  | 143  | 143 | 143  | 143  | 143  | 143  | 143  |
| 2017                 | 0   | 796  | 295  | 295 | 295  | 295  | 295  | 295  | 295  |
| 2018                 | 0   | 963  | 462  | 462 | 462  | 462  | 462  | 462  | 462  |
| 2019                 | 0   | 1136 | 635  | 635 | 635  | 635  | 635  | 635  | 635  |
| 2020                 | 173 | 1309 | 808  | 635 | 808  | 808  | 808  | 808  | 808  |
| 2021                 | 359 | 1495 | 994  | 631 | 994  | 994  | 994  | 994  | 994  |
| 2022                 | 525 | 1661 | 1160 | 626 | 1160 | 1160 | 1160 | 1160 | 1160 |
| 2023                 | 715 | 1851 | 1350 | 626 | 1350 | 1350 | 1350 | 1350 | 1350 |
| 2024                 | 914 | 2050 | 1549 | 611 | 1549 | 1549 | 1549 | 1549 | 1549 |
| 2025                 | 914 | 2050 | 1741 | 608 | 1549 | 1549 | 1549 | 1549 | 1549 |
| 2026                 | 913 | 2049 | 1924 | 599 | 1549 | 1544 | 1548 | 1548 | 1548 |
| 2027                 | 911 | 2047 | 2117 | 594 | 1549 | 1534 | 1546 | 1546 | 1546 |
| 2028                 | 905 | 2041 | 2311 | 577 | 1545 | 1521 | 1540 | 1540 | 1540 |
| 2029                 | 893 | 2029 | 2483 | 570 | 1540 | 1511 | 1528 | 1528 | 1528 |
| 2030                 | 891 | 2027 | 2483 | 562 | 1539 | 1493 | 1526 | 1526 | 1526 |
| 2031                 | 882 | 2018 | 2478 | 548 | 1529 | 1472 | 1517 | 1517 | 1517 |
| 2032                 | 864 | 1995 | 2466 | 536 | 1521 | 1453 | 1494 | 1494 | 1494 |
| 2033                 | 854 | 1977 | 2466 | 528 | 1512 | 1434 | 1483 | 1483 | 1483 |
| 2034                 | 847 | 1970 | 2453 | 516 | 1500 | 1414 | 1475 | 1475 | 1475 |
| 2035                 | 827 | 1949 | 2439 | 515 | 1494 | 1384 | 1454 | 1454 | 1454 |
| 2036                 | 803 | 1919 | 2428 | 508 | 1484 | 1364 | 1427 | 1427 | 1427 |
| 2037                 | 797 | 1895 | 2409 | 493 | 1463 | 1323 | 1404 | 1404 | 1404 |
| 2038                 | 785 | 1876 | 2397 | 490 | 1452 | 1284 | 1381 | 1381 | 1381 |
| 2039                 | 778 | 1857 | 2385 | 482 | 1452 | 1256 | 1362 | 1362 | 1362 |
| 2040                 | 761 | 1819 | 2365 | 469 | 1444 | 1243 | 1330 | 1330 | 1330 |
| 2041                 | 752 | 1795 | 2361 | 339 | 1439 | 1231 | 1322 | 1322 | 1322 |
| 2042                 | 735 | 1744 | 2309 | 127 | 1216 | 1221 | 1300 | 1300 | 1300 |
| 2043                 | 547 | 1526 | 2300 | 91  | 921  | 1020 | 1083 | 1083 | 1083 |
| 2044                 | 358 | 1248 | 2024 | 33  | 700  | 752  | 836  | 836  | 836  |
| 2045                 | 191 | 1017 | 1747 | 32  | 515  | 569  | 638  | 638  | 638  |
| 2046                 | 132 | 798  | 1499 | 32  | 331  | 352  | 436  | 436  | 436  |
| 2047                 | 42  | 599  | 1283 | 32  | 154  | 163  | 245  | 245  | 245  |
| 2048                 | 28  | 394  | 1067 | 32  | 91   | 102  | 119  | 119  | 119  |
| 2049                 | 4   | 221  | 840  | 32  | 39   | 50   | 61   | 61   | 61   |
| 2050                 | 4   | 121  | 630  | 32  | 14   | 20   | 23   | 23   | 23   |
| 2051                 | 4   | 77   | 409  | 32  | 0    | 1    | 1    | 1    | 1    |

| ScenarioID /<br>Year | 64 | 65 | 66  | 67 | 68 | 69 | 70 | 71 | 72 |
|----------------------|----|----|-----|----|----|----|----|----|----|
| 2052                 | 4  | 47 | 257 | 32 | 0  | 1  | 1  | 1  | 1  |
| 2053                 | 4  | 17 | 149 | 32 | 0  | 1  | 1  | 1  | 1  |
| 2054                 | 4  | 1  | 65  | 32 | 0  | 1  | 1  | 1  | 1  |
| 2055                 | 4  | 1  | 31  | 32 | 0  | 1  | 1  | 1  | 1  |
| 2056                 | 4  | 1  | 17  | 32 | 0  | 1  | 1  | 1  | 1  |
| 2057                 | 4  | 1  | 7   | 32 | 0  | 1  | 1  | 1  | 1  |
| 2058                 | 4  | 1  | 7   | 32 | 0  | 1  | 1  | 1  | 1  |
| 2059                 | 4  | 1  | 7   | 32 | 0  | 1  | 1  | 1  | 1  |
| 2060                 | 4  | 1  | 7   | 32 | 0  | 1  | 1  | 1  | 1  |
| 2061                 | 4  | 1  | 7   | 32 | 0  | 1  | 1  | 1  | 1  |
| 2062                 | 4  | 1  | 7   | 32 | 0  | 1  | 1  | 1  | 1  |
| 2063                 | 4  | 1  | 7   | 32 | 0  | 1  | 1  | 1  | 1  |
| 2064                 | 4  | 1  | 7   | 32 | 0  | 1  | 1  | 1  | 1  |
| 2065                 | 4  | 1  | 7   | 32 | 0  | 1  | 1  | 1  | 1  |
| 2066                 | 4  | 1  | 7   | 32 | 0  | 1  | 1  | 1  | 1  |
| 2067                 | 4  | 1  | 7   | 32 | 0  | 1  | 1  | 1  | 1  |
| 2068                 | 4  | 1  | 7   | 32 | 0  | 1  | 1  | 1  | 1  |
| 2069                 | 4  | 1  | 7   | 32 | 0  | 1  | 1  | 1  | 1  |
| 2070                 | 4  | 1  | 7   | 32 | 0  | 1  | 1  | 1  | 1  |
| 2071                 | 4  | 1  | 7   | 32 | 0  | 1  | 1  | 1  | 1  |
| 2072                 | 4  | 1  | 7   | 32 | 0  | 1  | 1  | 1  | 1  |
| 2073                 | 4  | 1  | 7   | 32 | 0  | 1  | 1  | 1  | 1  |
| 2074                 | 4  | 1  | 7   | 32 | 0  | 1  | 1  | 1  | 1  |
| 2075                 | 4  | 1  | 7   | 32 | 0  | 1  | 1  | 1  | 1  |
| 2076                 | 4  | 1  | 7   | 32 | 0  | 1  | 1  | 1  | 1  |
| 2077                 | 4  | 1  | 7   | 32 | 0  | 1  | 1  | 1  | 1  |
| 2078                 | 4  | 1  | 7   | 32 | 0  | 1  | 1  | 1  | 1  |
| 2079                 | 4  | 1  | 7   | 32 | 0  | 1  | 1  | 1  | 1  |
| 2080                 | 4  | 1  | 7   | 32 | 0  | 1  | 1  | 1  | 1  |
| 2081                 | 4  | 1  | 7   | 32 | 0  | 1  | 1  | 1  | 1  |
| 2082                 | 4  | 1  | 7   | 32 | 0  | 1  | 1  | 1  | 1  |
| 2083                 | 4  | 1  | 7   | 32 | 0  | 1  | 1  | 1  | 1  |
| 2084                 | 4  | 1  | 7   | 32 | 0  | 1  | 1  | 1  | 1  |
| 2085                 | 4  | 1  | 7   | 32 | 0  | 1  | 1  | 1  | 1  |
| 2086                 | 4  | 1  | 7   | 32 | 0  | 1  | 1  | 1  | 1  |
| 2087                 | 4  | 1  | 7   | 32 | 0  | 1  | 1  | 1  | 1  |
| 2088                 | 4  | 1  | 7   | 32 | 0  | 1  | 1  | 1  | 1  |
| 2089                 | 4  | 1  | 7   | 32 | 0  | 1  | 1  | 1  | 1  |
| 2090                 | 4  | 1  | 7   | 32 | 0  | 1  | 1  | 1  | 1  |

| ScenarioID /<br>Year | 73  | 74   | 75   | 76  | 77   | 78   | 79   | 80   | 81   |
|----------------------|-----|------|------|-----|------|------|------|------|------|
| 2002                 | 0   | 0    | 0    | 0   | 0    | 0    | 0    | 0    | 0    |
| 2003                 | 0   | 0    | 0    | 0   | 0    | 0    | 0    | 0    | 0    |
| 2004                 | 0   | 0    | 0    | 0   | 0    | 0    | 0    | 0    | 0    |
| 2005                 | 0   | 0    | 0    | 0   | 0    | 0    | 0    | 0    | 0    |
| 2006                 | 0   | 0    | 0    | 0   | 0    | 0    | 0    | 0    | 0    |
| 2007                 | 0   | 0    | 0    | 0   | 0    | 0    | 0    | 0    | 0    |
| 2008                 | 0   | 0    | 0    | 0   | 0    | 0    | 0    | 0    | 0    |
| 2009                 | 0   | 0    | 0    | 0   | 0    | 0    | 0    | 0    | 0    |
| 2010                 | 0   | 0    | 0    | 0   | 0    | 0    | 0    | 0    | 0    |
| 2011                 | 0   | 0    | 0    | 0   | 0    | 0    | 0    | 0    | 0    |
| 2012                 | 0   | 105  | 0    | 0   | 0    | 0    | 0    | 0    | 0    |
| 2013                 | 0   | 234  | 0    | 0   | 0    | 0    | 0    | 0    | 0    |
| 2014                 | 0   | 352  | 0    | 0   | 0    | 0    | 0    | 0    | 0    |
| 2015                 | 0   | 501  | 0    | 0   | 0    | 0    | 0    | 0    | 0    |
| 2016                 | 0   | 644  | 143  | 143 | 143  | 143  | 143  | 143  | 143  |
| 2017                 | 0   | 796  | 295  | 295 | 295  | 295  | 295  | 295  | 295  |
| 2018                 | 0   | 963  | 462  | 462 | 462  | 462  | 462  | 462  | 462  |
| 2019                 | 0   | 1136 | 635  | 635 | 635  | 635  | 635  | 635  | 635  |
| 2020                 | 173 | 1309 | 808  | 635 | 808  | 808  | 808  | 808  | 808  |
| 2021                 | 359 | 1495 | 994  | 635 | 994  | 994  | 994  | 994  | 994  |
| 2022                 | 525 | 1661 | 1160 | 630 | 1160 | 1160 | 1160 | 1160 | 1160 |
| 2023                 | 715 | 1851 | 1350 | 630 | 1350 | 1350 | 1350 | 1350 | 1350 |
| 2024                 | 914 | 2050 | 1549 | 630 | 1549 | 1549 | 1549 | 1549 | 1549 |
| 2025                 | 914 | 2050 | 1741 | 624 | 1549 | 1549 | 1549 | 1549 | 1549 |
| 2026                 | 912 | 2048 | 1924 | 624 | 1549 | 1546 | 1547 | 1547 | 1547 |
| 2027                 | 912 | 2048 | 2117 | 618 | 1549 | 1541 | 1547 | 1547 | 1547 |
| 2028                 | 906 | 2042 | 2311 | 616 | 1545 | 1532 | 1541 | 1541 | 1541 |
| 2029                 | 903 | 2039 | 2483 | 609 | 1545 | 1522 | 1538 | 1538 | 1538 |
| 2030                 | 903 | 2039 | 2483 | 609 | 1545 | 1516 | 1538 | 1538 | 1538 |
| 2031                 | 895 | 2031 | 2483 | 598 | 1545 | 1498 | 1530 | 1530 | 1530 |
| 2032                 | 890 | 2021 | 2475 | 585 | 1543 | 1481 | 1520 | 1520 | 1520 |
| 2033                 | 886 | 2012 | 2475 | 577 | 1541 | 1462 | 1518 | 1518 | 1518 |
| 2034                 | 877 | 2006 | 2467 | 568 | 1540 | 1439 | 1509 | 1509 | 1509 |
| 2035                 | 877 | 1999 | 2467 | 562 | 1535 | 1422 | 1502 | 1502 | 1502 |
| 2036                 | 871 | 1993 | 2467 | 545 | 1530 | 1405 | 1496 | 1496 | 1496 |
| 2037                 | 859 | 1977 | 2463 | 533 | 1521 | 1374 | 1487 | 1487 | 1487 |
| 2038                 | 853 | 1974 | 2459 | 527 | 1517 | 1340 | 1473 | 1473 | 1473 |
| 2039                 | 844 | 1963 | 2459 | 518 | 1517 | 1324 | 1469 | 1469 | 1469 |
| 2040                 | 838 | 1955 | 2440 | 333 | 1498 | 1318 | 1455 | 1455 | 1455 |
| 2041                 | 831 | 1936 | 2440 | 80  | 1492 | 1304 | 1447 | 1447 | 1447 |
| 2042                 | 607 | 1689 | 2421 | 63  | 1253 | 1287 | 1194 | 1194 | 1194 |
| 2043                 | 343 | 1389 | 2412 | 17  | 955  | 1037 | 904  | 904  | 904  |
| 2044                 | 240 | 1147 | 2132 | 17  | 734  | 795  | 673  | 673  | 673  |
| 2045                 | 72  | 941  | 1840 | 0   | 559  | 603  | 514  | 514  | 514  |
| 2046                 | 68  | 737  | 1572 | 0   | 382  | 396  | 320  | 320  | 320  |
| 2047                 | 15  | 539  | 1337 | 0   | 178  | 235  | 146  | 146  | 146  |
| 2048                 | 13  | 335  | 1128 | 0   | 95   | 129  | 82   | 82   | 82   |
| 2049                 | 2   | 196  | 917  | 0   | 52   | 50   | 30   | 30   | 30   |
| 2050                 | 2   | 101  | 682  | 0   | 19   | 17   | 13   | 13   | 13   |
| 2051                 | 2   | 57   | 461  | 0   | 0    | 2    | 3    | 3    | 3    |

| ScenarioID /<br>Year | 73 | 74 | 75  | 76 | 77 | 78 | 79 | 80 | 81 |
|----------------------|----|----|-----|----|----|----|----|----|----|
| 2052                 | 2  | 27 | 309 | 0  | 0  | 2  | 3  | 3  | 3  |
| 2053                 | 2  | 7  | 199 | 0  | 0  | 2  | 3  | 3  | 3  |
| 2054                 | 2  | 0  | 99  | 0  | 0  | 2  | 3  | 3  | 3  |
| 2055                 | 2  | 0  | 42  | 0  | 0  | 2  | 3  | 3  | 3  |
| 2056                 | 2  | 0  | 20  | 0  | 0  | 2  | 3  | 3  | 3  |
| 2057                 | 2  | 0  | 5   | 0  | 0  | 2  | 3  | 3  | 3  |
| 2058                 | 2  | 0  | 5   | 0  | 0  | 2  | 3  | 3  | 3  |
| 2059                 | 2  | 0  | 5   | 0  | 0  | 2  | 3  | 3  | 3  |
| 2060                 | 2  | 0  | 5   | 0  | 0  | 2  | 3  | 3  | 3  |
| 2061                 | 2  | 0  | 5   | 0  | 0  | 2  | 3  | 3  | 3  |
| 2062                 | 2  | 0  | 5   | 0  | 0  | 2  | 3  | 3  | 3  |
| 2063                 | 2  | 0  | 5   | 0  | 0  | 2  | 3  | 3  | 3  |
| 2064                 | 2  | 0  | 5   | 0  | 0  | 2  | 3  | 3  | 3  |
| 2065                 | 2  | 0  | 5   | 0  | 0  | 2  | 3  | 3  | 3  |
| 2066                 | 2  | 0  | 5   | 0  | 0  | 2  | 3  | 3  | 3  |
| 2067                 | 2  | 0  | 5   | 0  | 0  | 2  | 3  | 3  | 3  |
| 2068                 | 2  | 0  | 5   | 0  | 0  | 2  | 3  | 3  | 3  |
| 2069                 | 2  | 0  | 5   | 0  | 0  | 2  | 3  | 3  | 3  |
| 2070                 | 2  | 0  | 5   | 0  | 0  | 2  | 3  | 3  | 3  |
| 2071                 | 2  | 0  | 5   | 0  | 0  | 2  | 3  | 3  | 3  |
| 2072                 | 2  | 0  | 5   | 0  | 0  | 2  | 3  | 3  | 3  |
| 2073                 | 2  | 0  | 5   | 0  | 0  | 2  | 3  | 3  | 3  |
| 2074                 | 2  | 0  | 5   | 0  | 0  | 2  | 3  | 3  | 3  |
| 2075                 | 2  | 0  | 5   | 0  | 0  | 2  | 3  | 3  | 3  |
| 2076                 | 2  | 0  | 5   | 0  | 0  | 2  | 3  | 3  | 3  |
| 2077                 | 2  | 0  | 5   | 0  | 0  | 2  | 3  | 3  | 3  |
| 2078                 | 2  | 0  | 5   | 0  | 0  | 2  | 3  | 3  | 3  |
| 2079                 | 2  | 0  | 5   | 0  | 0  | 2  | 3  | 3  | 3  |
| 2080                 | 2  | 0  | 5   | 0  | 0  | 2  | 3  | 3  | 3  |
| 2081                 | 2  | 0  | 5   | 0  | 0  | 2  | 3  | 3  | 3  |
| 2082                 | 2  | 0  | 5   | 0  | 0  | 2  | 3  | 3  | 3  |
| 2083                 | 2  | 0  | 5   | 0  | 0  | 2  | 3  | 3  | 3  |
| 2084                 | 2  | 0  | 5   | 0  | 0  | 2  | 3  | 3  | 3  |
| 2085                 | 2  | 0  | 5   | 0  | 0  | 2  | 3  | 3  | 3  |
| 2086                 | 2  | 0  | 5   | 0  | 0  | 2  | 3  | 3  | 3  |
| 2087                 | 2  | 0  | 5   | 0  | 0  | 2  | 3  | 3  | 3  |
| 2088                 | 2  | 0  | 5   | 0  | 0  | 2  | 3  | 3  | 3  |
| 2089                 | 2  | 0  | 5   | 0  | 0  | 2  | 3  | 3  | 3  |
| 2090                 | 2  | 0  | 5   | 0  | 0  | 2  | 3  | 3  | 3  |

| ScenarioID /<br>Year | 1   | 2   | 3   | 4   | 5   | 6   | 7   | 8   | 9   |
|----------------------|-----|-----|-----|-----|-----|-----|-----|-----|-----|
| 2002                 | 0   | 0   | 0   | 0   | 0   | 0   | 0   | 0   | 0   |
| 2003                 | 0   | 0   | 0   | 0   | 0   | 0   | 0   | 0   | 0   |
| 2004                 | 0   | 0   | 0   | 0   | 0   | 0   | 0   | 0   | 0   |
| 2005                 | 0   | 0   | 0   | 0   | 0   | 0   | 0   | 0   | 0   |
| 2006                 | 0   | 0   | 0   | 0   | 0   | 0   | 0   | 0   | 0   |
| 2007                 | 0   | 0   | 0   | 0   | 0   | 0   | 0   | 0   | 0   |
| 2008                 | 0   | 0   | 0   | 0   | 0   | 0   | 0   | 0   | 0   |
| 2009                 | 0   | 0   | 0   | 0   | 0   | 0   | 0   | 0   | 0   |
| 2010                 | 0   | 0   | 0   | 0   | 0   | 0   | 0   | 0   | 0   |
| 2011                 | 0   | 0   | 0   | 0   | 0   | 0   | 0   | 0   | 0   |
| 2012                 | 0   | 0   | 0   | 0   | 0   | 0   | 0   | 0   | 0   |
| 2013                 | 0   | 0   | 0   | 0   | 0   | 0   | 0   | 0   | 0   |
| 2014                 | 0   | 0   | 0   | 0   | 0   | 0   | 0   | 0   | 0   |
| 2015                 | 0   | 0   | 0   | 0   | 0   | 0   | 0   | 0   | 0   |
| 2016                 | 0   | 0   | 0   | 0   | 0   | 0   | 0   | 0   | 0   |
| 2017                 | 0   | 0   | 0   | 0   | 0   | 0   | 0   | 0   | 0   |
| 2018                 | 0   | 0   | 0   | 0   | 0   | 0   | 0   | 0   | 0   |
| 2019                 | 0   | 0   | 0   | 0   | 0   | 0   | 0   | 0   | 0   |
| 2020                 | 0   | 0   | 0   | 0   | 0   | 0   | 0   | 0   | 0   |
| 2021                 | 0   | 0   | 0   | 0   | 0   | 0   | 0   | 0   | 0   |
| 2022                 | 0   | 0   | 0   | 0   | 0   | 0   | 0   | 0   | 0   |
| 2023                 | 0   | 0   | 0   | 0   | 0   | 0   | 0   | 0   | 0   |
| 2024                 | 0   | 0   | 0   | 0   | 0   | 0   | 0   | 0   | 0   |
| 2025                 | 0   | 0   | 0   | 0   | 0   | 0   | 0   | 0   | 0   |
| 2026                 | 0   | 0   | 0   | 0   | 0   | 0   | 0   | 0   | 0   |
| 2027                 | 0   | 0   | 0   | 0   | 0   | 0   | 0   | 0   | 0   |
| 2028                 | 0   | 0   | 0   | 0   | 0   | 0   | 0   | 0   | 0   |
| 2029                 | 0   | 0   | 0   | 0   | 0   | 0   | 0   | 0   | 0   |
| 2030                 | 0   | 0   | 0   | 0   | 0   | 0   | 0   | 0   | 0   |
| 2031                 | 0   | 0   | 0   | 0   | 0   | 0   | 0   | 0   | 0   |
| 2032                 | 0   | 0   | 0   | 0   | 0   | 0   | 0   | 0   | 0   |
| 2033                 | 0   | 0   | 0   | 0   | 0   | 0   | 0   | 0   | 0   |
| 2034                 | 0   | 0   | 0   | 0   | 0   | 0   | 0   | 0   | 0   |
| 2035                 | 0   | 0   | 0   | 0   | 0   | 0   | 0   | 0   | 0   |
| 2036                 | 0   | 0   | 0   | 0   | 0   | 0   | 0   | 0   | 0   |
| 2037                 | 0   | 0   | 0   | 44  | 0   | 0   | 0   | 0   | 0   |
| 2038                 | 0   | 0   | 0   | 59  | 0   | 0   | 0   | 0   | 0   |
| 2039                 | 37  | 41  | 0   | 97  | 37  | 28  | 40  | 40  | 40  |
| 2040                 | 60  | 64  | 0   | 123 | 60  | 53  | 63  | 63  | 63  |
| 2041                 | 93  | 103 | 23  | 160 | 99  | 83  | 102 | 102 | 102 |
| 2042                 | 141 | 151 | 60  | 218 | 145 | 125 | 150 | 150 | 150 |
| 2043                 | 181 | 191 | 97  | 264 | 186 | 167 | 190 | 190 | 190 |
| 2044                 | 230 | 240 | 141 | 312 | 234 | 211 | 239 | 239 | 239 |
| 2045                 | 315 | 325 | 228 | 394 | 315 | 295 | 324 | 324 | 324 |
| 2046                 | 382 | 392 | 299 | 461 | 381 | 364 | 391 | 391 | 391 |
| 2047                 | 448 | 458 | 367 | 518 | 447 | 429 | 457 | 457 | 457 |
| 2048                 | 520 | 530 | 444 | 579 | 519 | 499 | 529 | 529 | 529 |
| 2049                 | 530 | 540 | 454 | 589 | 529 | 509 | 539 | 539 | 539 |
| 2050                 | 551 | 561 | 475 | 610 | 550 | 531 | 560 | 560 | 560 |
| 2051                 | 571 | 581 | 495 | 630 | 570 | 552 | 580 | 580 | 580 |



| ScenarioID /<br>Year | 1   | 2   | 3   | 4   | 5   | 6   | 7   | 8   | 9   |
|----------------------|-----|-----|-----|-----|-----|-----|-----|-----|-----|
| 2052                 | 576 | 586 | 500 | 635 | 575 | 557 | 585 | 585 | 585 |
| 2053                 | 576 | 586 | 500 | 635 | 575 | 557 | 585 | 585 | 585 |
| 2054                 | 589 | 599 | 513 | 648 | 588 | 570 | 598 | 598 | 598 |
| 2055                 | 591 | 601 | 515 | 650 | 590 | 572 | 600 | 600 | 600 |
| 2056                 | 601 | 611 | 525 | 660 | 600 | 582 | 610 | 610 | 610 |
| 2057                 | 601 | 611 | 525 | 660 | 600 | 582 | 610 | 610 | 610 |
| 2058                 | 601 | 611 | 525 | 660 | 600 | 582 | 610 | 610 | 610 |
| 2059                 | 601 | 611 | 525 | 660 | 600 | 582 | 610 | 610 | 610 |
| 2060                 | 601 | 611 | 525 | 660 | 600 | 582 | 610 | 610 | 610 |
| 2061                 | 601 | 611 | 525 | 660 | 600 | 582 | 610 | 610 | 610 |
| 2062                 | 601 | 611 | 525 | 660 | 600 | 582 | 610 | 610 | 610 |
| 2063                 | 601 | 611 | 525 | 660 | 600 | 582 | 610 | 610 | 610 |
| 2064                 | 601 | 611 | 525 | 660 | 600 | 582 | 610 | 610 | 610 |
| 2065                 | 601 | 611 | 525 | 660 | 600 | 582 | 610 | 610 | 610 |
| 2066                 | 601 | 611 | 525 | 660 | 600 | 582 | 610 | 610 | 610 |
| 2067                 | 601 | 611 | 525 | 660 | 600 | 582 | 610 | 610 | 610 |
| 2068                 | 601 | 611 | 525 | 660 | 600 | 582 | 610 | 610 | 610 |
| 2069                 | 601 | 611 | 525 | 660 | 600 | 582 | 610 | 610 | 610 |
| 2070                 | 601 | 611 | 525 | 660 | 600 | 582 | 610 | 610 | 610 |
| 2071                 | 601 | 611 | 525 | 660 | 600 | 582 | 610 | 610 | 610 |
| 2072                 | 601 | 611 | 525 | 660 | 600 | 582 | 610 | 610 | 610 |
| 2073                 | 601 | 611 | 525 | 660 | 600 | 582 | 610 | 610 | 610 |
| 2074                 | 601 | 611 | 525 | 660 | 600 | 582 | 610 | 610 | 610 |
| 2075                 | 601 | 611 | 525 | 660 | 600 | 582 | 610 | 610 | 610 |
| 2076                 | 601 | 611 | 525 | 660 | 600 | 582 | 610 | 610 | 610 |
| 2077                 | 601 | 611 | 525 | 660 | 600 | 582 | 610 | 610 | 610 |
| 2078                 | 601 | 611 | 525 | 660 | 600 | 582 | 610 | 610 | 610 |
| 2079                 | 601 | 611 | 525 | 660 | 600 | 582 | 610 | 610 | 610 |
| 2080                 | 601 | 611 | 525 | 660 | 600 | 582 | 610 | 610 | 610 |
| 2081                 | 601 | 611 | 525 | 660 | 600 | 582 | 610 | 610 | 610 |
| 2082                 | 601 | 611 | 525 | 660 | 600 | 582 | 610 | 610 | 610 |
| 2083                 | 601 | 611 | 525 | 660 | 600 | 582 | 610 | 610 | 610 |
| 2084                 | 601 | 611 | 525 | 660 | 600 | 582 | 610 | 610 | 610 |
| 2085                 | 601 | 611 | 525 | 660 | 600 | 582 | 610 | 610 | 610 |
| 2086                 | 601 | 611 | 525 | 660 | 600 | 582 | 610 | 610 | 610 |
| 2087                 | 601 | 611 | 525 | 660 | 600 | 582 | 610 | 610 | 610 |
| 2088                 | 601 | 611 | 525 | 660 | 600 | 582 | 610 | 610 | 610 |
| 2089                 | 601 | 611 | 525 | 660 | 600 | 582 | 610 | 610 | 610 |
| 2090                 | 601 | 611 | 525 | 660 | 600 | 582 | 610 | 610 | 610 |

| ScenarioID /<br>Year | 10  | 11  | 12  | 13  | 14  | 15  | 16  | 17  | 18  |
|----------------------|-----|-----|-----|-----|-----|-----|-----|-----|-----|
| 2002                 | 0   | 0   | 0   | 0   | 0   | 0   | 0   | 0   | 0   |
| 2003                 | 0   | 0   | 0   | 0   | 0   | 0   | 0   | 0   | 0   |
| 2004                 | 0   | 0   | 0   | 0   | 0   | 0   | 0   | 0   | 0   |
| 2005                 | 0   | 0   | 0   | 0   | 0   | 0   | 0   | 0   | 0   |
| 2006                 | 0   | 0   | 0   | 0   | 0   | 0   | 0   | 0   | 0   |
| 2007                 | 0   | 0   | 0   | 0   | 0   | 0   | 0   | 0   | 0   |
| 2008                 | 0   | 0   | 0   | 0   | 0   | 0   | 0   | 0   | 0   |
| 2009                 | 0   | 0   | 0   | 0   | 0   | 0   | 0   | 0   | 0   |
| 2010                 | 0   | 0   | 0   | 0   | 0   | 0   | 0   | 0   | 0   |
| 2011                 | 0   | 0   | 0   | 0   | 0   | 0   | 0   | 0   | 0   |
| 2012                 | 0   | 0   | 0   | 0   | 0   | 0   | 0   | 0   | 0   |
| 2013                 | 0   | 0   | 0   | 0   | 0   | 0   | 0   | 0   | 0   |
| 2014                 | 0   | 0   | 0   | 0   | 0   | 0   | 0   | 0   | 0   |
| 2015                 | 0   | 0   | 0   | 0   | 0   | 0   | 0   | 0   | 0   |
| 2016                 | 0   | 0   | 0   | 0   | 0   | 0   | 0   | 0   | 0   |
| 2017                 | 0   | 0   | 0   | 0   | 0   | 0   | 0   | 0   | 0   |
| 2018                 | 0   | 0   | 0   | 0   | 0   | 0   | 0   | 0   | 0   |
| 2019                 | 0   | 0   | 0   | 0   | 0   | 0   | 0   | 0   | 0   |
| 2020                 | 0   | 0   | 0   | 0   | 0   | 0   | 0   | 0   | 0   |
| 2021                 | 0   | 0   | 0   | 0   | 0   | 0   | 0   | 0   | 0   |
| 2022                 | 0   | 0   | 0   | 0   | 0   | 0   | 0   | 0   | 0   |
| 2023                 | 0   | 0   | 0   | 0   | 0   | 0   | 0   | 0   | 0   |
| 2024                 | 0   | 0   | 0   | 0   | 0   | 0   | 0   | 0   | 0   |
| 2025                 | 0   | 0   | 0   | 0   | 0   | 0   | 0   | 0   | 0   |
| 2026                 | 0   | 0   | 0   | 0   | 0   | 0   | 0   | 0   | 0   |
| 2027                 | 0   | 0   | 0   | 0   | 0   | 0   | 0   | 0   | 0   |
| 2028                 | 0   | 0   | 0   | 0   | 0   | 0   | 0   | 0   | 0   |
| 2029                 | 0   | 0   | 0   | 0   | 0   | 0   | 0   | 0   | 0   |
| 2030                 | 0   | 0   | 0   | 0   | 0   | 0   | 0   | 0   | 0   |
| 2031                 | 0   | 0   | 0   | 0   | 0   | 0   | 0   | 0   | 0   |
| 2032                 | 0   | 0   | 0   | 0   | 0   | 0   | 0   | 0   | 0   |
| 2033                 | 0   | 0   | 0   | 0   | 0   | 0   | 0   | 0   | 0   |
| 2034                 | 0   | 0   | 0   | 0   | 0   | 0   | 0   | 0   | 0   |
| 2035                 | 0   | 0   | 0   | 0   | 0   | 0   | 0   | 0   | 0   |
| 2036                 | 0   | 0   | 0   | 0   | 0   | 0   | 0   | 0   | 0   |
| 2037                 | 0   | 0   | 0   | 15  | 0   | 0   | 0   | 0   | 0   |
| 2038                 | 0   | 0   | 0   | 32  | 0   | 0   | 0   | 0   | 0   |
| 2039                 | 23  | 14  | 0   | 50  | 14  | 9   | 13  | 13  | 13  |
| 2040                 | 43  | 36  | 0   | 71  | 37  | 28  | 35  | 35  | 35  |
| 2041                 | 61  | 59  | 0   | 91  | 60  | 47  | 58  | 58  | 58  |
| 2042                 | 84  | 82  | 17  | 115 | 83  | 69  | 81  | 81  | 81  |
| 2043                 | 141 | 143 | 45  | 183 | 145 | 130 | 142 | 142 | 142 |
| 2044                 | 221 | 223 | 115 | 266 | 224 | 208 | 222 | 222 | 222 |
| 2045                 | 292 | 293 | 175 | 329 | 295 | 277 | 292 | 292 | 292 |
| 2046                 | 374 | 375 | 256 | 405 | 377 | 357 | 374 | 374 | 374 |
| 2047                 | 436 | 437 | 314 | 454 | 439 | 419 | 436 | 436 | 436 |
| 2048                 | 488 | 489 | 384 | 498 | 491 | 470 | 488 | 488 | 488 |
| 2049                 | 495 | 496 | 394 | 504 | 498 | 477 | 495 | 495 | 495 |
| 2050                 | 507 | 508 | 415 | 516 | 510 | 490 | 507 | 507 | 507 |
| 2051                 | 524 | 525 | 435 | 529 | 527 | 508 | 524 | 524 | 524 |

| ScenarioID /<br>Year | 10  | 11  | 12  | 13  | 14  | 15  | 16  | 17  | 18  |
|----------------------|-----|-----|-----|-----|-----|-----|-----|-----|-----|
| 2052                 | 527 | 528 | 440 | 532 | 530 | 511 | 527 | 527 | 527 |
| 2053                 | 527 | 528 | 440 | 532 | 530 | 511 | 527 | 527 | 527 |
| 2054                 | 537 | 538 | 453 | 542 | 540 | 521 | 537 | 537 | 537 |
| 2055                 | 537 | 538 | 455 | 542 | 540 | 521 | 537 | 537 | 537 |
| 2056                 | 545 | 545 | 465 | 542 | 548 | 527 | 544 | 544 | 544 |
| 2057                 | 546 | 546 | 465 | 542 | 549 | 528 | 545 | 545 | 545 |
| 2058                 | 546 | 546 | 465 | 542 | 549 | 528 | 545 | 545 | 545 |
| 2059                 | 546 | 546 | 465 | 542 | 549 | 528 | 545 | 545 | 545 |
| 2060                 | 546 | 546 | 465 | 542 | 549 | 528 | 545 | 545 | 545 |
| 2061                 | 546 | 546 | 465 | 542 | 549 | 528 | 545 | 545 | 545 |
| 2062                 | 546 | 546 | 465 | 542 | 549 | 528 | 545 | 545 | 545 |
| 2063                 | 546 | 546 | 465 | 542 | 549 | 528 | 545 | 545 | 545 |
| 2064                 | 546 | 546 | 465 | 542 | 549 | 528 | 545 | 545 | 545 |
| 2065                 | 546 | 546 | 465 | 542 | 549 | 528 | 545 | 545 | 545 |
| 2066                 | 546 | 546 | 465 | 542 | 549 | 528 | 545 | 545 | 545 |
| 2067                 | 546 | 546 | 465 | 542 | 549 | 528 | 545 | 545 | 545 |
| 2068                 | 546 | 546 | 465 | 542 | 549 | 528 | 545 | 545 | 545 |
| 2069                 | 546 | 546 | 465 | 542 | 549 | 528 | 545 | 545 | 545 |
| 2070                 | 546 | 546 | 465 | 542 | 549 | 528 | 545 | 545 | 545 |
| 2071                 | 546 | 546 | 465 | 542 | 549 | 528 | 545 | 545 | 545 |
| 2072                 | 546 | 546 | 465 | 542 | 549 | 528 | 545 | 545 | 545 |
| 2073                 | 546 | 546 | 465 | 542 | 549 | 528 | 545 | 545 | 545 |
| 2074                 | 546 | 546 | 465 | 542 | 549 | 528 | 545 | 545 | 545 |
| 2075                 | 546 | 546 | 465 | 542 | 549 | 528 | 545 | 545 | 545 |
| 2076                 | 546 | 546 | 465 | 542 | 549 | 528 | 545 | 545 | 545 |
| 2077                 | 546 | 546 | 465 | 542 | 549 | 528 | 545 | 545 | 545 |
| 2078                 | 546 | 546 | 465 | 542 | 549 | 528 | 545 | 545 | 545 |
| 2079                 | 546 | 546 | 465 | 542 | 549 | 528 | 545 | 545 | 545 |
| 2080                 | 546 | 546 | 465 | 542 | 549 | 528 | 545 | 545 | 545 |
| 2081                 | 546 | 546 | 465 | 542 | 549 | 528 | 545 | 545 | 545 |
| 2082                 | 546 | 546 | 465 | 542 | 549 | 528 | 545 | 545 | 545 |
| 2083                 | 546 | 546 | 465 | 542 | 549 | 528 | 545 | 545 | 545 |
| 2084                 | 546 | 546 | 465 | 542 | 549 | 528 | 545 | 545 | 545 |
| 2085                 | 546 | 546 | 465 | 542 | 549 | 528 | 545 | 545 | 545 |
| 2086                 | 546 | 546 | 465 | 542 | 549 | 528 | 545 | 545 | 545 |
| 2087                 | 546 | 546 | 465 | 542 | 549 | 528 | 545 | 545 | 545 |
| 2088                 | 546 | 546 | 465 | 542 | 549 | 528 | 545 | 545 | 545 |
| 2089                 | 546 | 546 | 465 | 542 | 549 | 528 | 545 | 545 | 545 |
| 2090                 | 546 | 546 | 465 | 542 | 549 | 528 | 545 | 545 | 545 |

| ScenarioID /<br>Year | 19  | 20  | 21  | 22  | 23  | 24  | 25  | 26  | 27  |
|----------------------|-----|-----|-----|-----|-----|-----|-----|-----|-----|
| 2002                 | 0   | 0   | 0   | 0   | 0   | 0   | 0   | 0   | 0   |
| 2003                 | 0   | 0   | 0   | 0   | 0   | 0   | 0   | 0   | 0   |
| 2004                 | 0   | 0   | 0   | 0   | 0   | 0   | 0   | 0   | 0   |
| 2005                 | 0   | 0   | 0   | 0   | 0   | 0   | 0   | 0   | 0   |
| 2006                 | 0   | 0   | 0   | 0   | 0   | 0   | 0   | 0   | 0   |
| 2007                 | 0   | 0   | 0   | 0   | 0   | 0   | 0   | 0   | 0   |
| 2008                 | 0   | 0   | 0   | 0   | 0   | 0   | 0   | 0   | 0   |
| 2009                 | 0   | 0   | 0   | 0   | 0   | 0   | 0   | 0   | 0   |
| 2010                 | 0   | 0   | 0   | 0   | 0   | 0   | 0   | 0   | 0   |
| 2011                 | 0   | 0   | 0   | 0   | 0   | 0   | 0   | 0   | 0   |
| 2012                 | 0   | 0   | 0   | 0   | 0   | 0   | 0   | 0   | 0   |
| 2013                 | 0   | 0   | 0   | 0   | 0   | 0   | 0   | 0   | 0   |
| 2014                 | 0   | 0   | 0   | 0   | 0   | 0   | 0   | 0   | 0   |
| 2015                 | 0   | 0   | 0   | 0   | 0   | 0   | 0   | 0   | 0   |
| 2016                 | 0   | 0   | 0   | 0   | 0   | 0   | 0   | 0   | 0   |
| 2017                 | 0   | 0   | 0   | 0   | 0   | 0   | 0   | 0   | 0   |
| 2018                 | 0   | 0   | 0   | 0   | 0   | 0   | 0   | 0   | 0   |
| 2019                 | 0   | 0   | 0   | 0   | 0   | 0   | 0   | 0   | 0   |
| 2020                 | 0   | 0   | 0   | 0   | 0   | 0   | 0   | 0   | 0   |
| 2021                 | 0   | 0   | 0   | 0   | 0   | 0   | 0   | 0   | 0   |
| 2022                 | 0   | 0   | 0   | 0   | 0   | 0   | 0   | 0   | 0   |
| 2023                 | 0   | 0   | 0   | 0   | 0   | 0   | 0   | 0   | 0   |
| 2024                 | 0   | 0   | 0   | 0   | 0   | 0   | 0   | 0   | 0   |
| 2025                 | 0   | 0   | 0   | 0   | 0   | 0   | 0   | 0   | 0   |
| 2026                 | 0   | 0   | 0   | 0   | 0   | 0   | 0   | 0   | 0   |
| 2027                 | 0   | 0   | 0   | 0   | 0   | 0   | 0   | 0   | 0   |
| 2028                 | 0   | 0   | 0   | 0   | 0   | 0   | 0   | 0   | 0   |
| 2029                 | 0   | 0   | 0   | 0   | 0   | 0   | 0   | 0   | 0   |
| 2030                 | 0   | 0   | 0   | 0   | 0   | 0   | 0   | 0   | 0   |
| 2031                 | 0   | 0   | 0   | 0   | 0   | 0   | 0   | 0   | 0   |
| 2032                 | 0   | 0   | 0   | 0   | 0   | 0   | 0   | 0   | 0   |
| 2033                 | 0   | 0   | 0   | 0   | 0   | 0   | 0   | 0   | 0   |
| 2034                 | 0   | 0   | 0   | 0   | 0   | 0   | 0   | 0   | 0   |
| 2035                 | 0   | 0   | 0   | 0   | 0   | 0   | 0   | 0   | 0   |
| 2036                 | 0   | 0   | 0   | 0   | 0   | 0   | 0   | 0   | 0   |
| 2037                 | 0   | 0   | 0   | 43  | 0   | 0   | 0   | 0   | 0   |
| 2038                 | 0   | 0   | 0   | 66  | 0   | 0   | 0   | 0   | 0   |
| 2039                 | 15  | 13  | 0   | 86  | 14  | 12  | 12  | 12  | 12  |
| 2040                 | 43  | 38  | 0   | 108 | 39  | 35  | 38  | 38  | 38  |
| 2041                 | 61  | 56  | 1   | 133 | 58  | 54  | 56  | 56  | 56  |
| 2042                 | 89  | 82  | 20  | 163 | 84  | 79  | 82  | 82  | 82  |
| 2043                 | 154 | 146 | 60  | 227 | 148 | 143 | 147 | 147 | 147 |
| 2044                 | 234 | 225 | 133 | 315 | 227 | 222 | 226 | 226 | 226 |
| 2045                 | 311 | 297 | 203 | 389 | 299 | 294 | 299 | 299 | 299 |
| 2046                 | 394 | 380 | 283 | 471 | 382 | 376 | 382 | 382 | 382 |
| 2047                 | 455 | 441 | 345 | 533 | 443 | 438 | 443 | 443 | 443 |
| 2048                 | 507 | 493 | 416 | 584 | 495 | 490 | 495 | 495 | 495 |
| 2049                 | 514 | 500 | 426 | 591 | 502 | 497 | 502 | 502 | 502 |
| 2050                 | 526 | 512 | 447 | 604 | 514 | 510 | 514 | 514 | 514 |
| 2051                 | 543 | 529 | 467 | 621 | 531 | 528 | 531 | 531 | 531 |

| ScenarioID /<br>Year | 19  | 20  | 21  | 22  | 23  | 24  | 25  | 26  | 27  |
|----------------------|-----|-----|-----|-----|-----|-----|-----|-----|-----|
| 2052                 | 546 | 532 | 472 | 624 | 534 | 531 | 534 | 534 | 534 |
| 2053                 | 546 | 532 | 472 | 624 | 534 | 531 | 534 | 534 | 534 |
| 2054                 | 556 | 542 | 485 | 634 | 544 | 541 | 544 | 544 | 544 |
| 2055                 | 556 | 542 | 487 | 634 | 544 | 541 | 544 | 544 | 544 |
| 2056                 | 565 | 549 | 497 | 634 | 551 | 548 | 552 | 552 | 552 |
| 2057                 | 566 | 550 | 497 | 634 | 552 | 549 | 553 | 553 | 553 |
| 2058                 | 566 | 550 | 497 | 634 | 552 | 549 | 553 | 553 | 553 |
| 2059                 | 566 | 550 | 497 | 634 | 552 | 549 | 553 | 553 | 553 |
| 2060                 | 566 | 550 | 497 | 634 | 552 | 549 | 553 | 553 | 553 |
| 2061                 | 566 | 550 | 497 | 634 | 552 | 549 | 553 | 553 | 553 |
| 2062                 | 566 | 550 | 497 | 634 | 552 | 549 | 553 | 553 | 553 |
| 2063                 | 566 | 550 | 497 | 634 | 552 | 549 | 553 | 553 | 553 |
| 2064                 | 566 | 550 | 497 | 634 | 552 | 549 | 553 | 553 | 553 |
| 2065                 | 566 | 550 | 497 | 634 | 552 | 549 | 553 | 553 | 553 |
| 2066                 | 566 | 550 | 497 | 634 | 552 | 549 | 553 | 553 | 553 |
| 2067                 | 566 | 550 | 497 | 634 | 552 | 549 | 553 | 553 | 553 |
| 2068                 | 566 | 550 | 497 | 634 | 552 | 549 | 553 | 553 | 553 |
| 2069                 | 566 | 550 | 497 | 634 | 552 | 549 | 553 | 553 | 553 |
| 2070                 | 566 | 550 | 497 | 634 | 552 | 549 | 553 | 553 | 553 |
| 2071                 | 566 | 550 | 497 | 634 | 552 | 549 | 553 | 553 | 553 |
| 2072                 | 566 | 550 | 497 | 634 | 552 | 549 | 553 | 553 | 553 |
| 2073                 | 566 | 550 | 497 | 634 | 552 | 549 | 553 | 553 | 553 |
| 2074                 | 566 | 550 | 497 | 634 | 552 | 549 | 553 | 553 | 553 |
| 2075                 | 566 | 550 | 497 | 634 | 552 | 549 | 553 | 553 | 553 |
| 2076                 | 566 | 550 | 497 | 634 | 552 | 549 | 553 | 553 | 553 |
| 2077                 | 566 | 550 | 497 | 634 | 552 | 549 | 553 | 553 | 553 |
| 2078                 | 566 | 550 | 497 | 634 | 552 | 549 | 553 | 553 | 553 |
| 2079                 | 566 | 550 | 497 | 634 | 552 | 549 | 553 | 553 | 553 |
| 2080                 | 566 | 550 | 497 | 634 | 552 | 549 | 553 | 553 | 553 |
| 2081                 | 566 | 550 | 497 | 634 | 552 | 549 | 553 | 553 | 553 |
| 2082                 | 566 | 550 | 497 | 634 | 552 | 549 | 553 | 553 | 553 |
| 2083                 | 566 | 550 | 497 | 634 | 552 | 549 | 553 | 553 | 553 |
| 2084                 | 566 | 550 | 497 | 634 | 552 | 549 | 553 | 553 | 553 |
| 2085                 | 566 | 550 | 497 | 634 | 552 | 549 | 553 | 553 | 553 |
| 2086                 | 566 | 550 | 497 | 634 | 552 | 549 | 553 | 553 | 553 |
| 2087                 | 566 | 550 | 497 | 634 | 552 | 549 | 553 | 553 | 553 |
| 2088                 | 566 | 550 | 497 | 634 | 552 | 549 | 553 | 553 | 553 |
| 2089                 | 566 | 550 | 497 | 634 | 552 | 549 | 553 | 553 | 553 |
| 2090                 | 566 | 550 | 497 | 634 | 552 | 549 | 553 | 553 | 553 |

| ScenarioID /<br>Year | 28 | 29 | 30 | 31 | 32 | 33 | 34 | 35 | 36 |
|----------------------|----|----|----|----|----|----|----|----|----|
| 2002                 | 0  | 0  | 0  | 0  | 0  | 0  | 0  | 0  | 0  |
| 2003                 | 0  | 0  | 0  | 0  | 0  | 0  | 0  | 0  | 0  |
| 2004                 | 0  | 0  | 0  | 0  | 0  | 0  | 0  | 0  | 0  |
| 2005                 | 0  | 0  | 0  | 0  | 0  | 0  | 0  | 0  | 0  |
| 2006                 | 0  | 0  | 0  | 0  | 0  | 0  | 0  | 0  | 0  |
| 2007                 | 0  | 0  | 0  | 0  | 0  | 0  | 0  | 0  | 0  |
| 2008                 | 0  | 0  | 0  | 0  | 0  | 0  | 0  | 0  | 0  |
| 2009                 | 0  | 0  | 0  | 0  | 0  | 0  | 0  | 0  | 0  |
| 2010                 | 0  | 0  | 0  | 0  | 0  | 0  | 0  | 0  | 0  |
| 2011                 | 0  | 0  | 0  | 0  | 0  | 0  | 0  | 0  | 0  |
| 2012                 | 0  | 0  | 0  | 0  | 0  | 0  | 0  | 0  | 0  |
| 2013                 | 0  | 0  | 0  | 0  | 0  | 0  | 0  | 0  | 0  |
| 2014                 | 0  | 0  | 0  | 0  | 0  | 0  | 0  | 0  | 0  |
| 2015                 | 0  | 0  | 0  | 0  | 0  | 0  | 0  | 0  | 0  |
| 2016                 | 0  | 0  | 0  | 0  | 0  | 0  | 0  | 0  | 0  |
| 2017                 | 0  | 0  | 0  | 0  | 0  | 0  | 0  | 0  | 0  |
| 2018                 | 0  | 0  | 0  | 0  | 0  | 0  | 0  | 0  | 0  |
| 2019                 | 0  | 0  | 0  | 0  | 0  | 0  | 0  | 0  | 0  |
| 2020                 | 0  | 0  | 0  | 0  | 0  | 0  | 0  | 0  | 0  |
| 2021                 | 0  | 0  | 0  | 0  | 0  | 0  | 0  | 0  | 0  |
| 2022                 | 0  | 0  | 0  | 0  | 0  | 0  | 0  | 0  | 0  |
| 2023                 | 0  | 0  | 0  | 0  | 0  | 0  | 0  | 0  | 0  |
| 2024                 | 0  | 0  | 0  | 0  | 0  | 0  | 0  | 0  | 0  |
| 2025                 | 0  | 0  | 0  | 0  | 0  | 0  | 0  | 0  | 0  |
| 2026                 | 0  | 0  | 0  | 0  | 0  | 0  | 0  | 0  | 0  |
| 2027                 | 0  | 0  | 0  | 0  | 0  | 0  | 0  | 0  | 0  |
| 2028                 | 0  | 0  | 0  | 0  | 0  | 0  | 0  | 0  | 0  |
| 2029                 | 0  | 0  | 0  | 0  | 0  | 0  | 0  | 0  | 0  |
| 2030                 | 0  | 0  | 0  | 0  | 0  | 0  | 0  | 0  | 0  |
| 2031                 | 0  | 0  | 0  | 0  | 0  | 0  | 0  | 0  | 0  |
| 2032                 | 0  | 0  | 0  | 0  | 0  | 0  | 0  | 0  | 0  |
| 2033                 | 0  | 0  | 0  | 0  | 0  | 0  | 0  | 0  | 0  |
| 2034                 | 0  | 0  | 0  | 0  | 0  | 0  | 0  | 0  | 0  |
| 2035                 | 0  | 0  | 0  | 0  | 0  | 0  | 0  | 0  | 0  |
| 2036                 | 0  | 0  | 0  | 0  | 0  | 0  | 0  | 0  | 0  |
| 2037                 | 0  | 0  | 0  | 0  | 0  | 0  | 0  | 0  | 0  |
| 2038                 | 0  | 0  | 0  | 0  | 0  | 0  | 0  | 0  | 0  |
| 2039                 | 0  | 0  | 0  | 0  | 0  | 0  | 0  | 0  | 0  |
| 2040                 | 0  | 0  | 0  | 0  | 0  | 0  | 0  | 0  | 0  |
| 2041                 | 0  | 0  | 0  | 0  | 0  | 0  | 0  | 0  | 0  |
| 2042                 | 0  | 0  | 0  | 0  | 0  | 0  | 0  | 0  | 0  |
| 2043                 | 0  | 0  | 0  | 0  | 0  | 0  | 0  | 0  | 0  |
| 2044                 | 0  | 0  | 0  | 0  | 0  | 0  | 0  | 0  | 0  |
| 2045                 | 0  | 0  | 0  | 0  | 0  | 0  | 0  | 0  | 0  |
| 2046                 | 0  | 0  | 0  | 0  | 0  | 0  | 0  | 0  | 0  |
| 2047                 | 0  | 0  | 0  | 0  | 0  | 0  | 0  | 0  | 0  |
| 2048                 | 0  | 0  | 0  | 0  | 0  | 0  | 0  | 0  | 0  |
| 2049                 | 0  | 0  | 0  | 0  | 0  | 0  | 0  | 0  | 0  |
| 2050                 | 0  | 0  | 0  | 0  | 0  | 0  | 0  | 0  | 0  |
| 2051                 | 0  | 0  | 0  | 0  | 0  | 0  | 0  | 0  | 0  |

| ScenarioID /<br>Year | 28 | 29 | 30 | 31 | 32 | 33 | 34 | 35 | 36 |
|----------------------|----|----|----|----|----|----|----|----|----|
| 2052                 | 0  | 0  | 0  | 0  | 0  | 0  | 0  | 0  | 0  |
| 2053                 | 0  | 0  | 0  | 0  | 0  | 0  | 0  | 0  | 0  |
| 2054                 | 0  | 0  | 0  | 0  | 0  | 0  | 0  | 0  | 0  |
| 2055                 | 0  | 0  | 0  | 0  | 0  | 0  | 0  | 0  | 0  |
| 2056                 | 0  | 0  | 0  | 0  | 0  | 0  | 0  | 0  | 0  |
| 2057                 | 0  | 0  | 0  | 0  | 0  | 0  | 0  | 0  | 0  |
| 2058                 | 0  | 0  | 0  | 0  | 0  | 0  | 0  | 0  | 0  |
| 2059                 | 0  | 0  | 0  | 0  | 0  | 0  | 0  | 0  | 0  |
| 2060                 | 0  | 0  | 0  | 0  | 0  | 0  | 0  | 0  | 0  |
| 2061                 | 0  | 0  | 0  | 0  | 0  | 0  | 0  | 0  | 0  |
| 2062                 | 0  | 0  | 0  | 0  | 0  | 0  | 0  | 0  | 0  |
| 2063                 | 0  | 0  | 0  | 0  | 0  | 0  | 0  | 0  | 0  |
| 2064                 | 0  | 0  | 0  | 0  | 0  | 0  | 0  | 0  | 0  |
| 2065                 | 0  | 0  | 0  | 0  | 0  | 0  | 0  | 0  | 0  |
| 2066                 | 0  | 0  | 0  | 0  | 0  | 0  | 0  | 0  | 0  |
| 2067                 | 0  | 0  | 0  | 0  | 0  | 0  | 0  | 0  | 0  |
| 2068                 | 0  | 0  | 0  | 0  | 0  | 0  | 0  | 0  | 0  |
| 2069                 | 0  | 0  | 0  | 0  | 0  | 0  | 0  | 0  | 0  |
| 2070                 | 0  | 0  | 0  | 0  | 0  | 0  | 0  | 0  | 0  |
| 2071                 | 0  | 0  | 0  | 0  | 0  | 0  | 0  | 0  | 0  |
| 2072                 | 0  | 0  | 0  | 0  | 0  | 0  | 0  | 0  | 0  |
| 2073                 | 0  | 0  | 0  | 0  | 0  | 0  | 0  | 0  | 0  |
| 2074                 | 0  | 0  | 0  | 0  | 0  | 0  | 0  | 0  | 0  |
| 2075                 | 0  | 0  | 0  | 0  | 0  | 0  | 0  | 0  | 0  |
| 2076                 | 0  | 0  | 0  | 0  | 0  | 0  | 0  | 0  | 0  |
| 2077                 | 0  | 0  | 0  | 0  | 0  | 0  | 0  | 0  | 0  |
| 2078                 | 0  | 0  | 0  | 0  | 0  | 0  | 0  | 0  | 0  |
| 2079                 | 0  | 0  | 0  | 0  | 0  | 0  | 0  | 0  | 0  |
| 2080                 | 0  | 0  | 0  | 0  | 0  | 0  | 0  | 0  | 0  |
| 2081                 | 0  | 0  | 0  | 0  | 0  | 0  | 0  | 0  | 0  |
| 2082                 | 0  | 0  | 0  | 0  | 0  | 0  | 0  | 0  | 0  |
| 2083                 | 0  | 0  | 0  | 0  | 0  | 0  | 0  | 0  | 0  |
| 2084                 | 0  | 0  | 0  | 0  | 0  | 0  | 0  | 0  | 0  |
| 2085                 | 0  | 0  | 0  | 0  | 0  | 0  | 0  | 0  | 0  |
| 2086                 | 0  | 0  | 0  | 0  | 0  | 0  | 0  | 0  | 0  |
| 2087                 | 0  | 0  | 0  | 0  | 0  | 0  | 0  | 0  | 0  |
| 2088                 | 0  | 0  | 0  | 0  | 0  | 0  | 0  | 0  | 0  |
| 2089                 | 0  | 0  | 0  | 0  | 0  | 0  | 0  | 0  | 0  |
| 2090                 | 0  | 0  | 0  | 0  | 0  | 0  | 0  | 0  | 0  |

| ScenarioID /<br>Year | 37 | 38 | 39 | 40 | 41 | 42 | 43 | 44 | 45 |
|----------------------|----|----|----|----|----|----|----|----|----|
| 2002                 | 0  | 0  | 0  | 0  | 0  | 0  | 0  | 0  | 0  |
| 2003                 | 0  | 0  | 0  | 0  | 0  | 0  | 0  | 0  | 0  |
| 2004                 | 0  | 0  | 0  | 0  | 0  | 0  | 0  | 0  | 0  |
| 2005                 | 0  | 0  | 0  | 0  | 0  | 0  | 0  | 0  | 0  |
| 2006                 | 0  | 0  | 0  | 0  | 0  | 0  | 0  | 0  | 0  |
| 2007                 | 0  | 0  | 0  | 0  | 0  | 0  | 0  | 0  | 0  |
| 2008                 | 0  | 0  | 0  | 0  | 0  | 0  | 0  | 0  | 0  |
| 2009                 | 0  | 0  | 0  | 0  | 0  | 0  | 0  | 0  | 0  |
| 2010                 | 0  | 0  | 0  | 0  | 0  | 0  | 0  | 0  | 0  |
| 2011                 | 0  | 0  | 0  | 0  | 0  | 0  | 0  | 0  | 0  |
| 2012                 | 0  | 0  | 0  | 0  | 0  | 0  | 0  | 0  | 0  |
| 2013                 | 0  | 0  | 0  | 0  | 0  | 0  | 0  | 0  | 0  |
| 2014                 | 0  | 0  | 0  | 0  | 0  | 0  | 0  | 0  | 0  |
| 2015                 | 0  | 0  | 0  | 0  | 0  | 0  | 0  | 0  | 0  |
| 2016                 | 0  | 0  | 0  | 0  | 0  | 0  | 0  | 0  | 0  |
| 2017                 | 0  | 0  | 0  | 0  | 0  | 0  | 0  | 0  | 0  |
| 2018                 | 0  | 0  | 0  | 0  | 0  | 0  | 0  | 0  | 0  |
| 2019                 | 0  | 0  | 0  | 0  | 0  | 0  | 0  | 0  | 0  |
| 2020                 | 0  | 0  | 0  | 0  | 0  | 0  | 0  | 0  | 0  |
| 2021                 | 0  | 0  | 0  | 0  | 0  | 0  | 0  | 0  | 0  |
| 2022                 | 0  | 0  | 0  | 0  | 0  | 0  | 0  | 0  | 0  |
| 2023                 | 0  | 0  | 0  | 0  | 0  | 0  | 0  | 0  | 0  |
| 2024                 | 0  | 0  | 0  | 0  | 0  | 0  | 0  | 0  | 0  |
| 2025                 | 0  | 0  | 0  | 0  | 0  | 0  | 0  | 0  | 0  |
| 2026                 | 0  | 0  | 0  | 0  | 0  | 0  | 0  | 0  | 0  |
| 2027                 | 0  | 0  | 0  | 0  | 0  | 0  | 0  | 0  | 0  |
| 2028                 | 0  | 0  | 0  | 0  | 0  | 0  | 0  | 0  | 0  |
| 2029                 | 0  | 0  | 0  | 0  | 0  | 0  | 0  | 0  | 0  |
| 2030                 | 0  | 0  | 0  | 0  | 0  | 0  | 0  | 0  | 0  |
| 2031                 | 0  | 0  | 0  | 0  | 0  | 0  | 0  | 0  | 0  |
| 2032                 | 0  | 0  | 0  | 0  | 0  | 0  | 0  | 0  | 0  |
| 2033                 | 0  | 0  | 0  | 0  | 0  | 0  | 0  | 0  | 0  |
| 2034                 | 0  | 0  | 0  | 0  | 0  | 0  | 0  | 0  | 0  |
| 2035                 | 0  | 0  | 0  | 0  | 0  | 0  | 0  | 0  | 0  |
| 2036                 | 0  | 0  | 0  | 0  | 0  | 0  | 0  | 0  | 0  |
| 2037                 | 0  | 0  | 0  | 0  | 0  | 0  | 0  | 0  | 0  |
| 2038                 | 0  | 0  | 0  | 0  | 0  | 0  | 0  | 0  | 0  |
| 2039                 | 0  | 0  | 0  | 0  | 0  | 0  | 0  | 0  | 0  |
| 2040                 | 0  | 0  | 0  | 0  | 0  | 0  | 0  | 0  | 0  |
| 2041                 | 0  | 0  | 0  | 0  | 0  | 0  | 0  | 0  | 0  |
| 2042                 | 0  | 0  | 0  | 0  | 0  | 0  | 0  | 0  | 0  |
| 2043                 | 0  | 0  | 0  | 0  | 0  | 0  | 0  | 0  | 0  |
| 2044                 | 0  | 0  | 0  | 0  | 0  | 0  | 0  | 0  | 0  |
| 2045                 | 0  | 0  | 0  | 0  | 0  | 0  | 0  | 0  | 0  |
| 2046                 | 0  | 0  | 0  | 0  | 0  | 0  | 0  | 0  | 0  |
| 2047                 | 0  | 0  | 0  | 0  | 0  | 0  | 0  | 0  | 0  |
| 2048                 | 0  | 0  | 0  | 0  | 0  | 0  | 0  | 0  | 0  |
| 2049                 | 0  | 0  | 0  | 0  | 0  | 0  | 0  | 0  | 0  |
| 2050                 | 0  | 0  | 0  | 0  | 0  | 0  | 0  | 0  | 0  |
| 2051                 | 0  | 0  | 0  | 0  | 0  | 0  | 0  | 0  | 0  |



| ScenarioID /<br>Year | 37 | 38 | 39 | 40 | 41 | 42 | 43 | 44 | 45 |
|----------------------|----|----|----|----|----|----|----|----|----|
| 2052                 | 0  | 0  | 0  | 0  | 0  | 0  | 0  | 0  | 0  |
| 2053                 | 0  | 0  | 0  | 0  | 0  | 0  | 0  | 0  | 0  |
| 2054                 | 0  | 0  | 0  | 0  | 0  | 0  | 0  | 0  | 0  |
| 2055                 | 0  | 0  | 0  | 0  | 0  | 0  | 0  | 0  | 0  |
| 2056                 | 0  | 0  | 0  | 0  | 0  | 0  | 0  | 0  | 0  |
| 2057                 | 0  | 0  | 0  | 0  | 0  | 0  | 0  | 0  | 0  |
| 2058                 | 0  | 0  | 0  | 0  | 0  | 0  | 0  | 0  | 0  |
| 2059                 | 0  | 0  | 0  | 0  | 0  | 0  | 0  | 0  | 0  |
| 2060                 | 0  | 0  | 0  | 0  | 0  | 0  | 0  | 0  | 0  |
| 2061                 | 0  | 0  | 0  | 0  | 0  | 0  | 0  | 0  | 0  |
| 2062                 | 0  | 0  | 0  | 0  | 0  | 0  | 0  | 0  | 0  |
| 2063                 | 0  | 0  | 0  | 0  | 0  | 0  | 0  | 0  | 0  |
| 2064                 | 0  | 0  | 0  | 0  | 0  | 0  | 0  | 0  | 0  |
| 2065                 | 0  | 0  | 0  | 0  | 0  | 0  | 0  | 0  | 0  |
| 2066                 | 0  | 0  | 0  | 0  | 0  | 0  | 0  | 0  | 0  |
| 2067                 | 0  | 0  | 0  | 0  | 0  | 0  | 0  | 0  | 0  |
| 2068                 | 0  | 0  | 0  | 0  | 0  | 0  | 0  | 0  | 0  |
| 2069                 | 0  | 0  | 0  | 0  | 0  | 0  | 0  | 0  | 0  |
| 2070                 | 0  | 0  | 0  | 0  | 0  | 0  | 0  | 0  | 0  |
| 2071                 | 0  | 0  | 0  | 0  | 0  | 0  | 0  | 0  | 0  |
| 2072                 | 0  | 0  | 0  | 0  | 0  | 0  | 0  | 0  | 0  |
| 2073                 | 0  | 0  | 0  | 0  | 0  | 0  | 0  | 0  | 0  |
| 2074                 | 0  | 0  | 0  | 0  | 0  | 0  | 0  | 0  | 0  |
| 2075                 | 0  | 0  | 0  | 0  | 0  | 0  | 0  | 0  | 0  |
| 2076                 | 0  | 0  | 0  | 0  | 0  | 0  | 0  | 0  | 0  |
| 2077                 | 0  | 0  | 0  | 0  | 0  | 0  | 0  | 0  | 0  |
| 2078                 | 0  | 0  | 0  | 0  | 0  | 0  | 0  | 0  | 0  |
| 2079                 | 0  | 0  | 0  | 0  | 0  | 0  | 0  | 0  | 0  |
| 2080                 | 0  | 0  | 0  | 0  | 0  | 0  | 0  | 0  | 0  |
| 2081                 | 0  | 0  | 0  | 0  | 0  | 0  | 0  | 0  | 0  |
| 2082                 | 0  | 0  | 0  | 0  | 0  | 0  | 0  | 0  | 0  |
| 2083                 | 0  | 0  | 0  | 0  | 0  | 0  | 0  | 0  | 0  |
| 2084                 | 0  | 0  | 0  | 0  | 0  | 0  | 0  | 0  | 0  |
| 2085                 | 0  | 0  | 0  | 0  | 0  | 0  | 0  | 0  | 0  |
| 2086                 | 0  | 0  | 0  | 0  | 0  | 0  | 0  | 0  | 0  |
| 2087                 | 0  | 0  | 0  | 0  | 0  | 0  | 0  | 0  | 0  |
| 2088                 | 0  | 0  | 0  | 0  | 0  | 0  | 0  | 0  | 0  |
| 2089                 | 0  | 0  | 0  | 0  | 0  | 0  | 0  | 0  | 0  |
| 2090                 | 0  | 0  | 0  | 0  | 0  | 0  | 0  | 0  | 0  |

| ScenarioID / Year | 46 | 47 | 48 | 49 | 50 | 51 | 52 | 53 | 54 |
|-------------------|----|----|----|----|----|----|----|----|----|
| 2002              | 0  | 0  | 0  | 0  | 0  | 0  | 0  | 0  | 0  |
| 2003              | 0  | 0  | 0  | 0  | 0  | 0  | 0  | 0  | 0  |
| 2004              | 0  | 0  | 0  | 0  | 0  | 0  | 0  | 0  | 0  |
| 2005              | 0  | 0  | 0  | 0  | 0  | 0  | 0  | 0  | 0  |
| 2006              | 0  | 0  | 0  | 0  | 0  | 0  | 0  | 0  | 0  |
| 2007              | 0  | 0  | 0  | 0  | 0  | 0  | 0  | 0  | 0  |
| 2008              | 0  | 0  | 0  | 0  | 0  | 0  | 0  | 0  | 0  |
| 2009              | 0  | 0  | 0  | 0  | 0  | 0  | 0  | 0  | 0  |
| 2010              | 0  | 0  | 0  | 0  | 0  | 0  | 0  | 0  | 0  |
| 2011              | 0  | 0  | 0  | 0  | 0  | 0  | 0  | 0  | 0  |
| 2012              | 0  | 0  | 0  | 0  | 0  | 0  | 0  | 0  | 0  |
| 2013              | 0  | 0  | 0  | 0  | 0  | 0  | 0  | 0  | 0  |
| 2014              | 0  | 0  | 0  | 0  | 0  | 0  | 0  | 0  | 0  |
| 2015              | 0  | 0  | 0  | 0  | 0  | 0  | 0  | 0  | 0  |
| 2016              | 0  | 0  | 0  | 0  | 0  | 0  | 0  | 0  | 0  |
| 2017              | 0  | 0  | 0  | 0  | 0  | 0  | 0  | 0  | 0  |
| 2018              | 0  | 0  | 0  | 0  | 0  | 0  | 0  | 0  | 0  |
| 2019              | 0  | 0  | 0  | 0  | 0  | 0  | 0  | 0  | 0  |
| 2020              | 0  | 0  | 0  | 0  | 0  | 0  | 0  | 0  | 0  |
| 2021              | 0  | 0  | 0  | 0  | 0  | 0  | 0  | 0  | 0  |
| 2022              | 0  | 0  | 0  | 0  | 0  | 0  | 0  | 0  | 0  |
| 2023              | 0  | 0  | 0  | 0  | 0  | 0  | 0  | 0  | 0  |
| 2024              | 0  | 0  | 0  | 0  | 0  | 0  | 0  | 0  | 0  |
| 2025              | 0  | 0  | 0  | 0  | 0  | 0  | 0  | 0  | 0  |
| 2026              | 0  | 0  | 0  | 0  | 0  | 0  | 0  | 0  | 0  |
| 2027              | 0  | 0  | 0  | 0  | 0  | 0  | 0  | 0  | 0  |
| 2028              | 0  | 0  | 0  | 0  | 0  | 0  | 0  | 0  | 0  |
| 2029              | 0  | 0  | 0  | 0  | 0  | 0  | 0  | 0  | 0  |
| 2030              | 0  | 0  | 0  | 0  | 0  | 0  | 0  | 0  | 0  |
| 2031              | 0  | 0  | 0  | 0  | 0  | 0  | 0  | 0  | 0  |
| 2032              | 0  | 0  | 0  | 0  | 0  | 0  | 0  | 0  | 0  |
| 2033              | 0  | 0  | 0  | 0  | 0  | 0  | 0  | 0  | 0  |
| 2034              | 0  | 0  | 0  | 0  | 0  | 0  | 0  | 0  | 0  |
| 2035              | 0  | 0  | 0  | 0  | 0  | 0  | 0  | 0  | 0  |
| 2036              | 0  | 0  | 0  | 0  | 0  | 0  | 0  | 0  | 0  |
| 2037              | 0  | 0  | 0  | 0  | 0  | 0  | 0  | 0  | 0  |
| 2038              | 0  | 0  | 0  | 0  | 0  | 0  | 0  | 0  | 0  |
| 2039              | 0  | 0  | 0  | 0  | 0  | 0  | 0  | 0  | 0  |
| 2040              | 0  | 0  | 0  | 0  | 0  | 0  | 0  | 0  | 0  |
| 2041              | 0  | 0  | 0  | 0  | 0  | 0  | 0  | 0  | 0  |
| 2042              | 0  | 0  | 0  | 0  | 0  | 0  | 0  | 0  | 0  |
| 2043              | 0  | 0  | 0  | 0  | 0  | 0  | 0  | 0  | 0  |
| 2044              | 0  | 0  | 0  | 0  | 0  | 0  | 0  | 0  | 0  |
| 2045              | 0  | 0  | 0  | 0  | 0  | 0  | 0  | 0  | 0  |
| 2046              | 0  | 0  | 0  | 0  | 0  | 0  | 0  | 0  | 0  |
| 2047              | 0  | 0  | 0  | 0  | 0  | 0  | 0  | 0  | 0  |
| 2048              | 0  | 0  | 0  | 0  | 0  | 0  | 0  | 0  | 0  |
| 2049              | 0  | 0  | 0  | 0  | 0  | 0  | 0  | 0  | 0  |
| 2050              | 0  | 0  | 0  | 0  | 0  | 0  | 0  | 0  | 0  |
| 2051              | 0  | 0  | 0  | 0  | 0  | 0  | 0  | 0  | 0  |

| ScenarioID /<br>Year | 46 | 47 | 48 | 49 | 50 | 51 | 52 | 53 | 54 |
|----------------------|----|----|----|----|----|----|----|----|----|
| 2052                 | 0  | 0  | 0  | 0  | 0  | 0  | 0  | 0  | 0  |
| 2053                 | 0  | 0  | 0  | 0  | 0  | 0  | 0  | 0  | 0  |
| 2054                 | 0  | 0  | 0  | 0  | 0  | 0  | 0  | 0  | 0  |
| 2055                 | 0  | 0  | 0  | 0  | 0  | 0  | 0  | 0  | 0  |
| 2056                 | 0  | 0  | 0  | 0  | 0  | 0  | 0  | 0  | 0  |
| 2057                 | 0  | 0  | 0  | 0  | 0  | 0  | 0  | 0  | 0  |
| 2058                 | 0  | 0  | 0  | 0  | 0  | 0  | 0  | 0  | 0  |
| 2059                 | 0  | 0  | 0  | 0  | 0  | 0  | 0  | 0  | 0  |
| 2060                 | 0  | 0  | 0  | 0  | 0  | 0  | 0  | 0  | 0  |
| 2061                 | 0  | 0  | 0  | 0  | 0  | 0  | 0  | 0  | 0  |
| 2062                 | 0  | 0  | 0  | 0  | 0  | 0  | 0  | 0  | 0  |
| 2063                 | 0  | 0  | 0  | 0  | 0  | 0  | 0  | 0  | 0  |
| 2064                 | 0  | 0  | 0  | 0  | 0  | 0  | 0  | 0  | 0  |
| 2065                 | 0  | 0  | 0  | 0  | 0  | 0  | 0  | 0  | 0  |
| 2066                 | 0  | 0  | 0  | 0  | 0  | 0  | 0  | 0  | 0  |
| 2067                 | 0  | 0  | 0  | 0  | 0  | 0  | 0  | 0  | 0  |
| 2068                 | 0  | 0  | 0  | 0  | 0  | 0  | 0  | 0  | 0  |
| 2069                 | 0  | 0  | 0  | 0  | 0  | 0  | 0  | 0  | 0  |
| 2070                 | 0  | 0  | 0  | 0  | 0  | 0  | 0  | 0  | 0  |
| 2071                 | 0  | 0  | 0  | 0  | 0  | 0  | 0  | 0  | 0  |
| 2072                 | 0  | 0  | 0  | 0  | 0  | 0  | 0  | 0  | 0  |
| 2073                 | 0  | 0  | 0  | 0  | 0  | 0  | 0  | 0  | 0  |
| 2074                 | 0  | 0  | 0  | 0  | 0  | 0  | 0  | 0  | 0  |
| 2075                 | 0  | 0  | 0  | 0  | 0  | 0  | 0  | 0  | 0  |
| 2076                 | 0  | 0  | 0  | 0  | 0  | 0  | 0  | 0  | 0  |
| 2077                 | 0  | 0  | 0  | 0  | 0  | 0  | 0  | 0  | 0  |
| 2078                 | 0  | 0  | 0  | 0  | 0  | 0  | 0  | 0  | 0  |
| 2079                 | 0  | 0  | 0  | 0  | 0  | 0  | 0  | 0  | 0  |
| 2080                 | 0  | 0  | 0  | 0  | 0  | 0  | 0  | 0  | 0  |
| 2081                 | 0  | 0  | 0  | 0  | 0  | 0  | 0  | 0  | 0  |
| 2082                 | 0  | 0  | 0  | 0  | 0  | 0  | 0  | 0  | 0  |
| 2083                 | 0  | 0  | 0  | 0  | 0  | 0  | 0  | 0  | 0  |
| 2084                 | 0  | 0  | 0  | 0  | 0  | 0  | 0  | 0  | 0  |
| 2085                 | 0  | 0  | 0  | 0  | 0  | 0  | 0  | 0  | 0  |
| 2086                 | 0  | 0  | 0  | 0  | 0  | 0  | 0  | 0  | 0  |
| 2087                 | 0  | 0  | 0  | 0  | 0  | 0  | 0  | 0  | 0  |
| 2088                 | 0  | 0  | 0  | 0  | 0  | 0  | 0  | 0  | 0  |
| 2089                 | 0  | 0  | 0  | 0  | 0  | 0  | 0  | 0  | 0  |
| 2090                 | 0  | 0  | 0  | 0  | 0  | 0  | 0  | 0  | 0  |

| ScenarioID /<br>Year | 55  | 56  | 57  | 58  | 59  | 60  | 61  | 62  | 63  |
|----------------------|-----|-----|-----|-----|-----|-----|-----|-----|-----|
| 2002                 | 0   | 0   | 0   | 0   | 0   | 0   | 0   | 0   | 0   |
| 2003                 | 0   | 0   | 0   | 0   | 0   | 0   | 0   | 0   | 0   |
| 2004                 | 0   | 0   | 0   | 0   | 0   | 0   | 0   | 0   | 0   |
| 2005                 | 0   | 0   | 0   | 0   | 0   | 0   | 0   | 0   | 0   |
| 2006                 | 0   | 0   | 0   | 0   | 0   | 0   | 0   | 0   | 0   |
| 2007                 | 0   | 0   | 0   | 0   | 0   | 0   | 0   | 0   | 0   |
| 2008                 | 0   | 0   | 0   | 0   | 0   | 0   | 0   | 0   | 0   |
| 2009                 | 0   | 0   | 0   | 0   | 0   | 0   | 0   | 0   | 0   |
| 2010                 | 0   | 0   | 0   | 0   | 0   | 0   | 0   | 0   | 0   |
| 2011                 | 0   | 0   | 0   | 0   | 0   | 0   | 0   | 0   | 0   |
| 2012                 | 0   | 0   | 0   | 0   | 0   | 0   | 0   | 0   | 0   |
| 2013                 | 0   | 0   | 0   | 0   | 0   | 0   | 0   | 0   | 0   |
| 2014                 | 0   | 0   | 0   | 0   | 0   | 0   | 0   | 0   | 0   |
| 2015                 | 0   | 0   | 0   | 0   | 0   | 0   | 0   | 0   | 0   |
| 2016                 | 0   | 0   | 0   | 0   | 0   | 0   | 0   | 0   | 0   |
| 2017                 | 0   | 0   | 0   | 0   | 0   | 0   | 0   | 0   | 0   |
| 2018                 | 0   | 0   | 0   | 0   | 0   | 0   | 0   | 0   | 0   |
| 2019                 | 0   | 0   | 0   | 0   | 0   | 0   | 0   | 0   | 0   |
| 2020                 | 0   | 0   | 0   | 0   | 0   | 0   | 0   | 0   | 0   |
| 2021                 | 0   | 0   | 0   | 0   | 0   | 0   | 0   | 0   | 0   |
| 2022                 | 0   | 0   | 0   | 0   | 0   | 0   | 0   | 0   | 0   |
| 2023                 | 0   | 0   | 0   | 0   | 0   | 0   | 0   | 0   | 0   |
| 2024                 | 0   | 0   | 0   | 0   | 0   | 0   | 0   | 0   | 0   |
| 2025                 | 0   | 0   | 0   | 0   | 0   | 0   | 0   | 0   | 0   |
| 2026                 | 0   | 0   | 0   | 0   | 0   | 0   | 0   | 0   | 0   |
| 2027                 | 0   | 0   | 0   | 0   | 0   | 0   | 0   | 0   | 0   |
| 2028                 | 0   | 0   | 0   | 0   | 0   | 0   | 0   | 0   | 0   |
| 2029                 | 0   | 0   | 0   | 0   | 0   | 0   | 0   | 0   | 0   |
| 2030                 | 0   | 0   | 0   | 0   | 0   | 0   | 0   | 0   | 0   |
| 2031                 | 0   | 0   | 0   | 0   | 0   | 0   | 0   | 0   | 0   |
| 2032                 | 0   | 0   | 0   | 0   | 0   | 0   | 0   | 0   | 0   |
| 2033                 | 0   | 0   | 0   | 0   | 0   | 0   | 0   | 0   | 0   |
| 2034                 | 0   | 0   | 0   | 0   | 0   | 0   | 0   | 0   | 0   |
| 2035                 | 0   | 0   | 0   | 0   | 0   | 0   | 0   | 0   | 0   |
| 2036                 | 0   | 0   | 0   | 0   | 0   | 0   | 0   | 0   | 0   |
| 2037                 | 0   | 0   | 0   | 0   | 0   | 0   | 0   | 0   | 0   |
| 2038                 | 0   | 0   | 0   | 0   | 0   | 0   | 0   | 0   | 0   |
| 2039                 | 0   | 0   | 0   | 0   | 0   | 0   | 0   | 0   | 0   |
| 2040                 | 0   | 0   | 0   | 0   | 0   | 0   | 0   | 0   | 0   |
| 2041                 | 0   | 0   | 0   | 0   | 0   | 0   | 0   | 0   | 0   |
| 2042                 | 0   | 0   | 0   | 2   | 0   | 0   | 12  | 12  | 12  |
| 2043                 | 11  | 16  | 8   | 31  | 19  | 16  | 28  | 28  | 28  |
| 2044                 | 38  | 41  | 26  | 73  | 51  | 40  | 55  | 55  | 55  |
| 2045                 | 67  | 71  | 53  | 112 | 82  | 76  | 85  | 85  | 85  |
| 2046                 | 102 | 103 | 79  | 161 | 119 | 118 | 117 | 117 | 117 |
| 2047                 | 165 | 161 | 124 | 242 | 188 | 179 | 178 | 178 | 178 |
| 2048                 | 205 | 204 | 144 | 297 | 229 | 227 | 220 | 220 | 220 |
| 2049                 | 211 | 210 | 150 | 303 | 235 | 234 | 226 | 226 | 226 |
| 2050                 | 232 | 231 | 171 | 324 | 256 | 256 | 247 | 247 | 247 |
| 2051                 | 249 | 248 | 188 | 341 | 273 | 274 | 264 | 264 | 264 |

| ScenarioID /<br>Year | 55  | 56  | 57  | 58  | 59  | 60  | 61  | 62  | 63  |
|----------------------|-----|-----|-----|-----|-----|-----|-----|-----|-----|
| 2052                 | 252 | 251 | 191 | 344 | 276 | 277 | 267 | 267 | 267 |
| 2053                 | 252 | 251 | 191 | 344 | 276 | 277 | 267 | 267 | 267 |
| 2054                 | 262 | 261 | 201 | 354 | 286 | 287 | 277 | 277 | 277 |
| 2055                 | 264 | 261 | 201 | 354 | 288 | 287 | 277 | 277 | 277 |
| 2056                 | 274 | 269 | 208 | 360 | 298 | 293 | 286 | 286 | 286 |
| 2057                 | 274 | 270 | 209 | 361 | 298 | 293 | 287 | 287 | 287 |
| 2058                 | 274 | 270 | 209 | 361 | 298 | 293 | 287 | 287 | 287 |
| 2059                 | 274 | 270 | 209 | 361 | 298 | 293 | 287 | 287 | 287 |
| 2060                 | 274 | 270 | 209 | 361 | 298 | 293 | 287 | 287 | 287 |
| 2061                 | 274 | 270 | 209 | 361 | 298 | 293 | 287 | 287 | 287 |
| 2062                 | 274 | 270 | 209 | 361 | 298 | 293 | 287 | 287 | 287 |
| 2063                 | 274 | 270 | 209 | 361 | 298 | 293 | 287 | 287 | 287 |
| 2064                 | 274 | 270 | 209 | 361 | 298 | 293 | 287 | 287 | 287 |
| 2065                 | 274 | 270 | 209 | 361 | 298 | 293 | 287 | 287 | 287 |
| 2066                 | 274 | 270 | 209 | 361 | 298 | 293 | 287 | 287 | 287 |
| 2067                 | 274 | 270 | 209 | 361 | 298 | 293 | 287 | 287 | 287 |
| 2068                 | 274 | 270 | 209 | 361 | 298 | 293 | 287 | 287 | 287 |
| 2069                 | 274 | 270 | 209 | 361 | 298 | 293 | 287 | 287 | 287 |
| 2070                 | 274 | 270 | 209 | 361 | 298 | 293 | 287 | 287 | 287 |
| 2071                 | 274 | 270 | 209 | 361 | 298 | 293 | 287 | 287 | 287 |
| 2072                 | 274 | 270 | 209 | 361 | 298 | 293 | 287 | 287 | 287 |
| 2073                 | 274 | 270 | 209 | 361 | 298 | 293 | 287 | 287 | 287 |
| 2074                 | 274 | 270 | 209 | 361 | 298 | 293 | 287 | 287 | 287 |
| 2075                 | 274 | 270 | 209 | 361 | 298 | 293 | 287 | 287 | 287 |
| 2076                 | 274 | 270 | 209 | 361 | 298 | 293 | 287 | 287 | 287 |
| 2077                 | 274 | 270 | 209 | 361 | 298 | 293 | 287 | 287 | 287 |
| 2078                 | 274 | 270 | 209 | 361 | 298 | 293 | 287 | 287 | 287 |
| 2079                 | 274 | 270 | 209 | 361 | 298 | 293 | 287 | 287 | 287 |
| 2080                 | 274 | 270 | 209 | 361 | 298 | 293 | 287 | 287 | 287 |
| 2081                 | 274 | 270 | 209 | 361 | 298 | 293 | 287 | 287 | 287 |
| 2082                 | 274 | 270 | 209 | 361 | 298 | 293 | 287 | 287 | 287 |
| 2083                 | 274 | 270 | 209 | 361 | 298 | 293 | 287 | 287 | 287 |
| 2084                 | 274 | 270 | 209 | 361 | 298 | 293 | 287 | 287 | 287 |
| 2085                 | 274 | 270 | 209 | 361 | 298 | 293 | 287 | 287 | 287 |
| 2086                 | 274 | 270 | 209 | 361 | 298 | 293 | 287 | 287 | 287 |
| 2087                 | 274 | 270 | 209 | 361 | 298 | 293 | 287 | 287 | 287 |
| 2088                 | 274 | 270 | 209 | 361 | 298 | 293 | 287 | 287 | 287 |
| 2089                 | 274 | 270 | 209 | 361 | 298 | 293 | 287 | 287 | 287 |
| 2090                 | 274 | 270 | 209 | 361 | 298 | 293 | 287 | 287 | 287 |

| ScenarioID / Year | 64  | 65  | 66  | 67  | 68  | 69  | 70  | 71  | 72  |
|-------------------|-----|-----|-----|-----|-----|-----|-----|-----|-----|
| 2002              | 0   | 0   | 0   | 0   | 0   | 0   | 0   | 0   | 0   |
| 2003              | 0   | 0   | 0   | 0   | 0   | 0   | 0   | 0   | 0   |
| 2004              | 0   | 0   | 0   | 0   | 0   | 0   | 0   | 0   | 0   |
| 2005              | 0   | 0   | 0   | 0   | 0   | 0   | 0   | 0   | 0   |
| 2006              | 0   | 0   | 0   | 0   | 0   | 0   | 0   | 0   | 0   |
| 2007              | 0   | 0   | 0   | 0   | 0   | 0   | 0   | 0   | 0   |
| 2008              | 0   | 0   | 0   | 0   | 0   | 0   | 0   | 0   | 0   |
| 2009              | 0   | 0   | 0   | 0   | 0   | 0   | 0   | 0   | 0   |
| 2010              | 0   | 0   | 0   | 0   | 0   | 0   | 0   | 0   | 0   |
| 2011              | 0   | 0   | 0   | 0   | 0   | 0   | 0   | 0   | 0   |
| 2012              | 0   | 0   | 0   | 0   | 0   | 0   | 0   | 0   | 0   |
| 2013              | 0   | 0   | 0   | 0   | 0   | 0   | 0   | 0   | 0   |
| 2014              | 0   | 0   | 0   | 0   | 0   | 0   | 0   | 0   | 0   |
| 2015              | 0   | 0   | 0   | 0   | 0   | 0   | 0   | 0   | 0   |
| 2016              | 0   | 0   | 0   | 0   | 0   | 0   | 0   | 0   | 0   |
| 2017              | 0   | 0   | 0   | 0   | 0   | 0   | 0   | 0   | 0   |
| 2018              | 0   | 0   | 0   | 0   | 0   | 0   | 0   | 0   | 0   |
| 2019              | 0   | 0   | 0   | 0   | 0   | 0   | 0   | 0   | 0   |
| 2020              | 0   | 0   | 0   | 0   | 0   | 0   | 0   | 0   | 0   |
| 2021              | 0   | 0   | 0   | 0   | 0   | 0   | 0   | 0   | 0   |
| 2022              | 0   | 0   | 0   | 0   | 0   | 0   | 0   | 0   | 0   |
| 2023              | 0   | 0   | 0   | 0   | 0   | 0   | 0   | 0   | 0   |
| 2024              | 0   | 0   | 0   | 0   | 0   | 0   | 0   | 0   | 0   |
| 2025              | 0   | 0   | 0   | 0   | 0   | 0   | 0   | 0   | 0   |
| 2026              | 0   | 0   | 0   | 0   | 0   | 0   | 0   | 0   | 0   |
| 2027              | 0   | 0   | 0   | 0   | 0   | 0   | 0   | 0   | 0   |
| 2028              | 0   | 0   | 0   | 0   | 0   | 0   | 0   | 0   | 0   |
| 2029              | 0   | 0   | 0   | 0   | 0   | 0   | 0   | 0   | 0   |
| 2030              | 0   | 0   | 0   | 0   | 0   | 0   | 0   | 0   | 0   |
| 2031              | 0   | 0   | 0   | 0   | 0   | 0   | 0   | 0   | 0   |
| 2032              | 0   | 0   | 0   | 0   | 0   | 0   | 0   | 0   | 0   |
| 2033              | 0   | 0   | 0   | 0   | 0   | 0   | 0   | 0   | 0   |
| 2034              | 0   | 0   | 0   | 0   | 0   | 0   | 0   | 0   | 0   |
| 2035              | 0   | 0   | 0   | 0   | 0   | 0   | 0   | 0   | 0   |
| 2036              | 0   | 0   | 0   | 0   | 0   | 0   | 0   | 0   | 0   |
| 2037              | 0   | 0   | 0   | 0   | 0   | 0   | 0   | 0   | 0   |
| 2038              | 0   | 0   | 0   | 0   | 0   | 0   | 0   | 0   | 0   |
| 2039              | 0   | 0   | 0   | 0   | 0   | 0   | 0   | 0   | 0   |
| 2040              | 0   | 0   | 0   | 8   | 0   | 0   | 0   | 0   | 0   |
| 2041              | 0   | 0   | 0   | 8   | 0   | 0   | 0   | 0   | 0   |
| 2042              | 0   | 0   | 0   | 9   | 0   | 0   | 0   | 0   | 0   |
| 2043              | 16  | 16  | 10  | 38  | 20  | 15  | 16  | 16  | 16  |
| 2044              | 45  | 41  | 28  | 80  | 52  | 38  | 43  | 43  | 43  |
| 2045              | 86  | 70  | 55  | 126 | 83  | 74  | 73  | 73  | 73  |
| 2046              | 117 | 99  | 83  | 178 | 121 | 112 | 104 | 104 | 104 |
| 2047              | 179 | 155 | 129 | 254 | 197 | 169 | 166 | 166 | 166 |
| 2048              | 222 | 195 | 152 | 308 | 239 | 212 | 209 | 209 | 209 |
| 2049              | 228 | 202 | 158 | 314 | 245 | 219 | 215 | 215 | 215 |
| 2050              | 249 | 223 | 179 | 335 | 266 | 241 | 236 | 236 | 236 |
| 2051              | 266 | 240 | 196 | 352 | 283 | 259 | 253 | 253 | 253 |

| ScenarioID /<br>Year | 64  | 65  | 66  | 67  | 68  | 69  | 70  | 71  | 72  |
|----------------------|-----|-----|-----|-----|-----|-----|-----|-----|-----|
| 2052                 | 269 | 243 | 199 | 355 | 286 | 262 | 256 | 256 | 256 |
| 2053                 | 269 | 243 | 199 | 355 | 286 | 262 | 256 | 256 | 256 |
| 2054                 | 279 | 253 | 209 | 365 | 296 | 272 | 266 | 266 | 266 |
| 2055                 | 279 | 253 | 209 | 365 | 298 | 272 | 266 | 266 | 266 |
| 2056                 | 288 | 260 | 216 | 372 | 308 | 276 | 275 | 275 | 275 |
| 2057                 | 289 | 261 | 217 | 373 | 308 | 277 | 276 | 276 | 276 |
| 2058                 | 289 | 261 | 217 | 373 | 308 | 277 | 276 | 276 | 276 |
| 2059                 | 289 | 261 | 217 | 373 | 308 | 277 | 276 | 276 | 276 |
| 2060                 | 289 | 261 | 217 | 373 | 308 | 277 | 276 | 276 | 276 |
| 2061                 | 289 | 261 | 217 | 373 | 308 | 277 | 276 | 276 | 276 |
| 2062                 | 289 | 261 | 217 | 373 | 308 | 277 | 276 | 276 | 276 |
| 2063                 | 289 | 261 | 217 | 373 | 308 | 277 | 276 | 276 | 276 |
| 2064                 | 289 | 261 | 217 | 373 | 308 | 277 | 276 | 276 | 276 |
| 2065                 | 289 | 261 | 217 | 373 | 308 | 277 | 276 | 276 | 276 |
| 2066                 | 289 | 261 | 217 | 373 | 308 | 277 | 276 | 276 | 276 |
| 2067                 | 289 | 261 | 217 | 373 | 308 | 277 | 276 | 276 | 276 |
| 2068                 | 289 | 261 | 217 | 373 | 308 | 277 | 276 | 276 | 276 |
| 2069                 | 289 | 261 | 217 | 373 | 308 | 277 | 276 | 276 | 276 |
| 2070                 | 289 | 261 | 217 | 373 | 308 | 277 | 276 | 276 | 276 |
| 2071                 | 289 | 261 | 217 | 373 | 308 | 277 | 276 | 276 | 276 |
| 2072                 | 289 | 261 | 217 | 373 | 308 | 277 | 276 | 276 | 276 |
| 2073                 | 289 | 261 | 217 | 373 | 308 | 277 | 276 | 276 | 276 |
| 2074                 | 289 | 261 | 217 | 373 | 308 | 277 | 276 | 276 | 276 |
| 2075                 | 289 | 261 | 217 | 373 | 308 | 277 | 276 | 276 | 276 |
| 2076                 | 289 | 261 | 217 | 373 | 308 | 277 | 276 | 276 | 276 |
| 2077                 | 289 | 261 | 217 | 373 | 308 | 277 | 276 | 276 | 276 |
| 2078                 | 289 | 261 | 217 | 373 | 308 | 277 | 276 | 276 | 276 |
| 2079                 | 289 | 261 | 217 | 373 | 308 | 277 | 276 | 276 | 276 |
| 2080                 | 289 | 261 | 217 | 373 | 308 | 277 | 276 | 276 | 276 |
| 2081                 | 289 | 261 | 217 | 373 | 308 | 277 | 276 | 276 | 276 |
| 2082                 | 289 | 261 | 217 | 373 | 308 | 277 | 276 | 276 | 276 |
| 2083                 | 289 | 261 | 217 | 373 | 308 | 277 | 276 | 276 | 276 |
| 2084                 | 289 | 261 | 217 | 373 | 308 | 277 | 276 | 276 | 276 |
| 2085                 | 289 | 261 | 217 | 373 | 308 | 277 | 276 | 276 | 276 |
| 2086                 | 289 | 261 | 217 | 373 | 308 | 277 | 276 | 276 | 276 |
| 2087                 | 289 | 261 | 217 | 373 | 308 | 277 | 276 | 276 | 276 |
| 2088                 | 289 | 261 | 217 | 373 | 308 | 277 | 276 | 276 | 276 |
| 2089                 | 289 | 261 | 217 | 373 | 308 | 277 | 276 | 276 | 276 |
| 2090                 | 289 | 261 | 217 | 373 | 308 | 277 | 276 | 276 | 276 |

| ScenarioID / Year | 73  | 74  | 75  | 76  | 77  | 78  | 79  | 80  | 81  |
|-------------------|-----|-----|-----|-----|-----|-----|-----|-----|-----|
| 2002              | 0   | 0   | 0   | 0   | 0   | 0   | 0   | 0   | 0   |
| 2003              | 0   | 0   | 0   | 0   | 0   | 0   | 0   | 0   | 0   |
| 2004              | 0   | 0   | 0   | 0   | 0   | 0   | 0   | 0   | 0   |
| 2005              | 0   | 0   | 0   | 0   | 0   | 0   | 0   | 0   | 0   |
| 2006              | 0   | 0   | 0   | 0   | 0   | 0   | 0   | 0   | 0   |
| 2007              | 0   | 0   | 0   | 0   | 0   | 0   | 0   | 0   | 0   |
| 2008              | 0   | 0   | 0   | 0   | 0   | 0   | 0   | 0   | 0   |
| 2009              | 0   | 0   | 0   | 0   | 0   | 0   | 0   | 0   | 0   |
| 2010              | 0   | 0   | 0   | 0   | 0   | 0   | 0   | 0   | 0   |
| 2011              | 0   | 0   | 0   | 0   | 0   | 0   | 0   | 0   | 0   |
| 2012              | 0   | 0   | 0   | 0   | 0   | 0   | 0   | 0   | 0   |
| 2013              | 0   | 0   | 0   | 0   | 0   | 0   | 0   | 0   | 0   |
| 2014              | 0   | 0   | 0   | 0   | 0   | 0   | 0   | 0   | 0   |
| 2015              | 0   | 0   | 0   | 0   | 0   | 0   | 0   | 0   | 0   |
| 2016              | 0   | 0   | 0   | 0   | 0   | 0   | 0   | 0   | 0   |
| 2017              | 0   | 0   | 0   | 0   | 0   | 0   | 0   | 0   | 0   |
| 2018              | 0   | 0   | 0   | 0   | 0   | 0   | 0   | 0   | 0   |
| 2019              | 0   | 0   | 0   | 0   | 0   | 0   | 0   | 0   | 0   |
| 2020              | 0   | 0   | 0   | 0   | 0   | 0   | 0   | 0   | 0   |
| 2021              | 0   | 0   | 0   | 0   | 0   | 0   | 0   | 0   | 0   |
| 2022              | 0   | 0   | 0   | 0   | 0   | 0   | 0   | 0   | 0   |
| 2023              | 0   | 0   | 0   | 0   | 0   | 0   | 0   | 0   | 0   |
| 2024              | 0   | 0   | 0   | 0   | 0   | 0   | 0   | 0   | 0   |
| 2025              | 0   | 0   | 0   | 0   | 0   | 0   | 0   | 0   | 0   |
| 2026              | 0   | 0   | 0   | 0   | 0   | 0   | 0   | 0   | 0   |
| 2027              | 0   | 0   | 0   | 0   | 0   | 0   | 0   | 0   | 0   |
| 2028              | 0   | 0   | 0   | 0   | 0   | 0   | 0   | 0   | 0   |
| 2029              | 0   | 0   | 0   | 0   | 0   | 0   | 0   | 0   | 0   |
| 2030              | 0   | 0   | 0   | 0   | 0   | 0   | 0   | 0   | 0   |
| 2031              | 0   | 0   | 0   | 0   | 0   | 0   | 0   | 0   | 0   |
| 2032              | 0   | 0   | 0   | 0   | 0   | 0   | 0   | 0   | 0   |
| 2033              | 0   | 0   | 0   | 0   | 0   | 0   | 0   | 0   | 0   |
| 2034              | 0   | 0   | 0   | 0   | 0   | 0   | 0   | 0   | 0   |
| 2035              | 0   | 0   | 0   | 0   | 0   | 0   | 0   | 0   | 0   |
| 2036              | 0   | 0   | 0   | 0   | 0   | 0   | 0   | 0   | 0   |
| 2037              | 0   | 0   | 0   | 0   | 0   | 0   | 0   | 0   | 0   |
| 2038              | 0   | 0   | 0   | 0   | 0   | 0   | 0   | 0   | 0   |
| 2039              | 0   | 0   | 0   | 0   | 0   | 0   | 0   | 0   | 0   |
| 2040              | 0   | 0   | 0   | 0   | 0   | 0   | 0   | 0   | 0   |
| 2041              | 0   | 0   | 0   | 0   | 0   | 0   | 0   | 0   | 0   |
| 2042              | 0   | 0   | 0   | 0   | 0   | 0   | 0   | 0   | 0   |
| 2043              | 17  | 20  | 10  | 29  | 21  | 16  | 19  | 19  | 19  |
| 2044              | 47  | 53  | 28  | 67  | 55  | 41  | 49  | 49  | 49  |
| 2045              | 76  | 84  | 56  | 109 | 86  | 78  | 80  | 80  | 80  |
| 2046              | 120 | 123 | 83  | 180 | 125 | 119 | 117 | 117 | 117 |
| 2047              | 187 | 193 | 133 | 262 | 195 | 177 | 186 | 186 | 186 |
| 2048              | 230 | 235 | 154 | 320 | 239 | 229 | 227 | 227 | 227 |
| 2049              | 236 | 241 | 160 | 327 | 245 | 235 | 233 | 233 | 233 |
| 2050              | 257 | 262 | 181 | 348 | 266 | 257 | 254 | 254 | 254 |
| 2051              | 274 | 279 | 198 | 365 | 283 | 275 | 271 | 271 | 271 |



| ScenarioID /<br>Year | 73  | 74  | 75  | 76  | 77  | 78  | 79  | 80  | 81  |
|----------------------|-----|-----|-----|-----|-----|-----|-----|-----|-----|
| 2052                 | 277 | 282 | 201 | 368 | 286 | 278 | 274 | 274 | 274 |
| 2053                 | 277 | 282 | 201 | 368 | 286 | 278 | 274 | 274 | 274 |
| 2054                 | 287 | 292 | 211 | 378 | 296 | 288 | 284 | 284 | 284 |
| 2055                 | 289 | 294 | 211 | 380 | 298 | 288 | 286 | 286 | 286 |
| 2056                 | 299 | 304 | 218 | 390 | 308 | 296 | 296 | 296 | 296 |
| 2057                 | 299 | 304 | 219 | 390 | 308 | 297 | 296 | 296 | 296 |
| 2058                 | 299 | 304 | 219 | 390 | 308 | 297 | 296 | 296 | 296 |
| 2059                 | 299 | 304 | 219 | 390 | 308 | 297 | 296 | 296 | 296 |
| 2060                 | 299 | 304 | 219 | 390 | 308 | 297 | 296 | 296 | 296 |
| 2061                 | 299 | 304 | 219 | 390 | 308 | 297 | 296 | 296 | 296 |
| 2062                 | 299 | 304 | 219 | 390 | 308 | 297 | 296 | 296 | 296 |
| 2063                 | 299 | 304 | 219 | 390 | 308 | 297 | 296 | 296 | 296 |
| 2064                 | 299 | 304 | 219 | 390 | 308 | 297 | 296 | 296 | 296 |
| 2065                 | 299 | 304 | 219 | 390 | 308 | 297 | 296 | 296 | 296 |
| 2066                 | 299 | 304 | 219 | 390 | 308 | 297 | 296 | 296 | 296 |
| 2067                 | 299 | 304 | 219 | 390 | 308 | 297 | 296 | 296 | 296 |
| 2068                 | 299 | 304 | 219 | 390 | 308 | 297 | 296 | 296 | 296 |
| 2069                 | 299 | 304 | 219 | 390 | 308 | 297 | 296 | 296 | 296 |
| 2070                 | 299 | 304 | 219 | 390 | 308 | 297 | 296 | 296 | 296 |
| 2071                 | 299 | 304 | 219 | 390 | 308 | 297 | 296 | 296 | 296 |
| 2072                 | 299 | 304 | 219 | 390 | 308 | 297 | 296 | 296 | 296 |
| 2073                 | 299 | 304 | 219 | 390 | 308 | 297 | 296 | 296 | 296 |
| 2074                 | 299 | 304 | 219 | 390 | 308 | 297 | 296 | 296 | 296 |
| 2075                 | 299 | 304 | 219 | 390 | 308 | 297 | 296 | 296 | 296 |
| 2076                 | 299 | 304 | 219 | 390 | 308 | 297 | 296 | 296 | 296 |
| 2077                 | 299 | 304 | 219 | 390 | 308 | 297 | 296 | 296 | 296 |
| 2078                 | 299 | 304 | 219 | 390 | 308 | 297 | 296 | 296 | 296 |
| 2079                 | 299 | 304 | 219 | 390 | 308 | 297 | 296 | 296 | 296 |
| 2080                 | 299 | 304 | 219 | 390 | 308 | 297 | 296 | 296 | 296 |
| 2081                 | 299 | 304 | 219 | 390 | 308 | 297 | 296 | 296 | 296 |
| 2082                 | 299 | 304 | 219 | 390 | 308 | 297 | 296 | 296 | 296 |
| 2083                 | 299 | 304 | 219 | 390 | 308 | 297 | 296 | 296 | 296 |
| 2084                 | 299 | 304 | 219 | 390 | 308 | 297 | 296 | 296 | 296 |
| 2085                 | 299 | 304 | 219 | 390 | 308 | 297 | 296 | 296 | 296 |
| 2086                 | 299 | 304 | 219 | 390 | 308 | 297 | 296 | 296 | 296 |
| 2087                 | 299 | 304 | 219 | 390 | 308 | 297 | 296 | 296 | 296 |
| 2088                 | 299 | 304 | 219 | 390 | 308 | 297 | 296 | 296 | 296 |
| 2089                 | 299 | 304 | 219 | 390 | 308 | 297 | 296 | 296 | 296 |
| 2090                 | 299 | 304 | 219 | 390 | 308 | 297 | 296 | 296 | 296 |

| ScenarioID /<br>Year | 1    | 2   | 3   | 4   | 5   | 6   | 7   | 8   | 9   |
|----------------------|------|-----|-----|-----|-----|-----|-----|-----|-----|
| 2002                 | 0    | 0   | 0   | 0   | 0   | 0   | 0   | 0   | 0   |
| 2003                 | 0    | 0   | 0   | 0   | 0   | 0   | 0   | 0   | 0   |
| 2004                 | 1    | 1   | 1   | 1   | 1   | 1   | 1   | 1   | 1   |
| 2005                 | 3    | 3   | 3   | 3   | 3   | 3   | 3   | 3   | 3   |
| 2006                 | 14   | 14  | 14  | 14  | 14  | 14  | 14  | 14  | 14  |
| 2007                 | 33   | 33  | 33  | 33  | 33  | 33  | 33  | 33  | 33  |
| 2008                 | 67   | 67  | 67  | 67  | 67  | 67  | 67  | 67  | 67  |
| 2009                 | 128  | 128 | 128 | 128 | 128 | 128 | 128 | 128 | 128 |
| 2010                 | 210  | 210 | 210 | 210 | 210 | 210 | 210 | 210 | 210 |
| 2011                 | 313  | 313 | 313 | 313 | 313 | 313 | 313 | 313 | 313 |
| 2012                 | 418  | 313 | 418 | 418 | 418 | 418 | 418 | 418 | 418 |
| 2013                 | 547  | 313 | 547 | 547 | 547 | 547 | 547 | 547 | 547 |
| 2014                 | 665  | 313 | 665 | 665 | 665 | 665 | 665 | 665 | 665 |
| 2015                 | 814  | 313 | 814 | 814 | 814 | 814 | 814 | 814 | 814 |
| 2016                 | 957  | 313 | 814 | 814 | 814 | 814 | 814 | 814 | 814 |
| 2017                 | 1109 | 313 | 814 | 814 | 814 | 814 | 814 | 814 | 814 |
| 2018                 | 1276 | 313 | 814 | 814 | 814 | 814 | 814 | 814 | 814 |
| 2019                 | 1449 | 313 | 814 | 814 | 814 | 814 | 814 | 814 | 814 |
| 2020                 | 1449 | 313 | 814 | 814 | 814 | 814 | 814 | 814 | 814 |
| 2021                 | 1449 | 313 | 814 | 814 | 814 | 814 | 814 | 814 | 814 |
| 2022                 | 1449 | 313 | 814 | 814 | 814 | 814 | 814 | 814 | 814 |
| 2023                 | 1449 | 313 | 814 | 814 | 814 | 814 | 814 | 814 | 814 |
| 2024                 | 1449 | 313 | 814 | 814 | 814 | 814 | 814 | 814 | 814 |
| 2025                 | 1449 | 313 | 814 | 814 | 814 | 814 | 814 | 814 | 814 |
| 2026                 | 1449 | 313 | 814 | 814 | 814 | 814 | 814 | 814 | 814 |
| 2027                 | 1449 | 313 | 814 | 814 | 814 | 814 | 814 | 814 | 814 |
| 2028                 | 1449 | 313 | 814 | 814 | 814 | 814 | 814 | 814 | 814 |
| 2029                 | 1449 | 313 | 814 | 814 | 814 | 814 | 814 | 814 | 814 |
| 2030                 | 1449 | 313 | 814 | 814 | 814 | 814 | 814 | 814 | 814 |
| 2031                 | 1449 | 313 | 814 | 814 | 814 | 814 | 814 | 814 | 814 |
| 2032                 | 1449 | 313 | 814 | 814 | 814 | 814 | 814 | 814 | 814 |
| 2033                 | 1449 | 313 | 814 | 814 | 814 | 814 | 814 | 814 | 814 |
| 2034                 | 1449 | 313 | 814 | 814 | 814 | 814 | 814 | 814 | 814 |
| 2035                 | 1449 | 313 | 814 | 814 | 814 | 814 | 814 | 814 | 814 |
| 2036                 | 1449 | 313 | 814 | 814 | 814 | 814 | 814 | 814 | 814 |
| 2037                 | 1449 | 313 | 814 | 814 | 814 | 814 | 814 | 814 | 814 |
| 2038                 | 1449 | 313 | 814 | 814 | 814 | 814 | 814 | 814 | 814 |
| 2039                 | 1449 | 313 | 814 | 814 | 814 | 814 | 814 | 814 | 814 |
| 2040                 | 1449 | 313 | 814 | 814 | 814 | 814 | 814 | 814 | 814 |
| 2041                 | 1449 | 313 | 814 | 814 | 814 | 814 | 814 | 814 | 814 |
| 2042                 | 1449 | 313 | 814 | 814 | 814 | 814 | 814 | 814 | 814 |
| 2043                 | 1449 | 313 | 814 | 814 | 814 | 814 | 814 | 814 | 814 |
| 2044                 | 1449 | 313 | 814 | 814 | 814 | 814 | 814 | 814 | 814 |
| 2045                 | 1449 | 313 | 814 | 814 | 814 | 814 | 814 | 814 | 814 |
| 2046                 | 1449 | 313 | 814 | 814 | 814 | 814 | 814 | 814 | 814 |
| 2047                 | 1449 | 313 | 814 | 814 | 814 | 814 | 814 | 814 | 814 |
| 2048                 | 1449 | 313 | 814 | 814 | 814 | 814 | 814 | 814 | 814 |
| 2049                 | 1449 | 313 | 814 | 814 | 814 | 814 | 814 | 814 | 814 |
| 2050                 | 1449 | 313 | 814 | 814 | 814 | 814 | 814 | 814 | 814 |
| 2051                 | 1449 | 313 | 814 | 814 | 814 | 814 | 814 | 814 | 814 |

| ScenarioID /<br>Year | 1    | 2   | 3   | 4   | 5   | 6   | 7   | 8   | 9   |
|----------------------|------|-----|-----|-----|-----|-----|-----|-----|-----|
| 2052                 | 1449 | 313 | 814 | 814 | 814 | 814 | 814 | 814 | 814 |
| 2053                 | 1449 | 313 | 814 | 814 | 814 | 814 | 814 | 814 | 814 |
| 2054                 | 1449 | 313 | 814 | 814 | 814 | 814 | 814 | 814 | 814 |
| 2055                 | 1449 | 313 | 814 | 814 | 814 | 814 | 814 | 814 | 814 |
| 2056                 | 1449 | 313 | 814 | 814 | 814 | 814 | 814 | 814 | 814 |
| 2057                 | 1449 | 313 | 814 | 814 | 814 | 814 | 814 | 814 | 814 |
| 2058                 | 1449 | 313 | 814 | 814 | 814 | 814 | 814 | 814 | 814 |
| 2059                 | 1449 | 313 | 814 | 814 | 814 | 814 | 814 | 814 | 814 |
| 2060                 | 1449 | 313 | 814 | 814 | 814 | 814 | 814 | 814 | 814 |
| 2061                 | 1449 | 313 | 814 | 814 | 814 | 814 | 814 | 814 | 814 |
| 2062                 | 1449 | 313 | 814 | 814 | 814 | 814 | 814 | 814 | 814 |
| 2063                 | 1449 | 313 | 814 | 814 | 814 | 814 | 814 | 814 | 814 |
| 2064                 | 1449 | 313 | 814 | 814 | 814 | 814 | 814 | 814 | 814 |
| 2065                 | 1449 | 313 | 814 | 814 | 814 | 814 | 814 | 814 | 814 |
| 2066                 | 1449 | 313 | 814 | 814 | 814 | 814 | 814 | 814 | 814 |
| 2067                 | 1449 | 313 | 814 | 814 | 814 | 814 | 814 | 814 | 814 |
| 2068                 | 1449 | 313 | 814 | 814 | 814 | 814 | 814 | 814 | 814 |
| 2069                 | 1449 | 313 | 814 | 814 | 814 | 814 | 814 | 814 | 814 |
| 2070                 | 1449 | 313 | 814 | 814 | 814 | 814 | 814 | 814 | 814 |
| 2071                 | 1449 | 313 | 814 | 814 | 814 | 814 | 814 | 814 | 814 |
| 2072                 | 1449 | 313 | 814 | 814 | 814 | 814 | 814 | 814 | 814 |
| 2073                 | 1449 | 313 | 814 | 814 | 814 | 814 | 814 | 814 | 814 |
| 2074                 | 1449 | 313 | 814 | 814 | 814 | 814 | 814 | 814 | 814 |
| 2075                 | 1449 | 313 | 814 | 814 | 814 | 814 | 814 | 814 | 814 |
| 2076                 | 1449 | 313 | 814 | 814 | 814 | 814 | 814 | 814 | 814 |
| 2077                 | 1449 | 313 | 814 | 814 | 814 | 814 | 814 | 814 | 814 |
| 2078                 | 1449 | 313 | 814 | 814 | 814 | 814 | 814 | 814 | 814 |
| 2079                 | 1449 | 313 | 814 | 814 | 814 | 814 | 814 | 814 | 814 |
| 2080                 | 1449 | 313 | 814 | 814 | 814 | 814 | 814 | 814 | 814 |
| 2081                 | 1449 | 313 | 814 | 814 | 814 | 814 | 814 | 814 | 814 |
| 2082                 | 1449 | 313 | 814 | 814 | 814 | 814 | 814 | 814 | 814 |
| 2083                 | 1449 | 313 | 814 | 814 | 814 | 814 | 814 | 814 | 814 |
| 2084                 | 1449 | 313 | 814 | 814 | 814 | 814 | 814 | 814 | 814 |
| 2085                 | 1449 | 313 | 814 | 814 | 814 | 814 | 814 | 814 | 814 |
| 2086                 | 1449 | 313 | 814 | 814 | 814 | 814 | 814 | 814 | 814 |
| 2087                 | 1449 | 313 | 814 | 814 | 814 | 814 | 814 | 814 | 814 |
| 2088                 | 1449 | 313 | 814 | 814 | 814 | 814 | 814 | 814 | 814 |
| 2089                 | 1449 | 313 | 814 | 814 | 814 | 814 | 814 | 814 | 814 |
| 2090                 | 1449 | 313 | 814 | 814 | 814 | 814 | 814 | 814 | 814 |

| ScenarioID / Year | 10   | 11  | 12  | 13  | 14  | 15  | 16  | 17  | 18  |
|-------------------|------|-----|-----|-----|-----|-----|-----|-----|-----|
| 2002              | 0    | 0   | 0   | 0   | 0   | 0   | 0   | 0   | 0   |
| 2003              | 0    | 0   | 0   | 0   | 0   | 0   | 0   | 0   | 0   |
| 2004              | 1    | 1   | 1   | 1   | 1   | 1   | 1   | 1   | 1   |
| 2005              | 3    | 3   | 3   | 3   | 3   | 3   | 3   | 3   | 3   |
| 2006              | 14   | 14  | 14  | 14  | 14  | 14  | 14  | 14  | 14  |
| 2007              | 33   | 33  | 33  | 33  | 33  | 33  | 33  | 33  | 33  |
| 2008              | 67   | 67  | 67  | 67  | 67  | 67  | 67  | 67  | 67  |
| 2009              | 128  | 128 | 128 | 128 | 128 | 128 | 128 | 128 | 128 |
| 2010              | 210  | 210 | 210 | 210 | 210 | 210 | 210 | 210 | 210 |
| 2011              | 313  | 313 | 313 | 313 | 313 | 313 | 313 | 313 | 313 |
| 2012              | 418  | 313 | 418 | 418 | 418 | 418 | 418 | 418 | 418 |
| 2013              | 547  | 313 | 547 | 547 | 547 | 547 | 547 | 547 | 547 |
| 2014              | 665  | 313 | 665 | 665 | 665 | 665 | 665 | 665 | 665 |
| 2015              | 814  | 313 | 814 | 814 | 814 | 814 | 814 | 814 | 814 |
| 2016              | 957  | 313 | 814 | 814 | 814 | 814 | 814 | 814 | 814 |
| 2017              | 1109 | 313 | 814 | 814 | 814 | 814 | 814 | 814 | 814 |
| 2018              | 1276 | 313 | 814 | 814 | 814 | 814 | 814 | 814 | 814 |
| 2019              | 1449 | 313 | 814 | 814 | 814 | 814 | 814 | 814 | 814 |
| 2020              | 1449 | 313 | 814 | 814 | 814 | 814 | 814 | 814 | 814 |
| 2021              | 1449 | 313 | 814 | 814 | 814 | 814 | 814 | 814 | 814 |
| 2022              | 1449 | 313 | 814 | 814 | 814 | 814 | 814 | 814 | 814 |
| 2023              | 1449 | 313 | 814 | 814 | 814 | 814 | 814 | 814 | 814 |
| 2024              | 1449 | 313 | 814 | 814 | 814 | 814 | 814 | 814 | 814 |
| 2025              | 1449 | 313 | 814 | 814 | 814 | 814 | 814 | 814 | 814 |
| 2026              | 1449 | 313 | 814 | 814 | 814 | 814 | 814 | 814 | 814 |
| 2027              | 1449 | 313 | 814 | 814 | 814 | 814 | 814 | 814 | 814 |
| 2028              | 1449 | 313 | 814 | 814 | 814 | 814 | 814 | 814 | 814 |
| 2029              | 1449 | 313 | 814 | 814 | 814 | 814 | 814 | 814 | 814 |
| 2030              | 1449 | 313 | 814 | 814 | 814 | 814 | 814 | 814 | 814 |
| 2031              | 1449 | 313 | 814 | 814 | 814 | 814 | 814 | 814 | 814 |
| 2032              | 1449 | 313 | 814 | 814 | 814 | 814 | 814 | 814 | 814 |
| 2033              | 1449 | 313 | 814 | 814 | 814 | 814 | 814 | 814 | 814 |
| 2034              | 1449 | 313 | 814 | 814 | 814 | 814 | 814 | 814 | 814 |
| 2035              | 1449 | 313 | 814 | 814 | 814 | 814 | 814 | 814 | 814 |
| 2036              | 1449 | 313 | 814 | 814 | 814 | 814 | 814 | 814 | 814 |
| 2037              | 1449 | 313 | 814 | 814 | 814 | 814 | 814 | 814 | 814 |
| 2038              | 1449 | 313 | 814 | 814 | 814 | 814 | 814 | 814 | 814 |
| 2039              | 1449 | 313 | 814 | 814 | 814 | 814 | 814 | 814 | 814 |
| 2040              | 1449 | 313 | 814 | 814 | 814 | 814 | 814 | 814 | 814 |
| 2041              | 1449 | 313 | 814 | 814 | 814 | 814 | 814 | 814 | 814 |
| 2042              | 1449 | 313 | 814 | 814 | 814 | 814 | 814 | 814 | 814 |
| 2043              | 1449 | 313 | 814 | 814 | 814 | 814 | 814 | 814 | 814 |
| 2044              | 1449 | 313 | 814 | 814 | 814 | 814 | 814 | 814 | 814 |
| 2045              | 1449 | 313 | 814 | 814 | 814 | 814 | 814 | 814 | 814 |
| 2046              | 1449 | 313 | 814 | 814 | 814 | 814 | 814 | 814 | 814 |
| 2047              | 1449 | 313 | 814 | 814 | 814 | 814 | 814 | 814 | 814 |
| 2048              | 1449 | 313 | 814 | 814 | 814 | 814 | 814 | 814 | 814 |
| 2049              | 1449 | 313 | 814 | 814 | 814 | 814 | 814 | 814 | 814 |
| 2050              | 1449 | 313 | 814 | 814 | 814 | 814 | 814 | 814 | 814 |
| 2051              | 1449 | 313 | 814 | 814 | 814 | 814 | 814 | 814 | 814 |

| ScenarioID /<br>Year | 10   | 11  | 12  | 13  | 14  | 15  | 16  | 17  | 18  |
|----------------------|------|-----|-----|-----|-----|-----|-----|-----|-----|
| 2052                 | 1449 | 313 | 814 | 814 | 814 | 814 | 814 | 814 | 814 |
| 2053                 | 1449 | 313 | 814 | 814 | 814 | 814 | 814 | 814 | 814 |
| 2054                 | 1449 | 313 | 814 | 814 | 814 | 814 | 814 | 814 | 814 |
| 2055                 | 1449 | 313 | 814 | 814 | 814 | 814 | 814 | 814 | 814 |
| 2056                 | 1449 | 313 | 814 | 814 | 814 | 814 | 814 | 814 | 814 |
| 2057                 | 1449 | 313 | 814 | 814 | 814 | 814 | 814 | 814 | 814 |
| 2058                 | 1449 | 313 | 814 | 814 | 814 | 814 | 814 | 814 | 814 |
| 2059                 | 1449 | 313 | 814 | 814 | 814 | 814 | 814 | 814 | 814 |
| 2060                 | 1449 | 313 | 814 | 814 | 814 | 814 | 814 | 814 | 814 |
| 2061                 | 1449 | 313 | 814 | 814 | 814 | 814 | 814 | 814 | 814 |
| 2062                 | 1449 | 313 | 814 | 814 | 814 | 814 | 814 | 814 | 814 |
| 2063                 | 1449 | 313 | 814 | 814 | 814 | 814 | 814 | 814 | 814 |
| 2064                 | 1449 | 313 | 814 | 814 | 814 | 814 | 814 | 814 | 814 |
| 2065                 | 1449 | 313 | 814 | 814 | 814 | 814 | 814 | 814 | 814 |
| 2066                 | 1449 | 313 | 814 | 814 | 814 | 814 | 814 | 814 | 814 |
| 2067                 | 1449 | 313 | 814 | 814 | 814 | 814 | 814 | 814 | 814 |
| 2068                 | 1449 | 313 | 814 | 814 | 814 | 814 | 814 | 814 | 814 |
| 2069                 | 1449 | 313 | 814 | 814 | 814 | 814 | 814 | 814 | 814 |
| 2070                 | 1449 | 313 | 814 | 814 | 814 | 814 | 814 | 814 | 814 |
| 2071                 | 1449 | 313 | 814 | 814 | 814 | 814 | 814 | 814 | 814 |
| 2072                 | 1449 | 313 | 814 | 814 | 814 | 814 | 814 | 814 | 814 |
| 2073                 | 1449 | 313 | 814 | 814 | 814 | 814 | 814 | 814 | 814 |
| 2074                 | 1449 | 313 | 814 | 814 | 814 | 814 | 814 | 814 | 814 |
| 2075                 | 1449 | 313 | 814 | 814 | 814 | 814 | 814 | 814 | 814 |
| 2076                 | 1449 | 313 | 814 | 814 | 814 | 814 | 814 | 814 | 814 |
| 2077                 | 1449 | 313 | 814 | 814 | 814 | 814 | 814 | 814 | 814 |
| 2078                 | 1449 | 313 | 814 | 814 | 814 | 814 | 814 | 814 | 814 |
| 2079                 | 1449 | 313 | 814 | 814 | 814 | 814 | 814 | 814 | 814 |
| 2080                 | 1449 | 313 | 814 | 814 | 814 | 814 | 814 | 814 | 814 |
| 2081                 | 1449 | 313 | 814 | 814 | 814 | 814 | 814 | 814 | 814 |
| 2082                 | 1449 | 313 | 814 | 814 | 814 | 814 | 814 | 814 | 814 |
| 2083                 | 1449 | 313 | 814 | 814 | 814 | 814 | 814 | 814 | 814 |
| 2084                 | 1449 | 313 | 814 | 814 | 814 | 814 | 814 | 814 | 814 |
| 2085                 | 1449 | 313 | 814 | 814 | 814 | 814 | 814 | 814 | 814 |
| 2086                 | 1449 | 313 | 814 | 814 | 814 | 814 | 814 | 814 | 814 |
| 2087                 | 1449 | 313 | 814 | 814 | 814 | 814 | 814 | 814 | 814 |
| 2088                 | 1449 | 313 | 814 | 814 | 814 | 814 | 814 | 814 | 814 |
| 2089                 | 1449 | 313 | 814 | 814 | 814 | 814 | 814 | 814 | 814 |
| 2090                 | 1449 | 313 | 814 | 814 | 814 | 814 | 814 | 814 | 814 |

| ScenarioID /<br>Year | 19   | 20  | 21  | 22  | 23  | 24  | 25  | 26  | 27  |
|----------------------|------|-----|-----|-----|-----|-----|-----|-----|-----|
| 2002                 | 0    | 0   | 0   | 0   | 0   | 0   | 0   | 0   | 0   |
| 2003                 | 0    | 0   | 0   | 0   | 0   | 0   | 0   | 0   | 0   |
| 2004                 | 1    | 1   | 1   | 1   | 1   | 1   | 1   | 1   | 1   |
| 2005                 | 3    | 3   | 3   | 3   | 3   | 3   | 3   | 3   | 3   |
| 2006                 | 14   | 14  | 14  | 14  | 14  | 14  | 14  | 14  | 14  |
| 2007                 | 33   | 33  | 33  | 33  | 33  | 33  | 33  | 33  | 33  |
| 2008                 | 67   | 67  | 67  | 67  | 67  | 67  | 67  | 67  | 67  |
| 2009                 | 128  | 128 | 128 | 128 | 128 | 128 | 128 | 128 | 128 |
| 2010                 | 210  | 210 | 210 | 210 | 210 | 210 | 210 | 210 | 210 |
| 2011                 | 313  | 313 | 313 | 313 | 313 | 313 | 313 | 313 | 313 |
| 2012                 | 418  | 313 | 418 | 418 | 418 | 418 | 418 | 418 | 418 |
| 2013                 | 547  | 313 | 547 | 547 | 547 | 547 | 547 | 547 | 547 |
| 2014                 | 665  | 313 | 665 | 665 | 665 | 665 | 665 | 665 | 665 |
| 2015                 | 814  | 313 | 814 | 814 | 814 | 814 | 814 | 814 | 814 |
| 2016                 | 957  | 313 | 814 | 814 | 814 | 814 | 814 | 814 | 814 |
| 2017                 | 1109 | 313 | 814 | 814 | 814 | 814 | 814 | 814 | 814 |
| 2018                 | 1276 | 313 | 814 | 814 | 814 | 814 | 814 | 814 | 814 |
| 2019                 | 1449 | 313 | 814 | 814 | 814 | 814 | 814 | 814 | 814 |
| 2020                 | 1449 | 313 | 814 | 814 | 814 | 814 | 814 | 814 | 814 |
| 2021                 | 1449 | 313 | 814 | 814 | 814 | 814 | 814 | 814 | 814 |
| 2022                 | 1449 | 313 | 814 | 814 | 814 | 814 | 814 | 814 | 814 |
| 2023                 | 1449 | 313 | 814 | 814 | 814 | 814 | 814 | 814 | 814 |
| 2024                 | 1449 | 313 | 814 | 814 | 814 | 814 | 814 | 814 | 814 |
| 2025                 | 1449 | 313 | 814 | 814 | 814 | 814 | 814 | 814 | 814 |
| 2026                 | 1449 | 313 | 814 | 814 | 814 | 814 | 814 | 814 | 814 |
| 2027                 | 1449 | 313 | 814 | 814 | 814 | 814 | 814 | 814 | 814 |
| 2028                 | 1449 | 313 | 814 | 814 | 814 | 814 | 814 | 814 | 814 |
| 2029                 | 1449 | 313 | 814 | 814 | 814 | 814 | 814 | 814 | 814 |
| 2030                 | 1449 | 313 | 814 | 814 | 814 | 814 | 814 | 814 | 814 |
| 2031                 | 1449 | 313 | 814 | 814 | 814 | 814 | 814 | 814 | 814 |
| 2032                 | 1449 | 313 | 814 | 814 | 814 | 814 | 814 | 814 | 814 |
| 2033                 | 1449 | 313 | 814 | 814 | 814 | 814 | 814 | 814 | 814 |
| 2034                 | 1449 | 313 | 814 | 814 | 814 | 814 | 814 | 814 | 814 |
| 2035                 | 1449 | 313 | 814 | 814 | 814 | 814 | 814 | 814 | 814 |
| 2036                 | 1449 | 313 | 814 | 814 | 814 | 814 | 814 | 814 | 814 |
| 2037                 | 1449 | 313 | 814 | 814 | 814 | 814 | 814 | 814 | 814 |
| 2038                 | 1449 | 313 | 814 | 814 | 814 | 814 | 814 | 814 | 814 |
| 2039                 | 1449 | 313 | 814 | 814 | 814 | 814 | 814 | 814 | 814 |
| 2040                 | 1449 | 313 | 814 | 814 | 814 | 814 | 814 | 814 | 814 |
| 2041                 | 1449 | 313 | 814 | 814 | 814 | 814 | 814 | 814 | 814 |
| 2042                 | 1449 | 313 | 814 | 814 | 814 | 814 | 814 | 814 | 814 |
| 2043                 | 1449 | 313 | 814 | 814 | 814 | 814 | 814 | 814 | 814 |
| 2044                 | 1449 | 313 | 814 | 814 | 814 | 814 | 814 | 814 | 814 |
| 2045                 | 1449 | 313 | 814 | 814 | 814 | 814 | 814 | 814 | 814 |
| 2046                 | 1449 | 313 | 814 | 814 | 814 | 814 | 814 | 814 | 814 |
| 2047                 | 1449 | 313 | 814 | 814 | 814 | 814 | 814 | 814 | 814 |
| 2048                 | 1449 | 313 | 814 | 814 | 814 | 814 | 814 | 814 | 814 |
| 2049                 | 1449 | 313 | 814 | 814 | 814 | 814 | 814 | 814 | 814 |
| 2050                 | 1449 | 313 | 814 | 814 | 814 | 814 | 814 | 814 | 814 |
| 2051                 | 1449 | 313 | 814 | 814 | 814 | 814 | 814 | 814 | 814 |

| ScenarioID /<br>Year | 19   | 20  | 21  | 22  | 23  | 24  | 25  | 26  | 27  |
|----------------------|------|-----|-----|-----|-----|-----|-----|-----|-----|
| 2052                 | 1449 | 313 | 814 | 814 | 814 | 814 | 814 | 814 | 814 |
| 2053                 | 1449 | 313 | 814 | 814 | 814 | 814 | 814 | 814 | 814 |
| 2054                 | 1449 | 313 | 814 | 814 | 814 | 814 | 814 | 814 | 814 |
| 2055                 | 1449 | 313 | 814 | 814 | 814 | 814 | 814 | 814 | 814 |
| 2056                 | 1449 | 313 | 814 | 814 | 814 | 814 | 814 | 814 | 814 |
| 2057                 | 1449 | 313 | 814 | 814 | 814 | 814 | 814 | 814 | 814 |
| 2058                 | 1449 | 313 | 814 | 814 | 814 | 814 | 814 | 814 | 814 |
| 2059                 | 1449 | 313 | 814 | 814 | 814 | 814 | 814 | 814 | 814 |
| 2060                 | 1449 | 313 | 814 | 814 | 814 | 814 | 814 | 814 | 814 |
| 2061                 | 1449 | 313 | 814 | 814 | 814 | 814 | 814 | 814 | 814 |
| 2062                 | 1449 | 313 | 814 | 814 | 814 | 814 | 814 | 814 | 814 |
| 2063                 | 1449 | 313 | 814 | 814 | 814 | 814 | 814 | 814 | 814 |
| 2064                 | 1449 | 313 | 814 | 814 | 814 | 814 | 814 | 814 | 814 |
| 2065                 | 1449 | 313 | 814 | 814 | 814 | 814 | 814 | 814 | 814 |
| 2066                 | 1449 | 313 | 814 | 814 | 814 | 814 | 814 | 814 | 814 |
| 2067                 | 1449 | 313 | 814 | 814 | 814 | 814 | 814 | 814 | 814 |
| 2068                 | 1449 | 313 | 814 | 814 | 814 | 814 | 814 | 814 | 814 |
| 2069                 | 1449 | 313 | 814 | 814 | 814 | 814 | 814 | 814 | 814 |
| 2070                 | 1449 | 313 | 814 | 814 | 814 | 814 | 814 | 814 | 814 |
| 2071                 | 1449 | 313 | 814 | 814 | 814 | 814 | 814 | 814 | 814 |
| 2072                 | 1449 | 313 | 814 | 814 | 814 | 814 | 814 | 814 | 814 |
| 2073                 | 1449 | 313 | 814 | 814 | 814 | 814 | 814 | 814 | 814 |
| 2074                 | 1449 | 313 | 814 | 814 | 814 | 814 | 814 | 814 | 814 |
| 2075                 | 1449 | 313 | 814 | 814 | 814 | 814 | 814 | 814 | 814 |
| 2076                 | 1449 | 313 | 814 | 814 | 814 | 814 | 814 | 814 | 814 |
| 2077                 | 1449 | 313 | 814 | 814 | 814 | 814 | 814 | 814 | 814 |
| 2078                 | 1449 | 313 | 814 | 814 | 814 | 814 | 814 | 814 | 814 |
| 2079                 | 1449 | 313 | 814 | 814 | 814 | 814 | 814 | 814 | 814 |
| 2080                 | 1449 | 313 | 814 | 814 | 814 | 814 | 814 | 814 | 814 |
| 2081                 | 1449 | 313 | 814 | 814 | 814 | 814 | 814 | 814 | 814 |
| 2082                 | 1449 | 313 | 814 | 814 | 814 | 814 | 814 | 814 | 814 |
| 2083                 | 1449 | 313 | 814 | 814 | 814 | 814 | 814 | 814 | 814 |
| 2084                 | 1449 | 313 | 814 | 814 | 814 | 814 | 814 | 814 | 814 |
| 2085                 | 1449 | 313 | 814 | 814 | 814 | 814 | 814 | 814 | 814 |
| 2086                 | 1449 | 313 | 814 | 814 | 814 | 814 | 814 | 814 | 814 |
| 2087                 | 1449 | 313 | 814 | 814 | 814 | 814 | 814 | 814 | 814 |
| 2088                 | 1449 | 313 | 814 | 814 | 814 | 814 | 814 | 814 | 814 |
| 2089                 | 1449 | 313 | 814 | 814 | 814 | 814 | 814 | 814 | 814 |
| 2090                 | 1449 | 313 | 814 | 814 | 814 | 814 | 814 | 814 | 814 |

| ScenarioID / Year | 28   | 29  | 30  | 31  | 32  | 33  | 34  | 35  | 36  |
|-------------------|------|-----|-----|-----|-----|-----|-----|-----|-----|
| 2002              | 0    | 0   | 0   | 0   | 0   | 0   | 0   | 0   | 0   |
| 2003              | 0    | 0   | 0   | 0   | 0   | 0   | 0   | 0   | 0   |
| 2004              | 1    | 1   | 1   | 1   | 1   | 1   | 1   | 1   | 1   |
| 2005              | 3    | 3   | 3   | 3   | 3   | 3   | 3   | 3   | 3   |
| 2006              | 14   | 14  | 14  | 14  | 14  | 14  | 14  | 14  | 14  |
| 2007              | 33   | 33  | 33  | 33  | 33  | 33  | 33  | 33  | 33  |
| 2008              | 67   | 67  | 67  | 67  | 67  | 67  | 67  | 67  | 67  |
| 2009              | 128  | 128 | 128 | 128 | 128 | 128 | 128 | 128 | 128 |
| 2010              | 210  | 210 | 210 | 210 | 210 | 210 | 210 | 210 | 210 |
| 2011              | 313  | 313 | 313 | 313 | 313 | 313 | 313 | 313 | 313 |
| 2012              | 418  | 313 | 418 | 418 | 418 | 418 | 418 | 418 | 418 |
| 2013              | 547  | 313 | 547 | 547 | 547 | 547 | 547 | 547 | 547 |
| 2014              | 665  | 313 | 665 | 665 | 665 | 665 | 665 | 665 | 665 |
| 2015              | 814  | 313 | 814 | 814 | 814 | 814 | 814 | 814 | 814 |
| 2016              | 957  | 313 | 814 | 814 | 814 | 814 | 814 | 814 | 814 |
| 2017              | 1109 | 313 | 814 | 814 | 814 | 814 | 814 | 814 | 814 |
| 2018              | 1276 | 313 | 814 | 814 | 814 | 814 | 814 | 814 | 814 |
| 2019              | 1449 | 313 | 814 | 814 | 814 | 814 | 814 | 814 | 814 |
| 2020              | 1449 | 313 | 814 | 814 | 814 | 814 | 814 | 814 | 814 |
| 2021              | 1449 | 313 | 814 | 814 | 814 | 814 | 814 | 814 | 814 |
| 2022              | 1449 | 313 | 814 | 814 | 814 | 814 | 814 | 814 | 814 |
| 2023              | 1449 | 313 | 814 | 814 | 814 | 814 | 814 | 814 | 814 |
| 2024              | 1449 | 313 | 814 | 814 | 814 | 814 | 814 | 814 | 814 |
| 2025              | 1449 | 313 | 814 | 814 | 814 | 814 | 814 | 814 | 814 |
| 2026              | 1449 | 313 | 814 | 814 | 814 | 814 | 814 | 814 | 814 |
| 2027              | 1449 | 313 | 814 | 814 | 814 | 814 | 814 | 814 | 814 |
| 2028              | 1449 | 313 | 814 | 814 | 814 | 814 | 814 | 814 | 814 |
| 2029              | 1449 | 313 | 814 | 814 | 814 | 814 | 814 | 814 | 814 |
| 2030              | 1449 | 313 | 814 | 814 | 814 | 814 | 814 | 814 | 814 |
| 2031              | 1449 | 313 | 814 | 814 | 814 | 814 | 814 | 814 | 814 |
| 2032              | 1449 | 313 | 814 | 814 | 814 | 814 | 814 | 814 | 814 |
| 2033              | 1449 | 313 | 814 | 814 | 814 | 814 | 814 | 814 | 814 |
| 2034              | 1449 | 313 | 814 | 814 | 814 | 814 | 814 | 814 | 814 |
| 2035              | 1449 | 313 | 814 | 814 | 814 | 814 | 814 | 814 | 814 |
| 2036              | 1449 | 313 | 814 | 814 | 814 | 814 | 814 | 814 | 814 |
| 2037              | 1449 | 313 | 814 | 814 | 814 | 814 | 814 | 814 | 814 |
| 2038              | 1449 | 313 | 814 | 814 | 814 | 814 | 814 | 814 | 814 |
| 2039              | 1449 | 313 | 814 | 814 | 814 | 814 | 814 | 814 | 814 |
| 2040              | 1449 | 313 | 814 | 814 | 814 | 814 | 814 | 814 | 814 |
| 2041              | 1449 | 313 | 814 | 814 | 814 | 814 | 814 | 814 | 814 |
| 2042              | 1449 | 313 | 814 | 814 | 814 | 814 | 814 | 814 | 814 |
| 2043              | 1449 | 313 | 814 | 814 | 814 | 814 | 814 | 814 | 814 |
| 2044              | 1449 | 313 | 814 | 814 | 814 | 814 | 814 | 814 | 814 |
| 2045              | 1449 | 313 | 814 | 814 | 814 | 814 | 814 | 814 | 814 |
| 2046              | 1449 | 313 | 814 | 814 | 814 | 814 | 814 | 814 | 814 |
| 2047              | 1449 | 313 | 814 | 814 | 814 | 814 | 814 | 814 | 814 |
| 2048              | 1449 | 313 | 814 | 814 | 814 | 814 | 814 | 814 | 814 |
| 2049              | 1449 | 313 | 814 | 814 | 814 | 814 | 814 | 814 | 814 |
| 2050              | 1449 | 313 | 814 | 814 | 814 | 814 | 814 | 814 | 814 |
| 2051              | 1449 | 313 | 814 | 814 | 814 | 814 | 814 | 814 | 814 |



| ScenarioID /<br>Year | 28   | 29  | 30  | 31  | 32  | 33  | 34  | 35  | 36  |
|----------------------|------|-----|-----|-----|-----|-----|-----|-----|-----|
| 2052                 | 1449 | 313 | 814 | 814 | 814 | 814 | 814 | 814 | 814 |
| 2053                 | 1449 | 313 | 814 | 814 | 814 | 814 | 814 | 814 | 814 |
| 2054                 | 1449 | 313 | 814 | 814 | 814 | 814 | 814 | 814 | 814 |
| 2055                 | 1449 | 313 | 814 | 814 | 814 | 814 | 814 | 814 | 814 |
| 2056                 | 1449 | 313 | 814 | 814 | 814 | 814 | 814 | 814 | 814 |
| 2057                 | 1449 | 313 | 814 | 814 | 814 | 814 | 814 | 814 | 814 |
| 2058                 | 1449 | 313 | 814 | 814 | 814 | 814 | 814 | 814 | 814 |
| 2059                 | 1449 | 313 | 814 | 814 | 814 | 814 | 814 | 814 | 814 |
| 2060                 | 1449 | 313 | 814 | 814 | 814 | 814 | 814 | 814 | 814 |
| 2061                 | 1449 | 313 | 814 | 814 | 814 | 814 | 814 | 814 | 814 |
| 2062                 | 1449 | 313 | 814 | 814 | 814 | 814 | 814 | 814 | 814 |
| 2063                 | 1449 | 313 | 814 | 814 | 814 | 814 | 814 | 814 | 814 |
| 2064                 | 1449 | 313 | 814 | 814 | 814 | 814 | 814 | 814 | 814 |
| 2065                 | 1449 | 313 | 814 | 814 | 814 | 814 | 814 | 814 | 814 |
| 2066                 | 1449 | 313 | 814 | 814 | 814 | 814 | 814 | 814 | 814 |
| 2067                 | 1449 | 313 | 814 | 814 | 814 | 814 | 814 | 814 | 814 |
| 2068                 | 1449 | 313 | 814 | 814 | 814 | 814 | 814 | 814 | 814 |
| 2069                 | 1449 | 313 | 814 | 814 | 814 | 814 | 814 | 814 | 814 |
| 2070                 | 1449 | 313 | 814 | 814 | 814 | 814 | 814 | 814 | 814 |
| 2071                 | 1449 | 313 | 814 | 814 | 814 | 814 | 814 | 814 | 814 |
| 2072                 | 1449 | 313 | 814 | 814 | 814 | 814 | 814 | 814 | 814 |
| 2073                 | 1449 | 313 | 814 | 814 | 814 | 814 | 814 | 814 | 814 |
| 2074                 | 1449 | 313 | 814 | 814 | 814 | 814 | 814 | 814 | 814 |
| 2075                 | 1449 | 313 | 814 | 814 | 814 | 814 | 814 | 814 | 814 |
| 2076                 | 1449 | 313 | 814 | 814 | 814 | 814 | 814 | 814 | 814 |
| 2077                 | 1449 | 313 | 814 | 814 | 814 | 814 | 814 | 814 | 814 |
| 2078                 | 1449 | 313 | 814 | 814 | 814 | 814 | 814 | 814 | 814 |
| 2079                 | 1449 | 313 | 814 | 814 | 814 | 814 | 814 | 814 | 814 |
| 2080                 | 1449 | 313 | 814 | 814 | 814 | 814 | 814 | 814 | 814 |
| 2081                 | 1449 | 313 | 814 | 814 | 814 | 814 | 814 | 814 | 814 |
| 2082                 | 1449 | 313 | 814 | 814 | 814 | 814 | 814 | 814 | 814 |
| 2083                 | 1449 | 313 | 814 | 814 | 814 | 814 | 814 | 814 | 814 |
| 2084                 | 1449 | 313 | 814 | 814 | 814 | 814 | 814 | 814 | 814 |
| 2085                 | 1449 | 313 | 814 | 814 | 814 | 814 | 814 | 814 | 814 |
| 2086                 | 1449 | 313 | 814 | 814 | 814 | 814 | 814 | 814 | 814 |
| 2087                 | 1449 | 313 | 814 | 814 | 814 | 814 | 814 | 814 | 814 |
| 2088                 | 1449 | 313 | 814 | 814 | 814 | 814 | 814 | 814 | 814 |
| 2089                 | 1449 | 313 | 814 | 814 | 814 | 814 | 814 | 814 | 814 |
| 2090                 | 1449 | 313 | 814 | 814 | 814 | 814 | 814 | 814 | 814 |

| ScenarioID /<br>Year | 37   | 38  | 39  | 40  | 41  | 42  | 43  | 44  | 45  |
|----------------------|------|-----|-----|-----|-----|-----|-----|-----|-----|
| 2002                 | 0    | 0   | 0   | 0   | 0   | 0   | 0   | 0   | 0   |
| 2003                 | 0    | 0   | 0   | 0   | 0   | 0   | 0   | 0   | 0   |
| 2004                 | 1    | 1   | 1   | 1   | 1   | 1   | 1   | 1   | 1   |
| 2005                 | 3    | 3   | 3   | 3   | 3   | 3   | 3   | 3   | 3   |
| 2006                 | 14   | 14  | 14  | 14  | 14  | 14  | 14  | 14  | 14  |
| 2007                 | 33   | 33  | 33  | 33  | 33  | 33  | 33  | 33  | 33  |
| 2008                 | 67   | 67  | 67  | 67  | 67  | 67  | 67  | 67  | 67  |
| 2009                 | 128  | 128 | 128 | 128 | 128 | 128 | 128 | 128 | 128 |
| 2010                 | 210  | 210 | 210 | 210 | 210 | 210 | 210 | 210 | 210 |
| 2011                 | 313  | 313 | 313 | 313 | 313 | 313 | 313 | 313 | 313 |
| 2012                 | 418  | 313 | 418 | 418 | 418 | 418 | 418 | 418 | 418 |
| 2013                 | 547  | 313 | 547 | 547 | 547 | 547 | 547 | 547 | 547 |
| 2014                 | 665  | 313 | 665 | 665 | 665 | 665 | 665 | 665 | 665 |
| 2015                 | 814  | 313 | 814 | 814 | 814 | 814 | 814 | 814 | 814 |
| 2016                 | 957  | 313 | 814 | 814 | 814 | 814 | 814 | 814 | 814 |
| 2017                 | 1109 | 313 | 814 | 814 | 814 | 814 | 814 | 814 | 814 |
| 2018                 | 1276 | 313 | 814 | 814 | 814 | 814 | 814 | 814 | 814 |
| 2019                 | 1449 | 313 | 814 | 814 | 814 | 814 | 814 | 814 | 814 |
| 2020                 | 1449 | 313 | 814 | 814 | 814 | 814 | 814 | 814 | 814 |
| 2021                 | 1449 | 313 | 814 | 814 | 814 | 814 | 814 | 814 | 814 |
| 2022                 | 1449 | 313 | 814 | 814 | 814 | 814 | 814 | 814 | 814 |
| 2023                 | 1449 | 313 | 814 | 814 | 814 | 814 | 814 | 814 | 814 |
| 2024                 | 1449 | 313 | 814 | 814 | 814 | 814 | 814 | 814 | 814 |
| 2025                 | 1449 | 313 | 814 | 814 | 814 | 814 | 814 | 814 | 814 |
| 2026                 | 1449 | 313 | 814 | 814 | 814 | 814 | 814 | 814 | 814 |
| 2027                 | 1449 | 313 | 814 | 814 | 814 | 814 | 814 | 814 | 814 |
| 2028                 | 1449 | 313 | 814 | 814 | 814 | 814 | 814 | 814 | 814 |
| 2029                 | 1449 | 313 | 814 | 814 | 814 | 814 | 814 | 814 | 814 |
| 2030                 | 1449 | 313 | 814 | 814 | 814 | 814 | 814 | 814 | 814 |
| 2031                 | 1449 | 313 | 814 | 814 | 814 | 814 | 814 | 814 | 814 |
| 2032                 | 1449 | 313 | 814 | 814 | 814 | 814 | 814 | 814 | 814 |
| 2033                 | 1449 | 313 | 814 | 814 | 814 | 814 | 814 | 814 | 814 |
| 2034                 | 1449 | 313 | 814 | 814 | 814 | 814 | 814 | 814 | 814 |
| 2035                 | 1449 | 313 | 814 | 814 | 814 | 814 | 814 | 814 | 814 |
| 2036                 | 1449 | 313 | 814 | 814 | 814 | 814 | 814 | 814 | 814 |
| 2037                 | 1449 | 313 | 814 | 814 | 814 | 814 | 814 | 814 | 814 |
| 2038                 | 1449 | 313 | 814 | 814 | 814 | 814 | 814 | 814 | 814 |
| 2039                 | 1449 | 313 | 814 | 814 | 814 | 814 | 814 | 814 | 814 |
| 2040                 | 1449 | 313 | 814 | 814 | 814 | 814 | 814 | 814 | 814 |
| 2041                 | 1449 | 313 | 814 | 814 | 814 | 814 | 814 | 814 | 814 |
| 2042                 | 1449 | 313 | 814 | 814 | 814 | 814 | 814 | 814 | 814 |
| 2043                 | 1449 | 313 | 814 | 814 | 814 | 814 | 814 | 814 | 814 |
| 2044                 | 1449 | 313 | 814 | 814 | 814 | 814 | 814 | 814 | 814 |
| 2045                 | 1449 | 313 | 814 | 814 | 814 | 814 | 814 | 814 | 814 |
| 2046                 | 1449 | 313 | 814 | 814 | 814 | 814 | 814 | 814 | 814 |
| 2047                 | 1449 | 313 | 814 | 814 | 814 | 814 | 814 | 814 | 814 |
| 2048                 | 1449 | 313 | 814 | 814 | 814 | 814 | 814 | 814 | 814 |
| 2049                 | 1449 | 313 | 814 | 814 | 814 | 814 | 814 | 814 | 814 |
| 2050                 | 1449 | 313 | 814 | 814 | 814 | 814 | 814 | 814 | 814 |
| 2051                 | 1449 | 313 | 814 | 814 | 814 | 814 | 814 | 814 | 814 |

| ScenarioID /<br>Year | 37   | 38  | 39  | 40  | 41  | 42  | 43  | 44  | 45  |
|----------------------|------|-----|-----|-----|-----|-----|-----|-----|-----|
| 2052                 | 1449 | 313 | 814 | 814 | 814 | 814 | 814 | 814 | 814 |
| 2053                 | 1449 | 313 | 814 | 814 | 814 | 814 | 814 | 814 | 814 |
| 2054                 | 1449 | 313 | 814 | 814 | 814 | 814 | 814 | 814 | 814 |
| 2055                 | 1449 | 313 | 814 | 814 | 814 | 814 | 814 | 814 | 814 |
| 2056                 | 1449 | 313 | 814 | 814 | 814 | 814 | 814 | 814 | 814 |
| 2057                 | 1449 | 313 | 814 | 814 | 814 | 814 | 814 | 814 | 814 |
| 2058                 | 1449 | 313 | 814 | 814 | 814 | 814 | 814 | 814 | 814 |
| 2059                 | 1449 | 313 | 814 | 814 | 814 | 814 | 814 | 814 | 814 |
| 2060                 | 1449 | 313 | 814 | 814 | 814 | 814 | 814 | 814 | 814 |
| 2061                 | 1449 | 313 | 814 | 814 | 814 | 814 | 814 | 814 | 814 |
| 2062                 | 1449 | 313 | 814 | 814 | 814 | 814 | 814 | 814 | 814 |
| 2063                 | 1449 | 313 | 814 | 814 | 814 | 814 | 814 | 814 | 814 |
| 2064                 | 1449 | 313 | 814 | 814 | 814 | 814 | 814 | 814 | 814 |
| 2065                 | 1449 | 313 | 814 | 814 | 814 | 814 | 814 | 814 | 814 |
| 2066                 | 1449 | 313 | 814 | 814 | 814 | 814 | 814 | 814 | 814 |
| 2067                 | 1449 | 313 | 814 | 814 | 814 | 814 | 814 | 814 | 814 |
| 2068                 | 1449 | 313 | 814 | 814 | 814 | 814 | 814 | 814 | 814 |
| 2069                 | 1449 | 313 | 814 | 814 | 814 | 814 | 814 | 814 | 814 |
| 2070                 | 1449 | 313 | 814 | 814 | 814 | 814 | 814 | 814 | 814 |
| 2071                 | 1449 | 313 | 814 | 814 | 814 | 814 | 814 | 814 | 814 |
| 2072                 | 1449 | 313 | 814 | 814 | 814 | 814 | 814 | 814 | 814 |
| 2073                 | 1449 | 313 | 814 | 814 | 814 | 814 | 814 | 814 | 814 |
| 2074                 | 1449 | 313 | 814 | 814 | 814 | 814 | 814 | 814 | 814 |
| 2075                 | 1449 | 313 | 814 | 814 | 814 | 814 | 814 | 814 | 814 |
| 2076                 | 1449 | 313 | 814 | 814 | 814 | 814 | 814 | 814 | 814 |
| 2077                 | 1449 | 313 | 814 | 814 | 814 | 814 | 814 | 814 | 814 |
| 2078                 | 1449 | 313 | 814 | 814 | 814 | 814 | 814 | 814 | 814 |
| 2079                 | 1449 | 313 | 814 | 814 | 814 | 814 | 814 | 814 | 814 |
| 2080                 | 1449 | 313 | 814 | 814 | 814 | 814 | 814 | 814 | 814 |
| 2081                 | 1449 | 313 | 814 | 814 | 814 | 814 | 814 | 814 | 814 |
| 2082                 | 1449 | 313 | 814 | 814 | 814 | 814 | 814 | 814 | 814 |
| 2083                 | 1449 | 313 | 814 | 814 | 814 | 814 | 814 | 814 | 814 |
| 2084                 | 1449 | 313 | 814 | 814 | 814 | 814 | 814 | 814 | 814 |
| 2085                 | 1449 | 313 | 814 | 814 | 814 | 814 | 814 | 814 | 814 |
| 2086                 | 1449 | 313 | 814 | 814 | 814 | 814 | 814 | 814 | 814 |
| 2087                 | 1449 | 313 | 814 | 814 | 814 | 814 | 814 | 814 | 814 |
| 2088                 | 1449 | 313 | 814 | 814 | 814 | 814 | 814 | 814 | 814 |
| 2089                 | 1449 | 313 | 814 | 814 | 814 | 814 | 814 | 814 | 814 |
| 2090                 | 1449 | 313 | 814 | 814 | 814 | 814 | 814 | 814 | 814 |

| ScenarioID /<br>Year | 46   | 47  | 48  | 49  | 50  | 51  | 52  | 53  | 54  |
|----------------------|------|-----|-----|-----|-----|-----|-----|-----|-----|
| 2002                 | 0    | 0   | 0   | 0   | 0   | 0   | 0   | 0   | 0   |
| 2003                 | 0    | 0   | 0   | 0   | 0   | 0   | 0   | 0   | 0   |
| 2004                 | 1    | 1   | 1   | 1   | 1   | 1   | 1   | 1   | 1   |
| 2005                 | 3    | 3   | 3   | 3   | 3   | 3   | 3   | 3   | 3   |
| 2006                 | 14   | 14  | 14  | 14  | 14  | 14  | 14  | 14  | 14  |
| 2007                 | 33   | 33  | 33  | 33  | 33  | 33  | 33  | 33  | 33  |
| 2008                 | 67   | 67  | 67  | 67  | 67  | 67  | 67  | 67  | 67  |
| 2009                 | 128  | 128 | 128 | 128 | 128 | 128 | 128 | 128 | 128 |
| 2010                 | 210  | 210 | 210 | 210 | 210 | 210 | 210 | 210 | 210 |
| 2011                 | 313  | 313 | 313 | 313 | 313 | 313 | 313 | 313 | 313 |
| 2012                 | 418  | 313 | 418 | 418 | 418 | 418 | 418 | 418 | 418 |
| 2013                 | 547  | 313 | 547 | 547 | 547 | 547 | 547 | 547 | 547 |
| 2014                 | 665  | 313 | 665 | 665 | 665 | 665 | 665 | 665 | 665 |
| 2015                 | 814  | 313 | 814 | 814 | 814 | 814 | 814 | 814 | 814 |
| 2016                 | 957  | 313 | 814 | 814 | 814 | 814 | 814 | 814 | 814 |
| 2017                 | 1109 | 313 | 814 | 814 | 814 | 814 | 814 | 814 | 814 |
| 2018                 | 1276 | 313 | 814 | 814 | 814 | 814 | 814 | 814 | 814 |
| 2019                 | 1449 | 313 | 814 | 814 | 814 | 814 | 814 | 814 | 814 |
| 2020                 | 1449 | 313 | 814 | 814 | 814 | 814 | 814 | 814 | 814 |
| 2021                 | 1449 | 313 | 814 | 814 | 814 | 814 | 814 | 814 | 814 |
| 2022                 | 1449 | 313 | 814 | 814 | 814 | 814 | 814 | 814 | 814 |
| 2023                 | 1449 | 313 | 814 | 814 | 814 | 814 | 814 | 814 | 814 |
| 2024                 | 1449 | 313 | 814 | 814 | 814 | 814 | 814 | 814 | 814 |
| 2025                 | 1449 | 313 | 814 | 814 | 814 | 814 | 814 | 814 | 814 |
| 2026                 | 1449 | 313 | 814 | 814 | 814 | 814 | 814 | 814 | 814 |
| 2027                 | 1449 | 313 | 814 | 814 | 814 | 814 | 814 | 814 | 814 |
| 2028                 | 1449 | 313 | 814 | 814 | 814 | 814 | 814 | 814 | 814 |
| 2029                 | 1449 | 313 | 814 | 814 | 814 | 814 | 814 | 814 | 814 |
| 2030                 | 1449 | 313 | 814 | 814 | 814 | 814 | 814 | 814 | 814 |
| 2031                 | 1449 | 313 | 814 | 814 | 814 | 814 | 814 | 814 | 814 |
| 2032                 | 1449 | 313 | 814 | 814 | 814 | 814 | 814 | 814 | 814 |
| 2033                 | 1449 | 313 | 814 | 814 | 814 | 814 | 814 | 814 | 814 |
| 2034                 | 1449 | 313 | 814 | 814 | 814 | 814 | 814 | 814 | 814 |
| 2035                 | 1449 | 313 | 814 | 814 | 814 | 814 | 814 | 814 | 814 |
| 2036                 | 1449 | 313 | 814 | 814 | 814 | 814 | 814 | 814 | 814 |
| 2037                 | 1449 | 313 | 814 | 814 | 814 | 814 | 814 | 814 | 814 |
| 2038                 | 1449 | 313 | 814 | 814 | 814 | 814 | 814 | 814 | 814 |
| 2039                 | 1449 | 313 | 814 | 814 | 814 | 814 | 814 | 814 | 814 |
| 2040                 | 1449 | 313 | 814 | 814 | 814 | 814 | 814 | 814 | 814 |
| 2041                 | 1449 | 313 | 814 | 814 | 814 | 814 | 814 | 814 | 814 |
| 2042                 | 1449 | 313 | 814 | 814 | 814 | 814 | 814 | 814 | 814 |
| 2043                 | 1449 | 313 | 814 | 814 | 814 | 814 | 814 | 814 | 814 |
| 2044                 | 1449 | 313 | 814 | 814 | 814 | 814 | 814 | 814 | 814 |
| 2045                 | 1449 | 313 | 814 | 814 | 814 | 814 | 814 | 814 | 814 |
| 2046                 | 1449 | 313 | 814 | 814 | 814 | 814 | 814 | 814 | 814 |
| 2047                 | 1449 | 313 | 814 | 814 | 814 | 814 | 814 | 814 | 814 |
| 2048                 | 1449 | 313 | 814 | 814 | 814 | 814 | 814 | 814 | 814 |
| 2049                 | 1449 | 313 | 814 | 814 | 814 | 814 | 814 | 814 | 814 |
| 2050                 | 1449 | 313 | 814 | 814 | 814 | 814 | 814 | 814 | 814 |
| 2051                 | 1449 | 313 | 814 | 814 | 814 | 814 | 814 | 814 | 814 |

| ScenarioID /<br>Year | 46   | 47  | 48  | 49  | 50  | 51  | 52  | 53  | 54  |
|----------------------|------|-----|-----|-----|-----|-----|-----|-----|-----|
| 2052                 | 1449 | 313 | 814 | 814 | 814 | 814 | 814 | 814 | 814 |
| 2053                 | 1449 | 313 | 814 | 814 | 814 | 814 | 814 | 814 | 814 |
| 2054                 | 1449 | 313 | 814 | 814 | 814 | 814 | 814 | 814 | 814 |
| 2055                 | 1449 | 313 | 814 | 814 | 814 | 814 | 814 | 814 | 814 |
| 2056                 | 1449 | 313 | 814 | 814 | 814 | 814 | 814 | 814 | 814 |
| 2057                 | 1449 | 313 | 814 | 814 | 814 | 814 | 814 | 814 | 814 |
| 2058                 | 1449 | 313 | 814 | 814 | 814 | 814 | 814 | 814 | 814 |
| 2059                 | 1449 | 313 | 814 | 814 | 814 | 814 | 814 | 814 | 814 |
| 2060                 | 1449 | 313 | 814 | 814 | 814 | 814 | 814 | 814 | 814 |
| 2061                 | 1449 | 313 | 814 | 814 | 814 | 814 | 814 | 814 | 814 |
| 2062                 | 1449 | 313 | 814 | 814 | 814 | 814 | 814 | 814 | 814 |
| 2063                 | 1449 | 313 | 814 | 814 | 814 | 814 | 814 | 814 | 814 |
| 2064                 | 1449 | 313 | 814 | 814 | 814 | 814 | 814 | 814 | 814 |
| 2065                 | 1449 | 313 | 814 | 814 | 814 | 814 | 814 | 814 | 814 |
| 2066                 | 1449 | 313 | 814 | 814 | 814 | 814 | 814 | 814 | 814 |
| 2067                 | 1449 | 313 | 814 | 814 | 814 | 814 | 814 | 814 | 814 |
| 2068                 | 1449 | 313 | 814 | 814 | 814 | 814 | 814 | 814 | 814 |
| 2069                 | 1449 | 313 | 814 | 814 | 814 | 814 | 814 | 814 | 814 |
| 2070                 | 1449 | 313 | 814 | 814 | 814 | 814 | 814 | 814 | 814 |
| 2071                 | 1449 | 313 | 814 | 814 | 814 | 814 | 814 | 814 | 814 |
| 2072                 | 1449 | 313 | 814 | 814 | 814 | 814 | 814 | 814 | 814 |
| 2073                 | 1449 | 313 | 814 | 814 | 814 | 814 | 814 | 814 | 814 |
| 2074                 | 1449 | 313 | 814 | 814 | 814 | 814 | 814 | 814 | 814 |
| 2075                 | 1449 | 313 | 814 | 814 | 814 | 814 | 814 | 814 | 814 |
| 2076                 | 1449 | 313 | 814 | 814 | 814 | 814 | 814 | 814 | 814 |
| 2077                 | 1449 | 313 | 814 | 814 | 814 | 814 | 814 | 814 | 814 |
| 2078                 | 1449 | 313 | 814 | 814 | 814 | 814 | 814 | 814 | 814 |
| 2079                 | 1449 | 313 | 814 | 814 | 814 | 814 | 814 | 814 | 814 |
| 2080                 | 1449 | 313 | 814 | 814 | 814 | 814 | 814 | 814 | 814 |
| 2081                 | 1449 | 313 | 814 | 814 | 814 | 814 | 814 | 814 | 814 |
| 2082                 | 1449 | 313 | 814 | 814 | 814 | 814 | 814 | 814 | 814 |
| 2083                 | 1449 | 313 | 814 | 814 | 814 | 814 | 814 | 814 | 814 |
| 2084                 | 1449 | 313 | 814 | 814 | 814 | 814 | 814 | 814 | 814 |
| 2085                 | 1449 | 313 | 814 | 814 | 814 | 814 | 814 | 814 | 814 |
| 2086                 | 1449 | 313 | 814 | 814 | 814 | 814 | 814 | 814 | 814 |
| 2087                 | 1449 | 313 | 814 | 814 | 814 | 814 | 814 | 814 | 814 |
| 2088                 | 1449 | 313 | 814 | 814 | 814 | 814 | 814 | 814 | 814 |
| 2089                 | 1449 | 313 | 814 | 814 | 814 | 814 | 814 | 814 | 814 |
| 2090                 | 1449 | 313 | 814 | 814 | 814 | 814 | 814 | 814 | 814 |

| ScenarioID /<br>Year | 55   | 56  | 57  | 58  | 59  | 60  | 61  | 62  | 63  |
|----------------------|------|-----|-----|-----|-----|-----|-----|-----|-----|
| 2002                 | 0    | 0   | 0   | 0   | 0   | 0   | 0   | 0   | 0   |
| 2003                 | 0    | 0   | 0   | 0   | 0   | 0   | 0   | 0   | 0   |
| 2004                 | 1    | 1   | 1   | 1   | 1   | 1   | 1   | 1   | 1   |
| 2005                 | 3    | 3   | 3   | 3   | 3   | 3   | 3   | 3   | 3   |
| 2006                 | 14   | 14  | 14  | 14  | 14  | 14  | 14  | 14  | 14  |
| 2007                 | 33   | 33  | 33  | 33  | 33  | 33  | 33  | 33  | 33  |
| 2008                 | 67   | 67  | 67  | 67  | 67  | 67  | 67  | 67  | 67  |
| 2009                 | 128  | 128 | 128 | 128 | 128 | 128 | 128 | 128 | 128 |
| 2010                 | 210  | 210 | 210 | 210 | 210 | 210 | 210 | 210 | 210 |
| 2011                 | 313  | 313 | 313 | 313 | 313 | 313 | 313 | 313 | 313 |
| 2012                 | 418  | 313 | 418 | 418 | 418 | 418 | 418 | 418 | 418 |
| 2013                 | 547  | 313 | 547 | 547 | 547 | 547 | 547 | 547 | 547 |
| 2014                 | 665  | 313 | 665 | 665 | 665 | 665 | 665 | 665 | 665 |
| 2015                 | 814  | 313 | 814 | 814 | 814 | 814 | 814 | 814 | 814 |
| 2016                 | 957  | 313 | 814 | 814 | 814 | 814 | 814 | 814 | 814 |
| 2017                 | 1109 | 313 | 814 | 814 | 814 | 814 | 814 | 814 | 814 |
| 2018                 | 1276 | 313 | 814 | 814 | 814 | 814 | 814 | 814 | 814 |
| 2019                 | 1449 | 313 | 814 | 814 | 814 | 814 | 814 | 814 | 814 |
| 2020                 | 1449 | 313 | 814 | 814 | 814 | 814 | 814 | 814 | 814 |
| 2021                 | 1449 | 313 | 814 | 814 | 814 | 814 | 814 | 814 | 814 |
| 2022                 | 1449 | 313 | 814 | 814 | 814 | 814 | 814 | 814 | 814 |
| 2023                 | 1449 | 313 | 814 | 814 | 814 | 814 | 814 | 814 | 814 |
| 2024                 | 1449 | 313 | 814 | 814 | 814 | 814 | 814 | 814 | 814 |
| 2025                 | 1449 | 313 | 814 | 814 | 814 | 814 | 814 | 814 | 814 |
| 2026                 | 1449 | 313 | 814 | 814 | 814 | 814 | 814 | 814 | 814 |
| 2027                 | 1449 | 313 | 814 | 814 | 814 | 814 | 814 | 814 | 814 |
| 2028                 | 1449 | 313 | 814 | 814 | 814 | 814 | 814 | 814 | 814 |
| 2029                 | 1449 | 313 | 814 | 814 | 814 | 814 | 814 | 814 | 814 |
| 2030                 | 1449 | 313 | 814 | 814 | 814 | 814 | 814 | 814 | 814 |
| 2031                 | 1449 | 313 | 814 | 814 | 814 | 814 | 814 | 814 | 814 |
| 2032                 | 1449 | 313 | 814 | 814 | 814 | 814 | 814 | 814 | 814 |
| 2033                 | 1449 | 313 | 814 | 814 | 814 | 814 | 814 | 814 | 814 |
| 2034                 | 1449 | 313 | 814 | 814 | 814 | 814 | 814 | 814 | 814 |
| 2035                 | 1449 | 313 | 814 | 814 | 814 | 814 | 814 | 814 | 814 |
| 2036                 | 1449 | 313 | 814 | 814 | 814 | 814 | 814 | 814 | 814 |
| 2037                 | 1449 | 313 | 814 | 814 | 814 | 814 | 814 | 814 | 814 |
| 2038                 | 1449 | 313 | 814 | 814 | 814 | 814 | 814 | 814 | 814 |
| 2039                 | 1449 | 313 | 814 | 814 | 814 | 814 | 814 | 814 | 814 |
| 2040                 | 1449 | 313 | 814 | 814 | 814 | 814 | 814 | 814 | 814 |
| 2041                 | 1449 | 313 | 814 | 814 | 814 | 814 | 814 | 814 | 814 |
| 2042                 | 1449 | 313 | 814 | 814 | 814 | 814 | 814 | 814 | 814 |
| 2043                 | 1449 | 313 | 814 | 814 | 814 | 814 | 814 | 814 | 814 |
| 2044                 | 1449 | 313 | 814 | 814 | 814 | 814 | 814 | 814 | 814 |
| 2045                 | 1449 | 313 | 814 | 814 | 814 | 814 | 814 | 814 | 814 |
| 2046                 | 1449 | 313 | 814 | 814 | 814 | 814 | 814 | 814 | 814 |
| 2047                 | 1449 | 313 | 814 | 814 | 814 | 814 | 814 | 814 | 814 |
| 2048                 | 1449 | 313 | 814 | 814 | 814 | 814 | 814 | 814 | 814 |
| 2049                 | 1449 | 313 | 814 | 814 | 814 | 814 | 814 | 814 | 814 |
| 2050                 | 1449 | 313 | 814 | 814 | 814 | 814 | 814 | 814 | 814 |
| 2051                 | 1449 | 313 | 814 | 814 | 814 | 814 | 814 | 814 | 814 |

| ScenarioID /<br>Year | 55   | 56  | 57  | 58  | 59  | 60  | 61  | 62  | 63  |
|----------------------|------|-----|-----|-----|-----|-----|-----|-----|-----|
| 2052                 | 1449 | 313 | 814 | 814 | 814 | 814 | 814 | 814 | 814 |
| 2053                 | 1449 | 313 | 814 | 814 | 814 | 814 | 814 | 814 | 814 |
| 2054                 | 1449 | 313 | 814 | 814 | 814 | 814 | 814 | 814 | 814 |
| 2055                 | 1449 | 313 | 814 | 814 | 814 | 814 | 814 | 814 | 814 |
| 2056                 | 1449 | 313 | 814 | 814 | 814 | 814 | 814 | 814 | 814 |
| 2057                 | 1449 | 313 | 814 | 814 | 814 | 814 | 814 | 814 | 814 |
| 2058                 | 1449 | 313 | 814 | 814 | 814 | 814 | 814 | 814 | 814 |
| 2059                 | 1449 | 313 | 814 | 814 | 814 | 814 | 814 | 814 | 814 |
| 2060                 | 1449 | 313 | 814 | 814 | 814 | 814 | 814 | 814 | 814 |
| 2061                 | 1449 | 313 | 814 | 814 | 814 | 814 | 814 | 814 | 814 |
| 2062                 | 1449 | 313 | 814 | 814 | 814 | 814 | 814 | 814 | 814 |
| 2063                 | 1449 | 313 | 814 | 814 | 814 | 814 | 814 | 814 | 814 |
| 2064                 | 1449 | 313 | 814 | 814 | 814 | 814 | 814 | 814 | 814 |
| 2065                 | 1449 | 313 | 814 | 814 | 814 | 814 | 814 | 814 | 814 |
| 2066                 | 1449 | 313 | 814 | 814 | 814 | 814 | 814 | 814 | 814 |
| 2067                 | 1449 | 313 | 814 | 814 | 814 | 814 | 814 | 814 | 814 |
| 2068                 | 1449 | 313 | 814 | 814 | 814 | 814 | 814 | 814 | 814 |
| 2069                 | 1449 | 313 | 814 | 814 | 814 | 814 | 814 | 814 | 814 |
| 2070                 | 1449 | 313 | 814 | 814 | 814 | 814 | 814 | 814 | 814 |
| 2071                 | 1449 | 313 | 814 | 814 | 814 | 814 | 814 | 814 | 814 |
| 2072                 | 1449 | 313 | 814 | 814 | 814 | 814 | 814 | 814 | 814 |
| 2073                 | 1449 | 313 | 814 | 814 | 814 | 814 | 814 | 814 | 814 |
| 2074                 | 1449 | 313 | 814 | 814 | 814 | 814 | 814 | 814 | 814 |
| 2075                 | 1449 | 313 | 814 | 814 | 814 | 814 | 814 | 814 | 814 |
| 2076                 | 1449 | 313 | 814 | 814 | 814 | 814 | 814 | 814 | 814 |
| 2077                 | 1449 | 313 | 814 | 814 | 814 | 814 | 814 | 814 | 814 |
| 2078                 | 1449 | 313 | 814 | 814 | 814 | 814 | 814 | 814 | 814 |
| 2079                 | 1449 | 313 | 814 | 814 | 814 | 814 | 814 | 814 | 814 |
| 2080                 | 1449 | 313 | 814 | 814 | 814 | 814 | 814 | 814 | 814 |
| 2081                 | 1449 | 313 | 814 | 814 | 814 | 814 | 814 | 814 | 814 |
| 2082                 | 1449 | 313 | 814 | 814 | 814 | 814 | 814 | 814 | 814 |
| 2083                 | 1449 | 313 | 814 | 814 | 814 | 814 | 814 | 814 | 814 |
| 2084                 | 1449 | 313 | 814 | 814 | 814 | 814 | 814 | 814 | 814 |
| 2085                 | 1449 | 313 | 814 | 814 | 814 | 814 | 814 | 814 | 814 |
| 2086                 | 1449 | 313 | 814 | 814 | 814 | 814 | 814 | 814 | 814 |
| 2087                 | 1449 | 313 | 814 | 814 | 814 | 814 | 814 | 814 | 814 |
| 2088                 | 1449 | 313 | 814 | 814 | 814 | 814 | 814 | 814 | 814 |
| 2089                 | 1449 | 313 | 814 | 814 | 814 | 814 | 814 | 814 | 814 |
| 2090                 | 1449 | 313 | 814 | 814 | 814 | 814 | 814 | 814 | 814 |

| ScenarioID / Year | 64   | 65  | 66  | 67  | 68  | 69  | 70  | 71  | 72  |
|-------------------|------|-----|-----|-----|-----|-----|-----|-----|-----|
| 2002              | 0    | 0   | 0   | 0   | 0   | 0   | 0   | 0   | 0   |
| 2003              | 0    | 0   | 0   | 0   | 0   | 0   | 0   | 0   | 0   |
| 2004              | 1    | 1   | 1   | 1   | 1   | 1   | 1   | 1   | 1   |
| 2005              | 3    | 3   | 3   | 3   | 3   | 3   | 3   | 3   | 3   |
| 2006              | 14   | 14  | 14  | 14  | 14  | 14  | 14  | 14  | 14  |
| 2007              | 33   | 33  | 33  | 33  | 33  | 33  | 33  | 33  | 33  |
| 2008              | 67   | 67  | 67  | 67  | 67  | 67  | 67  | 67  | 67  |
| 2009              | 128  | 128 | 128 | 128 | 128 | 128 | 128 | 128 | 128 |
| 2010              | 210  | 210 | 210 | 210 | 210 | 210 | 210 | 210 | 210 |
| 2011              | 313  | 313 | 313 | 313 | 313 | 313 | 313 | 313 | 313 |
| 2012              | 418  | 313 | 418 | 418 | 418 | 418 | 418 | 418 | 418 |
| 2013              | 547  | 313 | 547 | 547 | 547 | 547 | 547 | 547 | 547 |
| 2014              | 665  | 313 | 665 | 665 | 665 | 665 | 665 | 665 | 665 |
| 2015              | 814  | 313 | 814 | 814 | 814 | 814 | 814 | 814 | 814 |
| 2016              | 957  | 313 | 814 | 814 | 814 | 814 | 814 | 814 | 814 |
| 2017              | 1109 | 313 | 814 | 814 | 814 | 814 | 814 | 814 | 814 |
| 2018              | 1276 | 313 | 814 | 814 | 814 | 814 | 814 | 814 | 814 |
| 2019              | 1449 | 313 | 814 | 814 | 814 | 814 | 814 | 814 | 814 |
| 2020              | 1449 | 313 | 814 | 814 | 814 | 814 | 814 | 814 | 814 |
| 2021              | 1449 | 313 | 814 | 814 | 814 | 814 | 814 | 814 | 814 |
| 2022              | 1449 | 313 | 814 | 814 | 814 | 814 | 814 | 814 | 814 |
| 2023              | 1449 | 313 | 814 | 814 | 814 | 814 | 814 | 814 | 814 |
| 2024              | 1449 | 313 | 814 | 814 | 814 | 814 | 814 | 814 | 814 |
| 2025              | 1449 | 313 | 814 | 814 | 814 | 814 | 814 | 814 | 814 |
| 2026              | 1449 | 313 | 814 | 814 | 814 | 814 | 814 | 814 | 814 |
| 2027              | 1449 | 313 | 814 | 814 | 814 | 814 | 814 | 814 | 814 |
| 2028              | 1449 | 313 | 814 | 814 | 814 | 814 | 814 | 814 | 814 |
| 2029              | 1449 | 313 | 814 | 814 | 814 | 814 | 814 | 814 | 814 |
| 2030              | 1449 | 313 | 814 | 814 | 814 | 814 | 814 | 814 | 814 |
| 2031              | 1449 | 313 | 814 | 814 | 814 | 814 | 814 | 814 | 814 |
| 2032              | 1449 | 313 | 814 | 814 | 814 | 814 | 814 | 814 | 814 |
| 2033              | 1449 | 313 | 814 | 814 | 814 | 814 | 814 | 814 | 814 |
| 2034              | 1449 | 313 | 814 | 814 | 814 | 814 | 814 | 814 | 814 |
| 2035              | 1449 | 313 | 814 | 814 | 814 | 814 | 814 | 814 | 814 |
| 2036              | 1449 | 313 | 814 | 814 | 814 | 814 | 814 | 814 | 814 |
| 2037              | 1449 | 313 | 814 | 814 | 814 | 814 | 814 | 814 | 814 |
| 2038              | 1449 | 313 | 814 | 814 | 814 | 814 | 814 | 814 | 814 |
| 2039              | 1449 | 313 | 814 | 814 | 814 | 814 | 814 | 814 | 814 |
| 2040              | 1449 | 313 | 814 | 814 | 814 | 814 | 814 | 814 | 814 |
| 2041              | 1449 | 313 | 814 | 814 | 814 | 814 | 814 | 814 | 814 |
| 2042              | 1449 | 313 | 814 | 814 | 814 | 814 | 814 | 814 | 814 |
| 2043              | 1449 | 313 | 814 | 814 | 814 | 814 | 814 | 814 | 814 |
| 2044              | 1449 | 313 | 814 | 814 | 814 | 814 | 814 | 814 | 814 |
| 2045              | 1449 | 313 | 814 | 814 | 814 | 814 | 814 | 814 | 814 |
| 2046              | 1449 | 313 | 814 | 814 | 814 | 814 | 814 | 814 | 814 |
| 2047              | 1449 | 313 | 814 | 814 | 814 | 814 | 814 | 814 | 814 |
| 2048              | 1449 | 313 | 814 | 814 | 814 | 814 | 814 | 814 | 814 |
| 2049              | 1449 | 313 | 814 | 814 | 814 | 814 | 814 | 814 | 814 |
| 2050              | 1449 | 313 | 814 | 814 | 814 | 814 | 814 | 814 | 814 |
| 2051              | 1449 | 313 | 814 | 814 | 814 | 814 | 814 | 814 | 814 |



| ScenarioID /<br>Year | 64   | 65  | 66  | 67  | 68  | 69  | 70  | 71  | 72  |
|----------------------|------|-----|-----|-----|-----|-----|-----|-----|-----|
| 2052                 | 1449 | 313 | 814 | 814 | 814 | 814 | 814 | 814 | 814 |
| 2053                 | 1449 | 313 | 814 | 814 | 814 | 814 | 814 | 814 | 814 |
| 2054                 | 1449 | 313 | 814 | 814 | 814 | 814 | 814 | 814 | 814 |
| 2055                 | 1449 | 313 | 814 | 814 | 814 | 814 | 814 | 814 | 814 |
| 2056                 | 1449 | 313 | 814 | 814 | 814 | 814 | 814 | 814 | 814 |
| 2057                 | 1449 | 313 | 814 | 814 | 814 | 814 | 814 | 814 | 814 |
| 2058                 | 1449 | 313 | 814 | 814 | 814 | 814 | 814 | 814 | 814 |
| 2059                 | 1449 | 313 | 814 | 814 | 814 | 814 | 814 | 814 | 814 |
| 2060                 | 1449 | 313 | 814 | 814 | 814 | 814 | 814 | 814 | 814 |
| 2061                 | 1449 | 313 | 814 | 814 | 814 | 814 | 814 | 814 | 814 |
| 2062                 | 1449 | 313 | 814 | 814 | 814 | 814 | 814 | 814 | 814 |
| 2063                 | 1449 | 313 | 814 | 814 | 814 | 814 | 814 | 814 | 814 |
| 2064                 | 1449 | 313 | 814 | 814 | 814 | 814 | 814 | 814 | 814 |
| 2065                 | 1449 | 313 | 814 | 814 | 814 | 814 | 814 | 814 | 814 |
| 2066                 | 1449 | 313 | 814 | 814 | 814 | 814 | 814 | 814 | 814 |
| 2067                 | 1449 | 313 | 814 | 814 | 814 | 814 | 814 | 814 | 814 |
| 2068                 | 1449 | 313 | 814 | 814 | 814 | 814 | 814 | 814 | 814 |
| 2069                 | 1449 | 313 | 814 | 814 | 814 | 814 | 814 | 814 | 814 |
| 2070                 | 1449 | 313 | 814 | 814 | 814 | 814 | 814 | 814 | 814 |
| 2071                 | 1449 | 313 | 814 | 814 | 814 | 814 | 814 | 814 | 814 |
| 2072                 | 1449 | 313 | 814 | 814 | 814 | 814 | 814 | 814 | 814 |
| 2073                 | 1449 | 313 | 814 | 814 | 814 | 814 | 814 | 814 | 814 |
| 2074                 | 1449 | 313 | 814 | 814 | 814 | 814 | 814 | 814 | 814 |
| 2075                 | 1449 | 313 | 814 | 814 | 814 | 814 | 814 | 814 | 814 |
| 2076                 | 1449 | 313 | 814 | 814 | 814 | 814 | 814 | 814 | 814 |
| 2077                 | 1449 | 313 | 814 | 814 | 814 | 814 | 814 | 814 | 814 |
| 2078                 | 1449 | 313 | 814 | 814 | 814 | 814 | 814 | 814 | 814 |
| 2079                 | 1449 | 313 | 814 | 814 | 814 | 814 | 814 | 814 | 814 |
| 2080                 | 1449 | 313 | 814 | 814 | 814 | 814 | 814 | 814 | 814 |
| 2081                 | 1449 | 313 | 814 | 814 | 814 | 814 | 814 | 814 | 814 |
| 2082                 | 1449 | 313 | 814 | 814 | 814 | 814 | 814 | 814 | 814 |
| 2083                 | 1449 | 313 | 814 | 814 | 814 | 814 | 814 | 814 | 814 |
| 2084                 | 1449 | 313 | 814 | 814 | 814 | 814 | 814 | 814 | 814 |
| 2085                 | 1449 | 313 | 814 | 814 | 814 | 814 | 814 | 814 | 814 |
| 2086                 | 1449 | 313 | 814 | 814 | 814 | 814 | 814 | 814 | 814 |
| 2087                 | 1449 | 313 | 814 | 814 | 814 | 814 | 814 | 814 | 814 |
| 2088                 | 1449 | 313 | 814 | 814 | 814 | 814 | 814 | 814 | 814 |
| 2089                 | 1449 | 313 | 814 | 814 | 814 | 814 | 814 | 814 | 814 |
| 2090                 | 1449 | 313 | 814 | 814 | 814 | 814 | 814 | 814 | 814 |

| ScenarioID /<br>Year | 73   | 74  | 75  | 76  | 77  | 78  | 79  | 80  | 81  |
|----------------------|------|-----|-----|-----|-----|-----|-----|-----|-----|
| 2002                 | 0    | 0   | 0   | 0   | 0   | 0   | 0   | 0   | 0   |
| 2003                 | 0    | 0   | 0   | 0   | 0   | 0   | 0   | 0   | 0   |
| 2004                 | 1    | 1   | 1   | 1   | 1   | 1   | 1   | 1   | 1   |
| 2005                 | 3    | 3   | 3   | 3   | 3   | 3   | 3   | 3   | 3   |
| 2006                 | 14   | 14  | 14  | 14  | 14  | 14  | 14  | 14  | 14  |
| 2007                 | 33   | 33  | 33  | 33  | 33  | 33  | 33  | 33  | 33  |
| 2008                 | 67   | 67  | 67  | 67  | 67  | 67  | 67  | 67  | 67  |
| 2009                 | 128  | 128 | 128 | 128 | 128 | 128 | 128 | 128 | 128 |
| 2010                 | 210  | 210 | 210 | 210 | 210 | 210 | 210 | 210 | 210 |
| 2011                 | 313  | 313 | 313 | 313 | 313 | 313 | 313 | 313 | 313 |
| 2012                 | 418  | 313 | 418 | 418 | 418 | 418 | 418 | 418 | 418 |
| 2013                 | 547  | 313 | 547 | 547 | 547 | 547 | 547 | 547 | 547 |
| 2014                 | 665  | 313 | 665 | 665 | 665 | 665 | 665 | 665 | 665 |
| 2015                 | 814  | 313 | 814 | 814 | 814 | 814 | 814 | 814 | 814 |
| 2016                 | 957  | 313 | 814 | 814 | 814 | 814 | 814 | 814 | 814 |
| 2017                 | 1109 | 313 | 814 | 814 | 814 | 814 | 814 | 814 | 814 |
| 2018                 | 1276 | 313 | 814 | 814 | 814 | 814 | 814 | 814 | 814 |
| 2019                 | 1449 | 313 | 814 | 814 | 814 | 814 | 814 | 814 | 814 |
| 2020                 | 1449 | 313 | 814 | 814 | 814 | 814 | 814 | 814 | 814 |
| 2021                 | 1449 | 313 | 814 | 814 | 814 | 814 | 814 | 814 | 814 |
| 2022                 | 1449 | 313 | 814 | 814 | 814 | 814 | 814 | 814 | 814 |
| 2023                 | 1449 | 313 | 814 | 814 | 814 | 814 | 814 | 814 | 814 |
| 2024                 | 1449 | 313 | 814 | 814 | 814 | 814 | 814 | 814 | 814 |
| 2025                 | 1449 | 313 | 814 | 814 | 814 | 814 | 814 | 814 | 814 |
| 2026                 | 1449 | 313 | 814 | 814 | 814 | 814 | 814 | 814 | 814 |
| 2027                 | 1449 | 313 | 814 | 814 | 814 | 814 | 814 | 814 | 814 |
| 2028                 | 1449 | 313 | 814 | 814 | 814 | 814 | 814 | 814 | 814 |
| 2029                 | 1449 | 313 | 814 | 814 | 814 | 814 | 814 | 814 | 814 |
| 2030                 | 1449 | 313 | 814 | 814 | 814 | 814 | 814 | 814 | 814 |
| 2031                 | 1449 | 313 | 814 | 814 | 814 | 814 | 814 | 814 | 814 |
| 2032                 | 1449 | 313 | 814 | 814 | 814 | 814 | 814 | 814 | 814 |
| 2033                 | 1449 | 313 | 814 | 814 | 814 | 814 | 814 | 814 | 814 |
| 2034                 | 1449 | 313 | 814 | 814 | 814 | 814 | 814 | 814 | 814 |
| 2035                 | 1449 | 313 | 814 | 814 | 814 | 814 | 814 | 814 | 814 |
| 2036                 | 1449 | 313 | 814 | 814 | 814 | 814 | 814 | 814 | 814 |
| 2037                 | 1449 | 313 | 814 | 814 | 814 | 814 | 814 | 814 | 814 |
| 2038                 | 1449 | 313 | 814 | 814 | 814 | 814 | 814 | 814 | 814 |
| 2039                 | 1449 | 313 | 814 | 814 | 814 | 814 | 814 | 814 | 814 |
| 2040                 | 1449 | 313 | 814 | 814 | 814 | 814 | 814 | 814 | 814 |
| 2041                 | 1449 | 313 | 814 | 814 | 814 | 814 | 814 | 814 | 814 |
| 2042                 | 1449 | 313 | 814 | 814 | 814 | 814 | 814 | 814 | 814 |
| 2043                 | 1449 | 313 | 814 | 814 | 814 | 814 | 814 | 814 | 814 |
| 2044                 | 1449 | 313 | 814 | 814 | 814 | 814 | 814 | 814 | 814 |
| 2045                 | 1449 | 313 | 814 | 814 | 814 | 814 | 814 | 814 | 814 |
| 2046                 | 1449 | 313 | 814 | 814 | 814 | 814 | 814 | 814 | 814 |
| 2047                 | 1449 | 313 | 814 | 814 | 814 | 814 | 814 | 814 | 814 |
| 2048                 | 1449 | 313 | 814 | 814 | 814 | 814 | 814 | 814 | 814 |
| 2049                 | 1449 | 313 | 814 | 814 | 814 | 814 | 814 | 814 | 814 |
| 2050                 | 1449 | 313 | 814 | 814 | 814 | 814 | 814 | 814 | 814 |
| 2051                 | 1449 | 313 | 814 | 814 | 814 | 814 | 814 | 814 | 814 |

| ScenarioID /<br>Year | 73   | 74  | 75  | 76  | 77  | 78  | 79  | 80  | 81  |
|----------------------|------|-----|-----|-----|-----|-----|-----|-----|-----|
| 2052                 | 1449 | 313 | 814 | 814 | 814 | 814 | 814 | 814 | 814 |
| 2053                 | 1449 | 313 | 814 | 814 | 814 | 814 | 814 | 814 | 814 |
| 2054                 | 1449 | 313 | 814 | 814 | 814 | 814 | 814 | 814 | 814 |
| 2055                 | 1449 | 313 | 814 | 814 | 814 | 814 | 814 | 814 | 814 |
| 2056                 | 1449 | 313 | 814 | 814 | 814 | 814 | 814 | 814 | 814 |
| 2057                 | 1449 | 313 | 814 | 814 | 814 | 814 | 814 | 814 | 814 |
| 2058                 | 1449 | 313 | 814 | 814 | 814 | 814 | 814 | 814 | 814 |
| 2059                 | 1449 | 313 | 814 | 814 | 814 | 814 | 814 | 814 | 814 |
| 2060                 | 1449 | 313 | 814 | 814 | 814 | 814 | 814 | 814 | 814 |
| 2061                 | 1449 | 313 | 814 | 814 | 814 | 814 | 814 | 814 | 814 |
| 2062                 | 1449 | 313 | 814 | 814 | 814 | 814 | 814 | 814 | 814 |
| 2063                 | 1449 | 313 | 814 | 814 | 814 | 814 | 814 | 814 | 814 |
| 2064                 | 1449 | 313 | 814 | 814 | 814 | 814 | 814 | 814 | 814 |
| 2065                 | 1449 | 313 | 814 | 814 | 814 | 814 | 814 | 814 | 814 |
| 2066                 | 1449 | 313 | 814 | 814 | 814 | 814 | 814 | 814 | 814 |
| 2067                 | 1449 | 313 | 814 | 814 | 814 | 814 | 814 | 814 | 814 |
| 2068                 | 1449 | 313 | 814 | 814 | 814 | 814 | 814 | 814 | 814 |
| 2069                 | 1449 | 313 | 814 | 814 | 814 | 814 | 814 | 814 | 814 |
| 2070                 | 1449 | 313 | 814 | 814 | 814 | 814 | 814 | 814 | 814 |
| 2071                 | 1449 | 313 | 814 | 814 | 814 | 814 | 814 | 814 | 814 |
| 2072                 | 1449 | 313 | 814 | 814 | 814 | 814 | 814 | 814 | 814 |
| 2073                 | 1449 | 313 | 814 | 814 | 814 | 814 | 814 | 814 | 814 |
| 2074                 | 1449 | 313 | 814 | 814 | 814 | 814 | 814 | 814 | 814 |
| 2075                 | 1449 | 313 | 814 | 814 | 814 | 814 | 814 | 814 | 814 |
| 2076                 | 1449 | 313 | 814 | 814 | 814 | 814 | 814 | 814 | 814 |
| 2077                 | 1449 | 313 | 814 | 814 | 814 | 814 | 814 | 814 | 814 |
| 2078                 | 1449 | 313 | 814 | 814 | 814 | 814 | 814 | 814 | 814 |
| 2079                 | 1449 | 313 | 814 | 814 | 814 | 814 | 814 | 814 | 814 |
| 2080                 | 1449 | 313 | 814 | 814 | 814 | 814 | 814 | 814 | 814 |
| 2081                 | 1449 | 313 | 814 | 814 | 814 | 814 | 814 | 814 | 814 |
| 2082                 | 1449 | 313 | 814 | 814 | 814 | 814 | 814 | 814 | 814 |
| 2083                 | 1449 | 313 | 814 | 814 | 814 | 814 | 814 | 814 | 814 |
| 2084                 | 1449 | 313 | 814 | 814 | 814 | 814 | 814 | 814 | 814 |
| 2085                 | 1449 | 313 | 814 | 814 | 814 | 814 | 814 | 814 | 814 |
| 2086                 | 1449 | 313 | 814 | 814 | 814 | 814 | 814 | 814 | 814 |
| 2087                 | 1449 | 313 | 814 | 814 | 814 | 814 | 814 | 814 | 814 |
| 2088                 | 1449 | 313 | 814 | 814 | 814 | 814 | 814 | 814 | 814 |
| 2089                 | 1449 | 313 | 814 | 814 | 814 | 814 | 814 | 814 | 814 |
| 2090                 | 1449 | 313 | 814 | 814 | 814 | 814 | 814 | 814 | 814 |

| ScenarioID /<br>Year | 1    | 2    | 3    | 4    | 5    | 6    | 7    | 8    | 9    |
|----------------------|------|------|------|------|------|------|------|------|------|
| 2002                 | 0    | 0    | 0    | 0    | 0    | 0    | 0    | 0    | 0    |
| 2003                 | 0    | 0    | 0    | 0    | 0    | 0    | 0    | 0    | 0    |
| 2004                 | 1    | 1    | 1    | 1    | 1    | 1    | 1    | 1    | 1    |
| 2005                 | 3    | 3    | 3    | 3    | 3    | 3    | 3    | 3    | 3    |
| 2006                 | 14   | 14   | 14   | 14   | 14   | 14   | 14   | 14   | 14   |
| 2007                 | 33   | 33   | 33   | 33   | 33   | 33   | 33   | 33   | 33   |
| 2008                 | 67   | 67   | 67   | 67   | 67   | 67   | 67   | 67   | 67   |
| 2009                 | 128  | 128  | 128  | 128  | 128  | 128  | 128  | 128  | 128  |
| 2010                 | 210  | 210  | 210  | 210  | 210  | 210  | 210  | 210  | 210  |
| 2011                 | 313  | 313  | 313  | 313  | 313  | 313  | 313  | 313  | 313  |
| 2012                 | 418  | 418  | 418  | 418  | 418  | 418  | 418  | 418  | 418  |
| 2013                 | 547  | 547  | 547  | 547  | 547  | 547  | 547  | 547  | 547  |
| 2014                 | 665  | 665  | 665  | 665  | 665  | 665  | 665  | 665  | 665  |
| 2015                 | 814  | 814  | 814  | 814  | 814  | 814  | 814  | 814  | 814  |
| 2016                 | 957  | 957  | 957  | 957  | 957  | 957  | 957  | 957  | 957  |
| 2017                 | 1109 | 1109 | 1109 | 1109 | 1109 | 1109 | 1109 | 1109 | 1109 |
| 2018                 | 1276 | 1276 | 1276 | 1276 | 1276 | 1276 | 1276 | 1276 | 1276 |
| 2019                 | 1449 | 1449 | 1449 | 1449 | 1449 | 1449 | 1449 | 1449 | 1449 |
| 2020                 | 1622 | 1622 | 1622 | 1842 | 1622 | 1622 | 1622 | 1622 | 1622 |
| 2021                 | 1808 | 1808 | 1808 | 2246 | 1808 | 1808 | 1808 | 1808 | 1808 |
| 2022                 | 1974 | 1974 | 1974 | 2623 | 1974 | 1974 | 1974 | 1974 | 1974 |
| 2023                 | 2164 | 2164 | 2164 | 2997 | 2164 | 2164 | 2164 | 2164 | 2164 |
| 2024                 | 2363 | 2363 | 2363 | 3361 | 2363 | 2363 | 2363 | 2363 | 2363 |
| 2025                 | 2768 | 2768 | 2555 | 3719 | 2768 | 2768 | 2768 | 2768 | 2768 |
| 2026                 | 3182 | 3182 | 2738 | 4076 | 3182 | 3182 | 3182 | 3182 | 3182 |
| 2027                 | 3566 | 3566 | 2931 | 4422 | 3566 | 3566 | 3566 | 3566 | 3566 |
| 2028                 | 3966 | 3966 | 3125 | 4779 | 3966 | 3966 | 3966 | 3966 | 3966 |
| 2029                 | 4312 | 4312 | 3297 | 5119 | 4312 | 4312 | 4312 | 4312 | 4312 |
| 2030                 | 4667 | 4667 | 3724 | 5464 | 4672 | 4669 | 4667 | 4667 | 4667 |
| 2031                 | 5042 | 5042 | 4149 | 5808 | 5039 | 5027 | 5042 | 5042 | 5042 |
| 2032                 | 5387 | 5387 | 4548 | 6138 | 5387 | 5367 | 5387 | 5387 | 5387 |
| 2033                 | 5743 | 5743 | 4941 | 6468 | 5744 | 5716 | 5743 | 5743 | 5743 |
| 2034                 | 6125 | 6125 | 5350 | 6829 | 6126 | 6086 | 6125 | 6125 | 6125 |
| 2035                 | 6454 | 6454 | 5747 | 7154 | 6465 | 6421 | 6454 | 6454 | 6454 |
| 2036                 | 6791 | 6791 | 6097 | 7486 | 6801 | 6754 | 6791 | 6791 | 6791 |
| 2037                 | 7145 | 7142 | 6459 | 7561 | 7158 | 7105 | 7142 | 7142 | 7142 |
| 2038                 | 7457 | 7454 | 6777 | 7576 | 7454 | 7397 | 7450 | 7450 | 7450 |
| 2039                 | 7551 | 7551 | 7120 | 7614 | 7547 | 7543 | 7548 | 7548 | 7548 |
| 2040                 | 7574 | 7574 | 7448 | 7640 | 7570 | 7568 | 7571 | 7571 | 7571 |
| 2041                 | 7607 | 7613 | 7543 | 7677 | 7609 | 7598 | 7610 | 7610 | 7610 |
| 2042                 | 7655 | 7661 | 7580 | 7735 | 7655 | 7640 | 7658 | 7658 | 7658 |
| 2043                 | 7695 | 7701 | 7617 | 7781 | 7696 | 7682 | 7698 | 7698 | 7698 |
| 2044                 | 7744 | 7750 | 7661 | 7829 | 7744 | 7726 | 7747 | 7747 | 7747 |
| 2045                 | 7829 | 7835 | 7748 | 7911 | 7825 | 7810 | 7832 | 7832 | 7832 |
| 2046                 | 7896 | 7902 | 7819 | 7978 | 7891 | 7879 | 7899 | 7899 | 7899 |
| 2047                 | 7962 | 7968 | 7887 | 8035 | 7957 | 7944 | 7965 | 7965 | 7965 |
| 2048                 | 8034 | 8040 | 7964 | 8096 | 8029 | 8014 | 8037 | 8037 | 8037 |
| 2049                 | 8044 | 8050 | 7974 | 8106 | 8039 | 8024 | 8047 | 8047 | 8047 |
| 2050                 | 8065 | 8071 | 7995 | 8127 | 8060 | 8046 | 8068 | 8068 | 8068 |
| 2051                 | 8085 | 8091 | 8015 | 8147 | 8080 | 8067 | 8088 | 8088 | 8088 |

| ScenarioID /<br>Year | 1    | 2    | 3    | 4    | 5    | 6    | 7    | 8    | 9    |
|----------------------|------|------|------|------|------|------|------|------|------|
| 2052                 | 8090 | 8096 | 8020 | 8152 | 8085 | 8072 | 8093 | 8093 | 8093 |
| 2053                 | 8090 | 8096 | 8020 | 8152 | 8085 | 8072 | 8093 | 8093 | 8093 |
| 2054                 | 8103 | 8109 | 8033 | 8165 | 8098 | 8085 | 8106 | 8106 | 8106 |
| 2055                 | 8105 | 8111 | 8035 | 8167 | 8100 | 8087 | 8108 | 8108 | 8108 |
| 2056                 | 8115 | 8121 | 8045 | 8177 | 8110 | 8097 | 8118 | 8118 | 8118 |
| 2057                 | 8115 | 8121 | 8045 | 8177 | 8110 | 8097 | 8118 | 8118 | 8118 |
| 2058                 | 8115 | 8121 | 8045 | 8177 | 8110 | 8097 | 8118 | 8118 | 8118 |
| 2059                 | 8115 | 8121 | 8045 | 8177 | 8110 | 8097 | 8118 | 8118 | 8118 |
| 2060                 | 8115 | 8121 | 8045 | 8177 | 8110 | 8097 | 8118 | 8118 | 8118 |
| 2061                 | 8115 | 8121 | 8045 | 8177 | 8110 | 8097 | 8118 | 8118 | 8118 |
| 2062                 | 8115 | 8121 | 8045 | 8177 | 8110 | 8097 | 8118 | 8118 | 8118 |
| 2063                 | 8115 | 8121 | 8045 | 8177 | 8110 | 8097 | 8118 | 8118 | 8118 |
| 2064                 | 8115 | 8121 | 8045 | 8177 | 8110 | 8097 | 8118 | 8118 | 8118 |
| 2065                 | 8115 | 8121 | 8045 | 8177 | 8110 | 8097 | 8118 | 8118 | 8118 |
| 2066                 | 8115 | 8121 | 8045 | 8177 | 8110 | 8097 | 8118 | 8118 | 8118 |
| 2067                 | 8115 | 8121 | 8045 | 8177 | 8110 | 8097 | 8118 | 8118 | 8118 |
| 2068                 | 8115 | 8121 | 8045 | 8177 | 8110 | 8097 | 8118 | 8118 | 8118 |
| 2069                 | 8115 | 8121 | 8045 | 8177 | 8110 | 8097 | 8118 | 8118 | 8118 |
| 2070                 | 8115 | 8121 | 8045 | 8177 | 8110 | 8097 | 8118 | 8118 | 8118 |
| 2071                 | 8115 | 8121 | 8045 | 8177 | 8110 | 8097 | 8118 | 8118 | 8118 |
| 2072                 | 8115 | 8121 | 8045 | 8177 | 8110 | 8097 | 8118 | 8118 | 8118 |
| 2073                 | 8115 | 8121 | 8045 | 8177 | 8110 | 8097 | 8118 | 8118 | 8118 |
| 2074                 | 8115 | 8121 | 8045 | 8177 | 8110 | 8097 | 8118 | 8118 | 8118 |
| 2075                 | 8115 | 8121 | 8045 | 8177 | 8110 | 8097 | 8118 | 8118 | 8118 |
| 2076                 | 8115 | 8121 | 8045 | 8177 | 8110 | 8097 | 8118 | 8118 | 8118 |
| 2077                 | 8115 | 8121 | 8045 | 8177 | 8110 | 8097 | 8118 | 8118 | 8118 |
| 2078                 | 8115 | 8121 | 8045 | 8177 | 8110 | 8097 | 8118 | 8118 | 8118 |
| 2079                 | 8115 | 8121 | 8045 | 8177 | 8110 | 8097 | 8118 | 8118 | 8118 |
| 2080                 | 8115 | 8121 | 8045 | 8177 | 8110 | 8097 | 8118 | 8118 | 8118 |
| 2081                 | 8115 | 8121 | 8045 | 8177 | 8110 | 8097 | 8118 | 8118 | 8118 |
| 2082                 | 8115 | 8121 | 8045 | 8177 | 8110 | 8097 | 8118 | 8118 | 8118 |
| 2083                 | 8115 | 8121 | 8045 | 8177 | 8110 | 8097 | 8118 | 8118 | 8118 |
| 2084                 | 8115 | 8121 | 8045 | 8177 | 8110 | 8097 | 8118 | 8118 | 8118 |
| 2085                 | 8115 | 8121 | 8045 | 8177 | 8110 | 8097 | 8118 | 8118 | 8118 |
| 2086                 | 8115 | 8121 | 8045 | 8177 | 8110 | 8097 | 8118 | 8118 | 8118 |
| 2087                 | 8115 | 8121 | 8045 | 8177 | 8110 | 8097 | 8118 | 8118 | 8118 |
| 2088                 | 8115 | 8121 | 8045 | 8177 | 8110 | 8097 | 8118 | 8118 | 8118 |
| 2089                 | 8115 | 8121 | 8045 | 8177 | 8110 | 8097 | 8118 | 8118 | 8118 |
| 2090                 | 8115 | 8121 | 8045 | 8177 | 8110 | 8097 | 8118 | 8118 | 8118 |

| ScenarioID /<br>Year | 10   | 11   | 12   | 13   | 14   | 15   | 16   | 17   | 18   |
|----------------------|------|------|------|------|------|------|------|------|------|
| 2002                 | 0    | 0    | 0    | 0    | 0    | 0    | 0    | 0    | 0    |
| 2003                 | 0    | 0    | 0    | 0    | 0    | 0    | 0    | 0    | 0    |
| 2004                 | 1    | 1    | 1    | 1    | 1    | 1    | 1    | 1    | 1    |
| 2005                 | 3    | 3    | 3    | 3    | 3    | 3    | 3    | 3    | 3    |
| 2006                 | 14   | 14   | 14   | 14   | 14   | 14   | 14   | 14   | 14   |
| 2007                 | 33   | 33   | 33   | 33   | 33   | 33   | 33   | 33   | 33   |
| 2008                 | 67   | 67   | 67   | 67   | 67   | 67   | 67   | 67   | 67   |
| 2009                 | 128  | 128  | 128  | 128  | 128  | 128  | 128  | 128  | 128  |
| 2010                 | 210  | 210  | 210  | 210  | 210  | 210  | 210  | 210  | 210  |
| 2011                 | 313  | 313  | 313  | 313  | 313  | 313  | 313  | 313  | 313  |
| 2012                 | 418  | 418  | 418  | 418  | 418  | 418  | 418  | 418  | 418  |
| 2013                 | 547  | 547  | 547  | 547  | 547  | 547  | 547  | 547  | 547  |
| 2014                 | 665  | 665  | 665  | 665  | 665  | 665  | 665  | 665  | 665  |
| 2015                 | 814  | 814  | 814  | 814  | 814  | 814  | 814  | 814  | 814  |
| 2016                 | 957  | 957  | 957  | 957  | 957  | 957  | 957  | 957  | 957  |
| 2017                 | 1109 | 1109 | 1109 | 1109 | 1109 | 1109 | 1109 | 1109 | 1109 |
| 2018                 | 1276 | 1276 | 1276 | 1276 | 1276 | 1276 | 1276 | 1276 | 1276 |
| 2019                 | 1449 | 1449 | 1449 | 1449 | 1449 | 1449 | 1449 | 1449 | 1449 |
| 2020                 | 1622 | 1622 | 1622 | 1824 | 1622 | 1622 | 1622 | 1622 | 1622 |
| 2021                 | 1808 | 1808 | 1808 | 2216 | 1808 | 1808 | 1808 | 1808 | 1808 |
| 2022                 | 1974 | 1974 | 1974 | 2579 | 1974 | 1974 | 1974 | 1974 | 1974 |
| 2023                 | 2164 | 2164 | 2164 | 2968 | 2164 | 2164 | 2164 | 2164 | 2164 |
| 2024                 | 2363 | 2363 | 2363 | 3318 | 2363 | 2363 | 2363 | 2363 | 2363 |
| 2025                 | 2761 | 2761 | 2555 | 3676 | 2761 | 2761 | 2761 | 2761 | 2761 |
| 2026                 | 3151 | 3151 | 2738 | 4030 | 3151 | 3143 | 3151 | 3151 | 3151 |
| 2027                 | 3525 | 3525 | 2931 | 4379 | 3525 | 3515 | 3525 | 3525 | 3525 |
| 2028                 | 3918 | 3917 | 3125 | 4739 | 3913 | 3893 | 3917 | 3917 | 3917 |
| 2029                 | 4269 | 4266 | 3297 | 5080 | 4261 | 4240 | 4266 | 4266 | 4266 |
| 2030                 | 4635 | 4632 | 3716 | 5426 | 4635 | 4606 | 4632 | 4632 | 4632 |
| 2031                 | 5012 | 5005 | 4132 | 5774 | 5016 | 4980 | 5005 | 5005 | 5005 |
| 2032                 | 5361 | 5343 | 4511 | 6125 | 5360 | 5315 | 5346 | 5346 | 5346 |
| 2033                 | 5717 | 5694 | 4868 | 6455 | 5719 | 5676 | 5703 | 5703 | 5703 |
| 2034                 | 6066 | 6043 | 5236 | 6779 | 6065 | 6020 | 6056 | 6056 | 6056 |
| 2035                 | 6424 | 6398 | 5637 | 7113 | 6410 | 6373 | 6417 | 6417 | 6417 |
| 2036                 | 6726 | 6702 | 5959 | 7381 | 6726 | 6698 | 6721 | 6721 | 6721 |
| 2037                 | 7068 | 7042 | 6300 | 7527 | 7045 | 7031 | 7056 | 7056 | 7056 |
| 2038                 | 7379 | 7335 | 6616 | 7544 | 7359 | 7323 | 7349 | 7349 | 7349 |
| 2039                 | 7536 | 7516 | 6919 | 7562 | 7523 | 7514 | 7529 | 7529 | 7529 |
| 2040                 | 7556 | 7538 | 7207 | 7583 | 7546 | 7533 | 7551 | 7551 | 7551 |
| 2041                 | 7574 | 7561 | 7495 | 7603 | 7569 | 7552 | 7574 | 7574 | 7574 |
| 2042                 | 7597 | 7584 | 7546 | 7627 | 7592 | 7574 | 7597 | 7597 | 7597 |
| 2043                 | 7654 | 7645 | 7574 | 7695 | 7654 | 7635 | 7658 | 7658 | 7658 |
| 2044                 | 7734 | 7725 | 7644 | 7778 | 7733 | 7713 | 7738 | 7738 | 7738 |
| 2045                 | 7805 | 7795 | 7704 | 7841 | 7804 | 7782 | 7808 | 7808 | 7808 |
| 2046                 | 7887 | 7877 | 7785 | 7917 | 7886 | 7862 | 7890 | 7890 | 7890 |
| 2047                 | 7949 | 7939 | 7843 | 7966 | 7948 | 7924 | 7952 | 7952 | 7952 |
| 2048                 | 8001 | 7991 | 7913 | 8010 | 8000 | 7975 | 8004 | 8004 | 8004 |
| 2049                 | 8008 | 7998 | 7923 | 8016 | 8007 | 7982 | 8011 | 8011 | 8011 |
| 2050                 | 8020 | 8010 | 7944 | 8028 | 8019 | 7995 | 8023 | 8023 | 8023 |
| 2051                 | 8037 | 8027 | 7964 | 8041 | 8036 | 8013 | 8040 | 8040 | 8040 |

| ScenarioID /<br>Year | 10   | 11   | 12   | 13   | 14   | 15   | 16   | 17   | 18   |
|----------------------|------|------|------|------|------|------|------|------|------|
| 2052                 | 8040 | 8030 | 7969 | 8044 | 8039 | 8016 | 8043 | 8043 | 8043 |
| 2053                 | 8040 | 8030 | 7969 | 8044 | 8039 | 8016 | 8043 | 8043 | 8043 |
| 2054                 | 8050 | 8040 | 7982 | 8054 | 8049 | 8026 | 8053 | 8053 | 8053 |
| 2055                 | 8050 | 8040 | 7984 | 8054 | 8049 | 8026 | 8053 | 8053 | 8053 |
| 2056                 | 8058 | 8047 | 7994 | 8054 | 8057 | 8032 | 8060 | 8060 | 8060 |
| 2057                 | 8059 | 8048 | 7994 | 8054 | 8058 | 8033 | 8061 | 8061 | 8061 |
| 2058                 | 8059 | 8048 | 7994 | 8054 | 8058 | 8033 | 8061 | 8061 | 8061 |
| 2059                 | 8059 | 8048 | 7994 | 8054 | 8058 | 8033 | 8061 | 8061 | 8061 |
| 2060                 | 8059 | 8048 | 7994 | 8054 | 8058 | 8033 | 8061 | 8061 | 8061 |
| 2061                 | 8059 | 8048 | 7994 | 8054 | 8058 | 8033 | 8061 | 8061 | 8061 |
| 2062                 | 8059 | 8048 | 7994 | 8054 | 8058 | 8033 | 8061 | 8061 | 8061 |
| 2063                 | 8059 | 8048 | 7994 | 8054 | 8058 | 8033 | 8061 | 8061 | 8061 |
| 2064                 | 8059 | 8048 | 7994 | 8054 | 8058 | 8033 | 8061 | 8061 | 8061 |
| 2065                 | 8059 | 8048 | 7994 | 8054 | 8058 | 8033 | 8061 | 8061 | 8061 |
| 2066                 | 8059 | 8048 | 7994 | 8054 | 8058 | 8033 | 8061 | 8061 | 8061 |
| 2067                 | 8059 | 8048 | 7994 | 8054 | 8058 | 8033 | 8061 | 8061 | 8061 |
| 2068                 | 8059 | 8048 | 7994 | 8054 | 8058 | 8033 | 8061 | 8061 | 8061 |
| 2069                 | 8059 | 8048 | 7994 | 8054 | 8058 | 8033 | 8061 | 8061 | 8061 |
| 2070                 | 8059 | 8048 | 7994 | 8054 | 8058 | 8033 | 8061 | 8061 | 8061 |
| 2071                 | 8059 | 8048 | 7994 | 8054 | 8058 | 8033 | 8061 | 8061 | 8061 |
| 2072                 | 8059 | 8048 | 7994 | 8054 | 8058 | 8033 | 8061 | 8061 | 8061 |
| 2073                 | 8059 | 8048 | 7994 | 8054 | 8058 | 8033 | 8061 | 8061 | 8061 |
| 2074                 | 8059 | 8048 | 7994 | 8054 | 8058 | 8033 | 8061 | 8061 | 8061 |
| 2075                 | 8059 | 8048 | 7994 | 8054 | 8058 | 8033 | 8061 | 8061 | 8061 |
| 2076                 | 8059 | 8048 | 7994 | 8054 | 8058 | 8033 | 8061 | 8061 | 8061 |
| 2077                 | 8059 | 8048 | 7994 | 8054 | 8058 | 8033 | 8061 | 8061 | 8061 |
| 2078                 | 8059 | 8048 | 7994 | 8054 | 8058 | 8033 | 8061 | 8061 | 8061 |
| 2079                 | 8059 | 8048 | 7994 | 8054 | 8058 | 8033 | 8061 | 8061 | 8061 |
| 2080                 | 8059 | 8048 | 7994 | 8054 | 8058 | 8033 | 8061 | 8061 | 8061 |
| 2081                 | 8059 | 8048 | 7994 | 8054 | 8058 | 8033 | 8061 | 8061 | 8061 |
| 2082                 | 8059 | 8048 | 7994 | 8054 | 8058 | 8033 | 8061 | 8061 | 8061 |
| 2083                 | 8059 | 8048 | 7994 | 8054 | 8058 | 8033 | 8061 | 8061 | 8061 |
| 2084                 | 8059 | 8048 | 7994 | 8054 | 8058 | 8033 | 8061 | 8061 | 8061 |
| 2085                 | 8059 | 8048 | 7994 | 8054 | 8058 | 8033 | 8061 | 8061 | 8061 |
| 2086                 | 8059 | 8048 | 7994 | 8054 | 8058 | 8033 | 8061 | 8061 | 8061 |
| 2087                 | 8059 | 8048 | 7994 | 8054 | 8058 | 8033 | 8061 | 8061 | 8061 |
| 2088                 | 8059 | 8048 | 7994 | 8054 | 8058 | 8033 | 8061 | 8061 | 8061 |
| 2089                 | 8059 | 8048 | 7994 | 8054 | 8058 | 8033 | 8061 | 8061 | 8061 |
| 2090                 | 8059 | 8048 | 7994 | 8054 | 8058 | 8033 | 8061 | 8061 | 8061 |

| ScenarioID / Year | 19   | 20   | 21   | 22   | 23   | 24   | 25   | 26   | 27   |
|-------------------|------|------|------|------|------|------|------|------|------|
| 2002              | 0    | 0    | 0    | 0    | 0    | 0    | 0    | 0    | 0    |
| 2003              | 0    | 0    | 0    | 0    | 0    | 0    | 0    | 0    | 0    |
| 2004              | 1    | 1    | 1    | 1    | 1    | 1    | 1    | 1    | 1    |
| 2005              | 3    | 3    | 3    | 3    | 3    | 3    | 3    | 3    | 3    |
| 2006              | 14   | 14   | 14   | 14   | 14   | 14   | 14   | 14   | 14   |
| 2007              | 33   | 33   | 33   | 33   | 33   | 33   | 33   | 33   | 33   |
| 2008              | 67   | 67   | 67   | 67   | 67   | 67   | 67   | 67   | 67   |
| 2009              | 128  | 128  | 128  | 128  | 128  | 128  | 128  | 128  | 128  |
| 2010              | 210  | 210  | 210  | 210  | 210  | 210  | 210  | 210  | 210  |
| 2011              | 313  | 313  | 313  | 313  | 313  | 313  | 313  | 313  | 313  |
| 2012              | 418  | 418  | 418  | 418  | 418  | 418  | 418  | 418  | 418  |
| 2013              | 547  | 547  | 547  | 547  | 547  | 547  | 547  | 547  | 547  |
| 2014              | 665  | 665  | 665  | 665  | 665  | 665  | 665  | 665  | 665  |
| 2015              | 814  | 814  | 814  | 814  | 814  | 814  | 814  | 814  | 814  |
| 2016              | 957  | 957  | 957  | 957  | 957  | 957  | 957  | 957  | 957  |
| 2017              | 1109 | 1109 | 1109 | 1109 | 1109 | 1109 | 1109 | 1109 | 1109 |
| 2018              | 1276 | 1276 | 1276 | 1276 | 1276 | 1276 | 1276 | 1276 | 1276 |
| 2019              | 1449 | 1449 | 1449 | 1449 | 1449 | 1449 | 1449 | 1449 | 1449 |
| 2020              | 1622 | 1622 | 1622 | 1824 | 1622 | 1622 | 1622 | 1622 | 1622 |
| 2021              | 1808 | 1808 | 1808 | 2216 | 1808 | 1808 | 1808 | 1808 | 1808 |
| 2022              | 1974 | 1974 | 1974 | 2578 | 1974 | 1974 | 1974 | 1974 | 1974 |
| 2023              | 2164 | 2164 | 2164 | 2963 | 2164 | 2164 | 2164 | 2164 | 2164 |
| 2024              | 2363 | 2363 | 2363 | 3311 | 2363 | 2363 | 2363 | 2363 | 2363 |
| 2025              | 2761 | 2761 | 2555 | 3679 | 2761 | 2761 | 2761 | 2761 | 2761 |
| 2026              | 3149 | 3149 | 2738 | 4032 | 3150 | 3147 | 3149 | 3149 | 3149 |
| 2027              | 3522 | 3522 | 2931 | 4380 | 3523 | 3520 | 3522 | 3522 | 3522 |
| 2028              | 3910 | 3910 | 3125 | 4743 | 3917 | 3904 | 3910 | 3910 | 3910 |
| 2029              | 4250 | 4250 | 3297 | 5078 | 4261 | 4240 | 4250 | 4250 | 4250 |
| 2030              | 4624 | 4618 | 3716 | 5438 | 4631 | 4605 | 4618 | 4618 | 4618 |
| 2031              | 5006 | 4994 | 4120 | 5792 | 5005 | 4980 | 4994 | 4994 | 4994 |
| 2032              | 5360 | 5344 | 4498 | 6142 | 5347 | 5327 | 5349 | 5349 | 5349 |
| 2033              | 5711 | 5695 | 4855 | 6468 | 5702 | 5679 | 5701 | 5701 | 5701 |
| 2034              | 6078 | 6057 | 5220 | 6798 | 6051 | 6028 | 6066 | 6066 | 6066 |
| 2035              | 6441 | 6414 | 5623 | 7146 | 6400 | 6377 | 6426 | 6426 | 6426 |
| 2036              | 6766 | 6732 | 5969 | 7447 | 6713 | 6706 | 6743 | 6743 | 6743 |
| 2037              | 7098 | 7058 | 6311 | 7559 | 7041 | 7051 | 7070 | 7070 | 7070 |
| 2038              | 7391 | 7355 | 6636 | 7582 | 7347 | 7354 | 7366 | 7366 | 7366 |
| 2039              | 7515 | 7532 | 6961 | 7602 | 7533 | 7519 | 7518 | 7518 | 7518 |
| 2040              | 7543 | 7557 | 7271 | 7624 | 7558 | 7542 | 7544 | 7544 | 7544 |
| 2041              | 7561 | 7575 | 7505 | 7649 | 7577 | 7561 | 7562 | 7562 | 7562 |
| 2042              | 7589 | 7601 | 7524 | 7679 | 7603 | 7586 | 7588 | 7588 | 7588 |
| 2043              | 7654 | 7665 | 7564 | 7743 | 7667 | 7650 | 7653 | 7653 | 7653 |
| 2044              | 7734 | 7744 | 7637 | 7831 | 7746 | 7729 | 7732 | 7732 | 7732 |
| 2045              | 7811 | 7816 | 7707 | 7905 | 7818 | 7801 | 7805 | 7805 | 7805 |
| 2046              | 7894 | 7899 | 7787 | 7987 | 7901 | 7883 | 7888 | 7888 | 7888 |
| 2047              | 7955 | 7960 | 7849 | 8049 | 7962 | 7945 | 7949 | 7949 | 7949 |
| 2048              | 8007 | 8012 | 7920 | 8100 | 8014 | 7997 | 8001 | 8001 | 8001 |
| 2049              | 8014 | 8019 | 7930 | 8107 | 8021 | 8004 | 8008 | 8008 | 8008 |
| 2050              | 8026 | 8031 | 7951 | 8120 | 8033 | 8017 | 8020 | 8020 | 8020 |
| 2051              | 8043 | 8048 | 7971 | 8137 | 8050 | 8035 | 8037 | 8037 | 8037 |



| ScenarioID /<br>Year | 19   | 20   | 21   | 22   | 23   | 24   | 25   | 26   | 27   |
|----------------------|------|------|------|------|------|------|------|------|------|
| 2052                 | 8046 | 8051 | 7976 | 8140 | 8053 | 8038 | 8040 | 8040 | 8040 |
| 2053                 | 8046 | 8051 | 7976 | 8140 | 8053 | 8038 | 8040 | 8040 | 8040 |
| 2054                 | 8056 | 8061 | 7989 | 8150 | 8063 | 8048 | 8050 | 8050 | 8050 |
| 2055                 | 8056 | 8061 | 7991 | 8150 | 8063 | 8048 | 8050 | 8050 | 8050 |
| 2056                 | 8065 | 8068 | 8001 | 8150 | 8070 | 8055 | 8058 | 8058 | 8058 |
| 2057                 | 8066 | 8069 | 8001 | 8150 | 8071 | 8056 | 8059 | 8059 | 8059 |
| 2058                 | 8066 | 8069 | 8001 | 8150 | 8071 | 8056 | 8059 | 8059 | 8059 |
| 2059                 | 8066 | 8069 | 8001 | 8150 | 8071 | 8056 | 8059 | 8059 | 8059 |
| 2060                 | 8066 | 8069 | 8001 | 8150 | 8071 | 8056 | 8059 | 8059 | 8059 |
| 2061                 | 8066 | 8069 | 8001 | 8150 | 8071 | 8056 | 8059 | 8059 | 8059 |
| 2062                 | 8066 | 8069 | 8001 | 8150 | 8071 | 8056 | 8059 | 8059 | 8059 |
| 2063                 | 8066 | 8069 | 8001 | 8150 | 8071 | 8056 | 8059 | 8059 | 8059 |
| 2064                 | 8066 | 8069 | 8001 | 8150 | 8071 | 8056 | 8059 | 8059 | 8059 |
| 2065                 | 8066 | 8069 | 8001 | 8150 | 8071 | 8056 | 8059 | 8059 | 8059 |
| 2066                 | 8066 | 8069 | 8001 | 8150 | 8071 | 8056 | 8059 | 8059 | 8059 |
| 2067                 | 8066 | 8069 | 8001 | 8150 | 8071 | 8056 | 8059 | 8059 | 8059 |
| 2068                 | 8066 | 8069 | 8001 | 8150 | 8071 | 8056 | 8059 | 8059 | 8059 |
| 2069                 | 8066 | 8069 | 8001 | 8150 | 8071 | 8056 | 8059 | 8059 | 8059 |
| 2070                 | 8066 | 8069 | 8001 | 8150 | 8071 | 8056 | 8059 | 8059 | 8059 |
| 2071                 | 8066 | 8069 | 8001 | 8150 | 8071 | 8056 | 8059 | 8059 | 8059 |
| 2072                 | 8066 | 8069 | 8001 | 8150 | 8071 | 8056 | 8059 | 8059 | 8059 |
| 2073                 | 8066 | 8069 | 8001 | 8150 | 8071 | 8056 | 8059 | 8059 | 8059 |
| 2074                 | 8066 | 8069 | 8001 | 8150 | 8071 | 8056 | 8059 | 8059 | 8059 |
| 2075                 | 8066 | 8069 | 8001 | 8150 | 8071 | 8056 | 8059 | 8059 | 8059 |
| 2076                 | 8066 | 8069 | 8001 | 8150 | 8071 | 8056 | 8059 | 8059 | 8059 |
| 2077                 | 8066 | 8069 | 8001 | 8150 | 8071 | 8056 | 8059 | 8059 | 8059 |
| 2078                 | 8066 | 8069 | 8001 | 8150 | 8071 | 8056 | 8059 | 8059 | 8059 |
| 2079                 | 8066 | 8069 | 8001 | 8150 | 8071 | 8056 | 8059 | 8059 | 8059 |
| 2080                 | 8066 | 8069 | 8001 | 8150 | 8071 | 8056 | 8059 | 8059 | 8059 |
| 2081                 | 8066 | 8069 | 8001 | 8150 | 8071 | 8056 | 8059 | 8059 | 8059 |
| 2082                 | 8066 | 8069 | 8001 | 8150 | 8071 | 8056 | 8059 | 8059 | 8059 |
| 2083                 | 8066 | 8069 | 8001 | 8150 | 8071 | 8056 | 8059 | 8059 | 8059 |
| 2084                 | 8066 | 8069 | 8001 | 8150 | 8071 | 8056 | 8059 | 8059 | 8059 |
| 2085                 | 8066 | 8069 | 8001 | 8150 | 8071 | 8056 | 8059 | 8059 | 8059 |
| 2086                 | 8066 | 8069 | 8001 | 8150 | 8071 | 8056 | 8059 | 8059 | 8059 |
| 2087                 | 8066 | 8069 | 8001 | 8150 | 8071 | 8056 | 8059 | 8059 | 8059 |
| 2088                 | 8066 | 8069 | 8001 | 8150 | 8071 | 8056 | 8059 | 8059 | 8059 |
| 2089                 | 8066 | 8069 | 8001 | 8150 | 8071 | 8056 | 8059 | 8059 | 8059 |
| 2090                 | 8066 | 8069 | 8001 | 8150 | 8071 | 8056 | 8059 | 8059 | 8059 |

| ScenarioID /<br>Year | 28    | 29    | 30    | 31    | 32    | 33    | 34    | 35    | 36    |
|----------------------|-------|-------|-------|-------|-------|-------|-------|-------|-------|
| 2002                 | 0     | 0     | 0     | 0     | 0     | 0     | 0     | 0     | 0     |
| 2003                 | 0     | 0     | 0     | 0     | 0     | 0     | 0     | 0     | 0     |
| 2004                 | 1     | 1     | 1     | 1     | 1     | 1     | 1     | 1     | 1     |
| 2005                 | 3     | 3     | 3     | 3     | 3     | 3     | 3     | 3     | 3     |
| 2006                 | 14    | 14    | 14    | 14    | 14    | 14    | 14    | 14    | 14    |
| 2007                 | 33    | 33    | 33    | 33    | 33    | 33    | 33    | 33    | 33    |
| 2008                 | 67    | 67    | 67    | 67    | 67    | 67    | 67    | 67    | 67    |
| 2009                 | 128   | 128   | 128   | 128   | 128   | 128   | 128   | 128   | 128   |
| 2010                 | 210   | 210   | 210   | 210   | 210   | 210   | 210   | 210   | 210   |
| 2011                 | 313   | 313   | 313   | 313   | 313   | 313   | 313   | 313   | 313   |
| 2012                 | 418   | 418   | 418   | 418   | 418   | 418   | 418   | 418   | 418   |
| 2013                 | 547   | 547   | 547   | 547   | 547   | 547   | 547   | 547   | 547   |
| 2014                 | 665   | 665   | 665   | 665   | 665   | 665   | 665   | 665   | 665   |
| 2015                 | 814   | 814   | 814   | 814   | 814   | 814   | 814   | 814   | 814   |
| 2016                 | 957   | 957   | 957   | 957   | 957   | 957   | 957   | 957   | 957   |
| 2017                 | 1109  | 1109  | 1109  | 1109  | 1109  | 1109  | 1109  | 1109  | 1109  |
| 2018                 | 1276  | 1276  | 1276  | 1276  | 1276  | 1276  | 1276  | 1276  | 1276  |
| 2019                 | 1449  | 1449  | 1449  | 1449  | 1449  | 1449  | 1449  | 1449  | 1449  |
| 2020                 | 1622  | 1622  | 1622  | 1881  | 1622  | 1622  | 1622  | 1622  | 1622  |
| 2021                 | 1808  | 1808  | 1808  | 2305  | 1808  | 1808  | 1808  | 1808  | 1808  |
| 2022                 | 1974  | 1974  | 1974  | 2708  | 1974  | 1974  | 1974  | 1974  | 1974  |
| 2023                 | 2164  | 2164  | 2164  | 3121  | 2164  | 2164  | 2164  | 2164  | 2164  |
| 2024                 | 2363  | 2363  | 2363  | 3536  | 2363  | 2363  | 2363  | 2363  | 2363  |
| 2025                 | 2822  | 2822  | 2555  | 3934  | 2822  | 2822  | 2822  | 2822  | 2822  |
| 2026                 | 3249  | 3249  | 2738  | 4333  | 3249  | 3249  | 3249  | 3249  | 3249  |
| 2027                 | 3674  | 3674  | 2931  | 4729  | 3674  | 3674  | 3674  | 3674  | 3674  |
| 2028                 | 4091  | 4091  | 3125  | 5087  | 4091  | 4091  | 4091  | 4091  | 4091  |
| 2029                 | 4485  | 4485  | 3297  | 5430  | 4485  | 4479  | 4485  | 4485  | 4485  |
| 2030                 | 4900  | 4900  | 3770  | 5813  | 4900  | 4876  | 4900  | 4900  | 4900  |
| 2031                 | 5316  | 5316  | 4212  | 6169  | 5320  | 5232  | 5316  | 5316  | 5316  |
| 2032                 | 5694  | 5698  | 4633  | 6513  | 5715  | 5585  | 5698  | 5698  | 5698  |
| 2033                 | 6031  | 6025  | 5051  | 6830  | 6095  | 5945  | 6026  | 6026  | 6026  |
| 2034                 | 6426  | 6399  | 5518  | 7196  | 6483  | 6358  | 6404  | 6404  | 6404  |
| 2035                 | 6787  | 6755  | 5943  | 7513  | 6813  | 6719  | 6765  | 6765  | 6765  |
| 2036                 | 7138  | 7095  | 6348  | 7796  | 7103  | 7054  | 7105  | 7105  | 7105  |
| 2037                 | 7480  | 7429  | 6736  | 8063  | 7408  | 7391  | 7436  | 7436  | 7436  |
| 2038                 | 7813  | 7736  | 7058  | 8317  | 7695  | 7692  | 7743  | 7743  | 7743  |
| 2039                 | 8155  | 8055  | 7339  | 8606  | 8001  | 8028  | 8067  | 8067  | 8067  |
| 2040                 | 8486  | 8365  | 7656  | 8919  | 8338  | 8364  | 8378  | 8378  | 8378  |
| 2041                 | 8824  | 8661  | 7991  | 9245  | 8628  | 8688  | 8700  | 8700  | 8700  |
| 2042                 | 9162  | 8988  | 8341  | 9575  | 8943  | 9022  | 9044  | 9044  | 9044  |
| 2043                 | 9470  | 9310  | 8681  | 9888  | 9274  | 9333  | 9359  | 9359  | 9359  |
| 2044                 | 9767  | 9619  | 8999  | 10167 | 9552  | 9637  | 9667  | 9667  | 9667  |
| 2045                 | 10086 | 9937  | 9311  | 10465 | 9850  | 9930  | 9986  | 9986  | 9986  |
| 2046                 | 10381 | 10244 | 9623  | 10744 | 10121 | 10212 | 10292 | 10292 | 10292 |
| 2047                 | 10627 | 10498 | 9900  | 10975 | 10368 | 10446 | 10545 | 10545 | 10545 |
| 2048                 | 10893 | 10745 | 10167 | 11231 | 10609 | 10698 | 10793 | 10793 | 10793 |
| 2049                 | 11139 | 10990 | 10419 | 11474 | 10842 | 10948 | 11036 | 11036 | 11036 |
| 2050                 | 11388 | 11244 | 10673 | 11718 | 11082 | 11179 | 11287 | 11287 | 11287 |
| 2051                 | 11654 | 11507 | 10927 | 11976 | 11343 | 11445 | 11547 | 11547 | 11547 |

| ScenarioID /<br>Year | 28    | 29    | 30    | 31    | 32    | 33    | 34    | 35    | 36    |
|----------------------|-------|-------|-------|-------|-------|-------|-------|-------|-------|
| 2052                 | 11945 | 11794 | 11214 | 12258 | 11631 | 11737 | 11840 | 11840 | 11840 |
| 2053                 | 12243 | 12090 | 11515 | 12546 | 11924 | 12039 | 12136 | 12136 | 12136 |
| 2054                 | 12530 | 12382 | 11812 | 12839 | 12216 | 12345 | 12403 | 12403 | 12403 |
| 2055                 | 12823 | 12658 | 12102 | 13143 | 12519 | 12649 | 12677 | 12677 | 12677 |
| 2056                 | 13113 | 12939 | 12392 | 13420 | 12811 | 12944 | 12960 | 12960 | 12960 |
| 2057                 | 13384 | 13206 | 12673 | 13623 | 13107 | 13245 | 13250 | 13250 | 13250 |
| 2058                 | 13595 | 13472 | 12931 | 13735 | 13385 | 13515 | 13510 | 13510 | 13510 |
| 2059                 | 13719 | 13639 | 13181 | 13810 | 13593 | 13639 | 13679 | 13679 | 13679 |
| 2060                 | 13789 | 13731 | 13381 | 13872 | 13757 | 13738 | 13774 | 13774 | 13774 |
| 2061                 | 13868 | 13819 | 13564 | 13937 | 13851 | 13816 | 13852 | 13852 | 13852 |
| 2062                 | 13932 | 13907 | 13695 | 13998 | 13924 | 13881 | 13919 | 13919 | 13919 |
| 2063                 | 13985 | 13974 | 13793 | 14041 | 13986 | 13956 | 13975 | 13975 | 13975 |
| 2064                 | 14029 | 14018 | 13850 | 14075 | 14031 | 14017 | 14019 | 14019 | 14019 |
| 2065                 | 14080 | 14074 | 13912 | 14118 | 14077 | 14066 | 14075 | 14075 | 14075 |
| 2066                 | 14098 | 14102 | 13975 | 14125 | 14111 | 14090 | 14098 | 14098 | 14098 |
| 2067                 | 14113 | 14126 | 14030 | 14130 | 14119 | 14109 | 14113 | 14113 | 14113 |
| 2068                 | 14126 | 14129 | 14059 | 14133 | 14128 | 14116 | 14126 | 14126 | 14126 |
| 2069                 | 14136 | 14133 | 14088 | 14136 | 14128 | 14118 | 14136 | 14136 | 14136 |
| 2070                 | 14136 | 14136 | 14099 | 14136 | 14132 | 14122 | 14136 | 14136 | 14136 |
| 2071                 | 14136 | 14136 | 14102 | 14136 | 14136 | 14125 | 14136 | 14136 | 14136 |
| 2072                 | 14136 | 14136 | 14115 | 14136 | 14136 | 14128 | 14136 | 14136 | 14136 |
| 2073                 | 14136 | 14136 | 14128 | 14136 | 14136 | 14128 | 14136 | 14136 | 14136 |
| 2074                 | 14136 | 14136 | 14130 | 14136 | 14136 | 14130 | 14136 | 14136 | 14136 |
| 2075                 | 14136 | 14136 | 14133 | 14136 | 14136 | 14133 | 14136 | 14136 | 14136 |
| 2076                 | 14136 | 14136 | 14136 | 14136 | 14136 | 14133 | 14136 | 14136 | 14136 |
| 2077                 | 14136 | 14136 | 14136 | 14136 | 14136 | 14136 | 14136 | 14136 | 14136 |
| 2078                 | 14136 | 14136 | 14136 | 14136 | 14136 | 14136 | 14136 | 14136 | 14136 |
| 2079                 | 14136 | 14136 | 14136 | 14136 | 14136 | 14136 | 14136 | 14136 | 14136 |
| 2080                 | 14136 | 14136 | 14136 | 14136 | 14136 | 14136 | 14136 | 14136 | 14136 |
| 2081                 | 14136 | 14136 | 14136 | 14136 | 14136 | 14136 | 14136 | 14136 | 14136 |
| 2082                 | 14136 | 14136 | 14136 | 14136 | 14136 | 14136 | 14136 | 14136 | 14136 |
| 2083                 | 14136 | 14136 | 14136 | 14136 | 14136 | 14136 | 14136 | 14136 | 14136 |
| 2084                 | 14136 | 14136 | 14136 | 14136 | 14136 | 14136 | 14136 | 14136 | 14136 |
| 2085                 | 14136 | 14136 | 14136 | 14136 | 14136 | 14136 | 14136 | 14136 | 14136 |
| 2086                 | 14136 | 14136 | 14136 | 14136 | 14136 | 14136 | 14136 | 14136 | 14136 |
| 2087                 | 14136 | 14136 | 14136 | 14136 | 14136 | 14136 | 14136 | 14136 | 14136 |
| 2088                 | 14136 | 14136 | 14136 | 14136 | 14136 | 14136 | 14136 | 14136 | 14136 |
| 2089                 | 14136 | 14136 | 14136 | 14136 | 14136 | 14136 | 14136 | 14136 | 14136 |
| 2090                 | 14136 | 14136 | 14136 | 14136 | 14136 | 14136 | 14136 | 14136 | 14136 |

| ScenarioID / Year | 37    | 38    | 39   | 40    | 41    | 42    | 43    | 44    | 45    |
|-------------------|-------|-------|------|-------|-------|-------|-------|-------|-------|
| 2002              | 0     | 0     | 0    | 0     | 0     | 0     | 0     | 0     | 0     |
| 2003              | 0     | 0     | 0    | 0     | 0     | 0     | 0     | 0     | 0     |
| 2004              | 1     | 1     | 1    | 1     | 1     | 1     | 1     | 1     | 1     |
| 2005              | 3     | 3     | 3    | 3     | 3     | 3     | 3     | 3     | 3     |
| 2006              | 14    | 14    | 14   | 14    | 14    | 14    | 14    | 14    | 14    |
| 2007              | 33    | 33    | 33   | 33    | 33    | 33    | 33    | 33    | 33    |
| 2008              | 67    | 67    | 67   | 67    | 67    | 67    | 67    | 67    | 67    |
| 2009              | 128   | 128   | 128  | 128   | 128   | 128   | 128   | 128   | 128   |
| 2010              | 210   | 210   | 210  | 210   | 210   | 210   | 210   | 210   | 210   |
| 2011              | 313   | 313   | 313  | 313   | 313   | 313   | 313   | 313   | 313   |
| 2012              | 418   | 418   | 418  | 418   | 418   | 418   | 418   | 418   | 418   |
| 2013              | 547   | 547   | 547  | 547   | 547   | 547   | 547   | 547   | 547   |
| 2014              | 665   | 665   | 665  | 665   | 665   | 665   | 665   | 665   | 665   |
| 2015              | 814   | 814   | 814  | 814   | 814   | 814   | 814   | 814   | 814   |
| 2016              | 957   | 957   | 957  | 957   | 957   | 957   | 957   | 957   | 957   |
| 2017              | 1109  | 1109  | 1109 | 1109  | 1109  | 1109  | 1109  | 1109  | 1109  |
| 2018              | 1276  | 1276  | 1276 | 1276  | 1276  | 1276  | 1276  | 1276  | 1276  |
| 2019              | 1449  | 1449  | 1449 | 1449  | 1449  | 1449  | 1449  | 1449  | 1449  |
| 2020              | 1622  | 1622  | 1622 | 1861  | 1622  | 1622  | 1622  | 1622  | 1622  |
| 2021              | 1808  | 1808  | 1808 | 2282  | 1808  | 1808  | 1808  | 1808  | 1808  |
| 2022              | 1974  | 1974  | 1974 | 2682  | 1974  | 1974  | 1974  | 1974  | 1974  |
| 2023              | 2164  | 2164  | 2164 | 3098  | 2164  | 2164  | 2164  | 2164  | 2164  |
| 2024              | 2363  | 2363  | 2363 | 3483  | 2363  | 2363  | 2363  | 2363  | 2363  |
| 2025              | 2796  | 2796  | 2555 | 3870  | 2796  | 2796  | 2796  | 2796  | 2796  |
| 2026              | 3196  | 3196  | 2738 | 4239  | 3196  | 3189  | 3196  | 3196  | 3196  |
| 2027              | 3610  | 3610  | 2931 | 4617  | 3610  | 3588  | 3610  | 3610  | 3610  |
| 2028              | 4012  | 4009  | 3125 | 4983  | 4006  | 3971  | 4006  | 4006  | 4006  |
| 2029              | 4383  | 4376  | 3297 | 5341  | 4386  | 4327  | 4372  | 4372  | 4372  |
| 2030              | 4780  | 4772  | 3750 | 5720  | 4768  | 4705  | 4768  | 4768  | 4768  |
| 2031              | 5166  | 5125  | 4179 | 6068  | 5129  | 5076  | 5122  | 5122  | 5122  |
| 2032              | 5517  | 5441  | 4576 | 6397  | 5459  | 5422  | 5459  | 5459  | 5459  |
| 2033              | 5883  | 5781  | 4980 | 6736  | 5804  | 5769  | 5816  | 5816  | 5816  |
| 2034              | 6232  | 6130  | 5367 | 7062  | 6150  | 6136  | 6167  | 6167  | 6167  |
| 2035              | 6614  | 6494  | 5781 | 7395  | 6523  | 6542  | 6541  | 6541  | 6541  |
| 2036              | 6908  | 6793  | 6086 | 7668  | 6819  | 6869  | 6843  | 6843  | 6843  |
| 2037              | 7225  | 7095  | 6413 | 7932  | 7118  | 7205  | 7146  | 7146  | 7146  |
| 2038              | 7514  | 7342  | 6696 | 8160  | 7379  | 7509  | 7410  | 7410  | 7410  |
| 2039              | 7790  | 7634  | 6979 | 8400  | 7674  | 7802  | 7693  | 7693  | 7693  |
| 2040              | 8050  | 7909  | 7252 | 8631  | 7951  | 8049  | 7973  | 7973  | 7973  |
| 2041              | 8332  | 8190  | 7524 | 8855  | 8227  | 8284  | 8260  | 8260  | 8260  |
| 2042              | 8580  | 8457  | 7787 | 9066  | 8511  | 8466  | 8529  | 8529  | 8529  |
| 2043              | 8851  | 8718  | 8059 | 9293  | 8795  | 8683  | 8787  | 8787  | 8787  |
| 2044              | 9088  | 8957  | 8350 | 9517  | 9076  | 8899  | 9027  | 9027  | 9027  |
| 2045              | 9313  | 9184  | 8659 | 9729  | 9337  | 9145  | 9256  | 9256  | 9256  |
| 2046              | 9515  | 9388  | 8925 | 9908  | 9593  | 9371  | 9457  | 9457  | 9457  |
| 2047              | 9769  | 9603  | 9206 | 10118 | 9859  | 9621  | 9708  | 9708  | 9708  |
| 2048              | 10009 | 9833  | 9431 | 10339 | 10107 | 9879  | 9979  | 9979  | 9979  |
| 2049              | 10221 | 10040 | 9619 | 10532 | 10324 | 10129 | 10208 | 10208 | 10208 |
| 2050              | 10427 | 10245 | 9808 | 10695 | 10532 | 10357 | 10410 | 10410 | 10410 |
| 2051              | 10617 | 10406 | 9956 | 10845 | 10742 | 10578 | 10596 | 10596 | 10596 |

| ScenarioID /<br>Year | 37    | 38    | 39    | 40    | 41    | 42    | 43    | 44    | 45    |
|----------------------|-------|-------|-------|-------|-------|-------|-------|-------|-------|
| 2052                 | 10822 | 10592 | 10104 | 11003 | 10943 | 10780 | 10783 | 10783 | 10783 |
| 2053                 | 10996 | 10766 | 10249 | 11169 | 11134 | 10977 | 10965 | 10965 | 10965 |
| 2054                 | 11176 | 10960 | 10419 | 11352 | 11348 | 11192 | 11153 | 11153 | 11153 |
| 2055                 | 11375 | 11182 | 10638 | 11546 | 11582 | 11399 | 11369 | 11369 | 11369 |
| 2056                 | 11600 | 11434 | 10893 | 11762 | 11841 | 11623 | 11607 | 11607 | 11607 |
| 2057                 | 11862 | 11706 | 11169 | 12030 | 12101 | 11871 | 11867 | 11867 | 11867 |
| 2058                 | 12152 | 11975 | 11454 | 12316 | 12380 | 12162 | 12143 | 12143 | 12143 |
| 2059                 | 12435 | 12251 | 11736 | 12600 | 12650 | 12445 | 12427 | 12427 | 12427 |
| 2060                 | 12721 | 12530 | 12010 | 12879 | 12919 | 12727 | 12706 | 12706 | 12706 |
| 2061                 | 12978 | 12804 | 12282 | 13137 | 13181 | 13019 | 12975 | 12975 | 12975 |
| 2062                 | 13206 | 13087 | 12542 | 13357 | 13378 | 13276 | 13205 | 13205 | 13205 |
| 2063                 | 13409 | 13320 | 12815 | 13547 | 13575 | 13491 | 13416 | 13416 | 13416 |
| 2064                 | 13590 | 13523 | 13101 | 13711 | 13741 | 13670 | 13599 | 13599 | 13599 |
| 2065                 | 13743 | 13691 | 13356 | 13842 | 13851 | 13791 | 13749 | 13749 | 13749 |
| 2066                 | 13855 | 13816 | 13594 | 13926 | 13942 | 13865 | 13865 | 13865 | 13865 |
| 2067                 | 13946 | 13917 | 13762 | 13992 | 13998 | 13928 | 13958 | 13958 | 13958 |
| 2068                 | 13998 | 13980 | 13855 | 14025 | 14048 | 13968 | 14010 | 14010 | 14010 |
| 2069                 | 14040 | 14027 | 13928 | 14056 | 14082 | 14007 | 14050 | 14050 | 14050 |
| 2070                 | 14074 | 14061 | 13980 | 14080 | 14109 | 14038 | 14084 | 14084 | 14084 |
| 2071                 | 14106 | 14092 | 14030 | 14103 | 14124 | 14065 | 14105 | 14105 | 14105 |
| 2072                 | 14117 | 14114 | 14074 | 14122 | 14134 | 14097 | 14117 | 14117 | 14117 |
| 2073                 | 14131 | 14130 | 14103 | 14134 | 14136 | 14113 | 14130 | 14130 | 14130 |
| 2074                 | 14134 | 14133 | 14125 | 14136 | 14136 | 14116 | 14133 | 14133 | 14133 |
| 2075                 | 14136 | 14136 | 14133 | 14136 | 14136 | 14118 | 14136 | 14136 | 14136 |
| 2076                 | 14136 | 14136 | 14136 | 14136 | 14136 | 14122 | 14136 | 14136 | 14136 |
| 2077                 | 14136 | 14136 | 14136 | 14136 | 14136 | 14123 | 14136 | 14136 | 14136 |
| 2078                 | 14136 | 14136 | 14136 | 14136 | 14136 | 14127 | 14136 | 14136 | 14136 |
| 2079                 | 14136 | 14136 | 14136 | 14136 | 14136 | 14128 | 14136 | 14136 | 14136 |
| 2080                 | 14136 | 14136 | 14136 | 14136 | 14136 | 14132 | 14136 | 14136 | 14136 |
| 2081                 | 14136 | 14136 | 14136 | 14136 | 14136 | 14133 | 14136 | 14136 | 14136 |
| 2082                 | 14136 | 14136 | 14136 | 14136 | 14136 | 14134 | 14136 | 14136 | 14136 |
| 2083                 | 14136 | 14136 | 14136 | 14136 | 14136 | 14136 | 14136 | 14136 | 14136 |
| 2084                 | 14136 | 14136 | 14136 | 14136 | 14136 | 14136 | 14136 | 14136 | 14136 |
| 2085                 | 14136 | 14136 | 14136 | 14136 | 14136 | 14136 | 14136 | 14136 | 14136 |
| 2086                 | 14136 | 14136 | 14136 | 14136 | 14136 | 14136 | 14136 | 14136 | 14136 |
| 2087                 | 14136 | 14136 | 14136 | 14136 | 14136 | 14136 | 14136 | 14136 | 14136 |
| 2088                 | 14136 | 14136 | 14136 | 14136 | 14136 | 14136 | 14136 | 14136 | 14136 |
| 2089                 | 14136 | 14136 | 14136 | 14136 | 14136 | 14136 | 14136 | 14136 | 14136 |
| 2090                 | 14136 | 14136 | 14136 | 14136 | 14136 | 14136 | 14136 | 14136 | 14136 |

| ScenarioID /<br>Year | 46    | 47    | 48    | 49    | 50    | 51    | 52    | 53    | 54    |
|----------------------|-------|-------|-------|-------|-------|-------|-------|-------|-------|
| 2002                 | 0     | 0     | 0     | 0     | 0     | 0     | 0     | 0     | 0     |
| 2003                 | 0     | 0     | 0     | 0     | 0     | 0     | 0     | 0     | 0     |
| 2004                 | 1     | 1     | 1     | 1     | 1     | 1     | 1     | 1     | 1     |
| 2005                 | 3     | 3     | 3     | 3     | 3     | 3     | 3     | 3     | 3     |
| 2006                 | 14    | 14    | 14    | 14    | 14    | 14    | 14    | 14    | 14    |
| 2007                 | 33    | 33    | 33    | 33    | 33    | 33    | 33    | 33    | 33    |
| 2008                 | 67    | 67    | 67    | 67    | 67    | 67    | 67    | 67    | 67    |
| 2009                 | 128   | 128   | 128   | 128   | 128   | 128   | 128   | 128   | 128   |
| 2010                 | 210   | 210   | 210   | 210   | 210   | 210   | 210   | 210   | 210   |
| 2011                 | 313   | 313   | 313   | 313   | 313   | 313   | 313   | 313   | 313   |
| 2012                 | 418   | 418   | 418   | 418   | 418   | 418   | 418   | 418   | 418   |
| 2013                 | 547   | 547   | 547   | 547   | 547   | 547   | 547   | 547   | 547   |
| 2014                 | 665   | 665   | 665   | 665   | 665   | 665   | 665   | 665   | 665   |
| 2015                 | 814   | 814   | 814   | 814   | 814   | 814   | 814   | 814   | 814   |
| 2016                 | 957   | 957   | 957   | 957   | 957   | 957   | 957   | 957   | 957   |
| 2017                 | 1109  | 1109  | 1109  | 1109  | 1109  | 1109  | 1109  | 1109  | 1109  |
| 2018                 | 1276  | 1276  | 1276  | 1276  | 1276  | 1276  | 1276  | 1276  | 1276  |
| 2019                 | 1449  | 1449  | 1449  | 1449  | 1449  | 1449  | 1449  | 1449  | 1449  |
| 2020                 | 1622  | 1622  | 1622  | 1861  | 1622  | 1622  | 1622  | 1622  | 1622  |
| 2021                 | 1808  | 1808  | 1808  | 2282  | 1808  | 1808  | 1808  | 1808  | 1808  |
| 2022                 | 1974  | 1974  | 1974  | 2684  | 1974  | 1974  | 1974  | 1974  | 1974  |
| 2023                 | 2164  | 2164  | 2164  | 3102  | 2164  | 2164  | 2164  | 2164  | 2164  |
| 2024                 | 2363  | 2363  | 2363  | 3504  | 2363  | 2363  | 2363  | 2363  | 2363  |
| 2025                 | 2796  | 2796  | 2555  | 3899  | 2796  | 2796  | 2796  | 2796  | 2796  |
| 2026                 | 3196  | 3196  | 2738  | 4268  | 3196  | 3192  | 3196  | 3196  | 3196  |
| 2027                 | 3613  | 3613  | 2931  | 4645  | 3613  | 3598  | 3613  | 3613  | 3613  |
| 2028                 | 4012  | 4015  | 3125  | 5022  | 4021  | 3986  | 4015  | 4015  | 4015  |
| 2029                 | 4413  | 4411  | 3297  | 5393  | 4415  | 4369  | 4413  | 4413  | 4413  |
| 2030                 | 4823  | 4807  | 3750  | 5788  | 4822  | 4762  | 4812  | 4812  | 4812  |
| 2031                 | 5191  | 5151  | 4174  | 6153  | 5187  | 5128  | 5167  | 5167  | 5167  |
| 2032                 | 5540  | 5471  | 4574  | 6474  | 5510  | 5465  | 5498  | 5498  | 5498  |
| 2033                 | 5903  | 5805  | 4985  | 6812  | 5849  | 5814  | 5859  | 5859  | 5859  |
| 2034                 | 6266  | 6157  | 5405  | 7140  | 6199  | 6180  | 6221  | 6221  | 6221  |
| 2035                 | 6659  | 6550  | 5828  | 7509  | 6591  | 6582  | 6622  | 6622  | 6622  |
| 2036                 | 6979  | 6871  | 6142  | 7800  | 6911  | 6907  | 6947  | 6947  | 6947  |
| 2037                 | 7320  | 7204  | 6475  | 8092  | 7221  | 7251  | 7277  | 7277  | 7277  |
| 2038                 | 7616  | 7509  | 6780  | 8354  | 7498  | 7564  | 7572  | 7572  | 7572  |
| 2039                 | 7941  | 7823  | 7095  | 8650  | 7804  | 7880  | 7882  | 7882  | 7882  |
| 2040                 | 8250  | 8120  | 7411  | 8942  | 8116  | 8188  | 8195  | 8195  | 8195  |
| 2041                 | 8556  | 8412  | 7700  | 9227  | 8428  | 8487  | 8499  | 8499  | 8499  |
| 2042                 | 8863  | 8697  | 7995  | 9492  | 8723  | 8764  | 8799  | 8799  | 8799  |
| 2043                 | 9188  | 9012  | 8290  | 9745  | 9022  | 9058  | 9117  | 9117  | 9117  |
| 2044                 | 9497  | 9334  | 8586  | 10008 | 9324  | 9342  | 9436  | 9436  | 9436  |
| 2045                 | 9772  | 9631  | 8901  | 10262 | 9627  | 9617  | 9721  | 9721  | 9721  |
| 2046                 | 10042 | 9915  | 9196  | 10517 | 9917  | 9886  | 9992  | 9992  | 9992  |
| 2047                 | 10298 | 10175 | 9485  | 10770 | 10178 | 10136 | 10243 | 10243 | 10243 |
| 2048                 | 10548 | 10394 | 9758  | 11047 | 10407 | 10388 | 10469 | 10469 | 10469 |
| 2049                 | 10795 | 10633 | 10006 | 11319 | 10638 | 10641 | 10706 | 10706 | 10706 |
| 2050                 | 11057 | 10880 | 10262 | 11573 | 10887 | 10886 | 10949 | 10949 | 10949 |
| 2051                 | 11325 | 11156 | 10527 | 11845 | 11168 | 11160 | 11202 | 11202 | 11202 |

| ScenarioID /<br>Year | 46    | 47    | 48    | 49    | 50    | 51    | 52    | 53    | 54    |
|----------------------|-------|-------|-------|-------|-------|-------|-------|-------|-------|
| 2052                 | 11604 | 11435 | 10791 | 12130 | 11452 | 11452 | 11476 | 11476 | 11476 |
| 2053                 | 11888 | 11704 | 11058 | 12418 | 11729 | 11752 | 11745 | 11745 | 11745 |
| 2054                 | 12177 | 11976 | 11309 | 12706 | 12005 | 12043 | 12017 | 12017 | 12017 |
| 2055                 | 12466 | 12255 | 11564 | 12992 | 12273 | 12331 | 12302 | 12302 | 12302 |
| 2056                 | 12749 | 12530 | 11842 | 13280 | 12538 | 12618 | 12593 | 12593 | 12593 |
| 2057                 | 13041 | 12810 | 12115 | 13454 | 12811 | 12895 | 12876 | 12876 | 12876 |
| 2058                 | 13316 | 13086 | 12387 | 13606 | 13093 | 13098 | 13162 | 13162 | 13162 |
| 2059                 | 13526 | 13351 | 12656 | 13729 | 13353 | 13287 | 13421 | 13421 | 13421 |
| 2060                 | 13673 | 13543 | 12934 | 13810 | 13573 | 13448 | 13595 | 13595 | 13595 |
| 2061                 | 13790 | 13693 | 13208 | 13908 | 13729 | 13588 | 13737 | 13737 | 13737 |
| 2062                 | 13869 | 13786 | 13472 | 13972 | 13822 | 13705 | 13838 | 13838 | 13838 |
| 2063                 | 13940 | 13868 | 13675 | 14011 | 13907 | 13819 | 13921 | 13921 | 13921 |
| 2064                 | 14008 | 13948 | 13792 | 14049 | 13963 | 13883 | 13994 | 13994 | 13994 |
| 2065                 | 14055 | 14016 | 13875 | 14070 | 14018 | 13938 | 14054 | 14054 | 14054 |
| 2066                 | 14089 | 14072 | 13949 | 14098 | 14068 | 13964 | 14092 | 14092 | 14092 |
| 2067                 | 14105 | 14100 | 14005 | 14113 | 14101 | 13977 | 14115 | 14115 | 14115 |
| 2068                 | 14110 | 14116 | 14056 | 14116 | 14114 | 13984 | 14131 | 14131 | 14131 |
| 2069                 | 14115 | 14119 | 14094 | 14120 | 14124 | 13992 | 14136 | 14136 | 14136 |
| 2070                 | 14116 | 14120 | 14115 | 14121 | 14126 | 14003 | 14136 | 14136 | 14136 |
| 2071                 | 14122 | 14121 | 14131 | 14125 | 14129 | 14023 | 14136 | 14136 | 14136 |
| 2072                 | 14123 | 14122 | 14136 | 14126 | 14133 | 14055 | 14136 | 14136 | 14136 |
| 2073                 | 14127 | 14125 | 14136 | 14130 | 14136 | 14077 | 14136 | 14136 | 14136 |
| 2074                 | 14128 | 14126 | 14136 | 14131 | 14136 | 14098 | 14136 | 14136 | 14136 |
| 2075                 | 14132 | 14129 | 14136 | 14136 | 14136 | 14110 | 14136 | 14136 | 14136 |
| 2076                 | 14133 | 14131 | 14136 | 14136 | 14136 | 14115 | 14136 | 14136 | 14136 |
| 2077                 | 14134 | 14132 | 14136 | 14136 | 14136 | 14116 | 14136 | 14136 | 14136 |
| 2078                 | 14136 | 14136 | 14136 | 14136 | 14136 | 14120 | 14136 | 14136 | 14136 |
| 2079                 | 14136 | 14136 | 14136 | 14136 | 14136 | 14121 | 14136 | 14136 | 14136 |
| 2080                 | 14136 | 14136 | 14136 | 14136 | 14136 | 14125 | 14136 | 14136 | 14136 |
| 2081                 | 14136 | 14136 | 14136 | 14136 | 14136 | 14126 | 14136 | 14136 | 14136 |
| 2082                 | 14136 | 14136 | 14136 | 14136 | 14136 | 14127 | 14136 | 14136 | 14136 |
| 2083                 | 14136 | 14136 | 14136 | 14136 | 14136 | 14130 | 14136 | 14136 | 14136 |
| 2084                 | 14136 | 14136 | 14136 | 14136 | 14136 | 14131 | 14136 | 14136 | 14136 |
| 2085                 | 14136 | 14136 | 14136 | 14136 | 14136 | 14136 | 14136 | 14136 | 14136 |
| 2086                 | 14136 | 14136 | 14136 | 14136 | 14136 | 14136 | 14136 | 14136 | 14136 |
| 2087                 | 14136 | 14136 | 14136 | 14136 | 14136 | 14136 | 14136 | 14136 | 14136 |
| 2088                 | 14136 | 14136 | 14136 | 14136 | 14136 | 14136 | 14136 | 14136 | 14136 |
| 2089                 | 14136 | 14136 | 14136 | 14136 | 14136 | 14136 | 14136 | 14136 | 14136 |
| 2090                 | 14136 | 14136 | 14136 | 14136 | 14136 | 14136 | 14136 | 14136 | 14136 |

| ScenarioID /<br>Year | 55   | 56   | 57   | 58   | 59   | 60   | 61   | 62   | 63   |
|----------------------|------|------|------|------|------|------|------|------|------|
| 2002                 | 0    | 0    | 0    | 0    | 0    | 0    | 0    | 0    | 0    |
| 2003                 | 0    | 0    | 0    | 0    | 0    | 0    | 0    | 0    | 0    |
| 2004                 | 1    | 1    | 1    | 1    | 1    | 1    | 1    | 1    | 1    |
| 2005                 | 3    | 3    | 3    | 3    | 3    | 3    | 3    | 3    | 3    |
| 2006                 | 14   | 14   | 14   | 14   | 14   | 14   | 14   | 14   | 14   |
| 2007                 | 33   | 33   | 33   | 33   | 33   | 33   | 33   | 33   | 33   |
| 2008                 | 67   | 67   | 67   | 67   | 67   | 67   | 67   | 67   | 67   |
| 2009                 | 128  | 128  | 128  | 128  | 128  | 128  | 128  | 128  | 128  |
| 2010                 | 210  | 210  | 210  | 210  | 210  | 210  | 210  | 210  | 210  |
| 2011                 | 313  | 313  | 313  | 313  | 313  | 313  | 313  | 313  | 313  |
| 2012                 | 418  | 418  | 418  | 418  | 418  | 418  | 418  | 418  | 418  |
| 2013                 | 547  | 547  | 547  | 547  | 547  | 547  | 547  | 547  | 547  |
| 2014                 | 665  | 665  | 665  | 665  | 665  | 665  | 665  | 665  | 665  |
| 2015                 | 814  | 814  | 814  | 814  | 814  | 814  | 814  | 814  | 814  |
| 2016                 | 957  | 957  | 957  | 957  | 957  | 957  | 957  | 957  | 957  |
| 2017                 | 1109 | 1109 | 1109 | 1109 | 1109 | 1109 | 1109 | 1109 | 1109 |
| 2018                 | 1276 | 1276 | 1276 | 1276 | 1276 | 1276 | 1276 | 1276 | 1276 |
| 2019                 | 1449 | 1449 | 1449 | 1449 | 1449 | 1449 | 1449 | 1449 | 1449 |
| 2020                 | 1622 | 1622 | 1622 | 1789 | 1622 | 1622 | 1622 | 1622 | 1622 |
| 2021                 | 1808 | 1808 | 1808 | 2102 | 1808 | 1808 | 1808 | 1808 | 1808 |
| 2022                 | 1974 | 1974 | 1974 | 2406 | 1974 | 1974 | 1974 | 1974 | 1974 |
| 2023                 | 2164 | 2164 | 2164 | 2707 | 2164 | 2164 | 2164 | 2164 | 2164 |
| 2024                 | 2363 | 2363 | 2363 | 3007 | 2363 | 2363 | 2363 | 2363 | 2363 |
| 2025                 | 2719 | 2719 | 2555 | 3307 | 2719 | 2719 | 2719 | 2719 | 2719 |
| 2026                 | 3035 | 3035 | 2738 | 3609 | 3035 | 3035 | 3035 | 3035 | 3035 |
| 2027                 | 3340 | 3340 | 2931 | 3909 | 3340 | 3334 | 3340 | 3340 | 3340 |
| 2028                 | 3641 | 3641 | 3125 | 4210 | 3641 | 3635 | 3641 | 3641 | 3641 |
| 2029                 | 3941 | 3941 | 3297 | 4510 | 3941 | 3930 | 3941 | 3941 | 3941 |
| 2030                 | 4239 | 4239 | 3662 | 4810 | 4243 | 4223 | 4239 | 4239 | 4239 |
| 2031                 | 4536 | 4535 | 3991 | 5109 | 4543 | 4504 | 4535 | 4535 | 4535 |
| 2032                 | 4833 | 4827 | 4293 | 5408 | 4843 | 4789 | 4827 | 4827 | 4827 |
| 2033                 | 5135 | 5123 | 4600 | 5710 | 5138 | 5084 | 5129 | 5129 | 5129 |
| 2034                 | 5434 | 5422 | 4903 | 6010 | 5437 | 5372 | 5428 | 5428 | 5428 |
| 2035                 | 5731 | 5719 | 5203 | 6300 | 5729 | 5661 | 5725 | 5725 | 5725 |
| 2036                 | 6023 | 6004 | 5503 | 6582 | 6028 | 5940 | 6010 | 6010 | 6010 |
| 2037                 | 6323 | 6299 | 5802 | 6863 | 6328 | 6209 | 6305 | 6305 | 6305 |
| 2038                 | 6622 | 6589 | 6104 | 7153 | 6627 | 6489 | 6595 | 6595 | 6595 |
| 2039                 | 6919 | 6878 | 6405 | 7446 | 6927 | 6785 | 6895 | 6895 | 6895 |
| 2040                 | 7219 | 7172 | 6705 | 7503 | 7221 | 7079 | 7186 | 7186 | 7186 |
| 2041                 | 7506 | 7444 | 7002 | 7503 | 7503 | 7368 | 7464 | 7464 | 7464 |
| 2042                 | 7506 | 7510 | 7290 | 7505 | 7503 | 7501 | 7515 | 7515 | 7515 |
| 2043                 | 7517 | 7526 | 7517 | 7534 | 7522 | 7517 | 7531 | 7531 | 7531 |
| 2044                 | 7544 | 7551 | 7535 | 7576 | 7554 | 7541 | 7558 | 7558 | 7558 |
| 2045                 | 7573 | 7581 | 7562 | 7615 | 7585 | 7577 | 7588 | 7588 | 7588 |
| 2046                 | 7608 | 7613 | 7588 | 7664 | 7622 | 7619 | 7620 | 7620 | 7620 |
| 2047                 | 7671 | 7671 | 7633 | 7745 | 7691 | 7680 | 7681 | 7681 | 7681 |
| 2048                 | 7711 | 7714 | 7653 | 7800 | 7732 | 7728 | 7723 | 7723 | 7723 |
| 2049                 | 7717 | 7720 | 7659 | 7806 | 7738 | 7735 | 7729 | 7729 | 7729 |
| 2050                 | 7738 | 7741 | 7680 | 7827 | 7759 | 7757 | 7750 | 7750 | 7750 |
| 2051                 | 7755 | 7758 | 7697 | 7844 | 7776 | 7775 | 7767 | 7767 | 7767 |



| ScenarioID /<br>Year | 55   | 56   | 57   | 58   | 59   | 60   | 61   | 62   | 63   |
|----------------------|------|------|------|------|------|------|------|------|------|
| 2052                 | 7758 | 7761 | 7700 | 7847 | 7779 | 7778 | 7770 | 7770 | 7770 |
| 2053                 | 7758 | 7761 | 7700 | 7847 | 7779 | 7778 | 7770 | 7770 | 7770 |
| 2054                 | 7768 | 7771 | 7710 | 7857 | 7789 | 7788 | 7780 | 7780 | 7780 |
| 2055                 | 7770 | 7771 | 7710 | 7857 | 7791 | 7788 | 7780 | 7780 | 7780 |
| 2056                 | 7780 | 7779 | 7717 | 7863 | 7801 | 7794 | 7789 | 7789 | 7789 |
| 2057                 | 7780 | 7780 | 7718 | 7864 | 7801 | 7794 | 7790 | 7790 | 7790 |
| 2058                 | 7780 | 7780 | 7718 | 7864 | 7801 | 7794 | 7790 | 7790 | 7790 |
| 2059                 | 7780 | 7780 | 7718 | 7864 | 7801 | 7794 | 7790 | 7790 | 7790 |
| 2060                 | 7780 | 7780 | 7718 | 7864 | 7801 | 7794 | 7790 | 7790 | 7790 |
| 2061                 | 7780 | 7780 | 7718 | 7864 | 7801 | 7794 | 7790 | 7790 | 7790 |
| 2062                 | 7780 | 7780 | 7718 | 7864 | 7801 | 7794 | 7790 | 7790 | 7790 |
| 2063                 | 7780 | 7780 | 7718 | 7864 | 7801 | 7794 | 7790 | 7790 | 7790 |
| 2064                 | 7780 | 7780 | 7718 | 7864 | 7801 | 7794 | 7790 | 7790 | 7790 |
| 2065                 | 7780 | 7780 | 7718 | 7864 | 7801 | 7794 | 7790 | 7790 | 7790 |
| 2066                 | 7780 | 7780 | 7718 | 7864 | 7801 | 7794 | 7790 | 7790 | 7790 |
| 2067                 | 7780 | 7780 | 7718 | 7864 | 7801 | 7794 | 7790 | 7790 | 7790 |
| 2068                 | 7780 | 7780 | 7718 | 7864 | 7801 | 7794 | 7790 | 7790 | 7790 |
| 2069                 | 7780 | 7780 | 7718 | 7864 | 7801 | 7794 | 7790 | 7790 | 7790 |
| 2070                 | 7780 | 7780 | 7718 | 7864 | 7801 | 7794 | 7790 | 7790 | 7790 |
| 2071                 | 7780 | 7780 | 7718 | 7864 | 7801 | 7794 | 7790 | 7790 | 7790 |
| 2072                 | 7780 | 7780 | 7718 | 7864 | 7801 | 7794 | 7790 | 7790 | 7790 |
| 2073                 | 7780 | 7780 | 7718 | 7864 | 7801 | 7794 | 7790 | 7790 | 7790 |
| 2074                 | 7780 | 7780 | 7718 | 7864 | 7801 | 7794 | 7790 | 7790 | 7790 |
| 2075                 | 7780 | 7780 | 7718 | 7864 | 7801 | 7794 | 7790 | 7790 | 7790 |
| 2076                 | 7780 | 7780 | 7718 | 7864 | 7801 | 7794 | 7790 | 7790 | 7790 |
| 2077                 | 7780 | 7780 | 7718 | 7864 | 7801 | 7794 | 7790 | 7790 | 7790 |
| 2078                 | 7780 | 7780 | 7718 | 7864 | 7801 | 7794 | 7790 | 7790 | 7790 |
| 2079                 | 7780 | 7780 | 7718 | 7864 | 7801 | 7794 | 7790 | 7790 | 7790 |
| 2080                 | 7780 | 7780 | 7718 | 7864 | 7801 | 7794 | 7790 | 7790 | 7790 |
| 2081                 | 7780 | 7780 | 7718 | 7864 | 7801 | 7794 | 7790 | 7790 | 7790 |
| 2082                 | 7780 | 7780 | 7718 | 7864 | 7801 | 7794 | 7790 | 7790 | 7790 |
| 2083                 | 7780 | 7780 | 7718 | 7864 | 7801 | 7794 | 7790 | 7790 | 7790 |
| 2084                 | 7780 | 7780 | 7718 | 7864 | 7801 | 7794 | 7790 | 7790 | 7790 |
| 2085                 | 7780 | 7780 | 7718 | 7864 | 7801 | 7794 | 7790 | 7790 | 7790 |
| 2086                 | 7780 | 7780 | 7718 | 7864 | 7801 | 7794 | 7790 | 7790 | 7790 |
| 2087                 | 7780 | 7780 | 7718 | 7864 | 7801 | 7794 | 7790 | 7790 | 7790 |
| 2088                 | 7780 | 7780 | 7718 | 7864 | 7801 | 7794 | 7790 | 7790 | 7790 |
| 2089                 | 7780 | 7780 | 7718 | 7864 | 7801 | 7794 | 7790 | 7790 | 7790 |
| 2090                 | 7780 | 7780 | 7718 | 7864 | 7801 | 7794 | 7790 | 7790 | 7790 |

| ScenarioID / Year | 64   | 65   | 66   | 67   | 68   | 69   | 70   | 71   | 72   |
|-------------------|------|------|------|------|------|------|------|------|------|
| 2002              | 0    | 0    | 0    | 0    | 0    | 0    | 0    | 0    | 0    |
| 2003              | 0    | 0    | 0    | 0    | 0    | 0    | 0    | 0    | 0    |
| 2004              | 1    | 1    | 1    | 1    | 1    | 1    | 1    | 1    | 1    |
| 2005              | 3    | 3    | 3    | 3    | 3    | 3    | 3    | 3    | 3    |
| 2006              | 14   | 14   | 14   | 14   | 14   | 14   | 14   | 14   | 14   |
| 2007              | 33   | 33   | 33   | 33   | 33   | 33   | 33   | 33   | 33   |
| 2008              | 67   | 67   | 67   | 67   | 67   | 67   | 67   | 67   | 67   |
| 2009              | 128  | 128  | 128  | 128  | 128  | 128  | 128  | 128  | 128  |
| 2010              | 210  | 210  | 210  | 210  | 210  | 210  | 210  | 210  | 210  |
| 2011              | 313  | 313  | 313  | 313  | 313  | 313  | 313  | 313  | 313  |
| 2012              | 418  | 418  | 418  | 418  | 418  | 418  | 418  | 418  | 418  |
| 2013              | 547  | 547  | 547  | 547  | 547  | 547  | 547  | 547  | 547  |
| 2014              | 665  | 665  | 665  | 665  | 665  | 665  | 665  | 665  | 665  |
| 2015              | 814  | 814  | 814  | 814  | 814  | 814  | 814  | 814  | 814  |
| 2016              | 957  | 957  | 957  | 957  | 957  | 957  | 957  | 957  | 957  |
| 2017              | 1109 | 1109 | 1109 | 1109 | 1109 | 1109 | 1109 | 1109 | 1109 |
| 2018              | 1276 | 1276 | 1276 | 1276 | 1276 | 1276 | 1276 | 1276 | 1276 |
| 2019              | 1449 | 1449 | 1449 | 1449 | 1449 | 1449 | 1449 | 1449 | 1449 |
| 2020              | 1622 | 1622 | 1622 | 1789 | 1622 | 1622 | 1622 | 1622 | 1622 |
| 2021              | 1808 | 1808 | 1808 | 2102 | 1808 | 1808 | 1808 | 1808 | 1808 |
| 2022              | 1974 | 1974 | 1974 | 2406 | 1974 | 1974 | 1974 | 1974 | 1974 |
| 2023              | 2164 | 2164 | 2164 | 2707 | 2164 | 2164 | 2164 | 2164 | 2164 |
| 2024              | 2363 | 2363 | 2363 | 3003 | 2363 | 2363 | 2363 | 2363 | 2363 |
| 2025              | 2719 | 2719 | 2555 | 3303 | 2719 | 2719 | 2719 | 2719 | 2719 |
| 2026              | 3035 | 3035 | 2738 | 3604 | 3035 | 3035 | 3035 | 3035 | 3035 |
| 2027              | 3340 | 3340 | 2931 | 3904 | 3340 | 3336 | 3340 | 3340 | 3340 |
| 2028              | 3641 | 3641 | 3125 | 4205 | 3641 | 3637 | 3641 | 3641 | 3641 |
| 2029              | 3941 | 3941 | 3297 | 4505 | 3941 | 3934 | 3941 | 3941 | 3941 |
| 2030              | 4243 | 4243 | 3662 | 4805 | 4243 | 4228 | 4243 | 4243 | 4243 |
| 2031              | 4540 | 4539 | 3991 | 5104 | 4543 | 4520 | 4539 | 4539 | 4539 |
| 2032              | 4837 | 4831 | 4293 | 5405 | 4843 | 4812 | 4831 | 4831 | 4831 |
| 2033              | 5139 | 5127 | 4600 | 5707 | 5138 | 5107 | 5133 | 5133 | 5133 |
| 2034              | 5435 | 5423 | 4903 | 6007 | 5440 | 5407 | 5429 | 5429 | 5429 |
| 2035              | 5725 | 5712 | 5205 | 6300 | 5738 | 5699 | 5718 | 5718 | 5718 |
| 2036              | 6012 | 6000 | 5505 | 6585 | 6039 | 5975 | 6006 | 6006 | 6006 |
| 2037              | 6305 | 6293 | 5804 | 6868 | 6339 | 6263 | 6299 | 6299 | 6299 |
| 2038              | 6587 | 6578 | 6097 | 7145 | 6638 | 6527 | 6583 | 6583 | 6583 |
| 2039              | 6880 | 6871 | 6393 | 7419 | 6938 | 6795 | 6876 | 6876 | 6876 |
| 2040              | 7167 | 7145 | 6692 | 7525 | 7235 | 7072 | 7163 | 7163 | 7163 |
| 2041              | 7453 | 7408 | 6988 | 7525 | 7500 | 7352 | 7453 | 7453 | 7453 |
| 2042              | 7511 | 7504 | 7280 | 7526 | 7500 | 7515 | 7509 | 7509 | 7509 |
| 2043              | 7527 | 7520 | 7515 | 7555 | 7520 | 7530 | 7525 | 7525 | 7525 |
| 2044              | 7556 | 7545 | 7533 | 7597 | 7552 | 7553 | 7552 | 7552 | 7552 |
| 2045              | 7597 | 7574 | 7560 | 7643 | 7583 | 7589 | 7582 | 7582 | 7582 |
| 2046              | 7628 | 7603 | 7588 | 7695 | 7621 | 7627 | 7613 | 7613 | 7613 |
| 2047              | 7690 | 7659 | 7634 | 7771 | 7697 | 7684 | 7675 | 7675 | 7675 |
| 2048              | 7733 | 7699 | 7657 | 7825 | 7739 | 7727 | 7718 | 7718 | 7718 |
| 2049              | 7739 | 7706 | 7663 | 7831 | 7745 | 7734 | 7724 | 7724 | 7724 |
| 2050              | 7760 | 7727 | 7684 | 7852 | 7766 | 7756 | 7745 | 7745 | 7745 |
| 2051              | 7777 | 7744 | 7701 | 7869 | 7783 | 7774 | 7762 | 7762 | 7762 |

| ScenarioID /<br>Year | 64   | 65   | 66   | 67   | 68   | 69   | 70   | 71   | 72   |
|----------------------|------|------|------|------|------|------|------|------|------|
| 2052                 | 7780 | 7747 | 7704 | 7872 | 7786 | 7777 | 7765 | 7765 | 7765 |
| 2053                 | 7780 | 7747 | 7704 | 7872 | 7786 | 7777 | 7765 | 7765 | 7765 |
| 2054                 | 7790 | 7757 | 7714 | 7882 | 7796 | 7787 | 7775 | 7775 | 7775 |
| 2055                 | 7790 | 7757 | 7714 | 7882 | 7798 | 7787 | 7775 | 7775 | 7775 |
| 2056                 | 7799 | 7764 | 7721 | 7889 | 7808 | 7791 | 7784 | 7784 | 7784 |
| 2057                 | 7800 | 7765 | 7722 | 7890 | 7808 | 7792 | 7785 | 7785 | 7785 |
| 2058                 | 7800 | 7765 | 7722 | 7890 | 7808 | 7792 | 7785 | 7785 | 7785 |
| 2059                 | 7800 | 7765 | 7722 | 7890 | 7808 | 7792 | 7785 | 7785 | 7785 |
| 2060                 | 7800 | 7765 | 7722 | 7890 | 7808 | 7792 | 7785 | 7785 | 7785 |
| 2061                 | 7800 | 7765 | 7722 | 7890 | 7808 | 7792 | 7785 | 7785 | 7785 |
| 2062                 | 7800 | 7765 | 7722 | 7890 | 7808 | 7792 | 7785 | 7785 | 7785 |
| 2063                 | 7800 | 7765 | 7722 | 7890 | 7808 | 7792 | 7785 | 7785 | 7785 |
| 2064                 | 7800 | 7765 | 7722 | 7890 | 7808 | 7792 | 7785 | 7785 | 7785 |
| 2065                 | 7800 | 7765 | 7722 | 7890 | 7808 | 7792 | 7785 | 7785 | 7785 |
| 2066                 | 7800 | 7765 | 7722 | 7890 | 7808 | 7792 | 7785 | 7785 | 7785 |
| 2067                 | 7800 | 7765 | 7722 | 7890 | 7808 | 7792 | 7785 | 7785 | 7785 |
| 2068                 | 7800 | 7765 | 7722 | 7890 | 7808 | 7792 | 7785 | 7785 | 7785 |
| 2069                 | 7800 | 7765 | 7722 | 7890 | 7808 | 7792 | 7785 | 7785 | 7785 |
| 2070                 | 7800 | 7765 | 7722 | 7890 | 7808 | 7792 | 7785 | 7785 | 7785 |
| 2071                 | 7800 | 7765 | 7722 | 7890 | 7808 | 7792 | 7785 | 7785 | 7785 |
| 2072                 | 7800 | 7765 | 7722 | 7890 | 7808 | 7792 | 7785 | 7785 | 7785 |
| 2073                 | 7800 | 7765 | 7722 | 7890 | 7808 | 7792 | 7785 | 7785 | 7785 |
| 2074                 | 7800 | 7765 | 7722 | 7890 | 7808 | 7792 | 7785 | 7785 | 7785 |
| 2075                 | 7800 | 7765 | 7722 | 7890 | 7808 | 7792 | 7785 | 7785 | 7785 |
| 2076                 | 7800 | 7765 | 7722 | 7890 | 7808 | 7792 | 7785 | 7785 | 7785 |
| 2077                 | 7800 | 7765 | 7722 | 7890 | 7808 | 7792 | 7785 | 7785 | 7785 |
| 2078                 | 7800 | 7765 | 7722 | 7890 | 7808 | 7792 | 7785 | 7785 | 7785 |
| 2079                 | 7800 | 7765 | 7722 | 7890 | 7808 | 7792 | 7785 | 7785 | 7785 |
| 2080                 | 7800 | 7765 | 7722 | 7890 | 7808 | 7792 | 7785 | 7785 | 7785 |
| 2081                 | 7800 | 7765 | 7722 | 7890 | 7808 | 7792 | 7785 | 7785 | 7785 |
| 2082                 | 7800 | 7765 | 7722 | 7890 | 7808 | 7792 | 7785 | 7785 | 7785 |
| 2083                 | 7800 | 7765 | 7722 | 7890 | 7808 | 7792 | 7785 | 7785 | 7785 |
| 2084                 | 7800 | 7765 | 7722 | 7890 | 7808 | 7792 | 7785 | 7785 | 7785 |
| 2085                 | 7800 | 7765 | 7722 | 7890 | 7808 | 7792 | 7785 | 7785 | 7785 |
| 2086                 | 7800 | 7765 | 7722 | 7890 | 7808 | 7792 | 7785 | 7785 | 7785 |
| 2087                 | 7800 | 7765 | 7722 | 7890 | 7808 | 7792 | 7785 | 7785 | 7785 |
| 2088                 | 7800 | 7765 | 7722 | 7890 | 7808 | 7792 | 7785 | 7785 | 7785 |
| 2089                 | 7800 | 7765 | 7722 | 7890 | 7808 | 7792 | 7785 | 7785 | 7785 |
| 2090                 | 7800 | 7765 | 7722 | 7890 | 7808 | 7792 | 7785 | 7785 | 7785 |

| ScenarioID / Year | 73   | 74   | 75   | 76   | 77   | 78   | 79   | 80   | 81   |
|-------------------|------|------|------|------|------|------|------|------|------|
| 2002              | 0    | 0    | 0    | 0    | 0    | 0    | 0    | 0    | 0    |
| 2003              | 0    | 0    | 0    | 0    | 0    | 0    | 0    | 0    | 0    |
| 2004              | 1    | 1    | 1    | 1    | 1    | 1    | 1    | 1    | 1    |
| 2005              | 3    | 3    | 3    | 3    | 3    | 3    | 3    | 3    | 3    |
| 2006              | 14   | 14   | 14   | 14   | 14   | 14   | 14   | 14   | 14   |
| 2007              | 33   | 33   | 33   | 33   | 33   | 33   | 33   | 33   | 33   |
| 2008              | 67   | 67   | 67   | 67   | 67   | 67   | 67   | 67   | 67   |
| 2009              | 128  | 128  | 128  | 128  | 128  | 128  | 128  | 128  | 128  |
| 2010              | 210  | 210  | 210  | 210  | 210  | 210  | 210  | 210  | 210  |
| 2011              | 313  | 313  | 313  | 313  | 313  | 313  | 313  | 313  | 313  |
| 2012              | 418  | 418  | 418  | 418  | 418  | 418  | 418  | 418  | 418  |
| 2013              | 547  | 547  | 547  | 547  | 547  | 547  | 547  | 547  | 547  |
| 2014              | 665  | 665  | 665  | 665  | 665  | 665  | 665  | 665  | 665  |
| 2015              | 814  | 814  | 814  | 814  | 814  | 814  | 814  | 814  | 814  |
| 2016              | 957  | 957  | 957  | 957  | 957  | 957  | 957  | 957  | 957  |
| 2017              | 1109 | 1109 | 1109 | 1109 | 1109 | 1109 | 1109 | 1109 | 1109 |
| 2018              | 1276 | 1276 | 1276 | 1276 | 1276 | 1276 | 1276 | 1276 | 1276 |
| 2019              | 1449 | 1449 | 1449 | 1449 | 1449 | 1449 | 1449 | 1449 | 1449 |
| 2020              | 1622 | 1622 | 1622 | 1789 | 1622 | 1622 | 1622 | 1622 | 1622 |
| 2021              | 1808 | 1808 | 1808 | 2102 | 1808 | 1808 | 1808 | 1808 | 1808 |
| 2022              | 1974 | 1974 | 1974 | 2406 | 1974 | 1974 | 1974 | 1974 | 1974 |
| 2023              | 2164 | 2164 | 2164 | 2707 | 2164 | 2164 | 2164 | 2164 | 2164 |
| 2024              | 2363 | 2363 | 2363 | 3007 | 2363 | 2363 | 2363 | 2363 | 2363 |
| 2025              | 2719 | 2719 | 2555 | 3307 | 2719 | 2719 | 2719 | 2719 | 2719 |
| 2026              | 3035 | 3035 | 2738 | 3609 | 3035 | 3035 | 3035 | 3035 | 3035 |
| 2027              | 3340 | 3340 | 2931 | 3909 | 3340 | 3340 | 3340 | 3340 | 3340 |
| 2028              | 3641 | 3641 | 3125 | 4210 | 3641 | 3641 | 3641 | 3641 | 3641 |
| 2029              | 3941 | 3941 | 3297 | 4510 | 3941 | 3941 | 3941 | 3941 | 3941 |
| 2030              | 4243 | 4243 | 3662 | 4810 | 4243 | 4241 | 4243 | 4243 | 4243 |
| 2031              | 4540 | 4539 | 3991 | 5110 | 4543 | 4536 | 4539 | 4539 | 4539 |
| 2032              | 4837 | 4831 | 4293 | 5407 | 4843 | 4819 | 4831 | 4831 | 4831 |
| 2033              | 5137 | 5127 | 4600 | 5709 | 5138 | 5106 | 5133 | 5133 | 5133 |
| 2034              | 5439 | 5429 | 4897 | 6009 | 5440 | 5402 | 5435 | 5435 | 5435 |
| 2035              | 5741 | 5731 | 5199 | 6307 | 5742 | 5697 | 5738 | 5738 | 5738 |
| 2036              | 6042 | 6032 | 5499 | 6608 | 6043 | 5985 | 6040 | 6040 | 6040 |
| 2037              | 6342 | 6328 | 5801 | 6905 | 6343 | 6275 | 6336 | 6336 | 6336 |
| 2038              | 6642 | 6628 | 6101 | 7205 | 6643 | 6557 | 6636 | 6636 | 6636 |
| 2039              | 6943 | 6928 | 6402 | 7505 | 6943 | 6851 | 6936 | 6936 | 6936 |
| 2040              | 7238 | 7229 | 6702 | 7505 | 7242 | 7143 | 7232 | 7232 | 7232 |
| 2041              | 7502 | 7502 | 7001 | 7505 | 7506 | 7436 | 7505 | 7505 | 7505 |
| 2042              | 7502 | 7502 | 7293 | 7505 | 7506 | 7506 | 7505 | 7505 | 7505 |
| 2043              | 7519 | 7522 | 7518 | 7534 | 7527 | 7522 | 7524 | 7524 | 7524 |
| 2044              | 7549 | 7555 | 7536 | 7572 | 7561 | 7547 | 7554 | 7554 | 7554 |
| 2045              | 7578 | 7586 | 7564 | 7614 | 7592 | 7584 | 7585 | 7585 | 7585 |
| 2046              | 7622 | 7625 | 7591 | 7685 | 7631 | 7625 | 7622 | 7622 | 7622 |
| 2047              | 7689 | 7695 | 7641 | 7767 | 7701 | 7683 | 7691 | 7691 | 7691 |
| 2048              | 7732 | 7737 | 7662 | 7825 | 7745 | 7735 | 7732 | 7732 | 7732 |
| 2049              | 7738 | 7743 | 7668 | 7832 | 7751 | 7741 | 7738 | 7738 | 7738 |
| 2050              | 7759 | 7764 | 7689 | 7853 | 7772 | 7763 | 7759 | 7759 | 7759 |
| 2051              | 7776 | 7781 | 7706 | 7870 | 7789 | 7781 | 7776 | 7776 | 7776 |

| ScenarioID /<br>Year | 73   | 74   | 75   | 76   | 77   | 78   | 79   | 80   | 81   |
|----------------------|------|------|------|------|------|------|------|------|------|
| 2052                 | 7779 | 7784 | 7709 | 7873 | 7792 | 7784 | 7779 | 7779 | 7779 |
| 2053                 | 7779 | 7784 | 7709 | 7873 | 7792 | 7784 | 7779 | 7779 | 7779 |
| 2054                 | 7789 | 7794 | 7719 | 7883 | 7802 | 7794 | 7789 | 7789 | 7789 |
| 2055                 | 7791 | 7796 | 7719 | 7885 | 7804 | 7794 | 7791 | 7791 | 7791 |
| 2056                 | 7801 | 7806 | 7726 | 7895 | 7814 | 7802 | 7801 | 7801 | 7801 |
| 2057                 | 7801 | 7806 | 7727 | 7895 | 7814 | 7803 | 7801 | 7801 | 7801 |
| 2058                 | 7801 | 7806 | 7727 | 7895 | 7814 | 7803 | 7801 | 7801 | 7801 |
| 2059                 | 7801 | 7806 | 7727 | 7895 | 7814 | 7803 | 7801 | 7801 | 7801 |
| 2060                 | 7801 | 7806 | 7727 | 7895 | 7814 | 7803 | 7801 | 7801 | 7801 |
| 2061                 | 7801 | 7806 | 7727 | 7895 | 7814 | 7803 | 7801 | 7801 | 7801 |
| 2062                 | 7801 | 7806 | 7727 | 7895 | 7814 | 7803 | 7801 | 7801 | 7801 |
| 2063                 | 7801 | 7806 | 7727 | 7895 | 7814 | 7803 | 7801 | 7801 | 7801 |
| 2064                 | 7801 | 7806 | 7727 | 7895 | 7814 | 7803 | 7801 | 7801 | 7801 |
| 2065                 | 7801 | 7806 | 7727 | 7895 | 7814 | 7803 | 7801 | 7801 | 7801 |
| 2066                 | 7801 | 7806 | 7727 | 7895 | 7814 | 7803 | 7801 | 7801 | 7801 |
| 2067                 | 7801 | 7806 | 7727 | 7895 | 7814 | 7803 | 7801 | 7801 | 7801 |
| 2068                 | 7801 | 7806 | 7727 | 7895 | 7814 | 7803 | 7801 | 7801 | 7801 |
| 2069                 | 7801 | 7806 | 7727 | 7895 | 7814 | 7803 | 7801 | 7801 | 7801 |
| 2070                 | 7801 | 7806 | 7727 | 7895 | 7814 | 7803 | 7801 | 7801 | 7801 |
| 2071                 | 7801 | 7806 | 7727 | 7895 | 7814 | 7803 | 7801 | 7801 | 7801 |
| 2072                 | 7801 | 7806 | 7727 | 7895 | 7814 | 7803 | 7801 | 7801 | 7801 |
| 2073                 | 7801 | 7806 | 7727 | 7895 | 7814 | 7803 | 7801 | 7801 | 7801 |
| 2074                 | 7801 | 7806 | 7727 | 7895 | 7814 | 7803 | 7801 | 7801 | 7801 |
| 2075                 | 7801 | 7806 | 7727 | 7895 | 7814 | 7803 | 7801 | 7801 | 7801 |
| 2076                 | 7801 | 7806 | 7727 | 7895 | 7814 | 7803 | 7801 | 7801 | 7801 |
| 2077                 | 7801 | 7806 | 7727 | 7895 | 7814 | 7803 | 7801 | 7801 | 7801 |
| 2078                 | 7801 | 7806 | 7727 | 7895 | 7814 | 7803 | 7801 | 7801 | 7801 |
| 2079                 | 7801 | 7806 | 7727 | 7895 | 7814 | 7803 | 7801 | 7801 | 7801 |
| 2080                 | 7801 | 7806 | 7727 | 7895 | 7814 | 7803 | 7801 | 7801 | 7801 |
| 2081                 | 7801 | 7806 | 7727 | 7895 | 7814 | 7803 | 7801 | 7801 | 7801 |
| 2082                 | 7801 | 7806 | 7727 | 7895 | 7814 | 7803 | 7801 | 7801 | 7801 |
| 2083                 | 7801 | 7806 | 7727 | 7895 | 7814 | 7803 | 7801 | 7801 | 7801 |
| 2084                 | 7801 | 7806 | 7727 | 7895 | 7814 | 7803 | 7801 | 7801 | 7801 |
| 2085                 | 7801 | 7806 | 7727 | 7895 | 7814 | 7803 | 7801 | 7801 | 7801 |
| 2086                 | 7801 | 7806 | 7727 | 7895 | 7814 | 7803 | 7801 | 7801 | 7801 |
| 2087                 | 7801 | 7806 | 7727 | 7895 | 7814 | 7803 | 7801 | 7801 | 7801 |
| 2088                 | 7801 | 7806 | 7727 | 7895 | 7814 | 7803 | 7801 | 7801 | 7801 |
| 2089                 | 7801 | 7806 | 7727 | 7895 | 7814 | 7803 | 7801 | 7801 | 7801 |
| 2090                 | 7801 | 7806 | 7727 | 7895 | 7814 | 7803 | 7801 | 7801 | 7801 |

| ScenarioID /<br>Year | 1      | 2      | 3      | 4      | 5      | 6      | 7      | 8      | 9      |
|----------------------|--------|--------|--------|--------|--------|--------|--------|--------|--------|
| 2002                 | 141104 | 141104 | 141104 | 141104 | 141104 | 141104 | 141104 | 141104 | 141104 |
| 2003                 | 149233 | 149233 | 149233 | 149233 | 149233 | 149233 | 149233 | 149233 | 149233 |
| 2004                 | 157146 | 157146 | 157146 | 157146 | 157146 | 157146 | 157146 | 157146 | 157146 |
| 2005                 | 164299 | 164299 | 164299 | 164299 | 164299 | 164299 | 164299 | 164299 | 164299 |
| 2006                 | 171496 | 171496 | 171496 | 171496 | 171496 | 171496 | 171496 | 171496 | 171496 |
| 2007                 | 178790 | 178790 | 178790 | 178790 | 178790 | 178790 | 178790 | 178790 | 178790 |
| 2008                 | 184759 | 184759 | 184759 | 184759 | 184759 | 184759 | 184759 | 184759 | 184759 |
| 2009                 | 190596 | 190596 | 190596 | 190596 | 190596 | 190596 | 190596 | 190596 | 190596 |
| 2010                 | 195244 | 195244 | 195244 | 195244 | 195244 | 195244 | 195244 | 195244 | 195244 |
| 2011                 | 199472 | 199472 | 199472 | 199472 | 199472 | 199472 | 199472 | 199472 | 199472 |
| 2012                 | 202694 | 202694 | 202694 | 202694 | 202694 | 202694 | 202694 | 202694 | 202694 |
| 2013                 | 206172 | 206172 | 206172 | 206172 | 206172 | 206172 | 206172 | 206172 | 206172 |
| 2014                 | 208841 | 208841 | 208841 | 208841 | 208841 | 208841 | 208841 | 208841 | 208841 |
| 2015                 | 211298 | 211298 | 211298 | 211298 | 211298 | 211298 | 211298 | 211298 | 211298 |
| 2016                 | 213570 | 213570 | 213570 | 213570 | 213570 | 213570 | 213570 | 213570 | 213570 |
| 2017                 | 215247 | 215247 | 215247 | 215247 | 215247 | 215247 | 215247 | 215247 | 215247 |
| 2018                 | 216679 | 216679 | 216679 | 216679 | 216679 | 216679 | 216679 | 216679 | 216679 |
| 2019                 | 217907 | 217907 | 217907 | 217907 | 217907 | 217907 | 217907 | 217907 | 217907 |
| 2020                 | 218888 | 218888 | 218888 | 210874 | 218888 | 218888 | 218888 | 218888 | 218888 |
| 2021                 | 219755 | 219755 | 219755 | 204177 | 219755 | 219755 | 219755 | 219755 | 219755 |
| 2022                 | 220922 | 220922 | 220922 | 198019 | 220922 | 220922 | 220922 | 220922 | 220922 |
| 2023                 | 221438 | 221438 | 221438 | 192555 | 221438 | 221438 | 221438 | 221438 | 221438 |
| 2024                 | 221835 | 221835 | 221835 | 187201 | 221835 | 221835 | 221835 | 221835 | 221835 |
| 2025                 | 214863 | 214863 | 222385 | 181751 | 214863 | 214863 | 214863 | 214863 | 214863 |
| 2026                 | 207420 | 207420 | 222873 | 176329 | 207420 | 207420 | 207420 | 207420 | 207420 |
| 2027                 | 200857 | 200857 | 223196 | 171273 | 200857 | 200857 | 200857 | 200857 | 200857 |
| 2028                 | 194119 | 194119 | 223606 | 166232 | 194119 | 194119 | 194119 | 194119 | 194119 |
| 2029                 | 188803 | 188803 | 224093 | 161119 | 188803 | 188803 | 188803 | 188803 | 188803 |
| 2030                 | 184576 | 184576 | 217917 | 157934 | 184356 | 184418 | 184576 | 184576 | 184576 |
| 2031                 | 179383 | 179383 | 210912 | 154089 | 179515 | 179705 | 179383 | 179383 | 179383 |
| 2032                 | 174329 | 174329 | 203665 | 149462 | 174450 | 174988 | 174329 | 174329 | 174329 |
| 2033                 | 171284 | 171284 | 198714 | 146892 | 171361 | 172251 | 171284 | 171284 | 171284 |
| 2034                 | 166889 | 166889 | 193245 | 143675 | 166947 | 168220 | 166889 | 166889 | 166889 |
| 2035                 | 164995 | 164995 | 189018 | 141989 | 164731 | 166355 | 164995 | 164995 | 164995 |
| 2036                 | 158072 | 158073 | 181678 | 134942 | 157815 | 159540 | 158073 | 158073 | 158073 |
| 2037                 | 152921 | 152960 | 175801 | 138801 | 152402 | 154343 | 152960 | 152960 | 152960 |
| 2038                 | 145943 | 145984 | 168628 | 141826 | 146097 | 147908 | 146091 | 146091 | 146091 |
| 2039                 | 147642 | 147600 | 161839 | 145159 | 147840 | 148051 | 147708 | 147708 | 147708 |
| 2040                 | 150400 | 150358 | 154487 | 147854 | 150598 | 150768 | 150466 | 150466 | 150466 |
| 2041                 | 152944 | 152775 | 155210 | 150314 | 153015 | 153374 | 152883 | 152883 | 152883 |
| 2042                 | 155237 | 155068 | 157734 | 152397 | 155349 | 155790 | 155176 | 155176 | 155176 |
| 2043                 | 158890 | 158721 | 161472 | 155854 | 158981 | 159413 | 158829 | 158829 | 158829 |
| 2044                 | 162297 | 162128 | 164964 | 159304 | 162410 | 162964 | 162236 | 162236 | 162236 |
| 2045                 | 163782 | 163613 | 166415 | 160760 | 163978 | 164449 | 163721 | 163721 | 163721 |
| 2046                 | 165418 | 165249 | 167874 | 162395 | 165636 | 165943 | 165357 | 165357 | 165357 |
| 2047                 | 167384 | 167215 | 169778 | 164757 | 167602 | 167953 | 167323 | 167323 | 167323 |
| 2048                 | 167373 | 167204 | 169661 | 165114 | 167591 | 167975 | 167312 | 167312 | 167312 |
| 2049                 | 167327 | 167158 | 169615 | 165068 | 167545 | 167929 | 167266 | 167266 | 167266 |
| 2050                 | 167559 | 167390 | 169847 | 165300 | 167777 | 168156 | 167498 | 167498 | 167498 |
| 2051                 | 167350 | 167181 | 169638 | 165092 | 167568 | 167926 | 167289 | 167289 | 167289 |

| ScenarioID /<br>Year | 1      | 2      | 3      | 4      | 5      | 6      | 7      | 8      | 9      |
|----------------------|--------|--------|--------|--------|--------|--------|--------|--------|--------|
| 2052                 | 167370 | 167201 | 169658 | 165112 | 167588 | 167946 | 167309 | 167309 | 167309 |
| 2053                 | 167370 | 167201 | 169658 | 165112 | 167588 | 167946 | 167309 | 167309 | 167309 |
| 2054                 | 167341 | 167172 | 169629 | 165083 | 167559 | 167917 | 167280 | 167280 | 167280 |
| 2055                 | 167350 | 167181 | 169638 | 165092 | 167568 | 167926 | 167289 | 167289 | 167289 |
| 2056                 | 167333 | 167164 | 169621 | 165075 | 167551 | 167909 | 167272 | 167272 | 167272 |
| 2057                 | 167333 | 167164 | 169621 | 165075 | 167551 | 167909 | 167272 | 167272 | 167272 |
| 2058                 | 167333 | 167164 | 169621 | 165075 | 167551 | 167909 | 167272 | 167272 | 167272 |
| 2059                 | 167333 | 167164 | 169621 | 165075 | 167551 | 167909 | 167272 | 167272 | 167272 |
| 2060                 | 167333 | 167164 | 169621 | 165075 | 167551 | 167909 | 167272 | 167272 | 167272 |
| 2061                 | 167333 | 167164 | 169621 | 165075 | 167551 | 167909 | 167272 | 167272 | 167272 |
| 2062                 | 167333 | 167164 | 169621 | 165075 | 167551 | 167909 | 167272 | 167272 | 167272 |
| 2063                 | 167333 | 167164 | 169621 | 165075 | 167551 | 167909 | 167272 | 167272 | 167272 |
| 2064                 | 167333 | 167164 | 169621 | 165075 | 167551 | 167909 | 167272 | 167272 | 167272 |
| 2065                 | 167333 | 167164 | 169621 | 165075 | 167551 | 167909 | 167272 | 167272 | 167272 |
| 2066                 | 167333 | 167164 | 169621 | 165075 | 167551 | 167909 | 167272 | 167272 | 167272 |
| 2067                 | 167333 | 167164 | 169621 | 165075 | 167551 | 167909 | 167272 | 167272 | 167272 |
| 2068                 | 167333 | 167164 | 169621 | 165075 | 167551 | 167909 | 167272 | 167272 | 167272 |
| 2069                 | 167333 | 167164 | 169621 | 165075 | 167551 | 167909 | 167272 | 167272 | 167272 |
| 2070                 | 167333 | 167164 | 169621 | 165075 | 167551 | 167909 | 167272 | 167272 | 167272 |
| 2071                 | 167333 | 167164 | 169621 | 165075 | 167551 | 167909 | 167272 | 167272 | 167272 |
| 2072                 | 167333 | 167164 | 169621 | 165075 | 167551 | 167909 | 167272 | 167272 | 167272 |
| 2073                 | 167333 | 167164 | 169621 | 165075 | 167551 | 167909 | 167272 | 167272 | 167272 |
| 2074                 | 167333 | 167164 | 169621 | 165075 | 167551 | 167909 | 167272 | 167272 | 167272 |
| 2075                 | 167333 | 167164 | 169621 | 165075 | 167551 | 167909 | 167272 | 167272 | 167272 |
| 2076                 | 167333 | 167164 | 169621 | 165075 | 167551 | 167909 | 167272 | 167272 | 167272 |
| 2077                 | 167333 | 167164 | 169621 | 165075 | 167551 | 167909 | 167272 | 167272 | 167272 |
| 2078                 | 167333 | 167164 | 169621 | 165075 | 167551 | 167909 | 167272 | 167272 | 167272 |
| 2079                 | 167333 | 167164 | 169621 | 165075 | 167551 | 167909 | 167272 | 167272 | 167272 |
| 2080                 | 167333 | 167164 | 169621 | 165075 | 167551 | 167909 | 167272 | 167272 | 167272 |
| 2081                 | 167333 | 167164 | 169621 | 165075 | 167551 | 167909 | 167272 | 167272 | 167272 |
| 2082                 | 167333 | 167164 | 169621 | 165075 | 167551 | 167909 | 167272 | 167272 | 167272 |
| 2083                 | 167333 | 167164 | 169621 | 165075 | 167551 | 167909 | 167272 | 167272 | 167272 |
| 2084                 | 167333 | 167164 | 169621 | 165075 | 167551 | 167909 | 167272 | 167272 | 167272 |
| 2085                 | 167333 | 167164 | 169621 | 165075 | 167551 | 167909 | 167272 | 167272 | 167272 |
| 2086                 | 167333 | 167164 | 169621 | 165075 | 167551 | 167909 | 167272 | 167272 | 167272 |
| 2087                 | 167333 | 167164 | 169621 | 165075 | 167551 | 167909 | 167272 | 167272 | 167272 |
| 2088                 | 167333 | 167164 | 169621 | 165075 | 167551 | 167909 | 167272 | 167272 | 167272 |
| 2089                 | 167333 | 167164 | 169621 | 165075 | 167551 | 167909 | 167272 | 167272 | 167272 |
| 2090                 | 167333 | 167164 | 169621 | 165075 | 167551 | 167909 | 167272 | 167272 | 167272 |

| ScenarioID /<br>Year | 10     | 11     | 12     | 13     | 14     | 15     | 16     | 17     | 18     |
|----------------------|--------|--------|--------|--------|--------|--------|--------|--------|--------|
| 2002                 | 141104 | 141104 | 141104 | 141104 | 141104 | 141104 | 141104 | 141104 | 141104 |
| 2003                 | 149233 | 149233 | 149233 | 149233 | 149233 | 149233 | 149233 | 149233 | 149233 |
| 2004                 | 157146 | 157146 | 157146 | 157146 | 157146 | 157146 | 157146 | 157146 | 157146 |
| 2005                 | 164299 | 164299 | 164299 | 164299 | 164299 | 164299 | 164299 | 164299 | 164299 |
| 2006                 | 171496 | 171496 | 171496 | 171496 | 171496 | 171496 | 171496 | 171496 | 171496 |
| 2007                 | 178790 | 178790 | 178790 | 178790 | 178790 | 178790 | 178790 | 178790 | 178790 |
| 2008                 | 184759 | 184759 | 184759 | 184759 | 184759 | 184759 | 184759 | 184759 | 184759 |
| 2009                 | 190596 | 190596 | 190596 | 190596 | 190596 | 190596 | 190596 | 190596 | 190596 |
| 2010                 | 195244 | 195244 | 195244 | 195244 | 195244 | 195244 | 195244 | 195244 | 195244 |
| 2011                 | 199472 | 199472 | 199472 | 199472 | 199472 | 199472 | 199472 | 199472 | 199472 |
| 2012                 | 202694 | 202694 | 202694 | 202694 | 202694 | 202694 | 202694 | 202694 | 202694 |
| 2013                 | 206172 | 206172 | 206172 | 206172 | 206172 | 206172 | 206172 | 206172 | 206172 |
| 2014                 | 208841 | 208841 | 208841 | 208841 | 208841 | 208841 | 208841 | 208841 | 208841 |
| 2015                 | 211298 | 211298 | 211298 | 211298 | 211298 | 211298 | 211298 | 211298 | 211298 |
| 2016                 | 213570 | 213570 | 213570 | 213570 | 213570 | 213570 | 213570 | 213570 | 213570 |
| 2017                 | 215247 | 215247 | 215247 | 215247 | 215247 | 215247 | 215247 | 215247 | 215247 |
| 2018                 | 216679 | 216679 | 216679 | 216679 | 216679 | 216679 | 216679 | 216679 | 216679 |
| 2019                 | 217907 | 217907 | 217907 | 217907 | 217907 | 217907 | 217907 | 217907 | 217907 |
| 2020                 | 218888 | 218888 | 218888 | 213290 | 218888 | 218888 | 218888 | 218888 | 218888 |
| 2021                 | 219755 | 219755 | 219755 | 208864 | 219755 | 219755 | 219755 | 219755 | 219755 |
| 2022                 | 220922 | 220922 | 220922 | 204696 | 220922 | 220922 | 220922 | 220922 | 220922 |
| 2023                 | 221438 | 221438 | 221438 | 200326 | 221438 | 221438 | 221438 | 221438 | 221438 |
| 2024                 | 221835 | 221835 | 221835 | 197749 | 221835 | 221835 | 221835 | 221835 | 221835 |
| 2025                 | 216749 | 216749 | 222385 | 194142 | 216749 | 216749 | 216749 | 216749 | 216749 |
| 2026                 | 211580 | 211580 | 222873 | 190763 | 211580 | 211737 | 211580 | 211580 | 211580 |
| 2027                 | 207134 | 207134 | 223196 | 187416 | 207134 | 207318 | 207134 | 207134 | 207134 |
| 2028                 | 202466 | 202486 | 223606 | 183439 | 202563 | 202974 | 202486 | 202486 | 202486 |
| 2029                 | 199234 | 199296 | 224093 | 179895 | 199392 | 199845 | 199296 | 199296 | 199296 |
| 2030                 | 196444 | 196507 | 219525 | 177455 | 196438 | 197058 | 196507 | 196507 | 196507 |
| 2031                 | 193028 | 193151 | 214490 | 174111 | 192934 | 193688 | 193151 | 193151 | 193151 |
| 2032                 | 189663 | 190014 | 209520 | 170114 | 189690 | 190597 | 189967 | 189967 | 189967 |
| 2033                 | 187098 | 187615 | 207308 | 168591 | 187094 | 187911 | 187461 | 187461 | 187461 |
| 2034                 | 184648 | 185191 | 205163 | 166347 | 184706 | 185335 | 184918 | 184918 | 184918 |
| 2035                 | 183218 | 183836 | 202190 | 164956 | 183549 | 183841 | 183438 | 183438 | 183438 |
| 2036                 | 178493 | 179070 | 197570 | 161008 | 178463 | 178303 | 178672 | 178672 | 178672 |
| 2037                 | 175070 | 175684 | 194415 | 162747 | 175605 | 174938 | 175381 | 175381 | 175381 |
| 2038                 | 170127 | 171174 | 189236 | 165418 | 170593 | 170270 | 170848 | 170848 | 170848 |
| 2039                 | 170147 | 170538 | 185169 | 168758 | 170345 | 169394 | 170259 | 170259 | 170259 |
| 2040                 | 172715 | 173063 | 181082 | 171286 | 172852 | 171982 | 172784 | 172784 | 172784 |
| 2041                 | 175298 | 175493 | 176603 | 173894 | 175282 | 174520 | 175214 | 175214 | 175214 |
| 2042                 | 177860 | 178056 | 178267 | 176508 | 177844 | 177107 | 177777 | 177777 | 177777 |
| 2043                 | 180626 | 180781 | 182131 | 179011 | 180505 | 179812 | 180502 | 180502 | 180502 |
| 2044                 | 182689 | 182865 | 184431 | 181078 | 182590 | 181940 | 182586 | 182586 | 182586 |
| 2045                 | 183731 | 183925 | 185976 | 182560 | 183637 | 183026 | 183646 | 183646 | 183646 |
| 2046                 | 184564 | 184758 | 186757 | 183629 | 184470 | 183894 | 184479 | 184479 | 184479 |
| 2047                 | 185908 | 186102 | 188300 | 185553 | 185814 | 185238 | 185823 | 185823 | 185823 |
| 2048                 | 185972 | 186187 | 187966 | 185961 | 185879 | 185338 | 185908 | 185908 | 185908 |
| 2049                 | 185989 | 186204 | 187920 | 186022 | 185896 | 185355 | 185925 | 185925 | 185925 |
| 2050                 | 186410 | 186625 | 188152 | 186443 | 186317 | 185771 | 186346 | 186346 | 186346 |
| 2051                 | 186264 | 186479 | 187943 | 186474 | 186171 | 185604 | 186200 | 186200 | 186200 |



| ScenarioID /<br>Year | 10     | 11     | 12     | 13     | 14     | 15     | 16     | 17     | 18     |
|----------------------|--------|--------|--------|--------|--------|--------|--------|--------|--------|
| 2052                 | 186326 | 186541 | 187963 | 186536 | 186233 | 185666 | 186262 | 186262 | 186262 |
| 2053                 | 186326 | 186541 | 187963 | 186536 | 186233 | 185666 | 186262 | 186262 | 186262 |
| 2054                 | 186360 | 186575 | 187934 | 186570 | 186267 | 185700 | 186296 | 186296 | 186296 |
| 2055                 | 186411 | 186626 | 187943 | 186621 | 186318 | 185751 | 186347 | 186347 | 186347 |
| 2056                 | 186437 | 186673 | 187926 | 186814 | 186346 | 185822 | 186394 | 186394 | 186394 |
| 2057                 | 186416 | 186652 | 187926 | 186814 | 186325 | 185801 | 186373 | 186373 | 186373 |
| 2058                 | 186416 | 186652 | 187926 | 186814 | 186325 | 185801 | 186373 | 186373 | 186373 |
| 2059                 | 186416 | 186652 | 187926 | 186814 | 186325 | 185801 | 186373 | 186373 | 186373 |
| 2060                 | 186416 | 186652 | 187926 | 186814 | 186325 | 185801 | 186373 | 186373 | 186373 |
| 2061                 | 186416 | 186652 | 187926 | 186814 | 186325 | 185801 | 186373 | 186373 | 186373 |
| 2062                 | 186416 | 186652 | 187926 | 186814 | 186325 | 185801 | 186373 | 186373 | 186373 |
| 2063                 | 186416 | 186652 | 187926 | 186814 | 186325 | 185801 | 186373 | 186373 | 186373 |
| 2064                 | 186416 | 186652 | 187926 | 186814 | 186325 | 185801 | 186373 | 186373 | 186373 |
| 2065                 | 186416 | 186652 | 187926 | 186814 | 186325 | 185801 | 186373 | 186373 | 186373 |
| 2066                 | 186416 | 186652 | 187926 | 186814 | 186325 | 185801 | 186373 | 186373 | 186373 |
| 2067                 | 186416 | 186652 | 187926 | 186814 | 186325 | 185801 | 186373 | 186373 | 186373 |
| 2068                 | 186416 | 186652 | 187926 | 186814 | 186325 | 185801 | 186373 | 186373 | 186373 |
| 2069                 | 186416 | 186652 | 187926 | 186814 | 186325 | 185801 | 186373 | 186373 | 186373 |
| 2070                 | 186416 | 186652 | 187926 | 186814 | 186325 | 185801 | 186373 | 186373 | 186373 |
| 2071                 | 186416 | 186652 | 187926 | 186814 | 186325 | 185801 | 186373 | 186373 | 186373 |
| 2072                 | 186416 | 186652 | 187926 | 186814 | 186325 | 185801 | 186373 | 186373 | 186373 |
| 2073                 | 186416 | 186652 | 187926 | 186814 | 186325 | 185801 | 186373 | 186373 | 186373 |
| 2074                 | 186416 | 186652 | 187926 | 186814 | 186325 | 185801 | 186373 | 186373 | 186373 |
| 2075                 | 186416 | 186652 | 187926 | 186814 | 186325 | 185801 | 186373 | 186373 | 186373 |
| 2076                 | 186416 | 186652 | 187926 | 186814 | 186325 | 185801 | 186373 | 186373 | 186373 |
| 2077                 | 186416 | 186652 | 187926 | 186814 | 186325 | 185801 | 186373 | 186373 | 186373 |
| 2078                 | 186416 | 186652 | 187926 | 186814 | 186325 | 185801 | 186373 | 186373 | 186373 |
| 2079                 | 186416 | 186652 | 187926 | 186814 | 186325 | 185801 | 186373 | 186373 | 186373 |
| 2080                 | 186416 | 186652 | 187926 | 186814 | 186325 | 185801 | 186373 | 186373 | 186373 |
| 2081                 | 186416 | 186652 | 187926 | 186814 | 186325 | 185801 | 186373 | 186373 | 186373 |
| 2082                 | 186416 | 186652 | 187926 | 186814 | 186325 | 185801 | 186373 | 186373 | 186373 |
| 2083                 | 186416 | 186652 | 187926 | 186814 | 186325 | 185801 | 186373 | 186373 | 186373 |
| 2084                 | 186416 | 186652 | 187926 | 186814 | 186325 | 185801 | 186373 | 186373 | 186373 |
| 2085                 | 186416 | 186652 | 187926 | 186814 | 186325 | 185801 | 186373 | 186373 | 186373 |
| 2086                 | 186416 | 186652 | 187926 | 186814 | 186325 | 185801 | 186373 | 186373 | 186373 |
| 2087                 | 186416 | 186652 | 187926 | 186814 | 186325 | 185801 | 186373 | 186373 | 186373 |
| 2088                 | 186416 | 186652 | 187926 | 186814 | 186325 | 185801 | 186373 | 186373 | 186373 |
| 2089                 | 186416 | 186652 | 187926 | 186814 | 186325 | 185801 | 186373 | 186373 | 186373 |
| 2090                 | 186416 | 186652 | 187926 | 186814 | 186325 | 185801 | 186373 | 186373 | 186373 |

| ScenarioID /<br>Year | 19     | 20     | 21     | 22     | 23     | 24     | 25     | 26     | 27     |
|----------------------|--------|--------|--------|--------|--------|--------|--------|--------|--------|
| 2002                 | 141104 | 141104 | 141104 | 141104 | 141104 | 141104 | 141104 | 141104 | 141104 |
| 2003                 | 149233 | 149233 | 149233 | 149233 | 149233 | 149233 | 149233 | 149233 | 149233 |
| 2004                 | 157146 | 157146 | 157146 | 157146 | 157146 | 157146 | 157146 | 157146 | 157146 |
| 2005                 | 164299 | 164299 | 164299 | 164299 | 164299 | 164299 | 164299 | 164299 | 164299 |
| 2006                 | 171496 | 171496 | 171496 | 171496 | 171496 | 171496 | 171496 | 171496 | 171496 |
| 2007                 | 178790 | 178790 | 178790 | 178790 | 178790 | 178790 | 178790 | 178790 | 178790 |
| 2008                 | 184759 | 184759 | 184759 | 184759 | 184759 | 184759 | 184759 | 184759 | 184759 |
| 2009                 | 190596 | 190596 | 190596 | 190596 | 190596 | 190596 | 190596 | 190596 | 190596 |
| 2010                 | 195244 | 195244 | 195244 | 195244 | 195244 | 195244 | 195244 | 195244 | 195244 |
| 2011                 | 199472 | 199472 | 199472 | 199472 | 199472 | 199472 | 199472 | 199472 | 199472 |
| 2012                 | 202694 | 202694 | 202694 | 202694 | 202694 | 202694 | 202694 | 202694 | 202694 |
| 2013                 | 206172 | 206172 | 206172 | 206172 | 206172 | 206172 | 206172 | 206172 | 206172 |
| 2014                 | 208841 | 208841 | 208841 | 208841 | 208841 | 208841 | 208841 | 208841 | 208841 |
| 2015                 | 211298 | 211298 | 211298 | 211298 | 211298 | 211298 | 211298 | 211298 | 211298 |
| 2016                 | 213570 | 213570 | 213570 | 213570 | 213570 | 213570 | 213570 | 213570 | 213570 |
| 2017                 | 215247 | 215247 | 215247 | 215247 | 215247 | 215247 | 215247 | 215247 | 215247 |
| 2018                 | 216679 | 216679 | 216679 | 216679 | 216679 | 216679 | 216679 | 216679 | 216679 |
| 2019                 | 217907 | 217907 | 217907 | 217907 | 217907 | 217907 | 217907 | 217907 | 217907 |
| 2020                 | 218888 | 218888 | 218888 | 213290 | 218888 | 218888 | 218888 | 218888 | 218888 |
| 2021                 | 219755 | 219755 | 219755 | 208864 | 219755 | 219755 | 219755 | 219755 | 219755 |
| 2022                 | 220922 | 220922 | 220922 | 204717 | 220922 | 220922 | 220922 | 220922 | 220922 |
| 2023                 | 221438 | 221438 | 221438 | 200431 | 221438 | 221438 | 221438 | 221438 | 221438 |
| 2024                 | 221835 | 221835 | 221835 | 197757 | 221835 | 221835 | 221835 | 221835 | 221835 |
| 2025                 | 216749 | 216749 | 222385 | 194031 | 216749 | 216749 | 216749 | 216749 | 216749 |
| 2026                 | 211621 | 211621 | 222873 | 190647 | 211600 | 211664 | 211621 | 211621 | 211621 |
| 2027                 | 207219 | 207219 | 223196 | 187643 | 207197 | 207261 | 207219 | 207219 | 207219 |
| 2028                 | 202655 | 202655 | 223606 | 183672 | 202501 | 202776 | 202655 | 202655 | 202655 |
| 2029                 | 199861 | 199861 | 224093 | 180460 | 199621 | 200066 | 199861 | 199861 | 199861 |
| 2030                 | 196885 | 197010 | 219525 | 177962 | 196727 | 197302 | 197010 | 197010 | 197010 |
| 2031                 | 193313 | 193565 | 214902 | 174771 | 193323 | 193947 | 193565 | 193565 | 193565 |
| 2032                 | 189930 | 190250 | 210022 | 170911 | 190200 | 190623 | 190162 | 190162 | 190162 |
| 2033                 | 187943 | 188257 | 207810 | 169618 | 188133 | 188234 | 188154 | 188154 | 188154 |
| 2034                 | 185038 | 185545 | 205544 | 167649 | 185655 | 185788 | 185356 | 185356 | 185356 |
| 2035                 | 183423 | 184143 | 202737 | 166232 | 184453 | 184476 | 183891 | 183891 | 183891 |
| 2036                 | 177971 | 178981 | 197555 | 161731 | 179390 | 178820 | 178749 | 178749 | 178749 |
| 2037                 | 174959 | 176133 | 194353 | 164277 | 176435 | 175152 | 175896 | 175896 | 175896 |
| 2038                 | 170430 | 171545 | 188980 | 166707 | 171797 | 170200 | 171306 | 171306 | 171306 |
| 2039                 | 171199 | 171043 | 184392 | 169981 | 171094 | 169865 | 171418 | 171418 | 171418 |
| 2040                 | 173530 | 173458 | 179884 | 172484 | 173509 | 172346 | 173795 | 173795 | 173795 |
| 2041                 | 176203 | 176108 | 177255 | 174830 | 176070 | 174973 | 176445 | 176445 | 176445 |
| 2042                 | 178569 | 178539 | 179831 | 177248 | 178501 | 177469 | 178875 | 178875 | 178875 |
| 2043                 | 181119 | 181132 | 183169 | 179836 | 181094 | 180062 | 181404 | 181404 | 181404 |
| 2044                 | 183181 | 183237 | 185407 | 181669 | 183199 | 182166 | 183489 | 183489 | 183489 |
| 2045                 | 184055 | 184237 | 186515 | 182555 | 184199 | 183095 | 184476 | 184476 | 184476 |
| 2046                 | 184816 | 184998 | 187363 | 183389 | 184960 | 183875 | 185237 | 185237 | 185237 |
| 2047                 | 186204 | 186386 | 188730 | 184733 | 186348 | 185219 | 186625 | 186625 | 186625 |
| 2048                 | 186268 | 186450 | 188395 | 184841 | 186412 | 185274 | 186689 | 186689 | 186689 |
| 2049                 | 186285 | 186467 | 188349 | 184858 | 186429 | 185291 | 186706 | 186706 | 186706 |
| 2050                 | 186706 | 186888 | 188581 | 185259 | 186850 | 185707 | 187127 | 187127 | 187127 |
| 2051                 | 186560 | 186742 | 188372 | 185113 | 186704 | 185540 | 186981 | 186981 | 186981 |

| ScenarioID /<br>Year | 19     | 20     | 21     | 22     | 23     | 24     | 25     | 26     | 27     |
|----------------------|--------|--------|--------|--------|--------|--------|--------|--------|--------|
| 2052                 | 186622 | 186804 | 188392 | 185175 | 186766 | 185602 | 187043 | 187043 | 187043 |
| 2053                 | 186622 | 186804 | 188392 | 185175 | 186766 | 185602 | 187043 | 187043 | 187043 |
| 2054                 | 186656 | 186838 | 188363 | 185209 | 186800 | 185636 | 187077 | 187077 | 187077 |
| 2055                 | 186707 | 186889 | 188372 | 185260 | 186851 | 185687 | 187128 | 187128 | 187128 |
| 2056                 | 186712 | 186936 | 188355 | 185453 | 186898 | 185734 | 187156 | 187156 | 187156 |
| 2057                 | 186691 | 186915 | 188355 | 185453 | 186877 | 185713 | 187135 | 187135 | 187135 |
| 2058                 | 186691 | 186915 | 188355 | 185453 | 186877 | 185713 | 187135 | 187135 | 187135 |
| 2059                 | 186691 | 186915 | 188355 | 185453 | 186877 | 185713 | 187135 | 187135 | 187135 |
| 2060                 | 186691 | 186915 | 188355 | 185453 | 186877 | 185713 | 187135 | 187135 | 187135 |
| 2061                 | 186691 | 186915 | 188355 | 185453 | 186877 | 185713 | 187135 | 187135 | 187135 |
| 2062                 | 186691 | 186915 | 188355 | 185453 | 186877 | 185713 | 187135 | 187135 | 187135 |
| 2063                 | 186691 | 186915 | 188355 | 185453 | 186877 | 185713 | 187135 | 187135 | 187135 |
| 2064                 | 186691 | 186915 | 188355 | 185453 | 186877 | 185713 | 187135 | 187135 | 187135 |
| 2065                 | 186691 | 186915 | 188355 | 185453 | 186877 | 185713 | 187135 | 187135 | 187135 |
| 2066                 | 186691 | 186915 | 188355 | 185453 | 186877 | 185713 | 187135 | 187135 | 187135 |
| 2067                 | 186691 | 186915 | 188355 | 185453 | 186877 | 185713 | 187135 | 187135 | 187135 |
| 2068                 | 186691 | 186915 | 188355 | 185453 | 186877 | 185713 | 187135 | 187135 | 187135 |
| 2069                 | 186691 | 186915 | 188355 | 185453 | 186877 | 185713 | 187135 | 187135 | 187135 |
| 2070                 | 186691 | 186915 | 188355 | 185453 | 186877 | 185713 | 187135 | 187135 | 187135 |
| 2071                 | 186691 | 186915 | 188355 | 185453 | 186877 | 185713 | 187135 | 187135 | 187135 |
| 2072                 | 186691 | 186915 | 188355 | 185453 | 186877 | 185713 | 187135 | 187135 | 187135 |
| 2073                 | 186691 | 186915 | 188355 | 185453 | 186877 | 185713 | 187135 | 187135 | 187135 |
| 2074                 | 186691 | 186915 | 188355 | 185453 | 186877 | 185713 | 187135 | 187135 | 187135 |
| 2075                 | 186691 | 186915 | 188355 | 185453 | 186877 | 185713 | 187135 | 187135 | 187135 |
| 2076                 | 186691 | 186915 | 188355 | 185453 | 186877 | 185713 | 187135 | 187135 | 187135 |
| 2077                 | 186691 | 186915 | 188355 | 185453 | 186877 | 185713 | 187135 | 187135 | 187135 |
| 2078                 | 186691 | 186915 | 188355 | 185453 | 186877 | 185713 | 187135 | 187135 | 187135 |
| 2079                 | 186691 | 186915 | 188355 | 185453 | 186877 | 185713 | 187135 | 187135 | 187135 |
| 2080                 | 186691 | 186915 | 188355 | 185453 | 186877 | 185713 | 187135 | 187135 | 187135 |
| 2081                 | 186691 | 186915 | 188355 | 185453 | 186877 | 185713 | 187135 | 187135 | 187135 |
| 2082                 | 186691 | 186915 | 188355 | 185453 | 186877 | 185713 | 187135 | 187135 | 187135 |
| 2083                 | 186691 | 186915 | 188355 | 185453 | 186877 | 185713 | 187135 | 187135 | 187135 |
| 2084                 | 186691 | 186915 | 188355 | 185453 | 186877 | 185713 | 187135 | 187135 | 187135 |
| 2085                 | 186691 | 186915 | 188355 | 185453 | 186877 | 185713 | 187135 | 187135 | 187135 |
| 2086                 | 186691 | 186915 | 188355 | 185453 | 186877 | 185713 | 187135 | 187135 | 187135 |
| 2087                 | 186691 | 186915 | 188355 | 185453 | 186877 | 185713 | 187135 | 187135 | 187135 |
| 2088                 | 186691 | 186915 | 188355 | 185453 | 186877 | 185713 | 187135 | 187135 | 187135 |
| 2089                 | 186691 | 186915 | 188355 | 185453 | 186877 | 185713 | 187135 | 187135 | 187135 |
| 2090                 | 186691 | 186915 | 188355 | 185453 | 186877 | 185713 | 187135 | 187135 | 187135 |

| ScenarioID /<br>Year | 28     | 29     | 30     | 31     | 32     | 33     | 34     | 35     | 36     |
|----------------------|--------|--------|--------|--------|--------|--------|--------|--------|--------|
| 2002                 | 141104 | 141104 | 141104 | 141104 | 141104 | 141104 | 141104 | 141104 | 141104 |
| 2003                 | 149233 | 149233 | 149233 | 149233 | 149233 | 149233 | 149233 | 149233 | 149233 |
| 2004                 | 157146 | 157146 | 157146 | 157146 | 157146 | 157146 | 157146 | 157146 | 157146 |
| 2005                 | 164299 | 164299 | 164299 | 164299 | 164299 | 164299 | 164299 | 164299 | 164299 |
| 2006                 | 171496 | 171496 | 171496 | 171496 | 171496 | 171496 | 171496 | 171496 | 171496 |
| 2007                 | 178790 | 178790 | 178790 | 178790 | 178790 | 178790 | 178790 | 178790 | 178790 |
| 2008                 | 184759 | 184759 | 184759 | 184759 | 184759 | 184759 | 184759 | 184759 | 184759 |
| 2009                 | 190596 | 190596 | 190596 | 190596 | 190596 | 190596 | 190596 | 190596 | 190596 |
| 2010                 | 195244 | 195244 | 195244 | 195244 | 195244 | 195244 | 195244 | 195244 | 195244 |
| 2011                 | 199472 | 199472 | 199472 | 199472 | 199472 | 199472 | 199472 | 199472 | 199472 |
| 2012                 | 202694 | 202694 | 202694 | 202694 | 202694 | 202694 | 202694 | 202694 | 202694 |
| 2013                 | 206172 | 206172 | 206172 | 206172 | 206172 | 206172 | 206172 | 206172 | 206172 |
| 2014                 | 208841 | 208841 | 208841 | 208841 | 208841 | 208841 | 208841 | 208841 | 208841 |
| 2015                 | 211298 | 211298 | 211298 | 211298 | 211298 | 211298 | 211298 | 211298 | 211298 |
| 2016                 | 213570 | 213570 | 213570 | 213570 | 213570 | 213570 | 213570 | 213570 | 213570 |
| 2017                 | 215247 | 215247 | 215247 | 215247 | 215247 | 215247 | 215247 | 215247 | 215247 |
| 2018                 | 216679 | 216679 | 216679 | 216679 | 216679 | 216679 | 216679 | 216679 | 216679 |
| 2019                 | 217907 | 217907 | 217907 | 217907 | 217907 | 217907 | 217907 | 217907 | 217907 |
| 2020                 | 218888 | 218888 | 218888 | 208977 | 218888 | 218888 | 218888 | 218888 | 218888 |
| 2021                 | 219755 | 219755 | 219755 | 201006 | 219755 | 219755 | 219755 | 219755 | 219755 |
| 2022                 | 220922 | 220922 | 220922 | 193488 | 220922 | 220922 | 220922 | 220922 | 220922 |
| 2023                 | 221438 | 221438 | 221438 | 185287 | 221438 | 221438 | 221438 | 221438 | 221438 |
| 2024                 | 221835 | 221835 | 221835 | 176821 | 221835 | 221835 | 221835 | 221835 | 221835 |
| 2025                 | 213073 | 213073 | 222385 | 168726 | 213073 | 213073 | 213073 | 213073 | 213073 |
| 2026                 | 204407 | 204407 | 222873 | 160558 | 204407 | 204407 | 204407 | 204407 | 204407 |
| 2027                 | 195806 | 195806 | 223196 | 153122 | 195806 | 195806 | 195806 | 195806 | 195806 |
| 2028                 | 186949 | 186949 | 223606 | 147675 | 186949 | 186949 | 186949 | 186949 | 186949 |
| 2029                 | 178128 | 178128 | 224093 | 142281 | 178128 | 178392 | 178128 | 178128 | 178128 |
| 2030                 | 171084 | 171084 | 216804 | 137475 | 171084 | 172071 | 171084 | 171084 | 171084 |
| 2031                 | 163393 | 163393 | 208671 | 133459 | 163235 | 166869 | 163393 | 163393 | 163393 |
| 2032                 | 156926 | 156751 | 199233 | 128647 | 156020 | 161977 | 156751 | 156751 | 156751 |
| 2033                 | 153356 | 153321 | 191836 | 126497 | 150251 | 158345 | 153277 | 153277 | 153277 |
| 2034                 | 149082 | 149075 | 183274 | 123231 | 145842 | 152984 | 149016 | 149016 | 149016 |
| 2035                 | 146414 | 146742 | 176732 | 121724 | 143693 | 149779 | 146601 | 146601 | 146601 |
| 2036                 | 139094 | 138568 | 166461 | 117017 | 138078 | 142674 | 138404 | 138404 | 138404 |
| 2037                 | 133682 | 133384 | 159135 | 114677 | 134264 | 138167 | 133445 | 133445 | 133445 |
| 2038                 | 125742 | 126676 | 151119 | 110207 | 128722 | 131552 | 127059 | 127059 | 127059 |
| 2039                 | 119508 | 121118 | 146261 | 106247 | 123076 | 125328 | 121209 | 121209 | 121209 |
| 2040                 | 112352 | 114513 | 138734 | 99673  | 115661 | 117843 | 114676 | 114676 | 114676 |
| 2041                 | 106162 | 109168 | 130786 | 93513  | 110398 | 111523 | 108825 | 108825 | 108825 |
| 2042                 | 99861  | 103312 | 123576 | 87571  | 103916 | 104939 | 102137 | 102137 | 102137 |
| 2043                 | 96250  | 99321  | 118049 | 83704  | 99459  | 100649 | 98307  | 98307  | 98307  |
| 2044                 | 92959  | 95915  | 113515 | 81134  | 96151  | 96627  | 94921  | 94921  | 94921  |
| 2045                 | 88107  | 91169  | 108109 | 76986  | 91781  | 92493  | 90139  | 90139  | 90139  |
| 2046                 | 83505  | 86315  | 102824 | 73296  | 87940  | 87961  | 85307  | 85307  | 85307  |
| 2047                 | 81125  | 83537  | 99045  | 71573  | 85163  | 85485  | 82549  | 82549  | 82549  |
| 2048                 | 75801  | 78663  | 93259  | 67032  | 80292  | 80353  | 77654  | 77654  | 77654  |
| 2049                 | 69140  | 72269  | 86063  | 60863  | 74320  | 73629  | 71303  | 71303  | 71303  |
| 2050                 | 63176  | 66199  | 79533  | 55240  | 68933  | 68577  | 65298  | 65298  | 65298  |
| 2051                 | 56350  | 59439  | 72834  | 48763  | 62419  | 61882  | 58598  | 58598  | 58598  |

| ScenarioID /<br>Year | 28    | 29    | 30    | 31    | 32    | 33    | 34    | 35    | 36    |
|----------------------|-------|-------|-------|-------|-------|-------|-------|-------|-------|
| 2052                 | 48401 | 51563 | 64837 | 41218 | 54669 | 53810 | 50597 | 50597 | 50597 |
| 2053                 | 40858 | 44047 | 56978 | 34144 | 47365 | 45496 | 43076 | 43076 | 43076 |
| 2054                 | 34610 | 37714 | 50254 | 27894 | 40993 | 38362 | 37250 | 37250 | 37250 |
| 2055                 | 28247 | 31624 | 43768 | 21231 | 34184 | 31363 | 31200 | 31200 | 31200 |
| 2056                 | 22036 | 25508 | 37430 | 15244 | 27920 | 24966 | 25093 | 25093 | 25093 |
| 2057                 | 15934 | 19488 | 31069 | 10851 | 21569 | 18540 | 18592 | 18592 | 18592 |
| 2058                 | 11345 | 13782 | 25265 | 8367  | 15611 | 12962 | 12987 | 12987 | 12987 |
| 2059                 | 8704  | 10340 | 19895 | 6797  | 11290 | 10345 | 9511  | 9511  | 9511  |
| 2060                 | 7227  | 8440  | 15697 | 5474  | 7865  | 8284  | 7560  | 7560  | 7560  |
| 2061                 | 5575  | 6586  | 11895 | 4110  | 5942  | 6630  | 5915  | 5915  | 5915  |
| 2062                 | 4210  | 4728  | 9177  | 2830  | 4390  | 5244  | 4493  | 4493  | 4493  |
| 2063                 | 3098  | 3329  | 7143  | 1939  | 3104  | 3675  | 3308  | 3308  | 3308  |
| 2064                 | 2172  | 2403  | 5939  | 1224  | 2133  | 2405  | 2382  | 2382  | 2382  |
| 2065                 | 1137  | 1244  | 4613  | 350   | 1186  | 1413  | 1223  | 1223  | 1223  |
| 2066                 | 776   | 673   | 3296  | 215   | 502   | 926   | 776   | 776   | 776   |
| 2067                 | 470   | 197   | 2171  | 119   | 348   | 549   | 470   | 470   | 470   |
| 2068                 | 198   | 134   | 1571  | 57    | 162   | 408   | 198   | 198   | 198   |
| 2069                 | 0     | 57    | 992   | 0     | 161   | 365   | 0     | 0     | 0     |
| 2070                 | 0     | 0     | 767   | 0     | 78    | 287   | 0     | 0     | 0     |
| 2071                 | 0     | 0     | 704   | 0     | 0     | 225   | 0     | 0     | 0     |
| 2072                 | 0     | 0     | 432   | 0     | 0     | 162   | 0     | 0     | 0     |
| 2073                 | 0     | 0     | 159   | 0     | 0     | 161   | 0     | 0     | 0     |
| 2074                 | 0     | 0     | 122   | 0     | 0     | 120   | 0     | 0     | 0     |
| 2075                 | 0     | 0     | 60    | 0     | 0     | 57    | 0     | 0     | 0     |
| 2076                 | 0     | 0     | 0     | 0     | 0     | 56    | 0     | 0     | 0     |
| 2077                 | 0     | 0     | 0     | 0     | 0     | 0     | 0     | 0     | 0     |
| 2078                 | 0     | 0     | 0     | 0     | 0     | 0     | 0     | 0     | 0     |
| 2079                 | 0     | 0     | 0     | 0     | 0     | 0     | 0     | 0     | 0     |
| 2080                 | 0     | 0     | 0     | 0     | 0     | 0     | 0     | 0     | 0     |
| 2081                 | 0     | 0     | 0     | 0     | 0     | 0     | 0     | 0     | 0     |
| 2082                 | 0     | 0     | 0     | 0     | 0     | 0     | 0     | 0     | 0     |
| 2083                 | 0     | 0     | 0     | 0     | 0     | 0     | 0     | 0     | 0     |
| 2084                 | 0     | 0     | 0     | 0     | 0     | 0     | 0     | 0     | 0     |
| 2085                 | 0     | 0     | 0     | 0     | 0     | 0     | 0     | 0     | 0     |
| 2086                 | 0     | 0     | 0     | 0     | 0     | 0     | 0     | 0     | 0     |
| 2087                 | 0     | 0     | 0     | 0     | 0     | 0     | 0     | 0     | 0     |
| 2088                 | 0     | 0     | 0     | 0     | 0     | 0     | 0     | 0     | 0     |
| 2089                 | 0     | 0     | 0     | 0     | 0     | 0     | 0     | 0     | 0     |
| 2090                 | 0     | 0     | 0     | 0     | 0     | 0     | 0     | 0     | 0     |

| ScenarioID /<br>Year | 37     | 38     | 39     | 40     | 41     | 42     | 43     | 44     | 45     |
|----------------------|--------|--------|--------|--------|--------|--------|--------|--------|--------|
| 2002                 | 141104 | 141104 | 141104 | 141104 | 141104 | 141104 | 141104 | 141104 | 141104 |
| 2003                 | 149233 | 149233 | 149233 | 149233 | 149233 | 149233 | 149233 | 149233 | 149233 |
| 2004                 | 157146 | 157146 | 157146 | 157146 | 157146 | 157146 | 157146 | 157146 | 157146 |
| 2005                 | 164299 | 164299 | 164299 | 164299 | 164299 | 164299 | 164299 | 164299 | 164299 |
| 2006                 | 171496 | 171496 | 171496 | 171496 | 171496 | 171496 | 171496 | 171496 | 171496 |
| 2007                 | 178790 | 178790 | 178790 | 178790 | 178790 | 178790 | 178790 | 178790 | 178790 |
| 2008                 | 184759 | 184759 | 184759 | 184759 | 184759 | 184759 | 184759 | 184759 | 184759 |
| 2009                 | 190596 | 190596 | 190596 | 190596 | 190596 | 190596 | 190596 | 190596 | 190596 |
| 2010                 | 195244 | 195244 | 195244 | 195244 | 195244 | 195244 | 195244 | 195244 | 195244 |
| 2011                 | 199472 | 199472 | 199472 | 199472 | 199472 | 199472 | 199472 | 199472 | 199472 |
| 2012                 | 202694 | 202694 | 202694 | 202694 | 202694 | 202694 | 202694 | 202694 | 202694 |
| 2013                 | 206172 | 206172 | 206172 | 206172 | 206172 | 206172 | 206172 | 206172 | 206172 |
| 2014                 | 208841 | 208841 | 208841 | 208841 | 208841 | 208841 | 208841 | 208841 | 208841 |
| 2015                 | 211298 | 211298 | 211298 | 211298 | 211298 | 211298 | 211298 | 211298 | 211298 |
| 2016                 | 213570 | 213570 | 213570 | 213570 | 213570 | 213570 | 213570 | 213570 | 213570 |
| 2017                 | 215247 | 215247 | 215247 | 215247 | 215247 | 215247 | 215247 | 215247 | 215247 |
| 2018                 | 216679 | 216679 | 216679 | 216679 | 216679 | 216679 | 216679 | 216679 | 216679 |
| 2019                 | 217907 | 217907 | 217907 | 217907 | 217907 | 217907 | 217907 | 217907 | 217907 |
| 2020                 | 218888 | 218888 | 218888 | 212259 | 218888 | 218888 | 218888 | 218888 | 218888 |
| 2021                 | 219755 | 219755 | 219755 | 206458 | 219755 | 219755 | 219755 | 219755 | 219755 |
| 2022                 | 220922 | 220922 | 220922 | 201052 | 220922 | 220922 | 220922 | 220922 | 220922 |
| 2023                 | 221438 | 221438 | 221438 | 195166 | 221438 | 221438 | 221438 | 221438 | 221438 |
| 2024                 | 221835 | 221835 | 221835 | 190414 | 221835 | 221835 | 221835 | 221835 | 221835 |
| 2025                 | 215668 | 215668 | 222385 | 185602 | 215668 | 215668 | 215668 | 215668 | 215668 |
| 2026                 | 210074 | 210074 | 222873 | 181115 | 210074 | 210221 | 210074 | 210074 | 210074 |
| 2027                 | 204006 | 204006 | 223196 | 176984 | 204006 | 204469 | 204006 | 204006 | 204006 |
| 2028                 | 198574 | 198638 | 223606 | 173551 | 198677 | 199526 | 198700 | 198700 | 198700 |
| 2029                 | 193778 | 193812 | 224093 | 170104 | 193301 | 194999 | 193917 | 193917 | 193917 |
| 2030                 | 189551 | 189216 | 218258 | 167115 | 189368 | 191518 | 189552 | 189552 | 189552 |
| 2031                 | 185397 | 185777 | 212621 | 164535 | 185808 | 188087 | 186161 | 186161 | 186161 |
| 2032                 | 181717 | 183007 | 206940 | 161887 | 182566 | 184595 | 182797 | 182797 | 182797 |
| 2033                 | 179352 | 181386 | 202591 | 160375 | 180854 | 182996 | 180558 | 180558 | 180558 |
| 2034                 | 177003 | 178905 | 198570 | 158697 | 178489 | 180341 | 178129 | 178129 | 178129 |
| 2035                 | 174827 | 177130 | 194643 | 157699 | 176216 | 177923 | 176158 | 176158 | 176158 |
| 2036                 | 170744 | 172822 | 189543 | 154059 | 171929 | 173250 | 171785 | 171785 | 171785 |
| 2037                 | 168014 | 170635 | 186234 | 152631 | 169635 | 170092 | 169493 | 169493 | 169493 |
| 2038                 | 164047 | 167552 | 182120 | 149876 | 166199 | 165949 | 166111 | 166111 | 166111 |
| 2039                 | 161105 | 164258 | 178598 | 147703 | 162255 | 162570 | 162992 | 162992 | 162992 |
| 2040                 | 157862 | 160716 | 175076 | 144931 | 158442 | 159625 | 159350 | 159350 | 159350 |
| 2041                 | 154121 | 157003 | 171319 | 141847 | 154798 | 156848 | 155517 | 155517 | 155517 |
| 2042                 | 151249 | 153722 | 168091 | 138223 | 151311 | 155366 | 152205 | 152205 | 152205 |
| 2043                 | 149113 | 151885 | 165715 | 135996 | 149037 | 154321 | 150433 | 150433 | 150433 |
| 2044                 | 147566 | 150279 | 163296 | 133893 | 146901 | 153299 | 148794 | 148794 | 148794 |
| 2045                 | 145270 | 147970 | 159303 | 131769 | 143735 | 149927 | 146459 | 146459 | 146459 |
| 2046                 | 143536 | 146206 | 156405 | 129786 | 140867 | 146554 | 144797 | 144797 | 144797 |
| 2047                 | 140827 | 144244 | 153175 | 128451 | 137783 | 142656 | 142162 | 142162 | 142162 |
| 2048                 | 136671 | 140425 | 149575 | 123696 | 133466 | 136192 | 137240 | 137240 | 137240 |
| 2049                 | 130427 | 135767 | 145622 | 118153 | 128876 | 128213 | 131182 | 131182 | 131182 |
| 2050                 | 125003 | 131421 | 142031 | 114341 | 123661 | 121672 | 125549 | 125549 | 125549 |
| 2051                 | 119520 | 127650 | 138914 | 110600 | 117448 | 115119 | 120515 | 120515 | 120515 |

| ScenarioID /<br>Year | 37     | 38     | 39     | 40     | 41     | 42     | 43     | 44     | 45     |
|----------------------|--------|--------|--------|--------|--------|--------|--------|--------|--------|
| 2052                 | 113345 | 122673 | 135710 | 106661 | 111936 | 109114 | 115033 | 115033 | 115033 |
| 2053                 | 108283 | 117617 | 132118 | 101932 | 106188 | 103144 | 109154 | 109154 | 109154 |
| 2054                 | 103154 | 111967 | 128176 | 96747  | 99405  | 97090  | 103394 | 103394 | 103394 |
| 2055                 | 97193  | 105085 | 123039 | 91576  | 91797  | 90785  | 96619  | 96619  | 96619  |
| 2056                 | 89736  | 96954  | 116987 | 85051  | 83412  | 83706  | 88897  | 88897  | 88897  |
| 2057                 | 81166  | 87723  | 108152 | 76273  | 75061  | 75863  | 80232  | 80232  | 80232  |
| 2058                 | 71806  | 78587  | 98433  | 66928  | 66194  | 66755  | 71321  | 71321  | 71321  |
| 2059                 | 62058  | 69392  | 89197  | 57495  | 57635  | 57816  | 61855  | 61855  | 61855  |
| 2060                 | 52627  | 60663  | 79752  | 48049  | 48566  | 48223  | 52909  | 52909  | 52909  |
| 2061                 | 43308  | 50687  | 70880  | 38707  | 38663  | 38348  | 43160  | 43160  | 43160  |
| 2062                 | 35022  | 40039  | 62826  | 30388  | 30830  | 29116  | 34840  | 34840  | 34840  |
| 2063                 | 27377  | 31128  | 52638  | 23035  | 22961  | 21479  | 26973  | 26973  | 26973  |
| 2064                 | 20580  | 23327  | 41687  | 16430  | 16279  | 15225  | 20164  | 20164  | 20164  |
| 2065                 | 14935  | 16892  | 31403  | 11176  | 11741  | 10972  | 14551  | 14551  | 14551  |
| 2066                 | 10896  | 12400  | 22136  | 8031   | 8132   | 8033   | 10433  | 10433  | 10433  |
| 2067                 | 7549   | 8711   | 15540  | 5543   | 5779   | 5976   | 6998   | 6998   | 6998   |
| 2068                 | 5545   | 6220   | 11731  | 4339   | 3719   | 4663   | 4994   | 4994   | 4994   |
| 2069                 | 3795   | 4344   | 8610   | 3246   | 2316   | 3392   | 3332   | 3332   | 3332   |
| 2070                 | 2386   | 2935   | 6341   | 2256   | 1132   | 2420   | 1942   | 1942   | 1942   |
| 2071                 | 1093   | 1667   | 4214   | 1313   | 491    | 1623   | 1114   | 1114   | 1114   |
| 2072                 | 632    | 745    | 2367   | 527    | 51     | 800    | 632    | 632    | 632    |
| 2073                 | 108    | 129    | 1206   | 51     | 0      | 477    | 129    | 129    | 129    |
| 2074                 | 36     | 57     | 284    | 0      | 0      | 414    | 57     | 57     | 57     |
| 2075                 | 0      | 0      | 57     | 0      | 0      | 372    | 0      | 0      | 0      |
| 2076                 | 0      | 0      | 0      | 0      | 0      | 288    | 0      | 0      | 0      |
| 2077                 | 0      | 0      | 0      | 0      | 0      | 267    | 0      | 0      | 0      |
| 2078                 | 0      | 0      | 0      | 0      | 0      | 183    | 0      | 0      | 0      |
| 2079                 | 0      | 0      | 0      | 0      | 0      | 162    | 0      | 0      | 0      |
| 2080                 | 0      | 0      | 0      | 0      | 0      | 78     | 0      | 0      | 0      |
| 2081                 | 0      | 0      | 0      | 0      | 0      | 57     | 0      | 0      | 0      |
| 2082                 | 0      | 0      | 0      | 0      | 0      | 36     | 0      | 0      | 0      |
| 2083                 | 0      | 0      | 0      | 0      | 0      | 0      | 0      | 0      | 0      |
| 2084                 | 0      | 0      | 0      | 0      | 0      | 0      | 0      | 0      | 0      |
| 2085                 | 0      | 0      | 0      | 0      | 0      | 0      | 0      | 0      | 0      |
| 2086                 | 0      | 0      | 0      | 0      | 0      | 0      | 0      | 0      | 0      |
| 2087                 | 0      | 0      | 0      | 0      | 0      | 0      | 0      | 0      | 0      |
| 2088                 | 0      | 0      | 0      | 0      | 0      | 0      | 0      | 0      | 0      |
| 2089                 | 0      | 0      | 0      | 0      | 0      | 0      | 0      | 0      | 0      |
| 2090                 | 0      | 0      | 0      | 0      | 0      | 0      | 0      | 0      | 0      |

| ScenarioID /<br>Year | 46     | 47     | 48     | 49     | 50     | 51     | 52     | 53     | 54     |
|----------------------|--------|--------|--------|--------|--------|--------|--------|--------|--------|
| 2002                 | 141104 | 141104 | 141104 | 141104 | 141104 | 141104 | 141104 | 141104 | 141104 |
| 2003                 | 149233 | 149233 | 149233 | 149233 | 149233 | 149233 | 149233 | 149233 | 149233 |
| 2004                 | 157146 | 157146 | 157146 | 157146 | 157146 | 157146 | 157146 | 157146 | 157146 |
| 2005                 | 164299 | 164299 | 164299 | 164299 | 164299 | 164299 | 164299 | 164299 | 164299 |
| 2006                 | 171496 | 171496 | 171496 | 171496 | 171496 | 171496 | 171496 | 171496 | 171496 |
| 2007                 | 178790 | 178790 | 178790 | 178790 | 178790 | 178790 | 178790 | 178790 | 178790 |
| 2008                 | 184759 | 184759 | 184759 | 184759 | 184759 | 184759 | 184759 | 184759 | 184759 |
| 2009                 | 190596 | 190596 | 190596 | 190596 | 190596 | 190596 | 190596 | 190596 | 190596 |
| 2010                 | 195244 | 195244 | 195244 | 195244 | 195244 | 195244 | 195244 | 195244 | 195244 |
| 2011                 | 199472 | 199472 | 199472 | 199472 | 199472 | 199472 | 199472 | 199472 | 199472 |
| 2012                 | 202694 | 202694 | 202694 | 202694 | 202694 | 202694 | 202694 | 202694 | 202694 |
| 2013                 | 206172 | 206172 | 206172 | 206172 | 206172 | 206172 | 206172 | 206172 | 206172 |
| 2014                 | 208841 | 208841 | 208841 | 208841 | 208841 | 208841 | 208841 | 208841 | 208841 |
| 2015                 | 211298 | 211298 | 211298 | 211298 | 211298 | 211298 | 211298 | 211298 | 211298 |
| 2016                 | 213570 | 213570 | 213570 | 213570 | 213570 | 213570 | 213570 | 213570 | 213570 |
| 2017                 | 215247 | 215247 | 215247 | 215247 | 215247 | 215247 | 215247 | 215247 | 215247 |
| 2018                 | 216679 | 216679 | 216679 | 216679 | 216679 | 216679 | 216679 | 216679 | 216679 |
| 2019                 | 217907 | 217907 | 217907 | 217907 | 217907 | 217907 | 217907 | 217907 | 217907 |
| 2020                 | 218888 | 218888 | 218888 | 212259 | 218888 | 218888 | 218888 | 218888 | 218888 |
| 2021                 | 219755 | 219755 | 219755 | 206458 | 219755 | 219755 | 219755 | 219755 | 219755 |
| 2022                 | 220922 | 220922 | 220922 | 201010 | 220922 | 220922 | 220922 | 220922 | 220922 |
| 2023                 | 221438 | 221438 | 221438 | 195083 | 221438 | 221438 | 221438 | 221438 | 221438 |
| 2024                 | 221835 | 221835 | 221835 | 189535 | 221835 | 221835 | 221835 | 221835 | 221835 |
| 2025                 | 215668 | 215668 | 222385 | 184602 | 215668 | 215668 | 215668 | 215668 | 215668 |
| 2026                 | 210074 | 210074 | 222873 | 180357 | 210074 | 210158 | 210074 | 210074 | 210074 |
| 2027                 | 203943 | 203943 | 223196 | 176194 | 203943 | 204258 | 203943 | 203943 | 203943 |
| 2028                 | 198552 | 198489 | 223606 | 172482 | 198363 | 199095 | 198489 | 198489 | 198489 |
| 2029                 | 192552 | 192594 | 224093 | 168580 | 192508 | 193473 | 192551 | 192551 | 192551 |
| 2030                 | 188098 | 188345 | 218258 | 165597 | 187970 | 189311 | 188259 | 188259 | 188259 |
| 2031                 | 184403 | 185199 | 212726 | 162891 | 184467 | 185774 | 184886 | 184886 | 184886 |
| 2032                 | 180720 | 182174 | 206982 | 160518 | 181377 | 182375 | 181628 | 181628 | 181628 |
| 2033                 | 178609 | 180665 | 202486 | 159143 | 179612 | 180541 | 179558 | 179558 | 179558 |
| 2034                 | 176099 | 178378 | 197290 | 157518 | 177247 | 177923 | 177071 | 177071 | 177071 |
| 2035                 | 173734 | 176017 | 193216 | 155764 | 174492 | 175357 | 174518 | 174518 | 174518 |
| 2036                 | 169081 | 171318 | 187839 | 151691 | 169794 | 170586 | 169730 | 169730 | 169730 |
| 2037                 | 165939 | 168573 | 184265 | 149620 | 167477 | 167605 | 167024 | 167024 | 167024 |
| 2038                 | 161634 | 163924 | 179689 | 146096 | 163602 | 163419 | 162597 | 162597 | 162597 |
| 2039                 | 157335 | 159828 | 175540 | 142371 | 159663 | 159713 | 158575 | 158575 | 158575 |
| 2040                 | 152739 | 155504 | 170667 | 137783 | 155128 | 155614 | 153904 | 153904 | 153904 |
| 2041                 | 148154 | 151202 | 166455 | 133112 | 150702 | 151412 | 149355 | 149355 | 149355 |
| 2042                 | 144247 | 147730 | 162888 | 128832 | 147084 | 147641 | 145591 | 145591 | 145591 |
| 2043                 | 141186 | 144875 | 160496 | 126524 | 144531 | 144338 | 142674 | 142674 | 142674 |
| 2044                 | 138298 | 141724 | 158036 | 122553 | 141891 | 140980 | 139589 | 139589 | 139589 |
| 2045                 | 134263 | 137945 | 153903 | 117532 | 137866 | 135791 | 135784 | 135784 | 135784 |
| 2046                 | 130824 | 134630 | 150257 | 112788 | 134288 | 131800 | 132501 | 132501 | 132501 |
| 2047                 | 127198 | 131222 | 146592 | 108608 | 131178 | 127028 | 129139 | 129139 | 129139 |
| 2048                 | 120448 | 126147 | 141736 | 101752 | 126351 | 120599 | 123655 | 123655 | 123655 |
| 2049                 | 112501 | 118316 | 136421 | 93119  | 119445 | 111701 | 116174 | 116174 | 116174 |
| 2050                 | 104936 | 110709 | 131156 | 85371  | 112090 | 104451 | 108744 | 108744 | 108744 |
| 2051                 | 96932  | 102242 | 124096 | 76722  | 103916 | 95799  | 101088 | 101088 | 101088 |



| ScenarioID /<br>Year | 46    | 47    | 48     | 49    | 50    | 51    | 52    | 53    | 54    |
|----------------------|-------|-------|--------|-------|-------|-------|-------|-------|-------|
| 2052                 | 87649 | 93215 | 115923 | 66992 | 95118 | 86486 | 92041 | 92041 | 92041 |
| 2053                 | 79119 | 84671 | 107184 | 57876 | 87240 | 77130 | 83711 | 83711 | 83711 |
| 2054                 | 70449 | 76691 | 99919  | 48257 | 79443 | 67568 | 75751 | 75751 | 75751 |
| 2055                 | 60624 | 68207 | 92042  | 38306 | 71652 | 57951 | 67147 | 67147 | 67147 |
| 2056                 | 50613 | 58883 | 84059  | 28086 | 63004 | 47988 | 57332 | 57332 | 57332 |
| 2057                 | 40098 | 48848 | 76457  | 21691 | 52897 | 37646 | 47181 | 47181 | 47181 |
| 2058                 | 29752 | 38659 | 68315  | 16230 | 41839 | 30355 | 36602 | 36602 | 36602 |
| 2059                 | 22130 | 28792 | 58746  | 12040 | 31677 | 23945 | 26953 | 26953 | 26953 |
| 2060                 | 16513 | 21470 | 47973  | 9186  | 23009 | 18846 | 20151 | 20151 | 20151 |
| 2061                 | 12143 | 15769 | 37112  | 6057  | 16749 | 14506 | 14770 | 14770 | 14770 |
| 2062                 | 9125  | 12114 | 26877  | 3953  | 12828 | 10879 | 10950 | 10950 | 10950 |
| 2063                 | 6437  | 9105  | 18824  | 2739  | 9459  | 7611  | 7917  | 7917  | 7917  |
| 2064                 | 3928  | 6233  | 13974  | 1768  | 7106  | 5634  | 5167  | 5167  | 5167  |
| 2065                 | 2214  | 3685  | 10370  | 1346  | 4785  | 4080  | 3011  | 3011  | 3011  |
| 2066                 | 1213  | 1950  | 7434   | 779   | 2654  | 3537  | 1680  | 1680  | 1680  |
| 2067                 | 648   | 984   | 5087   | 477   | 1247  | 3270  | 738   | 738   | 738   |
| 2068                 | 534   | 423   | 3008   | 414   | 694   | 3130  | 108   | 108   | 108   |
| 2069                 | 429   | 351   | 1548   | 330   | 254   | 2965  | 0     | 0     | 0     |
| 2070                 | 407   | 330   | 670    | 309   | 203   | 2733  | 0     | 0     | 0     |
| 2071                 | 288   | 309   | 111    | 225   | 141   | 2327  | 0     | 0     | 0     |
| 2072                 | 267   | 288   | 0      | 204   | 57    | 1658  | 0     | 0     | 0     |
| 2073                 | 183   | 225   | 0      | 120   | 0     | 1196  | 0     | 0     | 0     |
| 2074                 | 162   | 204   | 0      | 99    | 0     | 781   | 0     | 0     | 0     |
| 2075                 | 78    | 141   | 0      | 0     | 0     | 535   | 0     | 0     | 0     |
| 2076                 | 57    | 99    | 0      | 0     | 0     | 435   | 0     | 0     | 0     |
| 2077                 | 36    | 78    | 0      | 0     | 0     | 414   | 0     | 0     | 0     |
| 2078                 | 0     | 0     | 0      | 0     | 0     | 330   | 0     | 0     | 0     |
| 2079                 | 0     | 0     | 0      | 0     | 0     | 309   | 0     | 0     | 0     |
| 2080                 | 0     | 0     | 0      | 0     | 0     | 225   | 0     | 0     | 0     |
| 2081                 | 0     | 0     | 0      | 0     | 0     | 204   | 0     | 0     | 0     |
| 2082                 | 0     | 0     | 0      | 0     | 0     | 183   | 0     | 0     | 0     |
| 2083                 | 0     | 0     | 0      | 0     | 0     | 120   | 0     | 0     | 0     |
| 2084                 | 0     | 0     | 0      | 0     | 0     | 99    | 0     | 0     | 0     |
| 2085                 | 0     | 0     | 0      | 0     | 0     | 0     | 0     | 0     | 0     |
| 2086                 | 0     | 0     | 0      | 0     | 0     | 0     | 0     | 0     | 0     |
| 2087                 | 0     | 0     | 0      | 0     | 0     | 0     | 0     | 0     | 0     |
| 2088                 | 0     | 0     | 0      | 0     | 0     | 0     | 0     | 0     | 0     |
| 2089                 | 0     | 0     | 0      | 0     | 0     | 0     | 0     | 0     | 0     |
| 2090                 | 0     | 0     | 0      | 0     | 0     | 0     | 0     | 0     | 0     |

| ScenarioID /<br>Year | 55     | 56     | 57     | 58     | 59     | 60     | 61     | 62     | 63     |
|----------------------|--------|--------|--------|--------|--------|--------|--------|--------|--------|
| 2002                 | 141104 | 141104 | 141104 | 141104 | 141104 | 141104 | 141104 | 141104 | 141104 |
| 2003                 | 149233 | 149233 | 149233 | 149233 | 149233 | 149233 | 149233 | 149233 | 149233 |
| 2004                 | 157146 | 157146 | 157146 | 157146 | 157146 | 157146 | 157146 | 157146 | 157146 |
| 2005                 | 164299 | 164299 | 164299 | 164299 | 164299 | 164299 | 164299 | 164299 | 164299 |
| 2006                 | 171496 | 171496 | 171496 | 171496 | 171496 | 171496 | 171496 | 171496 | 171496 |
| 2007                 | 178790 | 178790 | 178790 | 178790 | 178790 | 178790 | 178790 | 178790 | 178790 |
| 2008                 | 184759 | 184759 | 184759 | 184759 | 184759 | 184759 | 184759 | 184759 | 184759 |
| 2009                 | 190596 | 190596 | 190596 | 190596 | 190596 | 190596 | 190596 | 190596 | 190596 |
| 2010                 | 195244 | 195244 | 195244 | 195244 | 195244 | 195244 | 195244 | 195244 | 195244 |
| 2011                 | 199472 | 199472 | 199472 | 199472 | 199472 | 199472 | 199472 | 199472 | 199472 |
| 2012                 | 202694 | 202694 | 202694 | 202694 | 202694 | 202694 | 202694 | 202694 | 202694 |
| 2013                 | 206172 | 206172 | 206172 | 206172 | 206172 | 206172 | 206172 | 206172 | 206172 |
| 2014                 | 208841 | 208841 | 208841 | 208841 | 208841 | 208841 | 208841 | 208841 | 208841 |
| 2015                 | 211298 | 211298 | 211298 | 211298 | 211298 | 211298 | 211298 | 211298 | 211298 |
| 2016                 | 213570 | 213570 | 213570 | 213570 | 213570 | 213570 | 213570 | 213570 | 213570 |
| 2017                 | 215247 | 215247 | 215247 | 215247 | 215247 | 215247 | 215247 | 215247 | 215247 |
| 2018                 | 216679 | 216679 | 216679 | 216679 | 216679 | 216679 | 216679 | 216679 | 216679 |
| 2019                 | 217907 | 217907 | 217907 | 217907 | 217907 | 217907 | 217907 | 217907 | 217907 |
| 2020                 | 218888 | 218888 | 218888 | 213610 | 218888 | 218888 | 218888 | 218888 | 218888 |
| 2021                 | 219755 | 219755 | 219755 | 210610 | 219755 | 219755 | 219755 | 219755 | 219755 |
| 2022                 | 220922 | 220922 | 220922 | 208483 | 220922 | 220922 | 220922 | 220922 | 220922 |
| 2023                 | 221438 | 221438 | 221438 | 206025 | 221438 | 221438 | 221438 | 221438 | 221438 |
| 2024                 | 221835 | 221835 | 221835 | 203954 | 221835 | 221835 | 221835 | 221835 | 221835 |
| 2025                 | 216710 | 216710 | 222385 | 201452 | 216710 | 216710 | 216710 | 216710 | 216710 |
| 2026                 | 213526 | 213526 | 222873 | 198866 | 213526 | 213527 | 213526 | 213526 | 213526 |
| 2027                 | 211560 | 211560 | 223196 | 196482 | 211559 | 211676 | 211560 | 211560 | 211560 |
| 2028                 | 208575 | 208575 | 223606 | 194189 | 208575 | 208690 | 208575 | 208575 | 208575 |
| 2029                 | 205865 | 205865 | 224093 | 191595 | 205865 | 206088 | 205865 | 205865 | 205865 |
| 2030                 | 205141 | 205139 | 220106 | 190186 | 205055 | 205465 | 205139 | 205139 | 205139 |
| 2031                 | 203045 | 203065 | 217242 | 188510 | 202907 | 203719 | 203065 | 203065 | 203065 |
| 2032                 | 200707 | 200831 | 214940 | 186115 | 200495 | 201614 | 200831 | 200831 | 200831 |
| 2033                 | 199544 | 199797 | 213724 | 184367 | 199476 | 200582 | 199671 | 199671 | 199671 |
| 2034                 | 198673 | 198925 | 211571 | 182624 | 198608 | 200114 | 198799 | 198799 | 198799 |
| 2035                 | 198336 | 198588 | 210908 | 182649 | 198059 | 199710 | 198255 | 198255 | 198255 |
| 2036                 | 193908 | 194292 | 206992 | 178864 | 193716 | 195527 | 194189 | 194189 | 194189 |
| 2037                 | 191574 | 192061 | 203705 | 176359 | 191496 | 193965 | 191958 | 191958 | 191958 |
| 2038                 | 186520 | 187717 | 199697 | 172676 | 186508 | 189819 | 187385 | 187385 | 187385 |
| 2039                 | 182570 | 183701 | 196039 | 169055 | 182269 | 185793 | 183374 | 183374 | 183374 |
| 2040                 | 178041 | 179284 | 191139 | 170811 | 177940 | 181244 | 178991 | 178991 | 178991 |
| 2041                 | 173032 | 175163 | 186966 | 174046 | 174217 | 176807 | 174746 | 174746 | 174746 |
| 2042                 | 176329 | 176673 | 182396 | 177256 | 177514 | 176411 | 176721 | 176721 | 176721 |
| 2043                 | 180643 | 180758 | 180914 | 180761 | 181467 | 180547 | 180806 | 180806 | 180806 |
| 2044                 | 184253 | 184507 | 184917 | 183708 | 184866 | 184331 | 184423 | 184423 | 184423 |
| 2045                 | 186652 | 186884 | 187424 | 185805 | 187178 | 186564 | 186778 | 186778 | 186778 |
| 2046                 | 188701 | 189016 | 189791 | 187395 | 189139 | 188479 | 188888 | 188888 | 188888 |
| 2047                 | 190358 | 190778 | 191880 | 188404 | 190514 | 190142 | 190566 | 190566 | 190566 |
| 2048                 | 191055 | 191284 | 193014 | 188490 | 191045 | 190519 | 191115 | 191115 | 191115 |
| 2049                 | 191116 | 191345 | 193075 | 188551 | 191106 | 190559 | 191176 | 191176 | 191176 |
| 2050                 | 191348 | 191577 | 193307 | 188783 | 191338 | 190786 | 191408 | 191408 | 191408 |
| 2051                 | 191202 | 191431 | 193161 | 188637 | 191192 | 190619 | 191262 | 191262 | 191262 |

| ScenarioID /<br>Year | 55     | 56     | 57     | 58     | 59     | 60     | 61     | 62     | 63     |
|----------------------|--------|--------|--------|--------|--------|--------|--------|--------|--------|
| 2052                 | 191264 | 191493 | 193223 | 188699 | 191254 | 190681 | 191324 | 191324 | 191324 |
| 2053                 | 191264 | 191493 | 193223 | 188699 | 191254 | 190681 | 191324 | 191324 | 191324 |
| 2054                 | 191298 | 191527 | 193257 | 188733 | 191288 | 190715 | 191358 | 191358 | 191358 |
| 2055                 | 191308 | 191578 | 193308 | 188784 | 191298 | 190766 | 191409 | 191409 | 191409 |
| 2056                 | 191291 | 191604 | 193355 | 188852 | 191281 | 190833 | 191414 | 191414 | 191414 |
| 2057                 | 191291 | 191583 | 193334 | 188831 | 191281 | 190833 | 191393 | 191393 | 191393 |
| 2058                 | 191291 | 191583 | 193334 | 188831 | 191281 | 190833 | 191393 | 191393 | 191393 |
| 2059                 | 191291 | 191583 | 193334 | 188831 | 191281 | 190833 | 191393 | 191393 | 191393 |
| 2060                 | 191291 | 191583 | 193334 | 188831 | 191281 | 190833 | 191393 | 191393 | 191393 |
| 2061                 | 191291 | 191583 | 193334 | 188831 | 191281 | 190833 | 191393 | 191393 | 191393 |
| 2062                 | 191291 | 191583 | 193334 | 188831 | 191281 | 190833 | 191393 | 191393 | 191393 |
| 2063                 | 191291 | 191583 | 193334 | 188831 | 191281 | 190833 | 191393 | 191393 | 191393 |
| 2064                 | 191291 | 191583 | 193334 | 188831 | 191281 | 190833 | 191393 | 191393 | 191393 |
| 2065                 | 191291 | 191583 | 193334 | 188831 | 191281 | 190833 | 191393 | 191393 | 191393 |
| 2066                 | 191291 | 191583 | 193334 | 188831 | 191281 | 190833 | 191393 | 191393 | 191393 |
| 2067                 | 191291 | 191583 | 193334 | 188831 | 191281 | 190833 | 191393 | 191393 | 191393 |
| 2068                 | 191291 | 191583 | 193334 | 188831 | 191281 | 190833 | 191393 | 191393 | 191393 |
| 2069                 | 191291 | 191583 | 193334 | 188831 | 191281 | 190833 | 191393 | 191393 | 191393 |
| 2070                 | 191291 | 191583 | 193334 | 188831 | 191281 | 190833 | 191393 | 191393 | 191393 |
| 2071                 | 191291 | 191583 | 193334 | 188831 | 191281 | 190833 | 191393 | 191393 | 191393 |
| 2072                 | 191291 | 191583 | 193334 | 188831 | 191281 | 190833 | 191393 | 191393 | 191393 |
| 2073                 | 191291 | 191583 | 193334 | 188831 | 191281 | 190833 | 191393 | 191393 | 191393 |
| 2074                 | 191291 | 191583 | 193334 | 188831 | 191281 | 190833 | 191393 | 191393 | 191393 |
| 2075                 | 191291 | 191583 | 193334 | 188831 | 191281 | 190833 | 191393 | 191393 | 191393 |
| 2076                 | 191291 | 191583 | 193334 | 188831 | 191281 | 190833 | 191393 | 191393 | 191393 |
| 2077                 | 191291 | 191583 | 193334 | 188831 | 191281 | 190833 | 191393 | 191393 | 191393 |
| 2078                 | 191291 | 191583 | 193334 | 188831 | 191281 | 190833 | 191393 | 191393 | 191393 |
| 2079                 | 191291 | 191583 | 193334 | 188831 | 191281 | 190833 | 191393 | 191393 | 191393 |
| 2080                 | 191291 | 191583 | 193334 | 188831 | 191281 | 190833 | 191393 | 191393 | 191393 |
| 2081                 | 191291 | 191583 | 193334 | 188831 | 191281 | 190833 | 191393 | 191393 | 191393 |
| 2082                 | 191291 | 191583 | 193334 | 188831 | 191281 | 190833 | 191393 | 191393 | 191393 |
| 2083                 | 191291 | 191583 | 193334 | 188831 | 191281 | 190833 | 191393 | 191393 | 191393 |
| 2084                 | 191291 | 191583 | 193334 | 188831 | 191281 | 190833 | 191393 | 191393 | 191393 |
| 2085                 | 191291 | 191583 | 193334 | 188831 | 191281 | 190833 | 191393 | 191393 | 191393 |
| 2086                 | 191291 | 191583 | 193334 | 188831 | 191281 | 190833 | 191393 | 191393 | 191393 |
| 2087                 | 191291 | 191583 | 193334 | 188831 | 191281 | 190833 | 191393 | 191393 | 191393 |
| 2088                 | 191291 | 191583 | 193334 | 188831 | 191281 | 190833 | 191393 | 191393 | 191393 |
| 2089                 | 191291 | 191583 | 193334 | 188831 | 191281 | 190833 | 191393 | 191393 | 191393 |
| 2090                 | 191291 | 191583 | 193334 | 188831 | 191281 | 190833 | 191393 | 191393 | 191393 |

| ScenarioID / Year | 64     | 65     | 66     | 67     | 68     | 69     | 70     | 71     | 72     |
|-------------------|--------|--------|--------|--------|--------|--------|--------|--------|--------|
| 2002              | 141104 | 141104 | 141104 | 141104 | 141104 | 141104 | 141104 | 141104 | 141104 |
| 2003              | 149233 | 149233 | 149233 | 149233 | 149233 | 149233 | 149233 | 149233 | 149233 |
| 2004              | 157146 | 157146 | 157146 | 157146 | 157146 | 157146 | 157146 | 157146 | 157146 |
| 2005              | 164299 | 164299 | 164299 | 164299 | 164299 | 164299 | 164299 | 164299 | 164299 |
| 2006              | 171496 | 171496 | 171496 | 171496 | 171496 | 171496 | 171496 | 171496 | 171496 |
| 2007              | 178790 | 178790 | 178790 | 178790 | 178790 | 178790 | 178790 | 178790 | 178790 |
| 2008              | 184759 | 184759 | 184759 | 184759 | 184759 | 184759 | 184759 | 184759 | 184759 |
| 2009              | 190596 | 190596 | 190596 | 190596 | 190596 | 190596 | 190596 | 190596 | 190596 |
| 2010              | 195244 | 195244 | 195244 | 195244 | 195244 | 195244 | 195244 | 195244 | 195244 |
| 2011              | 199472 | 199472 | 199472 | 199472 | 199472 | 199472 | 199472 | 199472 | 199472 |
| 2012              | 202694 | 202694 | 202694 | 202694 | 202694 | 202694 | 202694 | 202694 | 202694 |
| 2013              | 206172 | 206172 | 206172 | 206172 | 206172 | 206172 | 206172 | 206172 | 206172 |
| 2014              | 208841 | 208841 | 208841 | 208841 | 208841 | 208841 | 208841 | 208841 | 208841 |
| 2015              | 211298 | 211298 | 211298 | 211298 | 211298 | 211298 | 211298 | 211298 | 211298 |
| 2016              | 213570 | 213570 | 213570 | 213570 | 213570 | 213570 | 213570 | 213570 | 213570 |
| 2017              | 215247 | 215247 | 215247 | 215247 | 215247 | 215247 | 215247 | 215247 | 215247 |
| 2018              | 216679 | 216679 | 216679 | 216679 | 216679 | 216679 | 216679 | 216679 | 216679 |
| 2019              | 217907 | 217907 | 217907 | 217907 | 217907 | 217907 | 217907 | 217907 | 217907 |
| 2020              | 218888 | 218888 | 218888 | 213610 | 218888 | 218888 | 218888 | 218888 | 218888 |
| 2021              | 219755 | 219755 | 219755 | 210610 | 219755 | 219755 | 219755 | 219755 | 219755 |
| 2022              | 220922 | 220922 | 220922 | 208483 | 220922 | 220922 | 220922 | 220922 | 220922 |
| 2023              | 221438 | 221438 | 221438 | 206024 | 221438 | 221438 | 221438 | 221438 | 221438 |
| 2024              | 221835 | 221835 | 221835 | 204038 | 221835 | 221835 | 221835 | 221835 | 221835 |
| 2025              | 216710 | 216710 | 222385 | 201536 | 216710 | 216710 | 216710 | 216710 | 216710 |
| 2026              | 213526 | 213526 | 222873 | 198971 | 213526 | 213526 | 213526 | 213526 | 213526 |
| 2027              | 211559 | 211559 | 223196 | 196703 | 211559 | 211633 | 211559 | 211559 | 211559 |
| 2028              | 208575 | 208575 | 223606 | 194317 | 208575 | 208649 | 208575 | 208575 | 208575 |
| 2029              | 205865 | 205865 | 224093 | 191838 | 205865 | 206005 | 205865 | 205865 | 205865 |
| 2030              | 205055 | 205055 | 220106 | 190200 | 205055 | 205360 | 205055 | 205055 | 205055 |
| 2031              | 202961 | 202981 | 217242 | 188296 | 202907 | 203383 | 202981 | 202981 | 202981 |
| 2032              | 200624 | 200747 | 214940 | 185864 | 200495 | 201131 | 200747 | 200747 | 200747 |
| 2033              | 199232 | 199712 | 213724 | 184252 | 199476 | 200098 | 199586 | 199586 | 199586 |
| 2034              | 198654 | 198904 | 211571 | 182970 | 198545 | 199217 | 198778 | 198778 | 198778 |
| 2035              | 198169 | 198647 | 210820 | 182780 | 197756 | 198591 | 198314 | 198314 | 198314 |
| 2036              | 194073 | 194284 | 206903 | 178742 | 193371 | 194808 | 194181 | 194181 | 194181 |
| 2037              | 192002 | 192211 | 203610 | 176121 | 191380 | 192859 | 192109 | 192109 | 192109 |
| 2038              | 186972 | 187827 | 199883 | 172921 | 185933 | 188961 | 187514 | 187514 | 187514 |
| 2039              | 183224 | 183635 | 196199 | 169218 | 181923 | 185189 | 183651 | 183651 | 183651 |
| 2040              | 179209 | 179711 | 191320 | 169820 | 177762 | 181363 | 179497 | 179497 | 179497 |
| 2041              | 174920 | 176029 | 186959 | 173055 | 174303 | 177248 | 175036 | 175036 | 175036 |
| 2042              | 176679 | 176807 | 182514 | 176332 | 177600 | 176190 | 176856 | 176856 | 176856 |
| 2043              | 180764 | 180892 | 180858 | 179837 | 181509 | 180347 | 180941 | 180941 | 180941 |
| 2044              | 184341 | 184599 | 184861 | 182906 | 184908 | 184132 | 184560 | 184560 | 184560 |
| 2045              | 186466 | 186998 | 187408 | 184868 | 187220 | 186365 | 186916 | 186916 | 186916 |
| 2046              | 188621 | 189241 | 189767 | 186253 | 189137 | 188477 | 189071 | 189071 | 189071 |
| 2047              | 190259 | 191025 | 191932 | 187420 | 190343 | 190279 | 190709 | 190709 | 190709 |
| 2048              | 190789 | 191623 | 192934 | 187527 | 190830 | 190820 | 191239 | 191239 | 191239 |
| 2049              | 190850 | 191663 | 192995 | 187588 | 190891 | 190860 | 191300 | 191300 | 191300 |
| 2050              | 191082 | 191895 | 193227 | 187820 | 191123 | 191087 | 191532 | 191532 | 191532 |
| 2051              | 190936 | 191749 | 193081 | 187674 | 190977 | 190920 | 191386 | 191386 | 191386 |

| ScenarioID /<br>Year | 64     | 65     | 66     | 67     | 68     | 69     | 70     | 71     | 72     |
|----------------------|--------|--------|--------|--------|--------|--------|--------|--------|--------|
| 2052                 | 190998 | 191811 | 193143 | 187736 | 191039 | 190982 | 191448 | 191448 | 191448 |
| 2053                 | 190998 | 191811 | 193143 | 187736 | 191039 | 190982 | 191448 | 191448 | 191448 |
| 2054                 | 191032 | 191845 | 193177 | 187770 | 191073 | 191016 | 191482 | 191482 | 191482 |
| 2055                 | 191083 | 191896 | 193228 | 187821 | 191083 | 191067 | 191533 | 191533 | 191533 |
| 2056                 | 191089 | 191945 | 193275 | 187868 | 191066 | 191177 | 191539 | 191539 | 191539 |
| 2057                 | 191068 | 191924 | 193254 | 187847 | 191066 | 191156 | 191518 | 191518 | 191518 |
| 2058                 | 191068 | 191924 | 193254 | 187847 | 191066 | 191156 | 191518 | 191518 | 191518 |
| 2059                 | 191068 | 191924 | 193254 | 187847 | 191066 | 191156 | 191518 | 191518 | 191518 |
| 2060                 | 191068 | 191924 | 193254 | 187847 | 191066 | 191156 | 191518 | 191518 | 191518 |
| 2061                 | 191068 | 191924 | 193254 | 187847 | 191066 | 191156 | 191518 | 191518 | 191518 |
| 2062                 | 191068 | 191924 | 193254 | 187847 | 191066 | 191156 | 191518 | 191518 | 191518 |
| 2063                 | 191068 | 191924 | 193254 | 187847 | 191066 | 191156 | 191518 | 191518 | 191518 |
| 2064                 | 191068 | 191924 | 193254 | 187847 | 191066 | 191156 | 191518 | 191518 | 191518 |
| 2065                 | 191068 | 191924 | 193254 | 187847 | 191066 | 191156 | 191518 | 191518 | 191518 |
| 2066                 | 191068 | 191924 | 193254 | 187847 | 191066 | 191156 | 191518 | 191518 | 191518 |
| 2067                 | 191068 | 191924 | 193254 | 187847 | 191066 | 191156 | 191518 | 191518 | 191518 |
| 2068                 | 191068 | 191924 | 193254 | 187847 | 191066 | 191156 | 191518 | 191518 | 191518 |
| 2069                 | 191068 | 191924 | 193254 | 187847 | 191066 | 191156 | 191518 | 191518 | 191518 |
| 2070                 | 191068 | 191924 | 193254 | 187847 | 191066 | 191156 | 191518 | 191518 | 191518 |
| 2071                 | 191068 | 191924 | 193254 | 187847 | 191066 | 191156 | 191518 | 191518 | 191518 |
| 2072                 | 191068 | 191924 | 193254 | 187847 | 191066 | 191156 | 191518 | 191518 | 191518 |
| 2073                 | 191068 | 191924 | 193254 | 187847 | 191066 | 191156 | 191518 | 191518 | 191518 |
| 2074                 | 191068 | 191924 | 193254 | 187847 | 191066 | 191156 | 191518 | 191518 | 191518 |
| 2075                 | 191068 | 191924 | 193254 | 187847 | 191066 | 191156 | 191518 | 191518 | 191518 |
| 2076                 | 191068 | 191924 | 193254 | 187847 | 191066 | 191156 | 191518 | 191518 | 191518 |
| 2077                 | 191068 | 191924 | 193254 | 187847 | 191066 | 191156 | 191518 | 191518 | 191518 |
| 2078                 | 191068 | 191924 | 193254 | 187847 | 191066 | 191156 | 191518 | 191518 | 191518 |
| 2079                 | 191068 | 191924 | 193254 | 187847 | 191066 | 191156 | 191518 | 191518 | 191518 |
| 2080                 | 191068 | 191924 | 193254 | 187847 | 191066 | 191156 | 191518 | 191518 | 191518 |
| 2081                 | 191068 | 191924 | 193254 | 187847 | 191066 | 191156 | 191518 | 191518 | 191518 |
| 2082                 | 191068 | 191924 | 193254 | 187847 | 191066 | 191156 | 191518 | 191518 | 191518 |
| 2083                 | 191068 | 191924 | 193254 | 187847 | 191066 | 191156 | 191518 | 191518 | 191518 |
| 2084                 | 191068 | 191924 | 193254 | 187847 | 191066 | 191156 | 191518 | 191518 | 191518 |
| 2085                 | 191068 | 191924 | 193254 | 187847 | 191066 | 191156 | 191518 | 191518 | 191518 |
| 2086                 | 191068 | 191924 | 193254 | 187847 | 191066 | 191156 | 191518 | 191518 | 191518 |
| 2087                 | 191068 | 191924 | 193254 | 187847 | 191066 | 191156 | 191518 | 191518 | 191518 |
| 2088                 | 191068 | 191924 | 193254 | 187847 | 191066 | 191156 | 191518 | 191518 | 191518 |
| 2089                 | 191068 | 191924 | 193254 | 187847 | 191066 | 191156 | 191518 | 191518 | 191518 |
| 2090                 | 191068 | 191924 | 193254 | 187847 | 191066 | 191156 | 191518 | 191518 | 191518 |

| ScenarioID /<br>Year | 73     | 74     | 75     | 76     | 77     | 78     | 79     | 80     | 81     |
|----------------------|--------|--------|--------|--------|--------|--------|--------|--------|--------|
| 2002                 | 141104 | 141104 | 141104 | 141104 | 141104 | 141104 | 141104 | 141104 | 141104 |
| 2003                 | 149233 | 149233 | 149233 | 149233 | 149233 | 149233 | 149233 | 149233 | 149233 |
| 2004                 | 157146 | 157146 | 157146 | 157146 | 157146 | 157146 | 157146 | 157146 | 157146 |
| 2005                 | 164299 | 164299 | 164299 | 164299 | 164299 | 164299 | 164299 | 164299 | 164299 |
| 2006                 | 171496 | 171496 | 171496 | 171496 | 171496 | 171496 | 171496 | 171496 | 171496 |
| 2007                 | 178790 | 178790 | 178790 | 178790 | 178790 | 178790 | 178790 | 178790 | 178790 |
| 2008                 | 184759 | 184759 | 184759 | 184759 | 184759 | 184759 | 184759 | 184759 | 184759 |
| 2009                 | 190596 | 190596 | 190596 | 190596 | 190596 | 190596 | 190596 | 190596 | 190596 |
| 2010                 | 195244 | 195244 | 195244 | 195244 | 195244 | 195244 | 195244 | 195244 | 195244 |
| 2011                 | 199472 | 199472 | 199472 | 199472 | 199472 | 199472 | 199472 | 199472 | 199472 |
| 2012                 | 202694 | 202694 | 202694 | 202694 | 202694 | 202694 | 202694 | 202694 | 202694 |
| 2013                 | 206172 | 206172 | 206172 | 206172 | 206172 | 206172 | 206172 | 206172 | 206172 |
| 2014                 | 208841 | 208841 | 208841 | 208841 | 208841 | 208841 | 208841 | 208841 | 208841 |
| 2015                 | 211298 | 211298 | 211298 | 211298 | 211298 | 211298 | 211298 | 211298 | 211298 |
| 2016                 | 213570 | 213570 | 213570 | 213570 | 213570 | 213570 | 213570 | 213570 | 213570 |
| 2017                 | 215247 | 215247 | 215247 | 215247 | 215247 | 215247 | 215247 | 215247 | 215247 |
| 2018                 | 216679 | 216679 | 216679 | 216679 | 216679 | 216679 | 216679 | 216679 | 216679 |
| 2019                 | 217907 | 217907 | 217907 | 217907 | 217907 | 217907 | 217907 | 217907 | 217907 |
| 2020                 | 218888 | 218888 | 218888 | 213610 | 218888 | 218888 | 218888 | 218888 | 218888 |
| 2021                 | 219755 | 219755 | 219755 | 210610 | 219755 | 219755 | 219755 | 219755 | 219755 |
| 2022                 | 220922 | 220922 | 220922 | 208483 | 220922 | 220922 | 220922 | 220922 | 220922 |
| 2023                 | 221438 | 221438 | 221438 | 206024 | 221438 | 221438 | 221438 | 221438 | 221438 |
| 2024                 | 221835 | 221835 | 221835 | 203954 | 221835 | 221835 | 221835 | 221835 | 221835 |
| 2025                 | 216710 | 216710 | 222385 | 201452 | 216710 | 216710 | 216710 | 216710 | 216710 |
| 2026                 | 213526 | 213526 | 222873 | 198867 | 213526 | 213526 | 213526 | 213526 | 213526 |
| 2027                 | 211559 | 211559 | 223196 | 196528 | 211559 | 211559 | 211559 | 211559 | 211559 |
| 2028                 | 208575 | 208575 | 223606 | 194442 | 208575 | 208575 | 208575 | 208575 | 208575 |
| 2029                 | 205865 | 205865 | 224093 | 191618 | 205865 | 205865 | 205865 | 205865 | 205865 |
| 2030                 | 205055 | 205055 | 220106 | 190208 | 205055 | 205094 | 205055 | 205055 | 205055 |
| 2031                 | 202961 | 202981 | 217242 | 188406 | 202907 | 203044 | 202981 | 202981 | 202981 |
| 2032                 | 200622 | 200747 | 214940 | 186058 | 200495 | 200955 | 200747 | 200747 | 200747 |
| 2033                 | 199503 | 199712 | 213724 | 184276 | 199476 | 200104 | 199586 | 199586 | 199586 |
| 2034                 | 198573 | 198783 | 211697 | 182764 | 198545 | 199321 | 198657 | 198657 | 198657 |
| 2035                 | 197837 | 198047 | 210946 | 182448 | 197672 | 198946 | 197763 | 197763 | 197763 |
| 2036                 | 193445 | 193655 | 207029 | 178504 | 193287 | 194597 | 193350 | 193350 | 193350 |
| 2037                 | 191226 | 191515 | 203792 | 175747 | 191296 | 192606 | 191439 | 191439 | 191439 |
| 2038                 | 185735 | 186254 | 199689 | 171867 | 185806 | 188230 | 185948 | 185948 | 185948 |
| 2039                 | 181707 | 182014 | 196033 | 167399 | 181797 | 184168 | 181940 | 181940 | 181940 |
| 2040                 | 177602 | 177835 | 191363 | 170639 | 177607 | 179885 | 177818 | 177818 | 177818 |
| 2041                 | 174024 | 174373 | 186708 | 173874 | 174383 | 175361 | 174165 | 174165 | 174165 |
| 2042                 | 177321 | 177670 | 182263 | 177171 | 177680 | 176672 | 177462 | 177462 | 177462 |
| 2043                 | 181371 | 181579 | 180893 | 180675 | 181545 | 180757 | 181415 | 181415 | 181415 |
| 2044                 | 184849 | 184934 | 184896 | 183797 | 184856 | 184506 | 184902 | 184902 | 184902 |
| 2045                 | 187248 | 187246 | 187377 | 185805 | 187168 | 186717 | 187214 | 187214 | 187214 |
| 2046                 | 189016 | 189119 | 189736 | 186768 | 189041 | 188655 | 189175 | 189175 | 189175 |
| 2047                 | 190410 | 190450 | 191707 | 187731 | 190363 | 190417 | 190550 | 190550 | 190550 |
| 2048                 | 190969 | 190937 | 192782 | 187741 | 190771 | 190725 | 191081 | 191081 | 191081 |
| 2049                 | 191030 | 190998 | 192844 | 187758 | 190832 | 190786 | 191142 | 191142 | 191142 |
| 2050                 | 191262 | 191230 | 193076 | 187990 | 191064 | 191013 | 191374 | 191374 | 191374 |
| 2051                 | 191116 | 191084 | 192930 | 187844 | 190918 | 190846 | 191228 | 191228 | 191228 |

| ScenarioID /<br>Year | 73     | 74     | 75     | 76     | 77     | 78     | 79     | 80     | 81     |
|----------------------|--------|--------|--------|--------|--------|--------|--------|--------|--------|
| 2052                 | 191178 | 191146 | 192992 | 187906 | 190980 | 190908 | 191290 | 191290 | 191290 |
| 2053                 | 191178 | 191146 | 192992 | 187906 | 190980 | 190908 | 191290 | 191290 | 191290 |
| 2054                 | 191212 | 191180 | 193026 | 187940 | 191014 | 190942 | 191324 | 191324 | 191324 |
| 2055                 | 191222 | 191190 | 193077 | 187950 | 191024 | 190993 | 191334 | 191334 | 191334 |
| 2056                 | 191205 | 191173 | 193124 | 187933 | 191007 | 191019 | 191317 | 191317 | 191317 |
| 2057                 | 191205 | 191173 | 193103 | 187933 | 191007 | 190998 | 191317 | 191317 | 191317 |
| 2058                 | 191205 | 191173 | 193103 | 187933 | 191007 | 190998 | 191317 | 191317 | 191317 |
| 2059                 | 191205 | 191173 | 193103 | 187933 | 191007 | 190998 | 191317 | 191317 | 191317 |
| 2060                 | 191205 | 191173 | 193103 | 187933 | 191007 | 190998 | 191317 | 191317 | 191317 |
| 2061                 | 191205 | 191173 | 193103 | 187933 | 191007 | 190998 | 191317 | 191317 | 191317 |
| 2062                 | 191205 | 191173 | 193103 | 187933 | 191007 | 190998 | 191317 | 191317 | 191317 |
| 2063                 | 191205 | 191173 | 193103 | 187933 | 191007 | 190998 | 191317 | 191317 | 191317 |
| 2064                 | 191205 | 191173 | 193103 | 187933 | 191007 | 190998 | 191317 | 191317 | 191317 |
| 2065                 | 191205 | 191173 | 193103 | 187933 | 191007 | 190998 | 191317 | 191317 | 191317 |
| 2066                 | 191205 | 191173 | 193103 | 187933 | 191007 | 190998 | 191317 | 191317 | 191317 |
| 2067                 | 191205 | 191173 | 193103 | 187933 | 191007 | 190998 | 191317 | 191317 | 191317 |
| 2068                 | 191205 | 191173 | 193103 | 187933 | 191007 | 190998 | 191317 | 191317 | 191317 |
| 2069                 | 191205 | 191173 | 193103 | 187933 | 191007 | 190998 | 191317 | 191317 | 191317 |
| 2070                 | 191205 | 191173 | 193103 | 187933 | 191007 | 190998 | 191317 | 191317 | 191317 |
| 2071                 | 191205 | 191173 | 193103 | 187933 | 191007 | 190998 | 191317 | 191317 | 191317 |
| 2072                 | 191205 | 191173 | 193103 | 187933 | 191007 | 190998 | 191317 | 191317 | 191317 |
| 2073                 | 191205 | 191173 | 193103 | 187933 | 191007 | 190998 | 191317 | 191317 | 191317 |
| 2074                 | 191205 | 191173 | 193103 | 187933 | 191007 | 190998 | 191317 | 191317 | 191317 |
| 2075                 | 191205 | 191173 | 193103 | 187933 | 191007 | 190998 | 191317 | 191317 | 191317 |
| 2076                 | 191205 | 191173 | 193103 | 187933 | 191007 | 190998 | 191317 | 191317 | 191317 |
| 2077                 | 191205 | 191173 | 193103 | 187933 | 191007 | 190998 | 191317 | 191317 | 191317 |
| 2078                 | 191205 | 191173 | 193103 | 187933 | 191007 | 190998 | 191317 | 191317 | 191317 |
| 2079                 | 191205 | 191173 | 193103 | 187933 | 191007 | 190998 | 191317 | 191317 | 191317 |
| 2080                 | 191205 | 191173 | 193103 | 187933 | 191007 | 190998 | 191317 | 191317 | 191317 |
| 2081                 | 191205 | 191173 | 193103 | 187933 | 191007 | 190998 | 191317 | 191317 | 191317 |
| 2082                 | 191205 | 191173 | 193103 | 187933 | 191007 | 190998 | 191317 | 191317 | 191317 |
| 2083                 | 191205 | 191173 | 193103 | 187933 | 191007 | 190998 | 191317 | 191317 | 191317 |
| 2084                 | 191205 | 191173 | 193103 | 187933 | 191007 | 190998 | 191317 | 191317 | 191317 |
| 2085                 | 191205 | 191173 | 193103 | 187933 | 191007 | 190998 | 191317 | 191317 | 191317 |
| 2086                 | 191205 | 191173 | 193103 | 187933 | 191007 | 190998 | 191317 | 191317 | 191317 |
| 2087                 | 191205 | 191173 | 193103 | 187933 | 191007 | 190998 | 191317 | 191317 | 191317 |
| 2088                 | 191205 | 191173 | 193103 | 187933 | 191007 | 190998 | 191317 | 191317 | 191317 |
| 2089                 | 191205 | 191173 | 193103 | 187933 | 191007 | 190998 | 191317 | 191317 | 191317 |
| 2090                 | 191205 | 191173 | 193103 | 187933 | 191007 | 190998 | 191317 | 191317 | 191317 |

| ScenarioID / Year | 1   | 2   | 3   | 4   | 5   | 6   | 7   | 8   | 9   | 10  | 11  | 12  | 13  | 14  |
|-------------------|-----|-----|-----|-----|-----|-----|-----|-----|-----|-----|-----|-----|-----|-----|
| 2002              | 0   | 0   | 0   | 0   | 0   | 0   | 0   | 0   | 0   | 0   | 0   | 0   | 0   | 0   |
| 2003              | 0   | 0   | 0   | 0   | 0   | 0   | 0   | 0   | 0   | 0   | 0   | 0   | 0   | 0   |
| 2004              | 0   | 0   | 0   | 0   | 0   | 0   | 0   | 0   | 0   | 0   | 0   | 0   | 0   | 0   |
| 2005              | 0   | 0   | 0   | 0   | 0   | 0   | 0   | 0   | 0   | 0   | 0   | 0   | 0   | 0   |
| 2006              | 0   | 0   | 0   | 0   | 0   | 0   | 0   | 0   | 0   | 0   | 0   | 0   | 0   | 0   |
| 2007              | 0   | 0   | 0   | 0   | 0   | 0   | 0   | 0   | 0   | 0   | 0   | 0   | 0   | 0   |
| 2008              | 0   | 0   | 0   | 0   | 0   | 0   | 0   | 0   | 0   | 0   | 0   | 0   | 0   | 0   |
| 2009              | 0   | 0   | 0   | 0   | 0   | 0   | 0   | 0   | 0   | 0   | 0   | 0   | 0   | 0   |
| 2010              | 0   | 0   | 0   | 0   | 0   | 0   | 0   | 0   | 0   | 0   | 0   | 0   | 0   | 0   |
| 2011              | 0   | 0   | 0   | 0   | 0   | 0   | 0   | 0   | 0   | 0   | 0   | 0   | 0   | 0   |
| 2012              | 0   | 0   | 0   | 0   | 0   | 0   | 0   | 0   | 0   | 0   | 0   | 0   | 0   | 0   |
| 2013              | 0   | 0   | 0   | 0   | 0   | 0   | 0   | 0   | 0   | 0   | 0   | 0   | 0   | 0   |
| 2014              | 0   | 0   | 0   | 0   | 0   | 0   | 0   | 0   | 0   | 0   | 0   | 0   | 0   | 0   |
| 2015              | 0   | 0   | 0   | 0   | 0   | 0   | 0   | 0   | 0   | 0   | 0   | 0   | 0   | 0   |
| 2016              | 0   | 0   | 0   | 0   | 0   | 0   | 0   | 0   | 0   | 0   | 0   | 0   | 0   | 0   |
| 2017              | 0   | 0   | 0   | 0   | 0   | 0   | 0   | 0   | 0   | 0   | 0   | 0   | 0   | 0   |
| 2018              | 0   | 0   | 0   | 0   | 0   | 0   | 0   | 0   | 0   | 0   | 0   | 0   | 0   | 0   |
| 2019              | 0   | 0   | 0   | 0   | 0   | 0   | 0   | 0   | 0   | 0   | 0   | 0   | 0   | 0   |
| 2020              | 0   | 0   | 0   | 266 | 0   | 0   | 0   | 0   | 0   | 0   | 0   | 0   | 266 | 0   |
| 2021              | 0   | 0   | 0   | 295 | 0   | 0   | 0   | 0   | 0   | 0   | 0   | 0   | 295 | 0   |
| 2022              | 0   | 0   | 0   | 288 | 0   | 0   | 0   | 0   | 0   | 0   | 0   | 0   | 288 | 0   |
| 2023              | 0   | 0   | 0   | 297 | 0   | 0   | 0   | 0   | 0   | 0   | 0   | 0   | 297 | 0   |
| 2024              | 0   | 0   | 0   | 295 | 0   | 0   | 0   | 0   | 0   | 0   | 0   | 0   | 295 | 0   |
| 2025              | 266 | 266 | 0   | 304 | 266 | 266 | 266 | 266 | 266 | 266 | 266 | 0   | 304 | 266 |
| 2026              | 295 | 295 | 0   | 310 | 295 | 295 | 295 | 295 | 295 | 295 | 295 | 0   | 310 | 295 |
| 2027              | 288 | 288 | 0   | 295 | 288 | 288 | 288 | 288 | 288 | 288 | 288 | 0   | 295 | 288 |
| 2028              | 297 | 297 | 0   | 310 | 297 | 297 | 297 | 297 | 297 | 297 | 297 | 0   | 310 | 297 |
| 2029              | 295 | 295 | 0   | 302 | 295 | 295 | 295 | 295 | 295 | 295 | 295 | 0   | 302 | 295 |
| 2030              | 304 | 304 | 266 | 302 | 304 | 304 | 304 | 304 | 304 | 304 | 304 | 266 | 302 | 304 |
| 2031              | 310 | 310 | 295 | 304 | 310 | 310 | 310 | 310 | 310 | 310 | 310 | 295 | 304 | 310 |
| 2032              | 295 | 295 | 288 | 307 | 295 | 295 | 295 | 295 | 295 | 295 | 295 | 288 | 307 | 295 |
| 2033              | 310 | 310 | 297 | 302 | 310 | 310 | 310 | 310 | 310 | 310 | 310 | 297 | 302 | 310 |
| 2034              | 302 | 302 | 295 | 303 | 302 | 302 | 302 | 302 | 302 | 302 | 302 | 295 | 303 | 302 |
| 2035              | 302 | 302 | 304 | 302 | 302 | 302 | 302 | 302 | 302 | 302 | 302 | 304 | 296 | 302 |
| 2036              | 304 | 304 | 310 | 306 | 304 | 304 | 304 | 304 | 304 | 304 | 304 | 310 | 299 | 304 |
| 2037              | 307 | 307 | 295 | 299 | 307 | 307 | 307 | 307 | 307 | 307 | 307 | 295 | 293 | 307 |
| 2038              | 302 | 302 | 310 | 253 | 302 | 302 | 302 | 302 | 302 | 302 | 302 | 310 | 237 | 302 |
| 2039              | 303 | 303 | 302 | 219 | 303 | 303 | 303 | 303 | 303 | 303 | 303 | 302 | 180 | 303 |
| 2040              | 285 | 285 | 302 | 120 | 285 | 285 | 285 | 285 | 285 | 280 | 284 | 302 | 0   | 284 |
| 2041              | 276 | 284 | 304 | 0   | 286 | 281 | 284 | 284 | 284 | 259 | 282 | 304 | 0   | 282 |
| 2042              | 238 | 268 | 291 | 0   | 268 | 257 | 268 | 268 | 268 | 192 | 271 | 307 | 0   | 270 |
| 2043              | 158 | 265 | 284 | 0   | 268 | 259 | 264 | 264 | 264 | 101 | 257 | 284 | 0   | 253 |
| 2044              | 77  | 254 | 283 | 0   | 241 | 188 | 232 | 232 | 232 | 0   | 249 | 287 | 0   | 198 |
| 2045              | 0   | 245 | 286 | 0   | 208 | 149 | 176 | 176 | 176 | 0   | 210 | 288 | 0   | 137 |
| 2046              | 0   | 225 | 278 | 0   | 131 | 97  | 123 | 123 | 123 | 0   | 179 | 285 | 0   | 87  |
| 2047              | 0   | 176 | 258 | 0   | 78  | 0   | 72  | 72  | 72  | 0   | 114 | 268 | 0   | 46  |
| 2048              | 0   | 110 | 263 | 0   | 0   | 0   | 0   | 0   | 0   | 0   | 66  | 248 | 0   | 0   |
| 2049              | 0   | 72  | 220 | 0   | 0   | 0   | 0   | 0   | 0   | 0   | 45  | 223 | 0   | 0   |
| 2050              | 0   | 0   | 223 | 0   | 0   | 0   | 0   | 0   | 0   | 0   | 34  | 182 | 0   | 0   |
| 2051              | 0   | 0   | 172 | 0   | 0   | 0   | 0   | 0   | 0   | 0   | 0   | 161 | 0   | 0   |



| ScenarioID /<br>Year | 1 | 2 | 3   | 4 | 5 | 6  | 7 | 8 | 9 | 10 | 11 | 12  | 13 | 14 |
|----------------------|---|---|-----|---|---|----|---|---|---|----|----|-----|----|----|
| 2052                 | 0 | 0 | 111 | 0 | 0 | 16 | 0 | 0 | 0 | 0  | 0  | 125 | 0  | 0  |
| 2053                 | 0 | 0 | 52  | 0 | 0 | 0  | 0 | 0 | 0 | 0  | 0  | 73  | 0  | 0  |
| 2054                 | 0 | 0 | 0   | 0 | 0 | 0  | 0 | 0 | 0 | 0  | 0  | 0   | 0  | 0  |
| 2055                 | 0 | 0 | 0   | 0 | 0 | 0  | 0 | 0 | 0 | 0  | 0  | 0   | 0  | 0  |
| 2056                 | 0 | 0 | 0   | 0 | 0 | 0  | 0 | 0 | 0 | 0  | 0  | 0   | 0  | 0  |
| 2057                 | 0 | 0 | 0   | 0 | 0 | 0  | 0 | 0 | 0 | 0  | 0  | 0   | 0  | 0  |
| 2058                 | 0 | 0 | 0   | 0 | 0 | 0  | 0 | 0 | 0 | 0  | 0  | 0   | 0  | 0  |
| 2059                 | 0 | 0 | 0   | 0 | 0 | 0  | 0 | 0 | 0 | 0  | 0  | 0   | 0  | 0  |
| 2060                 | 0 | 0 | 0   | 0 | 0 | 0  | 0 | 0 | 0 | 0  | 0  | 0   | 0  | 0  |
| 2061                 | 0 | 0 | 0   | 0 | 0 | 0  | 0 | 0 | 0 | 0  | 0  | 0   | 0  | 0  |
| 2062                 | 0 | 0 | 0   | 0 | 0 | 0  | 0 | 0 | 0 | 0  | 0  | 0   | 0  | 0  |
| 2063                 | 0 | 0 | 0   | 0 | 0 | 0  | 0 | 0 | 0 | 0  | 0  | 0   | 0  | 0  |
| 2064                 | 0 | 0 | 0   | 0 | 0 | 0  | 0 | 0 | 0 | 0  | 0  | 0   | 0  | 0  |
| 2065                 | 0 | 0 | 0   | 0 | 0 | 0  | 0 | 0 | 0 | 0  | 0  | 0   | 0  | 0  |
| 2066                 | 0 | 0 | 0   | 0 | 0 | 0  | 0 | 0 | 0 | 0  | 0  | 0   | 0  | 0  |
| 2067                 | 0 | 0 | 0   | 0 | 0 | 0  | 0 | 0 | 0 | 0  | 0  | 0   | 0  | 0  |
| 2068                 | 0 | 0 | 0   | 0 | 0 | 0  | 0 | 0 | 0 | 0  | 0  | 0   | 0  | 0  |
| 2069                 | 0 | 0 | 0   | 0 | 0 | 0  | 0 | 0 | 0 | 0  | 0  | 0   | 0  | 0  |
| 2070                 | 0 | 0 | 0   | 0 | 0 | 0  | 0 | 0 | 0 | 0  | 0  | 0   | 0  | 0  |
| 2071                 | 0 | 0 | 0   | 0 | 0 | 0  | 0 | 0 | 0 | 0  | 0  | 0   | 0  | 0  |
| 2072                 | 0 | 0 | 0   | 0 | 0 | 0  | 0 | 0 | 0 | 0  | 0  | 0   | 0  | 0  |
| 2073                 | 0 | 0 | 0   | 0 | 0 | 0  | 0 | 0 | 0 | 0  | 0  | 0   | 0  | 0  |
| 2074                 | 0 | 0 | 0   | 0 | 0 | 0  | 0 | 0 | 0 | 0  | 0  | 0   | 0  | 0  |
| 2075                 | 0 | 0 | 0   | 0 | 0 | 0  | 0 | 0 | 0 | 0  | 0  | 0   | 0  | 0  |
| 2076                 | 0 | 0 | 0   | 0 | 0 | 0  | 0 | 0 | 0 | 0  | 0  | 0   | 0  | 0  |
| 2077                 | 0 | 0 | 0   | 0 | 0 | 0  | 0 | 0 | 0 | 0  | 0  | 0   | 0  | 0  |
| 2078                 | 0 | 0 | 0   | 0 | 0 | 0  | 0 | 0 | 0 | 0  | 0  | 0   | 0  | 0  |
| 2079                 | 0 | 0 | 0   | 0 | 0 | 0  | 0 | 0 | 0 | 0  | 0  | 0   | 0  | 0  |
| 2080                 | 0 | 0 | 0   | 0 | 0 | 0  | 0 | 0 | 0 | 0  | 0  | 0   | 0  | 0  |
| 2081                 | 0 | 0 | 0   | 0 | 0 | 0  | 0 | 0 | 0 | 0  | 0  | 0   | 0  | 0  |
| 2082                 | 0 | 0 | 0   | 0 | 0 | 0  | 0 | 0 | 0 | 0  | 0  | 0   | 0  | 0  |
| 2083                 | 0 | 0 | 0   | 0 | 0 | 0  | 0 | 0 | 0 | 0  | 0  | 0   | 0  | 0  |
| 2084                 | 0 | 0 | 0   | 0 | 0 | 0  | 0 | 0 | 0 | 0  | 0  | 0   | 0  | 0  |
| 2085                 | 0 | 0 | 0   | 0 | 0 | 0  | 0 | 0 | 0 | 0  | 0  | 0   | 0  | 0  |
| 2086                 | 0 | 0 | 0   | 0 | 0 | 0  | 0 | 0 | 0 | 0  | 0  | 0   | 0  | 0  |
| 2087                 | 0 | 0 | 0   | 0 | 0 | 0  | 0 | 0 | 0 | 0  | 0  | 0   | 0  | 0  |
| 2088                 | 0 | 0 | 0   | 0 | 0 | 0  | 0 | 0 | 0 | 0  | 0  | 0   | 0  | 0  |
| 2089                 | 0 | 0 | 0   | 0 | 0 | 0  | 0 | 0 | 0 | 0  | 0  | 0   | 0  | 0  |
| 2090                 | 0 | 0 | 0   | 0 | 0 | 0  | 0 | 0 | 0 | 0  | 0  | 0   | 0  | 0  |

| ScenarioID /<br>Year | 15  | 16  | 17  | 18  | 19  | 20  | 21  | 22  | 23  | 24  | 25  | 26  | 27  | 28  |
|----------------------|-----|-----|-----|-----|-----|-----|-----|-----|-----|-----|-----|-----|-----|-----|
| 2002                 | 0   | 0   | 0   | 0   | 0   | 0   | 0   | 0   | 0   | 0   | 0   | 0   | 0   | 0   |
| 2003                 | 0   | 0   | 0   | 0   | 0   | 0   | 0   | 0   | 0   | 0   | 0   | 0   | 0   | 0   |
| 2004                 | 0   | 0   | 0   | 0   | 0   | 0   | 0   | 0   | 0   | 0   | 0   | 0   | 0   | 0   |
| 2005                 | 0   | 0   | 0   | 0   | 0   | 0   | 0   | 0   | 0   | 0   | 0   | 0   | 0   | 0   |
| 2006                 | 0   | 0   | 0   | 0   | 0   | 0   | 0   | 0   | 0   | 0   | 0   | 0   | 0   | 0   |
| 2007                 | 0   | 0   | 0   | 0   | 0   | 0   | 0   | 0   | 0   | 0   | 0   | 0   | 0   | 0   |
| 2008                 | 0   | 0   | 0   | 0   | 0   | 0   | 0   | 0   | 0   | 0   | 0   | 0   | 0   | 0   |
| 2009                 | 0   | 0   | 0   | 0   | 0   | 0   | 0   | 0   | 0   | 0   | 0   | 0   | 0   | 0   |
| 2010                 | 0   | 0   | 0   | 0   | 0   | 0   | 0   | 0   | 0   | 0   | 0   | 0   | 0   | 0   |
| 2011                 | 0   | 0   | 0   | 0   | 0   | 0   | 0   | 0   | 0   | 0   | 0   | 0   | 0   | 0   |
| 2012                 | 0   | 0   | 0   | 0   | 0   | 0   | 0   | 0   | 0   | 0   | 0   | 0   | 0   | 0   |
| 2013                 | 0   | 0   | 0   | 0   | 0   | 0   | 0   | 0   | 0   | 0   | 0   | 0   | 0   | 0   |
| 2014                 | 0   | 0   | 0   | 0   | 0   | 0   | 0   | 0   | 0   | 0   | 0   | 0   | 0   | 0   |
| 2015                 | 0   | 0   | 0   | 0   | 0   | 0   | 0   | 0   | 0   | 0   | 0   | 0   | 0   | 0   |
| 2016                 | 0   | 0   | 0   | 0   | 0   | 0   | 0   | 0   | 0   | 0   | 0   | 0   | 0   | 0   |
| 2017                 | 0   | 0   | 0   | 0   | 0   | 0   | 0   | 0   | 0   | 0   | 0   | 0   | 0   | 0   |
| 2018                 | 0   | 0   | 0   | 0   | 0   | 0   | 0   | 0   | 0   | 0   | 0   | 0   | 0   | 0   |
| 2019                 | 0   | 0   | 0   | 0   | 0   | 0   | 0   | 0   | 0   | 0   | 0   | 0   | 0   | 0   |
| 2020                 | 0   | 0   | 0   | 0   | 0   | 0   | 0   | 266 | 0   | 0   | 0   | 0   | 0   | 0   |
| 2021                 | 0   | 0   | 0   | 0   | 0   | 0   | 0   | 295 | 0   | 0   | 0   | 0   | 0   | 0   |
| 2022                 | 0   | 0   | 0   | 0   | 0   | 0   | 0   | 288 | 0   | 0   | 0   | 0   | 0   | 0   |
| 2023                 | 0   | 0   | 0   | 0   | 0   | 0   | 0   | 297 | 0   | 0   | 0   | 0   | 0   | 0   |
| 2024                 | 0   | 0   | 0   | 0   | 0   | 0   | 0   | 295 | 0   | 0   | 0   | 0   | 0   | 0   |
| 2025                 | 266 | 266 | 266 | 266 | 266 | 266 | 0   | 304 | 266 | 266 | 266 | 266 | 266 | 300 |
| 2026                 | 295 | 295 | 295 | 295 | 295 | 295 | 0   | 310 | 295 | 295 | 295 | 295 | 295 | 300 |
| 2027                 | 288 | 288 | 288 | 288 | 288 | 288 | 0   | 295 | 288 | 288 | 288 | 288 | 288 | 300 |
| 2028                 | 297 | 297 | 297 | 297 | 297 | 297 | 0   | 310 | 297 | 297 | 297 | 297 | 297 | 300 |
| 2029                 | 295 | 295 | 295 | 295 | 295 | 295 | 0   | 302 | 295 | 295 | 295 | 295 | 295 | 300 |
| 2030                 | 304 | 304 | 304 | 304 | 304 | 304 | 266 | 302 | 304 | 304 | 304 | 304 | 304 | 300 |
| 2031                 | 310 | 310 | 310 | 310 | 310 | 310 | 295 | 304 | 310 | 310 | 310 | 310 | 310 | 300 |
| 2032                 | 295 | 295 | 295 | 295 | 295 | 295 | 288 | 307 | 295 | 295 | 295 | 295 | 295 | 300 |
| 2033                 | 310 | 310 | 310 | 310 | 310 | 310 | 297 | 302 | 310 | 310 | 310 | 310 | 310 | 300 |
| 2034                 | 302 | 302 | 302 | 302 | 302 | 302 | 295 | 303 | 302 | 302 | 302 | 302 | 302 | 300 |
| 2035                 | 302 | 302 | 302 | 302 | 302 | 302 | 304 | 302 | 302 | 302 | 302 | 302 | 302 | 300 |
| 2036                 | 304 | 304 | 304 | 304 | 304 | 304 | 310 | 306 | 304 | 304 | 304 | 304 | 304 | 300 |
| 2037                 | 307 | 307 | 307 | 307 | 307 | 307 | 295 | 299 | 307 | 307 | 307 | 307 | 307 | 300 |
| 2038                 | 302 | 302 | 302 | 302 | 302 | 302 | 310 | 264 | 302 | 302 | 302 | 302 | 302 | 300 |
| 2039                 | 303 | 303 | 303 | 303 | 303 | 303 | 302 | 219 | 303 | 303 | 303 | 303 | 303 | 300 |
| 2040                 | 284 | 284 | 284 | 284 | 281 | 284 | 302 | 96  | 284 | 284 | 284 | 284 | 284 | 300 |
| 2041                 | 270 | 275 | 275 | 275 | 263 | 282 | 304 | 0   | 282 | 270 | 282 | 282 | 282 | 300 |
| 2042                 | 249 | 261 | 261 | 261 | 216 | 271 | 291 | 0   | 270 | 257 | 265 | 265 | 265 | 300 |
| 2043                 | 222 | 244 | 244 | 244 | 142 | 263 | 284 | 0   | 258 | 231 | 250 | 250 | 250 | 300 |
| 2044                 | 155 | 178 | 178 | 178 | 54  | 252 | 274 | 0   | 219 | 173 | 207 | 207 | 207 | 300 |
| 2045                 | 104 | 124 | 124 | 124 | 21  | 213 | 284 | 0   | 175 | 125 | 157 | 157 | 157 | 300 |
| 2046                 | 53  | 76  | 76  | 76  | 0   | 186 | 282 | 0   | 115 | 68  | 100 | 100 | 100 | 300 |
| 2047                 | 21  | 42  | 42  | 42  | 0   | 157 | 266 | 0   | 59  | 29  | 48  | 48  | 48  | 300 |
| 2048                 | 0   | 0   | 0   | 0   | 0   | 86  | 249 | 0   | 0   | 0   | 0   | 0   | 0   | 300 |
| 2049                 | 0   | 0   | 0   | 0   | 0   | 56  | 197 | 0   | 0   | 0   | 0   | 0   | 0   | 300 |
| 2050                 | 0   | 0   | 0   | 0   | 0   | 34  | 183 | 0   | 0   | 0   | 0   | 0   | 0   | 300 |
| 2051                 | 0   | 0   | 0   | 0   | 0   | 0   | 165 | 0   | 0   | 0   | 0   | 0   | 0   | 300 |

| ScenarioID /<br>Year | 15 | 16 | 17 | 18 | 19 | 20 | 21 | 22 | 23 | 24 | 25 | 26 | 27 | 28  |
|----------------------|----|----|----|----|----|----|----|----|----|----|----|----|----|-----|
| 2052                 | 0  | 0  | 0  | 0  | 0  | 0  | 95 | 0  | 0  | 0  | 0  | 0  | 0  | 300 |
| 2053                 | 0  | 0  | 0  | 0  | 0  | 0  | 59 | 0  | 0  | 0  | 0  | 0  | 0  | 300 |
| 2054                 | 0  | 0  | 0  | 0  | 0  | 0  | 28 | 0  | 0  | 0  | 0  | 0  | 0  | 300 |
| 2055                 | 0  | 0  | 0  | 0  | 0  | 0  | 0  | 0  | 0  | 0  | 0  | 0  | 0  | 300 |
| 2056                 | 0  | 0  | 0  | 0  | 0  | 0  | 0  | 0  | 0  | 0  | 0  | 0  | 0  | 300 |
| 2057                 | 0  | 0  | 0  | 0  | 0  | 0  | 0  | 0  | 0  | 0  | 0  | 0  | 0  | 300 |
| 2058                 | 0  | 0  | 0  | 0  | 0  | 0  | 0  | 0  | 0  | 0  | 0  | 0  | 0  | 289 |
| 2059                 | 0  | 0  | 0  | 0  | 0  | 0  | 0  | 0  | 0  | 0  | 0  | 0  | 0  | 198 |
| 2060                 | 0  | 0  | 0  | 0  | 0  | 0  | 0  | 0  | 0  | 0  | 0  | 0  | 0  | 156 |
| 2061                 | 0  | 0  | 0  | 0  | 0  | 0  | 0  | 0  | 0  | 0  | 0  | 0  | 0  | 167 |
| 2062                 | 0  | 0  | 0  | 0  | 0  | 0  | 0  | 0  | 0  | 0  | 0  | 0  | 0  | 154 |
| 2063                 | 0  | 0  | 0  | 0  | 0  | 0  | 0  | 0  | 0  | 0  | 0  | 0  | 0  | 147 |
| 2064                 | 0  | 0  | 0  | 0  | 0  | 0  | 0  | 0  | 0  | 0  | 0  | 0  | 0  | 138 |
| 2065                 | 0  | 0  | 0  | 0  | 0  | 0  | 0  | 0  | 0  | 0  | 0  | 0  | 0  | 154 |
| 2066                 | 0  | 0  | 0  | 0  | 0  | 0  | 0  | 0  | 0  | 0  | 0  | 0  | 0  | 122 |
| 2067                 | 0  | 0  | 0  | 0  | 0  | 0  | 0  | 0  | 0  | 0  | 0  | 0  | 0  | 116 |
| 2068                 | 0  | 0  | 0  | 0  | 0  | 0  | 0  | 0  | 0  | 0  | 0  | 0  | 0  | 113 |
| 2069                 | 0  | 0  | 0  | 0  | 0  | 0  | 0  | 0  | 0  | 0  | 0  | 0  | 0  | 108 |
| 2070                 | 0  | 0  | 0  | 0  | 0  | 0  | 0  | 0  | 0  | 0  | 0  | 0  | 0  | 102 |
| 2071                 | 0  | 0  | 0  | 0  | 0  | 0  | 0  | 0  | 0  | 0  | 0  | 0  | 0  | 102 |
| 2072                 | 0  | 0  | 0  | 0  | 0  | 0  | 0  | 0  | 0  | 0  | 0  | 0  | 0  | 102 |
| 2073                 | 0  | 0  | 0  | 0  | 0  | 0  | 0  | 0  | 0  | 0  | 0  | 0  | 0  | 102 |
| 2074                 | 0  | 0  | 0  | 0  | 0  | 0  | 0  | 0  | 0  | 0  | 0  | 0  | 0  | 102 |
| 2075                 | 0  | 0  | 0  | 0  | 0  | 0  | 0  | 0  | 0  | 0  | 0  | 0  | 0  | 102 |
| 2076                 | 0  | 0  | 0  | 0  | 0  | 0  | 0  | 0  | 0  | 0  | 0  | 0  | 0  | 102 |
| 2077                 | 0  | 0  | 0  | 0  | 0  | 0  | 0  | 0  | 0  | 0  | 0  | 0  | 0  | 102 |
| 2078                 | 0  | 0  | 0  | 0  | 0  | 0  | 0  | 0  | 0  | 0  | 0  | 0  | 0  | 102 |
| 2079                 | 0  | 0  | 0  | 0  | 0  | 0  | 0  | 0  | 0  | 0  | 0  | 0  | 0  | 102 |
| 2080                 | 0  | 0  | 0  | 0  | 0  | 0  | 0  | 0  | 0  | 0  | 0  | 0  | 0  | 102 |
| 2081                 | 0  | 0  | 0  | 0  | 0  | 0  | 0  | 0  | 0  | 0  | 0  | 0  | 0  | 102 |
| 2082                 | 0  | 0  | 0  | 0  | 0  | 0  | 0  | 0  | 0  | 0  | 0  | 0  | 0  | 102 |
| 2083                 | 0  | 0  | 0  | 0  | 0  | 0  | 0  | 0  | 0  | 0  | 0  | 0  | 0  | 102 |
| 2084                 | 0  | 0  | 0  | 0  | 0  | 0  | 0  | 0  | 0  | 0  | 0  | 0  | 0  | 102 |
| 2085                 | 0  | 0  | 0  | 0  | 0  | 0  | 0  | 0  | 0  | 0  | 0  | 0  | 0  | 102 |
| 2086                 | 0  | 0  | 0  | 0  | 0  | 0  | 0  | 0  | 0  | 0  | 0  | 0  | 0  | 102 |
| 2087                 | 0  | 0  | 0  | 0  | 0  | 0  | 0  | 0  | 0  | 0  | 0  | 0  | 0  | 102 |
| 2088                 | 0  | 0  | 0  | 0  | 0  | 0  | 0  | 0  | 0  | 0  | 0  | 0  | 0  | 102 |
| 2089                 | 0  | 0  | 0  | 0  | 0  | 0  | 0  | 0  | 0  | 0  | 0  | 0  | 0  | 102 |
| 2090                 | 0  | 0  | 0  | 0  | 0  | 0  | 0  | 0  | 0  | 0  | 0  | 0  | 0  | 102 |

| ScenarioID / Year | 29  | 30  | 31  | 32  | 33  | 34  | 35  | 36  | 37  | 38  | 39  | 40  | 41  | 42  |
|-------------------|-----|-----|-----|-----|-----|-----|-----|-----|-----|-----|-----|-----|-----|-----|
| 2002              | 0   | 0   | 0   | 0   | 0   | 0   | 0   | 0   | 0   | 0   | 0   | 0   | 0   | 0   |
| 2003              | 0   | 0   | 0   | 0   | 0   | 0   | 0   | 0   | 0   | 0   | 0   | 0   | 0   | 0   |
| 2004              | 0   | 0   | 0   | 0   | 0   | 0   | 0   | 0   | 0   | 0   | 0   | 0   | 0   | 0   |
| 2005              | 0   | 0   | 0   | 0   | 0   | 0   | 0   | 0   | 0   | 0   | 0   | 0   | 0   | 0   |
| 2006              | 0   | 0   | 0   | 0   | 0   | 0   | 0   | 0   | 0   | 0   | 0   | 0   | 0   | 0   |
| 2007              | 0   | 0   | 0   | 0   | 0   | 0   | 0   | 0   | 0   | 0   | 0   | 0   | 0   | 0   |
| 2008              | 0   | 0   | 0   | 0   | 0   | 0   | 0   | 0   | 0   | 0   | 0   | 0   | 0   | 0   |
| 2009              | 0   | 0   | 0   | 0   | 0   | 0   | 0   | 0   | 0   | 0   | 0   | 0   | 0   | 0   |
| 2010              | 0   | 0   | 0   | 0   | 0   | 0   | 0   | 0   | 0   | 0   | 0   | 0   | 0   | 0   |
| 2011              | 0   | 0   | 0   | 0   | 0   | 0   | 0   | 0   | 0   | 0   | 0   | 0   | 0   | 0   |
| 2012              | 0   | 0   | 0   | 0   | 0   | 0   | 0   | 0   | 0   | 0   | 0   | 0   | 0   | 0   |
| 2013              | 0   | 0   | 0   | 0   | 0   | 0   | 0   | 0   | 0   | 0   | 0   | 0   | 0   | 0   |
| 2014              | 0   | 0   | 0   | 0   | 0   | 0   | 0   | 0   | 0   | 0   | 0   | 0   | 0   | 0   |
| 2015              | 0   | 0   | 0   | 0   | 0   | 0   | 0   | 0   | 0   | 0   | 0   | 0   | 0   | 0   |
| 2016              | 0   | 0   | 0   | 0   | 0   | 0   | 0   | 0   | 0   | 0   | 0   | 0   | 0   | 0   |
| 2017              | 0   | 0   | 0   | 0   | 0   | 0   | 0   | 0   | 0   | 0   | 0   | 0   | 0   | 0   |
| 2018              | 0   | 0   | 0   | 0   | 0   | 0   | 0   | 0   | 0   | 0   | 0   | 0   | 0   | 0   |
| 2019              | 0   | 0   | 0   | 0   | 0   | 0   | 0   | 0   | 0   | 0   | 0   | 0   | 0   | 0   |
| 2020              | 0   | 0   | 300 | 0   | 0   | 0   | 0   | 0   | 0   | 0   | 0   | 300 | 0   | 0   |
| 2021              | 0   | 0   | 300 | 0   | 0   | 0   | 0   | 0   | 0   | 0   | 0   | 300 | 0   | 0   |
| 2022              | 0   | 0   | 300 | 0   | 0   | 0   | 0   | 0   | 0   | 0   | 0   | 300 | 0   | 0   |
| 2023              | 0   | 0   | 300 | 0   | 0   | 0   | 0   | 0   | 0   | 0   | 0   | 300 | 0   | 0   |
| 2024              | 0   | 0   | 300 | 0   | 0   | 0   | 0   | 0   | 0   | 0   | 0   | 300 | 0   | 0   |
| 2025              | 300 | 0   | 300 | 300 | 300 | 300 | 300 | 300 | 300 | 300 | 0   | 300 | 300 | 300 |
| 2026              | 300 | 0   | 300 | 300 | 300 | 300 | 300 | 300 | 300 | 300 | 0   | 300 | 300 | 300 |
| 2027              | 300 | 0   | 300 | 300 | 300 | 300 | 300 | 300 | 300 | 300 | 0   | 300 | 300 | 300 |
| 2028              | 300 | 0   | 300 | 300 | 300 | 300 | 300 | 300 | 300 | 300 | 0   | 300 | 300 | 300 |
| 2029              | 300 | 0   | 300 | 300 | 300 | 300 | 300 | 300 | 300 | 300 | 0   | 300 | 300 | 300 |
| 2030              | 300 | 300 | 300 | 300 | 300 | 300 | 300 | 300 | 300 | 300 | 300 | 300 | 300 | 300 |
| 2031              | 300 | 300 | 300 | 300 | 300 | 300 | 300 | 300 | 300 | 300 | 300 | 300 | 300 | 300 |
| 2032              | 300 | 300 | 300 | 300 | 300 | 300 | 300 | 300 | 300 | 300 | 300 | 300 | 300 | 300 |
| 2033              | 300 | 300 | 300 | 300 | 300 | 300 | 300 | 300 | 300 | 300 | 300 | 300 | 300 | 300 |
| 2034              | 300 | 300 | 300 | 300 | 300 | 300 | 300 | 300 | 300 | 300 | 300 | 300 | 300 | 300 |
| 2035              | 300 | 300 | 300 | 300 | 300 | 300 | 300 | 300 | 300 | 300 | 300 | 300 | 300 | 300 |
| 2036              | 300 | 300 | 300 | 300 | 300 | 300 | 300 | 300 | 300 | 300 | 300 | 300 | 300 | 300 |
| 2037              | 300 | 300 | 300 | 300 | 300 | 300 | 300 | 300 | 300 | 300 | 300 | 300 | 300 | 300 |
| 2038              | 300 | 300 | 300 | 300 | 300 | 300 | 300 | 300 | 300 | 300 | 300 | 300 | 300 | 300 |
| 2039              | 300 | 300 | 300 | 300 | 300 | 300 | 300 | 300 | 300 | 300 | 300 | 300 | 300 | 300 |
| 2040              | 300 | 300 | 300 | 300 | 300 | 300 | 300 | 300 | 300 | 300 | 300 | 300 | 300 | 300 |
| 2041              | 300 | 300 | 300 | 300 | 300 | 300 | 300 | 300 | 300 | 300 | 300 | 300 | 300 | 300 |
| 2042              | 300 | 300 | 300 | 300 | 300 | 300 | 300 | 300 | 300 | 300 | 300 | 300 | 300 | 300 |
| 2043              | 300 | 300 | 300 | 300 | 300 | 300 | 300 | 300 | 300 | 300 | 300 | 300 | 300 | 300 |
| 2044              | 300 | 300 | 300 | 300 | 300 | 300 | 300 | 300 | 300 | 300 | 300 | 300 | 300 | 300 |
| 2045              | 300 | 300 | 300 | 300 | 300 | 300 | 300 | 300 | 300 | 300 | 300 | 300 | 300 | 300 |
| 2046              | 300 | 300 | 300 | 300 | 300 | 300 | 300 | 300 | 300 | 300 | 300 | 300 | 300 | 300 |
| 2047              | 300 | 300 | 300 | 300 | 300 | 300 | 300 | 300 | 300 | 300 | 300 | 300 | 300 | 300 |
| 2048              | 300 | 300 | 300 | 300 | 300 | 300 | 300 | 300 | 300 | 300 | 300 | 300 | 300 | 300 |
| 2049              | 300 | 300 | 300 | 300 | 300 | 300 | 300 | 300 | 300 | 300 | 300 | 300 | 300 | 300 |
| 2050              | 300 | 300 | 300 | 300 | 300 | 300 | 300 | 300 | 300 | 300 | 300 | 300 | 300 | 300 |
| 2051              | 300 | 300 | 300 | 300 | 300 | 300 | 300 | 300 | 300 | 300 | 300 | 300 | 300 | 300 |

| ScenarioID /<br>Year | 29  | 30  | 31  | 32  | 33  | 34  | 35  | 36  | 37  | 38  | 39  | 40  | 41  | 42  |
|----------------------|-----|-----|-----|-----|-----|-----|-----|-----|-----|-----|-----|-----|-----|-----|
| 2052                 | 300 | 300 | 300 | 300 | 300 | 300 | 300 | 300 | 300 | 300 | 300 | 300 | 300 | 300 |
| 2053                 | 300 | 300 | 300 | 300 | 300 | 300 | 300 | 300 | 300 | 300 | 300 | 300 | 300 | 300 |
| 2054                 | 300 | 300 | 300 | 300 | 300 | 300 | 300 | 300 | 300 | 300 | 300 | 300 | 300 | 300 |
| 2055                 | 300 | 300 | 300 | 300 | 300 | 300 | 300 | 300 | 300 | 300 | 300 | 300 | 300 | 300 |
| 2056                 | 300 | 300 | 300 | 300 | 300 | 300 | 300 | 300 | 300 | 300 | 300 | 300 | 300 | 300 |
| 2057                 | 300 | 300 | 270 | 300 | 300 | 300 | 300 | 300 | 300 | 300 | 300 | 300 | 300 | 300 |
| 2058                 | 300 | 300 | 196 | 300 | 300 | 300 | 300 | 300 | 300 | 300 | 300 | 300 | 300 | 300 |
| 2059                 | 292 | 300 | 164 | 300 | 236 | 261 | 261 | 261 | 300 | 300 | 300 | 300 | 300 | 300 |
| 2060                 | 216 | 300 | 153 | 298 | 200 | 185 | 185 | 185 | 300 | 300 | 300 | 300 | 300 | 300 |
| 2061                 | 190 | 300 | 155 | 219 | 174 | 176 | 176 | 176 | 300 | 300 | 300 | 300 | 300 | 300 |
| 2062                 | 187 | 271 | 154 | 186 | 155 | 163 | 163 | 163 | 295 | 300 | 300 | 298 | 298 | 300 |
| 2063                 | 169 | 230 | 144 | 160 | 155 | 149 | 149 | 149 | 278 | 300 | 300 | 271 | 283 | 291 |
| 2064                 | 147 | 176 | 130 | 141 | 147 | 138 | 138 | 138 | 260 | 300 | 300 | 245 | 271 | 261 |
| 2065                 | 154 | 178 | 136 | 142 | 146 | 154 | 154 | 154 | 233 | 274 | 300 | 232 | 241 | 222 |
| 2066                 | 140 | 163 | 105 | 137 | 133 | 140 | 140 | 140 | 201 | 264 | 300 | 174 | 204 | 161 |
| 2067                 | 140 | 151 | 104 | 139 | 131 | 131 | 131 | 131 | 181 | 232 | 300 | 163 | 158 | 164 |
| 2068                 | 123 | 142 | 104 | 130 | 109 | 123 | 123 | 123 | 156 | 170 | 271 | 144 | 151 | 156 |
| 2069                 | 105 | 148 | 103 | 112 | 102 | 108 | 108 | 108 | 146 | 151 | 223 | 128 | 147 | 156 |
| 2070                 | 103 | 141 | 102 | 105 | 103 | 102 | 102 | 102 | 136 | 148 | 174 | 121 | 147 | 140 |
| 2071                 | 102 | 130 | 102 | 104 | 104 | 102 | 102 | 102 | 132 | 150 | 156 | 122 | 140 | 133 |
| 2072                 | 102 | 133 | 102 | 102 | 104 | 102 | 102 | 102 | 129 | 148 | 148 | 121 | 131 | 137 |
| 2073                 | 102 | 125 | 102 | 102 | 101 | 102 | 102 | 102 | 123 | 140 | 149 | 116 | 129 | 133 |
| 2074                 | 102 | 102 | 102 | 102 | 103 | 102 | 102 | 102 | 111 | 131 | 148 | 111 | 115 | 116 |
| 2075                 | 102 | 104 | 102 | 102 | 104 | 102 | 102 | 102 | 106 | 130 | 149 | 102 | 111 | 112 |
| 2076                 | 102 | 103 | 102 | 102 | 101 | 102 | 102 | 102 | 102 | 120 | 148 | 102 | 104 | 105 |
| 2077                 | 102 | 102 | 102 | 102 | 103 | 102 | 102 | 102 | 102 | 113 | 139 | 102 | 102 | 102 |
| 2078                 | 102 | 102 | 102 | 102 | 102 | 102 | 102 | 102 | 102 | 111 | 138 | 102 | 102 | 105 |
| 2079                 | 102 | 102 | 102 | 102 | 102 | 102 | 102 | 102 | 102 | 104 | 125 | 102 | 102 | 102 |
| 2080                 | 102 | 102 | 102 | 102 | 102 | 102 | 102 | 102 | 102 | 102 | 114 | 102 | 102 | 105 |
| 2081                 | 102 | 102 | 102 | 102 | 102 | 102 | 102 | 102 | 102 | 102 | 105 | 102 | 102 | 102 |
| 2082                 | 102 | 102 | 102 | 102 | 102 | 102 | 102 | 102 | 102 | 102 | 102 | 102 | 102 | 102 |
| 2083                 | 102 | 102 | 102 | 102 | 102 | 102 | 102 | 102 | 102 | 102 | 102 | 102 | 102 | 102 |
| 2084                 | 102 | 102 | 102 | 102 | 102 | 102 | 102 | 102 | 102 | 102 | 102 | 102 | 102 | 102 |
| 2085                 | 102 | 102 | 102 | 102 | 102 | 102 | 102 | 102 | 102 | 102 | 102 | 102 | 102 | 102 |
| 2086                 | 102 | 102 | 102 | 102 | 102 | 102 | 102 | 102 | 102 | 102 | 102 | 102 | 102 | 102 |
| 2087                 | 102 | 102 | 102 | 102 | 102 | 102 | 102 | 102 | 102 | 102 | 102 | 102 | 102 | 102 |
| 2088                 | 102 | 102 | 102 | 102 | 102 | 102 | 102 | 102 | 102 | 102 | 102 | 102 | 102 | 102 |
| 2089                 | 102 | 102 | 102 | 102 | 102 | 102 | 102 | 102 | 102 | 102 | 102 | 102 | 102 | 102 |
| 2090                 | 102 | 102 | 102 | 102 | 102 | 102 | 102 | 102 | 102 | 102 | 102 | 102 | 102 | 102 |

| ScenarioID / Year | 43  | 44  | 45  | 46  | 47  | 48  | 49  | 50  | 51  | 52  | 53  | 54  | 55  | 56  |
|-------------------|-----|-----|-----|-----|-----|-----|-----|-----|-----|-----|-----|-----|-----|-----|
| 2002              | 0   | 0   | 0   | 0   | 0   | 0   | 0   | 0   | 0   | 0   | 0   | 0   | 0   | 0   |
| 2003              | 0   | 0   | 0   | 0   | 0   | 0   | 0   | 0   | 0   | 0   | 0   | 0   | 0   | 0   |
| 2004              | 0   | 0   | 0   | 0   | 0   | 0   | 0   | 0   | 0   | 0   | 0   | 0   | 0   | 0   |
| 2005              | 0   | 0   | 0   | 0   | 0   | 0   | 0   | 0   | 0   | 0   | 0   | 0   | 0   | 0   |
| 2006              | 0   | 0   | 0   | 0   | 0   | 0   | 0   | 0   | 0   | 0   | 0   | 0   | 0   | 0   |
| 2007              | 0   | 0   | 0   | 0   | 0   | 0   | 0   | 0   | 0   | 0   | 0   | 0   | 0   | 0   |
| 2008              | 0   | 0   | 0   | 0   | 0   | 0   | 0   | 0   | 0   | 0   | 0   | 0   | 0   | 0   |
| 2009              | 0   | 0   | 0   | 0   | 0   | 0   | 0   | 0   | 0   | 0   | 0   | 0   | 0   | 0   |
| 2010              | 0   | 0   | 0   | 0   | 0   | 0   | 0   | 0   | 0   | 0   | 0   | 0   | 0   | 0   |
| 2011              | 0   | 0   | 0   | 0   | 0   | 0   | 0   | 0   | 0   | 0   | 0   | 0   | 0   | 0   |
| 2012              | 0   | 0   | 0   | 0   | 0   | 0   | 0   | 0   | 0   | 0   | 0   | 0   | 0   | 0   |
| 2013              | 0   | 0   | 0   | 0   | 0   | 0   | 0   | 0   | 0   | 0   | 0   | 0   | 0   | 0   |
| 2014              | 0   | 0   | 0   | 0   | 0   | 0   | 0   | 0   | 0   | 0   | 0   | 0   | 0   | 0   |
| 2015              | 0   | 0   | 0   | 0   | 0   | 0   | 0   | 0   | 0   | 0   | 0   | 0   | 0   | 0   |
| 2016              | 0   | 0   | 0   | 0   | 0   | 0   | 0   | 0   | 0   | 0   | 0   | 0   | 0   | 0   |
| 2017              | 0   | 0   | 0   | 0   | 0   | 0   | 0   | 0   | 0   | 0   | 0   | 0   | 0   | 0   |
| 2018              | 0   | 0   | 0   | 0   | 0   | 0   | 0   | 0   | 0   | 0   | 0   | 0   | 0   | 0   |
| 2019              | 0   | 0   | 0   | 0   | 0   | 0   | 0   | 0   | 0   | 0   | 0   | 0   | 0   | 0   |
| 2020              | 0   | 0   | 0   | 0   | 0   | 0   | 300 | 0   | 0   | 0   | 0   | 0   | 0   | 0   |
| 2021              | 0   | 0   | 0   | 0   | 0   | 0   | 300 | 0   | 0   | 0   | 0   | 0   | 0   | 0   |
| 2022              | 0   | 0   | 0   | 0   | 0   | 0   | 300 | 0   | 0   | 0   | 0   | 0   | 0   | 0   |
| 2023              | 0   | 0   | 0   | 0   | 0   | 0   | 300 | 0   | 0   | 0   | 0   | 0   | 0   | 0   |
| 2024              | 0   | 0   | 0   | 0   | 0   | 0   | 300 | 0   | 0   | 0   | 0   | 0   | 0   | 0   |
| 2025              | 300 | 300 | 300 | 300 | 300 | 0   | 300 | 300 | 300 | 300 | 300 | 300 | 300 | 300 |
| 2026              | 300 | 300 | 300 | 300 | 300 | 0   | 300 | 300 | 300 | 300 | 300 | 300 | 300 | 300 |
| 2027              | 300 | 300 | 300 | 300 | 300 | 0   | 300 | 300 | 300 | 300 | 300 | 300 | 300 | 300 |
| 2028              | 300 | 300 | 300 | 300 | 300 | 0   | 300 | 300 | 300 | 300 | 300 | 300 | 300 | 300 |
| 2029              | 300 | 300 | 300 | 300 | 300 | 0   | 300 | 300 | 300 | 300 | 300 | 300 | 300 | 300 |
| 2030              | 300 | 300 | 300 | 300 | 300 | 300 | 300 | 300 | 300 | 300 | 300 | 300 | 300 | 300 |
| 2031              | 300 | 300 | 300 | 300 | 300 | 300 | 300 | 300 | 300 | 300 | 300 | 300 | 300 | 300 |
| 2032              | 300 | 300 | 300 | 300 | 300 | 300 | 300 | 300 | 300 | 300 | 300 | 300 | 300 | 300 |
| 2033              | 300 | 300 | 300 | 300 | 300 | 300 | 300 | 300 | 300 | 300 | 300 | 300 | 300 | 300 |
| 2034              | 300 | 300 | 300 | 300 | 300 | 300 | 300 | 300 | 300 | 300 | 300 | 300 | 300 | 300 |
| 2035              | 300 | 300 | 300 | 300 | 300 | 300 | 300 | 300 | 300 | 300 | 300 | 300 | 300 | 300 |
| 2036              | 300 | 300 | 300 | 300 | 300 | 300 | 300 | 300 | 300 | 300 | 300 | 300 | 300 | 300 |
| 2037              | 300 | 300 | 300 | 300 | 300 | 300 | 300 | 300 | 300 | 300 | 300 | 300 | 300 | 300 |
| 2038              | 300 | 300 | 300 | 300 | 300 | 300 | 300 | 300 | 300 | 300 | 300 | 300 | 300 | 300 |
| 2039              | 300 | 300 | 300 | 300 | 300 | 300 | 300 | 300 | 300 | 300 | 300 | 300 | 300 | 300 |
| 2040              | 300 | 300 | 300 | 300 | 300 | 300 | 300 | 300 | 300 | 300 | 300 | 300 | 300 | 300 |
| 2041              | 300 | 300 | 300 | 300 | 300 | 300 | 300 | 300 | 300 | 300 | 300 | 300 | 300 | 300 |
| 2042              | 300 | 300 | 300 | 300 | 300 | 300 | 300 | 300 | 300 | 300 | 300 | 300 | 300 | 300 |
| 2043              | 300 | 300 | 300 | 300 | 300 | 300 | 300 | 300 | 300 | 300 | 300 | 300 | 231 | 300 |
| 2044              | 300 | 300 | 300 | 300 | 300 | 300 | 300 | 300 | 300 | 300 | 300 | 300 | 165 | 300 |
| 2045              | 300 | 300 | 300 | 300 | 300 | 300 | 300 | 300 | 300 | 300 | 300 | 300 | 40  | 300 |
| 2046              | 300 | 300 | 300 | 300 | 300 | 300 | 300 | 300 | 300 | 300 | 300 | 300 | 29  | 300 |
| 2047              | 300 | 300 | 300 | 300 | 300 | 300 | 300 | 300 | 300 | 300 | 300 | 300 | 13  | 300 |
| 2048              | 300 | 300 | 300 | 300 | 300 | 300 | 300 | 300 | 300 | 300 | 300 | 300 | 0   | 244 |
| 2049              | 300 | 300 | 300 | 300 | 300 | 300 | 300 | 300 | 300 | 300 | 300 | 300 | 0   | 154 |
| 2050              | 300 | 300 | 300 | 300 | 300 | 300 | 300 | 300 | 300 | 300 | 300 | 300 | 0   | 154 |
| 2051              | 300 | 300 | 300 | 300 | 300 | 300 | 300 | 300 | 300 | 300 | 300 | 300 | 0   | 154 |

| ScenarioID /<br>Year | 43  | 44  | 45  | 46  | 47  | 48  | 49  | 50  | 51  | 52  | 53  | 54  | 55 | 56  |
|----------------------|-----|-----|-----|-----|-----|-----|-----|-----|-----|-----|-----|-----|----|-----|
| 2052                 | 300 | 300 | 300 | 300 | 300 | 300 | 300 | 300 | 300 | 300 | 300 | 300 | 0  | 154 |
| 2053                 | 300 | 300 | 300 | 300 | 300 | 300 | 300 | 300 | 300 | 300 | 300 | 300 | 0  | 154 |
| 2054                 | 300 | 300 | 300 | 300 | 300 | 300 | 300 | 300 | 300 | 300 | 300 | 300 | 0  | 0   |
| 2055                 | 300 | 300 | 300 | 300 | 300 | 300 | 300 | 300 | 300 | 300 | 300 | 300 | 0  | 0   |
| 2056                 | 300 | 300 | 300 | 300 | 300 | 300 | 300 | 300 | 300 | 300 | 300 | 300 | 0  | 0   |
| 2057                 | 300 | 300 | 300 | 300 | 300 | 300 | 259 | 300 | 300 | 300 | 300 | 300 | 0  | 0   |
| 2058                 | 300 | 300 | 300 | 300 | 300 | 300 | 227 | 300 | 281 | 300 | 300 | 300 | 0  | 0   |
| 2059                 | 300 | 300 | 300 | 300 | 300 | 300 | 185 | 300 | 271 | 300 | 300 | 300 | 0  | 0   |
| 2060                 | 300 | 300 | 300 | 234 | 300 | 300 | 161 | 300 | 237 | 286 | 286 | 286 | 0  | 0   |
| 2061                 | 300 | 300 | 300 | 197 | 279 | 300 | 182 | 276 | 215 | 255 | 255 | 255 | 0  | 0   |
| 2062                 | 300 | 300 | 300 | 165 | 226 | 300 | 164 | 232 | 189 | 211 | 211 | 211 | 0  | 0   |
| 2063                 | 291 | 291 | 291 | 161 | 197 | 300 | 142 | 183 | 191 | 175 | 175 | 175 | 0  | 0   |
| 2064                 | 268 | 268 | 268 | 159 | 167 | 292 | 131 | 153 | 162 | 163 | 163 | 163 | 0  | 0   |
| 2065                 | 248 | 248 | 248 | 149 | 155 | 252 | 124 | 149 | 163 | 157 | 157 | 157 | 0  | 0   |
| 2066                 | 227 | 227 | 227 | 147 | 167 | 219 | 125 | 147 | 150 | 153 | 153 | 153 | 0  | 0   |
| 2067                 | 184 | 184 | 184 | 129 | 152 | 161 | 112 | 146 | 133 | 147 | 147 | 147 | 0  | 0   |
| 2068                 | 156 | 156 | 156 | 112 | 150 | 147 | 104 | 146 | 120 | 140 | 140 | 140 | 0  | 0   |
| 2069                 | 151 | 151 | 151 | 109 | 138 | 149 | 105 | 139 | 110 | 130 | 130 | 130 | 0  | 0   |
| 2070                 | 148 | 148 | 148 | 101 | 125 | 146 | 102 | 137 | 106 | 121 | 121 | 121 | 0  | 0   |
| 2071                 | 143 | 143 | 143 | 105 | 120 | 150 | 105 | 116 | 114 | 120 | 120 | 120 | 0  | 0   |
| 2072                 | 132 | 132 | 132 | 102 | 120 | 148 | 102 | 114 | 127 | 105 | 105 | 105 | 0  | 0   |
| 2073                 | 129 | 129 | 129 | 105 | 115 | 147 | 105 | 105 | 119 | 102 | 102 | 102 | 0  | 0   |
| 2074                 | 120 | 120 | 120 | 102 | 104 | 139 | 102 | 102 | 116 | 102 | 102 | 102 | 0  | 0   |
| 2075                 | 114 | 114 | 114 | 105 | 104 | 129 | 105 | 102 | 110 | 102 | 102 | 102 | 0  | 0   |
| 2076                 | 111 | 111 | 111 | 102 | 103 | 119 | 102 | 102 | 104 | 102 | 102 | 102 | 0  | 0   |
| 2077                 | 104 | 104 | 104 | 102 | 102 | 105 | 102 | 102 | 102 | 102 | 102 | 102 | 0  | 0   |
| 2078                 | 102 | 102 | 102 | 102 | 104 | 102 | 102 | 102 | 105 | 102 | 102 | 102 | 0  | 0   |
| 2079                 | 102 | 102 | 102 | 102 | 102 | 102 | 102 | 102 | 102 | 102 | 102 | 102 | 0  | 0   |
| 2080                 | 102 | 102 | 102 | 102 | 102 | 102 | 102 | 102 | 105 | 102 | 102 | 102 | 0  | 0   |
| 2081                 | 102 | 102 | 102 | 102 | 102 | 102 | 102 | 102 | 102 | 102 | 102 | 102 | 0  | 0   |
| 2082                 | 102 | 102 | 102 | 102 | 102 | 102 | 102 | 102 | 102 | 102 | 102 | 102 | 0  | 0   |
| 2083                 | 102 | 102 | 102 | 102 | 102 | 102 | 102 | 102 | 104 | 102 | 102 | 102 | 0  | 0   |
| 2084                 | 102 | 102 | 102 | 102 | 102 | 102 | 102 | 102 | 102 | 102 | 102 | 102 | 0  | 0   |
| 2085                 | 102 | 102 | 102 | 102 | 102 | 102 | 102 | 102 | 105 | 102 | 102 | 102 | 0  | 0   |
| 2086                 | 102 | 102 | 102 | 102 | 102 | 102 | 102 | 102 | 102 | 102 | 102 | 102 | 0  | 0   |
| 2087                 | 102 | 102 | 102 | 102 | 102 | 102 | 102 | 102 | 102 | 102 | 102 | 102 | 0  | 0   |
| 2088                 | 102 | 102 | 102 | 102 | 102 | 102 | 102 | 102 | 102 | 102 | 102 | 102 | 0  | 0   |
| 2089                 | 102 | 102 | 102 | 102 | 102 | 102 | 102 | 102 | 102 | 102 | 102 | 102 | 0  | 0   |
| 2090                 | 102 | 102 | 102 | 102 | 102 | 102 | 102 | 102 | 102 | 102 | 102 | 102 | 0  | 0   |

| ScenarioID /<br>Year | 57  | 58  | 59  | 60  | 61  | 62  | 63  | 64  | 65  | 66  | 67  | 68  | 69  | 70  |
|----------------------|-----|-----|-----|-----|-----|-----|-----|-----|-----|-----|-----|-----|-----|-----|
| 2002                 | 0   | 0   | 0   | 0   | 0   | 0   | 0   | 0   | 0   | 0   | 0   | 0   | 0   | 0   |
| 2003                 | 0   | 0   | 0   | 0   | 0   | 0   | 0   | 0   | 0   | 0   | 0   | 0   | 0   | 0   |
| 2004                 | 0   | 0   | 0   | 0   | 0   | 0   | 0   | 0   | 0   | 0   | 0   | 0   | 0   | 0   |
| 2005                 | 0   | 0   | 0   | 0   | 0   | 0   | 0   | 0   | 0   | 0   | 0   | 0   | 0   | 0   |
| 2006                 | 0   | 0   | 0   | 0   | 0   | 0   | 0   | 0   | 0   | 0   | 0   | 0   | 0   | 0   |
| 2007                 | 0   | 0   | 0   | 0   | 0   | 0   | 0   | 0   | 0   | 0   | 0   | 0   | 0   | 0   |
| 2008                 | 0   | 0   | 0   | 0   | 0   | 0   | 0   | 0   | 0   | 0   | 0   | 0   | 0   | 0   |
| 2009                 | 0   | 0   | 0   | 0   | 0   | 0   | 0   | 0   | 0   | 0   | 0   | 0   | 0   | 0   |
| 2010                 | 0   | 0   | 0   | 0   | 0   | 0   | 0   | 0   | 0   | 0   | 0   | 0   | 0   | 0   |
| 2011                 | 0   | 0   | 0   | 0   | 0   | 0   | 0   | 0   | 0   | 0   | 0   | 0   | 0   | 0   |
| 2012                 | 0   | 0   | 0   | 0   | 0   | 0   | 0   | 0   | 0   | 0   | 0   | 0   | 0   | 0   |
| 2013                 | 0   | 0   | 0   | 0   | 0   | 0   | 0   | 0   | 0   | 0   | 0   | 0   | 0   | 0   |
| 2014                 | 0   | 0   | 0   | 0   | 0   | 0   | 0   | 0   | 0   | 0   | 0   | 0   | 0   | 0   |
| 2015                 | 0   | 0   | 0   | 0   | 0   | 0   | 0   | 0   | 0   | 0   | 0   | 0   | 0   | 0   |
| 2016                 | 0   | 0   | 0   | 0   | 0   | 0   | 0   | 0   | 0   | 0   | 0   | 0   | 0   | 0   |
| 2017                 | 0   | 0   | 0   | 0   | 0   | 0   | 0   | 0   | 0   | 0   | 0   | 0   | 0   | 0   |
| 2018                 | 0   | 0   | 0   | 0   | 0   | 0   | 0   | 0   | 0   | 0   | 0   | 0   | 0   | 0   |
| 2019                 | 0   | 0   | 0   | 0   | 0   | 0   | 0   | 0   | 0   | 0   | 0   | 0   | 0   | 0   |
| 2020                 | 0   | 300 | 0   | 0   | 0   | 0   | 0   | 0   | 0   | 0   | 300 | 0   | 0   | 0   |
| 2021                 | 0   | 300 | 0   | 0   | 0   | 0   | 0   | 0   | 0   | 0   | 300 | 0   | 0   | 0   |
| 2022                 | 0   | 300 | 0   | 0   | 0   | 0   | 0   | 0   | 0   | 0   | 300 | 0   | 0   | 0   |
| 2023                 | 0   | 300 | 0   | 0   | 0   | 0   | 0   | 0   | 0   | 0   | 300 | 0   | 0   | 0   |
| 2024                 | 0   | 300 | 0   | 0   | 0   | 0   | 0   | 0   | 0   | 0   | 300 | 0   | 0   | 0   |
| 2025                 | 0   | 300 | 300 | 300 | 300 | 300 | 300 | 300 | 300 | 0   | 300 | 300 | 300 | 300 |
| 2026                 | 0   | 300 | 300 | 300 | 300 | 300 | 300 | 300 | 300 | 0   | 300 | 300 | 300 | 300 |
| 2027                 | 0   | 300 | 300 | 300 | 300 | 300 | 300 | 300 | 300 | 0   | 300 | 300 | 300 | 300 |
| 2028                 | 0   | 300 | 300 | 300 | 300 | 300 | 300 | 300 | 300 | 0   | 300 | 300 | 300 | 300 |
| 2029                 | 0   | 300 | 300 | 300 | 300 | 300 | 300 | 300 | 300 | 0   | 300 | 300 | 300 | 300 |
| 2030                 | 300 | 300 | 300 | 300 | 300 | 300 | 300 | 300 | 300 | 300 | 300 | 300 | 300 | 300 |
| 2031                 | 300 | 300 | 300 | 300 | 300 | 300 | 300 | 300 | 300 | 300 | 300 | 300 | 300 | 300 |
| 2032                 | 300 | 300 | 300 | 300 | 300 | 300 | 300 | 300 | 300 | 300 | 300 | 300 | 300 | 300 |
| 2033                 | 300 | 300 | 300 | 300 | 300 | 300 | 300 | 300 | 300 | 300 | 300 | 300 | 300 | 300 |
| 2034                 | 300 | 300 | 300 | 300 | 300 | 300 | 300 | 300 | 300 | 300 | 300 | 300 | 300 | 300 |
| 2035                 | 300 | 300 | 300 | 300 | 300 | 300 | 300 | 300 | 300 | 300 | 300 | 300 | 300 | 300 |
| 2036                 | 300 | 300 | 300 | 300 | 300 | 300 | 300 | 300 | 300 | 300 | 300 | 300 | 300 | 300 |
| 2037                 | 300 | 300 | 300 | 300 | 300 | 300 | 300 | 300 | 300 | 300 | 300 | 300 | 300 | 300 |
| 2038                 | 300 | 300 | 300 | 300 | 300 | 300 | 300 | 300 | 300 | 300 | 300 | 300 | 300 | 300 |
| 2039                 | 300 | 300 | 300 | 300 | 300 | 300 | 300 | 300 | 300 | 300 | 300 | 300 | 300 | 300 |
| 2040                 | 300 | 300 | 300 | 300 | 300 | 300 | 300 | 300 | 300 | 300 | 300 | 300 | 300 | 300 |
| 2041                 | 300 | 267 | 300 | 300 | 300 | 300 | 300 | 300 | 300 | 300 | 300 | 300 | 300 | 300 |
| 2042                 | 300 | 81  | 300 | 300 | 300 | 300 | 300 | 300 | 300 | 300 | 127 | 300 | 300 | 300 |
| 2043                 | 300 | 70  | 300 | 300 | 300 | 300 | 300 | 300 | 300 | 300 | 91  | 300 | 300 | 300 |
| 2044                 | 300 | 11  | 300 | 300 | 300 | 300 | 300 | 300 | 300 | 300 | 33  | 300 | 300 | 300 |
| 2045                 | 300 | 11  | 300 | 300 | 300 | 300 | 300 | 191 | 300 | 300 | 33  | 300 | 300 | 300 |
| 2046                 | 300 | 11  | 276 | 228 | 300 | 300 | 300 | 132 | 300 | 300 | 33  | 293 | 300 | 300 |
| 2047                 | 300 | 11  | 130 | 99  | 178 | 178 | 178 | 42  | 300 | 300 | 33  | 154 | 163 | 245 |
| 2048                 | 300 | 11  | 74  | 59  | 98  | 98  | 98  | 28  | 256 | 300 | 33  | 86  | 85  | 119 |
| 2049                 | 300 | 11  | 35  | 14  | 40  | 40  | 40  | 0   | 175 | 300 | 33  | 39  | 50  | 61  |
| 2050                 | 300 | 11  | 35  | 14  | 40  | 40  | 40  | 0   | 175 | 300 | 33  | 39  | 50  | 61  |
| 2051                 | 216 | 11  | 0   | 14  | 40  | 40  | 40  | 0   | 175 | 246 | 33  | 0   | 0   | 0   |



| ScenarioID /<br>Year | 57  | 58 | 59 | 60 | 61 | 62 | 63 | 64 | 65  | 66  | 67 | 68 | 69 | 70 |
|----------------------|-----|----|----|----|----|----|----|----|-----|-----|----|----|----|----|
| 2052                 | 131 | 11 | 0  | 14 | 40 | 40 | 40 | 0  | 175 | 154 | 33 | 0  | 0  | 0  |
| 2053                 | 96  | 11 | 0  | 14 | 40 | 40 | 40 | 0  | 175 | 110 | 33 | 0  | 0  | 0  |
| 2054                 | 54  | 11 | 0  | 14 | 40 | 40 | 40 | 0  | 0   | 65  | 33 | 0  | 0  | 0  |
| 2055                 | 54  | 11 | 0  | 14 | 40 | 40 | 40 | 0  | 0   | 65  | 33 | 0  | 0  | 0  |
| 2056                 | 0   | 11 | 0  | 14 | 40 | 40 | 40 | 0  | 0   | 65  | 33 | 0  | 0  | 0  |
| 2057                 | 0   | 11 | 0  | 14 | 40 | 40 | 40 | 0  | 0   | 65  | 33 | 0  | 0  | 0  |
| 2058                 | 0   | 11 | 0  | 14 | 40 | 40 | 40 | 0  | 0   | 65  | 33 | 0  | 0  | 0  |
| 2059                 | 0   | 11 | 0  | 14 | 40 | 40 | 40 | 0  | 0   | 65  | 33 | 0  | 0  | 0  |
| 2060                 | 0   | 11 | 0  | 14 | 40 | 40 | 40 | 0  | 0   | 65  | 33 | 0  | 0  | 0  |
| 2061                 | 0   | 11 | 0  | 14 | 40 | 40 | 40 | 0  | 0   | 65  | 33 | 0  | 0  | 0  |
| 2062                 | 0   | 11 | 0  | 14 | 40 | 40 | 40 | 0  | 0   | 65  | 33 | 0  | 0  | 0  |
| 2063                 | 0   | 11 | 0  | 14 | 40 | 40 | 40 | 0  | 0   | 65  | 33 | 0  | 0  | 0  |
| 2064                 | 0   | 11 | 0  | 14 | 40 | 40 | 40 | 0  | 0   | 65  | 33 | 0  | 0  | 0  |
| 2065                 | 0   | 11 | 0  | 14 | 40 | 40 | 40 | 0  | 0   | 65  | 33 | 0  | 0  | 0  |
| 2066                 | 0   | 11 | 0  | 14 | 40 | 40 | 40 | 0  | 0   | 65  | 33 | 0  | 0  | 0  |
| 2067                 | 0   | 11 | 0  | 14 | 40 | 40 | 40 | 0  | 0   | 65  | 33 | 0  | 0  | 0  |
| 2068                 | 0   | 11 | 0  | 14 | 40 | 40 | 40 | 0  | 0   | 65  | 33 | 0  | 0  | 0  |
| 2069                 | 0   | 11 | 0  | 14 | 40 | 40 | 40 | 0  | 0   | 65  | 33 | 0  | 0  | 0  |
| 2070                 | 0   | 11 | 0  | 14 | 40 | 40 | 40 | 0  | 0   | 65  | 33 | 0  | 0  | 0  |
| 2071                 | 0   | 11 | 0  | 14 | 40 | 40 | 40 | 0  | 0   | 65  | 33 | 0  | 0  | 0  |
| 2072                 | 0   | 11 | 0  | 14 | 40 | 40 | 40 | 0  | 0   | 65  | 33 | 0  | 0  | 0  |
| 2073                 | 0   | 11 | 0  | 14 | 40 | 40 | 40 | 0  | 0   | 65  | 33 | 0  | 0  | 0  |
| 2074                 | 0   | 11 | 0  | 14 | 40 | 40 | 40 | 0  | 0   | 65  | 33 | 0  | 0  | 0  |
| 2075                 | 0   | 11 | 0  | 14 | 40 | 40 | 40 | 0  | 0   | 65  | 33 | 0  | 0  | 0  |
| 2076                 | 0   | 11 | 0  | 14 | 40 | 40 | 40 | 0  | 0   | 65  | 33 | 0  | 0  | 0  |
| 2077                 | 0   | 11 | 0  | 14 | 40 | 40 | 40 | 0  | 0   | 65  | 33 | 0  | 0  | 0  |
| 2078                 | 0   | 11 | 0  | 14 | 40 | 40 | 40 | 0  | 0   | 65  | 33 | 0  | 0  | 0  |
| 2079                 | 0   | 11 | 0  | 14 | 40 | 40 | 40 | 0  | 0   | 65  | 33 | 0  | 0  | 0  |
| 2080                 | 0   | 11 | 0  | 14 | 40 | 40 | 40 | 0  | 0   | 65  | 33 | 0  | 0  | 0  |
| 2081                 | 0   | 11 | 0  | 14 | 40 | 40 | 40 | 0  | 0   | 65  | 33 | 0  | 0  | 0  |
| 2082                 | 0   | 11 | 0  | 14 | 40 | 40 | 40 | 0  | 0   | 65  | 33 | 0  | 0  | 0  |
| 2083                 | 0   | 11 | 0  | 14 | 40 | 40 | 40 | 0  | 0   | 65  | 33 | 0  | 0  | 0  |
| 2084                 | 0   | 11 | 0  | 14 | 40 | 40 | 40 | 0  | 0   | 65  | 33 | 0  | 0  | 0  |
| 2085                 | 0   | 11 | 0  | 14 | 40 | 40 | 40 | 0  | 0   | 65  | 33 | 0  | 0  | 0  |
| 2086                 | 0   | 11 | 0  | 14 | 40 | 40 | 40 | 0  | 0   | 65  | 33 | 0  | 0  | 0  |
| 2087                 | 0   | 11 | 0  | 14 | 40 | 40 | 40 | 0  | 0   | 65  | 33 | 0  | 0  | 0  |
| 2088                 | 0   | 11 | 0  | 14 | 40 | 40 | 40 | 0  | 0   | 65  | 33 | 0  | 0  | 0  |
| 2089                 | 0   | 11 | 0  | 14 | 40 | 40 | 40 | 0  | 0   | 65  | 33 | 0  | 0  | 0  |
| 2090                 | 0   | 11 | 0  | 14 | 40 | 40 | 40 | 0  | 0   | 65  | 33 | 0  | 0  | 0  |

| ScenarioID /<br>Year | 71  | 72  | 73  | 74  | 75  | 76  | 77  | 78  | 79  | 80  | 81  |
|----------------------|-----|-----|-----|-----|-----|-----|-----|-----|-----|-----|-----|
| 2002                 | 0   | 0   | 0   | 0   | 0   | 0   | 0   | 0   | 0   | 0   | 0   |
| 2003                 | 0   | 0   | 0   | 0   | 0   | 0   | 0   | 0   | 0   | 0   | 0   |
| 2004                 | 0   | 0   | 0   | 0   | 0   | 0   | 0   | 0   | 0   | 0   | 0   |
| 2005                 | 0   | 0   | 0   | 0   | 0   | 0   | 0   | 0   | 0   | 0   | 0   |
| 2006                 | 0   | 0   | 0   | 0   | 0   | 0   | 0   | 0   | 0   | 0   | 0   |
| 2007                 | 0   | 0   | 0   | 0   | 0   | 0   | 0   | 0   | 0   | 0   | 0   |
| 2008                 | 0   | 0   | 0   | 0   | 0   | 0   | 0   | 0   | 0   | 0   | 0   |
| 2009                 | 0   | 0   | 0   | 0   | 0   | 0   | 0   | 0   | 0   | 0   | 0   |
| 2010                 | 0   | 0   | 0   | 0   | 0   | 0   | 0   | 0   | 0   | 0   | 0   |
| 2011                 | 0   | 0   | 0   | 0   | 0   | 0   | 0   | 0   | 0   | 0   | 0   |
| 2012                 | 0   | 0   | 0   | 0   | 0   | 0   | 0   | 0   | 0   | 0   | 0   |
| 2013                 | 0   | 0   | 0   | 0   | 0   | 0   | 0   | 0   | 0   | 0   | 0   |
| 2014                 | 0   | 0   | 0   | 0   | 0   | 0   | 0   | 0   | 0   | 0   | 0   |
| 2015                 | 0   | 0   | 0   | 0   | 0   | 0   | 0   | 0   | 0   | 0   | 0   |
| 2016                 | 0   | 0   | 0   | 0   | 0   | 0   | 0   | 0   | 0   | 0   | 0   |
| 2017                 | 0   | 0   | 0   | 0   | 0   | 0   | 0   | 0   | 0   | 0   | 0   |
| 2018                 | 0   | 0   | 0   | 0   | 0   | 0   | 0   | 0   | 0   | 0   | 0   |
| 2019                 | 0   | 0   | 0   | 0   | 0   | 0   | 0   | 0   | 0   | 0   | 0   |
| 2020                 | 0   | 0   | 0   | 0   | 0   | 300 | 0   | 0   | 0   | 0   | 0   |
| 2021                 | 0   | 0   | 0   | 0   | 0   | 300 | 0   | 0   | 0   | 0   | 0   |
| 2022                 | 0   | 0   | 0   | 0   | 0   | 300 | 0   | 0   | 0   | 0   | 0   |
| 2023                 | 0   | 0   | 0   | 0   | 0   | 300 | 0   | 0   | 0   | 0   | 0   |
| 2024                 | 0   | 0   | 0   | 0   | 0   | 300 | 0   | 0   | 0   | 0   | 0   |
| 2025                 | 300 | 300 | 300 | 300 | 0   | 300 | 300 | 300 | 300 | 300 | 300 |
| 2026                 | 300 | 300 | 300 | 300 | 0   | 300 | 300 | 300 | 300 | 300 | 300 |
| 2027                 | 300 | 300 | 300 | 300 | 0   | 300 | 300 | 300 | 300 | 300 | 300 |
| 2028                 | 300 | 300 | 300 | 300 | 0   | 300 | 300 | 300 | 300 | 300 | 300 |
| 2029                 | 300 | 300 | 300 | 300 | 0   | 300 | 300 | 300 | 300 | 300 | 300 |
| 2030                 | 300 | 300 | 300 | 300 | 300 | 300 | 300 | 300 | 300 | 300 | 300 |
| 2031                 | 300 | 300 | 300 | 300 | 300 | 300 | 300 | 300 | 300 | 300 | 300 |
| 2032                 | 300 | 300 | 300 | 300 | 300 | 300 | 300 | 300 | 300 | 300 | 300 |
| 2033                 | 300 | 300 | 300 | 300 | 300 | 300 | 300 | 300 | 300 | 300 | 300 |
| 2034                 | 300 | 300 | 300 | 300 | 300 | 300 | 300 | 300 | 300 | 300 | 300 |
| 2035                 | 300 | 300 | 300 | 300 | 300 | 300 | 300 | 300 | 300 | 300 | 300 |
| 2036                 | 300 | 300 | 300 | 300 | 300 | 300 | 300 | 300 | 300 | 300 | 300 |
| 2037                 | 300 | 300 | 300 | 300 | 300 | 300 | 300 | 300 | 300 | 300 | 300 |
| 2038                 | 300 | 300 | 300 | 300 | 300 | 300 | 300 | 300 | 300 | 300 | 300 |
| 2039                 | 300 | 300 | 300 | 300 | 300 | 300 | 300 | 300 | 300 | 300 | 300 |
| 2040                 | 300 | 300 | 300 | 300 | 300 | 300 | 300 | 300 | 300 | 300 | 300 |
| 2041                 | 300 | 300 | 300 | 300 | 300 | 80  | 300 | 300 | 300 | 300 | 300 |
| 2042                 | 300 | 300 | 300 | 300 | 300 | 63  | 300 | 300 | 300 | 300 | 300 |
| 2043                 | 300 | 300 | 300 | 300 | 300 | 17  | 300 | 300 | 300 | 300 | 300 |
| 2044                 | 300 | 300 | 240 | 300 | 300 | 17  | 300 | 300 | 300 | 300 | 300 |
| 2045                 | 300 | 300 | 72  | 300 | 300 | 0   | 300 | 300 | 300 | 300 | 300 |
| 2046                 | 300 | 300 | 59  | 300 | 300 | 0   | 294 | 300 | 277 | 277 | 277 |
| 2047                 | 245 | 245 | 15  | 300 | 300 | 0   | 178 | 194 | 146 | 146 | 146 |
| 2048                 | 119 | 119 | 13  | 209 | 300 | 0   | 95  | 108 | 82  | 82  | 82  |
| 2049                 | 61  | 61  | 0   | 141 | 300 | 0   | 52  | 50  | 30  | 30  | 30  |
| 2050                 | 61  | 61  | 0   | 141 | 300 | 0   | 52  | 50  | 30  | 30  | 30  |
| 2051                 | 0   | 0   | 0   | 141 | 289 | 0   | 0   | 0   | 0   | 0   | 0   |

| ScenarioID /<br>Year | 71 | 72 | 73 | 74  | 75  | 76 | 77 | 78 | 79 | 80 | 81 |
|----------------------|----|----|----|-----|-----|----|----|----|----|----|----|
| 2052                 | 0  | 0  | 0  | 141 | 154 | 0  | 0  | 0  | 0  | 0  | 0  |
| 2053                 | 0  | 0  | 0  | 141 | 112 | 0  | 0  | 0  | 0  | 0  | 0  |
| 2054                 | 0  | 0  | 0  | 0   | 99  | 0  | 0  | 0  | 0  | 0  | 0  |
| 2055                 | 0  | 0  | 0  | 0   | 99  | 0  | 0  | 0  | 0  | 0  | 0  |
| 2056                 | 0  | 0  | 0  | 0   | 99  | 0  | 0  | 0  | 0  | 0  | 0  |
| 2057                 | 0  | 0  | 0  | 0   | 0   | 0  | 0  | 0  | 0  | 0  | 0  |
| 2058                 | 0  | 0  | 0  | 0   | 0   | 0  | 0  | 0  | 0  | 0  | 0  |
| 2059                 | 0  | 0  | 0  | 0   | 0   | 0  | 0  | 0  | 0  | 0  | 0  |
| 2060                 | 0  | 0  | 0  | 0   | 0   | 0  | 0  | 0  | 0  | 0  | 0  |
| 2061                 | 0  | 0  | 0  | 0   | 0   | 0  | 0  | 0  | 0  | 0  | 0  |
| 2062                 | 0  | 0  | 0  | 0   | 0   | 0  | 0  | 0  | 0  | 0  | 0  |
| 2063                 | 0  | 0  | 0  | 0   | 0   | 0  | 0  | 0  | 0  | 0  | 0  |
| 2064                 | 0  | 0  | 0  | 0   | 0   | 0  | 0  | 0  | 0  | 0  | 0  |
| 2065                 | 0  | 0  | 0  | 0   | 0   | 0  | 0  | 0  | 0  | 0  | 0  |
| 2066                 | 0  | 0  | 0  | 0   | 0   | 0  | 0  | 0  | 0  | 0  | 0  |
| 2067                 | 0  | 0  | 0  | 0   | 0   | 0  | 0  | 0  | 0  | 0  | 0  |
| 2068                 | 0  | 0  | 0  | 0   | 0   | 0  | 0  | 0  | 0  | 0  | 0  |
| 2069                 | 0  | 0  | 0  | 0   | 0   | 0  | 0  | 0  | 0  | 0  | 0  |
| 2070                 | 0  | 0  | 0  | 0   | 0   | 0  | 0  | 0  | 0  | 0  | 0  |
| 2071                 | 0  | 0  | 0  | 0   | 0   | 0  | 0  | 0  | 0  | 0  | 0  |
| 2072                 | 0  | 0  | 0  | 0   | 0   | 0  | 0  | 0  | 0  | 0  | 0  |
| 2073                 | 0  | 0  | 0  | 0   | 0   | 0  | 0  | 0  | 0  | 0  | 0  |
| 2074                 | 0  | 0  | 0  | 0   | 0   | 0  | 0  | 0  | 0  | 0  | 0  |
| 2075                 | 0  | 0  | 0  | 0   | 0   | 0  | 0  | 0  | 0  | 0  | 0  |
| 2076                 | 0  | 0  | 0  | 0   | 0   | 0  | 0  | 0  | 0  | 0  | 0  |
| 2077                 | 0  | 0  | 0  | 0   | 0   | 0  | 0  | 0  | 0  | 0  | 0  |
| 2078                 | 0  | 0  | 0  | 0   | 0   | 0  | 0  | 0  | 0  | 0  | 0  |
| 2079                 | 0  | 0  | 0  | 0   | 0   | 0  | 0  | 0  | 0  | 0  | 0  |
| 2080                 | 0  | 0  | 0  | 0   | 0   | 0  | 0  | 0  | 0  | 0  | 0  |
| 2081                 | 0  | 0  | 0  | 0   | 0   | 0  | 0  | 0  | 0  | 0  | 0  |
| 2082                 | 0  | 0  | 0  | 0   | 0   | 0  | 0  | 0  | 0  | 0  | 0  |
| 2083                 | 0  | 0  | 0  | 0   | 0   | 0  | 0  | 0  | 0  | 0  | 0  |
| 2084                 | 0  | 0  | 0  | 0   | 0   | 0  | 0  | 0  | 0  | 0  | 0  |
| 2085                 | 0  | 0  | 0  | 0   | 0   | 0  | 0  | 0  | 0  | 0  | 0  |
| 2086                 | 0  | 0  | 0  | 0   | 0   | 0  | 0  | 0  | 0  | 0  | 0  |
| 2087                 | 0  | 0  | 0  | 0   | 0   | 0  | 0  | 0  | 0  | 0  | 0  |
| 2088                 | 0  | 0  | 0  | 0   | 0   | 0  | 0  | 0  | 0  | 0  | 0  |
| 2089                 | 0  | 0  | 0  | 0   | 0   | 0  | 0  | 0  | 0  | 0  | 0  |
| 2090                 | 0  | 0  | 0  | 0   | 0   | 0  | 0  | 0  | 0  | 0  | 0  |

| ScenarioID /<br>Year | 1  | 2  | 3  | 4  | 5  | 6  | 7  | 8  | 9  | 10 | 11 | 12 | 13 | 14 |
|----------------------|----|----|----|----|----|----|----|----|----|----|----|----|----|----|
| 2002                 | 0  | 0  | 0  | 0  | 0  | 0  | 0  | 0  | 0  | 0  | 0  | 0  | 0  | 0  |
| 2003                 | 0  | 0  | 0  | 0  | 0  | 0  | 0  | 0  | 0  | 0  | 0  | 0  | 0  | 0  |
| 2004                 | 1  | 1  | 1  | 1  | 1  | 1  | 1  | 1  | 1  | 1  | 1  | 1  | 1  | 1  |
| 2005                 | 2  | 2  | 2  | 2  | 2  | 2  | 2  | 2  | 2  | 2  | 2  | 2  | 2  | 2  |
| 2006                 | 3  | 3  | 3  | 3  | 3  | 3  | 3  | 3  | 3  | 3  | 3  | 3  | 3  | 3  |
| 2007                 | 7  | 7  | 7  | 7  | 7  | 7  | 7  | 7  | 7  | 7  | 7  | 7  | 7  | 7  |
| 2008                 | 10 | 10 | 10 | 10 | 10 | 10 | 10 | 10 | 10 | 10 | 10 | 10 | 10 | 10 |
| 2009                 | 17 | 17 | 17 | 17 | 17 | 17 | 17 | 17 | 17 | 17 | 17 | 17 | 17 | 17 |
| 2010                 | 19 | 19 | 19 | 19 | 19 | 19 | 19 | 19 | 19 | 19 | 19 | 19 | 19 | 19 |
| 2011                 | 30 | 30 | 30 | 30 | 30 | 30 | 30 | 30 | 30 | 30 | 30 | 30 | 30 | 30 |
| 2012                 | 27 | 27 | 27 | 27 | 27 | 27 | 27 | 27 | 27 | 27 | 27 | 27 | 27 | 27 |
| 2013                 | 31 | 31 | 31 | 31 | 31 | 31 | 31 | 31 | 31 | 31 | 31 | 31 | 31 | 31 |
| 2014                 | 32 | 32 | 32 | 32 | 32 | 32 | 32 | 32 | 32 | 32 | 32 | 32 | 32 | 32 |
| 2015                 | 41 | 41 | 41 | 41 | 41 | 41 | 41 | 41 | 41 | 41 | 41 | 41 | 41 | 41 |
| 2016                 | 37 | 37 | 37 | 37 | 37 | 37 | 37 | 37 | 37 | 37 | 37 | 37 | 37 | 37 |
| 2017                 | 44 | 44 | 44 | 44 | 44 | 44 | 44 | 44 | 44 | 44 | 44 | 44 | 44 | 44 |
| 2018                 | 44 | 44 | 44 | 44 | 44 | 44 | 44 | 44 | 44 | 44 | 44 | 44 | 44 | 44 |
| 2019                 | 45 | 45 | 45 | 45 | 45 | 45 | 45 | 45 | 45 | 45 | 45 | 45 | 45 | 45 |
| 2020                 | 47 | 47 | 47 | 68 | 47 | 47 | 47 | 47 | 47 | 47 | 47 | 47 | 63 | 47 |
| 2021                 | 49 | 49 | 49 | 68 | 49 | 49 | 49 | 49 | 49 | 49 | 49 | 49 | 63 | 49 |
| 2022                 | 47 | 47 | 47 | 64 | 47 | 47 | 47 | 47 | 47 | 47 | 47 | 47 | 63 | 47 |
| 2023                 | 50 | 50 | 50 | 61 | 50 | 50 | 50 | 50 | 50 | 50 | 50 | 50 | 65 | 50 |
| 2024                 | 49 | 49 | 49 | 62 | 49 | 49 | 49 | 49 | 49 | 49 | 49 | 49 | 59 | 49 |
| 2025                 | 72 | 72 | 52 | 60 | 72 | 72 | 72 | 72 | 72 | 69 | 69 | 52 | 64 | 69 |
| 2026                 | 73 | 73 | 51 | 62 | 73 | 73 | 73 | 73 | 73 | 66 | 66 | 51 | 62 | 66 |
| 2027                 | 65 | 65 | 51 | 60 | 65 | 65 | 65 | 65 | 65 | 61 | 61 | 51 | 63 | 61 |
| 2028                 | 70 | 70 | 53 | 61 | 70 | 70 | 70 | 70 | 70 | 66 | 65 | 53 | 63 | 65 |
| 2029                 | 61 | 61 | 51 | 56 | 61 | 61 | 61 | 61 | 61 | 63 | 62 | 51 | 63 | 62 |
| 2030                 | 64 | 64 | 77 | 56 | 64 | 63 | 64 | 64 | 64 | 59 | 59 | 72 | 52 | 59 |
| 2031                 | 65 | 65 | 76 | 56 | 65 | 65 | 65 | 65 | 65 | 63 | 62 | 69 | 56 | 62 |
| 2032                 | 59 | 59 | 71 | 56 | 59 | 60 | 59 | 59 | 59 | 61 | 60 | 67 | 55 | 58 |
| 2033                 | 60 | 60 | 66 | 52 | 60 | 59 | 60 | 60 | 60 | 57 | 59 | 59 | 54 | 58 |
| 2034                 | 59 | 59 | 70 | 51 | 58 | 59 | 59 | 59 | 59 | 56 | 55 | 64 | 50 | 55 |
| 2035                 | 44 | 44 | 62 | 49 | 46 | 49 | 44 | 44 | 44 | 56 | 54 | 60 | 55 | 52 |
| 2036                 | 53 | 53 | 58 | 54 | 52 | 54 | 53 | 53 | 53 | 48 | 49 | 53 | 51 | 52 |
| 2037                 | 56 | 54 | 54 | 31 | 53 | 53 | 54 | 54 | 54 | 57 | 56 | 56 | 49 | 55 |
| 2038                 | 45 | 45 | 51 | 5  | 44 | 44 | 45 | 45 | 45 | 48 | 46 | 52 | 5  | 49 |
| 2039                 | 48 | 49 | 49 | 8  | 46 | 48 | 49 | 49 | 49 | 46 | 46 | 46 | 3  | 47 |
| 2040                 | 6  | 6  | 46 | 7  | 6  | 6  | 6  | 6  | 6  | 6  | 6  | 44 | 6  | 7  |
| 2041                 | 7  | 7  | 46 | 8  | 7  | 6  | 7  | 7  | 7  | 6  | 7  | 46 | 6  | 7  |
| 2042                 | 10 | 10 | 8  | 12 | 9  | 9  | 10 | 10 | 10 | 7  | 7  | 37 | 7  | 7  |
| 2043                 | 11 | 11 | 9  | 12 | 11 | 12 | 11 | 11 | 11 | 13 | 13 | 8  | 14 | 13 |
| 2044                 | 11 | 11 | 10 | 11 | 11 | 10 | 11 | 11 | 11 | 13 | 14 | 12 | 15 | 13 |
| 2045                 | 13 | 13 | 15 | 14 | 12 | 13 | 13 | 13 | 13 | 12 | 13 | 14 | 10 | 12 |
| 2046                 | 14 | 14 | 14 | 13 | 14 | 14 | 14 | 14 | 14 | 13 | 13 | 15 | 12 | 13 |
| 2047                 | 9  | 9  | 10 | 8  | 9  | 9  | 9  | 9  | 9  | 9  | 9  | 8  | 7  | 9  |
| 2048                 | 10 | 10 | 10 | 8  | 10 | 11 | 10 | 10 | 10 | 9  | 9  | 13 | 7  | 9  |
| 2049                 | 3  | 3  | 3  | 3  | 3  | 3  | 3  | 3  | 3  | 2  | 2  | 3  | 1  | 2  |
| 2050                 | 2  | 2  | 2  | 2  | 2  | 3  | 2  | 2  | 2  | 1  | 1  | 2  | 1  | 1  |
| 2051                 | 3  | 3  | 3  | 3  | 3  | 4  | 3  | 3  | 3  | 2  | 2  | 3  | 2  | 2  |

| ScenarioID /<br>Year | 1 | 2 | 3 | 4 | 5 | 6 | 7 | 8 | 9 | 10 | 11 | 12 | 13 | 14 |
|----------------------|---|---|---|---|---|---|---|---|---|----|----|----|----|----|
| 2052                 | 2 | 2 | 2 | 2 | 2 | 2 | 2 | 2 | 2 | 1  | 1  | 2  | 1  | 1  |
| 2053                 | 0 | 0 | 0 | 0 | 0 | 0 | 0 | 0 | 0 | 0  | 0  | 0  | 0  | 0  |
| 2054                 | 2 | 2 | 2 | 2 | 2 | 2 | 2 | 2 | 2 | 1  | 1  | 2  | 1  | 1  |
| 2055                 | 1 | 1 | 1 | 1 | 1 | 1 | 1 | 1 | 1 | 0  | 0  | 1  | 0  | 0  |
| 2056                 | 1 | 1 | 1 | 1 | 1 | 1 | 1 | 1 | 1 | 1  | 1  | 1  | 0  | 1  |
| 2057                 | 0 | 0 | 0 | 0 | 0 | 0 | 0 | 0 | 0 | 1  | 1  | 0  | 0  | 1  |
| 2058                 | 0 | 0 | 0 | 0 | 0 | 0 | 0 | 0 | 0 | 0  | 0  | 0  | 0  | 0  |
| 2059                 | 0 | 0 | 0 | 0 | 0 | 0 | 0 | 0 | 0 | 0  | 0  | 0  | 0  | 0  |
| 2060                 | 0 | 0 | 0 | 0 | 0 | 0 | 0 | 0 | 0 | 0  | 0  | 0  | 0  | 0  |
| 2061                 | 0 | 0 | 0 | 0 | 0 | 0 | 0 | 0 | 0 | 0  | 0  | 0  | 0  | 0  |
| 2062                 | 0 | 0 | 0 | 0 | 0 | 0 | 0 | 0 | 0 | 0  | 0  | 0  | 0  | 0  |
| 2063                 | 0 | 0 | 0 | 0 | 0 | 0 | 0 | 0 | 0 | 0  | 0  | 0  | 0  | 0  |
| 2064                 | 0 | 0 | 0 | 0 | 0 | 0 | 0 | 0 | 0 | 0  | 0  | 0  | 0  | 0  |
| 2065                 | 0 | 0 | 0 | 0 | 0 | 0 | 0 | 0 | 0 | 0  | 0  | 0  | 0  | 0  |
| 2066                 | 0 | 0 | 0 | 0 | 0 | 0 | 0 | 0 | 0 | 0  | 0  | 0  | 0  | 0  |
| 2067                 | 0 | 0 | 0 | 0 | 0 | 0 | 0 | 0 | 0 | 0  | 0  | 0  | 0  | 0  |
| 2068                 | 0 | 0 | 0 | 0 | 0 | 0 | 0 | 0 | 0 | 0  | 0  | 0  | 0  | 0  |
| 2069                 | 0 | 0 | 0 | 0 | 0 | 0 | 0 | 0 | 0 | 0  | 0  | 0  | 0  | 0  |
| 2070                 | 0 | 0 | 0 | 0 | 0 | 0 | 0 | 0 | 0 | 0  | 0  | 0  | 0  | 0  |
| 2071                 | 0 | 0 | 0 | 0 | 0 | 0 | 0 | 0 | 0 | 0  | 0  | 0  | 0  | 0  |
| 2072                 | 0 | 0 | 0 | 0 | 0 | 0 | 0 | 0 | 0 | 0  | 0  | 0  | 0  | 0  |
| 2073                 | 0 | 0 | 0 | 0 | 0 | 0 | 0 | 0 | 0 | 0  | 0  | 0  | 0  | 0  |
| 2074                 | 0 | 0 | 0 | 0 | 0 | 0 | 0 | 0 | 0 | 0  | 0  | 0  | 0  | 0  |
| 2075                 | 0 | 0 | 0 | 0 | 0 | 0 | 0 | 0 | 0 | 0  | 0  | 0  | 0  | 0  |
| 2076                 | 0 | 0 | 0 | 0 | 0 | 0 | 0 | 0 | 0 | 0  | 0  | 0  | 0  | 0  |
| 2077                 | 0 | 0 | 0 | 0 | 0 | 0 | 0 | 0 | 0 | 0  | 0  | 0  | 0  | 0  |
| 2078                 | 0 | 0 | 0 | 0 | 0 | 0 | 0 | 0 | 0 | 0  | 0  | 0  | 0  | 0  |
| 2079                 | 0 | 0 | 0 | 0 | 0 | 0 | 0 | 0 | 0 | 0  | 0  | 0  | 0  | 0  |
| 2080                 | 0 | 0 | 0 | 0 | 0 | 0 | 0 | 0 | 0 | 0  | 0  | 0  | 0  | 0  |
| 2081                 | 0 | 0 | 0 | 0 | 0 | 0 | 0 | 0 | 0 | 0  | 0  | 0  | 0  | 0  |
| 2082                 | 0 | 0 | 0 | 0 | 0 | 0 | 0 | 0 | 0 | 0  | 0  | 0  | 0  | 0  |
| 2083                 | 0 | 0 | 0 | 0 | 0 | 0 | 0 | 0 | 0 | 0  | 0  | 0  | 0  | 0  |
| 2084                 | 0 | 0 | 0 | 0 | 0 | 0 | 0 | 0 | 0 | 0  | 0  | 0  | 0  | 0  |
| 2085                 | 0 | 0 | 0 | 0 | 0 | 0 | 0 | 0 | 0 | 0  | 0  | 0  | 0  | 0  |
| 2086                 | 0 | 0 | 0 | 0 | 0 | 0 | 0 | 0 | 0 | 0  | 0  | 0  | 0  | 0  |
| 2087                 | 0 | 0 | 0 | 0 | 0 | 0 | 0 | 0 | 0 | 0  | 0  | 0  | 0  | 0  |
| 2088                 | 0 | 0 | 0 | 0 | 0 | 0 | 0 | 0 | 0 | 0  | 0  | 0  | 0  | 0  |
| 2089                 | 0 | 0 | 0 | 0 | 0 | 0 | 0 | 0 | 0 | 0  | 0  | 0  | 0  | 0  |
| 2090                 | 0 | 0 | 0 | 0 | 0 | 0 | 0 | 0 | 0 | 0  | 0  | 0  | 0  | 0  |

| ScenarioID /<br>Year | 15 | 16 | 17 | 18 | 19 | 20 | 21 | 22 | 23 | 24 | 25 | 26 | 27 | 28 |
|----------------------|----|----|----|----|----|----|----|----|----|----|----|----|----|----|
| 2002                 | 0  | 0  | 0  | 0  | 0  | 0  | 0  | 0  | 0  | 0  | 0  | 0  | 0  | 0  |
| 2003                 | 0  | 0  | 0  | 0  | 0  | 0  | 0  | 0  | 0  | 0  | 0  | 0  | 0  | 0  |
| 2004                 | 1  | 1  | 1  | 1  | 1  | 1  | 1  | 1  | 1  | 1  | 1  | 1  | 1  | 1  |
| 2005                 | 2  | 2  | 2  | 2  | 2  | 2  | 2  | 2  | 2  | 2  | 2  | 2  | 2  | 2  |
| 2006                 | 3  | 3  | 3  | 3  | 3  | 3  | 3  | 3  | 3  | 3  | 3  | 3  | 3  | 3  |
| 2007                 | 7  | 7  | 7  | 7  | 7  | 7  | 7  | 7  | 7  | 7  | 7  | 7  | 7  | 7  |
| 2008                 | 10 | 10 | 10 | 10 | 10 | 10 | 10 | 10 | 10 | 10 | 10 | 10 | 10 | 10 |
| 2009                 | 17 | 17 | 17 | 17 | 17 | 17 | 17 | 17 | 17 | 17 | 17 | 17 | 17 | 17 |
| 2010                 | 19 | 19 | 19 | 19 | 19 | 19 | 19 | 19 | 19 | 19 | 19 | 19 | 19 | 19 |
| 2011                 | 30 | 30 | 30 | 30 | 30 | 30 | 30 | 30 | 30 | 30 | 30 | 30 | 30 | 30 |
| 2012                 | 27 | 27 | 27 | 27 | 27 | 27 | 27 | 27 | 27 | 27 | 27 | 27 | 27 | 27 |
| 2013                 | 31 | 31 | 31 | 31 | 31 | 31 | 31 | 31 | 31 | 31 | 31 | 31 | 31 | 31 |
| 2014                 | 32 | 32 | 32 | 32 | 32 | 32 | 32 | 32 | 32 | 32 | 32 | 32 | 32 | 32 |
| 2015                 | 41 | 41 | 41 | 41 | 41 | 41 | 41 | 41 | 41 | 41 | 41 | 41 | 41 | 41 |
| 2016                 | 37 | 37 | 37 | 37 | 37 | 37 | 37 | 37 | 37 | 37 | 37 | 37 | 37 | 37 |
| 2017                 | 44 | 44 | 44 | 44 | 44 | 44 | 44 | 44 | 44 | 44 | 44 | 44 | 44 | 44 |
| 2018                 | 44 | 44 | 44 | 44 | 44 | 44 | 44 | 44 | 44 | 44 | 44 | 44 | 44 | 44 |
| 2019                 | 45 | 45 | 45 | 45 | 45 | 45 | 45 | 45 | 45 | 45 | 45 | 45 | 45 | 45 |
| 2020                 | 47 | 47 | 47 | 47 | 47 | 47 | 47 | 63 | 47 | 47 | 47 | 47 | 47 | 47 |
| 2021                 | 49 | 49 | 49 | 49 | 49 | 49 | 49 | 63 | 49 | 49 | 49 | 49 | 49 | 49 |
| 2022                 | 47 | 47 | 47 | 47 | 47 | 47 | 47 | 64 | 47 | 47 | 47 | 47 | 47 | 47 |
| 2023                 | 50 | 50 | 50 | 50 | 50 | 50 | 50 | 65 | 50 | 50 | 50 | 50 | 50 | 50 |
| 2024                 | 49 | 49 | 49 | 49 | 49 | 49 | 49 | 58 | 49 | 49 | 49 | 49 | 49 | 49 |
| 2025                 | 69 | 69 | 69 | 69 | 69 | 69 | 52 | 63 | 69 | 69 | 69 | 69 | 69 | 74 |
| 2026                 | 65 | 66 | 66 | 66 | 66 | 66 | 51 | 58 | 66 | 67 | 66 | 66 | 66 | 67 |
| 2027                 | 61 | 61 | 61 | 61 | 60 | 60 | 51 | 57 | 60 | 60 | 60 | 60 | 60 | 66 |
| 2028                 | 65 | 65 | 65 | 65 | 66 | 66 | 53 | 60 | 66 | 66 | 66 | 66 | 66 | 65 |
| 2029                 | 63 | 62 | 62 | 62 | 61 | 61 | 51 | 58 | 61 | 60 | 61 | 61 | 61 | 61 |
| 2030                 | 58 | 59 | 59 | 59 | 60 | 59 | 72 | 53 | 58 | 59 | 59 | 59 | 59 | 65 |
| 2031                 | 62 | 62 | 62 | 62 | 61 | 61 | 68 | 56 | 60 | 61 | 61 | 61 | 61 | 66 |
| 2032                 | 61 | 60 | 60 | 60 | 60 | 60 | 66 | 55 | 57 | 60 | 61 | 61 | 61 | 60 |
| 2033                 | 61 | 59 | 59 | 59 | 54 | 55 | 59 | 51 | 57 | 57 | 55 | 55 | 55 | 58 |
| 2034                 | 54 | 55 | 55 | 55 | 55 | 55 | 63 | 48 | 54 | 55 | 55 | 55 | 55 | 62 |
| 2035                 | 51 | 55 | 55 | 55 | 51 | 49 | 60 | 51 | 49 | 50 | 50 | 50 | 50 | 51 |
| 2036                 | 49 | 49 | 49 | 49 | 48 | 48 | 53 | 48 | 48 | 49 | 48 | 48 | 48 | 51 |
| 2037                 | 54 | 56 | 56 | 56 | 53 | 51 | 55 | 50 | 51 | 53 | 51 | 51 | 51 | 53 |
| 2038                 | 48 | 46 | 46 | 46 | 47 | 47 | 53 | 7  | 48 | 51 | 47 | 47 | 47 | 46 |
| 2039                 | 44 | 46 | 46 | 46 | 45 | 42 | 45 | 4  | 43 | 43 | 42 | 42 | 42 | 45 |
| 2040                 | 5  | 6  | 6  | 6  | 8  | 7  | 45 | 6  | 7  | 6  | 8  | 8  | 8  | 47 |
| 2041                 | 7  | 7  | 7  | 7  | 6  | 6  | 44 | 8  | 6  | 7  | 6  | 6  | 6  | 47 |
| 2042                 | 7  | 7  | 7  | 7  | 9  | 8  | 6  | 9  | 8  | 9  | 8  | 8  | 8  | 44 |
| 2043                 | 13 | 13 | 13 | 13 | 14 | 14 | 11 | 13 | 14 | 14 | 14 | 14 | 14 | 38 |
| 2044                 | 13 | 14 | 14 | 14 | 14 | 14 | 12 | 15 | 14 | 14 | 13 | 13 | 13 | 35 |
| 2045                 | 12 | 13 | 13 | 13 | 14 | 14 | 14 | 11 | 14 | 14 | 13 | 13 | 13 | 39 |
| 2046                 | 13 | 13 | 13 | 13 | 14 | 14 | 13 | 13 | 14 | 14 | 14 | 14 | 14 | 37 |
| 2047                 | 9  | 9  | 9  | 9  | 8  | 8  | 9  | 9  | 8  | 9  | 8  | 8  | 8  | 29 |
| 2048                 | 10 | 9  | 9  | 9  | 9  | 9  | 12 | 9  | 9  | 10 | 9  | 9  | 9  | 32 |
| 2049                 | 2  | 2  | 2  | 2  | 2  | 2  | 3  | 2  | 2  | 2  | 2  | 2  | 2  | 28 |
| 2050                 | 2  | 1  | 1  | 1  | 1  | 1  | 2  | 2  | 1  | 2  | 1  | 1  | 1  | 30 |
| 2051                 | 3  | 2  | 2  | 2  | 2  | 2  | 3  | 2  | 2  | 3  | 2  | 2  | 2  | 31 |

| ScenarioID /<br>Year | 15 | 16 | 17 | 18 | 19 | 20 | 21 | 22 | 23 | 24 | 25 | 26 | 27 | 28 |
|----------------------|----|----|----|----|----|----|----|----|----|----|----|----|----|----|
| 2052                 | 1  | 1  | 1  | 1  | 1  | 1  | 2  | 1  | 1  | 1  | 1  | 1  | 1  | 32 |
| 2053                 | 0  | 0  | 0  | 0  | 0  | 0  | 0  | 0  | 0  | 0  | 0  | 0  | 0  | 39 |
| 2054                 | 1  | 1  | 1  | 1  | 1  | 1  | 2  | 1  | 1  | 1  | 1  | 1  | 1  | 40 |
| 2055                 | 0  | 0  | 0  | 0  | 0  | 0  | 1  | 0  | 0  | 0  | 0  | 0  | 0  | 34 |
| 2056                 | 1  | 1  | 1  | 1  | 1  | 1  | 1  | 0  | 1  | 1  | 1  | 1  | 1  | 37 |
| 2057                 | 1  | 1  | 1  | 1  | 1  | 1  | 0  | 0  | 1  | 1  | 1  | 1  | 1  | 34 |
| 2058                 | 0  | 0  | 0  | 0  | 0  | 0  | 0  | 0  | 0  | 0  | 0  | 0  | 0  | 27 |
| 2059                 | 0  | 0  | 0  | 0  | 0  | 0  | 0  | 0  | 0  | 0  | 0  | 0  | 0  | 22 |
| 2060                 | 0  | 0  | 0  | 0  | 0  | 0  | 0  | 0  | 0  | 0  | 0  | 0  | 0  | 9  |
| 2061                 | 0  | 0  | 0  | 0  | 0  | 0  | 0  | 0  | 0  | 0  | 0  | 0  | 0  | 11 |
| 2062                 | 0  | 0  | 0  | 0  | 0  | 0  | 0  | 0  | 0  | 0  | 0  | 0  | 0  | 8  |
| 2063                 | 0  | 0  | 0  | 0  | 0  | 0  | 0  | 0  | 0  | 0  | 0  | 0  | 0  | 7  |
| 2064                 | 0  | 0  | 0  | 0  | 0  | 0  | 0  | 0  | 0  | 0  | 0  | 0  | 0  | 5  |
| 2065                 | 0  | 0  | 0  | 0  | 0  | 0  | 0  | 0  | 0  | 0  | 0  | 0  | 0  | 8  |
| 2066                 | 0  | 0  | 0  | 0  | 0  | 0  | 0  | 0  | 0  | 0  | 0  | 0  | 0  | 4  |
| 2067                 | 0  | 0  | 0  | 0  | 0  | 0  | 0  | 0  | 0  | 0  | 0  | 0  | 0  | 2  |
| 2068                 | 0  | 0  | 0  | 0  | 0  | 0  | 0  | 0  | 0  | 0  | 0  | 0  | 0  | 2  |
| 2069                 | 0  | 0  | 0  | 0  | 0  | 0  | 0  | 0  | 0  | 0  | 0  | 0  | 0  | 2  |
| 2070                 | 0  | 0  | 0  | 0  | 0  | 0  | 0  | 0  | 0  | 0  | 0  | 0  | 0  | 0  |
| 2071                 | 0  | 0  | 0  | 0  | 0  | 0  | 0  | 0  | 0  | 0  | 0  | 0  | 0  | 0  |
| 2072                 | 0  | 0  | 0  | 0  | 0  | 0  | 0  | 0  | 0  | 0  | 0  | 0  | 0  | 0  |
| 2073                 | 0  | 0  | 0  | 0  | 0  | 0  | 0  | 0  | 0  | 0  | 0  | 0  | 0  | 0  |
| 2074                 | 0  | 0  | 0  | 0  | 0  | 0  | 0  | 0  | 0  | 0  | 0  | 0  | 0  | 0  |
| 2075                 | 0  | 0  | 0  | 0  | 0  | 0  | 0  | 0  | 0  | 0  | 0  | 0  | 0  | 0  |
| 2076                 | 0  | 0  | 0  | 0  | 0  | 0  | 0  | 0  | 0  | 0  | 0  | 0  | 0  | 0  |
| 2077                 | 0  | 0  | 0  | 0  | 0  | 0  | 0  | 0  | 0  | 0  | 0  | 0  | 0  | 0  |
| 2078                 | 0  | 0  | 0  | 0  | 0  | 0  | 0  | 0  | 0  | 0  | 0  | 0  | 0  | 0  |
| 2079                 | 0  | 0  | 0  | 0  | 0  | 0  | 0  | 0  | 0  | 0  | 0  | 0  | 0  | 0  |
| 2080                 | 0  | 0  | 0  | 0  | 0  | 0  | 0  | 0  | 0  | 0  | 0  | 0  | 0  | 0  |
| 2081                 | 0  | 0  | 0  | 0  | 0  | 0  | 0  | 0  | 0  | 0  | 0  | 0  | 0  | 0  |
| 2082                 | 0  | 0  | 0  | 0  | 0  | 0  | 0  | 0  | 0  | 0  | 0  | 0  | 0  | 0  |
| 2083                 | 0  | 0  | 0  | 0  | 0  | 0  | 0  | 0  | 0  | 0  | 0  | 0  | 0  | 0  |
| 2084                 | 0  | 0  | 0  | 0  | 0  | 0  | 0  | 0  | 0  | 0  | 0  | 0  | 0  | 0  |
| 2085                 | 0  | 0  | 0  | 0  | 0  | 0  | 0  | 0  | 0  | 0  | 0  | 0  | 0  | 0  |
| 2086                 | 0  | 0  | 0  | 0  | 0  | 0  | 0  | 0  | 0  | 0  | 0  | 0  | 0  | 0  |
| 2087                 | 0  | 0  | 0  | 0  | 0  | 0  | 0  | 0  | 0  | 0  | 0  | 0  | 0  | 0  |
| 2088                 | 0  | 0  | 0  | 0  | 0  | 0  | 0  | 0  | 0  | 0  | 0  | 0  | 0  | 0  |
| 2089                 | 0  | 0  | 0  | 0  | 0  | 0  | 0  | 0  | 0  | 0  | 0  | 0  | 0  | 0  |
| 2090                 | 0  | 0  | 0  | 0  | 0  | 0  | 0  | 0  | 0  | 0  | 0  | 0  | 0  | 0  |

| ScenarioID /<br>Year | 29 | 30 | 31 | 32 | 33 | 34 | 35 | 36 | 37 | 38 | 39 | 40 | 41 | 42 |
|----------------------|----|----|----|----|----|----|----|----|----|----|----|----|----|----|
| 2002                 | 0  | 0  | 0  | 0  | 0  | 0  | 0  | 0  | 0  | 0  | 0  | 0  | 0  | 0  |
| 2003                 | 0  | 0  | 0  | 0  | 0  | 0  | 0  | 0  | 0  | 0  | 0  | 0  | 0  | 0  |
| 2004                 | 1  | 1  | 1  | 1  | 1  | 1  | 1  | 1  | 1  | 1  | 1  | 1  | 1  | 1  |
| 2005                 | 2  | 2  | 2  | 2  | 2  | 2  | 2  | 2  | 2  | 2  | 2  | 2  | 2  | 2  |
| 2006                 | 3  | 3  | 3  | 3  | 3  | 3  | 3  | 3  | 3  | 3  | 3  | 3  | 3  | 3  |
| 2007                 | 7  | 7  | 7  | 7  | 7  | 7  | 7  | 7  | 7  | 7  | 7  | 7  | 7  | 7  |
| 2008                 | 10 | 10 | 10 | 10 | 10 | 10 | 10 | 10 | 10 | 10 | 10 | 10 | 10 | 10 |
| 2009                 | 17 | 17 | 17 | 17 | 17 | 17 | 17 | 17 | 17 | 17 | 17 | 17 | 17 | 17 |
| 2010                 | 19 | 19 | 19 | 19 | 19 | 19 | 19 | 19 | 19 | 19 | 19 | 19 | 19 | 19 |
| 2011                 | 30 | 30 | 30 | 30 | 30 | 30 | 30 | 30 | 30 | 30 | 30 | 30 | 30 | 30 |
| 2012                 | 27 | 27 | 27 | 27 | 27 | 27 | 27 | 27 | 27 | 27 | 27 | 27 | 27 | 27 |
| 2013                 | 31 | 31 | 31 | 31 | 31 | 31 | 31 | 31 | 31 | 31 | 31 | 31 | 31 | 31 |
| 2014                 | 32 | 32 | 32 | 32 | 32 | 32 | 32 | 32 | 32 | 32 | 32 | 32 | 32 | 32 |
| 2015                 | 41 | 41 | 41 | 41 | 41 | 41 | 41 | 41 | 41 | 41 | 41 | 41 | 41 | 41 |
| 2016                 | 37 | 37 | 37 | 37 | 37 | 37 | 37 | 37 | 37 | 37 | 37 | 37 | 37 | 37 |
| 2017                 | 44 | 44 | 44 | 44 | 44 | 44 | 44 | 44 | 44 | 44 | 44 | 44 | 44 | 44 |
| 2018                 | 44 | 44 | 44 | 44 | 44 | 44 | 44 | 44 | 44 | 44 | 44 | 44 | 44 | 44 |
| 2019                 | 45 | 45 | 45 | 45 | 45 | 45 | 45 | 45 | 45 | 45 | 45 | 45 | 45 | 45 |
| 2020                 | 47 | 47 | 69 | 47 | 47 | 47 | 47 | 47 | 47 | 47 | 47 | 58 | 47 | 47 |
| 2021                 | 49 | 49 | 64 | 49 | 49 | 49 | 49 | 49 | 49 | 49 | 49 | 58 | 49 | 49 |
| 2022                 | 47 | 47 | 59 | 47 | 47 | 47 | 47 | 47 | 47 | 47 | 47 | 56 | 47 | 47 |
| 2023                 | 50 | 50 | 62 | 50 | 50 | 50 | 50 | 50 | 50 | 50 | 50 | 57 | 50 | 50 |
| 2024                 | 49 | 49 | 62 | 49 | 49 | 49 | 49 | 49 | 49 | 49 | 49 | 54 | 49 | 49 |
| 2025                 | 74 | 52 | 60 | 74 | 74 | 74 | 74 | 74 | 63 | 63 | 52 | 57 | 63 | 63 |
| 2026                 | 67 | 51 | 62 | 67 | 67 | 67 | 67 | 67 | 55 | 55 | 51 | 55 | 55 | 55 |
| 2027                 | 66 | 51 | 62 | 66 | 66 | 66 | 66 | 66 | 56 | 56 | 51 | 56 | 56 | 56 |
| 2028                 | 65 | 53 | 58 | 65 | 65 | 65 | 65 | 65 | 60 | 60 | 53 | 56 | 59 | 58 |
| 2029                 | 61 | 51 | 57 | 61 | 61 | 61 | 61 | 61 | 55 | 56 | 51 | 53 | 56 | 55 |
| 2030                 | 65 | 80 | 62 | 65 | 65 | 65 | 65 | 65 | 53 | 55 | 63 | 53 | 55 | 54 |
| 2031                 | 66 | 69 | 57 | 66 | 65 | 66 | 66 | 66 | 56 | 56 | 61 | 53 | 56 | 56 |
| 2032                 | 61 | 67 | 57 | 62 | 61 | 61 | 61 | 61 | 54 | 51 | 57 | 55 | 52 | 52 |
| 2033                 | 58 | 62 | 49 | 57 | 57 | 58 | 58 | 58 | 56 | 51 | 55 | 58 | 51 | 52 |
| 2034                 | 60 | 66 | 56 | 60 | 61 | 60 | 60 | 60 | 51 | 52 | 57 | 60 | 54 | 55 |
| 2035                 | 52 | 57 | 46 | 51 | 54 | 52 | 52 | 52 | 56 | 53 | 56 | 57 | 51 | 56 |
| 2036                 | 50 | 57 | 41 | 47 | 51 | 51 | 51 | 51 | 46 | 45 | 48 | 48 | 47 | 55 |
| 2037                 | 52 | 56 | 42 | 49 | 52 | 50 | 50 | 50 | 47 | 48 | 48 | 53 | 48 | 50 |
| 2038                 | 44 | 46 | 36 | 42 | 46 | 43 | 43 | 43 | 47 | 39 | 45 | 43 | 41 | 50 |
| 2039                 | 47 | 46 | 37 | 45 | 42 | 48 | 48 | 48 | 41 | 42 | 39 | 46 | 44 | 44 |
| 2040                 | 43 | 48 | 42 | 46 | 44 | 44 | 44 | 44 | 42 | 44 | 40 | 40 | 39 | 43 |
| 2041                 | 43 | 46 | 41 | 40 | 43 | 41 | 41 | 41 | 45 | 43 | 38 | 44 | 39 | 43 |
| 2042                 | 42 | 47 | 43 | 42 | 42 | 46 | 46 | 46 | 43 | 42 | 40 | 42 | 41 | 33 |
| 2043                 | 40 | 42 | 40 | 38 | 40 | 38 | 38 | 38 | 42 | 44 | 38 | 46 | 40 | 39 |
| 2044                 | 38 | 40 | 35 | 36 | 41 | 39 | 39 | 39 | 39 | 37 | 38 | 39 | 41 | 36 |
| 2045                 | 38 | 39 | 36 | 37 | 39 | 39 | 39 | 39 | 39 | 36 | 44 | 40 | 40 | 44 |
| 2046                 | 37 | 36 | 37 | 34 | 43 | 36 | 36 | 36 | 42 | 36 | 41 | 31 | 38 | 38 |
| 2047                 | 29 | 31 | 29 | 30 | 34 | 29 | 29 | 29 | 43 | 36 | 41 | 36 | 40 | 44 |
| 2048                 | 31 | 33 | 34 | 30 | 34 | 31 | 31 | 31 | 47 | 44 | 40 | 39 | 40 | 47 |
| 2049                 | 27 | 27 | 30 | 27 | 31 | 28 | 28 | 28 | 39 | 36 | 33 | 36 | 39 | 48 |
| 2050                 | 28 | 28 | 30 | 27 | 27 | 29 | 29 | 29 | 38 | 36 | 30 | 37 | 29 | 43 |
| 2051                 | 29 | 27 | 34 | 30 | 31 | 30 | 30 | 30 | 32 | 31 | 29 | 35 | 31 | 45 |



| ScenarioID /<br>Year | 29 | 30 | 31 | 32 | 33 | 34 | 35 | 36 | 37 | 38 | 39 | 40 | 41 | 42 |
|----------------------|----|----|----|----|----|----|----|----|----|----|----|----|----|----|
| 2052                 | 32 | 31 | 36 | 30 | 34 | 32 | 32 | 32 | 34 | 30 | 25 | 30 | 28 | 39 |
| 2053                 | 34 | 31 | 36 | 31 | 32 | 34 | 34 | 34 | 31 | 29 | 25 | 33 | 29 | 42 |
| 2054                 | 36 | 32 | 35 | 31 | 36 | 37 | 37 | 37 | 28 | 30 | 26 | 37 | 26 | 39 |
| 2055                 | 36 | 30 | 33 | 31 | 33 | 36 | 36 | 36 | 32 | 32 | 32 | 37 | 29 | 36 |
| 2056                 | 37 | 33 | 31 | 29 | 31 | 39 | 39 | 39 | 31 | 35 | 37 | 37 | 30 | 38 |
| 2057                 | 33 | 34 | 26 | 32 | 36 | 34 | 34 | 34 | 34 | 36 | 36 | 39 | 34 | 38 |
| 2058                 | 36 | 37 | 14 | 34 | 35 | 33 | 33 | 33 | 39 | 35 | 32 | 41 | 33 | 43 |
| 2059                 | 24 | 37 | 13 | 29 | 20 | 24 | 24 | 24 | 35 | 36 | 32 | 39 | 31 | 42 |
| 2060                 | 12 | 27 | 7  | 23 | 17 | 12 | 12 | 12 | 38 | 37 | 29 | 36 | 34 | 38 |
| 2061                 | 12 | 26 | 9  | 16 | 16 | 11 | 11 | 11 | 38 | 35 | 30 | 33 | 33 | 40 |
| 2062                 | 10 | 19 | 7  | 10 | 13 | 9  | 9  | 9  | 31 | 41 | 31 | 26 | 23 | 34 |
| 2063                 | 9  | 13 | 6  | 9  | 12 | 8  | 8  | 8  | 27 | 32 | 32 | 22 | 21 | 31 |
| 2064                 | 5  | 10 | 4  | 6  | 10 | 5  | 5  | 5  | 26 | 26 | 35 | 18 | 19 | 27 |
| 2065                 | 8  | 9  | 6  | 7  | 9  | 8  | 8  | 8  | 20 | 22 | 29 | 15 | 12 | 18 |
| 2066                 | 5  | 9  | 2  | 4  | 4  | 5  | 5  | 5  | 13 | 16 | 25 | 10 | 10 | 13 |
| 2067                 | 3  | 9  | 1  | 3  | 6  | 2  | 2  | 2  | 11 | 14 | 18 | 8  | 6  | 13 |
| 2068                 | 1  | 5  | 1  | 2  | 3  | 2  | 2  | 2  | 7  | 9  | 10 | 6  | 7  | 11 |
| 2069                 | 2  | 6  | 1  | 0  | 1  | 2  | 2  | 2  | 6  | 8  | 9  | 4  | 5  | 9  |
| 2070                 | 1  | 3  | 0  | 1  | 1  | 0  | 0  | 0  | 5  | 5  | 6  | 4  | 3  | 8  |
| 2071                 | 0  | 1  | 0  | 1  | 1  | 0  | 0  | 0  | 4  | 4  | 6  | 3  | 2  | 5  |
| 2072                 | 0  | 2  | 0  | 0  | 1  | 0  | 0  | 0  | 2  | 3  | 6  | 3  | 1  | 5  |
| 2073                 | 0  | 2  | 0  | 0  | 0  | 0  | 0  | 0  | 2  | 3  | 5  | 2  | 1  | 2  |
| 2074                 | 0  | 1  | 0  | 0  | 1  | 0  | 0  | 0  | 2  | 2  | 3  | 1  | 0  | 1  |
| 2075                 | 0  | 1  | 0  | 0  | 1  | 0  | 0  | 0  | 1  | 1  | 3  | 0  | 0  | 1  |
| 2076                 | 0  | 1  | 0  | 0  | 0  | 0  | 0  | 0  | 0  | 0  | 1  | 0  | 0  | 1  |
| 2077                 | 0  | 0  | 0  | 0  | 1  | 0  | 0  | 0  | 0  | 0  | 0  | 0  | 0  | 1  |
| 2078                 | 0  | 0  | 0  | 0  | 0  | 0  | 0  | 0  | 0  | 0  | 0  | 0  | 0  | 1  |
| 2079                 | 0  | 0  | 0  | 0  | 0  | 0  | 0  | 0  | 0  | 0  | 0  | 0  | 0  | 1  |
| 2080                 | 0  | 0  | 0  | 0  | 0  | 0  | 0  | 0  | 0  | 0  | 0  | 0  | 0  | 1  |
| 2081                 | 0  | 0  | 0  | 0  | 0  | 0  | 0  | 0  | 0  | 0  | 0  | 0  | 0  | 1  |
| 2082                 | 0  | 0  | 0  | 0  | 0  | 0  | 0  | 0  | 0  | 0  | 0  | 0  | 0  | 1  |
| 2083                 | 0  | 0  | 0  | 0  | 0  | 0  | 0  | 0  | 0  | 0  | 0  | 0  | 0  | 1  |
| 2084                 | 0  | 0  | 0  | 0  | 0  | 0  | 0  | 0  | 0  | 0  | 0  | 0  | 0  | 0  |
| 2085                 | 0  | 0  | 0  | 0  | 0  | 0  | 0  | 0  | 0  | 0  | 0  | 0  | 0  | 0  |
| 2086                 | 0  | 0  | 0  | 0  | 0  | 0  | 0  | 0  | 0  | 0  | 0  | 0  | 0  | 0  |
| 2087                 | 0  | 0  | 0  | 0  | 0  | 0  | 0  | 0  | 0  | 0  | 0  | 0  | 0  | 0  |
| 2088                 | 0  | 0  | 0  | 0  | 0  | 0  | 0  | 0  | 0  | 0  | 0  | 0  | 0  | 0  |
| 2089                 | 0  | 0  | 0  | 0  | 0  | 0  | 0  | 0  | 0  | 0  | 0  | 0  | 0  | 0  |
| 2090                 | 0  | 0  | 0  | 0  | 0  | 0  | 0  | 0  | 0  | 0  | 0  | 0  | 0  | 0  |

| ScenarioID /<br>Year | 43 | 44 | 45 | 46 | 47 | 48 | 49 | 50 | 51 | 52 | 53 | 54 | 55 | 56 |
|----------------------|----|----|----|----|----|----|----|----|----|----|----|----|----|----|
| 2002                 | 0  | 0  | 0  | 0  | 0  | 0  | 0  | 0  | 0  | 0  | 0  | 0  | 0  | 0  |
| 2003                 | 0  | 0  | 0  | 0  | 0  | 0  | 0  | 0  | 0  | 0  | 0  | 0  | 0  | 0  |
| 2004                 | 1  | 1  | 1  | 1  | 1  | 1  | 1  | 1  | 1  | 1  | 1  | 1  | 1  | 1  |
| 2005                 | 2  | 2  | 2  | 2  | 2  | 2  | 2  | 2  | 2  | 2  | 2  | 2  | 2  | 2  |
| 2006                 | 3  | 3  | 3  | 3  | 3  | 3  | 3  | 3  | 3  | 3  | 3  | 3  | 3  | 3  |
| 2007                 | 7  | 7  | 7  | 7  | 7  | 7  | 7  | 7  | 7  | 7  | 7  | 7  | 7  | 7  |
| 2008                 | 10 | 10 | 10 | 10 | 10 | 10 | 10 | 10 | 10 | 10 | 10 | 10 | 10 | 10 |
| 2009                 | 17 | 17 | 17 | 17 | 17 | 17 | 17 | 17 | 17 | 17 | 17 | 17 | 17 | 17 |
| 2010                 | 19 | 19 | 19 | 19 | 19 | 19 | 19 | 19 | 19 | 19 | 19 | 19 | 19 | 19 |
| 2011                 | 30 | 30 | 30 | 30 | 30 | 30 | 30 | 30 | 30 | 30 | 30 | 30 | 30 | 30 |
| 2012                 | 27 | 27 | 27 | 27 | 27 | 27 | 27 | 27 | 27 | 27 | 27 | 27 | 27 | 27 |
| 2013                 | 31 | 31 | 31 | 31 | 31 | 31 | 31 | 31 | 31 | 31 | 31 | 31 | 31 | 31 |
| 2014                 | 32 | 32 | 32 | 32 | 32 | 32 | 32 | 32 | 32 | 32 | 32 | 32 | 32 | 32 |
| 2015                 | 41 | 41 | 41 | 41 | 41 | 41 | 41 | 41 | 41 | 41 | 41 | 41 | 41 | 41 |
| 2016                 | 37 | 37 | 37 | 37 | 37 | 37 | 37 | 37 | 37 | 37 | 37 | 37 | 37 | 37 |
| 2017                 | 44 | 44 | 44 | 44 | 44 | 44 | 44 | 44 | 44 | 44 | 44 | 44 | 44 | 44 |
| 2018                 | 44 | 44 | 44 | 44 | 44 | 44 | 44 | 44 | 44 | 44 | 44 | 44 | 44 | 44 |
| 2019                 | 45 | 45 | 45 | 45 | 45 | 45 | 45 | 45 | 45 | 45 | 45 | 45 | 45 | 45 |
| 2020                 | 47 | 47 | 47 | 47 | 47 | 47 | 58 | 47 | 47 | 47 | 47 | 47 | 47 | 47 |
| 2021                 | 49 | 49 | 49 | 49 | 49 | 49 | 58 | 49 | 49 | 49 | 49 | 49 | 49 | 49 |
| 2022                 | 47 | 47 | 47 | 47 | 47 | 47 | 56 | 47 | 47 | 47 | 47 | 47 | 47 | 47 |
| 2023                 | 50 | 50 | 50 | 50 | 50 | 50 | 58 | 50 | 50 | 50 | 50 | 50 | 50 | 50 |
| 2024                 | 49 | 49 | 49 | 49 | 49 | 49 | 52 | 49 | 49 | 49 | 49 | 49 | 49 | 49 |
| 2025                 | 63 | 63 | 63 | 63 | 63 | 52 | 57 | 63 | 63 | 63 | 63 | 63 | 52 | 52 |
| 2026                 | 55 | 55 | 55 | 55 | 55 | 51 | 55 | 55 | 55 | 55 | 55 | 55 | 38 | 38 |
| 2027                 | 56 | 56 | 56 | 56 | 56 | 51 | 55 | 56 | 56 | 56 | 56 | 56 | 31 | 31 |
| 2028                 | 59 | 59 | 59 | 60 | 60 | 53 | 56 | 60 | 58 | 60 | 60 | 60 | 31 | 31 |
| 2029                 | 56 | 56 | 56 | 57 | 57 | 51 | 52 | 56 | 55 | 56 | 56 | 56 | 30 | 30 |
| 2030                 | 55 | 55 | 55 | 54 | 55 | 63 | 56 | 55 | 54 | 54 | 54 | 54 | 31 | 29 |
| 2031                 | 55 | 55 | 55 | 55 | 55 | 61 | 52 | 56 | 54 | 55 | 55 | 55 | 30 | 29 |
| 2032                 | 50 | 50 | 50 | 51 | 51 | 57 | 50 | 51 | 51 | 51 | 51 | 51 | 32 | 30 |
| 2033                 | 53 | 53 | 53 | 50 | 47 | 55 | 52 | 48 | 51 | 49 | 49 | 49 | 28 | 29 |
| 2034                 | 51 | 51 | 51 | 50 | 50 | 57 | 54 | 49 | 55 | 50 | 50 | 50 | 31 | 31 |
| 2035                 | 54 | 54 | 54 | 51 | 51 | 56 | 51 | 52 | 57 | 52 | 52 | 52 | 31 | 31 |
| 2036                 | 45 | 45 | 45 | 44 | 45 | 45 | 44 | 46 | 48 | 44 | 44 | 44 | 30 | 29 |
| 2037                 | 48 | 48 | 48 | 46 | 46 | 48 | 52 | 44 | 47 | 45 | 45 | 45 | 31 | 30 |
| 2038                 | 41 | 41 | 41 | 44 | 45 | 41 | 47 | 39 | 50 | 44 | 44 | 44 | 30 | 28 |
| 2039                 | 42 | 42 | 42 | 44 | 42 | 36 | 47 | 44 | 43 | 40 | 40 | 40 | 30 | 29 |
| 2040                 | 47 | 47 | 47 | 42 | 43 | 41 | 48 | 46 | 47 | 42 | 42 | 42 | 32 | 31 |
| 2041                 | 46 | 46 | 46 | 42 | 38 | 36 | 47 | 42 | 46 | 42 | 42 | 42 | 34 | 30 |
| 2042                 | 43 | 43 | 43 | 48 | 43 | 41 | 42 | 40 | 46 | 47 | 47 | 47 | 0  | 28 |
| 2043                 | 42 | 42 | 42 | 55 | 44 | 38 | 45 | 42 | 43 | 49 | 49 | 49 | 2  | 2  |
| 2044                 | 38 | 38 | 38 | 49 | 44 | 39 | 45 | 39 | 44 | 49 | 49 | 49 | 4  | 5  |
| 2045                 | 39 | 39 | 39 | 40 | 46 | 38 | 44 | 43 | 42 | 41 | 41 | 41 | 3  | 4  |
| 2046                 | 40 | 40 | 40 | 37 | 42 | 38 | 42 | 40 | 40 | 39 | 39 | 39 | 6  | 4  |
| 2047                 | 39 | 39 | 39 | 38 | 37 | 37 | 37 | 33 | 39 | 36 | 36 | 36 | 9  | 8  |
| 2048                 | 48 | 48 | 48 | 36 | 34 | 40 | 41 | 31 | 41 | 35 | 35 | 35 | 5  | 7  |
| 2049                 | 40 | 40 | 40 | 35 | 35 | 33 | 40 | 30 | 42 | 37 | 37 | 37 | 1  | 1  |
| 2050                 | 34 | 34 | 34 | 35 | 34 | 35 | 35 | 33 | 38 | 33 | 33 | 33 | 2  | 2  |
| 2051                 | 32 | 32 | 32 | 37 | 37 | 37 | 36 | 34 | 41 | 35 | 35 | 35 | 2  | 2  |

| ScenarioID /<br>Year | 43 | 44 | 45 | 46 | 47 | 48 | 49 | 50 | 51 | 52 | 53 | 54 | 55 | 56 |
|----------------------|----|----|----|----|----|----|----|----|----|----|----|----|----|----|
| 2052                 | 31 | 31 | 31 | 40 | 39 | 31 | 39 | 33 | 42 | 40 | 40 | 40 | 1  | 1  |
| 2053                 | 30 | 30 | 30 | 36 | 33 | 33 | 36 | 34 | 47 | 35 | 35 | 35 | 0  | 0  |
| 2054                 | 30 | 30 | 30 | 38 | 33 | 32 | 38 | 35 | 44 | 35 | 35 | 35 | 1  | 1  |
| 2055                 | 33 | 33 | 33 | 37 | 39 | 33 | 40 | 33 | 40 | 40 | 40 | 40 | 1  | 0  |
| 2056                 | 34 | 34 | 34 | 36 | 37 | 32 | 41 | 34 | 47 | 38 | 38 | 38 | 1  | 1  |
| 2057                 | 36 | 36 | 36 | 40 | 36 | 35 | 28 | 32 | 44 | 36 | 36 | 36 | 0  | 1  |
| 2058                 | 36 | 36 | 36 | 31 | 35 | 35 | 24 | 34 | 33 | 35 | 35 | 35 | 0  | 0  |
| 2059                 | 38 | 38 | 38 | 28 | 35 | 32 | 24 | 29 | 27 | 34 | 34 | 34 | 0  | 0  |
| 2060                 | 38 | 38 | 38 | 21 | 26 | 34 | 16 | 26 | 25 | 22 | 22 | 22 | 0  | 0  |
| 2061                 | 38 | 38 | 38 | 18 | 23 | 30 | 15 | 19 | 23 | 21 | 21 | 21 | 0  | 0  |
| 2062                 | 31 | 31 | 31 | 11 | 13 | 29 | 11 | 12 | 21 | 14 | 14 | 14 | 0  | 0  |
| 2063                 | 27 | 27 | 27 | 10 | 13 | 24 | 7  | 11 | 19 | 12 | 12 | 12 | 0  | 0  |
| 2064                 | 26 | 26 | 26 | 10 | 13 | 15 | 7  | 7  | 13 | 11 | 11 | 11 | 0  | 0  |
| 2065                 | 18 | 18 | 18 | 8  | 12 | 9  | 4  | 8  | 9  | 11 | 11 | 11 | 0  | 0  |
| 2066                 | 13 | 13 | 13 | 6  | 9  | 11 | 4  | 7  | 6  | 7  | 7  | 7  | 0  | 0  |
| 2067                 | 11 | 11 | 11 | 3  | 5  | 7  | 3  | 4  | 4  | 3  | 3  | 3  | 0  | 0  |
| 2068                 | 7  | 7  | 7  | 3  | 2  | 7  | 1  | 2  | 3  | 3  | 3  | 3  | 0  | 0  |
| 2069                 | 6  | 6  | 6  | 2  | 2  | 6  | 1  | 1  | 4  | 2  | 2  | 2  | 0  | 0  |
| 2070                 | 5  | 5  | 5  | 1  | 1  | 4  | 1  | 1  | 3  | 0  | 0  | 0  | 0  | 0  |
| 2071                 | 3  | 3  | 3  | 2  | 1  | 3  | 1  | 1  | 4  | 0  | 0  | 0  | 0  | 0  |
| 2072                 | 2  | 2  | 2  | 1  | 1  | 2  | 1  | 1  | 5  | 0  | 0  | 0  | 0  | 0  |
| 2073                 | 2  | 2  | 2  | 1  | 1  | 0  | 1  | 1  | 4  | 0  | 0  | 0  | 0  | 0  |
| 2074                 | 2  | 2  | 2  | 1  | 1  | 0  | 1  | 0  | 4  | 0  | 0  | 0  | 0  | 0  |
| 2075                 | 1  | 1  | 1  | 1  | 1  | 0  | 1  | 0  | 2  | 0  | 0  | 0  | 0  | 0  |
| 2076                 | 0  | 0  | 0  | 1  | 1  | 0  | 0  | 0  | 1  | 0  | 0  | 0  | 0  | 0  |
| 2077                 | 0  | 0  | 0  | 1  | 1  | 0  | 0  | 0  | 1  | 0  | 0  | 0  | 0  | 0  |
| 2078                 | 0  | 0  | 0  | 1  | 1  | 0  | 0  | 0  | 1  | 0  | 0  | 0  | 0  | 0  |
| 2079                 | 0  | 0  | 0  | 0  | 0  | 0  | 0  | 0  | 1  | 0  | 0  | 0  | 0  | 0  |
| 2080                 | 0  | 0  | 0  | 0  | 0  | 0  | 0  | 0  | 1  | 0  | 0  | 0  | 0  | 0  |
| 2081                 | 0  | 0  | 0  | 0  | 0  | 0  | 0  | 0  | 1  | 0  | 0  | 0  | 0  | 0  |
| 2082                 | 0  | 0  | 0  | 0  | 0  | 0  | 0  | 0  | 1  | 0  | 0  | 0  | 0  | 0  |
| 2083                 | 0  | 0  | 0  | 0  | 0  | 0  | 0  | 0  | 1  | 0  | 0  | 0  | 0  | 0  |
| 2084                 | 0  | 0  | 0  | 0  | 0  | 0  | 0  | 0  | 1  | 0  | 0  | 0  | 0  | 0  |
| 2085                 | 0  | 0  | 0  | 0  | 0  | 0  | 0  | 0  | 1  | 0  | 0  | 0  | 0  | 0  |
| 2086                 | 0  | 0  | 0  | 0  | 0  | 0  | 0  | 0  | 0  | 0  | 0  | 0  | 0  | 0  |
| 2087                 | 0  | 0  | 0  | 0  | 0  | 0  | 0  | 0  | 0  | 0  | 0  | 0  | 0  | 0  |
| 2088                 | 0  | 0  | 0  | 0  | 0  | 0  | 0  | 0  | 0  | 0  | 0  | 0  | 0  | 0  |
| 2089                 | 0  | 0  | 0  | 0  | 0  | 0  | 0  | 0  | 0  | 0  | 0  | 0  | 0  | 0  |
| 2090                 | 0  | 0  | 0  | 0  | 0  | 0  | 0  | 0  | 0  | 0  | 0  | 0  | 0  | 0  |

| ScenarioID / Year | 57 | 58 | 59 | 60 | 61 | 62 | 63 | 64 | 65 | 66 | 67 | 68 | 69 | 70 |
|-------------------|----|----|----|----|----|----|----|----|----|----|----|----|----|----|
| 2002              | 0  | 0  | 0  | 0  | 0  | 0  | 0  | 0  | 0  | 0  | 0  | 0  | 0  | 0  |
| 2003              | 0  | 0  | 0  | 0  | 0  | 0  | 0  | 0  | 0  | 0  | 0  | 0  | 0  | 0  |
| 2004              | 1  | 1  | 1  | 1  | 1  | 1  | 1  | 1  | 1  | 1  | 1  | 1  | 1  | 1  |
| 2005              | 2  | 2  | 2  | 2  | 2  | 2  | 2  | 2  | 2  | 2  | 2  | 2  | 2  | 2  |
| 2006              | 3  | 3  | 3  | 3  | 3  | 3  | 3  | 3  | 3  | 3  | 3  | 3  | 3  | 3  |
| 2007              | 7  | 7  | 7  | 7  | 7  | 7  | 7  | 7  | 7  | 7  | 7  | 7  | 7  | 7  |
| 2008              | 10 | 10 | 10 | 10 | 10 | 10 | 10 | 10 | 10 | 10 | 10 | 10 | 10 | 10 |
| 2009              | 17 | 17 | 17 | 17 | 17 | 17 | 17 | 17 | 17 | 17 | 17 | 17 | 17 | 17 |
| 2010              | 19 | 19 | 19 | 19 | 19 | 19 | 19 | 19 | 19 | 19 | 19 | 19 | 19 | 19 |
| 2011              | 30 | 30 | 30 | 30 | 30 | 30 | 30 | 30 | 30 | 30 | 30 | 30 | 30 | 30 |
| 2012              | 27 | 27 | 27 | 27 | 27 | 27 | 27 | 27 | 27 | 27 | 27 | 27 | 27 | 27 |
| 2013              | 31 | 31 | 31 | 31 | 31 | 31 | 31 | 31 | 31 | 31 | 31 | 31 | 31 | 31 |
| 2014              | 32 | 32 | 32 | 32 | 32 | 32 | 32 | 32 | 32 | 32 | 32 | 32 | 32 | 32 |
| 2015              | 41 | 41 | 41 | 41 | 41 | 41 | 41 | 41 | 41 | 41 | 41 | 41 | 41 | 41 |
| 2016              | 37 | 37 | 37 | 37 | 37 | 37 | 37 | 37 | 37 | 37 | 37 | 37 | 37 | 37 |
| 2017              | 44 | 44 | 44 | 44 | 44 | 44 | 44 | 44 | 44 | 44 | 44 | 44 | 44 | 44 |
| 2018              | 44 | 44 | 44 | 44 | 44 | 44 | 44 | 44 | 44 | 44 | 44 | 44 | 44 | 44 |
| 2019              | 45 | 45 | 45 | 45 | 45 | 45 | 45 | 45 | 45 | 45 | 45 | 45 | 45 | 45 |
| 2020              | 47 | 47 | 47 | 47 | 47 | 47 | 47 | 47 | 47 | 47 | 47 | 47 | 47 | 47 |
| 2021              | 49 | 36 | 49 | 49 | 49 | 49 | 49 | 49 | 49 | 49 | 36 | 49 | 49 | 49 |
| 2022              | 47 | 31 | 47 | 47 | 47 | 47 | 47 | 47 | 47 | 47 | 31 | 47 | 47 | 47 |
| 2023              | 50 | 31 | 50 | 50 | 50 | 50 | 50 | 50 | 50 | 50 | 30 | 50 | 50 | 50 |
| 2024              | 49 | 30 | 49 | 49 | 49 | 49 | 49 | 49 | 49 | 49 | 30 | 49 | 49 | 49 |
| 2025              | 52 | 30 | 52 | 52 | 52 | 52 | 52 | 52 | 52 | 52 | 30 | 52 | 52 | 52 |
| 2026              | 51 | 30 | 38 | 38 | 38 | 38 | 38 | 38 | 38 | 51 | 30 | 38 | 38 | 38 |
| 2027              | 51 | 31 | 31 | 31 | 31 | 31 | 31 | 31 | 31 | 51 | 31 | 31 | 31 | 31 |
| 2028              | 53 | 32 | 31 | 31 | 31 | 31 | 31 | 31 | 31 | 53 | 32 | 31 | 31 | 31 |
| 2029              | 51 | 31 | 30 | 30 | 30 | 30 | 30 | 30 | 30 | 51 | 31 | 30 | 31 | 30 |
| 2030              | 55 | 30 | 29 | 29 | 29 | 29 | 29 | 29 | 29 | 55 | 31 | 29 | 29 | 29 |
| 2031              | 45 | 30 | 29 | 29 | 29 | 29 | 29 | 30 | 29 | 45 | 33 | 29 | 29 | 29 |
| 2032              | 31 | 32 | 30 | 31 | 30 | 30 | 30 | 32 | 30 | 31 | 35 | 30 | 31 | 30 |
| 2033              | 31 | 29 | 28 | 29 | 29 | 29 | 29 | 30 | 28 | 31 | 32 | 28 | 29 | 28 |
| 2034              | 29 | 32 | 30 | 33 | 31 | 31 | 31 | 33 | 31 | 29 | 35 | 30 | 33 | 31 |
| 2035              | 30 | 31 | 30 | 32 | 31 | 31 | 31 | 33 | 31 | 30 | 33 | 31 | 33 | 31 |
| 2036              | 30 | 30 | 30 | 31 | 29 | 29 | 29 | 33 | 30 | 30 | 33 | 31 | 33 | 30 |
| 2037              | 30 | 32 | 30 | 30 | 30 | 30 | 30 | 34 | 30 | 30 | 33 | 30 | 31 | 31 |
| 2038              | 31 | 35 | 28 | 31 | 28 | 28 | 28 | 32 | 30 | 30 | 34 | 29 | 30 | 30 |
| 2039              | 31 | 33 | 30 | 32 | 29 | 29 | 29 | 32 | 29 | 31 | 33 | 30 | 31 | 30 |
| 2040              | 29 | 34 | 29 | 31 | 34 | 34 | 34 | 35 | 31 | 29 | 33 | 30 | 31 | 31 |
| 2041              | 30 | 0  | 32 | 35 | 33 | 33 | 33 | 32 | 29 | 30 | 0  | 31 | 35 | 33 |
| 2042              | 30 | 1  | 0  | 33 | 30 | 30 | 30 | 38 | 30 | 29 | 1  | 0  | 30 | 36 |
| 2043              | 30 | 3  | 2  | 2  | 2  | 2  | 2  | 2  | 2  | 30 | 3  | 2  | 2  | 2  |
| 2044              | 3  | 6  | 5  | 5  | 5  | 5  | 5  | 6  | 5  | 3  | 6  | 5  | 4  | 5  |
| 2045              | 3  | 6  | 4  | 4  | 4  | 4  | 4  | 5  | 3  | 3  | 5  | 4  | 4  | 4  |
| 2046              | 5  | 11 | 6  | 6  | 4  | 4  | 4  | 4  | 4  | 5  | 10 | 6  | 7  | 4  |
| 2047              | 7  | 10 | 9  | 7  | 8  | 8  | 8  | 9  | 7  | 8  | 9  | 9  | 8  | 9  |
| 2048              | 4  | 8  | 6  | 9  | 6  | 6  | 6  | 6  | 6  | 7  | 8  | 6  | 8  | 6  |
| 2049              | 2  | 1  | 1  | 1  | 1  | 1  | 1  | 1  | 1  | 2  | 1  | 1  | 1  | 1  |
| 2050              | 2  | 2  | 2  | 3  | 2  | 2  | 2  | 2  | 2  | 2  | 2  | 2  | 3  | 2  |
| 2051              | 2  | 2  | 2  | 3  | 2  | 2  | 2  | 2  | 2  | 2  | 2  | 2  | 3  | 2  |

| ScenarioID /<br>Year | 57 | 58 | 59 | 60 | 61 | 62 | 63 | 64 | 65 | 66 | 67 | 68 | 69 | 70 |
|----------------------|----|----|----|----|----|----|----|----|----|----|----|----|----|----|
| 2052                 | 1  | 1  | 1  | 1  | 1  | 1  | 1  | 1  | 1  | 1  | 1  | 1  | 1  | 1  |
| 2053                 | 0  | 0  | 0  | 0  | 0  | 0  | 0  | 0  | 0  | 0  | 0  | 0  | 0  | 0  |
| 2054                 | 1  | 1  | 1  | 1  | 1  | 1  | 1  | 1  | 1  | 1  | 1  | 1  | 1  | 1  |
| 2055                 | 0  | 0  | 1  | 0  | 0  | 0  | 0  | 0  | 0  | 0  | 0  | 1  | 0  | 0  |
| 2056                 | 1  | 1  | 1  | 1  | 1  | 1  | 1  | 1  | 1  | 1  | 1  | 1  | 1  | 1  |
| 2057                 | 1  | 1  | 0  | 0  | 1  | 1  | 1  | 1  | 1  | 1  | 1  | 0  | 1  | 1  |
| 2058                 | 0  | 0  | 0  | 0  | 0  | 0  | 0  | 0  | 0  | 0  | 0  | 0  | 0  | 0  |
| 2059                 | 0  | 0  | 0  | 0  | 0  | 0  | 0  | 0  | 0  | 0  | 0  | 0  | 0  | 0  |
| 2060                 | 0  | 0  | 0  | 0  | 0  | 0  | 0  | 0  | 0  | 0  | 0  | 0  | 0  | 0  |
| 2061                 | 0  | 0  | 0  | 0  | 0  | 0  | 0  | 0  | 0  | 0  | 0  | 0  | 0  | 0  |
| 2062                 | 0  | 0  | 0  | 0  | 0  | 0  | 0  | 0  | 0  | 0  | 0  | 0  | 0  | 0  |
| 2063                 | 0  | 0  | 0  | 0  | 0  | 0  | 0  | 0  | 0  | 0  | 0  | 0  | 0  | 0  |
| 2064                 | 0  | 0  | 0  | 0  | 0  | 0  | 0  | 0  | 0  | 0  | 0  | 0  | 0  | 0  |
| 2065                 | 0  | 0  | 0  | 0  | 0  | 0  | 0  | 0  | 0  | 0  | 0  | 0  | 0  | 0  |
| 2066                 | 0  | 0  | 0  | 0  | 0  | 0  | 0  | 0  | 0  | 0  | 0  | 0  | 0  | 0  |
| 2067                 | 0  | 0  | 0  | 0  | 0  | 0  | 0  | 0  | 0  | 0  | 0  | 0  | 0  | 0  |
| 2068                 | 0  | 0  | 0  | 0  | 0  | 0  | 0  | 0  | 0  | 0  | 0  | 0  | 0  | 0  |
| 2069                 | 0  | 0  | 0  | 0  | 0  | 0  | 0  | 0  | 0  | 0  | 0  | 0  | 0  | 0  |
| 2070                 | 0  | 0  | 0  | 0  | 0  | 0  | 0  | 0  | 0  | 0  | 0  | 0  | 0  | 0  |
| 2071                 | 0  | 0  | 0  | 0  | 0  | 0  | 0  | 0  | 0  | 0  | 0  | 0  | 0  | 0  |
| 2072                 | 0  | 0  | 0  | 0  | 0  | 0  | 0  | 0  | 0  | 0  | 0  | 0  | 0  | 0  |
| 2073                 | 0  | 0  | 0  | 0  | 0  | 0  | 0  | 0  | 0  | 0  | 0  | 0  | 0  | 0  |
| 2074                 | 0  | 0  | 0  | 0  | 0  | 0  | 0  | 0  | 0  | 0  | 0  | 0  | 0  | 0  |
| 2075                 | 0  | 0  | 0  | 0  | 0  | 0  | 0  | 0  | 0  | 0  | 0  | 0  | 0  | 0  |
| 2076                 | 0  | 0  | 0  | 0  | 0  | 0  | 0  | 0  | 0  | 0  | 0  | 0  | 0  | 0  |
| 2077                 | 0  | 0  | 0  | 0  | 0  | 0  | 0  | 0  | 0  | 0  | 0  | 0  | 0  | 0  |
| 2078                 | 0  | 0  | 0  | 0  | 0  | 0  | 0  | 0  | 0  | 0  | 0  | 0  | 0  | 0  |
| 2079                 | 0  | 0  | 0  | 0  | 0  | 0  | 0  | 0  | 0  | 0  | 0  | 0  | 0  | 0  |
| 2080                 | 0  | 0  | 0  | 0  | 0  | 0  | 0  | 0  | 0  | 0  | 0  | 0  | 0  | 0  |
| 2081                 | 0  | 0  | 0  | 0  | 0  | 0  | 0  | 0  | 0  | 0  | 0  | 0  | 0  | 0  |
| 2082                 | 0  | 0  | 0  | 0  | 0  | 0  | 0  | 0  | 0  | 0  | 0  | 0  | 0  | 0  |
| 2083                 | 0  | 0  | 0  | 0  | 0  | 0  | 0  | 0  | 0  | 0  | 0  | 0  | 0  | 0  |
| 2084                 | 0  | 0  | 0  | 0  | 0  | 0  | 0  | 0  | 0  | 0  | 0  | 0  | 0  | 0  |
| 2085                 | 0  | 0  | 0  | 0  | 0  | 0  | 0  | 0  | 0  | 0  | 0  | 0  | 0  | 0  |
| 2086                 | 0  | 0  | 0  | 0  | 0  | 0  | 0  | 0  | 0  | 0  | 0  | 0  | 0  | 0  |
| 2087                 | 0  | 0  | 0  | 0  | 0  | 0  | 0  | 0  | 0  | 0  | 0  | 0  | 0  | 0  |
| 2088                 | 0  | 0  | 0  | 0  | 0  | 0  | 0  | 0  | 0  | 0  | 0  | 0  | 0  | 0  |
| 2089                 | 0  | 0  | 0  | 0  | 0  | 0  | 0  | 0  | 0  | 0  | 0  | 0  | 0  | 0  |
| 2090                 | 0  | 0  | 0  | 0  | 0  | 0  | 0  | 0  | 0  | 0  | 0  | 0  | 0  | 0  |

| ScenarioID /<br>Year | 71 | 72 | 73 | 74 | 75 | 76 | 77 | 78 | 79 | 80 | 81 |
|----------------------|----|----|----|----|----|----|----|----|----|----|----|
| 2002                 | 0  | 0  | 0  | 0  | 0  | 0  | 0  | 0  | 0  | 0  | 0  |
| 2003                 | 0  | 0  | 0  | 0  | 0  | 0  | 0  | 0  | 0  | 0  | 0  |
| 2004                 | 1  | 1  | 1  | 1  | 1  | 1  | 1  | 1  | 1  | 1  | 1  |
| 2005                 | 2  | 2  | 2  | 2  | 2  | 2  | 2  | 2  | 2  | 2  | 2  |
| 2006                 | 3  | 3  | 3  | 3  | 3  | 3  | 3  | 3  | 3  | 3  | 3  |
| 2007                 | 7  | 7  | 7  | 7  | 7  | 7  | 7  | 7  | 7  | 7  | 7  |
| 2008                 | 10 | 10 | 10 | 10 | 10 | 10 | 10 | 10 | 10 | 10 | 10 |
| 2009                 | 17 | 17 | 17 | 17 | 17 | 17 | 17 | 17 | 17 | 17 | 17 |
| 2010                 | 19 | 19 | 19 | 19 | 19 | 19 | 19 | 19 | 19 | 19 | 19 |
| 2011                 | 30 | 30 | 30 | 30 | 30 | 30 | 30 | 30 | 30 | 30 | 30 |
| 2012                 | 27 | 27 | 27 | 27 | 27 | 27 | 27 | 27 | 27 | 27 | 27 |
| 2013                 | 31 | 31 | 31 | 31 | 31 | 31 | 31 | 31 | 31 | 31 | 31 |
| 2014                 | 32 | 32 | 32 | 32 | 32 | 32 | 32 | 32 | 32 | 32 | 32 |
| 2015                 | 41 | 41 | 41 | 41 | 41 | 41 | 41 | 41 | 41 | 41 | 41 |
| 2016                 | 37 | 37 | 37 | 37 | 37 | 37 | 37 | 37 | 37 | 37 | 37 |
| 2017                 | 44 | 44 | 44 | 44 | 44 | 44 | 44 | 44 | 44 | 44 | 44 |
| 2018                 | 44 | 44 | 44 | 44 | 44 | 44 | 44 | 44 | 44 | 44 | 44 |
| 2019                 | 45 | 45 | 45 | 45 | 45 | 45 | 45 | 45 | 45 | 45 | 45 |
| 2020                 | 47 | 47 | 47 | 47 | 47 | 47 | 47 | 47 | 47 | 47 | 47 |
| 2021                 | 49 | 49 | 49 | 49 | 49 | 36 | 49 | 49 | 49 | 49 | 49 |
| 2022                 | 47 | 47 | 47 | 47 | 47 | 31 | 47 | 47 | 47 | 47 | 47 |
| 2023                 | 50 | 50 | 50 | 50 | 50 | 30 | 50 | 50 | 50 | 50 | 50 |
| 2024                 | 49 | 49 | 49 | 49 | 49 | 30 | 49 | 49 | 49 | 49 | 49 |
| 2025                 | 52 | 52 | 52 | 52 | 52 | 30 | 52 | 52 | 52 | 52 | 52 |
| 2026                 | 38 | 38 | 38 | 38 | 51 | 31 | 38 | 38 | 38 | 38 | 38 |
| 2027                 | 31 | 31 | 31 | 31 | 51 | 30 | 31 | 31 | 31 | 31 | 31 |
| 2028                 | 31 | 31 | 31 | 31 | 53 | 32 | 31 | 31 | 31 | 31 | 31 |
| 2029                 | 30 | 30 | 30 | 30 | 51 | 31 | 30 | 30 | 30 | 30 | 30 |
| 2030                 | 29 | 29 | 29 | 29 | 55 | 29 | 29 | 29 | 29 | 29 | 29 |
| 2031                 | 29 | 29 | 30 | 29 | 45 | 31 | 29 | 30 | 29 | 29 | 29 |
| 2032                 | 30 | 30 | 31 | 30 | 31 | 32 | 30 | 30 | 30 | 30 | 30 |
| 2033                 | 28 | 28 | 29 | 28 | 31 | 29 | 28 | 28 | 28 | 28 | 28 |
| 2034                 | 31 | 31 | 31 | 31 | 29 | 32 | 30 | 32 | 31 | 31 | 31 |
| 2035                 | 31 | 31 | 31 | 31 | 30 | 33 | 31 | 32 | 32 | 32 | 32 |
| 2036                 | 30 | 30 | 30 | 30 | 30 | 34 | 31 | 31 | 31 | 31 | 31 |
| 2037                 | 31 | 31 | 31 | 30 | 29 | 33 | 30 | 31 | 30 | 30 | 30 |
| 2038                 | 30 | 30 | 28 | 28 | 29 | 32 | 28 | 28 | 28 | 28 | 28 |
| 2039                 | 30 | 30 | 33 | 30 | 31 | 34 | 31 | 33 | 32 | 32 | 32 |
| 2040                 | 31 | 31 | 32 | 30 | 29 | 0  | 29 | 30 | 30 | 30 | 30 |
| 2041                 | 33 | 33 | 31 | 31 | 30 | 0  | 31 | 34 | 30 | 30 | 30 |
| 2042                 | 36 | 36 | 0  | 0  | 29 | 0  | 0  | 31 | 0  | 0  | 0  |
| 2043                 | 2  | 2  | 2  | 2  | 30 | 3  | 2  | 2  | 2  | 2  | 2  |
| 2044                 | 5  | 5  | 4  | 5  | 3  | 6  | 5  | 5  | 5  | 5  | 5  |
| 2045                 | 4  | 4  | 3  | 4  | 3  | 6  | 4  | 5  | 4  | 4  | 4  |
| 2046                 | 4  | 4  | 6  | 6  | 5  | 12 | 6  | 6  | 6  | 6  | 6  |
| 2047                 | 9  | 9  | 8  | 9  | 8  | 10 | 9  | 8  | 9  | 9  | 9  |
| 2048                 | 6  | 6  | 7  | 6  | 4  | 9  | 7  | 8  | 6  | 6  | 6  |
| 2049                 | 1  | 1  | 1  | 1  | 1  | 2  | 1  | 1  | 1  | 1  | 1  |
| 2050                 | 2  | 2  | 2  | 2  | 2  | 2  | 2  | 3  | 2  | 2  | 2  |
| 2051                 | 2  | 2  | 2  | 2  | 2  | 2  | 2  | 3  | 2  | 2  | 2  |

| ScenarioID /<br>Year | 71 | 72 | 73 | 74 | 75 | 76 | 77 | 78 | 79 | 80 | 81 |
|----------------------|----|----|----|----|----|----|----|----|----|----|----|
| 2052                 | 1  | 1  | 1  | 1  | 1  | 1  | 1  | 1  | 1  | 1  | 1  |
| 2053                 | 0  | 0  | 0  | 0  | 0  | 0  | 0  | 0  | 0  | 0  | 0  |
| 2054                 | 1  | 1  | 1  | 1  | 1  | 1  | 1  | 1  | 1  | 1  | 1  |
| 2055                 | 0  | 0  | 1  | 1  | 0  | 1  | 1  | 0  | 1  | 1  | 1  |
| 2056                 | 1  | 1  | 1  | 1  | 1  | 1  | 1  | 1  | 1  | 1  | 1  |
| 2057                 | 1  | 1  | 0  | 0  | 1  | 0  | 0  | 1  | 0  | 0  | 0  |
| 2058                 | 0  | 0  | 0  | 0  | 0  | 0  | 0  | 0  | 0  | 0  | 0  |
| 2059                 | 0  | 0  | 0  | 0  | 0  | 0  | 0  | 0  | 0  | 0  | 0  |
| 2060                 | 0  | 0  | 0  | 0  | 0  | 0  | 0  | 0  | 0  | 0  | 0  |
| 2061                 | 0  | 0  | 0  | 0  | 0  | 0  | 0  | 0  | 0  | 0  | 0  |
| 2062                 | 0  | 0  | 0  | 0  | 0  | 0  | 0  | 0  | 0  | 0  | 0  |
| 2063                 | 0  | 0  | 0  | 0  | 0  | 0  | 0  | 0  | 0  | 0  | 0  |
| 2064                 | 0  | 0  | 0  | 0  | 0  | 0  | 0  | 0  | 0  | 0  | 0  |
| 2065                 | 0  | 0  | 0  | 0  | 0  | 0  | 0  | 0  | 0  | 0  | 0  |
| 2066                 | 0  | 0  | 0  | 0  | 0  | 0  | 0  | 0  | 0  | 0  | 0  |
| 2067                 | 0  | 0  | 0  | 0  | 0  | 0  | 0  | 0  | 0  | 0  | 0  |
| 2068                 | 0  | 0  | 0  | 0  | 0  | 0  | 0  | 0  | 0  | 0  | 0  |
| 2069                 | 0  | 0  | 0  | 0  | 0  | 0  | 0  | 0  | 0  | 0  | 0  |
| 2070                 | 0  | 0  | 0  | 0  | 0  | 0  | 0  | 0  | 0  | 0  | 0  |
| 2071                 | 0  | 0  | 0  | 0  | 0  | 0  | 0  | 0  | 0  | 0  | 0  |
| 2072                 | 0  | 0  | 0  | 0  | 0  | 0  | 0  | 0  | 0  | 0  | 0  |
| 2073                 | 0  | 0  | 0  | 0  | 0  | 0  | 0  | 0  | 0  | 0  | 0  |
| 2074                 | 0  | 0  | 0  | 0  | 0  | 0  | 0  | 0  | 0  | 0  | 0  |
| 2075                 | 0  | 0  | 0  | 0  | 0  | 0  | 0  | 0  | 0  | 0  | 0  |
| 2076                 | 0  | 0  | 0  | 0  | 0  | 0  | 0  | 0  | 0  | 0  | 0  |
| 2077                 | 0  | 0  | 0  | 0  | 0  | 0  | 0  | 0  | 0  | 0  | 0  |
| 2078                 | 0  | 0  | 0  | 0  | 0  | 0  | 0  | 0  | 0  | 0  | 0  |
| 2079                 | 0  | 0  | 0  | 0  | 0  | 0  | 0  | 0  | 0  | 0  | 0  |
| 2080                 | 0  | 0  | 0  | 0  | 0  | 0  | 0  | 0  | 0  | 0  | 0  |
| 2081                 | 0  | 0  | 0  | 0  | 0  | 0  | 0  | 0  | 0  | 0  | 0  |
| 2082                 | 0  | 0  | 0  | 0  | 0  | 0  | 0  | 0  | 0  | 0  | 0  |
| 2083                 | 0  | 0  | 0  | 0  | 0  | 0  | 0  | 0  | 0  | 0  | 0  |
| 2084                 | 0  | 0  | 0  | 0  | 0  | 0  | 0  | 0  | 0  | 0  | 0  |
| 2085                 | 0  | 0  | 0  | 0  | 0  | 0  | 0  | 0  | 0  | 0  | 0  |
| 2086                 | 0  | 0  | 0  | 0  | 0  | 0  | 0  | 0  | 0  | 0  | 0  |
| 2087                 | 0  | 0  | 0  | 0  | 0  | 0  | 0  | 0  | 0  | 0  | 0  |
| 2088                 | 0  | 0  | 0  | 0  | 0  | 0  | 0  | 0  | 0  | 0  | 0  |
| 2089                 | 0  | 0  | 0  | 0  | 0  | 0  | 0  | 0  | 0  | 0  | 0  |
| 2090                 | 0  | 0  | 0  | 0  | 0  | 0  | 0  | 0  | 0  | 0  | 0  |

Scenario Parameters

| Scenario ID | Transportation Thermal Limit | Emplacement Thermal Limit | Waste Selection Order | YM Open | TAD Year | YMCap Number | Dry Storage Priority | Wet Dry Priority |
|-------------|------------------------------|---------------------------|-----------------------|---------|----------|--------------|----------------------|------------------|
| 1           | 21.5                         | 14.9                      | OFF                   | 2025    | 2020     | 7250         | TAD before DPC       | Pool             |
| 2           | 21.5                         | 14.9                      | OFF                   | 2025    | 2012     | 7250         | TAD before DPC       | Pool             |
| 3           | 21.5                         | 14.9                      | OFF                   | 2030    | 2016     | 7250         | TAD before DPC       | Pool             |
| 4           | 21.5                         | 14.9                      | OFF                   | 2020    | 2016     | 7250         | TAD before DPC       | Pool             |
| 5           | 25                           | 14.9                      | OFF                   | 2025    | 2016     | 7250         | TAD before DPC       | Pool             |
| 6           | 18                           | 14.9                      | OFF                   | 2025    | 2016     | 7250         | TAD before DPC       | Pool             |
| 7           | 21.5                         | 18                        | OFF                   | 2025    | 2016     | 7250         | TAD before DPC       | Pool             |
| 8           | 21.5                         | 11.8                      | OFF                   | 2025    | 2016     | 7250         | TAD before DPC       | Pool             |
| 9           | 21.5                         | 14.9                      | OFF                   | 2025    | 2016     | 7250         | TAD before DPC       | Pool             |
| 10          | 21.5                         | 14.9                      | YFF10                 | 2025    | 2020     | 7250         | TAD before DPC       | Pool             |
| 11          | 21.5                         | 14.9                      | YFF10                 | 2025    | 2012     | 7250         | TAD before DPC       | Pool             |
| 12          | 21.5                         | 14.9                      | YFF10                 | 2030    | 2016     | 7250         | TAD before DPC       | Pool             |
| 13          | 21.5                         | 14.9                      | YFF10                 | 2020    | 2016     | 7250         | TAD before DPC       | Pool             |
| 14          | 25                           | 14.9                      | YFF10                 | 2025    | 2016     | 7250         | TAD before DPC       | Pool             |
| 15          | 18                           | 14.9                      | YFF10                 | 2025    | 2016     | 7250         | TAD before DPC       | Pool             |
| 16          | 21.5                         | 18                        | YFF10                 | 2025    | 2016     | 7250         | TAD before DPC       | Pool             |
| 17          | 21.5                         | 11.8                      | YFF10                 | 2025    | 2016     | 7250         | TAD before DPC       | Pool             |
| 18          | 21.5                         | 14.9                      | YFF10                 | 2025    | 2016     | 7250         | TAD before DPC       | Pool             |
| 19          | 21.5                         | 14.9                      | YFF5                  | 2025    | 2020     | 7250         | TAD before DPC       | Pool             |
| 20          | 21.5                         | 14.9                      | YFF5                  | 2025    | 2012     | 7250         | TAD before DPC       | Pool             |
| 21          | 21.5                         | 14.9                      | YFF5                  | 2030    | 2016     | 7250         | TAD before DPC       | Pool             |
| 22          | 21.5                         | 14.9                      | YFF5                  | 2020    | 2016     | 7250         | TAD before DPC       | Pool             |
| 23          | 25                           | 14.9                      | YFF5                  | 2025    | 2016     | 7250         | TAD before DPC       | Pool             |
| 24          | 18                           | 14.9                      | YFF5                  | 2025    | 2016     | 7250         | TAD before DPC       | Pool             |
| 25          | 21.5                         | 18                        | YFF5                  | 2025    | 2016     | 7250         | TAD before DPC       | Pool             |
| 26          | 21.5                         | 11.8                      | YFF5                  | 2025    | 2016     | 7250         | TAD before DPC       | Pool             |
| 27          | 21.5                         | 14.9                      | YFF5                  | 2025    | 2016     | 7250         | TAD before DPC       | Pool             |
| 28          | 21.5                         | 14.9                      | OFF                   | 2025    | 2020     | 7250         | Proportional         | Pool             |
| 29          | 21.5                         | 14.9                      | OFF                   | 2025    | 2012     | 7250         | Proportional         | Pool             |
| 30          | 21.5                         | 14.9                      | OFF                   | 2030    | 2016     | 7250         | Proportional         | Pool             |
| 31          | 21.5                         | 14.9                      | OFF                   | 2020    | 2016     | 7250         | Proportional         | Pool             |
| 32          | 25                           | 14.9                      | OFF                   | 2025    | 2016     | 7250         | Proportional         | Pool             |
| 33          | 18                           | 14.9                      | OFF                   | 2025    | 2016     | 7250         | Proportional         | Pool             |
| 34          | 21.5                         | 18                        | OFF                   | 2025    | 2016     | 7250         | Proportional         | Pool             |
| 35          | 21.5                         | 11.8                      | OFF                   | 2025    | 2016     | 7250         | Proportional         | Pool             |
| 36          | 21.5                         | 14.9                      | OFF                   | 2025    | 2016     | 7250         | Proportional         | Pool             |
| 37          | 21.5                         | 14.9                      | YFF10                 | 2025    | 2020     | 7250         | Proportional         | Pool             |
| 38          | 21.5                         | 14.9                      | YFF10                 | 2025    | 2012     | 7250         | Proportional         | Pool             |
| 39          | 21.5                         | 14.9                      | YFF10                 | 2030    | 2016     | 7250         | Proportional         | Pool             |
| 40          | 21.5                         | 14.9                      | YFF10                 | 2020    | 2016     | 7250         | Proportional         | Pool             |
| 41          | 25                           | 14.9                      | YFF10                 | 2025    | 2016     | 7250         | Proportional         | Pool             |
| 42          | 18                           | 14.9                      | YFF10                 | 2025    | 2016     | 7250         | Proportional         | Pool             |
| 43          | 21.5                         | 18                        | YFF10                 | 2025    | 2016     | 7250         | Proportional         | Pool             |
| 44          | 21.5                         | 11.8                      | YFF10                 | 2025    | 2016     | 7250         | Proportional         | Pool             |
| 45          | 21.5                         | 14.9                      | YFF10                 | 2025    | 2016     | 7250         | Proportional         | Pool             |
| 46          | 21.5                         | 14.9                      | YFF5                  | 2025    | 2020     | 7250         | Proportional         | Pool             |
| 47          | 21.5                         | 14.9                      | YFF5                  | 2025    | 2012     | 7250         | Proportional         | Pool             |
| 48          | 21.5                         | 14.9                      | YFF5                  | 2030    | 2016     | 7250         | Proportional         | Pool             |
| 49          | 21.5                         | 14.9                      | YFF5                  | 2020    | 2016     | 7250         | Proportional         | Pool             |
| 50          | 25                           | 14.9                      | YFF5                  | 2025    | 2016     | 7250         | Proportional         | Pool             |
| 51          | 18                           | 14.9                      | YFF5                  | 2025    | 2016     | 7250         | Proportional         | Pool             |
| 52          | 21.5                         | 18                        | YFF5                  | 2025    | 2016     | 7250         | Proportional         | Pool             |
| 53          | 21.5                         | 11.8                      | YFF5                  | 2025    | 2016     | 7250         | Proportional         | Pool             |
| 54          | 21.5                         | 14.9                      | YFF5                  | 2025    | 2016     | 7250         | Proportional         | Pool             |
| 55          | 21.5                         | 14.9                      | OFF                   | 2025    | 2020     | 7250         | TAD before DPC       | Dry              |
| 56          | 21.5                         | 14.9                      | OFF                   | 2025    | 2012     | 7250         | TAD before DPC       | Dry              |



Scenario Parameters

| Scenario ID | Transportation Thermal Limit | Emplacement Thermal Limit | Waste Selection Order | YM Open | TAD Year | YMCap Number | Dry Storage Priority | Wet Dry Priority |
|-------------|------------------------------|---------------------------|-----------------------|---------|----------|--------------|----------------------|------------------|
| 57          | 21.5                         | 14.9                      | OFF                   | 2030    | 2016     | 7250         | TAD before DPC       | Dry              |
| 58          | 21.5                         | 14.9                      | OFF                   | 2020    | 2016     | 7250         | TAD before DPC       | Dry              |
| 59          | 25                           | 14.9                      | OFF                   | 2025    | 2016     | 7250         | TAD before DPC       | Dry              |
| 60          | 18                           | 14.9                      | OFF                   | 2025    | 2016     | 7250         | TAD before DPC       | Dry              |
| 61          | 21.5                         | 18                        | OFF                   | 2025    | 2016     | 7250         | TAD before DPC       | Dry              |
| 62          | 21.5                         | 11.8                      | OFF                   | 2025    | 2016     | 7250         | TAD before DPC       | Dry              |
| 63          | 21.5                         | 14.9                      | OFF                   | 2025    | 2016     | 7250         | TAD before DPC       | Dry              |
| 64          | 21.5                         | 14.9                      | YFF10                 | 2025    | 2020     | 7250         | TAD before DPC       | Dry              |
| 65          | 21.5                         | 14.9                      | YFF10                 | 2025    | 2012     | 7250         | TAD before DPC       | Dry              |
| 66          | 21.5                         | 14.9                      | YFF10                 | 2030    | 2016     | 7250         | TAD before DPC       | Dry              |
| 67          | 21.5                         | 14.9                      | YFF10                 | 2020    | 2016     | 7250         | TAD before DPC       | Dry              |
| 68          | 25                           | 14.9                      | YFF10                 | 2025    | 2016     | 7250         | TAD before DPC       | Dry              |
| 69          | 18                           | 14.9                      | YFF10                 | 2025    | 2016     | 7250         | TAD before DPC       | Dry              |
| 70          | 21.5                         | 18                        | YFF10                 | 2025    | 2016     | 7250         | TAD before DPC       | Dry              |
| 71          | 21.5                         | 11.8                      | YFF10                 | 2025    | 2016     | 7250         | TAD before DPC       | Dry              |
| 72          | 21.5                         | 14.9                      | YFF10                 | 2025    | 2016     | 7250         | TAD before DPC       | Dry              |
| 73          | 21.5                         | 14.9                      | YFF5                  | 2025    | 2020     | 7250         | TAD before DPC       | Dry              |
| 74          | 21.5                         | 14.9                      | YFF5                  | 2025    | 2012     | 7250         | TAD before DPC       | Dry              |
| 75          | 21.5                         | 14.9                      | YFF5                  | 2030    | 2016     | 7250         | TAD before DPC       | Dry              |
| 76          | 21.5                         | 14.9                      | YFF5                  | 2020    | 2016     | 7250         | TAD before DPC       | Dry              |
| 77          | 25                           | 14.9                      | YFF5                  | 2025    | 2016     | 7250         | TAD before DPC       | Dry              |
| 78          | 18                           | 14.9                      | YFF5                  | 2025    | 2016     | 7250         | TAD before DPC       | Dry              |
| 79          | 21.5                         | 18                        | YFF5                  | 2025    | 2016     | 7250         | TAD before DPC       | Dry              |
| 80          | 21.5                         | 11.8                      | YFF5                  | 2025    | 2016     | 7250         | TAD before DPC       | Dry              |
| 81          | 21.5                         | 14.9                      | YFF5                  | 2025    | 2016     | 7250         | TAD before DPC       | Dry              |
| 82          | 21.5                         | 14.9                      | OFF                   | 2025    | 2020     | 7250         | Proportional         | Dry              |
| 83          | 21.5                         | 14.9                      | OFF                   | 2025    | 2012     | 7250         | Proportional         | Dry              |
| 84          | 21.5                         | 14.9                      | OFF                   | 2030    | 2016     | 7250         | Proportional         | Dry              |
| 85          | 21.5                         | 14.9                      | OFF                   | 2020    | 2016     | 7250         | Proportional         | Dry              |
| 86          | 25                           | 14.9                      | OFF                   | 2025    | 2016     | 7250         | Proportional         | Dry              |
| 87          | 18                           | 14.9                      | OFF                   | 2025    | 2016     | 7250         | Proportional         | Dry              |
| 88          | 21.5                         | 18                        | OFF                   | 2025    | 2016     | 7250         | Proportional         | Dry              |
| 89          | 21.5                         | 11.8                      | OFF                   | 2025    | 2016     | 7250         | Proportional         | Dry              |
| 90          | 21.5                         | 14.9                      | OFF                   | 2025    | 2016     | 7250         | Proportional         | Dry              |
| 91          | 21.5                         | 14.9                      | YFF10                 | 2025    | 2020     | 7250         | Proportional         | Dry              |
| 92          | 21.5                         | 14.9                      | YFF10                 | 2025    | 2012     | 7250         | Proportional         | Dry              |
| 93          | 21.5                         | 14.9                      | YFF10                 | 2030    | 2016     | 7250         | Proportional         | Dry              |
| 94          | 21.5                         | 14.9                      | YFF10                 | 2020    | 2016     | 7250         | Proportional         | Dry              |
| 95          | 25                           | 14.9                      | YFF10                 | 2025    | 2016     | 7250         | Proportional         | Dry              |
| 96          | 18                           | 14.9                      | YFF10                 | 2025    | 2016     | 7250         | Proportional         | Dry              |
| 97          | 21.5                         | 18                        | YFF10                 | 2025    | 2016     | 7250         | Proportional         | Dry              |
| 98          | 21.5                         | 11.8                      | YFF10                 | 2025    | 2016     | 7250         | Proportional         | Dry              |
| 99          | 21.5                         | 14.9                      | YFF10                 | 2025    | 2016     | 7250         | Proportional         | Dry              |
| 100         | 21.5                         | 14.9                      | YFF5                  | 2025    | 2020     | 7250         | Proportional         | Dry              |
| 101         | 21.5                         | 14.9                      | YFF5                  | 2025    | 2012     | 7250         | Proportional         | Dry              |
| 102         | 21.5                         | 14.9                      | YFF5                  | 2030    | 2016     | 7250         | Proportional         | Dry              |
| 103         | 21.5                         | 14.9                      | YFF5                  | 2020    | 2016     | 7250         | Proportional         | Dry              |
| 104         | 25                           | 14.9                      | YFF5                  | 2025    | 2016     | 7250         | Proportional         | Dry              |
| 105         | 18                           | 14.9                      | YFF5                  | 2025    | 2016     | 7250         | Proportional         | Dry              |
| 106         | 21.5                         | 18                        | YFF5                  | 2025    | 2016     | 7250         | Proportional         | Dry              |
| 107         | 21.5                         | 11.8                      | YFF5                  | 2025    | 2016     | 7250         | Proportional         | Dry              |
| 108         | 21.5                         | 14.9                      | YFF5                  | 2025    | 2016     | 7250         | Proportional         | Dry              |
| 109         | 21.5                         | 14.9                      | OFF                   | 2025    | 2020     | 7250         | DPC before TAD       | Pool             |
| 110         | 21.5                         | 14.9                      | OFF                   | 2025    | 2012     | 7250         | DPC before TAD       | Pool             |
| 111         | 21.5                         | 14.9                      | OFF                   | 2030    | 2016     | 7250         | DPC before TAD       | Pool             |
| 112         | 21.5                         | 14.9                      | OFF                   | 2020    | 2016     | 7250         | DPC before TAD       | Pool             |

Scenario Parameters

| Scenario ID | Transportation Thermal Limit | Emplacement Thermal Limit | Waste Selection Order | YM Open | TAD Year | YMCap Number | Dry Storage Priority | Wet Dry Priority |
|-------------|------------------------------|---------------------------|-----------------------|---------|----------|--------------|----------------------|------------------|
| 113         | 25                           | 14.9                      | OFF                   | 2025    | 2016     | 7250         | DPC before TAD       | Pool             |
| 114         | 18                           | 14.9                      | OFF                   | 2025    | 2016     | 7250         | DPC before TAD       | Pool             |
| 115         | 21.5                         | 18                        | OFF                   | 2025    | 2016     | 7250         | DPC before TAD       | Pool             |
| 116         | 21.5                         | 11.8                      | OFF                   | 2025    | 2016     | 7250         | DPC before TAD       | Pool             |
| 117         | 21.5                         | 14.9                      | OFF                   | 2025    | 2016     | 7250         | DPC before TAD       | Pool             |
| 118         | 21.5                         | 14.9                      | YFF10                 | 2025    | 2020     | 7250         | DPC before TAD       | Pool             |
| 119         | 21.5                         | 14.9                      | YFF10                 | 2025    | 2012     | 7250         | DPC before TAD       | Pool             |
| 120         | 21.5                         | 14.9                      | YFF10                 | 2030    | 2016     | 7250         | DPC before TAD       | Pool             |
| 121         | 21.5                         | 14.9                      | YFF10                 | 2020    | 2016     | 7250         | DPC before TAD       | Pool             |
| 122         | 25                           | 14.9                      | YFF10                 | 2025    | 2016     | 7250         | DPC before TAD       | Pool             |
| 123         | 18                           | 14.9                      | YFF10                 | 2025    | 2016     | 7250         | DPC before TAD       | Pool             |
| 124         | 21.5                         | 18                        | YFF10                 | 2025    | 2016     | 7250         | DPC before TAD       | Pool             |
| 125         | 21.5                         | 11.8                      | YFF10                 | 2025    | 2016     | 7250         | DPC before TAD       | Pool             |
| 126         | 21.5                         | 14.9                      | YFF10                 | 2025    | 2016     | 7250         | DPC before TAD       | Pool             |
| 127         | 21.5                         | 14.9                      | YFF5                  | 2025    | 2020     | 7250         | DPC before TAD       | Pool             |
| 128         | 21.5                         | 14.9                      | YFF5                  | 2025    | 2012     | 7250         | DPC before TAD       | Pool             |
| 129         | 21.5                         | 14.9                      | YFF5                  | 2030    | 2016     | 7250         | DPC before TAD       | Pool             |
| 130         | 21.5                         | 14.9                      | YFF5                  | 2020    | 2016     | 7250         | DPC before TAD       | Pool             |
| 131         | 25                           | 14.9                      | YFF5                  | 2025    | 2016     | 7250         | DPC before TAD       | Pool             |
| 132         | 18                           | 14.9                      | YFF5                  | 2025    | 2016     | 7250         | DPC before TAD       | Pool             |
| 133         | 21.5                         | 18                        | YFF5                  | 2025    | 2016     | 7250         | DPC before TAD       | Pool             |
| 134         | 21.5                         | 11.8                      | YFF5                  | 2025    | 2016     | 7250         | DPC before TAD       | Pool             |
| 135         | 21.5                         | 14.9                      | YFF5                  | 2025    | 2016     | 7250         | DPC before TAD       | Pool             |
| 136         | 21.5                         | 14.9                      | OFF                   | 2025    | 2020     | 7250         | DPC before TAD       | Dry              |
| 137         | 21.5                         | 14.9                      | OFF                   | 2025    | 2012     | 7250         | DPC before TAD       | Dry              |
| 138         | 21.5                         | 14.9                      | OFF                   | 2030    | 2016     | 7250         | DPC before TAD       | Dry              |
| 139         | 21.5                         | 14.9                      | OFF                   | 2020    | 2016     | 7250         | DPC before TAD       | Dry              |
| 140         | 25                           | 14.9                      | OFF                   | 2025    | 2016     | 7250         | DPC before TAD       | Dry              |
| 141         | 18                           | 14.9                      | OFF                   | 2025    | 2016     | 7250         | DPC before TAD       | Dry              |
| 142         | 21.5                         | 18                        | OFF                   | 2025    | 2016     | 7250         | DPC before TAD       | Dry              |
| 143         | 21.5                         | 11.8                      | OFF                   | 2025    | 2016     | 7250         | DPC before TAD       | Dry              |
| 144         | 21.5                         | 14.9                      | OFF                   | 2025    | 2016     | 7250         | DPC before TAD       | Dry              |
| 145         | 21.5                         | 14.9                      | YFF10                 | 2025    | 2020     | 7250         | DPC before TAD       | Dry              |
| 146         | 21.5                         | 14.9                      | YFF10                 | 2025    | 2012     | 7250         | DPC before TAD       | Dry              |
| 147         | 21.5                         | 14.9                      | YFF10                 | 2030    | 2016     | 7250         | DPC before TAD       | Dry              |
| 148         | 21.5                         | 14.9                      | YFF10                 | 2020    | 2016     | 7250         | DPC before TAD       | Dry              |
| 149         | 25                           | 14.9                      | YFF10                 | 2025    | 2016     | 7250         | DPC before TAD       | Dry              |
| 150         | 18                           | 14.9                      | YFF10                 | 2025    | 2016     | 7250         | DPC before TAD       | Dry              |
| 151         | 21.5                         | 18                        | YFF10                 | 2025    | 2016     | 7250         | DPC before TAD       | Dry              |
| 152         | 21.5                         | 11.8                      | YFF10                 | 2025    | 2016     | 7250         | DPC before TAD       | Dry              |
| 153         | 21.5                         | 14.9                      | YFF10                 | 2025    | 2016     | 7250         | DPC before TAD       | Dry              |
| 154         | 21.5                         | 14.9                      | YFF5                  | 2025    | 2020     | 7250         | DPC before TAD       | Dry              |
| 155         | 21.5                         | 14.9                      | YFF5                  | 2025    | 2012     | 7250         | DPC before TAD       | Dry              |
| 156         | 21.5                         | 14.9                      | YFF5                  | 2030    | 2016     | 7250         | DPC before TAD       | Dry              |
| 157         | 21.5                         | 14.9                      | YFF5                  | 2020    | 2016     | 7250         | DPC before TAD       | Dry              |
| 158         | 25                           | 14.9                      | YFF5                  | 2025    | 2016     | 7250         | DPC before TAD       | Dry              |
| 159         | 18                           | 14.9                      | YFF5                  | 2025    | 2016     | 7250         | DPC before TAD       | Dry              |
| 160         | 21.5                         | 18                        | YFF5                  | 2025    | 2016     | 7250         | DPC before TAD       | Dry              |
| 161         | 21.5                         | 11.8                      | YFF5                  | 2025    | 2016     | 7250         | DPC before TAD       | Dry              |
| 162         | 21.5                         | 14.9                      | YFF5                  | 2025    | 2016     | 7250         | DPC before TAD       | Dry              |

|      | 1    | 2    | 3    | 4    | 5    | 6    | 7    | 8    | 9    |
|------|------|------|------|------|------|------|------|------|------|
| 2002 | 0    | 0    | 0    | 0    | 0    | 0    | 0    | 0    | 0    |
| 2003 | 0    | 0    | 0    | 0    | 0    | 0    | 0    | 0    | 0    |
| 2004 | 1    | 1    | 1    | 1    | 1    | 1    | 1    | 1    | 1    |
| 2005 | 3    | 3    | 3    | 3    | 3    | 3    | 3    | 3    | 3    |
| 2006 | 14   | 14   | 14   | 14   | 14   | 14   | 14   | 14   | 14   |
| 2007 | 33   | 33   | 33   | 33   | 33   | 33   | 33   | 33   | 33   |
| 2008 | 67   | 67   | 67   | 67   | 67   | 67   | 67   | 67   | 67   |
| 2009 | 128  | 128  | 128  | 128  | 128  | 128  | 128  | 128  | 128  |
| 2010 | 210  | 210  | 210  | 210  | 210  | 210  | 210  | 210  | 210  |
| 2011 | 313  | 313  | 313  | 313  | 313  | 313  | 313  | 313  | 313  |
| 2012 | 418  | 418  | 418  | 418  | 418  | 418  | 418  | 418  | 418  |
| 2013 | 547  | 547  | 547  | 547  | 547  | 547  | 547  | 547  | 547  |
| 2014 | 665  | 665  | 665  | 665  | 665  | 665  | 665  | 665  | 665  |
| 2015 | 814  | 814  | 814  | 814  | 814  | 814  | 814  | 814  | 814  |
| 2016 | 957  | 957  | 957  | 957  | 957  | 957  | 957  | 957  | 957  |
| 2017 | 1109 | 1109 | 1109 | 1109 | 1109 | 1109 | 1109 | 1109 | 1109 |
| 2018 | 1276 | 1276 | 1276 | 1276 | 1276 | 1276 | 1276 | 1276 | 1276 |
| 2019 | 1449 | 1449 | 1449 | 1449 | 1449 | 1449 | 1449 | 1449 | 1449 |
| 2020 | 1622 | 1622 | 1622 | 1703 | 1622 | 1622 | 1622 | 1622 | 1622 |
| 2021 | 1808 | 1808 | 1808 | 1955 | 1808 | 1808 | 1808 | 1808 | 1808 |
| 2022 | 1974 | 1974 | 1974 | 2209 | 1974 | 1974 | 1974 | 1974 | 1974 |
| 2023 | 2164 | 2164 | 2164 | 2466 | 2164 | 2164 | 2164 | 2164 | 2164 |
| 2024 | 2363 | 2363 | 2363 | 2717 | 2363 | 2363 | 2363 | 2363 | 2363 |
| 2025 | 2619 | 2619 | 2555 | 2986 | 2619 | 2619 | 2619 | 2619 | 2619 |
| 2026 | 2869 | 2869 | 2738 | 3242 | 2869 | 2869 | 2869 | 2869 | 2869 |
| 2027 | 3120 | 3120 | 2931 | 3499 | 3120 | 3120 | 3120 | 3120 | 3120 |
| 2028 | 3374 | 3374 | 3125 | 3753 | 3374 | 3374 | 3374 | 3374 | 3374 |
| 2029 | 3624 | 3624 | 3297 | 4027 | 3624 | 3624 | 3624 | 3624 | 3624 |
| 2030 | 3876 | 3876 | 3553 | 4294 | 3876 | 3876 | 3876 | 3876 | 3876 |
| 2031 | 4134 | 4134 | 3806 | 4552 | 4134 | 4134 | 4134 | 4134 | 4134 |
| 2032 | 4390 | 4390 | 4056 | 4835 | 4390 | 4384 | 4390 | 4390 | 4390 |
| 2033 | 4640 | 4640 | 4313 | 5126 | 4640 | 4624 | 4640 | 4640 | 4640 |
| 2034 | 4899 | 4899 | 4568 | 5385 | 4899 | 4850 | 4899 | 4899 | 4899 |
| 2035 | 5166 | 5166 | 4820 | 5709 | 5166 | 5100 | 5166 | 5166 | 5166 |
| 2036 | 5452 | 5452 | 5087 | 6011 | 5451 | 5348 | 5452 | 5452 | 5452 |
| 2037 | 5707 | 5717 | 5349 | 6241 | 5724 | 5638 | 5717 | 5717 | 5717 |
| 2038 | 6018 | 6032 | 5608 | 6516 | 6050 | 5938 | 6032 | 6032 | 6032 |
| 2039 | 6243 | 6266 | 5866 | 6809 | 6328 | 6209 | 6266 | 6266 | 6266 |
| 2040 | 6545 | 6572 | 6124 | 7081 | 6630 | 6520 | 6571 | 6571 | 6571 |
| 2041 | 6813 | 6832 | 6369 | 7256 | 6894 | 6789 | 6826 | 6826 | 6826 |
| 2042 | 7096 | 7153 | 6627 | 7892 | 7242 | 7110 | 7148 | 7148 | 7148 |
| 2043 | 7306 | 7310 | 6913 | 8315 | 7288 | 7322 | 7316 | 7316 | 7316 |
| 2044 | 7964 | 7965 | 7165 | 8562 | 7941 | 7974 | 7968 | 7968 | 7968 |
| 2045 | 8364 | 8351 | 7283 | 8679 | 8326 | 8374 | 8354 | 8354 | 8354 |
| 2046 | 8546 | 8533 | 8052 | 8741 | 8508 | 8566 | 8536 | 8536 | 8536 |
| 2047 | 8633 | 8620 | 8404 | 8778 | 8595 | 8653 | 8623 | 8623 | 8623 |
| 2048 | 8716 | 8705 | 8563 | 8829 | 8684 | 8736 | 8707 | 8707 | 8707 |
| 2049 | 8726 | 8715 | 8651 | 8838 | 8695 | 8747 | 8718 | 8718 | 8718 |
| 2050 | 8735 | 8724 | 8664 | 8847 | 8704 | 8757 | 8727 | 8727 | 8727 |
| 2051 | 8750 | 8739 | 8680 | 8862 | 8719 | 8773 | 8742 | 8742 | 8742 |
| 2052 | 8755 | 8744 | 8685 | 8867 | 8724 | 8778 | 8747 | 8747 | 8747 |
| 2053 | 8755 | 8744 | 8685 | 8867 | 8724 | 8778 | 8747 | 8747 | 8747 |
| 2054 | 8768 | 8757 | 8698 | 8880 | 8737 | 8791 | 8760 | 8760 | 8760 |
| 2055 | 8770 | 8759 | 8700 | 8882 | 8739 | 8793 | 8762 | 8762 | 8762 |
| 2056 | 8780 | 8769 | 8710 | 8892 | 8749 | 8803 | 8772 | 8772 | 8772 |
| 2057 | 8780 | 8769 | 8710 | 8892 | 8749 | 8803 | 8772 | 8772 | 8772 |
| 2058 | 8780 | 8769 | 8710 | 8892 | 8749 | 8803 | 8772 | 8772 | 8772 |
| 2059 | 8780 | 8769 | 8710 | 8892 | 8749 | 8803 | 8772 | 8772 | 8772 |

|      | 1    | 2    | 3    | 4    | 5    | 6    | 7    | 8    | 9    |
|------|------|------|------|------|------|------|------|------|------|
| 2060 | 8780 | 8769 | 8710 | 8892 | 8749 | 8803 | 8772 | 8772 | 8772 |
| 2061 | 8780 | 8769 | 8710 | 8892 | 8749 | 8803 | 8772 | 8772 | 8772 |
| 2062 | 8780 | 8769 | 8710 | 8892 | 8749 | 8803 | 8772 | 8772 | 8772 |
| 2063 | 8780 | 8769 | 8710 | 8892 | 8749 | 8803 | 8772 | 8772 | 8772 |
| 2064 | 8780 | 8769 | 8710 | 8892 | 8749 | 8803 | 8772 | 8772 | 8772 |
| 2065 | 8780 | 8769 | 8710 | 8892 | 8749 | 8803 | 8772 | 8772 | 8772 |
| 2066 | 8780 | 8769 | 8710 | 8892 | 8749 | 8803 | 8772 | 8772 | 8772 |
| 2067 | 8780 | 8769 | 8710 | 8892 | 8749 | 8803 | 8772 | 8772 | 8772 |
| 2068 | 8780 | 8769 | 8710 | 8892 | 8749 | 8803 | 8772 | 8772 | 8772 |
| 2069 | 8780 | 8769 | 8710 | 8892 | 8749 | 8803 | 8772 | 8772 | 8772 |
| 2070 | 8780 | 8769 | 8710 | 8892 | 8749 | 8803 | 8772 | 8772 | 8772 |
| 2071 | 8780 | 8769 | 8710 | 8892 | 8749 | 8803 | 8772 | 8772 | 8772 |
| 2072 | 8780 | 8769 | 8710 | 8892 | 8749 | 8803 | 8772 | 8772 | 8772 |
| 2073 | 8780 | 8769 | 8710 | 8892 | 8749 | 8803 | 8772 | 8772 | 8772 |
| 2074 | 8780 | 8769 | 8710 | 8892 | 8749 | 8803 | 8772 | 8772 | 8772 |
| 2075 | 8780 | 8769 | 8710 | 8892 | 8749 | 8803 | 8772 | 8772 | 8772 |
| 2076 | 8780 | 8769 | 8710 | 8892 | 8749 | 8803 | 8772 | 8772 | 8772 |
| 2077 | 8780 | 8769 | 8710 | 8892 | 8749 | 8803 | 8772 | 8772 | 8772 |
| 2078 | 8780 | 8769 | 8710 | 8892 | 8749 | 8803 | 8772 | 8772 | 8772 |
| 2079 | 8780 | 8769 | 8710 | 8892 | 8749 | 8803 | 8772 | 8772 | 8772 |
| 2080 | 8780 | 8769 | 8710 | 8892 | 8749 | 8803 | 8772 | 8772 | 8772 |
| 2081 | 8780 | 8769 | 8710 | 8892 | 8749 | 8803 | 8772 | 8772 | 8772 |
| 2082 | 8780 | 8769 | 8710 | 8892 | 8749 | 8803 | 8772 | 8772 | 8772 |
| 2083 | 8780 | 8769 | 8710 | 8892 | 8749 | 8803 | 8772 | 8772 | 8772 |
| 2084 | 8780 | 8769 | 8710 | 8892 | 8749 | 8803 | 8772 | 8772 | 8772 |
| 2085 | 8780 | 8769 | 8710 | 8892 | 8749 | 8803 | 8772 | 8772 | 8772 |
| 2086 | 8780 | 8769 | 8710 | 8892 | 8749 | 8803 | 8772 | 8772 | 8772 |
| 2087 | 8780 | 8769 | 8710 | 8892 | 8749 | 8803 | 8772 | 8772 | 8772 |
| 2088 | 8780 | 8769 | 8710 | 8892 | 8749 | 8803 | 8772 | 8772 | 8772 |
| 2089 | 8780 | 8769 | 8710 | 8892 | 8749 | 8803 | 8772 | 8772 | 8772 |
| 2090 | 8780 | 8769 | 8710 | 8892 | 8749 | 8803 | 8772 | 8772 | 8772 |
|      |      |      |      |      |      |      |      |      |      |

|      | 10   | 11   | 12   | 13   | 14   | 15   | 16   | 17   | 18   |
|------|------|------|------|------|------|------|------|------|------|
| 2002 | 0    | 0    | 0    | 0    | 0    | 0    | 0    | 0    | 0    |
| 2003 | 0    | 0    | 0    | 0    | 0    | 0    | 0    | 0    | 0    |
| 2004 | 1    | 1    | 1    | 1    | 1    | 1    | 1    | 1    | 1    |
| 2005 | 3    | 3    | 3    | 3    | 3    | 3    | 3    | 3    | 3    |
| 2006 | 14   | 14   | 14   | 14   | 14   | 14   | 14   | 14   | 14   |
| 2007 | 33   | 33   | 33   | 33   | 33   | 33   | 33   | 33   | 33   |
| 2008 | 67   | 67   | 67   | 67   | 67   | 67   | 67   | 67   | 67   |
| 2009 | 128  | 128  | 128  | 128  | 128  | 128  | 128  | 128  | 128  |
| 2010 | 210  | 210  | 210  | 210  | 210  | 210  | 210  | 210  | 210  |
| 2011 | 313  | 313  | 313  | 313  | 313  | 313  | 313  | 313  | 313  |
| 2012 | 418  | 418  | 418  | 418  | 418  | 418  | 418  | 418  | 418  |
| 2013 | 547  | 547  | 547  | 547  | 547  | 547  | 547  | 547  | 547  |
| 2014 | 665  | 665  | 665  | 665  | 665  | 665  | 665  | 665  | 665  |
| 2015 | 814  | 814  | 814  | 814  | 814  | 814  | 814  | 814  | 814  |
| 2016 | 957  | 957  | 957  | 957  | 957  | 957  | 957  | 957  | 957  |
| 2017 | 1109 | 1109 | 1109 | 1109 | 1109 | 1109 | 1109 | 1109 | 1109 |
| 2018 | 1276 | 1276 | 1276 | 1276 | 1276 | 1276 | 1276 | 1276 | 1276 |
| 2019 | 1449 | 1449 | 1449 | 1449 | 1449 | 1449 | 1449 | 1449 | 1449 |
| 2020 | 1622 | 1622 | 1622 | 1699 | 1622 | 1622 | 1622 | 1622 | 1622 |
| 2021 | 1808 | 1808 | 1808 | 1949 | 1808 | 1808 | 1808 | 1808 | 1808 |
| 2022 | 1974 | 1974 | 1974 | 2194 | 1974 | 1974 | 1974 | 1974 | 1974 |
| 2023 | 2164 | 2164 | 2164 | 2444 | 2164 | 2164 | 2164 | 2164 | 2164 |
| 2024 | 2363 | 2363 | 2363 | 2702 | 2363 | 2363 | 2363 | 2363 | 2363 |
| 2025 | 2613 | 2613 | 2555 | 2933 | 2613 | 2611 | 2613 | 2613 | 2613 |
| 2026 | 2856 | 2856 | 2738 | 3165 | 2859 | 2845 | 2856 | 2856 | 2856 |
| 2027 | 3106 | 3106 | 2931 | 3411 | 3104 | 3077 | 3106 | 3106 | 3106 |
| 2028 | 3343 | 3342 | 3125 | 3678 | 3340 | 3306 | 3348 | 3348 | 3348 |
| 2029 | 3569 | 3568 | 3297 | 3935 | 3567 | 3532 | 3581 | 3581 | 3581 |
| 2030 | 3811 | 3810 | 3547 | 4137 | 3806 | 3768 | 3816 | 3816 | 3816 |
| 2031 | 4038 | 4038 | 3797 | 4374 | 4048 | 3987 | 4046 | 4046 | 4046 |
| 2032 | 4246 | 4246 | 4038 | 4592 | 4256 | 4206 | 4254 | 4254 | 4254 |
| 2033 | 4462 | 4468 | 4281 | 4814 | 4486 | 4423 | 4473 | 4473 | 4473 |
| 2034 | 4708 | 4714 | 4526 | 5038 | 4729 | 4666 | 4726 | 4726 | 4726 |
| 2035 | 4952 | 4949 | 4761 | 5272 | 4944 | 4909 | 4968 | 4968 | 4968 |
| 2036 | 5128 | 5126 | 4983 | 5452 | 5131 | 5113 | 5152 | 5152 | 5152 |
| 2037 | 5316 | 5315 | 5197 | 5671 | 5315 | 5319 | 5340 | 5340 | 5340 |
| 2038 | 5509 | 5506 | 5416 | 5851 | 5534 | 5513 | 5524 | 5524 | 5524 |
| 2039 | 5709 | 5702 | 5619 | 6045 | 5722 | 5700 | 5716 | 5716 | 5716 |
| 2040 | 5948 | 5943 | 5838 | 6239 | 5947 | 5926 | 5950 | 5950 | 5950 |
| 2041 | 6178 | 6169 | 6073 | 6420 | 6170 | 6134 | 6182 | 6182 | 6182 |
| 2042 | 6385 | 6385 | 6272 | 6585 | 6388 | 6330 | 6390 | 6390 | 6390 |
| 2043 | 6573 | 6566 | 6490 | 6733 | 6610 | 6527 | 6566 | 6566 | 6566 |
| 2044 | 6727 | 6726 | 6709 | 6898 | 6801 | 6693 | 6720 | 6720 | 6720 |
| 2045 | 6860 | 6859 | 6906 | 7044 | 6970 | 6868 | 6865 | 6865 | 6865 |
| 2046 | 6996 | 6992 | 7099 | 7155 | 7140 | 7052 | 7015 | 7015 | 7015 |
| 2047 | 7150 | 7144 | 7265 | 7253 | 7258 | 7243 | 7169 | 7169 | 7169 |
| 2048 | 7250 | 7250 | 7669 | 7625 | 7679 | 7302 | 7253 | 7253 | 7253 |
| 2049 | 7671 | 7671 | 7947 | 7991 | 8021 | 7678 | 7673 | 7673 | 7673 |
| 2050 | 8013 | 8013 | 8134 | 8283 | 8267 | 8019 | 8015 | 8015 | 8015 |
| 2051 | 8259 | 8259 | 8301 | 8518 | 8457 | 8271 | 8261 | 8261 | 8261 |
| 2052 | 8449 | 8449 | 8403 | 8724 | 8641 | 8459 | 8451 | 8451 | 8451 |
| 2053 | 8633 | 8633 | 8447 | 8888 | 8755 | 8625 | 8635 | 8635 | 8635 |
| 2054 | 8747 | 8747 | 8483 | 9013 | 8803 | 8733 | 8749 | 8749 | 8749 |
| 2055 | 8795 | 8795 | 8519 | 9085 | 8840 | 8786 | 8797 | 8797 | 8797 |
| 2056 | 8832 | 8832 | 8540 | 9132 | 8876 | 8823 | 8834 | 8834 | 8834 |
| 2057 | 8868 | 8868 | 8555 | 9172 | 8915 | 8859 | 8870 | 8870 | 8870 |
| 2058 | 8907 | 8907 | 8557 | 9208 | 8949 | 8896 | 8909 | 8909 | 8909 |
| 2059 | 8941 | 8941 | 8557 | 9244 | 8961 | 8928 | 8943 | 8943 | 8943 |

|      | 10   | 11   | 12   | 13   | 14   | 15   | 16   | 17   | 18   |
|------|------|------|------|------|------|------|------|------|------|
| 2060 | 8953 | 8953 | 8557 | 9278 | 8964 | 8942 | 8955 | 8955 | 8955 |
| 2061 | 8956 | 8956 | 8557 | 9294 | 8965 | 8945 | 8958 | 8958 | 8958 |
| 2062 | 8957 | 8957 | 8557 | 9299 | 8965 | 8946 | 8959 | 8959 | 8959 |
| 2063 | 8957 | 8957 | 8557 | 9299 | 8965 | 8946 | 8959 | 8959 | 8959 |
| 2064 | 8957 | 8957 | 8557 | 9299 | 8965 | 8946 | 8959 | 8959 | 8959 |
| 2065 | 8957 | 8957 | 8557 | 9299 | 8965 | 8946 | 8959 | 8959 | 8959 |
| 2066 | 8957 | 8957 | 8557 | 9299 | 8965 | 8946 | 8959 | 8959 | 8959 |
| 2067 | 8957 | 8957 | 8557 | 9299 | 8965 | 8946 | 8959 | 8959 | 8959 |
| 2068 | 8957 | 8957 | 8557 | 9299 | 8965 | 8946 | 8959 | 8959 | 8959 |
| 2069 | 8957 | 8957 | 8557 | 9299 | 8965 | 8946 | 8959 | 8959 | 8959 |
| 2070 | 8957 | 8957 | 8557 | 9299 | 8965 | 8946 | 8959 | 8959 | 8959 |
| 2071 | 8957 | 8957 | 8557 | 9299 | 8965 | 8946 | 8959 | 8959 | 8959 |
| 2072 | 8957 | 8957 | 8557 | 9299 | 8965 | 8946 | 8959 | 8959 | 8959 |
| 2073 | 8957 | 8957 | 8557 | 9299 | 8965 | 8946 | 8959 | 8959 | 8959 |
| 2074 | 8957 | 8957 | 8557 | 9299 | 8965 | 8946 | 8959 | 8959 | 8959 |
| 2075 | 8957 | 8957 | 8557 | 9299 | 8965 | 8946 | 8959 | 8959 | 8959 |
| 2076 | 8957 | 8957 | 8557 | 9299 | 8965 | 8946 | 8959 | 8959 | 8959 |
| 2077 | 8957 | 8957 | 8557 | 9299 | 8965 | 8946 | 8959 | 8959 | 8959 |
| 2078 | 8957 | 8957 | 8557 | 9299 | 8965 | 8946 | 8959 | 8959 | 8959 |
| 2079 | 8957 | 8957 | 8557 | 9299 | 8965 | 8946 | 8959 | 8959 | 8959 |
| 2080 | 8957 | 8957 | 8557 | 9299 | 8965 | 8946 | 8959 | 8959 | 8959 |
| 2081 | 8957 | 8957 | 8557 | 9299 | 8965 | 8946 | 8959 | 8959 | 8959 |
| 2082 | 8957 | 8957 | 8557 | 9299 | 8965 | 8946 | 8959 | 8959 | 8959 |
| 2083 | 8957 | 8957 | 8557 | 9299 | 8965 | 8946 | 8959 | 8959 | 8959 |
| 2084 | 8957 | 8957 | 8557 | 9299 | 8965 | 8946 | 8959 | 8959 | 8959 |
| 2085 | 8957 | 8957 | 8557 | 9299 | 8965 | 8946 | 8959 | 8959 | 8959 |
| 2086 | 8957 | 8957 | 8557 | 9299 | 8965 | 8946 | 8959 | 8959 | 8959 |
| 2087 | 8957 | 8957 | 8557 | 9299 | 8965 | 8946 | 8959 | 8959 | 8959 |
| 2088 | 8957 | 8957 | 8557 | 9299 | 8965 | 8946 | 8959 | 8959 | 8959 |
| 2089 | 8957 | 8957 | 8557 | 9299 | 8965 | 8946 | 8959 | 8959 | 8959 |
| 2090 | 8957 | 8957 | 8557 | 9299 | 8965 | 8946 | 8959 | 8959 | 8959 |
|      |      |      |      |      |      |      |      |      |      |

|      | 19   | 20   | 21   | 22   | 23   | 24   | 25   | 26   | 27   |
|------|------|------|------|------|------|------|------|------|------|
| 2002 | 0    | 0    | 0    | 0    | 0    | 0    | 0    | 0    | 0    |
| 2003 | 0    | 0    | 0    | 0    | 0    | 0    | 0    | 0    | 0    |
| 2004 | 1    | 1    | 1    | 1    | 1    | 1    | 1    | 1    | 1    |
| 2005 | 3    | 3    | 3    | 3    | 3    | 3    | 3    | 3    | 3    |
| 2006 | 14   | 14   | 14   | 14   | 14   | 14   | 14   | 14   | 14   |
| 2007 | 33   | 33   | 33   | 33   | 33   | 33   | 33   | 33   | 33   |
| 2008 | 67   | 67   | 67   | 67   | 67   | 67   | 67   | 67   | 67   |
| 2009 | 128  | 128  | 128  | 128  | 128  | 128  | 128  | 128  | 128  |
| 2010 | 210  | 210  | 210  | 210  | 210  | 210  | 210  | 210  | 210  |
| 2011 | 313  | 313  | 313  | 313  | 313  | 313  | 313  | 313  | 313  |
| 2012 | 418  | 418  | 418  | 418  | 418  | 418  | 418  | 418  | 418  |
| 2013 | 547  | 547  | 547  | 547  | 547  | 547  | 547  | 547  | 547  |
| 2014 | 665  | 665  | 665  | 665  | 665  | 665  | 665  | 665  | 665  |
| 2015 | 814  | 814  | 814  | 814  | 814  | 814  | 814  | 814  | 814  |
| 2016 | 957  | 957  | 957  | 957  | 957  | 957  | 957  | 957  | 957  |
| 2017 | 1109 | 1109 | 1109 | 1109 | 1109 | 1109 | 1109 | 1109 | 1109 |
| 2018 | 1276 | 1276 | 1276 | 1276 | 1276 | 1276 | 1276 | 1276 | 1276 |
| 2019 | 1449 | 1449 | 1449 | 1449 | 1449 | 1449 | 1449 | 1449 | 1449 |
| 2020 | 1622 | 1622 | 1622 | 1699 | 1622 | 1622 | 1622 | 1622 | 1622 |
| 2021 | 1808 | 1808 | 1808 | 1947 | 1808 | 1808 | 1808 | 1808 | 1808 |
| 2022 | 1974 | 1974 | 1974 | 2189 | 1974 | 1974 | 1974 | 1974 | 1974 |
| 2023 | 2164 | 2164 | 2164 | 2439 | 2164 | 2164 | 2164 | 2164 | 2164 |
| 2024 | 2363 | 2363 | 2363 | 2698 | 2363 | 2363 | 2363 | 2363 | 2363 |
| 2025 | 2613 | 2613 | 2555 | 2938 | 2613 | 2613 | 2613 | 2613 | 2613 |
| 2026 | 2856 | 2856 | 2738 | 3172 | 2859 | 2852 | 2856 | 2856 | 2856 |
| 2027 | 3102 | 3102 | 2931 | 3417 | 3109 | 3093 | 3102 | 3102 | 3102 |
| 2028 | 3342 | 3339 | 3125 | 3673 | 3359 | 3326 | 3347 | 3347 | 3347 |
| 2029 | 3578 | 3573 | 3297 | 3934 | 3595 | 3547 | 3590 | 3590 | 3590 |
| 2030 | 3827 | 3815 | 3547 | 4197 | 3840 | 3775 | 3833 | 3833 | 3833 |
| 2031 | 4055 | 4042 | 3792 | 4448 | 4081 | 4007 | 4059 | 4059 | 4059 |
| 2032 | 4281 | 4270 | 4035 | 4693 | 4299 | 4220 | 4278 | 4278 | 4278 |
| 2033 | 4507 | 4497 | 4281 | 4895 | 4541 | 4449 | 4501 | 4501 | 4501 |
| 2034 | 4751 | 4747 | 4527 | 5122 | 4766 | 4709 | 4758 | 4758 | 4758 |
| 2035 | 4999 | 5000 | 4775 | 5315 | 5005 | 4956 | 5003 | 5003 | 5003 |
| 2036 | 5205 | 5199 | 5015 | 5543 | 5209 | 5159 | 5211 | 5211 | 5211 |
| 2037 | 5422 | 5409 | 5249 | 5762 | 5419 | 5362 | 5421 | 5421 | 5421 |
| 2038 | 5625 | 5612 | 5494 | 5950 | 5609 | 5561 | 5623 | 5623 | 5623 |
| 2039 | 5797 | 5791 | 5700 | 6177 | 5803 | 5754 | 5800 | 5800 | 5800 |
| 2040 | 6020 | 6007 | 5907 | 6388 | 6032 | 5981 | 6032 | 6032 | 6032 |
| 2041 | 6254 | 6239 | 6135 | 6607 | 6261 | 6211 | 6271 | 6271 | 6271 |
| 2042 | 6516 | 6504 | 6346 | 6848 | 6502 | 6454 | 6535 | 6535 | 6535 |
| 2043 | 6727 | 6709 | 6574 | 7126 | 6717 | 6668 | 6744 | 6744 | 6744 |
| 2044 | 6920 | 6910 | 6790 | 7292 | 6935 | 6854 | 6935 | 6935 | 6935 |
| 2045 | 7125 | 7109 | 6983 | 7643 | 7164 | 7068 | 7141 | 7141 | 7141 |
| 2046 | 7250 | 7250 | 7196 | 7991 | 7262 | 7258 | 7260 | 7260 | 7260 |
| 2047 | 7671 | 7671 | 7272 | 8285 | 7654 | 7648 | 7681 | 7681 | 7681 |
| 2048 | 8014 | 8013 | 7677 | 8527 | 7995 | 7995 | 8023 | 8023 | 8023 |
| 2049 | 8260 | 8259 | 7955 | 8692 | 8240 | 8240 | 8269 | 8269 | 8269 |
| 2050 | 8450 | 8449 | 8142 | 8806 | 8430 | 8431 | 8459 | 8459 | 8459 |
| 2051 | 8634 | 8633 | 8309 | 8905 | 8614 | 8616 | 8643 | 8643 | 8643 |
| 2052 | 8748 | 8747 | 8411 | 8966 | 8728 | 8730 | 8757 | 8757 | 8757 |
| 2053 | 8796 | 8795 | 8455 | 9014 | 8776 | 8778 | 8805 | 8805 | 8805 |
| 2054 | 8833 | 8832 | 8491 | 9053 | 8813 | 8815 | 8842 | 8842 | 8842 |
| 2055 | 8869 | 8868 | 8527 | 9087 | 8850 | 8851 | 8878 | 8878 | 8878 |
| 2056 | 8909 | 8907 | 8548 | 9111 | 8899 | 8890 | 8917 | 8917 | 8917 |
| 2057 | 8944 | 8941 | 8563 | 9135 | 8933 | 8921 | 8951 | 8951 | 8951 |
| 2058 | 8956 | 8953 | 8565 | 9147 | 8945 | 8933 | 8963 | 8963 | 8963 |
| 2059 | 8959 | 8956 | 8565 | 9148 | 8948 | 8936 | 8966 | 8966 | 8966 |

|      | 19   | 20   | 21   | 22   | 23   | 24   | 25   | 26   | 27   |
|------|------|------|------|------|------|------|------|------|------|
| 2060 | 8960 | 8957 | 8565 | 9149 | 8949 | 8937 | 8967 | 8967 | 8967 |
| 2061 | 8960 | 8957 | 8565 | 9149 | 8949 | 8937 | 8967 | 8967 | 8967 |
| 2062 | 8960 | 8957 | 8565 | 9149 | 8949 | 8937 | 8967 | 8967 | 8967 |
| 2063 | 8960 | 8957 | 8565 | 9149 | 8949 | 8937 | 8967 | 8967 | 8967 |
| 2064 | 8960 | 8957 | 8565 | 9149 | 8949 | 8937 | 8967 | 8967 | 8967 |
| 2065 | 8960 | 8957 | 8565 | 9149 | 8949 | 8937 | 8967 | 8967 | 8967 |
| 2066 | 8960 | 8957 | 8565 | 9149 | 8949 | 8937 | 8967 | 8967 | 8967 |
| 2067 | 8960 | 8957 | 8565 | 9149 | 8949 | 8937 | 8967 | 8967 | 8967 |
| 2068 | 8960 | 8957 | 8565 | 9149 | 8949 | 8937 | 8967 | 8967 | 8967 |
| 2069 | 8960 | 8957 | 8565 | 9149 | 8949 | 8937 | 8967 | 8967 | 8967 |
| 2070 | 8960 | 8957 | 8565 | 9149 | 8949 | 8937 | 8967 | 8967 | 8967 |
| 2071 | 8960 | 8957 | 8565 | 9149 | 8949 | 8937 | 8967 | 8967 | 8967 |
| 2072 | 8960 | 8957 | 8565 | 9149 | 8949 | 8937 | 8967 | 8967 | 8967 |
| 2073 | 8960 | 8957 | 8565 | 9149 | 8949 | 8937 | 8967 | 8967 | 8967 |
| 2074 | 8960 | 8957 | 8565 | 9149 | 8949 | 8937 | 8967 | 8967 | 8967 |
| 2075 | 8960 | 8957 | 8565 | 9149 | 8949 | 8937 | 8967 | 8967 | 8967 |
| 2076 | 8960 | 8957 | 8565 | 9149 | 8949 | 8937 | 8967 | 8967 | 8967 |
| 2077 | 8960 | 8957 | 8565 | 9149 | 8949 | 8937 | 8967 | 8967 | 8967 |
| 2078 | 8960 | 8957 | 8565 | 9149 | 8949 | 8937 | 8967 | 8967 | 8967 |
| 2079 | 8960 | 8957 | 8565 | 9149 | 8949 | 8937 | 8967 | 8967 | 8967 |
| 2080 | 8960 | 8957 | 8565 | 9149 | 8949 | 8937 | 8967 | 8967 | 8967 |
| 2081 | 8960 | 8957 | 8565 | 9149 | 8949 | 8937 | 8967 | 8967 | 8967 |
| 2082 | 8960 | 8957 | 8565 | 9149 | 8949 | 8937 | 8967 | 8967 | 8967 |
| 2083 | 8960 | 8957 | 8565 | 9149 | 8949 | 8937 | 8967 | 8967 | 8967 |
| 2084 | 8960 | 8957 | 8565 | 9149 | 8949 | 8937 | 8967 | 8967 | 8967 |
| 2085 | 8960 | 8957 | 8565 | 9149 | 8949 | 8937 | 8967 | 8967 | 8967 |
| 2086 | 8960 | 8957 | 8565 | 9149 | 8949 | 8937 | 8967 | 8967 | 8967 |
| 2087 | 8960 | 8957 | 8565 | 9149 | 8949 | 8937 | 8967 | 8967 | 8967 |
| 2088 | 8960 | 8957 | 8565 | 9149 | 8949 | 8937 | 8967 | 8967 | 8967 |
| 2089 | 8960 | 8957 | 8565 | 9149 | 8949 | 8937 | 8967 | 8967 | 8967 |
| 2090 | 8960 | 8957 | 8565 | 9149 | 8949 | 8937 | 8967 | 8967 | 8967 |
|      |      |      |      |      |      |      |      |      |      |



|      | 28   | 29   | 30   | 31   | 32   | 33   | 34   | 35   | 36   |
|------|------|------|------|------|------|------|------|------|------|
| 2002 | 0    | 0    | 0    | 0    | 0    | 0    | 0    | 0    | 0    |
| 2003 | 0    | 0    | 0    | 0    | 0    | 0    | 0    | 0    | 0    |
| 2004 | 1    | 1    | 1    | 1    | 1    | 1    | 1    | 1    | 1    |
| 2005 | 3    | 3    | 3    | 3    | 3    | 3    | 3    | 3    | 3    |
| 2006 | 14   | 14   | 14   | 14   | 14   | 14   | 14   | 14   | 14   |
| 2007 | 33   | 33   | 33   | 33   | 33   | 33   | 33   | 33   | 33   |
| 2008 | 67   | 67   | 67   | 67   | 67   | 67   | 67   | 67   | 67   |
| 2009 | 128  | 128  | 128  | 128  | 128  | 128  | 128  | 128  | 128  |
| 2010 | 210  | 210  | 210  | 210  | 210  | 210  | 210  | 210  | 210  |
| 2011 | 313  | 313  | 313  | 313  | 313  | 313  | 313  | 313  | 313  |
| 2012 | 418  | 418  | 418  | 418  | 418  | 418  | 418  | 418  | 418  |
| 2013 | 547  | 547  | 547  | 547  | 547  | 547  | 547  | 547  | 547  |
| 2014 | 665  | 665  | 665  | 665  | 665  | 665  | 665  | 665  | 665  |
| 2015 | 814  | 814  | 814  | 814  | 814  | 814  | 814  | 814  | 814  |
| 2016 | 957  | 957  | 957  | 957  | 957  | 957  | 957  | 957  | 957  |
| 2017 | 1109 | 1109 | 1109 | 1109 | 1109 | 1109 | 1109 | 1109 | 1109 |
| 2018 | 1276 | 1276 | 1276 | 1276 | 1276 | 1276 | 1276 | 1276 | 1276 |
| 2019 | 1449 | 1449 | 1449 | 1449 | 1449 | 1449 | 1449 | 1449 | 1449 |
| 2020 | 1622 | 1622 | 1622 | 1703 | 1622 | 1622 | 1622 | 1622 | 1622 |
| 2021 | 1808 | 1808 | 1808 | 1955 | 1808 | 1808 | 1808 | 1808 | 1808 |
| 2022 | 1974 | 1974 | 1974 | 2209 | 1974 | 1974 | 1974 | 1974 | 1974 |
| 2023 | 2164 | 2164 | 2164 | 2466 | 2164 | 2164 | 2164 | 2164 | 2164 |
| 2024 | 2363 | 2363 | 2363 | 2717 | 2363 | 2363 | 2363 | 2363 | 2363 |
| 2025 | 2619 | 2619 | 2555 | 2986 | 2619 | 2619 | 2619 | 2619 | 2619 |
| 2026 | 2869 | 2869 | 2738 | 3242 | 2869 | 2869 | 2869 | 2869 | 2869 |
| 2027 | 3120 | 3120 | 2931 | 3499 | 3120 | 3120 | 3120 | 3120 | 3120 |
| 2028 | 3374 | 3374 | 3125 | 3753 | 3374 | 3374 | 3374 | 3374 | 3374 |
| 2029 | 3624 | 3624 | 3297 | 4027 | 3624 | 3624 | 3624 | 3624 | 3624 |
| 2030 | 3876 | 3876 | 3553 | 4291 | 3876 | 3876 | 3876 | 3876 | 3876 |
| 2031 | 4134 | 4134 | 3806 | 4549 | 4134 | 4134 | 4134 | 4134 | 4134 |
| 2032 | 4390 | 4390 | 4056 | 4830 | 4390 | 4383 | 4390 | 4390 | 4390 |
| 2033 | 4640 | 4640 | 4313 | 5121 | 4640 | 4619 | 4640 | 4640 | 4640 |
| 2034 | 4899 | 4899 | 4568 | 5380 | 4899 | 4836 | 4899 | 4899 | 4899 |
| 2035 | 5166 | 5166 | 4820 | 5714 | 5166 | 5064 | 5166 | 5166 | 5166 |
| 2036 | 5452 | 5452 | 5087 | 6010 | 5451 | 5277 | 5452 | 5452 | 5452 |
| 2037 | 5700 | 5714 | 5349 | 6242 | 5724 | 5539 | 5710 | 5710 | 5710 |
| 2038 | 6016 | 6028 | 5608 | 6520 | 6050 | 5787 | 6026 | 6026 | 6026 |
| 2039 | 6236 | 6254 | 5866 | 6823 | 6327 | 6063 | 6246 | 6246 | 6246 |
| 2040 | 6536 | 6562 | 6124 | 7095 | 6625 | 6359 | 6553 | 6553 | 6553 |
| 2041 | 6804 | 6818 | 6369 | 7257 | 6874 | 6650 | 6814 | 6814 | 6814 |
| 2042 | 7072 | 7108 | 6620 | 7892 | 7213 | 6941 | 7131 | 7131 | 7131 |
| 2043 | 7319 | 7330 | 6903 | 8308 | 7281 | 7279 | 7327 | 7327 | 7327 |
| 2044 | 7976 | 7978 | 7131 | 8554 | 7934 | 7953 | 7968 | 7968 | 7968 |
| 2045 | 8375 | 8365 | 7277 | 8666 | 8319 | 8368 | 8354 | 8354 | 8354 |
| 2046 | 8558 | 8547 | 8044 | 8728 | 8505 | 8561 | 8536 | 8536 | 8536 |
| 2047 | 8645 | 8634 | 8389 | 8765 | 8592 | 8648 | 8623 | 8623 | 8623 |
| 2048 | 8726 | 8717 | 8550 | 8816 | 8680 | 8728 | 8707 | 8707 | 8707 |
| 2049 | 8737 | 8728 | 8638 | 8825 | 8690 | 8739 | 8717 | 8717 | 8717 |
| 2050 | 8746 | 8737 | 8651 | 8834 | 8699 | 8749 | 8726 | 8726 | 8726 |
| 2051 | 8761 | 8752 | 8667 | 8849 | 8714 | 8765 | 8741 | 8741 | 8741 |
| 2052 | 8766 | 8757 | 8672 | 8854 | 8719 | 8770 | 8746 | 8746 | 8746 |
| 2053 | 8766 | 8757 | 8672 | 8854 | 8719 | 8770 | 8746 | 8746 | 8746 |
| 2054 | 8779 | 8770 | 8685 | 8867 | 8732 | 8783 | 8759 | 8759 | 8759 |
| 2055 | 8781 | 8772 | 8687 | 8869 | 8734 | 8785 | 8761 | 8761 | 8761 |
| 2056 | 8791 | 8782 | 8697 | 8879 | 8744 | 8795 | 8771 | 8771 | 8771 |
| 2057 | 8791 | 8782 | 8697 | 8879 | 8744 | 8795 | 8771 | 8771 | 8771 |
| 2058 | 8791 | 8782 | 8697 | 8879 | 8744 | 8795 | 8771 | 8771 | 8771 |
| 2059 | 8791 | 8782 | 8697 | 8879 | 8744 | 8795 | 8771 | 8771 | 8771 |

|      | 28   | 29   | 30   | 31   | 32   | 33   | 34   | 35   | 36   |
|------|------|------|------|------|------|------|------|------|------|
| 2060 | 8791 | 8782 | 8697 | 8879 | 8744 | 8795 | 8771 | 8771 | 8771 |
| 2061 | 8791 | 8782 | 8697 | 8879 | 8744 | 8795 | 8771 | 8771 | 8771 |
| 2062 | 8791 | 8782 | 8697 | 8879 | 8744 | 8795 | 8771 | 8771 | 8771 |
| 2063 | 8791 | 8782 | 8697 | 8879 | 8744 | 8795 | 8771 | 8771 | 8771 |
| 2064 | 8791 | 8782 | 8697 | 8879 | 8744 | 8795 | 8771 | 8771 | 8771 |
| 2065 | 8791 | 8782 | 8697 | 8879 | 8744 | 8795 | 8771 | 8771 | 8771 |
| 2066 | 8791 | 8782 | 8697 | 8879 | 8744 | 8795 | 8771 | 8771 | 8771 |
| 2067 | 8791 | 8782 | 8697 | 8879 | 8744 | 8795 | 8771 | 8771 | 8771 |
| 2068 | 8791 | 8782 | 8697 | 8879 | 8744 | 8795 | 8771 | 8771 | 8771 |
| 2069 | 8791 | 8782 | 8697 | 8879 | 8744 | 8795 | 8771 | 8771 | 8771 |
| 2070 | 8791 | 8782 | 8697 | 8879 | 8744 | 8795 | 8771 | 8771 | 8771 |
| 2071 | 8791 | 8782 | 8697 | 8879 | 8744 | 8795 | 8771 | 8771 | 8771 |
| 2072 | 8791 | 8782 | 8697 | 8879 | 8744 | 8795 | 8771 | 8771 | 8771 |
| 2073 | 8791 | 8782 | 8697 | 8879 | 8744 | 8795 | 8771 | 8771 | 8771 |
| 2074 | 8791 | 8782 | 8697 | 8879 | 8744 | 8795 | 8771 | 8771 | 8771 |
| 2075 | 8791 | 8782 | 8697 | 8879 | 8744 | 8795 | 8771 | 8771 | 8771 |
| 2076 | 8791 | 8782 | 8697 | 8879 | 8744 | 8795 | 8771 | 8771 | 8771 |
| 2077 | 8791 | 8782 | 8697 | 8879 | 8744 | 8795 | 8771 | 8771 | 8771 |
| 2078 | 8791 | 8782 | 8697 | 8879 | 8744 | 8795 | 8771 | 8771 | 8771 |
| 2079 | 8791 | 8782 | 8697 | 8879 | 8744 | 8795 | 8771 | 8771 | 8771 |
| 2080 | 8791 | 8782 | 8697 | 8879 | 8744 | 8795 | 8771 | 8771 | 8771 |
| 2081 | 8791 | 8782 | 8697 | 8879 | 8744 | 8795 | 8771 | 8771 | 8771 |
| 2082 | 8791 | 8782 | 8697 | 8879 | 8744 | 8795 | 8771 | 8771 | 8771 |
| 2083 | 8791 | 8782 | 8697 | 8879 | 8744 | 8795 | 8771 | 8771 | 8771 |
| 2084 | 8791 | 8782 | 8697 | 8879 | 8744 | 8795 | 8771 | 8771 | 8771 |
| 2085 | 8791 | 8782 | 8697 | 8879 | 8744 | 8795 | 8771 | 8771 | 8771 |
| 2086 | 8791 | 8782 | 8697 | 8879 | 8744 | 8795 | 8771 | 8771 | 8771 |
| 2087 | 8791 | 8782 | 8697 | 8879 | 8744 | 8795 | 8771 | 8771 | 8771 |
| 2088 | 8791 | 8782 | 8697 | 8879 | 8744 | 8795 | 8771 | 8771 | 8771 |
| 2089 | 8791 | 8782 | 8697 | 8879 | 8744 | 8795 | 8771 | 8771 | 8771 |
| 2090 | 8791 | 8782 | 8697 | 8879 | 8744 | 8795 | 8771 | 8771 | 8771 |
|      |      |      |      |      |      |      |      |      |      |

|      | 37   | 38   | 39   | 40   | 41   | 42   | 43   | 44   | 45   |
|------|------|------|------|------|------|------|------|------|------|
| 2002 | 0    | 0    | 0    | 0    | 0    | 0    | 0    | 0    | 0    |
| 2003 | 0    | 0    | 0    | 0    | 0    | 0    | 0    | 0    | 0    |
| 2004 | 1    | 1    | 1    | 1    | 1    | 1    | 1    | 1    | 1    |
| 2005 | 3    | 3    | 3    | 3    | 3    | 3    | 3    | 3    | 3    |
| 2006 | 14   | 14   | 14   | 14   | 14   | 14   | 14   | 14   | 14   |
| 2007 | 33   | 33   | 33   | 33   | 33   | 33   | 33   | 33   | 33   |
| 2008 | 67   | 67   | 67   | 67   | 67   | 67   | 67   | 67   | 67   |
| 2009 | 128  | 128  | 128  | 128  | 128  | 128  | 128  | 128  | 128  |
| 2010 | 210  | 210  | 210  | 210  | 210  | 210  | 210  | 210  | 210  |
| 2011 | 313  | 313  | 313  | 313  | 313  | 313  | 313  | 313  | 313  |
| 2012 | 418  | 418  | 418  | 418  | 418  | 418  | 418  | 418  | 418  |
| 2013 | 547  | 547  | 547  | 547  | 547  | 547  | 547  | 547  | 547  |
| 2014 | 665  | 665  | 665  | 665  | 665  | 665  | 665  | 665  | 665  |
| 2015 | 814  | 814  | 814  | 814  | 814  | 814  | 814  | 814  | 814  |
| 2016 | 957  | 957  | 957  | 957  | 957  | 957  | 957  | 957  | 957  |
| 2017 | 1109 | 1109 | 1109 | 1109 | 1109 | 1109 | 1109 | 1109 | 1109 |
| 2018 | 1276 | 1276 | 1276 | 1276 | 1276 | 1276 | 1276 | 1276 | 1276 |
| 2019 | 1449 | 1449 | 1449 | 1449 | 1449 | 1449 | 1449 | 1449 | 1449 |
| 2020 | 1622 | 1622 | 1622 | 1699 | 1622 | 1622 | 1622 | 1622 | 1622 |
| 2021 | 1808 | 1808 | 1808 | 1949 | 1808 | 1808 | 1808 | 1808 | 1808 |
| 2022 | 1974 | 1974 | 1974 | 2194 | 1974 | 1974 | 1974 | 1974 | 1974 |
| 2023 | 2164 | 2164 | 2164 | 2439 | 2164 | 2164 | 2164 | 2164 | 2164 |
| 2024 | 2363 | 2363 | 2363 | 2695 | 2363 | 2363 | 2363 | 2363 | 2363 |
| 2025 | 2613 | 2613 | 2555 | 2925 | 2613 | 2611 | 2613 | 2613 | 2613 |
| 2026 | 2853 | 2853 | 2738 | 3158 | 2855 | 2839 | 2853 | 2853 | 2853 |
| 2027 | 3103 | 3103 | 2931 | 3408 | 3095 | 3067 | 3103 | 3103 | 3103 |
| 2028 | 3339 | 3337 | 3125 | 3673 | 3333 | 3289 | 3341 | 3341 | 3341 |
| 2029 | 3563 | 3556 | 3297 | 3926 | 3556 | 3509 | 3567 | 3567 | 3567 |
| 2030 | 3802 | 3800 | 3547 | 4123 | 3785 | 3733 | 3804 | 3804 | 3804 |
| 2031 | 4030 | 4027 | 3797 | 4349 | 4004 | 3964 | 4029 | 4029 | 4029 |
| 2032 | 4237 | 4235 | 4030 | 4571 | 4205 | 4197 | 4233 | 4233 | 4233 |
| 2033 | 4452 | 4449 | 4270 | 4793 | 4435 | 4409 | 4447 | 4447 | 4447 |
| 2034 | 4686 | 4693 | 4518 | 5022 | 4682 | 4647 | 4691 | 4691 | 4691 |
| 2035 | 4922 | 4926 | 4746 | 5255 | 4913 | 4886 | 4929 | 4929 | 4929 |
| 2036 | 5110 | 5104 | 4960 | 5463 | 5106 | 5099 | 5127 | 5127 | 5127 |
| 2037 | 5320 | 5306 | 5158 | 5656 | 5309 | 5301 | 5333 | 5333 | 5333 |
| 2038 | 5526 | 5511 | 5380 | 5827 | 5518 | 5500 | 5537 | 5537 | 5537 |
| 2039 | 5726 | 5712 | 5580 | 6016 | 5717 | 5684 | 5733 | 5733 | 5733 |
| 2040 | 5956 | 5948 | 5799 | 6226 | 5970 | 5929 | 5963 | 5963 | 5963 |
| 2041 | 6178 | 6183 | 6032 | 6459 | 6193 | 6142 | 6193 | 6193 | 6193 |
| 2042 | 6372 | 6401 | 6228 | 6603 | 6413 | 6345 | 6400 | 6400 | 6400 |
| 2043 | 6544 | 6595 | 6442 | 6744 | 6618 | 6548 | 6589 | 6589 | 6589 |
| 2044 | 6684 | 6741 | 6678 | 6908 | 6820 | 6716 | 6725 | 6725 | 6725 |
| 2045 | 6825 | 6868 | 6898 | 7063 | 7002 | 6899 | 6868 | 6868 | 6868 |
| 2046 | 6973 | 7001 | 7101 | 7206 | 7167 | 7072 | 7009 | 7009 | 7009 |
| 2047 | 7145 | 7158 | 7263 | 7252 | 7251 | 7254 | 7179 | 7179 | 7179 |
| 2048 | 7250 | 7253 | 7667 | 7620 | 7672 | 7633 | 7264 | 7264 | 7264 |
| 2049 | 7666 | 7674 | 7945 | 7966 | 8014 | 7974 | 7682 | 7682 | 7682 |
| 2050 | 8009 | 8016 | 8132 | 8257 | 8260 | 8220 | 8024 | 8024 | 8024 |
| 2051 | 8255 | 8262 | 8299 | 8493 | 8450 | 8411 | 8270 | 8270 | 8270 |
| 2052 | 8445 | 8452 | 8401 | 8674 | 8634 | 8592 | 8460 | 8460 | 8460 |
| 2053 | 8629 | 8636 | 8445 | 8822 | 8748 | 8702 | 8644 | 8644 | 8644 |
| 2054 | 8743 | 8750 | 8481 | 8946 | 8796 | 8750 | 8758 | 8758 | 8758 |
| 2055 | 8791 | 8798 | 8517 | 9018 | 8833 | 8787 | 8806 | 8806 | 8806 |
| 2056 | 8828 | 8835 | 8538 | 9066 | 8869 | 8823 | 8843 | 8843 | 8843 |
| 2057 | 8864 | 8871 | 8553 | 9105 | 8908 | 8862 | 8879 | 8879 | 8879 |
| 2058 | 8903 | 8910 | 8555 | 9141 | 8942 | 8896 | 8918 | 8918 | 8918 |
| 2059 | 8937 | 8944 | 8555 | 9166 | 8954 | 8908 | 8952 | 8952 | 8952 |

|      | 37   | 38   | 39   | 40   | 41   | 42   | 43   | 44   | 45   |
|------|------|------|------|------|------|------|------|------|------|
| 2060 | 8949 | 8956 | 8555 | 9190 | 8957 | 8911 | 8964 | 8964 | 8964 |
| 2061 | 8952 | 8959 | 8555 | 9205 | 8958 | 8912 | 8967 | 8967 | 8967 |
| 2062 | 8953 | 8960 | 8555 | 9210 | 8958 | 8912 | 8968 | 8968 | 8968 |
| 2063 | 8953 | 8960 | 8555 | 9210 | 8958 | 8912 | 8968 | 8968 | 8968 |
| 2064 | 8953 | 8960 | 8555 | 9210 | 8958 | 8912 | 8968 | 8968 | 8968 |
| 2065 | 8953 | 8960 | 8555 | 9210 | 8958 | 8912 | 8968 | 8968 | 8968 |
| 2066 | 8953 | 8960 | 8555 | 9210 | 8958 | 8912 | 8968 | 8968 | 8968 |
| 2067 | 8953 | 8960 | 8555 | 9210 | 8958 | 8912 | 8968 | 8968 | 8968 |
| 2068 | 8953 | 8960 | 8555 | 9210 | 8958 | 8912 | 8968 | 8968 | 8968 |
| 2069 | 8953 | 8960 | 8555 | 9210 | 8958 | 8912 | 8968 | 8968 | 8968 |
| 2070 | 8953 | 8960 | 8555 | 9210 | 8958 | 8912 | 8968 | 8968 | 8968 |
| 2071 | 8953 | 8960 | 8555 | 9210 | 8958 | 8912 | 8968 | 8968 | 8968 |
| 2072 | 8953 | 8960 | 8555 | 9210 | 8958 | 8912 | 8968 | 8968 | 8968 |
| 2073 | 8953 | 8960 | 8555 | 9210 | 8958 | 8912 | 8968 | 8968 | 8968 |
| 2074 | 8953 | 8960 | 8555 | 9210 | 8958 | 8912 | 8968 | 8968 | 8968 |
| 2075 | 8953 | 8960 | 8555 | 9210 | 8958 | 8912 | 8968 | 8968 | 8968 |
| 2076 | 8953 | 8960 | 8555 | 9210 | 8958 | 8912 | 8968 | 8968 | 8968 |
| 2077 | 8953 | 8960 | 8555 | 9210 | 8958 | 8912 | 8968 | 8968 | 8968 |
| 2078 | 8953 | 8960 | 8555 | 9210 | 8958 | 8912 | 8968 | 8968 | 8968 |
| 2079 | 8953 | 8960 | 8555 | 9210 | 8958 | 8912 | 8968 | 8968 | 8968 |
| 2080 | 8953 | 8960 | 8555 | 9210 | 8958 | 8912 | 8968 | 8968 | 8968 |
| 2081 | 8953 | 8960 | 8555 | 9210 | 8958 | 8912 | 8968 | 8968 | 8968 |
| 2082 | 8953 | 8960 | 8555 | 9210 | 8958 | 8912 | 8968 | 8968 | 8968 |
| 2083 | 8953 | 8960 | 8555 | 9210 | 8958 | 8912 | 8968 | 8968 | 8968 |
| 2084 | 8953 | 8960 | 8555 | 9210 | 8958 | 8912 | 8968 | 8968 | 8968 |
| 2085 | 8953 | 8960 | 8555 | 9210 | 8958 | 8912 | 8968 | 8968 | 8968 |
| 2086 | 8953 | 8960 | 8555 | 9210 | 8958 | 8912 | 8968 | 8968 | 8968 |
| 2087 | 8953 | 8960 | 8555 | 9210 | 8958 | 8912 | 8968 | 8968 | 8968 |
| 2088 | 8953 | 8960 | 8555 | 9210 | 8958 | 8912 | 8968 | 8968 | 8968 |
| 2089 | 8953 | 8960 | 8555 | 9210 | 8958 | 8912 | 8968 | 8968 | 8968 |
| 2090 | 8953 | 8960 | 8555 | 9210 | 8958 | 8912 | 8968 | 8968 | 8968 |
|      |      |      |      |      |      |      |      |      |      |

|      | 46   | 47   | 48   | 49   | 50   | 51   | 52   | 53   | 54   |
|------|------|------|------|------|------|------|------|------|------|
| 2002 | 0    | 0    | 0    | 0    | 0    | 0    | 0    | 0    | 0    |
| 2003 | 0    | 0    | 0    | 0    | 0    | 0    | 0    | 0    | 0    |
| 2004 | 1    | 1    | 1    | 1    | 1    | 1    | 1    | 1    | 1    |
| 2005 | 3    | 3    | 3    | 3    | 3    | 3    | 3    | 3    | 3    |
| 2006 | 14   | 14   | 14   | 14   | 14   | 14   | 14   | 14   | 14   |
| 2007 | 33   | 33   | 33   | 33   | 33   | 33   | 33   | 33   | 33   |
| 2008 | 67   | 67   | 67   | 67   | 67   | 67   | 67   | 67   | 67   |
| 2009 | 128  | 128  | 128  | 128  | 128  | 128  | 128  | 128  | 128  |
| 2010 | 210  | 210  | 210  | 210  | 210  | 210  | 210  | 210  | 210  |
| 2011 | 313  | 313  | 313  | 313  | 313  | 313  | 313  | 313  | 313  |
| 2012 | 418  | 418  | 418  | 418  | 418  | 418  | 418  | 418  | 418  |
| 2013 | 547  | 547  | 547  | 547  | 547  | 547  | 547  | 547  | 547  |
| 2014 | 665  | 665  | 665  | 665  | 665  | 665  | 665  | 665  | 665  |
| 2015 | 814  | 814  | 814  | 814  | 814  | 814  | 814  | 814  | 814  |
| 2016 | 957  | 957  | 957  | 957  | 957  | 957  | 957  | 957  | 957  |
| 2017 | 1109 | 1109 | 1109 | 1109 | 1109 | 1109 | 1109 | 1109 | 1109 |
| 2018 | 1276 | 1276 | 1276 | 1276 | 1276 | 1276 | 1276 | 1276 | 1276 |
| 2019 | 1449 | 1449 | 1449 | 1449 | 1449 | 1449 | 1449 | 1449 | 1449 |
| 2020 | 1622 | 1622 | 1622 | 1699 | 1622 | 1622 | 1622 | 1622 | 1622 |
| 2021 | 1808 | 1808 | 1808 | 1945 | 1808 | 1808 | 1808 | 1808 | 1808 |
| 2022 | 1974 | 1974 | 1974 | 2188 | 1974 | 1974 | 1974 | 1974 | 1974 |
| 2023 | 2164 | 2164 | 2164 | 2435 | 2164 | 2164 | 2164 | 2164 | 2164 |
| 2024 | 2363 | 2363 | 2363 | 2693 | 2363 | 2363 | 2363 | 2363 | 2363 |
| 2025 | 2613 | 2613 | 2555 | 2932 | 2613 | 2613 | 2613 | 2613 | 2613 |
| 2026 | 2849 | 2850 | 2738 | 3166 | 2855 | 2845 | 2849 | 2849 | 2849 |
| 2027 | 3093 | 3094 | 2931 | 3406 | 3105 | 3083 | 3093 | 3093 | 3093 |
| 2028 | 3333 | 3333 | 3125 | 3667 | 3356 | 3315 | 3333 | 3333 | 3333 |
| 2029 | 3571 | 3567 | 3297 | 3926 | 3591 | 3537 | 3572 | 3572 | 3572 |
| 2030 | 3818 | 3805 | 3547 | 4188 | 3835 | 3760 | 3815 | 3815 | 3815 |
| 2031 | 4044 | 4032 | 3787 | 4441 | 4076 | 3991 | 4038 | 4038 | 4038 |
| 2032 | 4266 | 4258 | 4028 | 4680 | 4290 | 4211 | 4264 | 4264 | 4264 |
| 2033 | 4493 | 4489 | 4272 | 4879 | 4527 | 4437 | 4483 | 4483 | 4483 |
| 2034 | 4736 | 4733 | 4523 | 5102 | 4747 | 4690 | 4733 | 4733 | 4733 |
| 2035 | 4985 | 4985 | 4759 | 5305 | 4989 | 4925 | 4982 | 4982 | 4982 |
| 2036 | 5187 | 5184 | 4993 | 5529 | 5208 | 5124 | 5173 | 5173 | 5173 |
| 2037 | 5402 | 5393 | 5219 | 5750 | 5418 | 5334 | 5386 | 5386 | 5386 |
| 2038 | 5610 | 5592 | 5457 | 5941 | 5603 | 5552 | 5588 | 5588 | 5588 |
| 2039 | 5791 | 5765 | 5657 | 6168 | 5802 | 5752 | 5766 | 5766 | 5766 |
| 2040 | 6053 | 5986 | 5855 | 6383 | 6040 | 5991 | 6004 | 6004 | 6004 |
| 2041 | 6287 | 6212 | 6080 | 6616 | 6264 | 6225 | 6236 | 6236 | 6236 |
| 2042 | 6534 | 6465 | 6303 | 6879 | 6496 | 6475 | 6486 | 6486 | 6486 |
| 2043 | 6740 | 6686 | 6523 | 7157 | 6711 | 6683 | 6703 | 6703 | 6703 |
| 2044 | 6927 | 6898 | 6729 | 7305 | 6940 | 6889 | 6909 | 6909 | 6909 |
| 2045 | 7141 | 7112 | 6926 | 7654 | 7184 | 7079 | 7127 | 7127 | 7127 |
| 2046 | 7264 | 7254 | 7143 | 8002 | 7278 | 7259 | 7251 | 7251 | 7251 |
| 2047 | 7685 | 7675 | 7250 | 8296 | 7650 | 7633 | 7672 | 7672 | 7672 |
| 2048 | 8028 | 8018 | 7655 | 8531 | 7991 | 7978 | 8015 | 8015 | 8015 |
| 2049 | 8274 | 8264 | 7933 | 8685 | 8236 | 8223 | 8261 | 8261 | 8261 |
| 2050 | 8464 | 8454 | 8120 | 8797 | 8426 | 8414 | 8451 | 8451 | 8451 |
| 2051 | 8648 | 8638 | 8287 | 8897 | 8610 | 8599 | 8635 | 8635 | 8635 |
| 2052 | 8762 | 8752 | 8389 | 8958 | 8724 | 8713 | 8749 | 8749 | 8749 |
| 2053 | 8810 | 8800 | 8433 | 9007 | 8772 | 8761 | 8797 | 8797 | 8797 |
| 2054 | 8847 | 8837 | 8469 | 9045 | 8809 | 8798 | 8834 | 8834 | 8834 |
| 2055 | 8883 | 8873 | 8505 | 9080 | 8846 | 8834 | 8870 | 8870 | 8870 |
| 2056 | 8922 | 8916 | 8526 | 9104 | 8895 | 8873 | 8909 | 8909 | 8909 |
| 2057 | 8956 | 8951 | 8541 | 9129 | 8929 | 8903 | 8943 | 8943 | 8943 |
| 2058 | 8968 | 8963 | 8543 | 9130 | 8941 | 8915 | 8955 | 8955 | 8955 |
| 2059 | 8971 | 8966 | 8543 | 9130 | 8944 | 8918 | 8958 | 8958 | 8958 |

|      | 46   | 47   | 48   | 49   | 50   | 51   | 52   | 53   | 54   |
|------|------|------|------|------|------|------|------|------|------|
| 2060 | 8972 | 8967 | 8543 | 9130 | 8945 | 8919 | 8959 | 8959 | 8959 |
| 2061 | 8972 | 8967 | 8543 | 9130 | 8945 | 8919 | 8959 | 8959 | 8959 |
| 2062 | 8972 | 8967 | 8543 | 9130 | 8945 | 8919 | 8959 | 8959 | 8959 |
| 2063 | 8972 | 8967 | 8543 | 9130 | 8945 | 8919 | 8959 | 8959 | 8959 |
| 2064 | 8972 | 8967 | 8543 | 9130 | 8945 | 8919 | 8959 | 8959 | 8959 |
| 2065 | 8972 | 8967 | 8543 | 9130 | 8945 | 8919 | 8959 | 8959 | 8959 |
| 2066 | 8972 | 8967 | 8543 | 9130 | 8945 | 8919 | 8959 | 8959 | 8959 |
| 2067 | 8972 | 8967 | 8543 | 9130 | 8945 | 8919 | 8959 | 8959 | 8959 |
| 2068 | 8972 | 8967 | 8543 | 9130 | 8945 | 8919 | 8959 | 8959 | 8959 |
| 2069 | 8972 | 8967 | 8543 | 9130 | 8945 | 8919 | 8959 | 8959 | 8959 |
| 2070 | 8972 | 8967 | 8543 | 9130 | 8945 | 8919 | 8959 | 8959 | 8959 |
| 2071 | 8972 | 8967 | 8543 | 9130 | 8945 | 8919 | 8959 | 8959 | 8959 |
| 2072 | 8972 | 8967 | 8543 | 9130 | 8945 | 8919 | 8959 | 8959 | 8959 |
| 2073 | 8972 | 8967 | 8543 | 9130 | 8945 | 8919 | 8959 | 8959 | 8959 |
| 2074 | 8972 | 8967 | 8543 | 9130 | 8945 | 8919 | 8959 | 8959 | 8959 |
| 2075 | 8972 | 8967 | 8543 | 9130 | 8945 | 8919 | 8959 | 8959 | 8959 |
| 2076 | 8972 | 8967 | 8543 | 9130 | 8945 | 8919 | 8959 | 8959 | 8959 |
| 2077 | 8972 | 8967 | 8543 | 9130 | 8945 | 8919 | 8959 | 8959 | 8959 |
| 2078 | 8972 | 8967 | 8543 | 9130 | 8945 | 8919 | 8959 | 8959 | 8959 |
| 2079 | 8972 | 8967 | 8543 | 9130 | 8945 | 8919 | 8959 | 8959 | 8959 |
| 2080 | 8972 | 8967 | 8543 | 9130 | 8945 | 8919 | 8959 | 8959 | 8959 |
| 2081 | 8972 | 8967 | 8543 | 9130 | 8945 | 8919 | 8959 | 8959 | 8959 |
| 2082 | 8972 | 8967 | 8543 | 9130 | 8945 | 8919 | 8959 | 8959 | 8959 |
| 2083 | 8972 | 8967 | 8543 | 9130 | 8945 | 8919 | 8959 | 8959 | 8959 |
| 2084 | 8972 | 8967 | 8543 | 9130 | 8945 | 8919 | 8959 | 8959 | 8959 |
| 2085 | 8972 | 8967 | 8543 | 9130 | 8945 | 8919 | 8959 | 8959 | 8959 |
| 2086 | 8972 | 8967 | 8543 | 9130 | 8945 | 8919 | 8959 | 8959 | 8959 |
| 2087 | 8972 | 8967 | 8543 | 9130 | 8945 | 8919 | 8959 | 8959 | 8959 |
| 2088 | 8972 | 8967 | 8543 | 9130 | 8945 | 8919 | 8959 | 8959 | 8959 |
| 2089 | 8972 | 8967 | 8543 | 9130 | 8945 | 8919 | 8959 | 8959 | 8959 |
| 2090 | 8972 | 8967 | 8543 | 9130 | 8945 | 8919 | 8959 | 8959 | 8959 |
|      |      |      |      |      |      |      |      |      |      |

|      | 55   | 56   | 57   | 58   | 59   | 60   | 61   | 62   | 63   |
|------|------|------|------|------|------|------|------|------|------|
| 2002 | 0    | 0    | 0    | 0    | 0    | 0    | 0    | 0    | 0    |
| 2003 | 0    | 0    | 0    | 0    | 0    | 0    | 0    | 0    | 0    |
| 2004 | 1    | 1    | 1    | 1    | 1    | 1    | 1    | 1    | 1    |
| 2005 | 3    | 3    | 3    | 3    | 3    | 3    | 3    | 3    | 3    |
| 2006 | 14   | 14   | 14   | 14   | 14   | 14   | 14   | 14   | 14   |
| 2007 | 33   | 33   | 33   | 33   | 33   | 33   | 33   | 33   | 33   |
| 2008 | 67   | 67   | 67   | 67   | 67   | 67   | 67   | 67   | 67   |
| 2009 | 128  | 128  | 128  | 128  | 128  | 128  | 128  | 128  | 128  |
| 2010 | 210  | 210  | 210  | 210  | 210  | 210  | 210  | 210  | 210  |
| 2011 | 313  | 313  | 313  | 313  | 313  | 313  | 313  | 313  | 313  |
| 2012 | 418  | 418  | 418  | 418  | 418  | 418  | 418  | 418  | 418  |
| 2013 | 547  | 547  | 547  | 547  | 547  | 547  | 547  | 547  | 547  |
| 2014 | 665  | 665  | 665  | 665  | 665  | 665  | 665  | 665  | 665  |
| 2015 | 814  | 814  | 814  | 814  | 814  | 814  | 814  | 814  | 814  |
| 2016 | 957  | 957  | 957  | 957  | 957  | 957  | 957  | 957  | 957  |
| 2017 | 1109 | 1109 | 1109 | 1109 | 1109 | 1109 | 1109 | 1109 | 1109 |
| 2018 | 1276 | 1276 | 1276 | 1276 | 1276 | 1276 | 1276 | 1276 | 1276 |
| 2019 | 1449 | 1449 | 1449 | 1449 | 1449 | 1449 | 1449 | 1449 | 1449 |
| 2020 | 1622 | 1622 | 1622 | 1703 | 1622 | 1622 | 1622 | 1622 | 1622 |
| 2021 | 1808 | 1808 | 1808 | 1877 | 1808 | 1808 | 1808 | 1808 | 1808 |
| 2022 | 1974 | 1974 | 1974 | 2095 | 1974 | 1974 | 1974 | 1974 | 1974 |
| 2023 | 2164 | 2164 | 2164 | 2325 | 2164 | 2164 | 2164 | 2164 | 2164 |
| 2024 | 2363 | 2363 | 2363 | 2550 | 2363 | 2363 | 2363 | 2363 | 2363 |
| 2025 | 2619 | 2619 | 2555 | 2790 | 2619 | 2619 | 2619 | 2619 | 2619 |
| 2026 | 2779 | 2779 | 2738 | 3059 | 2779 | 2779 | 2779 | 2779 | 2779 |
| 2027 | 2982 | 2978 | 2931 | 3304 | 2978 | 2978 | 2978 | 2978 | 2978 |
| 2028 | 3174 | 3161 | 3125 | 3526 | 3166 | 3166 | 3166 | 3166 | 3166 |
| 2029 | 3365 | 3346 | 3297 | 3773 | 3351 | 3351 | 3351 | 3351 | 3351 |
| 2030 | 3571 | 3553 | 3553 | 4041 | 3568 | 3568 | 3568 | 3568 | 3568 |
| 2031 | 3788 | 3779 | 3722 | 4308 | 3789 | 3789 | 3789 | 3789 | 3789 |
| 2032 | 3973 | 3964 | 3882 | 4599 | 3973 | 3973 | 3973 | 3973 | 3973 |
| 2033 | 4182 | 4163 | 4087 | 4891 | 4174 | 4174 | 4174 | 4174 | 4174 |
| 2034 | 4410 | 4394 | 4291 | 5180 | 4402 | 4402 | 4402 | 4402 | 4402 |
| 2035 | 4659 | 4635 | 4518 | 5463 | 4653 | 4649 | 4653 | 4653 | 4653 |
| 2036 | 4933 | 4908 | 4723 | 5814 | 4929 | 4916 | 4929 | 4929 | 4929 |
| 2037 | 5214 | 5165 | 4913 | 6077 | 5175 | 5189 | 5175 | 5175 | 5175 |
| 2038 | 5469 | 5440 | 5094 | 6352 | 5450 | 5494 | 5450 | 5450 | 5450 |
| 2039 | 5746 | 5718 | 5286 | 6652 | 5737 | 5768 | 5735 | 5735 | 5735 |
| 2040 | 6076 | 6049 | 5486 | 6927 | 6027 | 6062 | 6067 | 6067 | 6067 |
| 2041 | 6414 | 6373 | 5710 | 7201 | 6374 | 6387 | 6405 | 6405 | 6405 |
| 2042 | 6694 | 6648 | 5951 | 7345 | 6652 | 6677 | 6684 | 6684 | 6684 |
| 2043 | 7073 | 7002 | 6197 | 7963 | 6979 | 7016 | 7064 | 7064 | 7064 |
| 2044 | 7286 | 7294 | 6453 | 8351 | 7288 | 7285 | 7279 | 7279 | 7279 |
| 2045 | 7943 | 7958 | 6749 | 8584 | 7968 | 7962 | 7940 | 7940 | 7940 |
| 2046 | 8324 | 8339 | 7042 | 8685 | 8370 | 8352 | 8321 | 8321 | 8321 |
| 2047 | 8504 | 8515 | 7270 | 8725 | 8564 | 8541 | 8499 | 8499 | 8499 |
| 2048 | 8599 | 8613 | 8028 | 8781 | 8684 | 8659 | 8594 | 8594 | 8594 |
| 2049 | 8635 | 8649 | 8377 | 8790 | 8723 | 8698 | 8624 | 8624 | 8624 |
| 2050 | 8645 | 8659 | 8511 | 8799 | 8734 | 8710 | 8634 | 8634 | 8634 |
| 2051 | 8660 | 8674 | 8610 | 8814 | 8749 | 8726 | 8649 | 8649 | 8649 |
| 2052 | 8665 | 8679 | 8628 | 8819 | 8754 | 8731 | 8654 | 8654 | 8654 |
| 2053 | 8665 | 8679 | 8631 | 8819 | 8754 | 8731 | 8654 | 8654 | 8654 |
| 2054 | 8678 | 8692 | 8644 | 8832 | 8767 | 8744 | 8667 | 8667 | 8667 |
| 2055 | 8680 | 8694 | 8646 | 8834 | 8769 | 8746 | 8669 | 8669 | 8669 |
| 2056 | 8690 | 8704 | 8656 | 8844 | 8779 | 8756 | 8679 | 8679 | 8679 |
| 2057 | 8690 | 8704 | 8656 | 8844 | 8779 | 8756 | 8679 | 8679 | 8679 |
| 2058 | 8690 | 8704 | 8656 | 8844 | 8779 | 8756 | 8679 | 8679 | 8679 |
| 2059 | 8690 | 8704 | 8656 | 8844 | 8779 | 8756 | 8679 | 8679 | 8679 |

|      | 55   | 56   | 57   | 58   | 59   | 60   | 61   | 62   | 63   |
|------|------|------|------|------|------|------|------|------|------|
| 2060 | 8690 | 8704 | 8656 | 8844 | 8779 | 8756 | 8679 | 8679 | 8679 |
| 2061 | 8690 | 8704 | 8656 | 8844 | 8779 | 8756 | 8679 | 8679 | 8679 |
| 2062 | 8690 | 8704 | 8656 | 8844 | 8779 | 8756 | 8679 | 8679 | 8679 |
| 2063 | 8690 | 8704 | 8656 | 8844 | 8779 | 8756 | 8679 | 8679 | 8679 |
| 2064 | 8690 | 8704 | 8656 | 8844 | 8779 | 8756 | 8679 | 8679 | 8679 |
| 2065 | 8690 | 8704 | 8656 | 8844 | 8779 | 8756 | 8679 | 8679 | 8679 |
| 2066 | 8690 | 8704 | 8656 | 8844 | 8779 | 8756 | 8679 | 8679 | 8679 |
| 2067 | 8690 | 8704 | 8656 | 8844 | 8779 | 8756 | 8679 | 8679 | 8679 |
| 2068 | 8690 | 8704 | 8656 | 8844 | 8779 | 8756 | 8679 | 8679 | 8679 |
| 2069 | 8690 | 8704 | 8656 | 8844 | 8779 | 8756 | 8679 | 8679 | 8679 |
| 2070 | 8690 | 8704 | 8656 | 8844 | 8779 | 8756 | 8679 | 8679 | 8679 |
| 2071 | 8690 | 8704 | 8656 | 8844 | 8779 | 8756 | 8679 | 8679 | 8679 |
| 2072 | 8690 | 8704 | 8656 | 8844 | 8779 | 8756 | 8679 | 8679 | 8679 |
| 2073 | 8690 | 8704 | 8656 | 8844 | 8779 | 8756 | 8679 | 8679 | 8679 |
| 2074 | 8690 | 8704 | 8656 | 8844 | 8779 | 8756 | 8679 | 8679 | 8679 |
| 2075 | 8690 | 8704 | 8656 | 8844 | 8779 | 8756 | 8679 | 8679 | 8679 |
| 2076 | 8690 | 8704 | 8656 | 8844 | 8779 | 8756 | 8679 | 8679 | 8679 |
| 2077 | 8690 | 8704 | 8656 | 8844 | 8779 | 8756 | 8679 | 8679 | 8679 |
| 2078 | 8690 | 8704 | 8656 | 8844 | 8779 | 8756 | 8679 | 8679 | 8679 |
| 2079 | 8690 | 8704 | 8656 | 8844 | 8779 | 8756 | 8679 | 8679 | 8679 |
| 2080 | 8690 | 8704 | 8656 | 8844 | 8779 | 8756 | 8679 | 8679 | 8679 |
| 2081 | 8690 | 8704 | 8656 | 8844 | 8779 | 8756 | 8679 | 8679 | 8679 |
| 2082 | 8690 | 8704 | 8656 | 8844 | 8779 | 8756 | 8679 | 8679 | 8679 |
| 2083 | 8690 | 8704 | 8656 | 8844 | 8779 | 8756 | 8679 | 8679 | 8679 |
| 2084 | 8690 | 8704 | 8656 | 8844 | 8779 | 8756 | 8679 | 8679 | 8679 |
| 2085 | 8690 | 8704 | 8656 | 8844 | 8779 | 8756 | 8679 | 8679 | 8679 |
| 2086 | 8690 | 8704 | 8656 | 8844 | 8779 | 8756 | 8679 | 8679 | 8679 |
| 2087 | 8690 | 8704 | 8656 | 8844 | 8779 | 8756 | 8679 | 8679 | 8679 |
| 2088 | 8690 | 8704 | 8656 | 8844 | 8779 | 8756 | 8679 | 8679 | 8679 |
| 2089 | 8690 | 8704 | 8656 | 8844 | 8779 | 8756 | 8679 | 8679 | 8679 |
| 2090 | 8690 | 8704 | 8656 | 8844 | 8779 | 8756 | 8679 | 8679 | 8679 |
|      |      |      |      |      |      |      |      |      |      |



|      | 64   | 65   | 66   | 67   | 68   | 69   | 70   | 71   | 72   |
|------|------|------|------|------|------|------|------|------|------|
| 2002 | 0    | 0    | 0    | 0    | 0    | 0    | 0    | 0    | 0    |
| 2003 | 0    | 0    | 0    | 0    | 0    | 0    | 0    | 0    | 0    |
| 2004 | 1    | 1    | 1    | 1    | 1    | 1    | 1    | 1    | 1    |
| 2005 | 3    | 3    | 3    | 3    | 3    | 3    | 3    | 3    | 3    |
| 2006 | 14   | 14   | 14   | 14   | 14   | 14   | 14   | 14   | 14   |
| 2007 | 33   | 33   | 33   | 33   | 33   | 33   | 33   | 33   | 33   |
| 2008 | 67   | 67   | 67   | 67   | 67   | 67   | 67   | 67   | 67   |
| 2009 | 128  | 128  | 128  | 128  | 128  | 128  | 128  | 128  | 128  |
| 2010 | 210  | 210  | 210  | 210  | 210  | 210  | 210  | 210  | 210  |
| 2011 | 313  | 313  | 313  | 313  | 313  | 313  | 313  | 313  | 313  |
| 2012 | 418  | 418  | 418  | 418  | 418  | 418  | 418  | 418  | 418  |
| 2013 | 547  | 547  | 547  | 547  | 547  | 547  | 547  | 547  | 547  |
| 2014 | 665  | 665  | 665  | 665  | 665  | 665  | 665  | 665  | 665  |
| 2015 | 814  | 814  | 814  | 814  | 814  | 814  | 814  | 814  | 814  |
| 2016 | 957  | 957  | 957  | 957  | 957  | 957  | 957  | 957  | 957  |
| 2017 | 1109 | 1109 | 1109 | 1109 | 1109 | 1109 | 1109 | 1109 | 1109 |
| 2018 | 1276 | 1276 | 1276 | 1276 | 1276 | 1276 | 1276 | 1276 | 1276 |
| 2019 | 1449 | 1449 | 1449 | 1449 | 1449 | 1449 | 1449 | 1449 | 1449 |
| 2020 | 1622 | 1622 | 1622 | 1699 | 1622 | 1622 | 1622 | 1622 | 1622 |
| 2021 | 1808 | 1808 | 1808 | 1889 | 1808 | 1808 | 1808 | 1808 | 1808 |
| 2022 | 1974 | 1974 | 1974 | 2103 | 1974 | 1974 | 1974 | 1974 | 1974 |
| 2023 | 2164 | 2164 | 2164 | 2333 | 2164 | 2164 | 2164 | 2164 | 2164 |
| 2024 | 2363 | 2363 | 2363 | 2591 | 2363 | 2363 | 2363 | 2363 | 2363 |
| 2025 | 2613 | 2613 | 2555 | 2841 | 2613 | 2611 | 2613 | 2613 | 2613 |
| 2026 | 2764 | 2764 | 2738 | 3084 | 2764 | 2762 | 2764 | 2764 | 2764 |
| 2027 | 2945 | 2945 | 2931 | 3338 | 2945 | 2943 | 2945 | 2945 | 2945 |
| 2028 | 3166 | 3159 | 3125 | 3612 | 3163 | 3161 | 3163 | 3163 | 3163 |
| 2029 | 3377 | 3357 | 3297 | 3873 | 3377 | 3366 | 3375 | 3375 | 3375 |
| 2030 | 3599 | 3575 | 3547 | 4116 | 3594 | 3579 | 3590 | 3590 | 3590 |
| 2031 | 3845 | 3824 | 3709 | 4368 | 3836 | 3831 | 3839 | 3839 | 3839 |
| 2032 | 4086 | 4060 | 3868 | 4625 | 4072 | 4070 | 4077 | 4077 | 4077 |
| 2033 | 4311 | 4287 | 4070 | 4882 | 4308 | 4294 | 4301 | 4301 | 4301 |
| 2034 | 4586 | 4564 | 4300 | 5149 | 4578 | 4571 | 4577 | 4577 | 4577 |
| 2035 | 4872 | 4840 | 4509 | 5371 | 4836 | 4847 | 4864 | 4864 | 4864 |
| 2036 | 5104 | 5072 | 4689 | 5579 | 5070 | 5086 | 5096 | 5096 | 5096 |
| 2037 | 5320 | 5293 | 4900 | 5776 | 5290 | 5337 | 5312 | 5312 | 5312 |
| 2038 | 5523 | 5501 | 5161 | 5976 | 5502 | 5586 | 5518 | 5518 | 5518 |
| 2039 | 5736 | 5716 | 5400 | 6198 | 5722 | 5815 | 5730 | 5730 | 5730 |
| 2040 | 5999 | 5979 | 5624 | 6417 | 5989 | 6048 | 5990 | 5990 | 5990 |
| 2041 | 6230 | 6214 | 5889 | 6620 | 6226 | 6276 | 6221 | 6221 | 6221 |
| 2042 | 6466 | 6449 | 6101 | 6840 | 6488 | 6474 | 6463 | 6463 | 6463 |
| 2043 | 6676 | 6652 | 6294 | 7073 | 6693 | 6673 | 6666 | 6666 | 6666 |
| 2044 | 6867 | 6836 | 6522 | 7285 | 6870 | 6896 | 6857 | 6857 | 6857 |
| 2045 | 7049 | 7017 | 6731 | 7622 | 7040 | 7166 | 7047 | 7047 | 7047 |
| 2046 | 7214 | 7183 | 6937 | 7972 | 7223 | 7316 | 7213 | 7213 | 7213 |
| 2047 | 7252 | 7254 | 7157 | 8242 | 7252 | 7671 | 7253 | 7253 | 7253 |
| 2048 | 7632 | 7632 | 7252 | 8439 | 7651 | 8007 | 7626 | 7626 | 7626 |
| 2049 | 7973 | 7974 | 7656 | 8578 | 7993 | 8251 | 7967 | 7967 | 7967 |
| 2050 | 8218 | 8219 | 7934 | 8671 | 8239 | 8408 | 8212 | 8212 | 8212 |
| 2051 | 8408 | 8409 | 8121 | 8745 | 8429 | 8530 | 8402 | 8402 | 8402 |
| 2052 | 8592 | 8593 | 8288 | 8794 | 8613 | 8627 | 8586 | 8586 | 8586 |
| 2053 | 8706 | 8707 | 8390 | 8828 | 8727 | 8674 | 8700 | 8700 | 8700 |
| 2054 | 8754 | 8755 | 8434 | 8854 | 8775 | 8711 | 8748 | 8748 | 8748 |
| 2055 | 8791 | 8792 | 8470 | 8872 | 8812 | 8748 | 8785 | 8785 | 8785 |
| 2056 | 8827 | 8828 | 8506 | 8885 | 8848 | 8774 | 8821 | 8821 | 8821 |
| 2057 | 8866 | 8867 | 8527 | 8897 | 8887 | 8794 | 8860 | 8860 | 8860 |
| 2058 | 8900 | 8901 | 8542 | 8899 | 8921 | 8794 | 8894 | 8894 | 8894 |
| 2059 | 8912 | 8913 | 8544 | 8900 | 8933 | 8794 | 8906 | 8906 | 8906 |

|      | 64   | 65   | 66   | 67   | 68   | 69   | 70   | 71   | 72   |
|------|------|------|------|------|------|------|------|------|------|
| 2060 | 8915 | 8916 | 8544 | 8900 | 8936 | 8794 | 8909 | 8909 | 8909 |
| 2061 | 8916 | 8917 | 8544 | 8900 | 8937 | 8794 | 8910 | 8910 | 8910 |
| 2062 | 8916 | 8917 | 8544 | 8900 | 8937 | 8794 | 8910 | 8910 | 8910 |
| 2063 | 8916 | 8917 | 8544 | 8900 | 8937 | 8794 | 8910 | 8910 | 8910 |
| 2064 | 8916 | 8917 | 8544 | 8900 | 8937 | 8794 | 8910 | 8910 | 8910 |
| 2065 | 8916 | 8917 | 8544 | 8900 | 8937 | 8794 | 8910 | 8910 | 8910 |
| 2066 | 8916 | 8917 | 8544 | 8900 | 8937 | 8794 | 8910 | 8910 | 8910 |
| 2067 | 8916 | 8917 | 8544 | 8900 | 8937 | 8794 | 8910 | 8910 | 8910 |
| 2068 | 8916 | 8917 | 8544 | 8900 | 8937 | 8794 | 8910 | 8910 | 8910 |
| 2069 | 8916 | 8917 | 8544 | 8900 | 8937 | 8794 | 8910 | 8910 | 8910 |
| 2070 | 8916 | 8917 | 8544 | 8900 | 8937 | 8794 | 8910 | 8910 | 8910 |
| 2071 | 8916 | 8917 | 8544 | 8900 | 8937 | 8794 | 8910 | 8910 | 8910 |
| 2072 | 8916 | 8917 | 8544 | 8900 | 8937 | 8794 | 8910 | 8910 | 8910 |
| 2073 | 8916 | 8917 | 8544 | 8900 | 8937 | 8794 | 8910 | 8910 | 8910 |
| 2074 | 8916 | 8917 | 8544 | 8900 | 8937 | 8794 | 8910 | 8910 | 8910 |
| 2075 | 8916 | 8917 | 8544 | 8900 | 8937 | 8794 | 8910 | 8910 | 8910 |
| 2076 | 8916 | 8917 | 8544 | 8900 | 8937 | 8794 | 8910 | 8910 | 8910 |
| 2077 | 8916 | 8917 | 8544 | 8900 | 8937 | 8794 | 8910 | 8910 | 8910 |
| 2078 | 8916 | 8917 | 8544 | 8900 | 8937 | 8794 | 8910 | 8910 | 8910 |
| 2079 | 8916 | 8917 | 8544 | 8900 | 8937 | 8794 | 8910 | 8910 | 8910 |
| 2080 | 8916 | 8917 | 8544 | 8900 | 8937 | 8794 | 8910 | 8910 | 8910 |
| 2081 | 8916 | 8917 | 8544 | 8900 | 8937 | 8794 | 8910 | 8910 | 8910 |
| 2082 | 8916 | 8917 | 8544 | 8900 | 8937 | 8794 | 8910 | 8910 | 8910 |
| 2083 | 8916 | 8917 | 8544 | 8900 | 8937 | 8794 | 8910 | 8910 | 8910 |
| 2084 | 8916 | 8917 | 8544 | 8900 | 8937 | 8794 | 8910 | 8910 | 8910 |
| 2085 | 8916 | 8917 | 8544 | 8900 | 8937 | 8794 | 8910 | 8910 | 8910 |
| 2086 | 8916 | 8917 | 8544 | 8900 | 8937 | 8794 | 8910 | 8910 | 8910 |
| 2087 | 8916 | 8917 | 8544 | 8900 | 8937 | 8794 | 8910 | 8910 | 8910 |
| 2088 | 8916 | 8917 | 8544 | 8900 | 8937 | 8794 | 8910 | 8910 | 8910 |
| 2089 | 8916 | 8917 | 8544 | 8900 | 8937 | 8794 | 8910 | 8910 | 8910 |
| 2090 | 8916 | 8917 | 8544 | 8900 | 8937 | 8794 | 8910 | 8910 | 8910 |
|      |      |      |      |      |      |      |      |      |      |

|      | 73   | 74   | 75   | 76   | 77   | 78   | 79   | 80   | 81   |
|------|------|------|------|------|------|------|------|------|------|
| 2002 | 0    | 0    | 0    | 0    | 0    | 0    | 0    | 0    | 0    |
| 2003 | 0    | 0    | 0    | 0    | 0    | 0    | 0    | 0    | 0    |
| 2004 | 1    | 1    | 1    | 1    | 1    | 1    | 1    | 1    | 1    |
| 2005 | 3    | 3    | 3    | 3    | 3    | 3    | 3    | 3    | 3    |
| 2006 | 14   | 14   | 14   | 14   | 14   | 14   | 14   | 14   | 14   |
| 2007 | 33   | 33   | 33   | 33   | 33   | 33   | 33   | 33   | 33   |
| 2008 | 67   | 67   | 67   | 67   | 67   | 67   | 67   | 67   | 67   |
| 2009 | 128  | 128  | 128  | 128  | 128  | 128  | 128  | 128  | 128  |
| 2010 | 210  | 210  | 210  | 210  | 210  | 210  | 210  | 210  | 210  |
| 2011 | 313  | 313  | 313  | 313  | 313  | 313  | 313  | 313  | 313  |
| 2012 | 418  | 418  | 418  | 418  | 418  | 418  | 418  | 418  | 418  |
| 2013 | 547  | 547  | 547  | 547  | 547  | 547  | 547  | 547  | 547  |
| 2014 | 665  | 665  | 665  | 665  | 665  | 665  | 665  | 665  | 665  |
| 2015 | 814  | 814  | 814  | 814  | 814  | 814  | 814  | 814  | 814  |
| 2016 | 957  | 957  | 957  | 957  | 957  | 957  | 957  | 957  | 957  |
| 2017 | 1109 | 1109 | 1109 | 1109 | 1109 | 1109 | 1109 | 1109 | 1109 |
| 2018 | 1276 | 1276 | 1276 | 1276 | 1276 | 1276 | 1276 | 1276 | 1276 |
| 2019 | 1449 | 1449 | 1449 | 1449 | 1449 | 1449 | 1449 | 1449 | 1449 |
| 2020 | 1622 | 1622 | 1622 | 1699 | 1622 | 1622 | 1622 | 1622 | 1622 |
| 2021 | 1808 | 1808 | 1808 | 1889 | 1808 | 1808 | 1808 | 1808 | 1808 |
| 2022 | 1974 | 1974 | 1974 | 2103 | 1974 | 1974 | 1974 | 1974 | 1974 |
| 2023 | 2164 | 2164 | 2164 | 2333 | 2164 | 2164 | 2164 | 2164 | 2164 |
| 2024 | 2363 | 2363 | 2363 | 2591 | 2363 | 2363 | 2363 | 2363 | 2363 |
| 2025 | 2613 | 2613 | 2555 | 2841 | 2613 | 2613 | 2613 | 2613 | 2613 |
| 2026 | 2764 | 2764 | 2738 | 3084 | 2773 | 2764 | 2764 | 2764 | 2764 |
| 2027 | 2945 | 2945 | 2931 | 3332 | 2954 | 2945 | 2945 | 2945 | 2945 |
| 2028 | 3166 | 3159 | 3125 | 3606 | 3172 | 3163 | 3163 | 3163 | 3163 |
| 2029 | 3377 | 3357 | 3297 | 3867 | 3376 | 3368 | 3375 | 3375 | 3375 |
| 2030 | 3599 | 3575 | 3547 | 4121 | 3589 | 3580 | 3590 | 3590 | 3590 |
| 2031 | 3845 | 3824 | 3709 | 4382 | 3831 | 3832 | 3839 | 3839 | 3839 |
| 2032 | 4088 | 4062 | 3868 | 4652 | 4073 | 4071 | 4079 | 4079 | 4079 |
| 2033 | 4326 | 4294 | 4070 | 4902 | 4314 | 4295 | 4317 | 4317 | 4317 |
| 2034 | 4603 | 4571 | 4300 | 5178 | 4581 | 4572 | 4594 | 4594 | 4594 |
| 2035 | 4872 | 4837 | 4509 | 5421 | 4843 | 4849 | 4860 | 4860 | 4860 |
| 2036 | 5117 | 5083 | 4689 | 5659 | 5083 | 5088 | 5104 | 5104 | 5104 |
| 2037 | 5367 | 5333 | 4900 | 5902 | 5318 | 5323 | 5354 | 5354 | 5354 |
| 2038 | 5597 | 5563 | 5162 | 6125 | 5538 | 5556 | 5584 | 5584 | 5584 |
| 2039 | 5835 | 5806 | 5401 | 6385 | 5771 | 5810 | 5818 | 5818 | 5818 |
| 2040 | 6100 | 6081 | 5625 | 6635 | 6056 | 6085 | 6086 | 6086 | 6086 |
| 2041 | 6344 | 6334 | 5891 | 6940 | 6310 | 6353 | 6332 | 6332 | 6332 |
| 2042 | 6623 | 6614 | 6113 | 7230 | 6593 | 6600 | 6610 | 6610 | 6610 |
| 2043 | 6860 | 6855 | 6323 | 7346 | 6830 | 6823 | 6848 | 6848 | 6848 |
| 2044 | 7093 | 7095 | 6587 | 7688 | 7068 | 7080 | 7081 | 7081 | 7081 |
| 2045 | 7269 | 7254 | 6816 | 8026 | 7265 | 7304 | 7276 | 7276 | 7276 |
| 2046 | 7641 | 7626 | 7054 | 8318 | 7637 | 7652 | 7649 | 7649 | 7649 |
| 2047 | 7973 | 7958 | 7250 | 8528 | 7969 | 7974 | 7981 | 7981 | 7981 |
| 2048 | 8229 | 8214 | 7646 | 8682 | 8223 | 8235 | 8236 | 8236 | 8236 |
| 2049 | 8419 | 8404 | 7924 | 8761 | 8413 | 8403 | 8426 | 8426 | 8426 |
| 2050 | 8596 | 8584 | 8111 | 8836 | 8597 | 8550 | 8606 | 8606 | 8606 |
| 2051 | 8709 | 8697 | 8278 | 8895 | 8711 | 8653 | 8720 | 8720 | 8720 |
| 2052 | 8757 | 8745 | 8380 | 8943 | 8759 | 8701 | 8768 | 8768 | 8768 |
| 2053 | 8794 | 8782 | 8424 | 8971 | 8796 | 8738 | 8805 | 8805 | 8805 |
| 2054 | 8830 | 8818 | 8460 | 8996 | 8832 | 8777 | 8841 | 8841 | 8841 |
| 2055 | 8869 | 8857 | 8496 | 9010 | 8871 | 8800 | 8880 | 8880 | 8880 |
| 2056 | 8903 | 8891 | 8517 | 9022 | 8905 | 8806 | 8914 | 8914 | 8914 |
| 2057 | 8915 | 8903 | 8532 | 9024 | 8917 | 8806 | 8926 | 8926 | 8926 |
| 2058 | 8918 | 8906 | 8534 | 9024 | 8920 | 8806 | 8929 | 8929 | 8929 |
| 2059 | 8919 | 8907 | 8534 | 9024 | 8921 | 8806 | 8930 | 8930 | 8930 |

|      | 73   | 74   | 75   | 76   | 77   | 78   | 79   | 80   | 81   |
|------|------|------|------|------|------|------|------|------|------|
| 2060 | 8919 | 8907 | 8534 | 9024 | 8921 | 8806 | 8930 | 8930 | 8930 |
| 2061 | 8919 | 8907 | 8534 | 9024 | 8921 | 8806 | 8930 | 8930 | 8930 |
| 2062 | 8919 | 8907 | 8534 | 9024 | 8921 | 8806 | 8930 | 8930 | 8930 |
| 2063 | 8919 | 8907 | 8534 | 9024 | 8921 | 8806 | 8930 | 8930 | 8930 |
| 2064 | 8919 | 8907 | 8534 | 9024 | 8921 | 8806 | 8930 | 8930 | 8930 |
| 2065 | 8919 | 8907 | 8534 | 9024 | 8921 | 8806 | 8930 | 8930 | 8930 |
| 2066 | 8919 | 8907 | 8534 | 9024 | 8921 | 8806 | 8930 | 8930 | 8930 |
| 2067 | 8919 | 8907 | 8534 | 9024 | 8921 | 8806 | 8930 | 8930 | 8930 |
| 2068 | 8919 | 8907 | 8534 | 9024 | 8921 | 8806 | 8930 | 8930 | 8930 |
| 2069 | 8919 | 8907 | 8534 | 9024 | 8921 | 8806 | 8930 | 8930 | 8930 |
| 2070 | 8919 | 8907 | 8534 | 9024 | 8921 | 8806 | 8930 | 8930 | 8930 |
| 2071 | 8919 | 8907 | 8534 | 9024 | 8921 | 8806 | 8930 | 8930 | 8930 |
| 2072 | 8919 | 8907 | 8534 | 9024 | 8921 | 8806 | 8930 | 8930 | 8930 |
| 2073 | 8919 | 8907 | 8534 | 9024 | 8921 | 8806 | 8930 | 8930 | 8930 |
| 2074 | 8919 | 8907 | 8534 | 9024 | 8921 | 8806 | 8930 | 8930 | 8930 |
| 2075 | 8919 | 8907 | 8534 | 9024 | 8921 | 8806 | 8930 | 8930 | 8930 |
| 2076 | 8919 | 8907 | 8534 | 9024 | 8921 | 8806 | 8930 | 8930 | 8930 |
| 2077 | 8919 | 8907 | 8534 | 9024 | 8921 | 8806 | 8930 | 8930 | 8930 |
| 2078 | 8919 | 8907 | 8534 | 9024 | 8921 | 8806 | 8930 | 8930 | 8930 |
| 2079 | 8919 | 8907 | 8534 | 9024 | 8921 | 8806 | 8930 | 8930 | 8930 |
| 2080 | 8919 | 8907 | 8534 | 9024 | 8921 | 8806 | 8930 | 8930 | 8930 |
| 2081 | 8919 | 8907 | 8534 | 9024 | 8921 | 8806 | 8930 | 8930 | 8930 |
| 2082 | 8919 | 8907 | 8534 | 9024 | 8921 | 8806 | 8930 | 8930 | 8930 |
| 2083 | 8919 | 8907 | 8534 | 9024 | 8921 | 8806 | 8930 | 8930 | 8930 |
| 2084 | 8919 | 8907 | 8534 | 9024 | 8921 | 8806 | 8930 | 8930 | 8930 |
| 2085 | 8919 | 8907 | 8534 | 9024 | 8921 | 8806 | 8930 | 8930 | 8930 |
| 2086 | 8919 | 8907 | 8534 | 9024 | 8921 | 8806 | 8930 | 8930 | 8930 |
| 2087 | 8919 | 8907 | 8534 | 9024 | 8921 | 8806 | 8930 | 8930 | 8930 |
| 2088 | 8919 | 8907 | 8534 | 9024 | 8921 | 8806 | 8930 | 8930 | 8930 |
| 2089 | 8919 | 8907 | 8534 | 9024 | 8921 | 8806 | 8930 | 8930 | 8930 |
| 2090 | 8919 | 8907 | 8534 | 9024 | 8921 | 8806 | 8930 | 8930 | 8930 |
|      |      |      |      |      |      |      |      |      |      |

|      | 82   | 83   | 84   | 85   | 86   | 87   | 88   | 89   | 90   |
|------|------|------|------|------|------|------|------|------|------|
| 2002 | 0    | 0    | 0    | 0    | 0    | 0    | 0    | 0    | 0    |
| 2003 | 0    | 0    | 0    | 0    | 0    | 0    | 0    | 0    | 0    |
| 2004 | 1    | 1    | 1    | 1    | 1    | 1    | 1    | 1    | 1    |
| 2005 | 3    | 3    | 3    | 3    | 3    | 3    | 3    | 3    | 3    |
| 2006 | 14   | 14   | 14   | 14   | 14   | 14   | 14   | 14   | 14   |
| 2007 | 33   | 33   | 33   | 33   | 33   | 33   | 33   | 33   | 33   |
| 2008 | 67   | 67   | 67   | 67   | 67   | 67   | 67   | 67   | 67   |
| 2009 | 128  | 128  | 128  | 128  | 128  | 128  | 128  | 128  | 128  |
| 2010 | 210  | 210  | 210  | 210  | 210  | 210  | 210  | 210  | 210  |
| 2011 | 313  | 313  | 313  | 313  | 313  | 313  | 313  | 313  | 313  |
| 2012 | 418  | 418  | 418  | 418  | 418  | 418  | 418  | 418  | 418  |
| 2013 | 547  | 547  | 547  | 547  | 547  | 547  | 547  | 547  | 547  |
| 2014 | 665  | 665  | 665  | 665  | 665  | 665  | 665  | 665  | 665  |
| 2015 | 814  | 814  | 814  | 814  | 814  | 814  | 814  | 814  | 814  |
| 2016 | 957  | 957  | 957  | 957  | 957  | 957  | 957  | 957  | 957  |
| 2017 | 1109 | 1109 | 1109 | 1109 | 1109 | 1109 | 1109 | 1109 | 1109 |
| 2018 | 1276 | 1276 | 1276 | 1276 | 1276 | 1276 | 1276 | 1276 | 1276 |
| 2019 | 1449 | 1449 | 1449 | 1449 | 1449 | 1449 | 1449 | 1449 | 1449 |
| 2020 | 1622 | 1622 | 1622 | 1703 | 1622 | 1622 | 1622 | 1622 | 1622 |
| 2021 | 1808 | 1808 | 1808 | 1877 | 1808 | 1808 | 1808 | 1808 | 1808 |
| 2022 | 1974 | 1974 | 1974 | 2085 | 1974 | 1974 | 1974 | 1974 | 1974 |
| 2023 | 2164 | 2164 | 2164 | 2308 | 2164 | 2164 | 2164 | 2164 | 2164 |
| 2024 | 2363 | 2363 | 2363 | 2529 | 2363 | 2363 | 2363 | 2363 | 2363 |
| 2025 | 2619 | 2619 | 2555 | 2768 | 2619 | 2619 | 2619 | 2619 | 2619 |
| 2026 | 2779 | 2779 | 2738 | 3029 | 2779 | 2779 | 2779 | 2779 | 2779 |
| 2027 | 2978 | 2978 | 2931 | 3268 | 2978 | 2978 | 2978 | 2978 | 2978 |
| 2028 | 3161 | 3161 | 3125 | 3492 | 3161 | 3161 | 3161 | 3161 | 3161 |
| 2029 | 3346 | 3346 | 3297 | 3730 | 3346 | 3346 | 3346 | 3346 | 3346 |
| 2030 | 3553 | 3553 | 3553 | 4008 | 3553 | 3553 | 3553 | 3553 | 3553 |
| 2031 | 3775 | 3775 | 3722 | 4276 | 3775 | 3775 | 3775 | 3775 | 3775 |
| 2032 | 3960 | 3960 | 3882 | 4521 | 3960 | 3960 | 3960 | 3960 | 3960 |
| 2033 | 4154 | 4154 | 4087 | 4821 | 4154 | 4154 | 4154 | 4154 | 4154 |
| 2034 | 4380 | 4380 | 4287 | 5142 | 4380 | 4380 | 4380 | 4380 | 4380 |
| 2035 | 4615 | 4615 | 4511 | 5422 | 4615 | 4615 | 4615 | 4615 | 4615 |
| 2036 | 4887 | 4887 | 4711 | 5791 | 4887 | 4895 | 4887 | 4887 | 4887 |
| 2037 | 5142 | 5142 | 4900 | 6068 | 5142 | 5159 | 5142 | 5142 | 5142 |
| 2038 | 5418 | 5418 | 5065 | 6324 | 5418 | 5451 | 5418 | 5418 | 5418 |
| 2039 | 5710 | 5710 | 5259 | 6642 | 5716 | 5703 | 5710 | 5710 | 5710 |
| 2040 | 6012 | 6012 | 5458 | 6935 | 6017 | 6002 | 6012 | 6012 | 6012 |
| 2041 | 6357 | 6357 | 5683 | 7185 | 6323 | 6298 | 6357 | 6357 | 6357 |
| 2042 | 6614 | 6614 | 5926 | 7353 | 6640 | 6616 | 6614 | 6614 | 6614 |
| 2043 | 6943 | 6943 | 6179 | 7998 | 6944 | 6940 | 6943 | 6943 | 6943 |
| 2044 | 7284 | 7284 | 6436 | 8383 | 7289 | 7263 | 7284 | 7284 | 7284 |
| 2045 | 7949 | 7949 | 6750 | 8604 | 7977 | 7945 | 7949 | 7949 | 7949 |
| 2046 | 8341 | 8341 | 6998 | 8687 | 8379 | 8346 | 8341 | 8341 | 8341 |
| 2047 | 8534 | 8534 | 7256 | 8728 | 8573 | 8537 | 8534 | 8534 | 8534 |
| 2048 | 8654 | 8654 | 8027 | 8784 | 8693 | 8656 | 8654 | 8654 | 8654 |
| 2049 | 8693 | 8693 | 8378 | 8793 | 8732 | 8695 | 8693 | 8693 | 8693 |
| 2050 | 8704 | 8704 | 8512 | 8802 | 8743 | 8707 | 8704 | 8704 | 8704 |
| 2051 | 8719 | 8719 | 8611 | 8817 | 8758 | 8723 | 8719 | 8719 | 8719 |
| 2052 | 8724 | 8724 | 8629 | 8822 | 8763 | 8728 | 8724 | 8724 | 8724 |
| 2053 | 8724 | 8724 | 8632 | 8822 | 8763 | 8728 | 8724 | 8724 | 8724 |
| 2054 | 8737 | 8737 | 8645 | 8835 | 8776 | 8741 | 8737 | 8737 | 8737 |
| 2055 | 8739 | 8739 | 8647 | 8837 | 8778 | 8743 | 8739 | 8739 | 8739 |
| 2056 | 8749 | 8749 | 8657 | 8847 | 8788 | 8753 | 8749 | 8749 | 8749 |
| 2057 | 8749 | 8749 | 8657 | 8847 | 8788 | 8753 | 8749 | 8749 | 8749 |
| 2058 | 8749 | 8749 | 8657 | 8847 | 8788 | 8753 | 8749 | 8749 | 8749 |
| 2059 | 8749 | 8749 | 8657 | 8847 | 8788 | 8753 | 8749 | 8749 | 8749 |

|      | 82   | 83   | 84   | 85   | 86   | 87   | 88   | 89   | 90   |
|------|------|------|------|------|------|------|------|------|------|
| 2060 | 8749 | 8749 | 8657 | 8847 | 8788 | 8753 | 8749 | 8749 | 8749 |
| 2061 | 8749 | 8749 | 8657 | 8847 | 8788 | 8753 | 8749 | 8749 | 8749 |
| 2062 | 8749 | 8749 | 8657 | 8847 | 8788 | 8753 | 8749 | 8749 | 8749 |
| 2063 | 8749 | 8749 | 8657 | 8847 | 8788 | 8753 | 8749 | 8749 | 8749 |
| 2064 | 8749 | 8749 | 8657 | 8847 | 8788 | 8753 | 8749 | 8749 | 8749 |
| 2065 | 8749 | 8749 | 8657 | 8847 | 8788 | 8753 | 8749 | 8749 | 8749 |
| 2066 | 8749 | 8749 | 8657 | 8847 | 8788 | 8753 | 8749 | 8749 | 8749 |
| 2067 | 8749 | 8749 | 8657 | 8847 | 8788 | 8753 | 8749 | 8749 | 8749 |
| 2068 | 8749 | 8749 | 8657 | 8847 | 8788 | 8753 | 8749 | 8749 | 8749 |
| 2069 | 8749 | 8749 | 8657 | 8847 | 8788 | 8753 | 8749 | 8749 | 8749 |
| 2070 | 8749 | 8749 | 8657 | 8847 | 8788 | 8753 | 8749 | 8749 | 8749 |
| 2071 | 8749 | 8749 | 8657 | 8847 | 8788 | 8753 | 8749 | 8749 | 8749 |
| 2072 | 8749 | 8749 | 8657 | 8847 | 8788 | 8753 | 8749 | 8749 | 8749 |
| 2073 | 8749 | 8749 | 8657 | 8847 | 8788 | 8753 | 8749 | 8749 | 8749 |
| 2074 | 8749 | 8749 | 8657 | 8847 | 8788 | 8753 | 8749 | 8749 | 8749 |
| 2075 | 8749 | 8749 | 8657 | 8847 | 8788 | 8753 | 8749 | 8749 | 8749 |
| 2076 | 8749 | 8749 | 8657 | 8847 | 8788 | 8753 | 8749 | 8749 | 8749 |
| 2077 | 8749 | 8749 | 8657 | 8847 | 8788 | 8753 | 8749 | 8749 | 8749 |
| 2078 | 8749 | 8749 | 8657 | 8847 | 8788 | 8753 | 8749 | 8749 | 8749 |
| 2079 | 8749 | 8749 | 8657 | 8847 | 8788 | 8753 | 8749 | 8749 | 8749 |
| 2080 | 8749 | 8749 | 8657 | 8847 | 8788 | 8753 | 8749 | 8749 | 8749 |
| 2081 | 8749 | 8749 | 8657 | 8847 | 8788 | 8753 | 8749 | 8749 | 8749 |
| 2082 | 8749 | 8749 | 8657 | 8847 | 8788 | 8753 | 8749 | 8749 | 8749 |
| 2083 | 8749 | 8749 | 8657 | 8847 | 8788 | 8753 | 8749 | 8749 | 8749 |
| 2084 | 8749 | 8749 | 8657 | 8847 | 8788 | 8753 | 8749 | 8749 | 8749 |
| 2085 | 8749 | 8749 | 8657 | 8847 | 8788 | 8753 | 8749 | 8749 | 8749 |
| 2086 | 8749 | 8749 | 8657 | 8847 | 8788 | 8753 | 8749 | 8749 | 8749 |
| 2087 | 8749 | 8749 | 8657 | 8847 | 8788 | 8753 | 8749 | 8749 | 8749 |
| 2088 | 8749 | 8749 | 8657 | 8847 | 8788 | 8753 | 8749 | 8749 | 8749 |
| 2089 | 8749 | 8749 | 8657 | 8847 | 8788 | 8753 | 8749 | 8749 | 8749 |
| 2090 | 8749 | 8749 | 8657 | 8847 | 8788 | 8753 | 8749 | 8749 | 8749 |
|      |      |      |      |      |      |      |      |      |      |

|      | 91   | 92   | 93   | 94   | 95   | 96   | 97   | 98   | 99   |
|------|------|------|------|------|------|------|------|------|------|
| 2002 | 0    | 0    | 0    | 0    | 0    | 0    | 0    | 0    | 0    |
| 2003 | 0    | 0    | 0    | 0    | 0    | 0    | 0    | 0    | 0    |
| 2004 | 1    | 1    | 1    | 1    | 1    | 1    | 1    | 1    | 1    |
| 2005 | 3    | 3    | 3    | 3    | 3    | 3    | 3    | 3    | 3    |
| 2006 | 14   | 14   | 14   | 14   | 14   | 14   | 14   | 14   | 14   |
| 2007 | 33   | 33   | 33   | 33   | 33   | 33   | 33   | 33   | 33   |
| 2008 | 67   | 67   | 67   | 67   | 67   | 67   | 67   | 67   | 67   |
| 2009 | 128  | 128  | 128  | 128  | 128  | 128  | 128  | 128  | 128  |
| 2010 | 210  | 210  | 210  | 210  | 210  | 210  | 210  | 210  | 210  |
| 2011 | 313  | 313  | 313  | 313  | 313  | 313  | 313  | 313  | 313  |
| 2012 | 418  | 418  | 418  | 418  | 418  | 418  | 418  | 418  | 418  |
| 2013 | 547  | 547  | 547  | 547  | 547  | 547  | 547  | 547  | 547  |
| 2014 | 665  | 665  | 665  | 665  | 665  | 665  | 665  | 665  | 665  |
| 2015 | 814  | 814  | 814  | 814  | 814  | 814  | 814  | 814  | 814  |
| 2016 | 957  | 957  | 957  | 957  | 957  | 957  | 957  | 957  | 957  |
| 2017 | 1109 | 1109 | 1109 | 1109 | 1109 | 1109 | 1109 | 1109 | 1109 |
| 2018 | 1276 | 1276 | 1276 | 1276 | 1276 | 1276 | 1276 | 1276 | 1276 |
| 2019 | 1449 | 1449 | 1449 | 1449 | 1449 | 1449 | 1449 | 1449 | 1449 |
| 2020 | 1622 | 1622 | 1622 | 1699 | 1622 | 1622 | 1622 | 1622 | 1622 |
| 2021 | 1808 | 1808 | 1808 | 1889 | 1808 | 1808 | 1808 | 1808 | 1808 |
| 2022 | 1974 | 1974 | 1974 | 2092 | 1974 | 1974 | 1974 | 1974 | 1974 |
| 2023 | 2164 | 2164 | 2164 | 2304 | 2164 | 2164 | 2164 | 2164 | 2164 |
| 2024 | 2363 | 2363 | 2363 | 2555 | 2363 | 2363 | 2363 | 2363 | 2363 |
| 2025 | 2613 | 2613 | 2555 | 2801 | 2613 | 2611 | 2613 | 2613 | 2613 |
| 2026 | 2764 | 2764 | 2738 | 3044 | 2764 | 2762 | 2764 | 2764 | 2764 |
| 2027 | 2945 | 2945 | 2931 | 3296 | 2945 | 2943 | 2945 | 2945 | 2945 |
| 2028 | 3159 | 3159 | 3125 | 3570 | 3161 | 3156 | 3159 | 3159 | 3159 |
| 2029 | 3357 | 3357 | 3297 | 3828 | 3359 | 3349 | 3357 | 3357 | 3357 |
| 2030 | 3572 | 3572 | 3547 | 4071 | 3576 | 3565 | 3572 | 3572 | 3572 |
| 2031 | 3814 | 3814 | 3709 | 4323 | 3811 | 3810 | 3814 | 3814 | 3814 |
| 2032 | 4045 | 4045 | 3868 | 4573 | 4042 | 4046 | 4045 | 4045 | 4045 |
| 2033 | 4274 | 4274 | 4070 | 4830 | 4274 | 4263 | 4274 | 4274 | 4274 |
| 2034 | 4551 | 4551 | 4298 | 5122 | 4541 | 4537 | 4551 | 4551 | 4551 |
| 2035 | 4817 | 4817 | 4498 | 5343 | 4802 | 4817 | 4817 | 4817 | 4817 |
| 2036 | 5049 | 5049 | 4677 | 5541 | 5032 | 5056 | 5049 | 5049 | 5049 |
| 2037 | 5271 | 5271 | 4879 | 5733 | 5258 | 5298 | 5271 | 5271 | 5271 |
| 2038 | 5482 | 5482 | 5133 | 5926 | 5473 | 5520 | 5482 | 5482 | 5482 |
| 2039 | 5686 | 5686 | 5370 | 6108 | 5694 | 5744 | 5686 | 5686 | 5686 |
| 2040 | 5936 | 5936 | 5588 | 6299 | 5951 | 5988 | 5936 | 5936 | 5936 |
| 2041 | 6175 | 6175 | 5840 | 6481 | 6202 | 6214 | 6175 | 6175 | 6175 |
| 2042 | 6413 | 6413 | 6041 | 6682 | 6440 | 6420 | 6413 | 6413 | 6413 |
| 2043 | 6623 | 6623 | 6244 | 6834 | 6662 | 6615 | 6623 | 6623 | 6623 |
| 2044 | 6791 | 6791 | 6449 | 6999 | 6840 | 6824 | 6791 | 6791 | 6791 |
| 2045 | 6955 | 6955 | 6652 | 7176 | 7006 | 7068 | 6955 | 6955 | 6955 |
| 2046 | 7099 | 7099 | 6854 | 7301 | 7191 | 7277 | 7099 | 7099 | 7099 |
| 2047 | 7254 | 7254 | 7074 | 7673 | 7252 | 7653 | 7254 | 7254 | 7254 |
| 2048 | 7651 | 7651 | 7250 | 8039 | 7649 | 7992 | 7651 | 7651 | 7651 |
| 2049 | 7993 | 7993 | 7654 | 8332 | 7991 | 8236 | 7993 | 7993 | 7993 |
| 2050 | 8239 | 8239 | 7932 | 8572 | 8237 | 8398 | 8239 | 8239 | 8239 |
| 2051 | 8429 | 8429 | 8119 | 8746 | 8427 | 8535 | 8429 | 8429 | 8429 |
| 2052 | 8613 | 8613 | 8286 | 8864 | 8611 | 8634 | 8613 | 8613 | 8613 |
| 2053 | 8727 | 8727 | 8388 | 8968 | 8725 | 8678 | 8727 | 8727 | 8727 |
| 2054 | 8775 | 8775 | 8432 | 9040 | 8773 | 8715 | 8775 | 8775 | 8775 |
| 2055 | 8812 | 8812 | 8468 | 9088 | 8810 | 8752 | 8812 | 8812 | 8812 |
| 2056 | 8848 | 8848 | 8504 | 9126 | 8846 | 8785 | 8848 | 8848 | 8848 |
| 2057 | 8887 | 8887 | 8525 | 9162 | 8885 | 8807 | 8887 | 8887 | 8887 |
| 2058 | 8921 | 8921 | 8540 | 9199 | 8919 | 8819 | 8921 | 8921 | 8921 |
| 2059 | 8933 | 8933 | 8542 | 9226 | 8931 | 8822 | 8933 | 8933 | 8933 |

|      | 91   | 92   | 93   | 94   | 95   | 96   | 97   | 98   | 99   |
|------|------|------|------|------|------|------|------|------|------|
| 2060 | 8936 | 8936 | 8542 | 9229 | 8934 | 8823 | 8936 | 8936 | 8936 |
| 2061 | 8937 | 8937 | 8542 | 9230 | 8935 | 8823 | 8937 | 8937 | 8937 |
| 2062 | 8937 | 8937 | 8542 | 9230 | 8935 | 8823 | 8937 | 8937 | 8937 |
| 2063 | 8937 | 8937 | 8542 | 9230 | 8935 | 8823 | 8937 | 8937 | 8937 |
| 2064 | 8937 | 8937 | 8542 | 9230 | 8935 | 8823 | 8937 | 8937 | 8937 |
| 2065 | 8937 | 8937 | 8542 | 9230 | 8935 | 8823 | 8937 | 8937 | 8937 |
| 2066 | 8937 | 8937 | 8542 | 9230 | 8935 | 8823 | 8937 | 8937 | 8937 |
| 2067 | 8937 | 8937 | 8542 | 9230 | 8935 | 8823 | 8937 | 8937 | 8937 |
| 2068 | 8937 | 8937 | 8542 | 9230 | 8935 | 8823 | 8937 | 8937 | 8937 |
| 2069 | 8937 | 8937 | 8542 | 9230 | 8935 | 8823 | 8937 | 8937 | 8937 |
| 2070 | 8937 | 8937 | 8542 | 9230 | 8935 | 8823 | 8937 | 8937 | 8937 |
| 2071 | 8937 | 8937 | 8542 | 9230 | 8935 | 8823 | 8937 | 8937 | 8937 |
| 2072 | 8937 | 8937 | 8542 | 9230 | 8935 | 8823 | 8937 | 8937 | 8937 |
| 2073 | 8937 | 8937 | 8542 | 9230 | 8935 | 8823 | 8937 | 8937 | 8937 |
| 2074 | 8937 | 8937 | 8542 | 9230 | 8935 | 8823 | 8937 | 8937 | 8937 |
| 2075 | 8937 | 8937 | 8542 | 9230 | 8935 | 8823 | 8937 | 8937 | 8937 |
| 2076 | 8937 | 8937 | 8542 | 9230 | 8935 | 8823 | 8937 | 8937 | 8937 |
| 2077 | 8937 | 8937 | 8542 | 9230 | 8935 | 8823 | 8937 | 8937 | 8937 |
| 2078 | 8937 | 8937 | 8542 | 9230 | 8935 | 8823 | 8937 | 8937 | 8937 |
| 2079 | 8937 | 8937 | 8542 | 9230 | 8935 | 8823 | 8937 | 8937 | 8937 |
| 2080 | 8937 | 8937 | 8542 | 9230 | 8935 | 8823 | 8937 | 8937 | 8937 |
| 2081 | 8937 | 8937 | 8542 | 9230 | 8935 | 8823 | 8937 | 8937 | 8937 |
| 2082 | 8937 | 8937 | 8542 | 9230 | 8935 | 8823 | 8937 | 8937 | 8937 |
| 2083 | 8937 | 8937 | 8542 | 9230 | 8935 | 8823 | 8937 | 8937 | 8937 |
| 2084 | 8937 | 8937 | 8542 | 9230 | 8935 | 8823 | 8937 | 8937 | 8937 |
| 2085 | 8937 | 8937 | 8542 | 9230 | 8935 | 8823 | 8937 | 8937 | 8937 |
| 2086 | 8937 | 8937 | 8542 | 9230 | 8935 | 8823 | 8937 | 8937 | 8937 |
| 2087 | 8937 | 8937 | 8542 | 9230 | 8935 | 8823 | 8937 | 8937 | 8937 |
| 2088 | 8937 | 8937 | 8542 | 9230 | 8935 | 8823 | 8937 | 8937 | 8937 |
| 2089 | 8937 | 8937 | 8542 | 9230 | 8935 | 8823 | 8937 | 8937 | 8937 |
| 2090 | 8937 | 8937 | 8542 | 9230 | 8935 | 8823 | 8937 | 8937 | 8937 |
|      |      |      |      |      |      |      |      |      |      |



|      | 100  | 101  | 102  | 103  | 104  | 105  | 106  | 107  | 108  |
|------|------|------|------|------|------|------|------|------|------|
| 2002 | 0    | 0    | 0    | 0    | 0    | 0    | 0    | 0    | 0    |
| 2003 | 0    | 0    | 0    | 0    | 0    | 0    | 0    | 0    | 0    |
| 2004 | 1    | 1    | 1    | 1    | 1    | 1    | 1    | 1    | 1    |
| 2005 | 3    | 3    | 3    | 3    | 3    | 3    | 3    | 3    | 3    |
| 2006 | 14   | 14   | 14   | 14   | 14   | 14   | 14   | 14   | 14   |
| 2007 | 33   | 33   | 33   | 33   | 33   | 33   | 33   | 33   | 33   |
| 2008 | 67   | 67   | 67   | 67   | 67   | 67   | 67   | 67   | 67   |
| 2009 | 128  | 128  | 128  | 128  | 128  | 128  | 128  | 128  | 128  |
| 2010 | 210  | 210  | 210  | 210  | 210  | 210  | 210  | 210  | 210  |
| 2011 | 313  | 313  | 313  | 313  | 313  | 313  | 313  | 313  | 313  |
| 2012 | 418  | 418  | 418  | 418  | 418  | 418  | 418  | 418  | 418  |
| 2013 | 547  | 547  | 547  | 547  | 547  | 547  | 547  | 547  | 547  |
| 2014 | 665  | 665  | 665  | 665  | 665  | 665  | 665  | 665  | 665  |
| 2015 | 814  | 814  | 814  | 814  | 814  | 814  | 814  | 814  | 814  |
| 2016 | 957  | 957  | 957  | 957  | 957  | 957  | 957  | 957  | 957  |
| 2017 | 1109 | 1109 | 1109 | 1109 | 1109 | 1109 | 1109 | 1109 | 1109 |
| 2018 | 1276 | 1276 | 1276 | 1276 | 1276 | 1276 | 1276 | 1276 | 1276 |
| 2019 | 1449 | 1449 | 1449 | 1449 | 1449 | 1449 | 1449 | 1449 | 1449 |
| 2020 | 1622 | 1622 | 1622 | 1699 | 1622 | 1622 | 1622 | 1622 | 1622 |
| 2021 | 1808 | 1808 | 1808 | 1889 | 1808 | 1808 | 1808 | 1808 | 1808 |
| 2022 | 1974 | 1974 | 1974 | 2092 | 1974 | 1974 | 1974 | 1974 | 1974 |
| 2023 | 2164 | 2164 | 2164 | 2304 | 2164 | 2164 | 2164 | 2164 | 2164 |
| 2024 | 2363 | 2363 | 2363 | 2555 | 2363 | 2363 | 2363 | 2363 | 2363 |
| 2025 | 2613 | 2613 | 2555 | 2801 | 2613 | 2613 | 2613 | 2613 | 2613 |
| 2026 | 2764 | 2764 | 2738 | 3044 | 2773 | 2764 | 2764 | 2764 | 2764 |
| 2027 | 2945 | 2945 | 2931 | 3288 | 2954 | 2945 | 2945 | 2945 | 2945 |
| 2028 | 3159 | 3159 | 3125 | 3562 | 3170 | 3158 | 3159 | 3159 | 3159 |
| 2029 | 3357 | 3357 | 3297 | 3827 | 3358 | 3354 | 3357 | 3357 | 3357 |
| 2030 | 3572 | 3572 | 3547 | 4074 | 3571 | 3568 | 3572 | 3572 | 3572 |
| 2031 | 3814 | 3814 | 3709 | 4336 | 3806 | 3813 | 3814 | 3814 | 3814 |
| 2032 | 4047 | 4047 | 3868 | 4606 | 4045 | 4046 | 4047 | 4047 | 4047 |
| 2033 | 4281 | 4281 | 4070 | 4856 | 4279 | 4263 | 4281 | 4281 | 4281 |
| 2034 | 4558 | 4558 | 4298 | 5111 | 4547 | 4540 | 4558 | 4558 | 4558 |
| 2035 | 4825 | 4825 | 4498 | 5352 | 4809 | 4810 | 4825 | 4825 | 4825 |
| 2036 | 5064 | 5064 | 4677 | 5614 | 5050 | 5049 | 5064 | 5064 | 5064 |
| 2037 | 5314 | 5314 | 4879 | 5847 | 5287 | 5284 | 5314 | 5314 | 5314 |
| 2038 | 5544 | 5544 | 5133 | 6058 | 5506 | 5512 | 5544 | 5544 | 5544 |
| 2039 | 5777 | 5777 | 5370 | 6294 | 5739 | 5747 | 5777 | 5777 | 5777 |
| 2040 | 6053 | 6053 | 5588 | 6534 | 6019 | 6028 | 6053 | 6053 | 6053 |
| 2041 | 6312 | 6312 | 5846 | 6803 | 6282 | 6295 | 6312 | 6312 | 6312 |
| 2042 | 6590 | 6590 | 6060 | 7101 | 6566 | 6563 | 6590 | 6590 | 6590 |
| 2043 | 6821 | 6821 | 6272 | 7304 | 6795 | 6791 | 6821 | 6821 | 6821 |
| 2044 | 7062 | 7062 | 6510 | 7653 | 7032 | 7037 | 7062 | 7062 | 7062 |
| 2045 | 7261 | 7261 | 6734 | 7999 | 7265 | 7296 | 7261 | 7261 | 7261 |
| 2046 | 7635 | 7635 | 6962 | 8291 | 7637 | 7644 | 7635 | 7635 | 7635 |
| 2047 | 7967 | 7967 | 7202 | 8528 | 7969 | 7967 | 7967 | 7967 | 7967 |
| 2048 | 8221 | 8221 | 7254 | 8694 | 8223 | 8231 | 8221 | 8221 | 8221 |
| 2049 | 8411 | 8411 | 7656 | 8801 | 8413 | 8407 | 8411 | 8411 | 8411 |
| 2050 | 8588 | 8588 | 7934 | 8892 | 8597 | 8553 | 8588 | 8588 | 8588 |
| 2051 | 8701 | 8701 | 8121 | 8961 | 8711 | 8652 | 8701 | 8701 | 8701 |
| 2052 | 8749 | 8749 | 8288 | 9009 | 8759 | 8701 | 8749 | 8749 | 8749 |
| 2053 | 8786 | 8786 | 8390 | 9039 | 8796 | 8738 | 8786 | 8786 | 8786 |
| 2054 | 8822 | 8822 | 8434 | 9063 | 8832 | 8776 | 8822 | 8822 | 8822 |
| 2055 | 8861 | 8861 | 8470 | 9081 | 8871 | 8803 | 8861 | 8861 | 8861 |
| 2056 | 8895 | 8895 | 8506 | 9094 | 8905 | 8819 | 8895 | 8895 | 8895 |
| 2057 | 8907 | 8907 | 8527 | 9096 | 8917 | 8819 | 8907 | 8907 | 8907 |
| 2058 | 8910 | 8910 | 8542 | 9097 | 8920 | 8819 | 8910 | 8910 | 8910 |
| 2059 | 8911 | 8911 | 8544 | 9097 | 8921 | 8819 | 8911 | 8911 | 8911 |

|      | 100  | 101  | 102  | 103  | 104  | 105  | 106  | 107  | 108  |
|------|------|------|------|------|------|------|------|------|------|
| 2060 | 8911 | 8911 | 8544 | 9097 | 8921 | 8819 | 8911 | 8911 | 8911 |
| 2061 | 8911 | 8911 | 8544 | 9097 | 8921 | 8819 | 8911 | 8911 | 8911 |
| 2062 | 8911 | 8911 | 8544 | 9097 | 8921 | 8819 | 8911 | 8911 | 8911 |
| 2063 | 8911 | 8911 | 8544 | 9097 | 8921 | 8819 | 8911 | 8911 | 8911 |
| 2064 | 8911 | 8911 | 8544 | 9097 | 8921 | 8819 | 8911 | 8911 | 8911 |
| 2065 | 8911 | 8911 | 8544 | 9097 | 8921 | 8819 | 8911 | 8911 | 8911 |
| 2066 | 8911 | 8911 | 8544 | 9097 | 8921 | 8819 | 8911 | 8911 | 8911 |
| 2067 | 8911 | 8911 | 8544 | 9097 | 8921 | 8819 | 8911 | 8911 | 8911 |
| 2068 | 8911 | 8911 | 8544 | 9097 | 8921 | 8819 | 8911 | 8911 | 8911 |
| 2069 | 8911 | 8911 | 8544 | 9097 | 8921 | 8819 | 8911 | 8911 | 8911 |
| 2070 | 8911 | 8911 | 8544 | 9097 | 8921 | 8819 | 8911 | 8911 | 8911 |
| 2071 | 8911 | 8911 | 8544 | 9097 | 8921 | 8819 | 8911 | 8911 | 8911 |
| 2072 | 8911 | 8911 | 8544 | 9097 | 8921 | 8819 | 8911 | 8911 | 8911 |
| 2073 | 8911 | 8911 | 8544 | 9097 | 8921 | 8819 | 8911 | 8911 | 8911 |
| 2074 | 8911 | 8911 | 8544 | 9097 | 8921 | 8819 | 8911 | 8911 | 8911 |
| 2075 | 8911 | 8911 | 8544 | 9097 | 8921 | 8819 | 8911 | 8911 | 8911 |
| 2076 | 8911 | 8911 | 8544 | 9097 | 8921 | 8819 | 8911 | 8911 | 8911 |
| 2077 | 8911 | 8911 | 8544 | 9097 | 8921 | 8819 | 8911 | 8911 | 8911 |
| 2078 | 8911 | 8911 | 8544 | 9097 | 8921 | 8819 | 8911 | 8911 | 8911 |
| 2079 | 8911 | 8911 | 8544 | 9097 | 8921 | 8819 | 8911 | 8911 | 8911 |
| 2080 | 8911 | 8911 | 8544 | 9097 | 8921 | 8819 | 8911 | 8911 | 8911 |
| 2081 | 8911 | 8911 | 8544 | 9097 | 8921 | 8819 | 8911 | 8911 | 8911 |
| 2082 | 8911 | 8911 | 8544 | 9097 | 8921 | 8819 | 8911 | 8911 | 8911 |
| 2083 | 8911 | 8911 | 8544 | 9097 | 8921 | 8819 | 8911 | 8911 | 8911 |
| 2084 | 8911 | 8911 | 8544 | 9097 | 8921 | 8819 | 8911 | 8911 | 8911 |
| 2085 | 8911 | 8911 | 8544 | 9097 | 8921 | 8819 | 8911 | 8911 | 8911 |
| 2086 | 8911 | 8911 | 8544 | 9097 | 8921 | 8819 | 8911 | 8911 | 8911 |
| 2087 | 8911 | 8911 | 8544 | 9097 | 8921 | 8819 | 8911 | 8911 | 8911 |
| 2088 | 8911 | 8911 | 8544 | 9097 | 8921 | 8819 | 8911 | 8911 | 8911 |
| 2089 | 8911 | 8911 | 8544 | 9097 | 8921 | 8819 | 8911 | 8911 | 8911 |
| 2090 | 8911 | 8911 | 8544 | 9097 | 8921 | 8819 | 8911 | 8911 | 8911 |
|      |      |      |      |      |      |      |      |      |      |

|      | 109  | 110  | 111  | 112  | 113  | 114  | 115  | 116  | 117  |
|------|------|------|------|------|------|------|------|------|------|
| 2002 | 0    | 0    | 0    | 0    | 0    | 0    | 0    | 0    | 0    |
| 2003 | 0    | 0    | 0    | 0    | 0    | 0    | 0    | 0    | 0    |
| 2004 | 1    | 1    | 1    | 1    | 1    | 1    | 1    | 1    | 1    |
| 2005 | 3    | 3    | 3    | 3    | 3    | 3    | 3    | 3    | 3    |
| 2006 | 14   | 14   | 14   | 14   | 14   | 14   | 14   | 14   | 14   |
| 2007 | 33   | 33   | 33   | 33   | 33   | 33   | 33   | 33   | 33   |
| 2008 | 67   | 67   | 67   | 67   | 67   | 67   | 67   | 67   | 67   |
| 2009 | 128  | 128  | 128  | 128  | 128  | 128  | 128  | 128  | 128  |
| 2010 | 210  | 210  | 210  | 210  | 210  | 210  | 210  | 210  | 210  |
| 2011 | 313  | 313  | 313  | 313  | 313  | 313  | 313  | 313  | 313  |
| 2012 | 418  | 418  | 418  | 418  | 418  | 418  | 418  | 418  | 418  |
| 2013 | 547  | 547  | 547  | 547  | 547  | 547  | 547  | 547  | 547  |
| 2014 | 665  | 665  | 665  | 665  | 665  | 665  | 665  | 665  | 665  |
| 2015 | 814  | 814  | 814  | 814  | 814  | 814  | 814  | 814  | 814  |
| 2016 | 957  | 957  | 957  | 957  | 957  | 957  | 957  | 957  | 957  |
| 2017 | 1109 | 1109 | 1109 | 1109 | 1109 | 1109 | 1109 | 1109 | 1109 |
| 2018 | 1276 | 1276 | 1276 | 1276 | 1276 | 1276 | 1276 | 1276 | 1276 |
| 2019 | 1449 | 1449 | 1449 | 1449 | 1449 | 1449 | 1449 | 1449 | 1449 |
| 2020 | 1622 | 1622 | 1622 | 1703 | 1622 | 1622 | 1622 | 1622 | 1622 |
| 2021 | 1808 | 1808 | 1808 | 1955 | 1808 | 1808 | 1808 | 1808 | 1808 |
| 2022 | 1974 | 1974 | 1974 | 2209 | 1974 | 1974 | 1974 | 1974 | 1974 |
| 2023 | 2164 | 2164 | 2164 | 2466 | 2164 | 2164 | 2164 | 2164 | 2164 |
| 2024 | 2363 | 2363 | 2363 | 2717 | 2363 | 2363 | 2363 | 2363 | 2363 |
| 2025 | 2619 | 2619 | 2555 | 2986 | 2619 | 2619 | 2619 | 2619 | 2619 |
| 2026 | 2869 | 2869 | 2738 | 3242 | 2869 | 2869 | 2869 | 2869 | 2869 |
| 2027 | 3120 | 3120 | 2931 | 3499 | 3120 | 3120 | 3120 | 3120 | 3120 |
| 2028 | 3374 | 3374 | 3125 | 3753 | 3374 | 3374 | 3374 | 3374 | 3374 |
| 2029 | 3624 | 3624 | 3297 | 4027 | 3624 | 3624 | 3624 | 3624 | 3624 |
| 2030 | 3876 | 3876 | 3553 | 4294 | 3876 | 3876 | 3876 | 3876 | 3876 |
| 2031 | 4134 | 4134 | 3806 | 4552 | 4134 | 4134 | 4134 | 4134 | 4134 |
| 2032 | 4390 | 4390 | 4056 | 4835 | 4390 | 4384 | 4390 | 4390 | 4390 |
| 2033 | 4640 | 4640 | 4313 | 5126 | 4640 | 4624 | 4640 | 4640 | 4640 |
| 2034 | 4899 | 4899 | 4568 | 5385 | 4899 | 4850 | 4899 | 4899 | 4899 |
| 2035 | 5166 | 5166 | 4820 | 5710 | 5166 | 5100 | 5166 | 5166 | 5166 |
| 2036 | 5452 | 5452 | 5087 | 6021 | 5451 | 5352 | 5452 | 5452 | 5452 |
| 2037 | 5717 | 5717 | 5349 | 6253 | 5724 | 5652 | 5717 | 5717 | 5717 |
| 2038 | 6030 | 6032 | 5608 | 6534 | 6050 | 5952 | 6036 | 6036 | 6036 |
| 2039 | 6264 | 6266 | 5866 | 6839 | 6329 | 6229 | 6274 | 6274 | 6274 |
| 2040 | 6570 | 6572 | 6125 | 7109 | 6631 | 6539 | 6580 | 6580 | 6580 |
| 2041 | 6829 | 6832 | 6370 | 7253 | 6895 | 6819 | 6851 | 6851 | 6851 |
| 2042 | 7159 | 7153 | 6631 | 7891 | 7245 | 7149 | 7203 | 7203 | 7203 |
| 2043 | 7317 | 7309 | 6917 | 8313 | 7315 | 7314 | 7321 | 7321 | 7321 |
| 2044 | 7971 | 7965 | 7168 | 8561 | 7970 | 7963 | 7975 | 7975 | 7975 |
| 2045 | 8357 | 8351 | 7308 | 8679 | 8355 | 8360 | 8359 | 8359 | 8359 |
| 2046 | 8539 | 8533 | 8062 | 8739 | 8537 | 8552 | 8537 | 8537 | 8537 |
| 2047 | 8626 | 8620 | 8407 | 8776 | 8609 | 8639 | 8609 | 8609 | 8609 |
| 2048 | 8711 | 8705 | 8566 | 8832 | 8685 | 8723 | 8685 | 8685 | 8685 |
| 2049 | 8722 | 8715 | 8654 | 8842 | 8695 | 8734 | 8695 | 8695 | 8695 |
| 2050 | 8731 | 8724 | 8667 | 8851 | 8704 | 8744 | 8704 | 8704 | 8704 |
| 2051 | 8746 | 8739 | 8683 | 8866 | 8719 | 8760 | 8719 | 8719 | 8719 |
| 2052 | 8751 | 8744 | 8688 | 8871 | 8724 | 8765 | 8724 | 8724 | 8724 |
| 2053 | 8751 | 8744 | 8688 | 8871 | 8724 | 8765 | 8724 | 8724 | 8724 |
| 2054 | 8764 | 8757 | 8701 | 8884 | 8737 | 8778 | 8737 | 8737 | 8737 |
| 2055 | 8766 | 8759 | 8703 | 8886 | 8739 | 8780 | 8739 | 8739 | 8739 |
| 2056 | 8776 | 8769 | 8713 | 8896 | 8749 | 8790 | 8749 | 8749 | 8749 |
| 2057 | 8776 | 8769 | 8713 | 8896 | 8749 | 8790 | 8749 | 8749 | 8749 |
| 2058 | 8776 | 8769 | 8713 | 8896 | 8749 | 8790 | 8749 | 8749 | 8749 |
| 2059 | 8776 | 8769 | 8713 | 8896 | 8749 | 8790 | 8749 | 8749 | 8749 |

|      | 109  | 110  | 111  | 112  | 113  | 114  | 115  | 116  | 117  |
|------|------|------|------|------|------|------|------|------|------|
| 2060 | 8776 | 8769 | 8713 | 8896 | 8749 | 8790 | 8749 | 8749 | 8749 |
| 2061 | 8776 | 8769 | 8713 | 8896 | 8749 | 8790 | 8749 | 8749 | 8749 |
| 2062 | 8776 | 8769 | 8713 | 8896 | 8749 | 8790 | 8749 | 8749 | 8749 |
| 2063 | 8776 | 8769 | 8713 | 8896 | 8749 | 8790 | 8749 | 8749 | 8749 |
| 2064 | 8776 | 8769 | 8713 | 8896 | 8749 | 8790 | 8749 | 8749 | 8749 |
| 2065 | 8776 | 8769 | 8713 | 8896 | 8749 | 8790 | 8749 | 8749 | 8749 |
| 2066 | 8776 | 8769 | 8713 | 8896 | 8749 | 8790 | 8749 | 8749 | 8749 |
| 2067 | 8776 | 8769 | 8713 | 8896 | 8749 | 8790 | 8749 | 8749 | 8749 |
| 2068 | 8776 | 8769 | 8713 | 8896 | 8749 | 8790 | 8749 | 8749 | 8749 |
| 2069 | 8776 | 8769 | 8713 | 8896 | 8749 | 8790 | 8749 | 8749 | 8749 |
| 2070 | 8776 | 8769 | 8713 | 8896 | 8749 | 8790 | 8749 | 8749 | 8749 |
| 2071 | 8776 | 8769 | 8713 | 8896 | 8749 | 8790 | 8749 | 8749 | 8749 |
| 2072 | 8776 | 8769 | 8713 | 8896 | 8749 | 8790 | 8749 | 8749 | 8749 |
| 2073 | 8776 | 8769 | 8713 | 8896 | 8749 | 8790 | 8749 | 8749 | 8749 |
| 2074 | 8776 | 8769 | 8713 | 8896 | 8749 | 8790 | 8749 | 8749 | 8749 |
| 2075 | 8776 | 8769 | 8713 | 8896 | 8749 | 8790 | 8749 | 8749 | 8749 |
| 2076 | 8776 | 8769 | 8713 | 8896 | 8749 | 8790 | 8749 | 8749 | 8749 |
| 2077 | 8776 | 8769 | 8713 | 8896 | 8749 | 8790 | 8749 | 8749 | 8749 |
| 2078 | 8776 | 8769 | 8713 | 8896 | 8749 | 8790 | 8749 | 8749 | 8749 |
| 2079 | 8776 | 8769 | 8713 | 8896 | 8749 | 8790 | 8749 | 8749 | 8749 |
| 2080 | 8776 | 8769 | 8713 | 8896 | 8749 | 8790 | 8749 | 8749 | 8749 |
| 2081 | 8776 | 8769 | 8713 | 8896 | 8749 | 8790 | 8749 | 8749 | 8749 |
| 2082 | 8776 | 8769 | 8713 | 8896 | 8749 | 8790 | 8749 | 8749 | 8749 |
| 2083 | 8776 | 8769 | 8713 | 8896 | 8749 | 8790 | 8749 | 8749 | 8749 |
| 2084 | 8776 | 8769 | 8713 | 8896 | 8749 | 8790 | 8749 | 8749 | 8749 |
| 2085 | 8776 | 8769 | 8713 | 8896 | 8749 | 8790 | 8749 | 8749 | 8749 |
| 2086 | 8776 | 8769 | 8713 | 8896 | 8749 | 8790 | 8749 | 8749 | 8749 |
| 2087 | 8776 | 8769 | 8713 | 8896 | 8749 | 8790 | 8749 | 8749 | 8749 |
| 2088 | 8776 | 8769 | 8713 | 8896 | 8749 | 8790 | 8749 | 8749 | 8749 |
| 2089 | 8776 | 8769 | 8713 | 8896 | 8749 | 8790 | 8749 | 8749 | 8749 |
| 2090 | 8776 | 8769 | 8713 | 8896 | 8749 | 8790 | 8749 | 8749 | 8749 |
|      |      |      |      |      |      |      |      |      |      |

|      | 118  | 119  | 120  | 121  | 122  | 123  | 124  | 125  | 126  |
|------|------|------|------|------|------|------|------|------|------|
| 2002 | 0    | 0    | 0    | 0    | 0    | 0    | 0    | 0    | 0    |
| 2003 | 0    | 0    | 0    | 0    | 0    | 0    | 0    | 0    | 0    |
| 2004 | 1    | 1    | 1    | 1    | 1    | 1    | 1    | 1    | 1    |
| 2005 | 3    | 3    | 3    | 3    | 3    | 3    | 3    | 3    | 3    |
| 2006 | 14   | 14   | 14   | 14   | 14   | 14   | 14   | 14   | 14   |
| 2007 | 33   | 33   | 33   | 33   | 33   | 33   | 33   | 33   | 33   |
| 2008 | 67   | 67   | 67   | 67   | 67   | 67   | 67   | 67   | 67   |
| 2009 | 128  | 128  | 128  | 128  | 128  | 128  | 128  | 128  | 128  |
| 2010 | 210  | 210  | 210  | 210  | 210  | 210  | 210  | 210  | 210  |
| 2011 | 313  | 313  | 313  | 313  | 313  | 313  | 313  | 313  | 313  |
| 2012 | 418  | 418  | 418  | 418  | 418  | 418  | 418  | 418  | 418  |
| 2013 | 547  | 547  | 547  | 547  | 547  | 547  | 547  | 547  | 547  |
| 2014 | 665  | 665  | 665  | 665  | 665  | 665  | 665  | 665  | 665  |
| 2015 | 814  | 814  | 814  | 814  | 814  | 814  | 814  | 814  | 814  |
| 2016 | 957  | 957  | 957  | 957  | 957  | 957  | 957  | 957  | 957  |
| 2017 | 1109 | 1109 | 1109 | 1109 | 1109 | 1109 | 1109 | 1109 | 1109 |
| 2018 | 1276 | 1276 | 1276 | 1276 | 1276 | 1276 | 1276 | 1276 | 1276 |
| 2019 | 1449 | 1449 | 1449 | 1449 | 1449 | 1449 | 1449 | 1449 | 1449 |
| 2020 | 1622 | 1622 | 1622 | 1699 | 1622 | 1622 | 1622 | 1622 | 1622 |
| 2021 | 1808 | 1808 | 1808 | 1949 | 1808 | 1808 | 1808 | 1808 | 1808 |
| 2022 | 1974 | 1974 | 1974 | 2194 | 1974 | 1974 | 1974 | 1974 | 1974 |
| 2023 | 2164 | 2164 | 2164 | 2442 | 2164 | 2164 | 2164 | 2164 | 2164 |
| 2024 | 2363 | 2363 | 2363 | 2700 | 2363 | 2363 | 2363 | 2363 | 2363 |
| 2025 | 2613 | 2613 | 2555 | 2935 | 2613 | 2611 | 2613 | 2613 | 2613 |
| 2026 | 2856 | 2856 | 2738 | 3164 | 2859 | 2845 | 2856 | 2856 | 2856 |
| 2027 | 3106 | 3106 | 2931 | 3415 | 3104 | 3077 | 3106 | 3106 | 3106 |
| 2028 | 3342 | 3342 | 3125 | 3669 | 3340 | 3297 | 3342 | 3342 | 3342 |
| 2029 | 3567 | 3567 | 3297 | 3915 | 3569 | 3522 | 3566 | 3566 | 3566 |
| 2030 | 3810 | 3802 | 3547 | 4125 | 3808 | 3756 | 3800 | 3800 | 3800 |
| 2031 | 4038 | 4029 | 3797 | 4367 | 4046 | 3978 | 4028 | 4028 | 4028 |
| 2032 | 4246 | 4243 | 4038 | 4606 | 4252 | 4190 | 4236 | 4236 | 4236 |
| 2033 | 4470 | 4467 | 4281 | 4815 | 4480 | 4412 | 4465 | 4465 | 4465 |
| 2034 | 4711 | 4709 | 4526 | 5010 | 4726 | 4640 | 4709 | 4709 | 4709 |
| 2035 | 4945 | 4941 | 4761 | 5206 | 4942 | 4879 | 4944 | 4944 | 4944 |
| 2036 | 5122 | 5134 | 4985 | 5386 | 5132 | 5083 | 5121 | 5121 | 5121 |
| 2037 | 5311 | 5323 | 5199 | 5533 | 5323 | 5290 | 5312 | 5312 | 5312 |
| 2038 | 5499 | 5518 | 5418 | 5675 | 5535 | 5482 | 5506 | 5506 | 5506 |
| 2039 | 5691 | 5715 | 5618 | 5860 | 5721 | 5672 | 5701 | 5701 | 5701 |
| 2040 | 5926 | 5949 | 5837 | 6045 | 5946 | 5896 | 5934 | 5934 | 5934 |
| 2041 | 6153 | 6180 | 6064 | 6236 | 6170 | 6113 | 6161 | 6161 | 6161 |
| 2042 | 6366 | 6393 | 6264 | 6388 | 6398 | 6318 | 6380 | 6380 | 6380 |
| 2043 | 6542 | 6568 | 6497 | 6547 | 6624 | 6499 | 6564 | 6564 | 6564 |
| 2044 | 6707 | 6736 | 6714 | 6690 | 6820 | 6653 | 6730 | 6730 | 6730 |
| 2045 | 6862 | 6868 | 6913 | 6831 | 6979 | 6807 | 6866 | 6866 | 6866 |
| 2046 | 7015 | 6995 | 7103 | 6945 | 7160 | 6972 | 7007 | 7007 | 7007 |
| 2047 | 7154 | 7166 | 7257 | 7080 | 7257 | 7161 | 7154 | 7154 | 7154 |
| 2048 | 7257 | 7257 | 7661 | 7253 | 7678 | 7253 | 7250 | 7250 | 7250 |
| 2049 | 7678 | 7678 | 7939 | 7625 | 8020 | 7649 | 7671 | 7671 | 7671 |
| 2050 | 8020 | 8020 | 8126 | 7991 | 8266 | 7991 | 8013 | 8013 | 8013 |
| 2051 | 8266 | 8266 | 8293 | 8283 | 8456 | 8237 | 8259 | 8259 | 8259 |
| 2052 | 8456 | 8456 | 8395 | 8518 | 8640 | 8427 | 8449 | 8449 | 8449 |
| 2053 | 8640 | 8640 | 8439 | 8724 | 8754 | 8611 | 8633 | 8633 | 8633 |
| 2054 | 8754 | 8754 | 8475 | 8888 | 8802 | 8724 | 8747 | 8747 | 8747 |
| 2055 | 8802 | 8802 | 8511 | 9013 | 8839 | 8772 | 8795 | 8795 | 8795 |
| 2056 | 8839 | 8839 | 8532 | 9085 | 8875 | 8809 | 8832 | 8832 | 8832 |
| 2057 | 8875 | 8875 | 8547 | 9132 | 8914 | 8845 | 8868 | 8868 | 8868 |
| 2058 | 8914 | 8914 | 8549 | 9172 | 8948 | 8884 | 8907 | 8907 | 8907 |
| 2059 | 8948 | 8948 | 8549 | 9208 | 8960 | 8918 | 8941 | 8941 | 8941 |

|      | 118  | 119  | 120  | 121  | 122  | 123  | 124  | 125  | 126  |
|------|------|------|------|------|------|------|------|------|------|
| 2060 | 8960 | 8960 | 8549 | 9244 | 8963 | 8930 | 8953 | 8953 | 8953 |
| 2061 | 8963 | 8963 | 8549 | 9278 | 8964 | 8933 | 8956 | 8956 | 8956 |
| 2062 | 8964 | 8964 | 8549 | 9294 | 8964 | 8934 | 8957 | 8957 | 8957 |
| 2063 | 8964 | 8964 | 8549 | 9299 | 8964 | 8934 | 8957 | 8957 | 8957 |
| 2064 | 8964 | 8964 | 8549 | 9299 | 8964 | 8934 | 8957 | 8957 | 8957 |
| 2065 | 8964 | 8964 | 8549 | 9299 | 8964 | 8934 | 8957 | 8957 | 8957 |
| 2066 | 8964 | 8964 | 8549 | 9299 | 8964 | 8934 | 8957 | 8957 | 8957 |
| 2067 | 8964 | 8964 | 8549 | 9299 | 8964 | 8934 | 8957 | 8957 | 8957 |
| 2068 | 8964 | 8964 | 8549 | 9299 | 8964 | 8934 | 8957 | 8957 | 8957 |
| 2069 | 8964 | 8964 | 8549 | 9299 | 8964 | 8934 | 8957 | 8957 | 8957 |
| 2070 | 8964 | 8964 | 8549 | 9299 | 8964 | 8934 | 8957 | 8957 | 8957 |
| 2071 | 8964 | 8964 | 8549 | 9299 | 8964 | 8934 | 8957 | 8957 | 8957 |
| 2072 | 8964 | 8964 | 8549 | 9299 | 8964 | 8934 | 8957 | 8957 | 8957 |
| 2073 | 8964 | 8964 | 8549 | 9299 | 8964 | 8934 | 8957 | 8957 | 8957 |
| 2074 | 8964 | 8964 | 8549 | 9299 | 8964 | 8934 | 8957 | 8957 | 8957 |
| 2075 | 8964 | 8964 | 8549 | 9299 | 8964 | 8934 | 8957 | 8957 | 8957 |
| 2076 | 8964 | 8964 | 8549 | 9299 | 8964 | 8934 | 8957 | 8957 | 8957 |
| 2077 | 8964 | 8964 | 8549 | 9299 | 8964 | 8934 | 8957 | 8957 | 8957 |
| 2078 | 8964 | 8964 | 8549 | 9299 | 8964 | 8934 | 8957 | 8957 | 8957 |
| 2079 | 8964 | 8964 | 8549 | 9299 | 8964 | 8934 | 8957 | 8957 | 8957 |
| 2080 | 8964 | 8964 | 8549 | 9299 | 8964 | 8934 | 8957 | 8957 | 8957 |
| 2081 | 8964 | 8964 | 8549 | 9299 | 8964 | 8934 | 8957 | 8957 | 8957 |
| 2082 | 8964 | 8964 | 8549 | 9299 | 8964 | 8934 | 8957 | 8957 | 8957 |
| 2083 | 8964 | 8964 | 8549 | 9299 | 8964 | 8934 | 8957 | 8957 | 8957 |
| 2084 | 8964 | 8964 | 8549 | 9299 | 8964 | 8934 | 8957 | 8957 | 8957 |
| 2085 | 8964 | 8964 | 8549 | 9299 | 8964 | 8934 | 8957 | 8957 | 8957 |
| 2086 | 8964 | 8964 | 8549 | 9299 | 8964 | 8934 | 8957 | 8957 | 8957 |
| 2087 | 8964 | 8964 | 8549 | 9299 | 8964 | 8934 | 8957 | 8957 | 8957 |
| 2088 | 8964 | 8964 | 8549 | 9299 | 8964 | 8934 | 8957 | 8957 | 8957 |
| 2089 | 8964 | 8964 | 8549 | 9299 | 8964 | 8934 | 8957 | 8957 | 8957 |
| 2090 | 8964 | 8964 | 8549 | 9299 | 8964 | 8934 | 8957 | 8957 | 8957 |
|      |      |      |      |      |      |      |      |      |      |

|      | 127  | 128  | 129  | 130  | 131  | 132  | 133  | 134  | 135  |
|------|------|------|------|------|------|------|------|------|------|
| 2002 | 0    | 0    | 0    | 0    | 0    | 0    | 0    | 0    | 0    |
| 2003 | 0    | 0    | 0    | 0    | 0    | 0    | 0    | 0    | 0    |
| 2004 | 1    | 1    | 1    | 1    | 1    | 1    | 1    | 1    | 1    |
| 2005 | 3    | 3    | 3    | 3    | 3    | 3    | 3    | 3    | 3    |
| 2006 | 14   | 14   | 14   | 14   | 14   | 14   | 14   | 14   | 14   |
| 2007 | 33   | 33   | 33   | 33   | 33   | 33   | 33   | 33   | 33   |
| 2008 | 67   | 67   | 67   | 67   | 67   | 67   | 67   | 67   | 67   |
| 2009 | 128  | 128  | 128  | 128  | 128  | 128  | 128  | 128  | 128  |
| 2010 | 210  | 210  | 210  | 210  | 210  | 210  | 210  | 210  | 210  |
| 2011 | 313  | 313  | 313  | 313  | 313  | 313  | 313  | 313  | 313  |
| 2012 | 418  | 418  | 418  | 418  | 418  | 418  | 418  | 418  | 418  |
| 2013 | 547  | 547  | 547  | 547  | 547  | 547  | 547  | 547  | 547  |
| 2014 | 665  | 665  | 665  | 665  | 665  | 665  | 665  | 665  | 665  |
| 2015 | 814  | 814  | 814  | 814  | 814  | 814  | 814  | 814  | 814  |
| 2016 | 957  | 957  | 957  | 957  | 957  | 957  | 957  | 957  | 957  |
| 2017 | 1109 | 1109 | 1109 | 1109 | 1109 | 1109 | 1109 | 1109 | 1109 |
| 2018 | 1276 | 1276 | 1276 | 1276 | 1276 | 1276 | 1276 | 1276 | 1276 |
| 2019 | 1449 | 1449 | 1449 | 1449 | 1449 | 1449 | 1449 | 1449 | 1449 |
| 2020 | 1622 | 1622 | 1622 | 1699 | 1622 | 1622 | 1622 | 1622 | 1622 |
| 2021 | 1808 | 1808 | 1808 | 1947 | 1808 | 1808 | 1808 | 1808 | 1808 |
| 2022 | 1974 | 1974 | 1974 | 2189 | 1974 | 1974 | 1974 | 1974 | 1974 |
| 2023 | 2164 | 2164 | 2164 | 2437 | 2164 | 2164 | 2164 | 2164 | 2164 |
| 2024 | 2363 | 2363 | 2363 | 2698 | 2363 | 2363 | 2363 | 2363 | 2363 |
| 2025 | 2613 | 2613 | 2555 | 2937 | 2613 | 2613 | 2613 | 2613 | 2613 |
| 2026 | 2856 | 2856 | 2738 | 3181 | 2859 | 2852 | 2856 | 2856 | 2856 |
| 2027 | 3102 | 3102 | 2931 | 3418 | 3109 | 3093 | 3102 | 3102 | 3102 |
| 2028 | 3339 | 3339 | 3125 | 3673 | 3359 | 3317 | 3339 | 3339 | 3339 |
| 2029 | 3573 | 3575 | 3297 | 3918 | 3597 | 3539 | 3573 | 3573 | 3573 |
| 2030 | 3815 | 3824 | 3547 | 4181 | 3842 | 3774 | 3815 | 3815 | 3815 |
| 2031 | 4041 | 4053 | 3792 | 4433 | 4081 | 4005 | 4048 | 4048 | 4048 |
| 2032 | 4270 | 4277 | 4035 | 4678 | 4301 | 4212 | 4272 | 4272 | 4272 |
| 2033 | 4498 | 4504 | 4281 | 4883 | 4545 | 4435 | 4505 | 4505 | 4505 |
| 2034 | 4745 | 4743 | 4527 | 5068 | 4761 | 4690 | 4742 | 4742 | 4742 |
| 2035 | 4995 | 4996 | 4775 | 5246 | 4999 | 4928 | 4994 | 4994 | 4994 |
| 2036 | 5196 | 5200 | 5015 | 5444 | 5203 | 5132 | 5199 | 5199 | 5199 |
| 2037 | 5395 | 5416 | 5249 | 5659 | 5408 | 5327 | 5409 | 5409 | 5409 |
| 2038 | 5595 | 5621 | 5493 | 5830 | 5599 | 5525 | 5613 | 5613 | 5613 |
| 2039 | 5777 | 5803 | 5699 | 6010 | 5794 | 5717 | 5792 | 5792 | 5792 |
| 2040 | 5986 | 6019 | 5906 | 6209 | 6022 | 5942 | 6006 | 6006 | 6006 |
| 2041 | 6225 | 6263 | 6134 | 6413 | 6242 | 6170 | 6246 | 6246 | 6246 |
| 2042 | 6487 | 6501 | 6341 | 6657 | 6485 | 6378 | 6496 | 6496 | 6496 |
| 2043 | 6701 | 6725 | 6565 | 6863 | 6697 | 6584 | 6718 | 6718 | 6718 |
| 2044 | 6905 | 6925 | 6794 | 7075 | 6916 | 6780 | 6916 | 6916 | 6916 |
| 2045 | 7091 | 7104 | 6995 | 7272 | 7132 | 6989 | 7100 | 7100 | 7100 |
| 2046 | 7259 | 7259 | 7211 | 7647 | 7263 | 7178 | 7261 | 7261 | 7261 |
| 2047 | 7680 | 7680 | 7264 | 7996 | 7654 | 7256 | 7682 | 7682 | 7682 |
| 2048 | 8022 | 8022 | 7669 | 8296 | 7995 | 7657 | 8024 | 8024 | 8024 |
| 2049 | 8268 | 8268 | 7947 | 8533 | 8240 | 7998 | 8270 | 8270 | 8270 |
| 2050 | 8458 | 8458 | 8134 | 8733 | 8430 | 8245 | 8460 | 8460 | 8460 |
| 2051 | 8642 | 8642 | 8301 | 8873 | 8614 | 8436 | 8644 | 8644 | 8644 |
| 2052 | 8756 | 8756 | 8403 | 8985 | 8728 | 8619 | 8758 | 8758 | 8758 |
| 2053 | 8804 | 8804 | 8447 | 9057 | 8776 | 8732 | 8806 | 8806 | 8806 |
| 2054 | 8841 | 8841 | 8483 | 9105 | 8813 | 8780 | 8843 | 8843 | 8843 |
| 2055 | 8877 | 8877 | 8519 | 9144 | 8850 | 8817 | 8879 | 8879 | 8879 |
| 2056 | 8916 | 8919 | 8540 | 9180 | 8899 | 8853 | 8920 | 8920 | 8920 |
| 2057 | 8950 | 8954 | 8555 | 9205 | 8933 | 8892 | 8955 | 8955 | 8955 |
| 2058 | 8962 | 8966 | 8557 | 9229 | 8945 | 8926 | 8967 | 8967 | 8967 |
| 2059 | 8965 | 8969 | 8557 | 9244 | 8948 | 8938 | 8970 | 8970 | 8970 |

|      | 127  | 128  | 129  | 130  | 131  | 132  | 133  | 134  | 135  |
|------|------|------|------|------|------|------|------|------|------|
| 2060 | 8966 | 8970 | 8557 | 9249 | 8949 | 8941 | 8971 | 8971 | 8971 |
| 2061 | 8966 | 8970 | 8557 | 9249 | 8949 | 8942 | 8971 | 8971 | 8971 |
| 2062 | 8966 | 8970 | 8557 | 9249 | 8949 | 8942 | 8971 | 8971 | 8971 |
| 2063 | 8966 | 8970 | 8557 | 9249 | 8949 | 8942 | 8971 | 8971 | 8971 |
| 2064 | 8966 | 8970 | 8557 | 9249 | 8949 | 8942 | 8971 | 8971 | 8971 |
| 2065 | 8966 | 8970 | 8557 | 9249 | 8949 | 8942 | 8971 | 8971 | 8971 |
| 2066 | 8966 | 8970 | 8557 | 9249 | 8949 | 8942 | 8971 | 8971 | 8971 |
| 2067 | 8966 | 8970 | 8557 | 9249 | 8949 | 8942 | 8971 | 8971 | 8971 |
| 2068 | 8966 | 8970 | 8557 | 9249 | 8949 | 8942 | 8971 | 8971 | 8971 |
| 2069 | 8966 | 8970 | 8557 | 9249 | 8949 | 8942 | 8971 | 8971 | 8971 |
| 2070 | 8966 | 8970 | 8557 | 9249 | 8949 | 8942 | 8971 | 8971 | 8971 |
| 2071 | 8966 | 8970 | 8557 | 9249 | 8949 | 8942 | 8971 | 8971 | 8971 |
| 2072 | 8966 | 8970 | 8557 | 9249 | 8949 | 8942 | 8971 | 8971 | 8971 |
| 2073 | 8966 | 8970 | 8557 | 9249 | 8949 | 8942 | 8971 | 8971 | 8971 |
| 2074 | 8966 | 8970 | 8557 | 9249 | 8949 | 8942 | 8971 | 8971 | 8971 |
| 2075 | 8966 | 8970 | 8557 | 9249 | 8949 | 8942 | 8971 | 8971 | 8971 |
| 2076 | 8966 | 8970 | 8557 | 9249 | 8949 | 8942 | 8971 | 8971 | 8971 |
| 2077 | 8966 | 8970 | 8557 | 9249 | 8949 | 8942 | 8971 | 8971 | 8971 |
| 2078 | 8966 | 8970 | 8557 | 9249 | 8949 | 8942 | 8971 | 8971 | 8971 |
| 2079 | 8966 | 8970 | 8557 | 9249 | 8949 | 8942 | 8971 | 8971 | 8971 |
| 2080 | 8966 | 8970 | 8557 | 9249 | 8949 | 8942 | 8971 | 8971 | 8971 |
| 2081 | 8966 | 8970 | 8557 | 9249 | 8949 | 8942 | 8971 | 8971 | 8971 |
| 2082 | 8966 | 8970 | 8557 | 9249 | 8949 | 8942 | 8971 | 8971 | 8971 |
| 2083 | 8966 | 8970 | 8557 | 9249 | 8949 | 8942 | 8971 | 8971 | 8971 |
| 2084 | 8966 | 8970 | 8557 | 9249 | 8949 | 8942 | 8971 | 8971 | 8971 |
| 2085 | 8966 | 8970 | 8557 | 9249 | 8949 | 8942 | 8971 | 8971 | 8971 |
| 2086 | 8966 | 8970 | 8557 | 9249 | 8949 | 8942 | 8971 | 8971 | 8971 |
| 2087 | 8966 | 8970 | 8557 | 9249 | 8949 | 8942 | 8971 | 8971 | 8971 |
| 2088 | 8966 | 8970 | 8557 | 9249 | 8949 | 8942 | 8971 | 8971 | 8971 |
| 2089 | 8966 | 8970 | 8557 | 9249 | 8949 | 8942 | 8971 | 8971 | 8971 |
| 2090 | 8966 | 8970 | 8557 | 9249 | 8949 | 8942 | 8971 | 8971 | 8971 |
|      |      |      |      |      |      |      |      |      |      |



|      | 136  | 137  | 138  | 139  | 140  | 141  | 142  | 143  | 144  |
|------|------|------|------|------|------|------|------|------|------|
| 2002 | 0    | 0    | 0    | 0    | 0    | 0    | 0    | 0    | 0    |
| 2003 | 0    | 0    | 0    | 0    | 0    | 0    | 0    | 0    | 0    |
| 2004 | 1    | 1    | 1    | 1    | 1    | 1    | 1    | 1    | 1    |
| 2005 | 3    | 3    | 3    | 3    | 3    | 3    | 3    | 3    | 3    |
| 2006 | 14   | 14   | 14   | 14   | 14   | 14   | 14   | 14   | 14   |
| 2007 | 33   | 33   | 33   | 33   | 33   | 33   | 33   | 33   | 33   |
| 2008 | 67   | 67   | 67   | 67   | 67   | 67   | 67   | 67   | 67   |
| 2009 | 128  | 128  | 128  | 128  | 128  | 128  | 128  | 128  | 128  |
| 2010 | 210  | 210  | 210  | 210  | 210  | 210  | 210  | 210  | 210  |
| 2011 | 313  | 313  | 313  | 313  | 313  | 313  | 313  | 313  | 313  |
| 2012 | 418  | 418  | 418  | 418  | 418  | 418  | 418  | 418  | 418  |
| 2013 | 547  | 547  | 547  | 547  | 547  | 547  | 547  | 547  | 547  |
| 2014 | 665  | 665  | 665  | 665  | 665  | 665  | 665  | 665  | 665  |
| 2015 | 814  | 814  | 814  | 814  | 814  | 814  | 814  | 814  | 814  |
| 2016 | 957  | 957  | 957  | 957  | 957  | 957  | 957  | 957  | 957  |
| 2017 | 1109 | 1109 | 1109 | 1109 | 1109 | 1109 | 1109 | 1109 | 1109 |
| 2018 | 1276 | 1276 | 1276 | 1276 | 1276 | 1276 | 1276 | 1276 | 1276 |
| 2019 | 1449 | 1449 | 1449 | 1449 | 1449 | 1449 | 1449 | 1449 | 1449 |
| 2020 | 1622 | 1622 | 1622 | 1703 | 1622 | 1622 | 1622 | 1622 | 1622 |
| 2021 | 1808 | 1808 | 1808 | 1885 | 1808 | 1808 | 1808 | 1808 | 1808 |
| 2022 | 1974 | 1974 | 1974 | 2108 | 1974 | 1974 | 1974 | 1974 | 1974 |
| 2023 | 2164 | 2164 | 2164 | 2330 | 2164 | 2164 | 2164 | 2164 | 2164 |
| 2024 | 2363 | 2363 | 2363 | 2541 | 2363 | 2363 | 2363 | 2363 | 2363 |
| 2025 | 2619 | 2619 | 2555 | 2756 | 2619 | 2619 | 2619 | 2619 | 2619 |
| 2026 | 2793 | 2784 | 2738 | 3019 | 2779 | 2779 | 2779 | 2779 | 2779 |
| 2027 | 2983 | 2982 | 2931 | 3259 | 2989 | 2989 | 2989 | 2989 | 2989 |
| 2028 | 3168 | 3163 | 3125 | 3472 | 3177 | 3177 | 3177 | 3177 | 3177 |
| 2029 | 3363 | 3346 | 3297 | 3717 | 3374 | 3374 | 3374 | 3374 | 3374 |
| 2030 | 3552 | 3559 | 3553 | 3993 | 3566 | 3566 | 3566 | 3566 | 3566 |
| 2031 | 3759 | 3768 | 3722 | 4260 | 3760 | 3760 | 3760 | 3760 | 3760 |
| 2032 | 3952 | 3953 | 3891 | 4523 | 3937 | 3937 | 3937 | 3937 | 3937 |
| 2033 | 4148 | 4143 | 4099 | 4796 | 4154 | 4154 | 4154 | 4154 | 4154 |
| 2034 | 4368 | 4359 | 4296 | 5127 | 4386 | 4386 | 4386 | 4386 | 4386 |
| 2035 | 4616 | 4592 | 4516 | 5388 | 4617 | 4617 | 4617 | 4617 | 4617 |
| 2036 | 4848 | 4858 | 4711 | 5757 | 4881 | 4890 | 4881 | 4881 | 4881 |
| 2037 | 5137 | 5112 | 4899 | 6034 | 5148 | 5149 | 5148 | 5148 | 5148 |
| 2038 | 5394 | 5388 | 5057 | 6283 | 5404 | 5431 | 5404 | 5404 | 5404 |
| 2039 | 5681 | 5675 | 5244 | 6590 | 5691 | 5692 | 5695 | 5695 | 5695 |
| 2040 | 5971 | 5965 | 5438 | 6888 | 5980 | 5991 | 5994 | 5994 | 5994 |
| 2041 | 6295 | 6260 | 5657 | 7140 | 6276 | 6284 | 6297 | 6297 | 6297 |
| 2042 | 6585 | 6587 | 5898 | 7346 | 6614 | 6598 | 6596 | 6596 | 6596 |
| 2043 | 6943 | 6916 | 6151 | 7963 | 6886 | 6897 | 6912 | 6912 | 6912 |
| 2044 | 7277 | 7250 | 6408 | 8355 | 7255 | 7235 | 7250 | 7250 | 7250 |
| 2045 | 7937 | 7924 | 6704 | 8583 | 7944 | 7317 | 7928 | 7928 | 7928 |
| 2046 | 8327 | 8326 | 6977 | 8667 | 8346 | 7987 | 8330 | 8330 | 8330 |
| 2047 | 8520 | 8520 | 7236 | 8708 | 8540 | 8370 | 8524 | 8524 | 8524 |
| 2048 | 8628 | 8640 | 7336 | 8764 | 8660 | 8595 | 8644 | 8644 | 8644 |
| 2049 | 8664 | 8679 | 8026 | 8773 | 8699 | 8658 | 8683 | 8683 | 8683 |
| 2050 | 8674 | 8690 | 8371 | 8782 | 8710 | 8696 | 8694 | 8694 | 8694 |
| 2051 | 8689 | 8705 | 8503 | 8797 | 8725 | 8712 | 8709 | 8709 | 8709 |
| 2052 | 8694 | 8710 | 8601 | 8802 | 8730 | 8717 | 8714 | 8714 | 8714 |
| 2053 | 8694 | 8710 | 8617 | 8802 | 8730 | 8717 | 8714 | 8714 | 8714 |
| 2054 | 8707 | 8723 | 8633 | 8815 | 8743 | 8730 | 8727 | 8727 | 8727 |
| 2055 | 8709 | 8725 | 8635 | 8817 | 8745 | 8732 | 8729 | 8729 | 8729 |
| 2056 | 8719 | 8735 | 8645 | 8827 | 8755 | 8742 | 8739 | 8739 | 8739 |
| 2057 | 8719 | 8735 | 8645 | 8827 | 8755 | 8742 | 8739 | 8739 | 8739 |
| 2058 | 8719 | 8735 | 8645 | 8827 | 8755 | 8742 | 8739 | 8739 | 8739 |
| 2059 | 8719 | 8735 | 8645 | 8827 | 8755 | 8742 | 8739 | 8739 | 8739 |

|      | 136  | 137  | 138  | 139  | 140  | 141  | 142  | 143  | 144  |
|------|------|------|------|------|------|------|------|------|------|
| 2060 | 8719 | 8735 | 8645 | 8827 | 8755 | 8742 | 8739 | 8739 | 8739 |
| 2061 | 8719 | 8735 | 8645 | 8827 | 8755 | 8742 | 8739 | 8739 | 8739 |
| 2062 | 8719 | 8735 | 8645 | 8827 | 8755 | 8742 | 8739 | 8739 | 8739 |
| 2063 | 8719 | 8735 | 8645 | 8827 | 8755 | 8742 | 8739 | 8739 | 8739 |
| 2064 | 8719 | 8735 | 8645 | 8827 | 8755 | 8742 | 8739 | 8739 | 8739 |
| 2065 | 8719 | 8735 | 8645 | 8827 | 8755 | 8742 | 8739 | 8739 | 8739 |
| 2066 | 8719 | 8735 | 8645 | 8827 | 8755 | 8742 | 8739 | 8739 | 8739 |
| 2067 | 8719 | 8735 | 8645 | 8827 | 8755 | 8742 | 8739 | 8739 | 8739 |
| 2068 | 8719 | 8735 | 8645 | 8827 | 8755 | 8742 | 8739 | 8739 | 8739 |
| 2069 | 8719 | 8735 | 8645 | 8827 | 8755 | 8742 | 8739 | 8739 | 8739 |
| 2070 | 8719 | 8735 | 8645 | 8827 | 8755 | 8742 | 8739 | 8739 | 8739 |
| 2071 | 8719 | 8735 | 8645 | 8827 | 8755 | 8742 | 8739 | 8739 | 8739 |
| 2072 | 8719 | 8735 | 8645 | 8827 | 8755 | 8742 | 8739 | 8739 | 8739 |
| 2073 | 8719 | 8735 | 8645 | 8827 | 8755 | 8742 | 8739 | 8739 | 8739 |
| 2074 | 8719 | 8735 | 8645 | 8827 | 8755 | 8742 | 8739 | 8739 | 8739 |
| 2075 | 8719 | 8735 | 8645 | 8827 | 8755 | 8742 | 8739 | 8739 | 8739 |
| 2076 | 8719 | 8735 | 8645 | 8827 | 8755 | 8742 | 8739 | 8739 | 8739 |
| 2077 | 8719 | 8735 | 8645 | 8827 | 8755 | 8742 | 8739 | 8739 | 8739 |
| 2078 | 8719 | 8735 | 8645 | 8827 | 8755 | 8742 | 8739 | 8739 | 8739 |
| 2079 | 8719 | 8735 | 8645 | 8827 | 8755 | 8742 | 8739 | 8739 | 8739 |
| 2080 | 8719 | 8735 | 8645 | 8827 | 8755 | 8742 | 8739 | 8739 | 8739 |
| 2081 | 8719 | 8735 | 8645 | 8827 | 8755 | 8742 | 8739 | 8739 | 8739 |
| 2082 | 8719 | 8735 | 8645 | 8827 | 8755 | 8742 | 8739 | 8739 | 8739 |
| 2083 | 8719 | 8735 | 8645 | 8827 | 8755 | 8742 | 8739 | 8739 | 8739 |
| 2084 | 8719 | 8735 | 8645 | 8827 | 8755 | 8742 | 8739 | 8739 | 8739 |
| 2085 | 8719 | 8735 | 8645 | 8827 | 8755 | 8742 | 8739 | 8739 | 8739 |
| 2086 | 8719 | 8735 | 8645 | 8827 | 8755 | 8742 | 8739 | 8739 | 8739 |
| 2087 | 8719 | 8735 | 8645 | 8827 | 8755 | 8742 | 8739 | 8739 | 8739 |
| 2088 | 8719 | 8735 | 8645 | 8827 | 8755 | 8742 | 8739 | 8739 | 8739 |
| 2089 | 8719 | 8735 | 8645 | 8827 | 8755 | 8742 | 8739 | 8739 | 8739 |
| 2090 | 8719 | 8735 | 8645 | 8827 | 8755 | 8742 | 8739 | 8739 | 8739 |
|      |      |      |      |      |      |      |      |      |      |

|      | 145  | 146  | 147  | 148  | 149  | 150  | 151  | 152  | 153  |
|------|------|------|------|------|------|------|------|------|------|
| 2002 | 0    | 0    | 0    | 0    | 0    | 0    | 0    | 0    | 0    |
| 2003 | 0    | 0    | 0    | 0    | 0    | 0    | 0    | 0    | 0    |
| 2004 | 1    | 1    | 1    | 1    | 1    | 1    | 1    | 1    | 1    |
| 2005 | 3    | 3    | 3    | 3    | 3    | 3    | 3    | 3    | 3    |
| 2006 | 14   | 14   | 14   | 14   | 14   | 14   | 14   | 14   | 14   |
| 2007 | 33   | 33   | 33   | 33   | 33   | 33   | 33   | 33   | 33   |
| 2008 | 67   | 67   | 67   | 67   | 67   | 67   | 67   | 67   | 67   |
| 2009 | 128  | 128  | 128  | 128  | 128  | 128  | 128  | 128  | 128  |
| 2010 | 210  | 210  | 210  | 210  | 210  | 210  | 210  | 210  | 210  |
| 2011 | 313  | 313  | 313  | 313  | 313  | 313  | 313  | 313  | 313  |
| 2012 | 418  | 418  | 418  | 418  | 418  | 418  | 418  | 418  | 418  |
| 2013 | 547  | 547  | 547  | 547  | 547  | 547  | 547  | 547  | 547  |
| 2014 | 665  | 665  | 665  | 665  | 665  | 665  | 665  | 665  | 665  |
| 2015 | 814  | 814  | 814  | 814  | 814  | 814  | 814  | 814  | 814  |
| 2016 | 957  | 957  | 957  | 957  | 957  | 957  | 957  | 957  | 957  |
| 2017 | 1109 | 1109 | 1109 | 1109 | 1109 | 1109 | 1109 | 1109 | 1109 |
| 2018 | 1276 | 1276 | 1276 | 1276 | 1276 | 1276 | 1276 | 1276 | 1276 |
| 2019 | 1449 | 1449 | 1449 | 1449 | 1449 | 1449 | 1449 | 1449 | 1449 |
| 2020 | 1622 | 1622 | 1622 | 1699 | 1622 | 1622 | 1622 | 1622 | 1622 |
| 2021 | 1808 | 1808 | 1808 | 1894 | 1808 | 1808 | 1808 | 1808 | 1808 |
| 2022 | 1974 | 1974 | 1974 | 2093 | 1974 | 1974 | 1974 | 1974 | 1974 |
| 2023 | 2164 | 2164 | 2164 | 2305 | 2164 | 2164 | 2164 | 2164 | 2164 |
| 2024 | 2363 | 2363 | 2363 | 2564 | 2363 | 2363 | 2363 | 2363 | 2363 |
| 2025 | 2613 | 2613 | 2555 | 2810 | 2613 | 2611 | 2613 | 2613 | 2613 |
| 2026 | 2773 | 2781 | 2738 | 3061 | 2769 | 2767 | 2769 | 2769 | 2769 |
| 2027 | 2948 | 2975 | 2931 | 3307 | 2947 | 2945 | 2947 | 2947 | 2947 |
| 2028 | 3153 | 3181 | 3125 | 3577 | 3152 | 3142 | 3150 | 3150 | 3150 |
| 2029 | 3346 | 3368 | 3297 | 3835 | 3346 | 3337 | 3344 | 3344 | 3344 |
| 2030 | 3570 | 3572 | 3547 | 4083 | 3561 | 3551 | 3559 | 3559 | 3559 |
| 2031 | 3799 | 3811 | 3714 | 4335 | 3795 | 3793 | 3798 | 3798 | 3798 |
| 2032 | 4022 | 4037 | 3869 | 4591 | 4021 | 4022 | 4027 | 4027 | 4027 |
| 2033 | 4251 | 4262 | 4070 | 4851 | 4248 | 4234 | 4252 | 4252 | 4252 |
| 2034 | 4526 | 4538 | 4308 | 5138 | 4515 | 4508 | 4526 | 4526 | 4526 |
| 2035 | 4792 | 4804 | 4503 | 5360 | 4776 | 4774 | 4792 | 4792 | 4792 |
| 2036 | 5023 | 5035 | 4668 | 5570 | 5020 | 5009 | 5031 | 5031 | 5031 |
| 2037 | 5262 | 5264 | 4863 | 5762 | 5246 | 5244 | 5264 | 5264 | 5264 |
| 2038 | 5474 | 5474 | 5116 | 5954 | 5460 | 5461 | 5467 | 5467 | 5467 |
| 2039 | 5668 | 5678 | 5350 | 6156 | 5682 | 5690 | 5672 | 5672 | 5672 |
| 2040 | 5916 | 5928 | 5572 | 6353 | 5936 | 5938 | 5913 | 5913 | 5913 |
| 2041 | 6152 | 6156 | 5822 | 6560 | 6176 | 6175 | 6152 | 6152 | 6152 |
| 2042 | 6391 | 6393 | 6032 | 6782 | 6434 | 6370 | 6394 | 6394 | 6394 |
| 2043 | 6590 | 6591 | 6230 | 6990 | 6636 | 6550 | 6594 | 6594 | 6594 |
| 2044 | 6755 | 6759 | 6424 | 7183 | 6824 | 6742 | 6760 | 6760 | 6760 |
| 2045 | 6933 | 6922 | 6608 | 7288 | 6996 | 6956 | 6924 | 6924 | 6924 |
| 2046 | 7097 | 7071 | 6798 | 7636 | 7183 | 7174 | 7074 | 7074 | 7074 |
| 2047 | 7258 | 7255 | 7013 | 7976 | 7260 | 7318 | 7250 | 7250 | 7250 |
| 2048 | 7655 | 7652 | 7221 | 8263 | 7657 | 7682 | 7647 | 7647 | 7647 |
| 2049 | 7997 | 7994 | 7252 | 8487 | 7999 | 8005 | 7989 | 7989 | 7989 |
| 2050 | 8243 | 8240 | 7656 | 8646 | 8245 | 8254 | 8235 | 8235 | 8235 |
| 2051 | 8433 | 8430 | 7934 | 8753 | 8435 | 8433 | 8425 | 8425 | 8425 |
| 2052 | 8617 | 8614 | 8121 | 8844 | 8619 | 8577 | 8609 | 8609 | 8609 |
| 2053 | 8731 | 8728 | 8288 | 8915 | 8733 | 8678 | 8723 | 8723 | 8723 |
| 2054 | 8779 | 8776 | 8390 | 8964 | 8781 | 8729 | 8771 | 8771 | 8771 |
| 2055 | 8816 | 8813 | 8434 | 8993 | 8818 | 8766 | 8808 | 8808 | 8808 |
| 2056 | 8852 | 8849 | 8470 | 9017 | 8854 | 8803 | 8844 | 8844 | 8844 |
| 2057 | 8891 | 8888 | 8506 | 9033 | 8893 | 8829 | 8883 | 8883 | 8883 |
| 2058 | 8925 | 8922 | 8527 | 9046 | 8927 | 8849 | 8917 | 8917 | 8917 |
| 2059 | 8937 | 8934 | 8542 | 9048 | 8939 | 8863 | 8929 | 8929 | 8929 |

|      | 145  | 146  | 147  | 148  | 149  | 150  | 151  | 152  | 153  |
|------|------|------|------|------|------|------|------|------|------|
| 2060 | 8940 | 8937 | 8544 | 9049 | 8942 | 8865 | 8932 | 8932 | 8932 |
| 2061 | 8941 | 8938 | 8544 | 9049 | 8943 | 8865 | 8933 | 8933 | 8933 |
| 2062 | 8941 | 8938 | 8544 | 9049 | 8943 | 8865 | 8933 | 8933 | 8933 |
| 2063 | 8941 | 8938 | 8544 | 9049 | 8943 | 8865 | 8933 | 8933 | 8933 |
| 2064 | 8941 | 8938 | 8544 | 9049 | 8943 | 8865 | 8933 | 8933 | 8933 |
| 2065 | 8941 | 8938 | 8544 | 9049 | 8943 | 8865 | 8933 | 8933 | 8933 |
| 2066 | 8941 | 8938 | 8544 | 9049 | 8943 | 8865 | 8933 | 8933 | 8933 |
| 2067 | 8941 | 8938 | 8544 | 9049 | 8943 | 8865 | 8933 | 8933 | 8933 |
| 2068 | 8941 | 8938 | 8544 | 9049 | 8943 | 8865 | 8933 | 8933 | 8933 |
| 2069 | 8941 | 8938 | 8544 | 9049 | 8943 | 8865 | 8933 | 8933 | 8933 |
| 2070 | 8941 | 8938 | 8544 | 9049 | 8943 | 8865 | 8933 | 8933 | 8933 |
| 2071 | 8941 | 8938 | 8544 | 9049 | 8943 | 8865 | 8933 | 8933 | 8933 |
| 2072 | 8941 | 8938 | 8544 | 9049 | 8943 | 8865 | 8933 | 8933 | 8933 |
| 2073 | 8941 | 8938 | 8544 | 9049 | 8943 | 8865 | 8933 | 8933 | 8933 |
| 2074 | 8941 | 8938 | 8544 | 9049 | 8943 | 8865 | 8933 | 8933 | 8933 |
| 2075 | 8941 | 8938 | 8544 | 9049 | 8943 | 8865 | 8933 | 8933 | 8933 |
| 2076 | 8941 | 8938 | 8544 | 9049 | 8943 | 8865 | 8933 | 8933 | 8933 |
| 2077 | 8941 | 8938 | 8544 | 9049 | 8943 | 8865 | 8933 | 8933 | 8933 |
| 2078 | 8941 | 8938 | 8544 | 9049 | 8943 | 8865 | 8933 | 8933 | 8933 |
| 2079 | 8941 | 8938 | 8544 | 9049 | 8943 | 8865 | 8933 | 8933 | 8933 |
| 2080 | 8941 | 8938 | 8544 | 9049 | 8943 | 8865 | 8933 | 8933 | 8933 |
| 2081 | 8941 | 8938 | 8544 | 9049 | 8943 | 8865 | 8933 | 8933 | 8933 |
| 2082 | 8941 | 8938 | 8544 | 9049 | 8943 | 8865 | 8933 | 8933 | 8933 |
| 2083 | 8941 | 8938 | 8544 | 9049 | 8943 | 8865 | 8933 | 8933 | 8933 |
| 2084 | 8941 | 8938 | 8544 | 9049 | 8943 | 8865 | 8933 | 8933 | 8933 |
| 2085 | 8941 | 8938 | 8544 | 9049 | 8943 | 8865 | 8933 | 8933 | 8933 |
| 2086 | 8941 | 8938 | 8544 | 9049 | 8943 | 8865 | 8933 | 8933 | 8933 |
| 2087 | 8941 | 8938 | 8544 | 9049 | 8943 | 8865 | 8933 | 8933 | 8933 |
| 2088 | 8941 | 8938 | 8544 | 9049 | 8943 | 8865 | 8933 | 8933 | 8933 |
| 2089 | 8941 | 8938 | 8544 | 9049 | 8943 | 8865 | 8933 | 8933 | 8933 |
| 2090 | 8941 | 8938 | 8544 | 9049 | 8943 | 8865 | 8933 | 8933 | 8933 |
|      |      |      |      |      |      |      |      |      |      |

|      | 154  | 155  | 156  | 157  | 158  | 159  | 160  | 161  | 162  |
|------|------|------|------|------|------|------|------|------|------|
| 2002 | 0    | 0    | 0    | 0    | 0    | 0    | 0    | 0    | 0    |
| 2003 | 0    | 0    | 0    | 0    | 0    | 0    | 0    | 0    | 0    |
| 2004 | 1    | 1    | 1    | 1    | 1    | 1    | 1    | 1    | 1    |
| 2005 | 3    | 3    | 3    | 3    | 3    | 3    | 3    | 3    | 3    |
| 2006 | 14   | 14   | 14   | 14   | 14   | 14   | 14   | 14   | 14   |
| 2007 | 33   | 33   | 33   | 33   | 33   | 33   | 33   | 33   | 33   |
| 2008 | 67   | 67   | 67   | 67   | 67   | 67   | 67   | 67   | 67   |
| 2009 | 128  | 128  | 128  | 128  | 128  | 128  | 128  | 128  | 128  |
| 2010 | 210  | 210  | 210  | 210  | 210  | 210  | 210  | 210  | 210  |
| 2011 | 313  | 313  | 313  | 313  | 313  | 313  | 313  | 313  | 313  |
| 2012 | 418  | 418  | 418  | 418  | 418  | 418  | 418  | 418  | 418  |
| 2013 | 547  | 547  | 547  | 547  | 547  | 547  | 547  | 547  | 547  |
| 2014 | 665  | 665  | 665  | 665  | 665  | 665  | 665  | 665  | 665  |
| 2015 | 814  | 814  | 814  | 814  | 814  | 814  | 814  | 814  | 814  |
| 2016 | 957  | 957  | 957  | 957  | 957  | 957  | 957  | 957  | 957  |
| 2017 | 1109 | 1109 | 1109 | 1109 | 1109 | 1109 | 1109 | 1109 | 1109 |
| 2018 | 1276 | 1276 | 1276 | 1276 | 1276 | 1276 | 1276 | 1276 | 1276 |
| 2019 | 1449 | 1449 | 1449 | 1449 | 1449 | 1449 | 1449 | 1449 | 1449 |
| 2020 | 1622 | 1622 | 1622 | 1699 | 1622 | 1622 | 1622 | 1622 | 1622 |
| 2021 | 1808 | 1808 | 1808 | 1894 | 1808 | 1808 | 1808 | 1808 | 1808 |
| 2022 | 1974 | 1974 | 1974 | 2093 | 1974 | 1974 | 1974 | 1974 | 1974 |
| 2023 | 2164 | 2164 | 2164 | 2305 | 2164 | 2164 | 2164 | 2164 | 2164 |
| 2024 | 2363 | 2363 | 2363 | 2564 | 2363 | 2363 | 2363 | 2363 | 2363 |
| 2025 | 2613 | 2613 | 2555 | 2810 | 2613 | 2613 | 2613 | 2613 | 2613 |
| 2026 | 2773 | 2783 | 2738 | 3061 | 2778 | 2769 | 2769 | 2769 | 2769 |
| 2027 | 2948 | 2977 | 2931 | 3301 | 2956 | 2947 | 2947 | 2947 | 2947 |
| 2028 | 3153 | 3181 | 3125 | 3571 | 3161 | 3147 | 3150 | 3150 | 3150 |
| 2029 | 3346 | 3368 | 3297 | 3831 | 3354 | 3341 | 3344 | 3344 | 3344 |
| 2030 | 3570 | 3572 | 3547 | 4088 | 3565 | 3555 | 3559 | 3559 | 3559 |
| 2031 | 3799 | 3811 | 3714 | 4351 | 3799 | 3797 | 3798 | 3798 | 3798 |
| 2032 | 4024 | 4039 | 3869 | 4621 | 4034 | 4026 | 4027 | 4027 | 4027 |
| 2033 | 4258 | 4271 | 4070 | 4869 | 4262 | 4241 | 4256 | 4256 | 4256 |
| 2034 | 4533 | 4547 | 4308 | 5124 | 4530 | 4515 | 4532 | 4532 | 4532 |
| 2035 | 4813 | 4813 | 4503 | 5363 | 4794 | 4782 | 4802 | 4802 | 4802 |
| 2036 | 5048 | 5052 | 4668 | 5622 | 5034 | 5020 | 5048 | 5048 | 5048 |
| 2037 | 5291 | 5302 | 4863 | 5851 | 5274 | 5258 | 5298 | 5298 | 5298 |
| 2038 | 5534 | 5531 | 5116 | 6061 | 5498 | 5475 | 5532 | 5532 | 5532 |
| 2039 | 5767 | 5759 | 5350 | 6287 | 5735 | 5709 | 5762 | 5762 | 5762 |
| 2040 | 6032 | 6029 | 5576 | 6527 | 6010 | 5984 | 6028 | 6028 | 6028 |
| 2041 | 6282 | 6275 | 5828 | 6808 | 6265 | 6237 | 6282 | 6282 | 6282 |
| 2042 | 6562 | 6553 | 6049 | 7101 | 6560 | 6504 | 6569 | 6569 | 6569 |
| 2043 | 6783 | 6774 | 6254 | 7303 | 6794 | 6735 | 6790 | 6790 | 6790 |
| 2044 | 7020 | 7008 | 6468 | 7649 | 7027 | 6955 | 7019 | 7019 | 7019 |
| 2045 | 7254 | 7244 | 6687 | 7984 | 7248 | 7221 | 7255 | 7255 | 7255 |
| 2046 | 7626 | 7280 | 6916 | 8276 | 7252 | 7289 | 7627 | 7627 | 7627 |
| 2047 | 7958 | 7652 | 7161 | 8510 | 7624 | 7666 | 7959 | 7959 | 7959 |
| 2048 | 8213 | 7993 | 7264 | 8675 | 7965 | 8013 | 8214 | 8214 | 8214 |
| 2049 | 8403 | 8239 | 7664 | 8784 | 8210 | 8258 | 8404 | 8404 | 8404 |
| 2050 | 8587 | 8429 | 7942 | 8875 | 8400 | 8420 | 8582 | 8582 | 8582 |
| 2051 | 8701 | 8612 | 8129 | 8944 | 8584 | 8554 | 8696 | 8696 | 8696 |
| 2052 | 8749 | 8726 | 8296 | 8992 | 8698 | 8658 | 8744 | 8744 | 8744 |
| 2053 | 8786 | 8775 | 8398 | 9021 | 8746 | 8706 | 8781 | 8781 | 8781 |
| 2054 | 8822 | 8812 | 8442 | 9045 | 8783 | 8743 | 8817 | 8817 | 8817 |
| 2055 | 8861 | 8848 | 8478 | 9063 | 8819 | 8781 | 8856 | 8856 | 8856 |
| 2056 | 8895 | 8886 | 8514 | 9076 | 8858 | 8807 | 8890 | 8890 | 8890 |
| 2057 | 8907 | 8919 | 8535 | 9078 | 8892 | 8828 | 8902 | 8902 | 8902 |
| 2058 | 8910 | 8932 | 8550 | 9079 | 8904 | 8828 | 8905 | 8905 | 8905 |
| 2059 | 8911 | 8935 | 8552 | 9079 | 8907 | 8828 | 8906 | 8906 | 8906 |

|      | 154  | 155  | 156  | 157  | 158  | 159  | 160  | 161  | 162  |
|------|------|------|------|------|------|------|------|------|------|
| 2060 | 8911 | 8936 | 8552 | 9079 | 8908 | 8828 | 8906 | 8906 | 8906 |
| 2061 | 8911 | 8936 | 8552 | 9079 | 8908 | 8828 | 8906 | 8906 | 8906 |
| 2062 | 8911 | 8936 | 8552 | 9079 | 8908 | 8828 | 8906 | 8906 | 8906 |
| 2063 | 8911 | 8936 | 8552 | 9079 | 8908 | 8828 | 8906 | 8906 | 8906 |
| 2064 | 8911 | 8936 | 8552 | 9079 | 8908 | 8828 | 8906 | 8906 | 8906 |
| 2065 | 8911 | 8936 | 8552 | 9079 | 8908 | 8828 | 8906 | 8906 | 8906 |
| 2066 | 8911 | 8936 | 8552 | 9079 | 8908 | 8828 | 8906 | 8906 | 8906 |
| 2067 | 8911 | 8936 | 8552 | 9079 | 8908 | 8828 | 8906 | 8906 | 8906 |
| 2068 | 8911 | 8936 | 8552 | 9079 | 8908 | 8828 | 8906 | 8906 | 8906 |
| 2069 | 8911 | 8936 | 8552 | 9079 | 8908 | 8828 | 8906 | 8906 | 8906 |
| 2070 | 8911 | 8936 | 8552 | 9079 | 8908 | 8828 | 8906 | 8906 | 8906 |
| 2071 | 8911 | 8936 | 8552 | 9079 | 8908 | 8828 | 8906 | 8906 | 8906 |
| 2072 | 8911 | 8936 | 8552 | 9079 | 8908 | 8828 | 8906 | 8906 | 8906 |
| 2073 | 8911 | 8936 | 8552 | 9079 | 8908 | 8828 | 8906 | 8906 | 8906 |
| 2074 | 8911 | 8936 | 8552 | 9079 | 8908 | 8828 | 8906 | 8906 | 8906 |
| 2075 | 8911 | 8936 | 8552 | 9079 | 8908 | 8828 | 8906 | 8906 | 8906 |
| 2076 | 8911 | 8936 | 8552 | 9079 | 8908 | 8828 | 8906 | 8906 | 8906 |
| 2077 | 8911 | 8936 | 8552 | 9079 | 8908 | 8828 | 8906 | 8906 | 8906 |
| 2078 | 8911 | 8936 | 8552 | 9079 | 8908 | 8828 | 8906 | 8906 | 8906 |
| 2079 | 8911 | 8936 | 8552 | 9079 | 8908 | 8828 | 8906 | 8906 | 8906 |
| 2080 | 8911 | 8936 | 8552 | 9079 | 8908 | 8828 | 8906 | 8906 | 8906 |
| 2081 | 8911 | 8936 | 8552 | 9079 | 8908 | 8828 | 8906 | 8906 | 8906 |
| 2082 | 8911 | 8936 | 8552 | 9079 | 8908 | 8828 | 8906 | 8906 | 8906 |
| 2083 | 8911 | 8936 | 8552 | 9079 | 8908 | 8828 | 8906 | 8906 | 8906 |
| 2084 | 8911 | 8936 | 8552 | 9079 | 8908 | 8828 | 8906 | 8906 | 8906 |
| 2085 | 8911 | 8936 | 8552 | 9079 | 8908 | 8828 | 8906 | 8906 | 8906 |
| 2086 | 8911 | 8936 | 8552 | 9079 | 8908 | 8828 | 8906 | 8906 | 8906 |
| 2087 | 8911 | 8936 | 8552 | 9079 | 8908 | 8828 | 8906 | 8906 | 8906 |
| 2088 | 8911 | 8936 | 8552 | 9079 | 8908 | 8828 | 8906 | 8906 | 8906 |
| 2089 | 8911 | 8936 | 8552 | 9079 | 8908 | 8828 | 8906 | 8906 | 8906 |
| 2090 | 8911 | 8936 | 8552 | 9079 | 8908 | 8828 | 8906 | 8906 | 8906 |
|      |      |      |      |      |      |      |      |      |      |

|      | 1 | 2 | 3 | 4 | 5 | 6 | 7 | 8 | 9 | 10 | 11 |
|------|---|---|---|---|---|---|---|---|---|----|----|
| 2002 | 0 | 0 | 0 | 0 | 0 | 0 | 0 | 0 | 0 | 0  | 0  |
| 2003 | 0 | 0 | 0 | 0 | 0 | 0 | 0 | 0 | 0 | 0  | 0  |
| 2004 | 0 | 0 | 0 | 0 | 0 | 0 | 0 | 0 | 0 | 0  | 0  |
| 2005 | 0 | 0 | 0 | 0 | 0 | 0 | 0 | 0 | 0 | 0  | 0  |
| 2006 | 0 | 0 | 0 | 0 | 0 | 0 | 0 | 0 | 0 | 0  | 0  |
| 2007 | 0 | 0 | 0 | 0 | 0 | 0 | 0 | 0 | 0 | 0  | 0  |
| 2008 | 0 | 0 | 0 | 0 | 0 | 0 | 0 | 0 | 0 | 0  | 0  |
| 2009 | 0 | 0 | 0 | 0 | 0 | 0 | 0 | 0 | 0 | 0  | 0  |
| 2010 | 0 | 0 | 0 | 0 | 0 | 0 | 0 | 0 | 0 | 0  | 0  |
| 2011 | 0 | 0 | 0 | 0 | 0 | 0 | 0 | 0 | 0 | 0  | 0  |
| 2012 | 0 | 0 | 0 | 0 | 0 | 0 | 0 | 0 | 0 | 0  | 0  |
| 2013 | 0 | 0 | 0 | 0 | 0 | 0 | 0 | 0 | 0 | 0  | 0  |
| 2014 | 0 | 0 | 0 | 0 | 0 | 0 | 0 | 0 | 0 | 0  | 0  |
| 2015 | 0 | 0 | 0 | 0 | 0 | 0 | 0 | 0 | 0 | 0  | 0  |
| 2016 | 0 | 0 | 0 | 0 | 0 | 0 | 0 | 0 | 0 | 0  | 0  |
| 2017 | 0 | 0 | 0 | 0 | 0 | 0 | 0 | 0 | 0 | 0  | 0  |
| 2018 | 0 | 0 | 0 | 0 | 0 | 0 | 0 | 0 | 0 | 0  | 0  |
| 2019 | 0 | 0 | 0 | 0 | 0 | 0 | 0 | 0 | 0 | 0  | 0  |
| 2020 | 0 | 0 | 0 | 0 | 0 | 0 | 0 | 0 | 0 | 0  | 0  |
| 2021 | 0 | 0 | 0 | 0 | 0 | 0 | 0 | 0 | 0 | 0  | 0  |
| 2022 | 0 | 0 | 0 | 0 | 0 | 0 | 0 | 0 | 0 | 0  | 0  |
| 2023 | 0 | 0 | 0 | 0 | 0 | 0 | 0 | 0 | 0 | 0  | 0  |
| 2024 | 0 | 0 | 0 | 0 | 0 | 0 | 0 | 0 | 0 | 0  | 0  |
| 2025 | 0 | 0 | 0 | 0 | 0 | 0 | 0 | 0 | 0 | 0  | 0  |
| 2026 | 0 | 0 | 0 | 0 | 0 | 0 | 0 | 0 | 0 | 0  | 0  |
| 2027 | 0 | 0 | 0 | 0 | 0 | 0 | 0 | 0 | 0 | 0  | 0  |
| 2028 | 0 | 0 | 0 | 0 | 0 | 0 | 0 | 0 | 0 | 0  | 0  |
| 2029 | 0 | 0 | 0 | 0 | 0 | 0 | 0 | 0 | 0 | 0  | 0  |
| 2030 | 0 | 0 | 0 | 0 | 0 | 0 | 0 | 0 | 0 | 0  | 0  |
| 2031 | 0 | 0 | 0 | 0 | 0 | 0 | 0 | 0 | 0 | 0  | 0  |
| 2032 | 0 | 0 | 0 | 0 | 0 | 0 | 0 | 0 | 0 | 0  | 0  |
| 2033 | 0 | 0 | 0 | 0 | 0 | 0 | 0 | 0 | 0 | 0  | 0  |
| 2034 | 0 | 0 | 0 | 0 | 0 | 0 | 0 | 0 | 0 | 0  | 0  |
| 2035 | 0 | 0 | 0 | 0 | 0 | 0 | 0 | 0 | 0 | 0  | 0  |
| 2036 | 0 | 0 | 0 | 0 | 0 | 0 | 0 | 0 | 0 | 0  | 0  |
| 2037 | 0 | 0 | 0 | 0 | 0 | 0 | 0 | 0 | 0 | 0  | 0  |
| 2038 | 0 | 0 | 0 | 0 | 0 | 0 | 0 | 0 | 0 | 0  | 0  |
| 2039 | 0 | 0 | 0 | 0 | 0 | 0 | 0 | 0 | 0 | 0  | 0  |
| 2040 | 0 | 0 | 0 | 0 | 0 | 0 | 0 | 0 | 0 | 0  | 0  |
| 2041 | 0 | 0 | 0 | 0 | 0 | 0 | 0 | 0 | 0 | 0  | 0  |
| 2042 | 0 | 0 | 0 | 0 | 0 | 0 | 0 | 0 | 0 | 0  | 0  |
| 2043 | 0 | 0 | 0 | 0 | 0 | 0 | 0 | 0 | 0 | 0  | 0  |
| 2044 | 0 | 0 | 0 | 0 | 0 | 0 | 0 | 0 | 0 | 0  | 0  |
| 2045 | 0 | 0 | 0 | 0 | 0 | 0 | 0 | 0 | 0 | 0  | 0  |
| 2046 | 0 | 0 | 0 | 0 | 0 | 0 | 0 | 0 | 0 | 0  | 0  |
| 2047 | 0 | 0 | 0 | 0 | 0 | 0 | 0 | 0 | 0 | 0  | 0  |
| 2048 | 0 | 0 | 0 | 0 | 0 | 0 | 0 | 0 | 0 | 0  | 0  |
| 2049 | 0 | 0 | 0 | 0 | 0 | 0 | 0 | 0 | 0 | 0  | 0  |
| 2050 | 0 | 0 | 0 | 0 | 0 | 0 | 0 | 0 | 0 | 0  | 0  |
| 2051 | 0 | 0 | 0 | 0 | 0 | 0 | 0 | 0 | 0 | 0  | 0  |
| 2052 | 0 | 0 | 0 | 0 | 0 | 0 | 0 | 0 | 0 | 0  | 0  |
| 2053 | 0 | 0 | 0 | 0 | 0 | 0 | 0 | 0 | 0 | 0  | 0  |
| 2054 | 0 | 0 | 0 | 0 | 0 | 0 | 0 | 0 | 0 | 0  | 0  |
| 2055 | 0 | 0 | 0 | 0 | 0 | 0 | 0 | 0 | 0 | 0  | 0  |
| 2056 | 0 | 0 | 0 | 0 | 0 | 0 | 0 | 0 | 0 | 0  | 0  |
| 2057 | 0 | 0 | 0 | 0 | 0 | 0 | 0 | 0 | 0 | 0  | 0  |
| 2058 | 0 | 0 | 0 | 0 | 0 | 0 | 0 | 0 | 0 | 0  | 0  |
| 2059 | 0 | 0 | 0 | 0 | 0 | 0 | 0 | 0 | 0 | 0  | 0  |

|      | 1 | 2 | 3 | 4 | 5 | 6 | 7 | 8 | 9 | 10 | 11 |
|------|---|---|---|---|---|---|---|---|---|----|----|
| 2060 | 0 | 0 | 0 | 0 | 0 | 0 | 0 | 0 | 0 | 0  | 0  |
| 2061 | 0 | 0 | 0 | 0 | 0 | 0 | 0 | 0 | 0 | 0  | 0  |
| 2062 | 0 | 0 | 0 | 0 | 0 | 0 | 0 | 0 | 0 | 0  | 0  |
| 2063 | 0 | 0 | 0 | 0 | 0 | 0 | 0 | 0 | 0 | 0  | 0  |
| 2064 | 0 | 0 | 0 | 0 | 0 | 0 | 0 | 0 | 0 | 0  | 0  |
| 2065 | 0 | 0 | 0 | 0 | 0 | 0 | 0 | 0 | 0 | 0  | 0  |
| 2066 | 0 | 0 | 0 | 0 | 0 | 0 | 0 | 0 | 0 | 0  | 0  |
| 2067 | 0 | 0 | 0 | 0 | 0 | 0 | 0 | 0 | 0 | 0  | 0  |
| 2068 | 0 | 0 | 0 | 0 | 0 | 0 | 0 | 0 | 0 | 0  | 0  |
| 2069 | 0 | 0 | 0 | 0 | 0 | 0 | 0 | 0 | 0 | 0  | 0  |
| 2070 | 0 | 0 | 0 | 0 | 0 | 0 | 0 | 0 | 0 | 0  | 0  |
| 2071 | 0 | 0 | 0 | 0 | 0 | 0 | 0 | 0 | 0 | 0  | 0  |
| 2072 | 0 | 0 | 0 | 0 | 0 | 0 | 0 | 0 | 0 | 0  | 0  |
| 2073 | 0 | 0 | 0 | 0 | 0 | 0 | 0 | 0 | 0 | 0  | 0  |
| 2074 | 0 | 0 | 0 | 0 | 0 | 0 | 0 | 0 | 0 | 0  | 0  |
| 2075 | 0 | 0 | 0 | 0 | 0 | 0 | 0 | 0 | 0 | 0  | 0  |
| 2076 | 0 | 0 | 0 | 0 | 0 | 0 | 0 | 0 | 0 | 0  | 0  |
| 2077 | 0 | 0 | 0 | 0 | 0 | 0 | 0 | 0 | 0 | 0  | 0  |
| 2078 | 0 | 0 | 0 | 0 | 0 | 0 | 0 | 0 | 0 | 0  | 0  |
| 2079 | 0 | 0 | 0 | 0 | 0 | 0 | 0 | 0 | 0 | 0  | 0  |
| 2080 | 0 | 0 | 0 | 0 | 0 | 0 | 0 | 0 | 0 | 0  | 0  |
| 2081 | 0 | 0 | 0 | 0 | 0 | 0 | 0 | 0 | 0 | 0  | 0  |
| 2082 | 0 | 0 | 0 | 0 | 0 | 0 | 0 | 0 | 0 | 0  | 0  |
| 2083 | 0 | 0 | 0 | 0 | 0 | 0 | 0 | 0 | 0 | 0  | 0  |
| 2084 | 0 | 0 | 0 | 0 | 0 | 0 | 0 | 0 | 0 | 0  | 0  |
| 2085 | 0 | 0 | 0 | 0 | 0 | 0 | 0 | 0 | 0 | 0  | 0  |
| 2086 | 0 | 0 | 0 | 0 | 0 | 0 | 0 | 0 | 0 | 0  | 0  |
| 2087 | 0 | 0 | 0 | 0 | 0 | 0 | 0 | 0 | 0 | 0  | 0  |
| 2088 | 0 | 0 | 0 | 0 | 0 | 0 | 0 | 0 | 0 | 0  | 0  |
| 2089 | 0 | 0 | 0 | 0 | 0 | 0 | 0 | 0 | 0 | 0  | 0  |
| 2090 | 0 | 0 | 0 | 0 | 0 | 0 | 0 | 0 | 0 | 0  | 0  |



|      | 12 | 13 | 14 | 15 | 16 | 17 | 18 | 19 | 20 | 21 | 22 |
|------|----|----|----|----|----|----|----|----|----|----|----|
| 2002 | 0  | 0  | 0  | 0  | 0  | 0  | 0  | 0  | 0  | 0  | 0  |
| 2003 | 0  | 0  | 0  | 0  | 0  | 0  | 0  | 0  | 0  | 0  | 0  |
| 2004 | 0  | 0  | 0  | 0  | 0  | 0  | 0  | 0  | 0  | 0  | 0  |
| 2005 | 0  | 0  | 0  | 0  | 0  | 0  | 0  | 0  | 0  | 0  | 0  |
| 2006 | 0  | 0  | 0  | 0  | 0  | 0  | 0  | 0  | 0  | 0  | 0  |
| 2007 | 0  | 0  | 0  | 0  | 0  | 0  | 0  | 0  | 0  | 0  | 0  |
| 2008 | 0  | 0  | 0  | 0  | 0  | 0  | 0  | 0  | 0  | 0  | 0  |
| 2009 | 0  | 0  | 0  | 0  | 0  | 0  | 0  | 0  | 0  | 0  | 0  |
| 2010 | 0  | 0  | 0  | 0  | 0  | 0  | 0  | 0  | 0  | 0  | 0  |
| 2011 | 0  | 0  | 0  | 0  | 0  | 0  | 0  | 0  | 0  | 0  | 0  |
| 2012 | 0  | 0  | 0  | 0  | 0  | 0  | 0  | 0  | 0  | 0  | 0  |
| 2013 | 0  | 0  | 0  | 0  | 0  | 0  | 0  | 0  | 0  | 0  | 0  |
| 2014 | 0  | 0  | 0  | 0  | 0  | 0  | 0  | 0  | 0  | 0  | 0  |
| 2015 | 0  | 0  | 0  | 0  | 0  | 0  | 0  | 0  | 0  | 0  | 0  |
| 2016 | 0  | 0  | 0  | 0  | 0  | 0  | 0  | 0  | 0  | 0  | 0  |
| 2017 | 0  | 0  | 0  | 0  | 0  | 0  | 0  | 0  | 0  | 0  | 0  |
| 2018 | 0  | 0  | 0  | 0  | 0  | 0  | 0  | 0  | 0  | 0  | 0  |
| 2019 | 0  | 0  | 0  | 0  | 0  | 0  | 0  | 0  | 0  | 0  | 0  |
| 2020 | 0  | 0  | 0  | 0  | 0  | 0  | 0  | 0  | 0  | 0  | 0  |
| 2021 | 0  | 0  | 0  | 0  | 0  | 0  | 0  | 0  | 0  | 0  | 4  |
| 2022 | 0  | 0  | 0  | 0  | 0  | 0  | 0  | 0  | 0  | 0  | 4  |
| 2023 | 0  | 0  | 0  | 0  | 0  | 0  | 0  | 0  | 0  | 0  | 8  |
| 2024 | 0  | 0  | 0  | 0  | 0  | 0  | 0  | 0  | 0  | 0  | 7  |
| 2025 | 0  | 0  | 0  | 0  | 0  | 0  | 0  | 0  | 0  | 0  | 7  |
| 2026 | 0  | 0  | 0  | 0  | 0  | 0  | 0  | 0  | 0  | 0  | 3  |
| 2027 | 0  | 0  | 0  | 0  | 0  | 6  | 0  | 2  | 0  | 0  | 2  |
| 2028 | 0  | 0  | 0  | 0  | 0  | 6  | 0  | 0  | 0  | 0  | 0  |
| 2029 | 0  | 0  | 0  | 0  | 0  | 5  | 0  | 5  | 0  | 0  | 0  |
| 2030 | 0  | 0  | 0  | 0  | 0  | 5  | 0  | 5  | 0  | 0  | 0  |
| 2031 | 0  | 0  | 0  | 0  | 0  | 5  | 0  | 3  | 0  | 0  | 0  |
| 2032 | 0  | 0  | 0  | 0  | 0  | 4  | 0  | 2  | 0  | 0  | 0  |
| 2033 | 0  | 0  | 0  | 0  | 0  | 2  | 0  | 0  | 0  | 0  | 0  |
| 2034 | 0  | 0  | 0  | 0  | 0  | 2  | 0  | 0  | 0  | 0  | 0  |
| 2035 | 0  | 0  | 0  | 0  | 0  | 0  | 0  | 0  | 0  | 0  | 0  |
| 2036 | 0  | 0  | 0  | 0  | 0  | 0  | 0  | 0  | 0  | 0  | 0  |
| 2037 | 0  | 0  | 0  | 0  | 0  | 0  | 0  | 0  | 0  | 0  | 0  |
| 2038 | 0  | 0  | 0  | 0  | 0  | 0  | 0  | 0  | 0  | 0  | 0  |
| 2039 | 0  | 0  | 0  | 0  | 0  | 0  | 0  | 0  | 0  | 0  | 0  |
| 2040 | 0  | 0  | 0  | 0  | 0  | 0  | 0  | 0  | 0  | 0  | 0  |
| 2041 | 0  | 0  | 0  | 0  | 0  | 0  | 0  | 0  | 0  | 0  | 0  |
| 2042 | 0  | 0  | 0  | 0  | 0  | 0  | 0  | 0  | 0  | 0  | 0  |
| 2043 | 0  | 0  | 0  | 0  | 0  | 0  | 0  | 0  | 0  | 0  | 0  |
| 2044 | 0  | 0  | 0  | 0  | 0  | 0  | 0  | 0  | 0  | 0  | 0  |
| 2045 | 0  | 0  | 0  | 0  | 0  | 0  | 0  | 0  | 0  | 0  | 0  |
| 2046 | 0  | 0  | 0  | 0  | 0  | 0  | 0  | 0  | 0  | 0  | 0  |
| 2047 | 0  | 0  | 0  | 0  | 0  | 0  | 0  | 0  | 0  | 0  | 0  |
| 2048 | 0  | 0  | 0  | 0  | 0  | 0  | 0  | 0  | 0  | 0  | 0  |
| 2049 | 0  | 0  | 0  | 0  | 0  | 0  | 0  | 0  | 0  | 0  | 0  |
| 2050 | 0  | 0  | 0  | 0  | 0  | 0  | 0  | 0  | 0  | 0  | 0  |
| 2051 | 0  | 0  | 0  | 0  | 0  | 0  | 0  | 0  | 0  | 0  | 0  |
| 2052 | 0  | 0  | 0  | 0  | 0  | 0  | 0  | 0  | 0  | 0  | 0  |
| 2053 | 0  | 0  | 0  | 0  | 0  | 0  | 0  | 0  | 0  | 0  | 0  |
| 2054 | 0  | 0  | 0  | 0  | 0  | 0  | 0  | 0  | 0  | 0  | 0  |
| 2055 | 0  | 0  | 0  | 0  | 0  | 0  | 0  | 0  | 0  | 0  | 0  |
| 2056 | 0  | 0  | 0  | 0  | 0  | 0  | 0  | 0  | 0  | 0  | 0  |
| 2057 | 0  | 0  | 0  | 0  | 0  | 0  | 0  | 0  | 0  | 0  | 0  |
| 2058 | 0  | 0  | 0  | 0  | 0  | 0  | 0  | 0  | 0  | 0  | 0  |
| 2059 | 0  | 0  | 0  | 0  | 0  | 0  | 0  | 0  | 0  | 0  | 0  |

|      | 12 | 13 | 14 | 15 | 16 | 17 | 18 | 19 | 20 | 21 | 22 |
|------|----|----|----|----|----|----|----|----|----|----|----|
| 2060 | 0  | 0  | 0  | 0  | 0  | 0  | 0  | 0  | 0  | 0  | 0  |
| 2061 | 0  | 0  | 0  | 0  | 0  | 0  | 0  | 0  | 0  | 0  | 0  |
| 2062 | 0  | 0  | 0  | 0  | 0  | 0  | 0  | 0  | 0  | 0  | 0  |
| 2063 | 0  | 0  | 0  | 0  | 0  | 0  | 0  | 0  | 0  | 0  | 0  |
| 2064 | 0  | 0  | 0  | 0  | 0  | 0  | 0  | 0  | 0  | 0  | 0  |
| 2065 | 0  | 0  | 0  | 0  | 0  | 0  | 0  | 0  | 0  | 0  | 0  |
| 2066 | 0  | 0  | 0  | 0  | 0  | 0  | 0  | 0  | 0  | 0  | 0  |
| 2067 | 0  | 0  | 0  | 0  | 0  | 0  | 0  | 0  | 0  | 0  | 0  |
| 2068 | 0  | 0  | 0  | 0  | 0  | 0  | 0  | 0  | 0  | 0  | 0  |
| 2069 | 0  | 0  | 0  | 0  | 0  | 0  | 0  | 0  | 0  | 0  | 0  |
| 2070 | 0  | 0  | 0  | 0  | 0  | 0  | 0  | 0  | 0  | 0  | 0  |
| 2071 | 0  | 0  | 0  | 0  | 0  | 0  | 0  | 0  | 0  | 0  | 0  |
| 2072 | 0  | 0  | 0  | 0  | 0  | 0  | 0  | 0  | 0  | 0  | 0  |
| 2073 | 0  | 0  | 0  | 0  | 0  | 0  | 0  | 0  | 0  | 0  | 0  |
| 2074 | 0  | 0  | 0  | 0  | 0  | 0  | 0  | 0  | 0  | 0  | 0  |
| 2075 | 0  | 0  | 0  | 0  | 0  | 0  | 0  | 0  | 0  | 0  | 0  |
| 2076 | 0  | 0  | 0  | 0  | 0  | 0  | 0  | 0  | 0  | 0  | 0  |
| 2077 | 0  | 0  | 0  | 0  | 0  | 0  | 0  | 0  | 0  | 0  | 0  |
| 2078 | 0  | 0  | 0  | 0  | 0  | 0  | 0  | 0  | 0  | 0  | 0  |
| 2079 | 0  | 0  | 0  | 0  | 0  | 0  | 0  | 0  | 0  | 0  | 0  |
| 2080 | 0  | 0  | 0  | 0  | 0  | 0  | 0  | 0  | 0  | 0  | 0  |
| 2081 | 0  | 0  | 0  | 0  | 0  | 0  | 0  | 0  | 0  | 0  | 0  |
| 2082 | 0  | 0  | 0  | 0  | 0  | 0  | 0  | 0  | 0  | 0  | 0  |
| 2083 | 0  | 0  | 0  | 0  | 0  | 0  | 0  | 0  | 0  | 0  | 0  |
| 2084 | 0  | 0  | 0  | 0  | 0  | 0  | 0  | 0  | 0  | 0  | 0  |
| 2085 | 0  | 0  | 0  | 0  | 0  | 0  | 0  | 0  | 0  | 0  | 0  |
| 2086 | 0  | 0  | 0  | 0  | 0  | 0  | 0  | 0  | 0  | 0  | 0  |
| 2087 | 0  | 0  | 0  | 0  | 0  | 0  | 0  | 0  | 0  | 0  | 0  |
| 2088 | 0  | 0  | 0  | 0  | 0  | 0  | 0  | 0  | 0  | 0  | 0  |
| 2089 | 0  | 0  | 0  | 0  | 0  | 0  | 0  | 0  | 0  | 0  | 0  |
| 2090 | 0  | 0  | 0  | 0  | 0  | 0  | 0  | 0  | 0  | 0  | 0  |

|      | 23 | 24 | 25 | 26 | 27 | 28 | 29 | 30 | 31 | 32 | 33 |
|------|----|----|----|----|----|----|----|----|----|----|----|
| 2002 | 0  | 0  | 0  | 0  | 0  | 0  | 0  | 0  | 0  | 0  | 0  |
| 2003 | 0  | 0  | 0  | 0  | 0  | 0  | 0  | 0  | 0  | 0  | 0  |
| 2004 | 0  | 0  | 0  | 0  | 0  | 0  | 0  | 0  | 0  | 0  | 0  |
| 2005 | 0  | 0  | 0  | 0  | 0  | 0  | 0  | 0  | 0  | 0  | 0  |
| 2006 | 0  | 0  | 0  | 0  | 0  | 0  | 0  | 0  | 0  | 0  | 0  |
| 2007 | 0  | 0  | 0  | 0  | 0  | 0  | 0  | 0  | 0  | 0  | 0  |
| 2008 | 0  | 0  | 0  | 0  | 0  | 0  | 0  | 0  | 0  | 0  | 0  |
| 2009 | 0  | 0  | 0  | 0  | 0  | 0  | 0  | 0  | 0  | 0  | 0  |
| 2010 | 0  | 0  | 0  | 0  | 0  | 0  | 0  | 0  | 0  | 0  | 0  |
| 2011 | 0  | 0  | 0  | 0  | 0  | 0  | 0  | 0  | 0  | 0  | 0  |
| 2012 | 0  | 0  | 0  | 0  | 0  | 0  | 0  | 0  | 0  | 0  | 0  |
| 2013 | 0  | 0  | 0  | 0  | 0  | 0  | 0  | 0  | 0  | 0  | 0  |
| 2014 | 0  | 0  | 0  | 0  | 0  | 0  | 0  | 0  | 0  | 0  | 0  |
| 2015 | 0  | 0  | 0  | 0  | 0  | 0  | 0  | 0  | 0  | 0  | 0  |
| 2016 | 0  | 0  | 0  | 0  | 0  | 0  | 0  | 0  | 0  | 0  | 0  |
| 2017 | 0  | 0  | 0  | 0  | 0  | 0  | 0  | 0  | 0  | 0  | 0  |
| 2018 | 0  | 0  | 0  | 0  | 0  | 0  | 0  | 0  | 0  | 0  | 0  |
| 2019 | 0  | 0  | 0  | 0  | 0  | 0  | 0  | 0  | 0  | 0  | 0  |
| 2020 | 0  | 0  | 0  | 0  | 0  | 0  | 0  | 0  | 0  | 0  | 0  |
| 2021 | 0  | 0  | 0  | 0  | 0  | 0  | 0  | 0  | 0  | 0  | 0  |
| 2022 | 0  | 0  | 0  | 0  | 0  | 0  | 0  | 0  | 0  | 0  | 0  |
| 2023 | 0  | 0  | 0  | 0  | 0  | 0  | 0  | 0  | 0  | 0  | 0  |
| 2024 | 0  | 0  | 0  | 0  | 0  | 0  | 0  | 0  | 0  | 0  | 0  |
| 2025 | 0  | 0  | 0  | 0  | 0  | 0  | 0  | 0  | 0  | 0  | 0  |
| 2026 | 0  | 0  | 0  | 0  | 0  | 0  | 0  | 0  | 0  | 0  | 0  |
| 2027 | 0  | 1  | 0  | 10 | 2  | 0  | 0  | 0  | 0  | 0  | 0  |
| 2028 | 0  | 0  | 0  | 10 | 0  | 0  | 0  | 0  | 0  | 0  | 0  |
| 2029 | 0  | 0  | 0  | 10 | 0  | 0  | 0  | 0  | 0  | 0  | 0  |
| 2030 | 0  | 0  | 0  | 10 | 0  | 0  | 0  | 0  | 0  | 0  | 0  |
| 2031 | 0  | 0  | 0  | 10 | 0  | 0  | 0  | 0  | 0  | 0  | 0  |
| 2032 | 0  | 0  | 0  | 10 | 0  | 0  | 0  | 0  | 0  | 0  | 0  |
| 2033 | 0  | 0  | 0  | 10 | 0  | 0  | 0  | 0  | 0  | 0  | 0  |
| 2034 | 0  | 0  | 0  | 10 | 0  | 0  | 0  | 0  | 0  | 0  | 0  |
| 2035 | 0  | 0  | 0  | 8  | 0  | 0  | 0  | 0  | 0  | 0  | 0  |
| 2036 | 0  | 0  | 0  | 7  | 0  | 0  | 0  | 0  | 0  | 0  | 0  |
| 2037 | 0  | 0  | 0  | 7  | 0  | 0  | 0  | 0  | 0  | 0  | 0  |
| 2038 | 0  | 0  | 0  | 3  | 0  | 0  | 0  | 0  | 0  | 0  | 0  |
| 2039 | 0  | 0  | 0  | 2  | 0  | 0  | 0  | 0  | 0  | 0  | 0  |
| 2040 | 0  | 0  | 0  | 0  | 0  | 0  | 0  | 0  | 0  | 0  | 0  |
| 2041 | 0  | 0  | 0  | 0  | 0  | 0  | 0  | 0  | 0  | 0  | 0  |
| 2042 | 0  | 0  | 0  | 0  | 0  | 0  | 0  | 0  | 0  | 0  | 0  |
| 2043 | 0  | 0  | 0  | 0  | 0  | 0  | 0  | 0  | 0  | 0  | 0  |
| 2044 | 0  | 0  | 0  | 0  | 0  | 0  | 0  | 0  | 0  | 0  | 0  |
| 2045 | 0  | 0  | 0  | 0  | 0  | 0  | 0  | 0  | 0  | 0  | 0  |
| 2046 | 0  | 0  | 0  | 0  | 0  | 0  | 0  | 0  | 0  | 0  | 0  |
| 2047 | 0  | 0  | 0  | 0  | 0  | 0  | 0  | 0  | 0  | 0  | 0  |
| 2048 | 0  | 0  | 0  | 0  | 0  | 0  | 0  | 0  | 0  | 0  | 0  |
| 2049 | 0  | 0  | 0  | 0  | 0  | 0  | 0  | 0  | 0  | 0  | 0  |
| 2050 | 0  | 0  | 0  | 0  | 0  | 0  | 0  | 0  | 0  | 0  | 0  |
| 2051 | 0  | 0  | 0  | 0  | 0  | 0  | 0  | 0  | 0  | 0  | 0  |
| 2052 | 0  | 0  | 0  | 0  | 0  | 0  | 0  | 0  | 0  | 0  | 0  |
| 2053 | 0  | 0  | 0  | 0  | 0  | 0  | 0  | 0  | 0  | 0  | 0  |
| 2054 | 0  | 0  | 0  | 0  | 0  | 0  | 0  | 0  | 0  | 0  | 0  |
| 2055 | 0  | 0  | 0  | 0  | 0  | 0  | 0  | 0  | 0  | 0  | 0  |
| 2056 | 0  | 0  | 0  | 0  | 0  | 0  | 0  | 0  | 0  | 0  | 0  |
| 2057 | 0  | 0  | 0  | 0  | 0  | 0  | 0  | 0  | 0  | 0  | 0  |
| 2058 | 0  | 0  | 0  | 0  | 0  | 0  | 0  | 0  | 0  | 0  | 0  |
| 2059 | 0  | 0  | 0  | 0  | 0  | 0  | 0  | 0  | 0  | 0  | 0  |

|      | 23 | 24 | 25 | 26 | 27 | 28 | 29 | 30 | 31 | 32 | 33 |
|------|----|----|----|----|----|----|----|----|----|----|----|
| 2060 | 0  | 0  | 0  | 0  | 0  | 0  | 0  | 0  | 0  | 0  | 0  |
| 2061 | 0  | 0  | 0  | 0  | 0  | 0  | 0  | 0  | 0  | 0  | 0  |
| 2062 | 0  | 0  | 0  | 0  | 0  | 0  | 0  | 0  | 0  | 0  | 0  |
| 2063 | 0  | 0  | 0  | 0  | 0  | 0  | 0  | 0  | 0  | 0  | 0  |
| 2064 | 0  | 0  | 0  | 0  | 0  | 0  | 0  | 0  | 0  | 0  | 0  |
| 2065 | 0  | 0  | 0  | 0  | 0  | 0  | 0  | 0  | 0  | 0  | 0  |
| 2066 | 0  | 0  | 0  | 0  | 0  | 0  | 0  | 0  | 0  | 0  | 0  |
| 2067 | 0  | 0  | 0  | 0  | 0  | 0  | 0  | 0  | 0  | 0  | 0  |
| 2068 | 0  | 0  | 0  | 0  | 0  | 0  | 0  | 0  | 0  | 0  | 0  |
| 2069 | 0  | 0  | 0  | 0  | 0  | 0  | 0  | 0  | 0  | 0  | 0  |
| 2070 | 0  | 0  | 0  | 0  | 0  | 0  | 0  | 0  | 0  | 0  | 0  |
| 2071 | 0  | 0  | 0  | 0  | 0  | 0  | 0  | 0  | 0  | 0  | 0  |
| 2072 | 0  | 0  | 0  | 0  | 0  | 0  | 0  | 0  | 0  | 0  | 0  |
| 2073 | 0  | 0  | 0  | 0  | 0  | 0  | 0  | 0  | 0  | 0  | 0  |
| 2074 | 0  | 0  | 0  | 0  | 0  | 0  | 0  | 0  | 0  | 0  | 0  |
| 2075 | 0  | 0  | 0  | 0  | 0  | 0  | 0  | 0  | 0  | 0  | 0  |
| 2076 | 0  | 0  | 0  | 0  | 0  | 0  | 0  | 0  | 0  | 0  | 0  |
| 2077 | 0  | 0  | 0  | 0  | 0  | 0  | 0  | 0  | 0  | 0  | 0  |
| 2078 | 0  | 0  | 0  | 0  | 0  | 0  | 0  | 0  | 0  | 0  | 0  |
| 2079 | 0  | 0  | 0  | 0  | 0  | 0  | 0  | 0  | 0  | 0  | 0  |
| 2080 | 0  | 0  | 0  | 0  | 0  | 0  | 0  | 0  | 0  | 0  | 0  |
| 2081 | 0  | 0  | 0  | 0  | 0  | 0  | 0  | 0  | 0  | 0  | 0  |
| 2082 | 0  | 0  | 0  | 0  | 0  | 0  | 0  | 0  | 0  | 0  | 0  |
| 2083 | 0  | 0  | 0  | 0  | 0  | 0  | 0  | 0  | 0  | 0  | 0  |
| 2084 | 0  | 0  | 0  | 0  | 0  | 0  | 0  | 0  | 0  | 0  | 0  |
| 2085 | 0  | 0  | 0  | 0  | 0  | 0  | 0  | 0  | 0  | 0  | 0  |
| 2086 | 0  | 0  | 0  | 0  | 0  | 0  | 0  | 0  | 0  | 0  | 0  |
| 2087 | 0  | 0  | 0  | 0  | 0  | 0  | 0  | 0  | 0  | 0  | 0  |
| 2088 | 0  | 0  | 0  | 0  | 0  | 0  | 0  | 0  | 0  | 0  | 0  |
| 2089 | 0  | 0  | 0  | 0  | 0  | 0  | 0  | 0  | 0  | 0  | 0  |
| 2090 | 0  | 0  | 0  | 0  | 0  | 0  | 0  | 0  | 0  | 0  | 0  |

|      | 34 | 35 | 36 | 37 | 38 | 39 | 40 | 41 | 42 | 43 | 44 |
|------|----|----|----|----|----|----|----|----|----|----|----|
| 2002 | 0  | 0  | 0  | 0  | 0  | 0  | 0  | 0  | 0  | 0  | 0  |
| 2003 | 0  | 0  | 0  | 0  | 0  | 0  | 0  | 0  | 0  | 0  | 0  |
| 2004 | 0  | 0  | 0  | 0  | 0  | 0  | 0  | 0  | 0  | 0  | 0  |
| 2005 | 0  | 0  | 0  | 0  | 0  | 0  | 0  | 0  | 0  | 0  | 0  |
| 2006 | 0  | 0  | 0  | 0  | 0  | 0  | 0  | 0  | 0  | 0  | 0  |
| 2007 | 0  | 0  | 0  | 0  | 0  | 0  | 0  | 0  | 0  | 0  | 0  |
| 2008 | 0  | 0  | 0  | 0  | 0  | 0  | 0  | 0  | 0  | 0  | 0  |
| 2009 | 0  | 0  | 0  | 0  | 0  | 0  | 0  | 0  | 0  | 0  | 0  |
| 2010 | 0  | 0  | 0  | 0  | 0  | 0  | 0  | 0  | 0  | 0  | 0  |
| 2011 | 0  | 0  | 0  | 0  | 0  | 0  | 0  | 0  | 0  | 0  | 0  |
| 2012 | 0  | 0  | 0  | 0  | 0  | 0  | 0  | 0  | 0  | 0  | 0  |
| 2013 | 0  | 0  | 0  | 0  | 0  | 0  | 0  | 0  | 0  | 0  | 0  |
| 2014 | 0  | 0  | 0  | 0  | 0  | 0  | 0  | 0  | 0  | 0  | 0  |
| 2015 | 0  | 0  | 0  | 0  | 0  | 0  | 0  | 0  | 0  | 0  | 0  |
| 2016 | 0  | 0  | 0  | 0  | 0  | 0  | 0  | 0  | 0  | 0  | 0  |
| 2017 | 0  | 0  | 0  | 0  | 0  | 0  | 0  | 0  | 0  | 0  | 0  |
| 2018 | 0  | 0  | 0  | 0  | 0  | 0  | 0  | 0  | 0  | 0  | 0  |
| 2019 | 0  | 0  | 0  | 0  | 0  | 0  | 0  | 0  | 0  | 0  | 0  |
| 2020 | 0  | 0  | 0  | 0  | 0  | 0  | 0  | 0  | 0  | 0  | 0  |
| 2021 | 0  | 0  | 0  | 0  | 0  | 0  | 0  | 0  | 0  | 0  | 0  |
| 2022 | 0  | 0  | 0  | 0  | 0  | 0  | 0  | 0  | 0  | 0  | 0  |
| 2023 | 0  | 0  | 0  | 0  | 0  | 0  | 0  | 0  | 0  | 0  | 0  |
| 2024 | 0  | 0  | 0  | 0  | 0  | 0  | 0  | 0  | 0  | 0  | 0  |
| 2025 | 0  | 0  | 0  | 0  | 0  | 0  | 0  | 0  | 0  | 0  | 0  |
| 2026 | 0  | 0  | 0  | 0  | 0  | 0  | 0  | 0  | 0  | 0  | 6  |
| 2027 | 0  | 0  | 0  | 0  | 0  | 0  | 0  | 0  | 0  | 0  | 7  |
| 2028 | 0  | 0  | 0  | 0  | 0  | 0  | 0  | 0  | 0  | 0  | 7  |
| 2029 | 0  | 0  | 0  | 0  | 0  | 0  | 0  | 0  | 0  | 0  | 5  |
| 2030 | 0  | 0  | 0  | 0  | 0  | 0  | 0  | 0  | 0  | 0  | 5  |
| 2031 | 0  | 0  | 0  | 0  | 0  | 0  | 0  | 0  | 0  | 0  | 5  |
| 2032 | 0  | 0  | 0  | 0  | 0  | 0  | 0  | 0  | 0  | 0  | 4  |
| 2033 | 0  | 0  | 0  | 0  | 0  | 0  | 0  | 0  | 0  | 0  | 2  |
| 2034 | 0  | 0  | 0  | 0  | 0  | 0  | 0  | 0  | 0  | 0  | 2  |
| 2035 | 0  | 0  | 0  | 0  | 0  | 0  | 0  | 0  | 0  | 0  | 0  |
| 2036 | 0  | 0  | 0  | 0  | 0  | 0  | 0  | 0  | 0  | 0  | 0  |
| 2037 | 0  | 0  | 0  | 0  | 0  | 0  | 0  | 0  | 0  | 0  | 0  |
| 2038 | 0  | 0  | 0  | 0  | 0  | 0  | 0  | 0  | 0  | 0  | 0  |
| 2039 | 0  | 0  | 0  | 0  | 0  | 0  | 0  | 0  | 0  | 0  | 0  |
| 2040 | 0  | 0  | 0  | 0  | 0  | 0  | 0  | 0  | 0  | 0  | 0  |
| 2041 | 0  | 0  | 0  | 0  | 0  | 0  | 0  | 0  | 0  | 0  | 0  |
| 2042 | 0  | 0  | 0  | 0  | 0  | 0  | 0  | 0  | 0  | 0  | 0  |
| 2043 | 0  | 0  | 0  | 0  | 0  | 0  | 0  | 0  | 0  | 0  | 0  |
| 2044 | 0  | 0  | 0  | 0  | 0  | 0  | 0  | 0  | 0  | 0  | 0  |
| 2045 | 0  | 0  | 0  | 0  | 0  | 0  | 0  | 0  | 0  | 0  | 0  |
| 2046 | 0  | 0  | 0  | 0  | 0  | 0  | 0  | 0  | 0  | 0  | 0  |
| 2047 | 0  | 0  | 0  | 0  | 0  | 0  | 0  | 0  | 0  | 0  | 0  |
| 2048 | 0  | 0  | 0  | 0  | 0  | 0  | 0  | 0  | 0  | 0  | 0  |
| 2049 | 0  | 0  | 0  | 0  | 0  | 0  | 0  | 0  | 0  | 0  | 0  |
| 2050 | 0  | 0  | 0  | 0  | 0  | 0  | 0  | 0  | 0  | 0  | 0  |
| 2051 | 0  | 0  | 0  | 0  | 0  | 0  | 0  | 0  | 0  | 0  | 0  |
| 2052 | 0  | 0  | 0  | 0  | 0  | 0  | 0  | 0  | 0  | 0  | 0  |
| 2053 | 0  | 0  | 0  | 0  | 0  | 0  | 0  | 0  | 0  | 0  | 0  |
| 2054 | 0  | 0  | 0  | 0  | 0  | 0  | 0  | 0  | 0  | 0  | 0  |
| 2055 | 0  | 0  | 0  | 0  | 0  | 0  | 0  | 0  | 0  | 0  | 0  |
| 2056 | 0  | 0  | 0  | 0  | 0  | 0  | 0  | 0  | 0  | 0  | 0  |
| 2057 | 0  | 0  | 0  | 0  | 0  | 0  | 0  | 0  | 0  | 0  | 0  |
| 2058 | 0  | 0  | 0  | 0  | 0  | 0  | 0  | 0  | 0  | 0  | 0  |
| 2059 | 0  | 0  | 0  | 0  | 0  | 0  | 0  | 0  | 0  | 0  | 0  |

|      | 34 | 35 | 36 | 37 | 38 | 39 | 40 | 41 | 42 | 43 | 44 |
|------|----|----|----|----|----|----|----|----|----|----|----|
| 2060 | 0  | 0  | 0  | 0  | 0  | 0  | 0  | 0  | 0  | 0  | 0  |
| 2061 | 0  | 0  | 0  | 0  | 0  | 0  | 0  | 0  | 0  | 0  | 0  |
| 2062 | 0  | 0  | 0  | 0  | 0  | 0  | 0  | 0  | 0  | 0  | 0  |
| 2063 | 0  | 0  | 0  | 0  | 0  | 0  | 0  | 0  | 0  | 0  | 0  |
| 2064 | 0  | 0  | 0  | 0  | 0  | 0  | 0  | 0  | 0  | 0  | 0  |
| 2065 | 0  | 0  | 0  | 0  | 0  | 0  | 0  | 0  | 0  | 0  | 0  |
| 2066 | 0  | 0  | 0  | 0  | 0  | 0  | 0  | 0  | 0  | 0  | 0  |
| 2067 | 0  | 0  | 0  | 0  | 0  | 0  | 0  | 0  | 0  | 0  | 0  |
| 2068 | 0  | 0  | 0  | 0  | 0  | 0  | 0  | 0  | 0  | 0  | 0  |
| 2069 | 0  | 0  | 0  | 0  | 0  | 0  | 0  | 0  | 0  | 0  | 0  |
| 2070 | 0  | 0  | 0  | 0  | 0  | 0  | 0  | 0  | 0  | 0  | 0  |
| 2071 | 0  | 0  | 0  | 0  | 0  | 0  | 0  | 0  | 0  | 0  | 0  |
| 2072 | 0  | 0  | 0  | 0  | 0  | 0  | 0  | 0  | 0  | 0  | 0  |
| 2073 | 0  | 0  | 0  | 0  | 0  | 0  | 0  | 0  | 0  | 0  | 0  |
| 2074 | 0  | 0  | 0  | 0  | 0  | 0  | 0  | 0  | 0  | 0  | 0  |
| 2075 | 0  | 0  | 0  | 0  | 0  | 0  | 0  | 0  | 0  | 0  | 0  |
| 2076 | 0  | 0  | 0  | 0  | 0  | 0  | 0  | 0  | 0  | 0  | 0  |
| 2077 | 0  | 0  | 0  | 0  | 0  | 0  | 0  | 0  | 0  | 0  | 0  |
| 2078 | 0  | 0  | 0  | 0  | 0  | 0  | 0  | 0  | 0  | 0  | 0  |
| 2079 | 0  | 0  | 0  | 0  | 0  | 0  | 0  | 0  | 0  | 0  | 0  |
| 2080 | 0  | 0  | 0  | 0  | 0  | 0  | 0  | 0  | 0  | 0  | 0  |
| 2081 | 0  | 0  | 0  | 0  | 0  | 0  | 0  | 0  | 0  | 0  | 0  |
| 2082 | 0  | 0  | 0  | 0  | 0  | 0  | 0  | 0  | 0  | 0  | 0  |
| 2083 | 0  | 0  | 0  | 0  | 0  | 0  | 0  | 0  | 0  | 0  | 0  |
| 2084 | 0  | 0  | 0  | 0  | 0  | 0  | 0  | 0  | 0  | 0  | 0  |
| 2085 | 0  | 0  | 0  | 0  | 0  | 0  | 0  | 0  | 0  | 0  | 0  |
| 2086 | 0  | 0  | 0  | 0  | 0  | 0  | 0  | 0  | 0  | 0  | 0  |
| 2087 | 0  | 0  | 0  | 0  | 0  | 0  | 0  | 0  | 0  | 0  | 0  |
| 2088 | 0  | 0  | 0  | 0  | 0  | 0  | 0  | 0  | 0  | 0  | 0  |
| 2089 | 0  | 0  | 0  | 0  | 0  | 0  | 0  | 0  | 0  | 0  | 0  |
| 2090 | 0  | 0  | 0  | 0  | 0  | 0  | 0  | 0  | 0  | 0  | 0  |

|      | 45 | 46 | 47 | 48 | 49 | 50 | 51 | 52 | 53 | 54 | 55 |
|------|----|----|----|----|----|----|----|----|----|----|----|
| 2002 | 0  | 0  | 0  | 0  | 0  | 0  | 0  | 0  | 0  | 0  | 0  |
| 2003 | 0  | 0  | 0  | 0  | 0  | 0  | 0  | 0  | 0  | 0  | 0  |
| 2004 | 0  | 0  | 0  | 0  | 0  | 0  | 0  | 0  | 0  | 0  | 0  |
| 2005 | 0  | 0  | 0  | 0  | 0  | 0  | 0  | 0  | 0  | 0  | 0  |
| 2006 | 0  | 0  | 0  | 0  | 0  | 0  | 0  | 0  | 0  | 0  | 0  |
| 2007 | 0  | 0  | 0  | 0  | 0  | 0  | 0  | 0  | 0  | 0  | 0  |
| 2008 | 0  | 0  | 0  | 0  | 0  | 0  | 0  | 0  | 0  | 0  | 0  |
| 2009 | 0  | 0  | 0  | 0  | 0  | 0  | 0  | 0  | 0  | 0  | 0  |
| 2010 | 0  | 0  | 0  | 0  | 0  | 0  | 0  | 0  | 0  | 0  | 0  |
| 2011 | 0  | 0  | 0  | 0  | 0  | 0  | 0  | 0  | 0  | 0  | 0  |
| 2012 | 0  | 0  | 0  | 0  | 0  | 0  | 0  | 0  | 0  | 0  | 0  |
| 2013 | 0  | 0  | 0  | 0  | 0  | 0  | 0  | 0  | 0  | 0  | 0  |
| 2014 | 0  | 0  | 0  | 0  | 0  | 0  | 0  | 0  | 0  | 0  | 0  |
| 2015 | 0  | 0  | 0  | 0  | 0  | 0  | 0  | 0  | 0  | 0  | 0  |
| 2016 | 0  | 0  | 0  | 0  | 0  | 0  | 0  | 0  | 0  | 0  | 0  |
| 2017 | 0  | 0  | 0  | 0  | 0  | 0  | 0  | 0  | 0  | 0  | 0  |
| 2018 | 0  | 0  | 0  | 0  | 0  | 0  | 0  | 0  | 0  | 0  | 0  |
| 2019 | 0  | 0  | 0  | 0  | 0  | 0  | 0  | 0  | 0  | 0  | 0  |
| 2020 | 0  | 0  | 0  | 0  | 0  | 0  | 0  | 0  | 0  | 0  | 0  |
| 2021 | 0  | 0  | 0  | 0  | 4  | 0  | 0  | 0  | 0  | 0  | 0  |
| 2022 | 0  | 0  | 0  | 0  | 4  | 0  | 0  | 0  | 0  | 0  | 0  |
| 2023 | 0  | 0  | 0  | 0  | 8  | 0  | 0  | 0  | 0  | 0  | 0  |
| 2024 | 0  | 0  | 0  | 0  | 7  | 0  | 0  | 0  | 0  | 0  | 0  |
| 2025 | 0  | 0  | 0  | 0  | 7  | 0  | 0  | 0  | 0  | 0  | 0  |
| 2026 | 0  | 0  | 0  | 0  | 3  | 0  | 0  | 0  | 5  | 0  | 0  |
| 2027 | 0  | 2  | 0  | 0  | 2  | 2  | 2  | 0  | 10 | 2  | 0  |
| 2028 | 0  | 0  | 0  | 0  | 0  | 0  | 0  | 0  | 10 | 0  | 0  |
| 2029 | 0  | 5  | 0  | 0  | 0  | 0  | 0  | 0  | 10 | 0  | 0  |
| 2030 | 0  | 5  | 0  | 0  | 0  | 0  | 0  | 0  | 10 | 0  | 0  |
| 2031 | 0  | 3  | 0  | 0  | 0  | 0  | 0  | 0  | 10 | 0  | 0  |
| 2032 | 0  | 2  | 0  | 0  | 0  | 0  | 0  | 0  | 12 | 0  | 0  |
| 2033 | 0  | 0  | 0  | 0  | 0  | 0  | 0  | 0  | 14 | 0  | 0  |
| 2034 | 0  | 0  | 0  | 0  | 0  | 0  | 0  | 0  | 10 | 0  | 0  |
| 2035 | 0  | 0  | 0  | 0  | 0  | 0  | 0  | 0  | 8  | 0  | 0  |
| 2036 | 0  | 0  | 0  | 0  | 0  | 0  | 0  | 0  | 7  | 0  | 0  |
| 2037 | 0  | 0  | 0  | 0  | 0  | 0  | 0  | 0  | 7  | 0  | 0  |
| 2038 | 0  | 0  | 0  | 0  | 0  | 0  | 0  | 0  | 3  | 0  | 0  |
| 2039 | 0  | 0  | 0  | 0  | 0  | 0  | 0  | 0  | 2  | 0  | 0  |
| 2040 | 0  | 0  | 0  | 0  | 0  | 0  | 0  | 0  | 0  | 0  | 0  |
| 2041 | 0  | 0  | 0  | 0  | 0  | 0  | 0  | 0  | 0  | 0  | 0  |
| 2042 | 0  | 0  | 0  | 0  | 0  | 0  | 0  | 0  | 0  | 0  | 0  |
| 2043 | 0  | 0  | 0  | 0  | 0  | 0  | 0  | 0  | 0  | 0  | 0  |
| 2044 | 0  | 0  | 0  | 0  | 0  | 0  | 0  | 0  | 0  | 0  | 0  |
| 2045 | 0  | 0  | 0  | 0  | 0  | 0  | 0  | 0  | 0  | 0  | 0  |
| 2046 | 0  | 0  | 0  | 0  | 0  | 0  | 0  | 0  | 0  | 0  | 0  |
| 2047 | 0  | 0  | 0  | 0  | 0  | 0  | 0  | 0  | 0  | 0  | 0  |
| 2048 | 0  | 0  | 0  | 0  | 0  | 0  | 0  | 0  | 0  | 0  | 0  |
| 2049 | 0  | 0  | 0  | 0  | 0  | 0  | 0  | 0  | 0  | 0  | 0  |
| 2050 | 0  | 0  | 0  | 0  | 0  | 0  | 0  | 0  | 0  | 0  | 0  |
| 2051 | 0  | 0  | 0  | 0  | 0  | 0  | 0  | 0  | 0  | 0  | 0  |
| 2052 | 0  | 0  | 0  | 0  | 0  | 0  | 0  | 0  | 0  | 0  | 0  |
| 2053 | 0  | 0  | 0  | 0  | 0  | 0  | 0  | 0  | 0  | 0  | 0  |
| 2054 | 0  | 0  | 0  | 0  | 0  | 0  | 0  | 0  | 0  | 0  | 0  |
| 2055 | 0  | 0  | 0  | 0  | 0  | 0  | 0  | 0  | 0  | 0  | 0  |
| 2056 | 0  | 0  | 0  | 0  | 0  | 0  | 0  | 0  | 0  | 0  | 0  |
| 2057 | 0  | 0  | 0  | 0  | 0  | 0  | 0  | 0  | 0  | 0  | 0  |
| 2058 | 0  | 0  | 0  | 0  | 0  | 0  | 0  | 0  | 0  | 0  | 0  |
| 2059 | 0  | 0  | 0  | 0  | 0  | 0  | 0  | 0  | 0  | 0  | 0  |

|      | 45 | 46 | 47 | 48 | 49 | 50 | 51 | 52 | 53 | 54 | 55 |
|------|----|----|----|----|----|----|----|----|----|----|----|
| 2060 | 0  | 0  | 0  | 0  | 0  | 0  | 0  | 0  | 0  | 0  | 0  |
| 2061 | 0  | 0  | 0  | 0  | 0  | 0  | 0  | 0  | 0  | 0  | 0  |
| 2062 | 0  | 0  | 0  | 0  | 0  | 0  | 0  | 0  | 0  | 0  | 0  |
| 2063 | 0  | 0  | 0  | 0  | 0  | 0  | 0  | 0  | 0  | 0  | 0  |
| 2064 | 0  | 0  | 0  | 0  | 0  | 0  | 0  | 0  | 0  | 0  | 0  |
| 2065 | 0  | 0  | 0  | 0  | 0  | 0  | 0  | 0  | 0  | 0  | 0  |
| 2066 | 0  | 0  | 0  | 0  | 0  | 0  | 0  | 0  | 0  | 0  | 0  |
| 2067 | 0  | 0  | 0  | 0  | 0  | 0  | 0  | 0  | 0  | 0  | 0  |
| 2068 | 0  | 0  | 0  | 0  | 0  | 0  | 0  | 0  | 0  | 0  | 0  |
| 2069 | 0  | 0  | 0  | 0  | 0  | 0  | 0  | 0  | 0  | 0  | 0  |
| 2070 | 0  | 0  | 0  | 0  | 0  | 0  | 0  | 0  | 0  | 0  | 0  |
| 2071 | 0  | 0  | 0  | 0  | 0  | 0  | 0  | 0  | 0  | 0  | 0  |
| 2072 | 0  | 0  | 0  | 0  | 0  | 0  | 0  | 0  | 0  | 0  | 0  |
| 2073 | 0  | 0  | 0  | 0  | 0  | 0  | 0  | 0  | 0  | 0  | 0  |
| 2074 | 0  | 0  | 0  | 0  | 0  | 0  | 0  | 0  | 0  | 0  | 0  |
| 2075 | 0  | 0  | 0  | 0  | 0  | 0  | 0  | 0  | 0  | 0  | 0  |
| 2076 | 0  | 0  | 0  | 0  | 0  | 0  | 0  | 0  | 0  | 0  | 0  |
| 2077 | 0  | 0  | 0  | 0  | 0  | 0  | 0  | 0  | 0  | 0  | 0  |
| 2078 | 0  | 0  | 0  | 0  | 0  | 0  | 0  | 0  | 0  | 0  | 0  |
| 2079 | 0  | 0  | 0  | 0  | 0  | 0  | 0  | 0  | 0  | 0  | 0  |
| 2080 | 0  | 0  | 0  | 0  | 0  | 0  | 0  | 0  | 0  | 0  | 0  |
| 2081 | 0  | 0  | 0  | 0  | 0  | 0  | 0  | 0  | 0  | 0  | 0  |
| 2082 | 0  | 0  | 0  | 0  | 0  | 0  | 0  | 0  | 0  | 0  | 0  |
| 2083 | 0  | 0  | 0  | 0  | 0  | 0  | 0  | 0  | 0  | 0  | 0  |
| 2084 | 0  | 0  | 0  | 0  | 0  | 0  | 0  | 0  | 0  | 0  | 0  |
| 2085 | 0  | 0  | 0  | 0  | 0  | 0  | 0  | 0  | 0  | 0  | 0  |
| 2086 | 0  | 0  | 0  | 0  | 0  | 0  | 0  | 0  | 0  | 0  | 0  |
| 2087 | 0  | 0  | 0  | 0  | 0  | 0  | 0  | 0  | 0  | 0  | 0  |
| 2088 | 0  | 0  | 0  | 0  | 0  | 0  | 0  | 0  | 0  | 0  | 0  |
| 2089 | 0  | 0  | 0  | 0  | 0  | 0  | 0  | 0  | 0  | 0  | 0  |
| 2090 | 0  | 0  | 0  | 0  | 0  | 0  | 0  | 0  | 0  | 0  | 0  |



|      | 56 | 57 | 58 | 59 | 60 | 61 | 62 | 63 | 64 | 65 | 66 |
|------|----|----|----|----|----|----|----|----|----|----|----|
| 2002 | 0  | 0  | 0  | 0  | 0  | 0  | 0  | 0  | 0  | 0  | 0  |
| 2003 | 0  | 0  | 0  | 0  | 0  | 0  | 0  | 0  | 0  | 0  | 0  |
| 2004 | 0  | 0  | 0  | 0  | 0  | 0  | 0  | 0  | 0  | 0  | 0  |
| 2005 | 0  | 0  | 0  | 0  | 0  | 0  | 0  | 0  | 0  | 0  | 0  |
| 2006 | 0  | 0  | 0  | 0  | 0  | 0  | 0  | 0  | 0  | 0  | 0  |
| 2007 | 0  | 0  | 0  | 0  | 0  | 0  | 0  | 0  | 0  | 0  | 0  |
| 2008 | 0  | 0  | 0  | 0  | 0  | 0  | 0  | 0  | 0  | 0  | 0  |
| 2009 | 0  | 0  | 0  | 0  | 0  | 0  | 0  | 0  | 0  | 0  | 0  |
| 2010 | 0  | 0  | 0  | 0  | 0  | 0  | 0  | 0  | 0  | 0  | 0  |
| 2011 | 0  | 0  | 0  | 0  | 0  | 0  | 0  | 0  | 0  | 0  | 0  |
| 2012 | 0  | 0  | 0  | 0  | 0  | 0  | 0  | 0  | 0  | 0  | 0  |
| 2013 | 0  | 0  | 0  | 0  | 0  | 0  | 0  | 0  | 0  | 0  | 0  |
| 2014 | 0  | 0  | 0  | 0  | 0  | 0  | 0  | 0  | 0  | 0  | 0  |
| 2015 | 0  | 0  | 0  | 0  | 0  | 0  | 0  | 0  | 0  | 0  | 0  |
| 2016 | 0  | 0  | 0  | 0  | 0  | 0  | 0  | 0  | 0  | 0  | 0  |
| 2017 | 0  | 0  | 0  | 0  | 0  | 0  | 0  | 0  | 0  | 0  | 0  |
| 2018 | 0  | 0  | 0  | 0  | 0  | 0  | 0  | 0  | 0  | 0  | 0  |
| 2019 | 0  | 0  | 0  | 0  | 0  | 0  | 0  | 0  | 0  | 0  | 0  |
| 2020 | 0  | 0  | 0  | 0  | 0  | 0  | 0  | 0  | 0  | 0  | 0  |
| 2021 | 0  | 0  | 0  | 0  | 0  | 0  | 0  | 0  | 0  | 0  | 0  |
| 2022 | 0  | 0  | 0  | 0  | 0  | 0  | 0  | 0  | 0  | 0  | 0  |
| 2023 | 0  | 0  | 0  | 0  | 0  | 0  | 0  | 0  | 0  | 0  | 0  |
| 2024 | 0  | 0  | 0  | 0  | 0  | 0  | 0  | 0  | 0  | 0  | 0  |
| 2025 | 0  | 0  | 0  | 0  | 0  | 0  | 0  | 0  | 0  | 0  | 0  |
| 2026 | 0  | 0  | 0  | 0  | 0  | 0  | 0  | 0  | 0  | 0  | 0  |
| 2027 | 0  | 0  | 0  | 0  | 0  | 0  | 0  | 0  | 0  | 0  | 0  |
| 2028 | 0  | 0  | 0  | 0  | 0  | 0  | 0  | 0  | 0  | 0  | 0  |
| 2029 | 0  | 0  | 0  | 0  | 0  | 0  | 0  | 0  | 0  | 0  | 0  |
| 2030 | 0  | 0  | 0  | 0  | 0  | 0  | 0  | 0  | 0  | 0  | 0  |
| 2031 | 0  | 0  | 0  | 0  | 0  | 0  | 0  | 0  | 0  | 0  | 0  |
| 2032 | 0  | 0  | 0  | 0  | 0  | 0  | 0  | 0  | 0  | 0  | 0  |
| 2033 | 0  | 0  | 0  | 0  | 0  | 0  | 0  | 0  | 0  | 0  | 0  |
| 2034 | 0  | 0  | 0  | 0  | 0  | 0  | 0  | 0  | 0  | 0  | 0  |
| 2035 | 0  | 0  | 0  | 0  | 0  | 0  | 0  | 0  | 0  | 0  | 0  |
| 2036 | 0  | 0  | 0  | 0  | 0  | 0  | 0  | 0  | 0  | 0  | 0  |
| 2037 | 0  | 0  | 0  | 0  | 0  | 0  | 0  | 0  | 0  | 0  | 0  |
| 2038 | 0  | 0  | 0  | 0  | 0  | 0  | 0  | 0  | 0  | 0  | 0  |
| 2039 | 0  | 0  | 0  | 0  | 0  | 0  | 0  | 0  | 0  | 0  | 0  |
| 2040 | 0  | 0  | 0  | 0  | 0  | 0  | 0  | 0  | 0  | 0  | 0  |
| 2041 | 0  | 0  | 0  | 0  | 0  | 0  | 0  | 0  | 0  | 0  | 0  |
| 2042 | 0  | 0  | 0  | 0  | 0  | 0  | 0  | 0  | 0  | 0  | 0  |
| 2043 | 0  | 0  | 0  | 0  | 0  | 0  | 0  | 0  | 0  | 0  | 0  |
| 2044 | 0  | 0  | 0  | 0  | 0  | 0  | 0  | 0  | 0  | 0  | 0  |
| 2045 | 0  | 0  | 0  | 0  | 0  | 0  | 0  | 0  | 0  | 0  | 0  |
| 2046 | 0  | 0  | 0  | 0  | 0  | 0  | 0  | 0  | 0  | 0  | 0  |
| 2047 | 0  | 0  | 0  | 0  | 0  | 0  | 0  | 0  | 0  | 0  | 0  |
| 2048 | 0  | 0  | 0  | 0  | 0  | 0  | 0  | 0  | 0  | 0  | 0  |
| 2049 | 0  | 0  | 0  | 0  | 0  | 0  | 0  | 0  | 0  | 0  | 0  |
| 2050 | 0  | 0  | 0  | 0  | 0  | 0  | 0  | 0  | 0  | 0  | 0  |
| 2051 | 0  | 0  | 0  | 0  | 0  | 0  | 0  | 0  | 0  | 0  | 0  |
| 2052 | 0  | 0  | 0  | 0  | 0  | 0  | 0  | 0  | 0  | 0  | 0  |
| 2053 | 0  | 0  | 0  | 0  | 0  | 0  | 0  | 0  | 0  | 0  | 0  |
| 2054 | 0  | 0  | 0  | 0  | 0  | 0  | 0  | 0  | 0  | 0  | 0  |
| 2055 | 0  | 0  | 0  | 0  | 0  | 0  | 0  | 0  | 0  | 0  | 0  |
| 2056 | 0  | 0  | 0  | 0  | 0  | 0  | 0  | 0  | 0  | 0  | 0  |
| 2057 | 0  | 0  | 0  | 0  | 0  | 0  | 0  | 0  | 0  | 0  | 0  |
| 2058 | 0  | 0  | 0  | 0  | 0  | 0  | 0  | 0  | 0  | 0  | 0  |
| 2059 | 0  | 0  | 0  | 0  | 0  | 0  | 0  | 0  | 0  | 0  | 0  |

|      | 56 | 57 | 58 | 59 | 60 | 61 | 62 | 63 | 64 | 65 | 66 |
|------|----|----|----|----|----|----|----|----|----|----|----|
| 2060 | 0  | 0  | 0  | 0  | 0  | 0  | 0  | 0  | 0  | 0  | 0  |
| 2061 | 0  | 0  | 0  | 0  | 0  | 0  | 0  | 0  | 0  | 0  | 0  |
| 2062 | 0  | 0  | 0  | 0  | 0  | 0  | 0  | 0  | 0  | 0  | 0  |
| 2063 | 0  | 0  | 0  | 0  | 0  | 0  | 0  | 0  | 0  | 0  | 0  |
| 2064 | 0  | 0  | 0  | 0  | 0  | 0  | 0  | 0  | 0  | 0  | 0  |
| 2065 | 0  | 0  | 0  | 0  | 0  | 0  | 0  | 0  | 0  | 0  | 0  |
| 2066 | 0  | 0  | 0  | 0  | 0  | 0  | 0  | 0  | 0  | 0  | 0  |
| 2067 | 0  | 0  | 0  | 0  | 0  | 0  | 0  | 0  | 0  | 0  | 0  |
| 2068 | 0  | 0  | 0  | 0  | 0  | 0  | 0  | 0  | 0  | 0  | 0  |
| 2069 | 0  | 0  | 0  | 0  | 0  | 0  | 0  | 0  | 0  | 0  | 0  |
| 2070 | 0  | 0  | 0  | 0  | 0  | 0  | 0  | 0  | 0  | 0  | 0  |
| 2071 | 0  | 0  | 0  | 0  | 0  | 0  | 0  | 0  | 0  | 0  | 0  |
| 2072 | 0  | 0  | 0  | 0  | 0  | 0  | 0  | 0  | 0  | 0  | 0  |
| 2073 | 0  | 0  | 0  | 0  | 0  | 0  | 0  | 0  | 0  | 0  | 0  |
| 2074 | 0  | 0  | 0  | 0  | 0  | 0  | 0  | 0  | 0  | 0  | 0  |
| 2075 | 0  | 0  | 0  | 0  | 0  | 0  | 0  | 0  | 0  | 0  | 0  |
| 2076 | 0  | 0  | 0  | 0  | 0  | 0  | 0  | 0  | 0  | 0  | 0  |
| 2077 | 0  | 0  | 0  | 0  | 0  | 0  | 0  | 0  | 0  | 0  | 0  |
| 2078 | 0  | 0  | 0  | 0  | 0  | 0  | 0  | 0  | 0  | 0  | 0  |
| 2079 | 0  | 0  | 0  | 0  | 0  | 0  | 0  | 0  | 0  | 0  | 0  |
| 2080 | 0  | 0  | 0  | 0  | 0  | 0  | 0  | 0  | 0  | 0  | 0  |
| 2081 | 0  | 0  | 0  | 0  | 0  | 0  | 0  | 0  | 0  | 0  | 0  |
| 2082 | 0  | 0  | 0  | 0  | 0  | 0  | 0  | 0  | 0  | 0  | 0  |
| 2083 | 0  | 0  | 0  | 0  | 0  | 0  | 0  | 0  | 0  | 0  | 0  |
| 2084 | 0  | 0  | 0  | 0  | 0  | 0  | 0  | 0  | 0  | 0  | 0  |
| 2085 | 0  | 0  | 0  | 0  | 0  | 0  | 0  | 0  | 0  | 0  | 0  |
| 2086 | 0  | 0  | 0  | 0  | 0  | 0  | 0  | 0  | 0  | 0  | 0  |
| 2087 | 0  | 0  | 0  | 0  | 0  | 0  | 0  | 0  | 0  | 0  | 0  |
| 2088 | 0  | 0  | 0  | 0  | 0  | 0  | 0  | 0  | 0  | 0  | 0  |
| 2089 | 0  | 0  | 0  | 0  | 0  | 0  | 0  | 0  | 0  | 0  | 0  |
| 2090 | 0  | 0  | 0  | 0  | 0  | 0  | 0  | 0  | 0  | 0  | 0  |

|      | 67 | 68 | 69 | 70 | 71 | 72 | 73 | 74 | 75 | 76 | 77 |
|------|----|----|----|----|----|----|----|----|----|----|----|
| 2002 | 0  | 0  | 0  | 0  | 0  | 0  | 0  | 0  | 0  | 0  | 0  |
| 2003 | 0  | 0  | 0  | 0  | 0  | 0  | 0  | 0  | 0  | 0  | 0  |
| 2004 | 0  | 0  | 0  | 0  | 0  | 0  | 0  | 0  | 0  | 0  | 0  |
| 2005 | 0  | 0  | 0  | 0  | 0  | 0  | 0  | 0  | 0  | 0  | 0  |
| 2006 | 0  | 0  | 0  | 0  | 0  | 0  | 0  | 0  | 0  | 0  | 0  |
| 2007 | 0  | 0  | 0  | 0  | 0  | 0  | 0  | 0  | 0  | 0  | 0  |
| 2008 | 0  | 0  | 0  | 0  | 0  | 0  | 0  | 0  | 0  | 0  | 0  |
| 2009 | 0  | 0  | 0  | 0  | 0  | 0  | 0  | 0  | 0  | 0  | 0  |
| 2010 | 0  | 0  | 0  | 0  | 0  | 0  | 0  | 0  | 0  | 0  | 0  |
| 2011 | 0  | 0  | 0  | 0  | 0  | 0  | 0  | 0  | 0  | 0  | 0  |
| 2012 | 0  | 0  | 0  | 0  | 0  | 0  | 0  | 0  | 0  | 0  | 0  |
| 2013 | 0  | 0  | 0  | 0  | 0  | 0  | 0  | 0  | 0  | 0  | 0  |
| 2014 | 0  | 0  | 0  | 0  | 0  | 0  | 0  | 0  | 0  | 0  | 0  |
| 2015 | 0  | 0  | 0  | 0  | 0  | 0  | 0  | 0  | 0  | 0  | 0  |
| 2016 | 0  | 0  | 0  | 0  | 0  | 0  | 0  | 0  | 0  | 0  | 0  |
| 2017 | 0  | 0  | 0  | 0  | 0  | 0  | 0  | 0  | 0  | 0  | 0  |
| 2018 | 0  | 0  | 0  | 0  | 0  | 0  | 0  | 0  | 0  | 0  | 0  |
| 2019 | 0  | 0  | 0  | 0  | 0  | 0  | 0  | 0  | 0  | 0  | 0  |
| 2020 | 0  | 0  | 0  | 0  | 0  | 0  | 0  | 0  | 0  | 0  | 0  |
| 2021 | 4  | 0  | 0  | 0  | 0  | 0  | 0  | 0  | 0  | 16 | 0  |
| 2022 | 4  | 0  | 0  | 0  | 0  | 0  | 0  | 0  | 0  | 12 | 0  |
| 2023 | 0  | 0  | 0  | 0  | 0  | 0  | 0  | 0  | 0  | 11 | 0  |
| 2024 | 0  | 0  | 0  | 0  | 0  | 0  | 0  | 0  | 0  | 7  | 0  |
| 2025 | 0  | 0  | 0  | 0  | 0  | 0  | 0  | 0  | 0  | 7  | 0  |
| 2026 | 0  | 0  | 0  | 0  | 1  | 0  | 6  | 0  | 0  | 3  | 0  |
| 2027 | 0  | 0  | 0  | 0  | 8  | 0  | 10 | 0  | 0  | 2  | 2  |
| 2028 | 0  | 0  | 0  | 0  | 9  | 0  | 5  | 0  | 0  | 0  | 0  |
| 2029 | 0  | 0  | 0  | 0  | 16 | 0  | 5  | 0  | 0  | 0  | 0  |
| 2030 | 0  | 0  | 0  | 0  | 12 | 0  | 5  | 0  | 0  | 0  | 0  |
| 2031 | 0  | 0  | 0  | 0  | 8  | 0  | 3  | 0  | 0  | 0  | 0  |
| 2032 | 0  | 0  | 0  | 0  | 7  | 0  | 2  | 0  | 0  | 0  | 0  |
| 2033 | 0  | 0  | 0  | 0  | 5  | 0  | 0  | 0  | 0  | 0  | 0  |
| 2034 | 0  | 0  | 0  | 0  | 5  | 0  | 0  | 0  | 0  | 0  | 0  |
| 2035 | 0  | 0  | 0  | 0  | 0  | 0  | 0  | 0  | 0  | 0  | 0  |
| 2036 | 0  | 0  | 0  | 0  | 0  | 0  | 0  | 0  | 0  | 0  | 0  |
| 2037 | 0  | 0  | 0  | 0  | 0  | 0  | 0  | 0  | 0  | 0  | 0  |
| 2038 | 0  | 0  | 0  | 0  | 0  | 0  | 0  | 0  | 0  | 0  | 0  |
| 2039 | 0  | 0  | 0  | 0  | 0  | 0  | 0  | 0  | 0  | 0  | 0  |
| 2040 | 0  | 0  | 0  | 0  | 0  | 0  | 0  | 0  | 0  | 0  | 0  |
| 2041 | 0  | 0  | 0  | 0  | 0  | 0  | 0  | 0  | 0  | 0  | 0  |
| 2042 | 0  | 0  | 0  | 0  | 0  | 0  | 0  | 0  | 0  | 0  | 0  |
| 2043 | 0  | 0  | 0  | 0  | 0  | 0  | 0  | 0  | 0  | 0  | 0  |
| 2044 | 0  | 0  | 0  | 0  | 0  | 0  | 0  | 0  | 0  | 0  | 0  |
| 2045 | 0  | 0  | 0  | 0  | 0  | 0  | 0  | 0  | 0  | 0  | 0  |
| 2046 | 0  | 0  | 0  | 0  | 0  | 0  | 0  | 0  | 0  | 0  | 0  |
| 2047 | 0  | 0  | 0  | 0  | 0  | 0  | 0  | 0  | 0  | 0  | 0  |
| 2048 | 0  | 0  | 0  | 0  | 0  | 0  | 0  | 0  | 0  | 0  | 0  |
| 2049 | 0  | 0  | 0  | 0  | 0  | 0  | 0  | 0  | 0  | 0  | 0  |
| 2050 | 0  | 0  | 0  | 0  | 0  | 0  | 0  | 0  | 0  | 0  | 0  |
| 2051 | 0  | 0  | 0  | 0  | 0  | 0  | 0  | 0  | 0  | 0  | 0  |
| 2052 | 0  | 0  | 0  | 0  | 0  | 0  | 0  | 0  | 0  | 0  | 0  |
| 2053 | 0  | 0  | 0  | 0  | 0  | 0  | 0  | 0  | 0  | 0  | 0  |
| 2054 | 0  | 0  | 0  | 0  | 0  | 0  | 0  | 0  | 0  | 0  | 0  |
| 2055 | 0  | 0  | 0  | 0  | 0  | 0  | 0  | 0  | 0  | 0  | 0  |
| 2056 | 0  | 0  | 0  | 0  | 0  | 0  | 0  | 0  | 0  | 0  | 0  |
| 2057 | 0  | 0  | 0  | 0  | 0  | 0  | 0  | 0  | 0  | 0  | 0  |
| 2058 | 0  | 0  | 0  | 0  | 0  | 0  | 0  | 0  | 0  | 0  | 0  |
| 2059 | 0  | 0  | 0  | 0  | 0  | 0  | 0  | 0  | 0  | 0  | 0  |

|      | 67 | 68 | 69 | 70 | 71 | 72 | 73 | 74 | 75 | 76 | 77 |
|------|----|----|----|----|----|----|----|----|----|----|----|
| 2060 | 0  | 0  | 0  | 0  | 0  | 0  | 0  | 0  | 0  | 0  | 0  |
| 2061 | 0  | 0  | 0  | 0  | 0  | 0  | 0  | 0  | 0  | 0  | 0  |
| 2062 | 0  | 0  | 0  | 0  | 0  | 0  | 0  | 0  | 0  | 0  | 0  |
| 2063 | 0  | 0  | 0  | 0  | 0  | 0  | 0  | 0  | 0  | 0  | 0  |
| 2064 | 0  | 0  | 0  | 0  | 0  | 0  | 0  | 0  | 0  | 0  | 0  |
| 2065 | 0  | 0  | 0  | 0  | 0  | 0  | 0  | 0  | 0  | 0  | 0  |
| 2066 | 0  | 0  | 0  | 0  | 0  | 0  | 0  | 0  | 0  | 0  | 0  |
| 2067 | 0  | 0  | 0  | 0  | 0  | 0  | 0  | 0  | 0  | 0  | 0  |
| 2068 | 0  | 0  | 0  | 0  | 0  | 0  | 0  | 0  | 0  | 0  | 0  |
| 2069 | 0  | 0  | 0  | 0  | 0  | 0  | 0  | 0  | 0  | 0  | 0  |
| 2070 | 0  | 0  | 0  | 0  | 0  | 0  | 0  | 0  | 0  | 0  | 0  |
| 2071 | 0  | 0  | 0  | 0  | 0  | 0  | 0  | 0  | 0  | 0  | 0  |
| 2072 | 0  | 0  | 0  | 0  | 0  | 0  | 0  | 0  | 0  | 0  | 0  |
| 2073 | 0  | 0  | 0  | 0  | 0  | 0  | 0  | 0  | 0  | 0  | 0  |
| 2074 | 0  | 0  | 0  | 0  | 0  | 0  | 0  | 0  | 0  | 0  | 0  |
| 2075 | 0  | 0  | 0  | 0  | 0  | 0  | 0  | 0  | 0  | 0  | 0  |
| 2076 | 0  | 0  | 0  | 0  | 0  | 0  | 0  | 0  | 0  | 0  | 0  |
| 2077 | 0  | 0  | 0  | 0  | 0  | 0  | 0  | 0  | 0  | 0  | 0  |
| 2078 | 0  | 0  | 0  | 0  | 0  | 0  | 0  | 0  | 0  | 0  | 0  |
| 2079 | 0  | 0  | 0  | 0  | 0  | 0  | 0  | 0  | 0  | 0  | 0  |
| 2080 | 0  | 0  | 0  | 0  | 0  | 0  | 0  | 0  | 0  | 0  | 0  |
| 2081 | 0  | 0  | 0  | 0  | 0  | 0  | 0  | 0  | 0  | 0  | 0  |
| 2082 | 0  | 0  | 0  | 0  | 0  | 0  | 0  | 0  | 0  | 0  | 0  |
| 2083 | 0  | 0  | 0  | 0  | 0  | 0  | 0  | 0  | 0  | 0  | 0  |
| 2084 | 0  | 0  | 0  | 0  | 0  | 0  | 0  | 0  | 0  | 0  | 0  |
| 2085 | 0  | 0  | 0  | 0  | 0  | 0  | 0  | 0  | 0  | 0  | 0  |
| 2086 | 0  | 0  | 0  | 0  | 0  | 0  | 0  | 0  | 0  | 0  | 0  |
| 2087 | 0  | 0  | 0  | 0  | 0  | 0  | 0  | 0  | 0  | 0  | 0  |
| 2088 | 0  | 0  | 0  | 0  | 0  | 0  | 0  | 0  | 0  | 0  | 0  |
| 2089 | 0  | 0  | 0  | 0  | 0  | 0  | 0  | 0  | 0  | 0  | 0  |
| 2090 | 0  | 0  | 0  | 0  | 0  | 0  | 0  | 0  | 0  | 0  | 0  |

|      | 78 | 79 | 80 | 81 | 82 | 83 | 84 | 85 | 86 | 87 | 88 |
|------|----|----|----|----|----|----|----|----|----|----|----|
| 2002 | 0  | 0  | 0  | 0  | 0  | 0  | 0  | 0  | 0  | 0  | 0  |
| 2003 | 0  | 0  | 0  | 0  | 0  | 0  | 0  | 0  | 0  | 0  | 0  |
| 2004 | 0  | 0  | 0  | 0  | 0  | 0  | 0  | 0  | 0  | 0  | 0  |
| 2005 | 0  | 0  | 0  | 0  | 0  | 0  | 0  | 0  | 0  | 0  | 0  |
| 2006 | 0  | 0  | 0  | 0  | 0  | 0  | 0  | 0  | 0  | 0  | 0  |
| 2007 | 0  | 0  | 0  | 0  | 0  | 0  | 0  | 0  | 0  | 0  | 0  |
| 2008 | 0  | 0  | 0  | 0  | 0  | 0  | 0  | 0  | 0  | 0  | 0  |
| 2009 | 0  | 0  | 0  | 0  | 0  | 0  | 0  | 0  | 0  | 0  | 0  |
| 2010 | 0  | 0  | 0  | 0  | 0  | 0  | 0  | 0  | 0  | 0  | 0  |
| 2011 | 0  | 0  | 0  | 0  | 0  | 0  | 0  | 0  | 0  | 0  | 0  |
| 2012 | 0  | 0  | 0  | 0  | 0  | 0  | 0  | 0  | 0  | 0  | 0  |
| 2013 | 0  | 0  | 0  | 0  | 0  | 0  | 0  | 0  | 0  | 0  | 0  |
| 2014 | 0  | 0  | 0  | 0  | 0  | 0  | 0  | 0  | 0  | 0  | 0  |
| 2015 | 0  | 0  | 0  | 0  | 0  | 0  | 0  | 0  | 0  | 0  | 0  |
| 2016 | 0  | 0  | 0  | 0  | 0  | 0  | 0  | 0  | 0  | 0  | 0  |
| 2017 | 0  | 0  | 0  | 0  | 0  | 0  | 0  | 0  | 0  | 0  | 0  |
| 2018 | 0  | 0  | 0  | 0  | 0  | 0  | 0  | 0  | 0  | 0  | 0  |
| 2019 | 0  | 0  | 0  | 0  | 0  | 0  | 0  | 0  | 0  | 0  | 0  |
| 2020 | 0  | 0  | 0  | 0  | 0  | 0  | 0  | 0  | 0  | 0  | 0  |
| 2021 | 0  | 0  | 0  | 0  | 0  | 0  | 0  | 0  | 0  | 0  | 0  |
| 2022 | 0  | 0  | 0  | 0  | 0  | 0  | 0  | 0  | 0  | 0  | 0  |
| 2023 | 0  | 0  | 0  | 0  | 0  | 0  | 0  | 0  | 0  | 0  | 0  |
| 2024 | 0  | 0  | 0  | 0  | 0  | 0  | 0  | 0  | 0  | 0  | 0  |
| 2025 | 0  | 0  | 0  | 0  | 0  | 0  | 0  | 0  | 0  | 0  | 0  |
| 2026 | 0  | 0  | 1  | 0  | 0  | 0  | 0  | 0  | 0  | 0  | 0  |
| 2027 | 1  | 0  | 19 | 2  | 0  | 0  | 0  | 0  | 0  | 0  | 0  |
| 2028 | 0  | 0  | 34 | 0  | 0  | 0  | 0  | 0  | 0  | 0  | 0  |
| 2029 | 0  | 0  | 53 | 0  | 0  | 0  | 0  | 0  | 0  | 0  | 0  |
| 2030 | 0  | 0  | 61 | 0  | 0  | 0  | 0  | 0  | 0  | 0  | 0  |
| 2031 | 0  | 0  | 32 | 0  | 0  | 0  | 0  | 0  | 0  | 0  | 0  |
| 2032 | 0  | 0  | 26 | 0  | 0  | 0  | 0  | 0  | 0  | 0  | 0  |
| 2033 | 0  | 0  | 21 | 0  | 0  | 0  | 0  | 0  | 0  | 0  | 0  |
| 2034 | 0  | 0  | 13 | 0  | 0  | 0  | 0  | 0  | 0  | 0  | 0  |
| 2035 | 0  | 0  | 8  | 0  | 0  | 0  | 0  | 0  | 0  | 0  | 0  |
| 2036 | 0  | 0  | 7  | 0  | 0  | 0  | 0  | 0  | 0  | 0  | 0  |
| 2037 | 0  | 0  | 7  | 0  | 0  | 0  | 0  | 0  | 0  | 0  | 0  |
| 2038 | 0  | 0  | 3  | 0  | 0  | 0  | 0  | 0  | 0  | 0  | 0  |
| 2039 | 0  | 0  | 2  | 0  | 0  | 0  | 0  | 0  | 0  | 0  | 0  |
| 2040 | 0  | 0  | 0  | 0  | 0  | 0  | 0  | 0  | 0  | 0  | 0  |
| 2041 | 0  | 0  | 0  | 0  | 0  | 0  | 0  | 0  | 0  | 0  | 0  |
| 2042 | 0  | 0  | 0  | 0  | 0  | 0  | 0  | 0  | 0  | 0  | 0  |
| 2043 | 0  | 0  | 0  | 0  | 0  | 0  | 0  | 0  | 0  | 0  | 0  |
| 2044 | 0  | 0  | 0  | 0  | 0  | 0  | 0  | 0  | 0  | 0  | 0  |
| 2045 | 0  | 0  | 0  | 0  | 0  | 0  | 0  | 0  | 0  | 0  | 0  |
| 2046 | 0  | 0  | 0  | 0  | 0  | 0  | 0  | 0  | 0  | 0  | 0  |
| 2047 | 0  | 0  | 0  | 0  | 0  | 0  | 0  | 0  | 0  | 0  | 0  |
| 2048 | 0  | 0  | 0  | 0  | 0  | 0  | 0  | 0  | 0  | 0  | 0  |
| 2049 | 0  | 0  | 0  | 0  | 0  | 0  | 0  | 0  | 0  | 0  | 0  |
| 2050 | 0  | 0  | 0  | 0  | 0  | 0  | 0  | 0  | 0  | 0  | 0  |
| 2051 | 0  | 0  | 0  | 0  | 0  | 0  | 0  | 0  | 0  | 0  | 0  |
| 2052 | 0  | 0  | 0  | 0  | 0  | 0  | 0  | 0  | 0  | 0  | 0  |
| 2053 | 0  | 0  | 0  | 0  | 0  | 0  | 0  | 0  | 0  | 0  | 0  |
| 2054 | 0  | 0  | 0  | 0  | 0  | 0  | 0  | 0  | 0  | 0  | 0  |
| 2055 | 0  | 0  | 0  | 0  | 0  | 0  | 0  | 0  | 0  | 0  | 0  |
| 2056 | 0  | 0  | 0  | 0  | 0  | 0  | 0  | 0  | 0  | 0  | 0  |
| 2057 | 0  | 0  | 0  | 0  | 0  | 0  | 0  | 0  | 0  | 0  | 0  |
| 2058 | 0  | 0  | 0  | 0  | 0  | 0  | 0  | 0  | 0  | 0  | 0  |
| 2059 | 0  | 0  | 0  | 0  | 0  | 0  | 0  | 0  | 0  | 0  | 0  |

|      | 78 | 79 | 80 | 81 | 82 | 83 | 84 | 85 | 86 | 87 | 88 |
|------|----|----|----|----|----|----|----|----|----|----|----|
| 2060 | 0  | 0  | 0  | 0  | 0  | 0  | 0  | 0  | 0  | 0  | 0  |
| 2061 | 0  | 0  | 0  | 0  | 0  | 0  | 0  | 0  | 0  | 0  | 0  |
| 2062 | 0  | 0  | 0  | 0  | 0  | 0  | 0  | 0  | 0  | 0  | 0  |
| 2063 | 0  | 0  | 0  | 0  | 0  | 0  | 0  | 0  | 0  | 0  | 0  |
| 2064 | 0  | 0  | 0  | 0  | 0  | 0  | 0  | 0  | 0  | 0  | 0  |
| 2065 | 0  | 0  | 0  | 0  | 0  | 0  | 0  | 0  | 0  | 0  | 0  |
| 2066 | 0  | 0  | 0  | 0  | 0  | 0  | 0  | 0  | 0  | 0  | 0  |
| 2067 | 0  | 0  | 0  | 0  | 0  | 0  | 0  | 0  | 0  | 0  | 0  |
| 2068 | 0  | 0  | 0  | 0  | 0  | 0  | 0  | 0  | 0  | 0  | 0  |
| 2069 | 0  | 0  | 0  | 0  | 0  | 0  | 0  | 0  | 0  | 0  | 0  |
| 2070 | 0  | 0  | 0  | 0  | 0  | 0  | 0  | 0  | 0  | 0  | 0  |
| 2071 | 0  | 0  | 0  | 0  | 0  | 0  | 0  | 0  | 0  | 0  | 0  |
| 2072 | 0  | 0  | 0  | 0  | 0  | 0  | 0  | 0  | 0  | 0  | 0  |
| 2073 | 0  | 0  | 0  | 0  | 0  | 0  | 0  | 0  | 0  | 0  | 0  |
| 2074 | 0  | 0  | 0  | 0  | 0  | 0  | 0  | 0  | 0  | 0  | 0  |
| 2075 | 0  | 0  | 0  | 0  | 0  | 0  | 0  | 0  | 0  | 0  | 0  |
| 2076 | 0  | 0  | 0  | 0  | 0  | 0  | 0  | 0  | 0  | 0  | 0  |
| 2077 | 0  | 0  | 0  | 0  | 0  | 0  | 0  | 0  | 0  | 0  | 0  |
| 2078 | 0  | 0  | 0  | 0  | 0  | 0  | 0  | 0  | 0  | 0  | 0  |
| 2079 | 0  | 0  | 0  | 0  | 0  | 0  | 0  | 0  | 0  | 0  | 0  |
| 2080 | 0  | 0  | 0  | 0  | 0  | 0  | 0  | 0  | 0  | 0  | 0  |
| 2081 | 0  | 0  | 0  | 0  | 0  | 0  | 0  | 0  | 0  | 0  | 0  |
| 2082 | 0  | 0  | 0  | 0  | 0  | 0  | 0  | 0  | 0  | 0  | 0  |
| 2083 | 0  | 0  | 0  | 0  | 0  | 0  | 0  | 0  | 0  | 0  | 0  |
| 2084 | 0  | 0  | 0  | 0  | 0  | 0  | 0  | 0  | 0  | 0  | 0  |
| 2085 | 0  | 0  | 0  | 0  | 0  | 0  | 0  | 0  | 0  | 0  | 0  |
| 2086 | 0  | 0  | 0  | 0  | 0  | 0  | 0  | 0  | 0  | 0  | 0  |
| 2087 | 0  | 0  | 0  | 0  | 0  | 0  | 0  | 0  | 0  | 0  | 0  |
| 2088 | 0  | 0  | 0  | 0  | 0  | 0  | 0  | 0  | 0  | 0  | 0  |
| 2089 | 0  | 0  | 0  | 0  | 0  | 0  | 0  | 0  | 0  | 0  | 0  |
| 2090 | 0  | 0  | 0  | 0  | 0  | 0  | 0  | 0  | 0  | 0  | 0  |

|      | 89 | 90 | 91 | 92 | 93 | 94 | 95 | 96 | 97 | 98 | 99 |
|------|----|----|----|----|----|----|----|----|----|----|----|
| 2002 | 0  | 0  | 0  | 0  | 0  | 0  | 0  | 0  | 0  | 0  | 0  |
| 2003 | 0  | 0  | 0  | 0  | 0  | 0  | 0  | 0  | 0  | 0  | 0  |
| 2004 | 0  | 0  | 0  | 0  | 0  | 0  | 0  | 0  | 0  | 0  | 0  |
| 2005 | 0  | 0  | 0  | 0  | 0  | 0  | 0  | 0  | 0  | 0  | 0  |
| 2006 | 0  | 0  | 0  | 0  | 0  | 0  | 0  | 0  | 0  | 0  | 0  |
| 2007 | 0  | 0  | 0  | 0  | 0  | 0  | 0  | 0  | 0  | 0  | 0  |
| 2008 | 0  | 0  | 0  | 0  | 0  | 0  | 0  | 0  | 0  | 0  | 0  |
| 2009 | 0  | 0  | 0  | 0  | 0  | 0  | 0  | 0  | 0  | 0  | 0  |
| 2010 | 0  | 0  | 0  | 0  | 0  | 0  | 0  | 0  | 0  | 0  | 0  |
| 2011 | 0  | 0  | 0  | 0  | 0  | 0  | 0  | 0  | 0  | 0  | 0  |
| 2012 | 0  | 0  | 0  | 0  | 0  | 0  | 0  | 0  | 0  | 0  | 0  |
| 2013 | 0  | 0  | 0  | 0  | 0  | 0  | 0  | 0  | 0  | 0  | 0  |
| 2014 | 0  | 0  | 0  | 0  | 0  | 0  | 0  | 0  | 0  | 0  | 0  |
| 2015 | 0  | 0  | 0  | 0  | 0  | 0  | 0  | 0  | 0  | 0  | 0  |
| 2016 | 0  | 0  | 0  | 0  | 0  | 0  | 0  | 0  | 0  | 0  | 0  |
| 2017 | 0  | 0  | 0  | 0  | 0  | 0  | 0  | 0  | 0  | 0  | 0  |
| 2018 | 0  | 0  | 0  | 0  | 0  | 0  | 0  | 0  | 0  | 0  | 0  |
| 2019 | 0  | 0  | 0  | 0  | 0  | 0  | 0  | 0  | 0  | 0  | 0  |
| 2020 | 0  | 0  | 0  | 0  | 0  | 0  | 0  | 0  | 0  | 0  | 0  |
| 2021 | 0  | 0  | 0  | 0  | 0  | 0  | 0  | 0  | 0  | 0  | 0  |
| 2022 | 0  | 0  | 0  | 0  | 0  | 3  | 0  | 0  | 0  | 0  | 0  |
| 2023 | 0  | 0  | 0  | 0  | 0  | 0  | 0  | 0  | 0  | 0  | 0  |
| 2024 | 0  | 0  | 0  | 0  | 0  | 0  | 0  | 0  | 0  | 0  | 0  |
| 2025 | 0  | 0  | 0  | 0  | 0  | 0  | 0  | 0  | 0  | 0  | 0  |
| 2026 | 0  | 0  | 0  | 0  | 0  | 0  | 0  | 0  | 0  | 5  | 0  |
| 2027 | 0  | 0  | 0  | 0  | 0  | 0  | 0  | 0  | 0  | 7  | 0  |
| 2028 | 0  | 0  | 0  | 0  | 0  | 0  | 0  | 0  | 0  | 11 | 0  |
| 2029 | 0  | 0  | 0  | 0  | 0  | 0  | 0  | 0  | 0  | 15 | 0  |
| 2030 | 0  | 0  | 0  | 0  | 0  | 0  | 0  | 0  | 0  | 7  | 0  |
| 2031 | 0  | 0  | 0  | 0  | 0  | 0  | 0  | 0  | 0  | 8  | 0  |
| 2032 | 0  | 0  | 0  | 0  | 0  | 0  | 0  | 0  | 0  | 7  | 0  |
| 2033 | 0  | 0  | 0  | 0  | 0  | 0  | 0  | 0  | 0  | 5  | 0  |
| 2034 | 0  | 0  | 0  | 0  | 0  | 0  | 0  | 0  | 0  | 5  | 0  |
| 2035 | 0  | 0  | 0  | 0  | 0  | 0  | 0  | 0  | 0  | 0  | 0  |
| 2036 | 0  | 0  | 0  | 0  | 0  | 0  | 0  | 0  | 0  | 0  | 0  |
| 2037 | 0  | 0  | 0  | 0  | 0  | 0  | 0  | 0  | 0  | 0  | 0  |
| 2038 | 0  | 0  | 0  | 0  | 0  | 0  | 0  | 0  | 0  | 0  | 0  |
| 2039 | 0  | 0  | 0  | 0  | 0  | 0  | 0  | 0  | 0  | 0  | 0  |
| 2040 | 0  | 0  | 0  | 0  | 0  | 0  | 0  | 0  | 0  | 0  | 0  |
| 2041 | 0  | 0  | 0  | 0  | 0  | 0  | 0  | 0  | 0  | 0  | 0  |
| 2042 | 0  | 0  | 0  | 0  | 0  | 0  | 0  | 0  | 0  | 0  | 0  |
| 2043 | 0  | 0  | 0  | 0  | 0  | 0  | 0  | 0  | 0  | 0  | 0  |
| 2044 | 0  | 0  | 0  | 0  | 0  | 0  | 0  | 0  | 0  | 0  | 0  |
| 2045 | 0  | 0  | 0  | 0  | 0  | 0  | 0  | 0  | 0  | 0  | 0  |
| 2046 | 0  | 0  | 0  | 0  | 0  | 0  | 0  | 0  | 0  | 0  | 0  |
| 2047 | 0  | 0  | 0  | 0  | 0  | 0  | 0  | 0  | 0  | 0  | 0  |
| 2048 | 0  | 0  | 0  | 0  | 0  | 0  | 0  | 0  | 0  | 0  | 0  |
| 2049 | 0  | 0  | 0  | 0  | 0  | 0  | 0  | 0  | 0  | 0  | 0  |
| 2050 | 0  | 0  | 0  | 0  | 0  | 0  | 0  | 0  | 0  | 0  | 0  |
| 2051 | 0  | 0  | 0  | 0  | 0  | 0  | 0  | 0  | 0  | 0  | 0  |
| 2052 | 0  | 0  | 0  | 0  | 0  | 0  | 0  | 0  | 0  | 0  | 0  |
| 2053 | 0  | 0  | 0  | 0  | 0  | 0  | 0  | 0  | 0  | 0  | 0  |
| 2054 | 0  | 0  | 0  | 0  | 0  | 0  | 0  | 0  | 0  | 0  | 0  |
| 2055 | 0  | 0  | 0  | 0  | 0  | 0  | 0  | 0  | 0  | 0  | 0  |
| 2056 | 0  | 0  | 0  | 0  | 0  | 0  | 0  | 0  | 0  | 0  | 0  |
| 2057 | 0  | 0  | 0  | 0  | 0  | 0  | 0  | 0  | 0  | 0  | 0  |
| 2058 | 0  | 0  | 0  | 0  | 0  | 0  | 0  | 0  | 0  | 0  | 0  |
| 2059 | 0  | 0  | 0  | 0  | 0  | 0  | 0  | 0  | 0  | 0  | 0  |

|      | 89 | 90 | 91 | 92 | 93 | 94 | 95 | 96 | 97 | 98 | 99 |
|------|----|----|----|----|----|----|----|----|----|----|----|
| 2060 | 0  | 0  | 0  | 0  | 0  | 0  | 0  | 0  | 0  | 0  | 0  |
| 2061 | 0  | 0  | 0  | 0  | 0  | 0  | 0  | 0  | 0  | 0  | 0  |
| 2062 | 0  | 0  | 0  | 0  | 0  | 0  | 0  | 0  | 0  | 0  | 0  |
| 2063 | 0  | 0  | 0  | 0  | 0  | 0  | 0  | 0  | 0  | 0  | 0  |
| 2064 | 0  | 0  | 0  | 0  | 0  | 0  | 0  | 0  | 0  | 0  | 0  |
| 2065 | 0  | 0  | 0  | 0  | 0  | 0  | 0  | 0  | 0  | 0  | 0  |
| 2066 | 0  | 0  | 0  | 0  | 0  | 0  | 0  | 0  | 0  | 0  | 0  |
| 2067 | 0  | 0  | 0  | 0  | 0  | 0  | 0  | 0  | 0  | 0  | 0  |
| 2068 | 0  | 0  | 0  | 0  | 0  | 0  | 0  | 0  | 0  | 0  | 0  |
| 2069 | 0  | 0  | 0  | 0  | 0  | 0  | 0  | 0  | 0  | 0  | 0  |
| 2070 | 0  | 0  | 0  | 0  | 0  | 0  | 0  | 0  | 0  | 0  | 0  |
| 2071 | 0  | 0  | 0  | 0  | 0  | 0  | 0  | 0  | 0  | 0  | 0  |
| 2072 | 0  | 0  | 0  | 0  | 0  | 0  | 0  | 0  | 0  | 0  | 0  |
| 2073 | 0  | 0  | 0  | 0  | 0  | 0  | 0  | 0  | 0  | 0  | 0  |
| 2074 | 0  | 0  | 0  | 0  | 0  | 0  | 0  | 0  | 0  | 0  | 0  |
| 2075 | 0  | 0  | 0  | 0  | 0  | 0  | 0  | 0  | 0  | 0  | 0  |
| 2076 | 0  | 0  | 0  | 0  | 0  | 0  | 0  | 0  | 0  | 0  | 0  |
| 2077 | 0  | 0  | 0  | 0  | 0  | 0  | 0  | 0  | 0  | 0  | 0  |
| 2078 | 0  | 0  | 0  | 0  | 0  | 0  | 0  | 0  | 0  | 0  | 0  |
| 2079 | 0  | 0  | 0  | 0  | 0  | 0  | 0  | 0  | 0  | 0  | 0  |
| 2080 | 0  | 0  | 0  | 0  | 0  | 0  | 0  | 0  | 0  | 0  | 0  |
| 2081 | 0  | 0  | 0  | 0  | 0  | 0  | 0  | 0  | 0  | 0  | 0  |
| 2082 | 0  | 0  | 0  | 0  | 0  | 0  | 0  | 0  | 0  | 0  | 0  |
| 2083 | 0  | 0  | 0  | 0  | 0  | 0  | 0  | 0  | 0  | 0  | 0  |
| 2084 | 0  | 0  | 0  | 0  | 0  | 0  | 0  | 0  | 0  | 0  | 0  |
| 2085 | 0  | 0  | 0  | 0  | 0  | 0  | 0  | 0  | 0  | 0  | 0  |
| 2086 | 0  | 0  | 0  | 0  | 0  | 0  | 0  | 0  | 0  | 0  | 0  |
| 2087 | 0  | 0  | 0  | 0  | 0  | 0  | 0  | 0  | 0  | 0  | 0  |
| 2088 | 0  | 0  | 0  | 0  | 0  | 0  | 0  | 0  | 0  | 0  | 0  |
| 2089 | 0  | 0  | 0  | 0  | 0  | 0  | 0  | 0  | 0  | 0  | 0  |
| 2090 | 0  | 0  | 0  | 0  | 0  | 0  | 0  | 0  | 0  | 0  | 0  |



|      | 100 | 101 | 102 | 103 | 104 | 105 | 106 | 107 | 108 | 109 | 110 |
|------|-----|-----|-----|-----|-----|-----|-----|-----|-----|-----|-----|
| 2002 | 0   | 0   | 0   | 0   | 0   | 0   | 0   | 0   | 0   | 0   | 0   |
| 2003 | 0   | 0   | 0   | 0   | 0   | 0   | 0   | 0   | 0   | 0   | 0   |
| 2004 | 0   | 0   | 0   | 0   | 0   | 0   | 0   | 0   | 0   | 0   | 0   |
| 2005 | 0   | 0   | 0   | 0   | 0   | 0   | 0   | 0   | 0   | 0   | 0   |
| 2006 | 0   | 0   | 0   | 0   | 0   | 0   | 0   | 0   | 0   | 0   | 0   |
| 2007 | 0   | 0   | 0   | 0   | 0   | 0   | 0   | 0   | 0   | 0   | 0   |
| 2008 | 0   | 0   | 0   | 0   | 0   | 0   | 0   | 0   | 0   | 0   | 0   |
| 2009 | 0   | 0   | 0   | 0   | 0   | 0   | 0   | 0   | 0   | 0   | 0   |
| 2010 | 0   | 0   | 0   | 0   | 0   | 0   | 0   | 0   | 0   | 0   | 0   |
| 2011 | 0   | 0   | 0   | 0   | 0   | 0   | 0   | 0   | 0   | 0   | 0   |
| 2012 | 0   | 0   | 0   | 0   | 0   | 0   | 0   | 0   | 0   | 0   | 0   |
| 2013 | 0   | 0   | 0   | 0   | 0   | 0   | 0   | 0   | 0   | 0   | 0   |
| 2014 | 0   | 0   | 0   | 0   | 0   | 0   | 0   | 0   | 0   | 0   | 0   |
| 2015 | 0   | 0   | 0   | 0   | 0   | 0   | 0   | 0   | 0   | 0   | 0   |
| 2016 | 0   | 0   | 0   | 0   | 0   | 0   | 0   | 0   | 0   | 0   | 0   |
| 2017 | 0   | 0   | 0   | 0   | 0   | 0   | 0   | 0   | 0   | 0   | 0   |
| 2018 | 0   | 0   | 0   | 0   | 0   | 0   | 0   | 0   | 0   | 0   | 0   |
| 2019 | 0   | 0   | 0   | 0   | 0   | 0   | 0   | 0   | 0   | 0   | 0   |
| 2020 | 0   | 0   | 0   | 0   | 0   | 0   | 0   | 0   | 0   | 0   | 0   |
| 2021 | 0   | 0   | 0   | 8   | 0   | 0   | 0   | 0   | 0   | 0   | 0   |
| 2022 | 0   | 0   | 0   | 9   | 0   | 0   | 0   | 0   | 0   | 0   | 0   |
| 2023 | 0   | 0   | 0   | 11  | 0   | 0   | 0   | 0   | 0   | 0   | 0   |
| 2024 | 0   | 0   | 0   | 7   | 0   | 0   | 0   | 0   | 0   | 0   | 0   |
| 2025 | 0   | 0   | 0   | 7   | 0   | 0   | 0   | 0   | 0   | 0   | 0   |
| 2026 | 2   | 0   | 0   | 3   | 0   | 0   | 0   | 15  | 0   | 0   | 0   |
| 2027 | 7   | 0   | 0   | 2   | 2   | 0   | 0   | 33  | 2   | 0   | 0   |
| 2028 | 2   | 0   | 0   | 0   | 0   | 0   | 0   | 43  | 0   | 0   | 0   |
| 2029 | 5   | 0   | 0   | 0   | 0   | 0   | 0   | 56  | 0   | 0   | 0   |
| 2030 | 5   | 0   | 0   | 0   | 0   | 0   | 0   | 51  | 0   | 0   | 0   |
| 2031 | 3   | 0   | 0   | 0   | 0   | 0   | 0   | 28  | 0   | 0   | 0   |
| 2032 | 2   | 0   | 0   | 0   | 0   | 0   | 0   | 24  | 0   | 0   | 0   |
| 2033 | 0   | 0   | 0   | 0   | 0   | 0   | 0   | 19  | 0   | 0   | 0   |
| 2034 | 0   | 0   | 0   | 0   | 0   | 0   | 0   | 13  | 0   | 0   | 0   |
| 2035 | 0   | 0   | 0   | 0   | 0   | 0   | 0   | 8   | 0   | 0   | 0   |
| 2036 | 0   | 0   | 0   | 0   | 0   | 0   | 0   | 7   | 0   | 0   | 0   |
| 2037 | 0   | 0   | 0   | 0   | 0   | 0   | 0   | 7   | 0   | 0   | 0   |
| 2038 | 0   | 0   | 0   | 0   | 0   | 0   | 0   | 3   | 0   | 0   | 0   |
| 2039 | 0   | 0   | 0   | 0   | 0   | 0   | 0   | 2   | 0   | 0   | 0   |
| 2040 | 0   | 0   | 0   | 0   | 0   | 0   | 0   | 0   | 0   | 0   | 0   |
| 2041 | 0   | 0   | 0   | 0   | 0   | 0   | 0   | 0   | 0   | 0   | 0   |
| 2042 | 0   | 0   | 0   | 0   | 0   | 0   | 0   | 0   | 0   | 0   | 0   |
| 2043 | 0   | 0   | 0   | 0   | 0   | 0   | 0   | 0   | 0   | 0   | 0   |
| 2044 | 0   | 0   | 0   | 0   | 0   | 0   | 0   | 0   | 0   | 0   | 0   |
| 2045 | 0   | 0   | 0   | 0   | 0   | 0   | 0   | 0   | 0   | 0   | 0   |
| 2046 | 0   | 0   | 0   | 0   | 0   | 0   | 0   | 0   | 0   | 0   | 0   |
| 2047 | 0   | 0   | 0   | 0   | 0   | 0   | 0   | 0   | 0   | 0   | 0   |
| 2048 | 0   | 0   | 0   | 0   | 0   | 0   | 0   | 0   | 0   | 0   | 0   |
| 2049 | 0   | 0   | 0   | 0   | 0   | 0   | 0   | 0   | 0   | 0   | 0   |
| 2050 | 0   | 0   | 0   | 0   | 0   | 0   | 0   | 0   | 0   | 0   | 0   |
| 2051 | 0   | 0   | 0   | 0   | 0   | 0   | 0   | 0   | 0   | 0   | 0   |
| 2052 | 0   | 0   | 0   | 0   | 0   | 0   | 0   | 0   | 0   | 0   | 0   |
| 2053 | 0   | 0   | 0   | 0   | 0   | 0   | 0   | 0   | 0   | 0   | 0   |
| 2054 | 0   | 0   | 0   | 0   | 0   | 0   | 0   | 0   | 0   | 0   | 0   |
| 2055 | 0   | 0   | 0   | 0   | 0   | 0   | 0   | 0   | 0   | 0   | 0   |
| 2056 | 0   | 0   | 0   | 0   | 0   | 0   | 0   | 0   | 0   | 0   | 0   |
| 2057 | 0   | 0   | 0   | 0   | 0   | 0   | 0   | 0   | 0   | 0   | 0   |
| 2058 | 0   | 0   | 0   | 0   | 0   | 0   | 0   | 0   | 0   | 0   | 0   |
| 2059 | 0   | 0   | 0   | 0   | 0   | 0   | 0   | 0   | 0   | 0   | 0   |

|      | 100 | 101 | 102 | 103 | 104 | 105 | 106 | 107 | 108 | 109 | 110 |
|------|-----|-----|-----|-----|-----|-----|-----|-----|-----|-----|-----|
| 2060 | 0   | 0   | 0   | 0   | 0   | 0   | 0   | 0   | 0   | 0   | 0   |
| 2061 | 0   | 0   | 0   | 0   | 0   | 0   | 0   | 0   | 0   | 0   | 0   |
| 2062 | 0   | 0   | 0   | 0   | 0   | 0   | 0   | 0   | 0   | 0   | 0   |
| 2063 | 0   | 0   | 0   | 0   | 0   | 0   | 0   | 0   | 0   | 0   | 0   |
| 2064 | 0   | 0   | 0   | 0   | 0   | 0   | 0   | 0   | 0   | 0   | 0   |
| 2065 | 0   | 0   | 0   | 0   | 0   | 0   | 0   | 0   | 0   | 0   | 0   |
| 2066 | 0   | 0   | 0   | 0   | 0   | 0   | 0   | 0   | 0   | 0   | 0   |
| 2067 | 0   | 0   | 0   | 0   | 0   | 0   | 0   | 0   | 0   | 0   | 0   |
| 2068 | 0   | 0   | 0   | 0   | 0   | 0   | 0   | 0   | 0   | 0   | 0   |
| 2069 | 0   | 0   | 0   | 0   | 0   | 0   | 0   | 0   | 0   | 0   | 0   |
| 2070 | 0   | 0   | 0   | 0   | 0   | 0   | 0   | 0   | 0   | 0   | 0   |
| 2071 | 0   | 0   | 0   | 0   | 0   | 0   | 0   | 0   | 0   | 0   | 0   |
| 2072 | 0   | 0   | 0   | 0   | 0   | 0   | 0   | 0   | 0   | 0   | 0   |
| 2073 | 0   | 0   | 0   | 0   | 0   | 0   | 0   | 0   | 0   | 0   | 0   |
| 2074 | 0   | 0   | 0   | 0   | 0   | 0   | 0   | 0   | 0   | 0   | 0   |
| 2075 | 0   | 0   | 0   | 0   | 0   | 0   | 0   | 0   | 0   | 0   | 0   |
| 2076 | 0   | 0   | 0   | 0   | 0   | 0   | 0   | 0   | 0   | 0   | 0   |
| 2077 | 0   | 0   | 0   | 0   | 0   | 0   | 0   | 0   | 0   | 0   | 0   |
| 2078 | 0   | 0   | 0   | 0   | 0   | 0   | 0   | 0   | 0   | 0   | 0   |
| 2079 | 0   | 0   | 0   | 0   | 0   | 0   | 0   | 0   | 0   | 0   | 0   |
| 2080 | 0   | 0   | 0   | 0   | 0   | 0   | 0   | 0   | 0   | 0   | 0   |
| 2081 | 0   | 0   | 0   | 0   | 0   | 0   | 0   | 0   | 0   | 0   | 0   |
| 2082 | 0   | 0   | 0   | 0   | 0   | 0   | 0   | 0   | 0   | 0   | 0   |
| 2083 | 0   | 0   | 0   | 0   | 0   | 0   | 0   | 0   | 0   | 0   | 0   |
| 2084 | 0   | 0   | 0   | 0   | 0   | 0   | 0   | 0   | 0   | 0   | 0   |
| 2085 | 0   | 0   | 0   | 0   | 0   | 0   | 0   | 0   | 0   | 0   | 0   |
| 2086 | 0   | 0   | 0   | 0   | 0   | 0   | 0   | 0   | 0   | 0   | 0   |
| 2087 | 0   | 0   | 0   | 0   | 0   | 0   | 0   | 0   | 0   | 0   | 0   |
| 2088 | 0   | 0   | 0   | 0   | 0   | 0   | 0   | 0   | 0   | 0   | 0   |
| 2089 | 0   | 0   | 0   | 0   | 0   | 0   | 0   | 0   | 0   | 0   | 0   |
| 2090 | 0   | 0   | 0   | 0   | 0   | 0   | 0   | 0   | 0   | 0   | 0   |

|      | 111 | 112 | 113 | 114 | 115 | 116 | 117 | 118 | 119 | 120 | 121 |
|------|-----|-----|-----|-----|-----|-----|-----|-----|-----|-----|-----|
| 2002 | 0   | 0   | 0   | 0   | 0   | 0   | 0   | 0   | 0   | 0   | 0   |
| 2003 | 0   | 0   | 0   | 0   | 0   | 0   | 0   | 0   | 0   | 0   | 0   |
| 2004 | 0   | 0   | 0   | 0   | 0   | 0   | 0   | 0   | 0   | 0   | 0   |
| 2005 | 0   | 0   | 0   | 0   | 0   | 0   | 0   | 0   | 0   | 0   | 0   |
| 2006 | 0   | 0   | 0   | 0   | 0   | 0   | 0   | 0   | 0   | 0   | 0   |
| 2007 | 0   | 0   | 0   | 0   | 0   | 0   | 0   | 0   | 0   | 0   | 0   |
| 2008 | 0   | 0   | 0   | 0   | 0   | 0   | 0   | 0   | 0   | 0   | 0   |
| 2009 | 0   | 0   | 0   | 0   | 0   | 0   | 0   | 0   | 0   | 0   | 0   |
| 2010 | 0   | 0   | 0   | 0   | 0   | 0   | 0   | 0   | 0   | 0   | 0   |
| 2011 | 0   | 0   | 0   | 0   | 0   | 0   | 0   | 0   | 0   | 0   | 0   |
| 2012 | 0   | 0   | 0   | 0   | 0   | 0   | 0   | 0   | 0   | 0   | 0   |
| 2013 | 0   | 0   | 0   | 0   | 0   | 0   | 0   | 0   | 0   | 0   | 0   |
| 2014 | 0   | 0   | 0   | 0   | 0   | 0   | 0   | 0   | 0   | 0   | 0   |
| 2015 | 0   | 0   | 0   | 0   | 0   | 0   | 0   | 0   | 0   | 0   | 0   |
| 2016 | 0   | 0   | 0   | 0   | 0   | 0   | 0   | 0   | 0   | 0   | 0   |
| 2017 | 0   | 0   | 0   | 0   | 0   | 0   | 0   | 0   | 0   | 0   | 0   |
| 2018 | 0   | 0   | 0   | 0   | 0   | 0   | 0   | 0   | 0   | 0   | 0   |
| 2019 | 0   | 0   | 0   | 0   | 0   | 0   | 0   | 0   | 0   | 0   | 0   |
| 2020 | 0   | 0   | 0   | 0   | 0   | 0   | 0   | 0   | 0   | 0   | 0   |
| 2021 | 0   | 0   | 0   | 0   | 0   | 0   | 0   | 0   | 0   | 0   | 0   |
| 2022 | 0   | 0   | 0   | 0   | 0   | 0   | 0   | 0   | 0   | 0   | 0   |
| 2023 | 0   | 0   | 0   | 0   | 0   | 0   | 0   | 0   | 0   | 0   | 0   |
| 2024 | 0   | 0   | 0   | 0   | 0   | 0   | 0   | 0   | 0   | 0   | 0   |
| 2025 | 0   | 0   | 0   | 0   | 0   | 0   | 0   | 0   | 0   | 0   | 0   |
| 2026 | 0   | 0   | 0   | 0   | 0   | 0   | 0   | 0   | 0   | 0   | 0   |
| 2027 | 0   | 0   | 0   | 0   | 0   | 0   | 0   | 0   | 0   | 0   | 0   |
| 2028 | 0   | 0   | 0   | 0   | 0   | 0   | 0   | 0   | 0   | 0   | 0   |
| 2029 | 0   | 0   | 0   | 0   | 0   | 0   | 0   | 0   | 0   | 0   | 0   |
| 2030 | 0   | 0   | 0   | 0   | 0   | 0   | 0   | 0   | 0   | 0   | 0   |
| 2031 | 0   | 0   | 0   | 0   | 0   | 0   | 0   | 0   | 0   | 0   | 0   |
| 2032 | 0   | 0   | 0   | 0   | 0   | 0   | 0   | 0   | 0   | 0   | 0   |
| 2033 | 0   | 0   | 0   | 0   | 0   | 0   | 0   | 0   | 0   | 0   | 0   |
| 2034 | 0   | 0   | 0   | 0   | 0   | 0   | 0   | 0   | 0   | 0   | 0   |
| 2035 | 0   | 0   | 0   | 0   | 0   | 0   | 0   | 0   | 0   | 0   | 0   |
| 2036 | 0   | 0   | 0   | 0   | 0   | 0   | 0   | 0   | 0   | 0   | 0   |
| 2037 | 0   | 0   | 0   | 0   | 0   | 0   | 0   | 0   | 0   | 0   | 0   |
| 2038 | 0   | 0   | 0   | 0   | 0   | 0   | 0   | 0   | 0   | 0   | 0   |
| 2039 | 0   | 0   | 0   | 0   | 0   | 0   | 0   | 0   | 0   | 0   | 0   |
| 2040 | 0   | 0   | 0   | 0   | 0   | 0   | 0   | 0   | 0   | 0   | 0   |
| 2041 | 0   | 0   | 0   | 0   | 0   | 0   | 0   | 0   | 0   | 0   | 0   |
| 2042 | 0   | 0   | 0   | 0   | 0   | 0   | 0   | 0   | 0   | 0   | 0   |
| 2043 | 0   | 0   | 0   | 0   | 0   | 0   | 0   | 0   | 0   | 0   | 0   |
| 2044 | 0   | 0   | 0   | 0   | 0   | 0   | 0   | 0   | 0   | 0   | 0   |
| 2045 | 0   | 0   | 0   | 0   | 0   | 0   | 0   | 0   | 0   | 0   | 0   |
| 2046 | 0   | 0   | 0   | 0   | 0   | 0   | 0   | 0   | 0   | 0   | 0   |
| 2047 | 0   | 0   | 0   | 0   | 0   | 0   | 0   | 0   | 0   | 0   | 0   |
| 2048 | 0   | 0   | 0   | 0   | 0   | 0   | 0   | 0   | 0   | 0   | 0   |
| 2049 | 0   | 0   | 0   | 0   | 0   | 0   | 0   | 0   | 0   | 0   | 0   |
| 2050 | 0   | 0   | 0   | 0   | 0   | 0   | 0   | 0   | 0   | 0   | 0   |
| 2051 | 0   | 0   | 0   | 0   | 0   | 0   | 0   | 0   | 0   | 0   | 0   |
| 2052 | 0   | 0   | 0   | 0   | 0   | 0   | 0   | 0   | 0   | 0   | 0   |
| 2053 | 0   | 0   | 0   | 0   | 0   | 0   | 0   | 0   | 0   | 0   | 0   |
| 2054 | 0   | 0   | 0   | 0   | 0   | 0   | 0   | 0   | 0   | 0   | 0   |
| 2055 | 0   | 0   | 0   | 0   | 0   | 0   | 0   | 0   | 0   | 0   | 0   |
| 2056 | 0   | 0   | 0   | 0   | 0   | 0   | 0   | 0   | 0   | 0   | 0   |
| 2057 | 0   | 0   | 0   | 0   | 0   | 0   | 0   | 0   | 0   | 0   | 0   |
| 2058 | 0   | 0   | 0   | 0   | 0   | 0   | 0   | 0   | 0   | 0   | 0   |
| 2059 | 0   | 0   | 0   | 0   | 0   | 0   | 0   | 0   | 0   | 0   | 0   |

|      | 111 | 112 | 113 | 114 | 115 | 116 | 117 | 118 | 119 | 120 | 121 |
|------|-----|-----|-----|-----|-----|-----|-----|-----|-----|-----|-----|
| 2060 | 0   | 0   | 0   | 0   | 0   | 0   | 0   | 0   | 0   | 0   | 0   |
| 2061 | 0   | 0   | 0   | 0   | 0   | 0   | 0   | 0   | 0   | 0   | 0   |
| 2062 | 0   | 0   | 0   | 0   | 0   | 0   | 0   | 0   | 0   | 0   | 0   |
| 2063 | 0   | 0   | 0   | 0   | 0   | 0   | 0   | 0   | 0   | 0   | 0   |
| 2064 | 0   | 0   | 0   | 0   | 0   | 0   | 0   | 0   | 0   | 0   | 0   |
| 2065 | 0   | 0   | 0   | 0   | 0   | 0   | 0   | 0   | 0   | 0   | 0   |
| 2066 | 0   | 0   | 0   | 0   | 0   | 0   | 0   | 0   | 0   | 0   | 0   |
| 2067 | 0   | 0   | 0   | 0   | 0   | 0   | 0   | 0   | 0   | 0   | 0   |
| 2068 | 0   | 0   | 0   | 0   | 0   | 0   | 0   | 0   | 0   | 0   | 0   |
| 2069 | 0   | 0   | 0   | 0   | 0   | 0   | 0   | 0   | 0   | 0   | 0   |
| 2070 | 0   | 0   | 0   | 0   | 0   | 0   | 0   | 0   | 0   | 0   | 0   |
| 2071 | 0   | 0   | 0   | 0   | 0   | 0   | 0   | 0   | 0   | 0   | 0   |
| 2072 | 0   | 0   | 0   | 0   | 0   | 0   | 0   | 0   | 0   | 0   | 0   |
| 2073 | 0   | 0   | 0   | 0   | 0   | 0   | 0   | 0   | 0   | 0   | 0   |
| 2074 | 0   | 0   | 0   | 0   | 0   | 0   | 0   | 0   | 0   | 0   | 0   |
| 2075 | 0   | 0   | 0   | 0   | 0   | 0   | 0   | 0   | 0   | 0   | 0   |
| 2076 | 0   | 0   | 0   | 0   | 0   | 0   | 0   | 0   | 0   | 0   | 0   |
| 2077 | 0   | 0   | 0   | 0   | 0   | 0   | 0   | 0   | 0   | 0   | 0   |
| 2078 | 0   | 0   | 0   | 0   | 0   | 0   | 0   | 0   | 0   | 0   | 0   |
| 2079 | 0   | 0   | 0   | 0   | 0   | 0   | 0   | 0   | 0   | 0   | 0   |
| 2080 | 0   | 0   | 0   | 0   | 0   | 0   | 0   | 0   | 0   | 0   | 0   |
| 2081 | 0   | 0   | 0   | 0   | 0   | 0   | 0   | 0   | 0   | 0   | 0   |
| 2082 | 0   | 0   | 0   | 0   | 0   | 0   | 0   | 0   | 0   | 0   | 0   |
| 2083 | 0   | 0   | 0   | 0   | 0   | 0   | 0   | 0   | 0   | 0   | 0   |
| 2084 | 0   | 0   | 0   | 0   | 0   | 0   | 0   | 0   | 0   | 0   | 0   |
| 2085 | 0   | 0   | 0   | 0   | 0   | 0   | 0   | 0   | 0   | 0   | 0   |
| 2086 | 0   | 0   | 0   | 0   | 0   | 0   | 0   | 0   | 0   | 0   | 0   |
| 2087 | 0   | 0   | 0   | 0   | 0   | 0   | 0   | 0   | 0   | 0   | 0   |
| 2088 | 0   | 0   | 0   | 0   | 0   | 0   | 0   | 0   | 0   | 0   | 0   |
| 2089 | 0   | 0   | 0   | 0   | 0   | 0   | 0   | 0   | 0   | 0   | 0   |
| 2090 | 0   | 0   | 0   | 0   | 0   | 0   | 0   | 0   | 0   | 0   | 0   |

|      | 122 | 123 | 124 | 125 | 126 | 127 | 128 | 129 | 130 | 131 | 132 |
|------|-----|-----|-----|-----|-----|-----|-----|-----|-----|-----|-----|
| 2002 | 0   | 0   | 0   | 0   | 0   | 0   | 0   | 0   | 0   | 0   | 0   |
| 2003 | 0   | 0   | 0   | 0   | 0   | 0   | 0   | 0   | 0   | 0   | 0   |
| 2004 | 0   | 0   | 0   | 0   | 0   | 0   | 0   | 0   | 0   | 0   | 0   |
| 2005 | 0   | 0   | 0   | 0   | 0   | 0   | 0   | 0   | 0   | 0   | 0   |
| 2006 | 0   | 0   | 0   | 0   | 0   | 0   | 0   | 0   | 0   | 0   | 0   |
| 2007 | 0   | 0   | 0   | 0   | 0   | 0   | 0   | 0   | 0   | 0   | 0   |
| 2008 | 0   | 0   | 0   | 0   | 0   | 0   | 0   | 0   | 0   | 0   | 0   |
| 2009 | 0   | 0   | 0   | 0   | 0   | 0   | 0   | 0   | 0   | 0   | 0   |
| 2010 | 0   | 0   | 0   | 0   | 0   | 0   | 0   | 0   | 0   | 0   | 0   |
| 2011 | 0   | 0   | 0   | 0   | 0   | 0   | 0   | 0   | 0   | 0   | 0   |
| 2012 | 0   | 0   | 0   | 0   | 0   | 0   | 0   | 0   | 0   | 0   | 0   |
| 2013 | 0   | 0   | 0   | 0   | 0   | 0   | 0   | 0   | 0   | 0   | 0   |
| 2014 | 0   | 0   | 0   | 0   | 0   | 0   | 0   | 0   | 0   | 0   | 0   |
| 2015 | 0   | 0   | 0   | 0   | 0   | 0   | 0   | 0   | 0   | 0   | 0   |
| 2016 | 0   | 0   | 0   | 0   | 0   | 0   | 0   | 0   | 0   | 0   | 0   |
| 2017 | 0   | 0   | 0   | 0   | 0   | 0   | 0   | 0   | 0   | 0   | 0   |
| 2018 | 0   | 0   | 0   | 0   | 0   | 0   | 0   | 0   | 0   | 0   | 0   |
| 2019 | 0   | 0   | 0   | 0   | 0   | 0   | 0   | 0   | 0   | 0   | 0   |
| 2020 | 0   | 0   | 0   | 0   | 0   | 0   | 0   | 0   | 0   | 0   | 0   |
| 2021 | 0   | 0   | 0   | 0   | 0   | 0   | 0   | 0   | 4   | 0   | 0   |
| 2022 | 0   | 0   | 0   | 0   | 0   | 0   | 0   | 0   | 4   | 0   | 0   |
| 2023 | 0   | 0   | 0   | 0   | 0   | 0   | 0   | 0   | 8   | 0   | 0   |
| 2024 | 0   | 0   | 0   | 0   | 0   | 0   | 0   | 0   | 7   | 0   | 0   |
| 2025 | 0   | 0   | 0   | 0   | 0   | 0   | 0   | 0   | 7   | 0   | 0   |
| 2026 | 0   | 0   | 0   | 6   | 0   | 0   | 0   | 0   | 3   | 0   | 0   |
| 2027 | 0   | 0   | 0   | 7   | 0   | 6   | 0   | 0   | 2   | 2   | 2   |
| 2028 | 0   | 0   | 0   | 7   | 0   | 4   | 0   | 0   | 0   | 0   | 0   |
| 2029 | 0   | 0   | 0   | 5   | 0   | 5   | 0   | 0   | 0   | 0   | 0   |
| 2030 | 0   | 0   | 0   | 5   | 0   | 5   | 0   | 0   | 0   | 0   | 0   |
| 2031 | 0   | 0   | 0   | 5   | 0   | 3   | 0   | 0   | 0   | 0   | 0   |
| 2032 | 0   | 0   | 0   | 4   | 0   | 2   | 0   | 0   | 0   | 0   | 0   |
| 2033 | 0   | 0   | 0   | 2   | 0   | 0   | 0   | 0   | 0   | 0   | 0   |
| 2034 | 0   | 0   | 0   | 2   | 0   | 0   | 0   | 0   | 0   | 0   | 0   |
| 2035 | 0   | 0   | 0   | 0   | 0   | 0   | 0   | 0   | 0   | 0   | 0   |
| 2036 | 0   | 0   | 0   | 0   | 0   | 0   | 0   | 0   | 0   | 0   | 0   |
| 2037 | 0   | 0   | 0   | 0   | 0   | 0   | 0   | 0   | 0   | 0   | 0   |
| 2038 | 0   | 0   | 0   | 0   | 0   | 0   | 0   | 0   | 0   | 0   | 0   |
| 2039 | 0   | 0   | 0   | 0   | 0   | 0   | 0   | 0   | 0   | 0   | 0   |
| 2040 | 0   | 0   | 0   | 0   | 0   | 0   | 0   | 0   | 0   | 0   | 0   |
| 2041 | 0   | 0   | 0   | 0   | 0   | 0   | 0   | 0   | 0   | 0   | 0   |
| 2042 | 0   | 0   | 0   | 0   | 0   | 0   | 0   | 0   | 0   | 0   | 0   |
| 2043 | 0   | 0   | 0   | 0   | 0   | 0   | 0   | 0   | 0   | 0   | 0   |
| 2044 | 0   | 0   | 0   | 0   | 0   | 0   | 0   | 0   | 0   | 0   | 0   |
| 2045 | 0   | 0   | 0   | 0   | 0   | 0   | 0   | 0   | 0   | 0   | 0   |
| 2046 | 0   | 0   | 0   | 0   | 0   | 0   | 0   | 0   | 0   | 0   | 0   |
| 2047 | 0   | 0   | 0   | 0   | 0   | 0   | 0   | 0   | 0   | 0   | 0   |
| 2048 | 0   | 0   | 0   | 0   | 0   | 0   | 0   | 0   | 0   | 0   | 0   |
| 2049 | 0   | 0   | 0   | 0   | 0   | 0   | 0   | 0   | 0   | 0   | 0   |
| 2050 | 0   | 0   | 0   | 0   | 0   | 0   | 0   | 0   | 0   | 0   | 0   |
| 2051 | 0   | 0   | 0   | 0   | 0   | 0   | 0   | 0   | 0   | 0   | 0   |
| 2052 | 0   | 0   | 0   | 0   | 0   | 0   | 0   | 0   | 0   | 0   | 0   |
| 2053 | 0   | 0   | 0   | 0   | 0   | 0   | 0   | 0   | 0   | 0   | 0   |
| 2054 | 0   | 0   | 0   | 0   | 0   | 0   | 0   | 0   | 0   | 0   | 0   |
| 2055 | 0   | 0   | 0   | 0   | 0   | 0   | 0   | 0   | 0   | 0   | 0   |
| 2056 | 0   | 0   | 0   | 0   | 0   | 0   | 0   | 0   | 0   | 0   | 0   |
| 2057 | 0   | 0   | 0   | 0   | 0   | 0   | 0   | 0   | 0   | 0   | 0   |
| 2058 | 0   | 0   | 0   | 0   | 0   | 0   | 0   | 0   | 0   | 0   | 0   |
| 2059 | 0   | 0   | 0   | 0   | 0   | 0   | 0   | 0   | 0   | 0   | 0   |

|      | 122 | 123 | 124 | 125 | 126 | 127 | 128 | 129 | 130 | 131 | 132 |
|------|-----|-----|-----|-----|-----|-----|-----|-----|-----|-----|-----|
| 2060 | 0   | 0   | 0   | 0   | 0   | 0   | 0   | 0   | 0   | 0   | 0   |
| 2061 | 0   | 0   | 0   | 0   | 0   | 0   | 0   | 0   | 0   | 0   | 0   |
| 2062 | 0   | 0   | 0   | 0   | 0   | 0   | 0   | 0   | 0   | 0   | 0   |
| 2063 | 0   | 0   | 0   | 0   | 0   | 0   | 0   | 0   | 0   | 0   | 0   |
| 2064 | 0   | 0   | 0   | 0   | 0   | 0   | 0   | 0   | 0   | 0   | 0   |
| 2065 | 0   | 0   | 0   | 0   | 0   | 0   | 0   | 0   | 0   | 0   | 0   |
| 2066 | 0   | 0   | 0   | 0   | 0   | 0   | 0   | 0   | 0   | 0   | 0   |
| 2067 | 0   | 0   | 0   | 0   | 0   | 0   | 0   | 0   | 0   | 0   | 0   |
| 2068 | 0   | 0   | 0   | 0   | 0   | 0   | 0   | 0   | 0   | 0   | 0   |
| 2069 | 0   | 0   | 0   | 0   | 0   | 0   | 0   | 0   | 0   | 0   | 0   |
| 2070 | 0   | 0   | 0   | 0   | 0   | 0   | 0   | 0   | 0   | 0   | 0   |
| 2071 | 0   | 0   | 0   | 0   | 0   | 0   | 0   | 0   | 0   | 0   | 0   |
| 2072 | 0   | 0   | 0   | 0   | 0   | 0   | 0   | 0   | 0   | 0   | 0   |
| 2073 | 0   | 0   | 0   | 0   | 0   | 0   | 0   | 0   | 0   | 0   | 0   |
| 2074 | 0   | 0   | 0   | 0   | 0   | 0   | 0   | 0   | 0   | 0   | 0   |
| 2075 | 0   | 0   | 0   | 0   | 0   | 0   | 0   | 0   | 0   | 0   | 0   |
| 2076 | 0   | 0   | 0   | 0   | 0   | 0   | 0   | 0   | 0   | 0   | 0   |
| 2077 | 0   | 0   | 0   | 0   | 0   | 0   | 0   | 0   | 0   | 0   | 0   |
| 2078 | 0   | 0   | 0   | 0   | 0   | 0   | 0   | 0   | 0   | 0   | 0   |
| 2079 | 0   | 0   | 0   | 0   | 0   | 0   | 0   | 0   | 0   | 0   | 0   |
| 2080 | 0   | 0   | 0   | 0   | 0   | 0   | 0   | 0   | 0   | 0   | 0   |
| 2081 | 0   | 0   | 0   | 0   | 0   | 0   | 0   | 0   | 0   | 0   | 0   |
| 2082 | 0   | 0   | 0   | 0   | 0   | 0   | 0   | 0   | 0   | 0   | 0   |
| 2083 | 0   | 0   | 0   | 0   | 0   | 0   | 0   | 0   | 0   | 0   | 0   |
| 2084 | 0   | 0   | 0   | 0   | 0   | 0   | 0   | 0   | 0   | 0   | 0   |
| 2085 | 0   | 0   | 0   | 0   | 0   | 0   | 0   | 0   | 0   | 0   | 0   |
| 2086 | 0   | 0   | 0   | 0   | 0   | 0   | 0   | 0   | 0   | 0   | 0   |
| 2087 | 0   | 0   | 0   | 0   | 0   | 0   | 0   | 0   | 0   | 0   | 0   |
| 2088 | 0   | 0   | 0   | 0   | 0   | 0   | 0   | 0   | 0   | 0   | 0   |
| 2089 | 0   | 0   | 0   | 0   | 0   | 0   | 0   | 0   | 0   | 0   | 0   |
| 2090 | 0   | 0   | 0   | 0   | 0   | 0   | 0   | 0   | 0   | 0   | 0   |

|      | 133 | 134 | 135 | 136 | 137 | 138 | 139 | 140 | 141 | 142 | 143 |
|------|-----|-----|-----|-----|-----|-----|-----|-----|-----|-----|-----|
| 2002 | 0   | 0   | 0   | 0   | 0   | 0   | 0   | 0   | 0   | 0   | 0   |
| 2003 | 0   | 0   | 0   | 0   | 0   | 0   | 0   | 0   | 0   | 0   | 0   |
| 2004 | 0   | 0   | 0   | 0   | 0   | 0   | 0   | 0   | 0   | 0   | 0   |
| 2005 | 0   | 0   | 0   | 0   | 0   | 0   | 0   | 0   | 0   | 0   | 0   |
| 2006 | 0   | 0   | 0   | 0   | 0   | 0   | 0   | 0   | 0   | 0   | 0   |
| 2007 | 0   | 0   | 0   | 0   | 0   | 0   | 0   | 0   | 0   | 0   | 0   |
| 2008 | 0   | 0   | 0   | 0   | 0   | 0   | 0   | 0   | 0   | 0   | 0   |
| 2009 | 0   | 0   | 0   | 0   | 0   | 0   | 0   | 0   | 0   | 0   | 0   |
| 2010 | 0   | 0   | 0   | 0   | 0   | 0   | 0   | 0   | 0   | 0   | 0   |
| 2011 | 0   | 0   | 0   | 0   | 0   | 0   | 0   | 0   | 0   | 0   | 0   |
| 2012 | 0   | 0   | 0   | 0   | 0   | 0   | 0   | 0   | 0   | 0   | 0   |
| 2013 | 0   | 0   | 0   | 0   | 0   | 0   | 0   | 0   | 0   | 0   | 0   |
| 2014 | 0   | 0   | 0   | 0   | 0   | 0   | 0   | 0   | 0   | 0   | 0   |
| 2015 | 0   | 0   | 0   | 0   | 0   | 0   | 0   | 0   | 0   | 0   | 0   |
| 2016 | 0   | 0   | 0   | 0   | 0   | 0   | 0   | 0   | 0   | 0   | 0   |
| 2017 | 0   | 0   | 0   | 0   | 0   | 0   | 0   | 0   | 0   | 0   | 0   |
| 2018 | 0   | 0   | 0   | 0   | 0   | 0   | 0   | 0   | 0   | 0   | 0   |
| 2019 | 0   | 0   | 0   | 0   | 0   | 0   | 0   | 0   | 0   | 0   | 0   |
| 2020 | 0   | 0   | 0   | 0   | 0   | 0   | 0   | 0   | 0   | 0   | 0   |
| 2021 | 0   | 0   | 0   | 0   | 0   | 0   | 0   | 0   | 0   | 0   | 0   |
| 2022 | 0   | 0   | 0   | 0   | 0   | 0   | 0   | 0   | 0   | 0   | 0   |
| 2023 | 0   | 0   | 0   | 0   | 0   | 0   | 0   | 0   | 0   | 0   | 0   |
| 2024 | 0   | 0   | 0   | 0   | 0   | 0   | 0   | 0   | 0   | 0   | 0   |
| 2025 | 0   | 0   | 0   | 0   | 0   | 0   | 0   | 0   | 0   | 0   | 0   |
| 2026 | 0   | 5   | 0   | 0   | 0   | 0   | 0   | 0   | 0   | 0   | 0   |
| 2027 | 0   | 11  | 2   | 0   | 0   | 0   | 0   | 0   | 0   | 0   | 0   |
| 2028 | 0   | 11  | 0   | 0   | 0   | 0   | 0   | 0   | 0   | 0   | 0   |
| 2029 | 0   | 10  | 0   | 0   | 0   | 0   | 0   | 0   | 0   | 0   | 0   |
| 2030 | 0   | 10  | 0   | 0   | 0   | 0   | 0   | 0   | 0   | 0   | 0   |
| 2031 | 0   | 12  | 0   | 0   | 0   | 0   | 0   | 0   | 0   | 0   | 0   |
| 2032 | 0   | 14  | 0   | 0   | 0   | 0   | 0   | 0   | 0   | 0   | 0   |
| 2033 | 0   | 14  | 0   | 0   | 0   | 0   | 0   | 0   | 0   | 0   | 0   |
| 2034 | 0   | 10  | 0   | 0   | 0   | 0   | 0   | 0   | 0   | 0   | 0   |
| 2035 | 0   | 8   | 0   | 0   | 0   | 0   | 0   | 0   | 0   | 0   | 0   |
| 2036 | 0   | 7   | 0   | 0   | 0   | 0   | 0   | 0   | 0   | 0   | 0   |
| 2037 | 0   | 7   | 0   | 0   | 0   | 0   | 0   | 0   | 0   | 0   | 0   |
| 2038 | 0   | 3   | 0   | 0   | 0   | 0   | 0   | 0   | 0   | 0   | 0   |
| 2039 | 0   | 2   | 0   | 0   | 0   | 0   | 0   | 0   | 0   | 0   | 0   |
| 2040 | 0   | 0   | 0   | 0   | 0   | 0   | 0   | 0   | 0   | 0   | 0   |
| 2041 | 0   | 0   | 0   | 0   | 0   | 0   | 0   | 0   | 0   | 0   | 0   |
| 2042 | 0   | 0   | 0   | 0   | 0   | 0   | 0   | 0   | 0   | 0   | 0   |
| 2043 | 0   | 0   | 0   | 0   | 0   | 0   | 0   | 0   | 0   | 0   | 0   |
| 2044 | 0   | 0   | 0   | 0   | 0   | 0   | 0   | 0   | 0   | 0   | 0   |
| 2045 | 0   | 0   | 0   | 0   | 0   | 0   | 0   | 0   | 0   | 0   | 0   |
| 2046 | 0   | 0   | 0   | 0   | 0   | 0   | 0   | 0   | 0   | 0   | 0   |
| 2047 | 0   | 0   | 0   | 0   | 0   | 0   | 0   | 0   | 0   | 0   | 0   |
| 2048 | 0   | 0   | 0   | 0   | 0   | 0   | 0   | 0   | 0   | 0   | 0   |
| 2049 | 0   | 0   | 0   | 0   | 0   | 0   | 0   | 0   | 0   | 0   | 0   |
| 2050 | 0   | 0   | 0   | 0   | 0   | 0   | 0   | 0   | 0   | 0   | 0   |
| 2051 | 0   | 0   | 0   | 0   | 0   | 0   | 0   | 0   | 0   | 0   | 0   |
| 2052 | 0   | 0   | 0   | 0   | 0   | 0   | 0   | 0   | 0   | 0   | 0   |
| 2053 | 0   | 0   | 0   | 0   | 0   | 0   | 0   | 0   | 0   | 0   | 0   |
| 2054 | 0   | 0   | 0   | 0   | 0   | 0   | 0   | 0   | 0   | 0   | 0   |
| 2055 | 0   | 0   | 0   | 0   | 0   | 0   | 0   | 0   | 0   | 0   | 0   |
| 2056 | 0   | 0   | 0   | 0   | 0   | 0   | 0   | 0   | 0   | 0   | 0   |
| 2057 | 0   | 0   | 0   | 0   | 0   | 0   | 0   | 0   | 0   | 0   | 0   |
| 2058 | 0   | 0   | 0   | 0   | 0   | 0   | 0   | 0   | 0   | 0   | 0   |
| 2059 | 0   | 0   | 0   | 0   | 0   | 0   | 0   | 0   | 0   | 0   | 0   |

|      | 133 | 134 | 135 | 136 | 137 | 138 | 139 | 140 | 141 | 142 | 143 |
|------|-----|-----|-----|-----|-----|-----|-----|-----|-----|-----|-----|
| 2060 | 0   | 0   | 0   | 0   | 0   | 0   | 0   | 0   | 0   | 0   | 0   |
| 2061 | 0   | 0   | 0   | 0   | 0   | 0   | 0   | 0   | 0   | 0   | 0   |
| 2062 | 0   | 0   | 0   | 0   | 0   | 0   | 0   | 0   | 0   | 0   | 0   |
| 2063 | 0   | 0   | 0   | 0   | 0   | 0   | 0   | 0   | 0   | 0   | 0   |
| 2064 | 0   | 0   | 0   | 0   | 0   | 0   | 0   | 0   | 0   | 0   | 0   |
| 2065 | 0   | 0   | 0   | 0   | 0   | 0   | 0   | 0   | 0   | 0   | 0   |
| 2066 | 0   | 0   | 0   | 0   | 0   | 0   | 0   | 0   | 0   | 0   | 0   |
| 2067 | 0   | 0   | 0   | 0   | 0   | 0   | 0   | 0   | 0   | 0   | 0   |
| 2068 | 0   | 0   | 0   | 0   | 0   | 0   | 0   | 0   | 0   | 0   | 0   |
| 2069 | 0   | 0   | 0   | 0   | 0   | 0   | 0   | 0   | 0   | 0   | 0   |
| 2070 | 0   | 0   | 0   | 0   | 0   | 0   | 0   | 0   | 0   | 0   | 0   |
| 2071 | 0   | 0   | 0   | 0   | 0   | 0   | 0   | 0   | 0   | 0   | 0   |
| 2072 | 0   | 0   | 0   | 0   | 0   | 0   | 0   | 0   | 0   | 0   | 0   |
| 2073 | 0   | 0   | 0   | 0   | 0   | 0   | 0   | 0   | 0   | 0   | 0   |
| 2074 | 0   | 0   | 0   | 0   | 0   | 0   | 0   | 0   | 0   | 0   | 0   |
| 2075 | 0   | 0   | 0   | 0   | 0   | 0   | 0   | 0   | 0   | 0   | 0   |
| 2076 | 0   | 0   | 0   | 0   | 0   | 0   | 0   | 0   | 0   | 0   | 0   |
| 2077 | 0   | 0   | 0   | 0   | 0   | 0   | 0   | 0   | 0   | 0   | 0   |
| 2078 | 0   | 0   | 0   | 0   | 0   | 0   | 0   | 0   | 0   | 0   | 0   |
| 2079 | 0   | 0   | 0   | 0   | 0   | 0   | 0   | 0   | 0   | 0   | 0   |
| 2080 | 0   | 0   | 0   | 0   | 0   | 0   | 0   | 0   | 0   | 0   | 0   |
| 2081 | 0   | 0   | 0   | 0   | 0   | 0   | 0   | 0   | 0   | 0   | 0   |
| 2082 | 0   | 0   | 0   | 0   | 0   | 0   | 0   | 0   | 0   | 0   | 0   |
| 2083 | 0   | 0   | 0   | 0   | 0   | 0   | 0   | 0   | 0   | 0   | 0   |
| 2084 | 0   | 0   | 0   | 0   | 0   | 0   | 0   | 0   | 0   | 0   | 0   |
| 2085 | 0   | 0   | 0   | 0   | 0   | 0   | 0   | 0   | 0   | 0   | 0   |
| 2086 | 0   | 0   | 0   | 0   | 0   | 0   | 0   | 0   | 0   | 0   | 0   |
| 2087 | 0   | 0   | 0   | 0   | 0   | 0   | 0   | 0   | 0   | 0   | 0   |
| 2088 | 0   | 0   | 0   | 0   | 0   | 0   | 0   | 0   | 0   | 0   | 0   |
| 2089 | 0   | 0   | 0   | 0   | 0   | 0   | 0   | 0   | 0   | 0   | 0   |
| 2090 | 0   | 0   | 0   | 0   | 0   | 0   | 0   | 0   | 0   | 0   | 0   |



|      | 144 | 145 | 146 | 147 | 148 | 149 | 150 | 151 | 152 | 153 | 154 |
|------|-----|-----|-----|-----|-----|-----|-----|-----|-----|-----|-----|
| 2002 | 0   | 0   | 0   | 0   | 0   | 0   | 0   | 0   | 0   | 0   | 0   |
| 2003 | 0   | 0   | 0   | 0   | 0   | 0   | 0   | 0   | 0   | 0   | 0   |
| 2004 | 0   | 0   | 0   | 0   | 0   | 0   | 0   | 0   | 0   | 0   | 0   |
| 2005 | 0   | 0   | 0   | 0   | 0   | 0   | 0   | 0   | 0   | 0   | 0   |
| 2006 | 0   | 0   | 0   | 0   | 0   | 0   | 0   | 0   | 0   | 0   | 0   |
| 2007 | 0   | 0   | 0   | 0   | 0   | 0   | 0   | 0   | 0   | 0   | 0   |
| 2008 | 0   | 0   | 0   | 0   | 0   | 0   | 0   | 0   | 0   | 0   | 0   |
| 2009 | 0   | 0   | 0   | 0   | 0   | 0   | 0   | 0   | 0   | 0   | 0   |
| 2010 | 0   | 0   | 0   | 0   | 0   | 0   | 0   | 0   | 0   | 0   | 0   |
| 2011 | 0   | 0   | 0   | 0   | 0   | 0   | 0   | 0   | 0   | 0   | 0   |
| 2012 | 0   | 0   | 0   | 0   | 0   | 0   | 0   | 0   | 0   | 0   | 0   |
| 2013 | 0   | 0   | 0   | 0   | 0   | 0   | 0   | 0   | 0   | 0   | 0   |
| 2014 | 0   | 0   | 0   | 0   | 0   | 0   | 0   | 0   | 0   | 0   | 0   |
| 2015 | 0   | 0   | 0   | 0   | 0   | 0   | 0   | 0   | 0   | 0   | 0   |
| 2016 | 0   | 0   | 0   | 0   | 0   | 0   | 0   | 0   | 0   | 0   | 0   |
| 2017 | 0   | 0   | 0   | 0   | 0   | 0   | 0   | 0   | 0   | 0   | 0   |
| 2018 | 0   | 0   | 0   | 0   | 0   | 0   | 0   | 0   | 0   | 0   | 0   |
| 2019 | 0   | 0   | 0   | 0   | 0   | 0   | 0   | 0   | 0   | 0   | 0   |
| 2020 | 0   | 0   | 0   | 0   | 0   | 0   | 0   | 0   | 0   | 0   | 0   |
| 2021 | 0   | 0   | 0   | 0   | 4   | 0   | 0   | 0   | 0   | 0   | 0   |
| 2022 | 0   | 0   | 0   | 0   | 4   | 0   | 0   | 0   | 0   | 0   | 0   |
| 2023 | 0   | 0   | 0   | 0   | 0   | 0   | 0   | 0   | 0   | 0   | 0   |
| 2024 | 0   | 0   | 0   | 0   | 0   | 0   | 0   | 0   | 0   | 0   | 0   |
| 2025 | 0   | 0   | 0   | 0   | 0   | 0   | 0   | 0   | 0   | 0   | 0   |
| 2026 | 0   | 0   | 0   | 0   | 0   | 0   | 0   | 0   | 29  | 0   | 9   |
| 2027 | 0   | 0   | 0   | 0   | 0   | 0   | 0   | 0   | 31  | 0   | 17  |
| 2028 | 0   | 0   | 0   | 0   | 0   | 0   | 0   | 0   | 31  | 0   | 5   |
| 2029 | 0   | 0   | 0   | 0   | 0   | 0   | 0   | 0   | 26  | 0   | 5   |
| 2030 | 0   | 0   | 0   | 0   | 0   | 0   | 0   | 0   | 12  | 0   | 5   |
| 2031 | 0   | 0   | 0   | 0   | 0   | 0   | 0   | 0   | 8   | 0   | 3   |
| 2032 | 0   | 0   | 0   | 0   | 0   | 0   | 0   | 0   | 7   | 0   | 2   |
| 2033 | 0   | 0   | 0   | 0   | 0   | 0   | 0   | 0   | 5   | 0   | 0   |
| 2034 | 0   | 0   | 0   | 0   | 0   | 0   | 0   | 0   | 5   | 0   | 0   |
| 2035 | 0   | 0   | 0   | 0   | 0   | 0   | 0   | 0   | 0   | 0   | 0   |
| 2036 | 0   | 0   | 0   | 0   | 0   | 0   | 0   | 0   | 0   | 0   | 0   |
| 2037 | 0   | 0   | 0   | 0   | 0   | 0   | 0   | 0   | 0   | 0   | 0   |
| 2038 | 0   | 0   | 0   | 0   | 0   | 0   | 0   | 0   | 0   | 0   | 0   |
| 2039 | 0   | 0   | 0   | 0   | 0   | 0   | 0   | 0   | 0   | 0   | 0   |
| 2040 | 0   | 0   | 0   | 0   | 0   | 0   | 0   | 0   | 0   | 0   | 0   |
| 2041 | 0   | 0   | 0   | 0   | 0   | 0   | 0   | 0   | 0   | 0   | 0   |
| 2042 | 0   | 0   | 0   | 0   | 0   | 0   | 0   | 0   | 0   | 0   | 0   |
| 2043 | 0   | 0   | 0   | 0   | 0   | 0   | 0   | 0   | 0   | 0   | 0   |
| 2044 | 0   | 0   | 0   | 0   | 0   | 0   | 0   | 0   | 0   | 0   | 0   |
| 2045 | 0   | 0   | 0   | 0   | 0   | 0   | 0   | 0   | 0   | 0   | 0   |
| 2046 | 0   | 0   | 0   | 0   | 0   | 0   | 0   | 0   | 0   | 0   | 0   |
| 2047 | 0   | 0   | 0   | 0   | 0   | 0   | 0   | 0   | 0   | 0   | 0   |
| 2048 | 0   | 0   | 0   | 0   | 0   | 0   | 0   | 0   | 0   | 0   | 0   |
| 2049 | 0   | 0   | 0   | 0   | 0   | 0   | 0   | 0   | 0   | 0   | 0   |
| 2050 | 0   | 0   | 0   | 0   | 0   | 0   | 0   | 0   | 0   | 0   | 0   |
| 2051 | 0   | 0   | 0   | 0   | 0   | 0   | 0   | 0   | 0   | 0   | 0   |
| 2052 | 0   | 0   | 0   | 0   | 0   | 0   | 0   | 0   | 0   | 0   | 0   |
| 2053 | 0   | 0   | 0   | 0   | 0   | 0   | 0   | 0   | 0   | 0   | 0   |
| 2054 | 0   | 0   | 0   | 0   | 0   | 0   | 0   | 0   | 0   | 0   | 0   |
| 2055 | 0   | 0   | 0   | 0   | 0   | 0   | 0   | 0   | 0   | 0   | 0   |
| 2056 | 0   | 0   | 0   | 0   | 0   | 0   | 0   | 0   | 0   | 0   | 0   |
| 2057 | 0   | 0   | 0   | 0   | 0   | 0   | 0   | 0   | 0   | 0   | 0   |
| 2058 | 0   | 0   | 0   | 0   | 0   | 0   | 0   | 0   | 0   | 0   | 0   |
| 2059 | 0   | 0   | 0   | 0   | 0   | 0   | 0   | 0   | 0   | 0   | 0   |

|      | 144 | 145 | 146 | 147 | 148 | 149 | 150 | 151 | 152 | 153 | 154 |
|------|-----|-----|-----|-----|-----|-----|-----|-----|-----|-----|-----|
| 2060 | 0   | 0   | 0   | 0   | 0   | 0   | 0   | 0   | 0   | 0   | 0   |
| 2061 | 0   | 0   | 0   | 0   | 0   | 0   | 0   | 0   | 0   | 0   | 0   |
| 2062 | 0   | 0   | 0   | 0   | 0   | 0   | 0   | 0   | 0   | 0   | 0   |
| 2063 | 0   | 0   | 0   | 0   | 0   | 0   | 0   | 0   | 0   | 0   | 0   |
| 2064 | 0   | 0   | 0   | 0   | 0   | 0   | 0   | 0   | 0   | 0   | 0   |
| 2065 | 0   | 0   | 0   | 0   | 0   | 0   | 0   | 0   | 0   | 0   | 0   |
| 2066 | 0   | 0   | 0   | 0   | 0   | 0   | 0   | 0   | 0   | 0   | 0   |
| 2067 | 0   | 0   | 0   | 0   | 0   | 0   | 0   | 0   | 0   | 0   | 0   |
| 2068 | 0   | 0   | 0   | 0   | 0   | 0   | 0   | 0   | 0   | 0   | 0   |
| 2069 | 0   | 0   | 0   | 0   | 0   | 0   | 0   | 0   | 0   | 0   | 0   |
| 2070 | 0   | 0   | 0   | 0   | 0   | 0   | 0   | 0   | 0   | 0   | 0   |
| 2071 | 0   | 0   | 0   | 0   | 0   | 0   | 0   | 0   | 0   | 0   | 0   |
| 2072 | 0   | 0   | 0   | 0   | 0   | 0   | 0   | 0   | 0   | 0   | 0   |
| 2073 | 0   | 0   | 0   | 0   | 0   | 0   | 0   | 0   | 0   | 0   | 0   |
| 2074 | 0   | 0   | 0   | 0   | 0   | 0   | 0   | 0   | 0   | 0   | 0   |
| 2075 | 0   | 0   | 0   | 0   | 0   | 0   | 0   | 0   | 0   | 0   | 0   |
| 2076 | 0   | 0   | 0   | 0   | 0   | 0   | 0   | 0   | 0   | 0   | 0   |
| 2077 | 0   | 0   | 0   | 0   | 0   | 0   | 0   | 0   | 0   | 0   | 0   |
| 2078 | 0   | 0   | 0   | 0   | 0   | 0   | 0   | 0   | 0   | 0   | 0   |
| 2079 | 0   | 0   | 0   | 0   | 0   | 0   | 0   | 0   | 0   | 0   | 0   |
| 2080 | 0   | 0   | 0   | 0   | 0   | 0   | 0   | 0   | 0   | 0   | 0   |
| 2081 | 0   | 0   | 0   | 0   | 0   | 0   | 0   | 0   | 0   | 0   | 0   |
| 2082 | 0   | 0   | 0   | 0   | 0   | 0   | 0   | 0   | 0   | 0   | 0   |
| 2083 | 0   | 0   | 0   | 0   | 0   | 0   | 0   | 0   | 0   | 0   | 0   |
| 2084 | 0   | 0   | 0   | 0   | 0   | 0   | 0   | 0   | 0   | 0   | 0   |
| 2085 | 0   | 0   | 0   | 0   | 0   | 0   | 0   | 0   | 0   | 0   | 0   |
| 2086 | 0   | 0   | 0   | 0   | 0   | 0   | 0   | 0   | 0   | 0   | 0   |
| 2087 | 0   | 0   | 0   | 0   | 0   | 0   | 0   | 0   | 0   | 0   | 0   |
| 2088 | 0   | 0   | 0   | 0   | 0   | 0   | 0   | 0   | 0   | 0   | 0   |
| 2089 | 0   | 0   | 0   | 0   | 0   | 0   | 0   | 0   | 0   | 0   | 0   |
| 2090 | 0   | 0   | 0   | 0   | 0   | 0   | 0   | 0   | 0   | 0   | 0   |

|      | 155 | 156 | 157 | 158 | 159 | 160 | 161 | 162 |
|------|-----|-----|-----|-----|-----|-----|-----|-----|
| 2002 | 0   | 0   | 0   | 0   | 0   | 0   | 0   | 0   |
| 2003 | 0   | 0   | 0   | 0   | 0   | 0   | 0   | 0   |
| 2004 | 0   | 0   | 0   | 0   | 0   | 0   | 0   | 0   |
| 2005 | 0   | 0   | 0   | 0   | 0   | 0   | 0   | 0   |
| 2006 | 0   | 0   | 0   | 0   | 0   | 0   | 0   | 0   |
| 2007 | 0   | 0   | 0   | 0   | 0   | 0   | 0   | 0   |
| 2008 | 0   | 0   | 0   | 0   | 0   | 0   | 0   | 0   |
| 2009 | 0   | 0   | 0   | 0   | 0   | 0   | 0   | 0   |
| 2010 | 0   | 0   | 0   | 0   | 0   | 0   | 0   | 0   |
| 2011 | 0   | 0   | 0   | 0   | 0   | 0   | 0   | 0   |
| 2012 | 0   | 0   | 0   | 0   | 0   | 0   | 0   | 0   |
| 2013 | 0   | 0   | 0   | 0   | 0   | 0   | 0   | 0   |
| 2014 | 0   | 0   | 0   | 0   | 0   | 0   | 0   | 0   |
| 2015 | 0   | 0   | 0   | 0   | 0   | 0   | 0   | 0   |
| 2016 | 0   | 0   | 0   | 0   | 0   | 0   | 0   | 0   |
| 2017 | 0   | 0   | 0   | 0   | 0   | 0   | 0   | 0   |
| 2018 | 0   | 0   | 0   | 0   | 0   | 0   | 0   | 0   |
| 2019 | 0   | 0   | 0   | 0   | 0   | 0   | 0   | 0   |
| 2020 | 0   | 0   | 0   | 0   | 0   | 0   | 0   | 0   |
| 2021 | 0   | 0   | 21  | 0   | 0   | 0   | 0   | 0   |
| 2022 | 0   | 0   | 12  | 0   | 0   | 0   | 0   | 0   |
| 2023 | 0   | 0   | 11  | 0   | 0   | 0   | 0   | 0   |
| 2024 | 0   | 0   | 7   | 0   | 0   | 0   | 0   | 0   |
| 2025 | 0   | 0   | 7   | 0   | 0   | 0   | 0   | 0   |
| 2026 | 0   | 0   | 3   | 3   | 1   | 0   | 57  | 3   |
| 2027 | 0   | 0   | 2   | 4   | 2   | 0   | 93  | 2   |
| 2028 | 0   | 0   | 0   | 0   | 0   | 0   | 105 | 0   |
| 2029 | 0   | 0   | 0   | 0   | 0   | 0   | 87  | 0   |
| 2030 | 0   | 0   | 0   | 0   | 0   | 0   | 67  | 0   |
| 2031 | 0   | 0   | 0   | 0   | 0   | 0   | 34  | 0   |
| 2032 | 0   | 0   | 0   | 0   | 0   | 0   | 26  | 0   |
| 2033 | 0   | 0   | 0   | 0   | 0   | 0   | 21  | 0   |
| 2034 | 0   | 0   | 0   | 0   | 0   | 0   | 13  | 0   |
| 2035 | 0   | 0   | 0   | 0   | 0   | 0   | 8   | 0   |
| 2036 | 0   | 0   | 0   | 0   | 0   | 0   | 7   | 0   |
| 2037 | 0   | 0   | 0   | 0   | 0   | 0   | 7   | 0   |
| 2038 | 0   | 0   | 0   | 0   | 0   | 0   | 3   | 0   |
| 2039 | 0   | 0   | 0   | 0   | 0   | 0   | 2   | 0   |
| 2040 | 0   | 0   | 0   | 0   | 0   | 0   | 0   | 0   |
| 2041 | 0   | 0   | 0   | 0   | 0   | 0   | 0   | 0   |
| 2042 | 0   | 0   | 0   | 0   | 0   | 0   | 0   | 0   |
| 2043 | 0   | 0   | 0   | 0   | 0   | 0   | 0   | 0   |
| 2044 | 0   | 0   | 0   | 0   | 0   | 0   | 0   | 0   |
| 2045 | 0   | 0   | 0   | 0   | 0   | 0   | 0   | 0   |
| 2046 | 0   | 0   | 0   | 0   | 0   | 0   | 0   | 0   |
| 2047 | 0   | 0   | 0   | 0   | 0   | 0   | 0   | 0   |
| 2048 | 0   | 0   | 0   | 0   | 0   | 0   | 0   | 0   |
| 2049 | 0   | 0   | 0   | 0   | 0   | 0   | 0   | 0   |
| 2050 | 0   | 0   | 0   | 0   | 0   | 0   | 0   | 0   |
| 2051 | 0   | 0   | 0   | 0   | 0   | 0   | 0   | 0   |
| 2052 | 0   | 0   | 0   | 0   | 0   | 0   | 0   | 0   |
| 2053 | 0   | 0   | 0   | 0   | 0   | 0   | 0   | 0   |
| 2054 | 0   | 0   | 0   | 0   | 0   | 0   | 0   | 0   |
| 2055 | 0   | 0   | 0   | 0   | 0   | 0   | 0   | 0   |
| 2056 | 0   | 0   | 0   | 0   | 0   | 0   | 0   | 0   |
| 2057 | 0   | 0   | 0   | 0   | 0   | 0   | 0   | 0   |
| 2058 | 0   | 0   | 0   | 0   | 0   | 0   | 0   | 0   |
| 2059 | 0   | 0   | 0   | 0   | 0   | 0   | 0   | 0   |

|      | 155 | 156 | 157 | 158 | 159 | 160 | 161 | 162 |
|------|-----|-----|-----|-----|-----|-----|-----|-----|
| 2060 | 0   | 0   | 0   | 0   | 0   | 0   | 0   | 0   |
| 2061 | 0   | 0   | 0   | 0   | 0   | 0   | 0   | 0   |
| 2062 | 0   | 0   | 0   | 0   | 0   | 0   | 0   | 0   |
| 2063 | 0   | 0   | 0   | 0   | 0   | 0   | 0   | 0   |
| 2064 | 0   | 0   | 0   | 0   | 0   | 0   | 0   | 0   |
| 2065 | 0   | 0   | 0   | 0   | 0   | 0   | 0   | 0   |
| 2066 | 0   | 0   | 0   | 0   | 0   | 0   | 0   | 0   |
| 2067 | 0   | 0   | 0   | 0   | 0   | 0   | 0   | 0   |
| 2068 | 0   | 0   | 0   | 0   | 0   | 0   | 0   | 0   |
| 2069 | 0   | 0   | 0   | 0   | 0   | 0   | 0   | 0   |
| 2070 | 0   | 0   | 0   | 0   | 0   | 0   | 0   | 0   |
| 2071 | 0   | 0   | 0   | 0   | 0   | 0   | 0   | 0   |
| 2072 | 0   | 0   | 0   | 0   | 0   | 0   | 0   | 0   |
| 2073 | 0   | 0   | 0   | 0   | 0   | 0   | 0   | 0   |
| 2074 | 0   | 0   | 0   | 0   | 0   | 0   | 0   | 0   |
| 2075 | 0   | 0   | 0   | 0   | 0   | 0   | 0   | 0   |
| 2076 | 0   | 0   | 0   | 0   | 0   | 0   | 0   | 0   |
| 2077 | 0   | 0   | 0   | 0   | 0   | 0   | 0   | 0   |
| 2078 | 0   | 0   | 0   | 0   | 0   | 0   | 0   | 0   |
| 2079 | 0   | 0   | 0   | 0   | 0   | 0   | 0   | 0   |
| 2080 | 0   | 0   | 0   | 0   | 0   | 0   | 0   | 0   |
| 2081 | 0   | 0   | 0   | 0   | 0   | 0   | 0   | 0   |
| 2082 | 0   | 0   | 0   | 0   | 0   | 0   | 0   | 0   |
| 2083 | 0   | 0   | 0   | 0   | 0   | 0   | 0   | 0   |
| 2084 | 0   | 0   | 0   | 0   | 0   | 0   | 0   | 0   |
| 2085 | 0   | 0   | 0   | 0   | 0   | 0   | 0   | 0   |
| 2086 | 0   | 0   | 0   | 0   | 0   | 0   | 0   | 0   |
| 2087 | 0   | 0   | 0   | 0   | 0   | 0   | 0   | 0   |
| 2088 | 0   | 0   | 0   | 0   | 0   | 0   | 0   | 0   |
| 2089 | 0   | 0   | 0   | 0   | 0   | 0   | 0   | 0   |
| 2090 | 0   | 0   | 0   | 0   | 0   | 0   | 0   | 0   |

|      | 1  | 2  | 3  | 4   | 5  | 6  | 7 | 8   | 9  | 10  | 11  | 12  |
|------|----|----|----|-----|----|----|---|-----|----|-----|-----|-----|
| 2002 | 0  | 0  | 0  | 0   | 0  | 0  | 0 | 0   | 0  | 0   | 0   | 0   |
| 2003 | 0  | 0  | 0  | 0   | 0  | 0  | 0 | 0   | 0  | 0   | 0   | 0   |
| 2004 | 0  | 0  | 0  | 0   | 0  | 0  | 0 | 0   | 0  | 0   | 0   | 0   |
| 2005 | 0  | 0  | 0  | 0   | 0  | 0  | 0 | 0   | 0  | 0   | 0   | 0   |
| 2006 | 0  | 0  | 0  | 0   | 0  | 0  | 0 | 0   | 0  | 0   | 0   | 0   |
| 2007 | 0  | 0  | 0  | 0   | 0  | 0  | 0 | 0   | 0  | 0   | 0   | 0   |
| 2008 | 0  | 0  | 0  | 0   | 0  | 0  | 0 | 0   | 0  | 0   | 0   | 0   |
| 2009 | 0  | 0  | 0  | 0   | 0  | 0  | 0 | 0   | 0  | 0   | 0   | 0   |
| 2010 | 0  | 0  | 0  | 0   | 0  | 0  | 0 | 0   | 0  | 0   | 0   | 0   |
| 2011 | 0  | 0  | 0  | 0   | 0  | 0  | 0 | 0   | 0  | 0   | 0   | 0   |
| 2012 | 0  | 0  | 0  | 0   | 0  | 0  | 0 | 0   | 0  | 0   | 0   | 0   |
| 2013 | 0  | 0  | 0  | 0   | 0  | 0  | 0 | 0   | 0  | 0   | 0   | 0   |
| 2014 | 0  | 0  | 0  | 0   | 0  | 0  | 0 | 0   | 0  | 0   | 0   | 0   |
| 2015 | 0  | 0  | 0  | 0   | 0  | 0  | 0 | 0   | 0  | 0   | 0   | 0   |
| 2016 | 0  | 0  | 0  | 0   | 0  | 0  | 0 | 0   | 0  | 0   | 0   | 0   |
| 2017 | 0  | 0  | 0  | 0   | 0  | 0  | 0 | 0   | 0  | 0   | 0   | 0   |
| 2018 | 0  | 0  | 0  | 0   | 0  | 0  | 0 | 0   | 0  | 0   | 0   | 0   |
| 2019 | 0  | 0  | 0  | 0   | 0  | 0  | 0 | 0   | 0  | 0   | 0   | 0   |
| 2020 | 0  | 0  | 0  | 0   | 0  | 0  | 0 | 0   | 0  | 0   | 0   | 0   |
| 2021 | 0  | 0  | 0  | 0   | 0  | 0  | 0 | 0   | 0  | 0   | 0   | 0   |
| 2022 | 0  | 0  | 0  | 0   | 0  | 0  | 0 | 0   | 0  | 0   | 0   | 0   |
| 2023 | 0  | 0  | 0  | 0   | 0  | 0  | 0 | 0   | 0  | 0   | 0   | 0   |
| 2024 | 0  | 0  | 0  | 0   | 0  | 0  | 0 | 0   | 0  | 0   | 0   | 0   |
| 2025 | 0  | 0  | 0  | 0   | 0  | 0  | 0 | 0   | 0  | 179 | 179 | 0   |
| 2026 | 0  | 0  | 0  | 0   | 0  | 0  | 0 | 0   | 0  | 325 | 318 | 0   |
| 2027 | 0  | 0  | 0  | 0   | 0  | 0  | 0 | 0   | 0  | 463 | 459 | 0   |
| 2028 | 0  | 0  | 0  | 0   | 0  | 0  | 0 | 0   | 0  | 513 | 504 | 0   |
| 2029 | 0  | 0  | 0  | 0   | 0  | 0  | 0 | 0   | 0  | 544 | 537 | 0   |
| 2030 | 0  | 0  | 0  | 0   | 0  | 0  | 0 | 0   | 0  | 547 | 540 | 184 |
| 2031 | 0  | 0  | 0  | 0   | 0  | 0  | 0 | 0   | 0  | 474 | 470 | 327 |
| 2032 | 0  | 0  | 0  | 1   | 0  | 0  | 0 | 7   | 0  | 444 | 442 | 444 |
| 2033 | 0  | 0  | 0  | 7   | 0  | 0  | 0 | 9   | 0  | 397 | 401 | 538 |
| 2034 | 0  | 0  | 0  | 24  | 0  | 0  | 0 | 44  | 0  | 404 | 409 | 591 |
| 2035 | 0  | 0  | 0  | 18  | 0  | 0  | 0 | 83  | 0  | 435 | 438 | 588 |
| 2036 | 0  | 1  | 0  | 54  | 2  | 0  | 0 | 160 | 1  | 385 | 386 | 544 |
| 2037 | 2  | 3  | 0  | 66  | 4  | 1  | 0 | 210 | 3  | 386 | 388 | 505 |
| 2038 | 4  | 6  | 0  | 100 | 9  | 2  | 0 | 261 | 6  | 404 | 403 | 489 |
| 2039 | 9  | 17 | 0  | 143 | 18 | 9  | 0 | 312 | 17 | 424 | 422 | 508 |
| 2040 | 15 | 24 | 0  | 166 | 37 | 24 | 0 | 367 | 24 | 428 | 427 | 516 |
| 2041 | 43 | 51 | 0  | 151 | 41 | 53 | 0 | 434 | 51 | 450 | 445 | 524 |
| 2042 | 64 | 67 | 1  | 124 | 79 | 85 | 0 | 455 | 67 | 439 | 437 | 464 |
| 2043 | 52 | 51 | 5  | 93  | 48 | 68 | 0 | 402 | 51 | 415 | 403 | 441 |
| 2044 | 30 | 26 | 30 | 68  | 28 | 46 | 0 | 356 | 26 | 411 | 406 | 410 |
| 2045 | 16 | 12 | 18 | 47  | 11 | 25 | 0 | 277 | 12 | 430 | 425 | 396 |
| 2046 | 4  | 3  | 8  | 31  | 8  | 13 | 0 | 252 | 3  | 427 | 419 | 387 |
| 2047 | 0  | 0  | 0  | 19  | 0  | 3  | 0 | 207 | 0  | 466 | 459 | 391 |
| 2048 | 0  | 0  | 0  | 10  | 0  | 0  | 0 | 178 | 0  | 488 | 481 | 309 |
| 2049 | 0  | 0  | 0  | 10  | 0  | 0  | 0 | 154 | 0  | 459 | 452 | 266 |
| 2050 | 0  | 0  | 0  | 0   | 0  | 0  | 0 | 114 | 0  | 417 | 411 | 235 |
| 2051 | 0  | 0  | 0  | 0   | 0  | 0  | 0 | 92  | 0  | 391 | 383 | 202 |
| 2052 | 0  | 0  | 0  | 0   | 0  | 0  | 0 | 70  | 0  | 351 | 342 | 179 |
| 2053 | 0  | 0  | 0  | 0   | 0  | 0  | 0 | 48  | 0  | 309 | 302 | 143 |
| 2054 | 0  | 0  | 0  | 0   | 0  | 0  | 0 | 33  | 0  | 274 | 268 | 118 |
| 2055 | 0  | 0  | 0  | 0   | 0  | 0  | 0 | 14  | 0  | 238 | 237 | 89  |
| 2056 | 0  | 0  | 0  | 0   | 0  | 0  | 0 | 7   | 0  | 221 | 219 | 83  |
| 2057 | 0  | 0  | 0  | 0   | 0  | 0  | 0 | 2   | 0  | 194 | 191 | 63  |
| 2058 | 0  | 0  | 0  | 0   | 0  | 0  | 0 | 0   | 0  | 175 | 174 | 58  |
| 2059 | 0  | 0  | 0  | 0   | 0  | 0  | 0 | 0   | 0  | 150 | 152 | 45  |
| 2060 | 0  | 0  | 0  | 0   | 0  | 0  | 0 | 0   | 0  | 124 | 126 | 35  |
| 2061 | 0  | 0  | 0  | 0   | 0  | 0  | 0 | 0   | 0  | 95  | 100 | 33  |
| 2062 | 0  | 0  | 0  | 0   | 0  | 0  | 0 | 0   | 0  | 65  | 67  | 18  |
| 2063 | 0  | 0  | 0  | 0   | 0  | 0  | 0 | 0   | 0  | 34  | 33  | 8   |
| 2064 | 0  | 0  | 0  | 0   | 0  | 0  | 0 | 0   | 0  | 7   | 7   | 0   |
| 2065 | 0  | 0  | 0  | 0   | 0  | 0  | 0 | 0   | 0  | 0   | 0   | 0   |
| 2066 | 0  | 0  | 0  | 0   | 0  | 0  | 0 | 0   | 0  | 0   | 0   | 0   |
| 2067 | 0  | 0  | 0  | 0   | 0  | 0  | 0 | 0   | 0  | 0   | 0   | 0   |
| 2068 | 0  | 0  | 0  | 0   | 0  | 0  | 0 | 0   | 0  | 0   | 0   | 0   |

|      | 1 | 2 | 3 | 4 | 5 | 6 | 7 | 8 | 9 | 10 | 11 | 12 |
|------|---|---|---|---|---|---|---|---|---|----|----|----|
| 2069 | 0 | 0 | 0 | 0 | 0 | 0 | 0 | 0 | 0 | 0  | 0  | 0  |
| 2070 | 0 | 0 | 0 | 0 | 0 | 0 | 0 | 0 | 0 | 0  | 0  | 0  |
| 2071 | 0 | 0 | 0 | 0 | 0 | 0 | 0 | 0 | 0 | 0  | 0  | 0  |
| 2072 | 0 | 0 | 0 | 0 | 0 | 0 | 0 | 0 | 0 | 0  | 0  | 0  |
| 2073 | 0 | 0 | 0 | 0 | 0 | 0 | 0 | 0 | 0 | 0  | 0  | 0  |
| 2074 | 0 | 0 | 0 | 0 | 0 | 0 | 0 | 0 | 0 | 0  | 0  | 0  |
| 2075 | 0 | 0 | 0 | 0 | 0 | 0 | 0 | 0 | 0 | 0  | 0  | 0  |
| 2076 | 0 | 0 | 0 | 0 | 0 | 0 | 0 | 0 | 0 | 0  | 0  | 0  |
| 2077 | 0 | 0 | 0 | 0 | 0 | 0 | 0 | 0 | 0 | 0  | 0  | 0  |
| 2078 | 0 | 0 | 0 | 0 | 0 | 0 | 0 | 0 | 0 | 0  | 0  | 0  |
| 2079 | 0 | 0 | 0 | 0 | 0 | 0 | 0 | 0 | 0 | 0  | 0  | 0  |
| 2080 | 0 | 0 | 0 | 0 | 0 | 0 | 0 | 0 | 0 | 0  | 0  | 0  |
| 2081 | 0 | 0 | 0 | 0 | 0 | 0 | 0 | 0 | 0 | 0  | 0  | 0  |
| 2082 | 0 | 0 | 0 | 0 | 0 | 0 | 0 | 0 | 0 | 0  | 0  | 0  |
| 2083 | 0 | 0 | 0 | 0 | 0 | 0 | 0 | 0 | 0 | 0  | 0  | 0  |
| 2084 | 0 | 0 | 0 | 0 | 0 | 0 | 0 | 0 | 0 | 0  | 0  | 0  |
| 2085 | 0 | 0 | 0 | 0 | 0 | 0 | 0 | 0 | 0 | 0  | 0  | 0  |
| 2086 | 0 | 0 | 0 | 0 | 0 | 0 | 0 | 0 | 0 | 0  | 0  | 0  |
| 2087 | 0 | 0 | 0 | 0 | 0 | 0 | 0 | 0 | 0 | 0  | 0  | 0  |
| 2088 | 0 | 0 | 0 | 0 | 0 | 0 | 0 | 0 | 0 | 0  | 0  | 0  |
| 2089 | 0 | 0 | 0 | 0 | 0 | 0 | 0 | 0 | 0 | 0  | 0  | 0  |
| 2090 | 0 | 0 | 0 | 0 | 0 | 0 | 0 | 0 | 0 | 0  | 0  | 0  |

|      | 13  | 14  | 15  | 16  | 17   | 18  | 19   | 20   | 21   | 22   | 23   | 24  |
|------|-----|-----|-----|-----|------|-----|------|------|------|------|------|-----|
| 2002 | 0   | 0   | 0   | 0   | 0    | 0   | 0    | 0    | 0    | 0    | 0    | 0   |
| 2003 | 0   | 0   | 0   | 0   | 0    | 0   | 0    | 0    | 0    | 0    | 0    | 0   |
| 2004 | 0   | 0   | 0   | 0   | 0    | 0   | 0    | 0    | 0    | 0    | 0    | 0   |
| 2005 | 0   | 0   | 0   | 0   | 0    | 0   | 0    | 0    | 0    | 0    | 0    | 0   |
| 2006 | 0   | 0   | 0   | 0   | 0    | 0   | 0    | 0    | 0    | 0    | 0    | 0   |
| 2007 | 0   | 0   | 0   | 0   | 0    | 0   | 0    | 0    | 0    | 0    | 0    | 0   |
| 2008 | 0   | 0   | 0   | 0   | 0    | 0   | 0    | 0    | 0    | 0    | 0    | 0   |
| 2009 | 0   | 0   | 0   | 0   | 0    | 0   | 0    | 0    | 0    | 0    | 0    | 0   |
| 2010 | 0   | 0   | 0   | 0   | 0    | 0   | 0    | 0    | 0    | 0    | 0    | 0   |
| 2011 | 0   | 0   | 0   | 0   | 0    | 0   | 0    | 0    | 0    | 0    | 0    | 0   |
| 2012 | 0   | 0   | 0   | 0   | 0    | 0   | 0    | 0    | 0    | 0    | 0    | 0   |
| 2013 | 0   | 0   | 0   | 0   | 0    | 0   | 0    | 0    | 0    | 0    | 0    | 0   |
| 2014 | 0   | 0   | 0   | 0   | 0    | 0   | 0    | 0    | 0    | 0    | 0    | 0   |
| 2015 | 0   | 0   | 0   | 0   | 0    | 0   | 0    | 0    | 0    | 0    | 0    | 0   |
| 2016 | 0   | 0   | 0   | 0   | 0    | 0   | 0    | 0    | 0    | 0    | 0    | 0   |
| 2017 | 0   | 0   | 0   | 0   | 0    | 0   | 0    | 0    | 0    | 0    | 0    | 0   |
| 2018 | 0   | 0   | 0   | 0   | 0    | 0   | 0    | 0    | 0    | 0    | 0    | 0   |
| 2019 | 0   | 0   | 0   | 0   | 0    | 0   | 0    | 0    | 0    | 0    | 0    | 0   |
| 2020 | 160 | 0   | 0   | 0   | 0    | 0   | 0    | 0    | 0    | 240  | 0    | 0   |
| 2021 | 317 | 0   | 0   | 0   | 0    | 0   | 0    | 0    | 0    | 476  | 0    | 0   |
| 2022 | 407 | 0   | 0   | 0   | 0    | 0   | 0    | 0    | 0    | 674  | 0    | 0   |
| 2023 | 431 | 0   | 0   | 0   | 0    | 0   | 0    | 0    | 0    | 851  | 0    | 0   |
| 2024 | 399 | 0   | 0   | 0   | 0    | 0   | 0    | 0    | 0    | 1012 | 0    | 0   |
| 2025 | 417 | 186 | 74  | 6   | 246  | 179 | 233  | 233  | 0    | 1127 | 238  | 187 |
| 2026 | 373 | 336 | 154 | 12  | 471  | 320 | 447  | 445  | 0    | 1163 | 475  | 311 |
| 2027 | 372 | 473 | 177 | 16  | 717  | 463 | 652  | 650  | 0    | 1182 | 715  | 438 |
| 2028 | 347 | 566 | 196 | 19  | 929  | 510 | 848  | 835  | 0    | 1156 | 927  | 485 |
| 2029 | 340 | 637 | 228 | 14  | 1111 | 541 | 980  | 972  | 0    | 1167 | 1110 | 478 |
| 2030 | 298 | 684 | 242 | 15  | 1307 | 539 | 1091 | 1072 | 240  | 1131 | 1271 | 506 |
| 2031 | 302 | 646 | 247 | 25  | 1459 | 472 | 1164 | 1143 | 446  | 1143 | 1383 | 486 |
| 2032 | 283 | 625 | 244 | 22  | 1602 | 444 | 1205 | 1193 | 625  | 1095 | 1471 | 488 |
| 2033 | 313 | 545 | 237 | 21  | 1656 | 398 | 1217 | 1215 | 800  | 1067 | 1556 | 518 |
| 2034 | 335 | 479 | 264 | 40  | 1780 | 416 | 1166 | 1164 | 900  | 1006 | 1620 | 507 |
| 2035 | 361 | 425 | 325 | 54  | 1901 | 443 | 1125 | 1124 | 1010 | 945  | 1681 | 561 |
| 2036 | 399 | 411 | 345 | 69  | 1969 | 390 | 1043 | 1042 | 1105 | 921  | 1627 | 589 |
| 2037 | 438 | 442 | 333 | 94  | 1981 | 391 | 990  | 986  | 1154 | 890  | 1495 | 576 |
| 2038 | 453 | 503 | 302 | 96  | 1983 | 401 | 930  | 928  | 1188 | 837  | 1413 | 578 |
| 2039 | 468 | 530 | 306 | 106 | 1973 | 411 | 887  | 883  | 1137 | 824  | 1306 | 557 |
| 2040 | 523 | 556 | 312 | 116 | 1984 | 426 | 887  | 875  | 1059 | 843  | 1268 | 522 |
| 2041 | 551 | 585 | 330 | 116 | 1959 | 446 | 879  | 879  | 1002 | 810  | 1228 | 509 |
| 2042 | 587 | 605 | 284 | 117 | 1889 | 435 | 882  | 887  | 981  | 790  | 1239 | 425 |
| 2043 | 600 | 653 | 274 | 111 | 1783 | 407 | 837  | 829  | 968  | 802  | 1190 | 416 |
| 2044 | 664 | 683 | 298 | 115 | 1681 | 404 | 815  | 815  | 932  | 723  | 1161 | 388 |
| 2045 | 717 | 692 | 295 | 132 | 1575 | 433 | 759  | 756  | 872  | 591  | 1122 | 372 |
| 2046 | 748 | 701 | 339 | 158 | 1540 | 443 | 701  | 706  | 851  | 495  | 999  | 380 |
| 2047 | 785 | 710 | 305 | 183 | 1521 | 475 | 575  | 579  | 732  | 380  | 790  | 273 |
| 2048 | 723 | 629 | 249 | 188 | 1464 | 485 | 429  | 440  | 555  | 281  | 626  | 224 |
| 2049 | 682 | 585 | 199 | 168 | 1281 | 457 | 344  | 353  | 441  | 244  | 537  | 180 |
| 2050 | 632 | 527 | 166 | 135 | 1169 | 414 | 279  | 286  | 346  | 214  | 477  | 124 |
| 2051 | 590 | 469 | 128 | 108 | 1073 | 388 | 212  | 216  | 268  | 179  | 417  | 85  |
| 2052 | 527 | 419 | 93  | 81  | 999  | 349 | 179  | 181  | 211  | 165  | 333  | 50  |
| 2053 | 478 | 384 | 67  | 56  | 891  | 309 | 139  | 145  | 159  | 148  | 263  | 31  |
| 2054 | 424 | 339 | 48  | 20  | 796  | 272 | 102  | 107  | 95   | 123  | 227  | 15  |
| 2055 | 369 | 310 | 30  | 4   | 710  | 239 | 89   | 94   | 74   | 104  | 171  | 0   |
| 2056 | 310 | 267 | 10  | 0   | 678  | 217 | 75   | 80   | 47   | 85   | 162  | 0   |
| 2057 | 260 | 226 | 0   | 0   | 639  | 187 | 58   | 61   | 27   | 55   | 107  | 0   |
| 2058 | 209 | 212 | 0   | 0   | 590  | 172 | 48   | 50   | 16   | 38   | 85   | 0   |
| 2059 | 163 | 173 | 0   | 0   | 549  | 141 | 34   | 36   | 12   | 12   | 68   | 0   |
| 2060 | 126 | 153 | 0   | 0   | 508  | 116 | 26   | 27   | 12   | 5    | 58   | 0   |
| 2061 | 76  | 135 | 0   | 0   | 467  | 87  | 17   | 18   | 12   | 0    | 53   | 0   |
| 2062 | 41  | 115 | 0   | 0   | 435  | 60  | 2    | 2    | 8    | 0    | 42   | 0   |
| 2063 | 15  | 94  | 0   | 0   | 396  | 31  | 0    | 0    | 6    | 0    | 39   | 0   |
| 2064 | 0   | 65  | 0   | 0   | 378  | 7   | 0    | 0    | 0    | 0    | 28   | 0   |
| 2065 | 0   | 44  | 0   | 0   | 325  | 0   | 0    | 0    | 0    | 0    | 18   | 0   |
| 2066 | 0   | 25  | 0   | 0   | 297  | 0   | 0    | 0    | 0    | 0    | 11   | 0   |
| 2067 | 0   | 8   | 0   | 0   | 261  | 0   | 0    | 0    | 0    | 0    | 0    | 0   |
| 2068 | 0   | 0   | 0   | 0   | 232  | 0   | 0    | 0    | 0    | 0    | 0    | 0   |

|      | 13 | 14 | 15 | 16 | 17  | 18 | 19 | 20 | 21 | 22 | 23 | 24 |
|------|----|----|----|----|-----|----|----|----|----|----|----|----|
| 2069 | 0  | 0  | 0  | 0  | 212 | 0  | 0  | 0  | 0  | 0  | 0  | 0  |
| 2070 | 0  | 0  | 0  | 0  | 187 | 0  | 0  | 0  | 0  | 0  | 0  | 0  |
| 2071 | 0  | 0  | 0  | 0  | 171 | 0  | 0  | 0  | 0  | 0  | 0  | 0  |
| 2072 | 0  | 0  | 0  | 0  | 138 | 0  | 0  | 0  | 0  | 0  | 0  | 0  |
| 2073 | 0  | 0  | 0  | 0  | 116 | 0  | 0  | 0  | 0  | 0  | 0  | 0  |
| 2074 | 0  | 0  | 0  | 0  | 89  | 0  | 0  | 0  | 0  | 0  | 0  | 0  |
| 2075 | 0  | 0  | 0  | 0  | 58  | 0  | 0  | 0  | 0  | 0  | 0  | 0  |
| 2076 | 0  | 0  | 0  | 0  | 36  | 0  | 0  | 0  | 0  | 0  | 0  | 0  |
| 2077 | 0  | 0  | 0  | 0  | 10  | 0  | 0  | 0  | 0  | 0  | 0  | 0  |
| 2078 | 0  | 0  | 0  | 0  | 0   | 0  | 0  | 0  | 0  | 0  | 0  | 0  |
| 2079 | 0  | 0  | 0  | 0  | 0   | 0  | 0  | 0  | 0  | 0  | 0  | 0  |
| 2080 | 0  | 0  | 0  | 0  | 0   | 0  | 0  | 0  | 0  | 0  | 0  | 0  |
| 2081 | 0  | 0  | 0  | 0  | 0   | 0  | 0  | 0  | 0  | 0  | 0  | 0  |
| 2082 | 0  | 0  | 0  | 0  | 0   | 0  | 0  | 0  | 0  | 0  | 0  | 0  |
| 2083 | 0  | 0  | 0  | 0  | 0   | 0  | 0  | 0  | 0  | 0  | 0  | 0  |
| 2084 | 0  | 0  | 0  | 0  | 0   | 0  | 0  | 0  | 0  | 0  | 0  | 0  |
| 2085 | 0  | 0  | 0  | 0  | 0   | 0  | 0  | 0  | 0  | 0  | 0  | 0  |
| 2086 | 0  | 0  | 0  | 0  | 0   | 0  | 0  | 0  | 0  | 0  | 0  | 0  |
| 2087 | 0  | 0  | 0  | 0  | 0   | 0  | 0  | 0  | 0  | 0  | 0  | 0  |
| 2088 | 0  | 0  | 0  | 0  | 0   | 0  | 0  | 0  | 0  | 0  | 0  | 0  |
| 2089 | 0  | 0  | 0  | 0  | 0   | 0  | 0  | 0  | 0  | 0  | 0  | 0  |
| 2090 | 0  | 0  | 0  | 0  | 0   | 0  | 0  | 0  | 0  | 0  | 0  | 0  |



|      | 25  | 26   | 27   | 28 | 29 | 30 | 31  | 32 | 33 | 34 | 35  | 36 |
|------|-----|------|------|----|----|----|-----|----|----|----|-----|----|
| 2002 | 0   | 0    | 0    | 0  | 0  | 0  | 0   | 0  | 0  | 0  | 0   | 0  |
| 2003 | 0   | 0    | 0    | 0  | 0  | 0  | 0   | 0  | 0  | 0  | 0   | 0  |
| 2004 | 0   | 0    | 0    | 0  | 0  | 0  | 0   | 0  | 0  | 0  | 0   | 0  |
| 2005 | 0   | 0    | 0    | 0  | 0  | 0  | 0   | 0  | 0  | 0  | 0   | 0  |
| 2006 | 0   | 0    | 0    | 0  | 0  | 0  | 0   | 0  | 0  | 0  | 0   | 0  |
| 2007 | 0   | 0    | 0    | 0  | 0  | 0  | 0   | 0  | 0  | 0  | 0   | 0  |
| 2008 | 0   | 0    | 0    | 0  | 0  | 0  | 0   | 0  | 0  | 0  | 0   | 0  |
| 2009 | 0   | 0    | 0    | 0  | 0  | 0  | 0   | 0  | 0  | 0  | 0   | 0  |
| 2010 | 0   | 0    | 0    | 0  | 0  | 0  | 0   | 0  | 0  | 0  | 0   | 0  |
| 2011 | 0   | 0    | 0    | 0  | 0  | 0  | 0   | 0  | 0  | 0  | 0   | 0  |
| 2012 | 0   | 0    | 0    | 0  | 0  | 0  | 0   | 0  | 0  | 0  | 0   | 0  |
| 2013 | 0   | 0    | 0    | 0  | 0  | 0  | 0   | 0  | 0  | 0  | 0   | 0  |
| 2014 | 0   | 0    | 0    | 0  | 0  | 0  | 0   | 0  | 0  | 0  | 0   | 0  |
| 2015 | 0   | 0    | 0    | 0  | 0  | 0  | 0   | 0  | 0  | 0  | 0   | 0  |
| 2016 | 0   | 0    | 0    | 0  | 0  | 0  | 0   | 0  | 0  | 0  | 0   | 0  |
| 2017 | 0   | 0    | 0    | 0  | 0  | 0  | 0   | 0  | 0  | 0  | 0   | 0  |
| 2018 | 0   | 0    | 0    | 0  | 0  | 0  | 0   | 0  | 0  | 0  | 0   | 0  |
| 2019 | 0   | 0    | 0    | 0  | 0  | 0  | 0   | 0  | 0  | 0  | 0   | 0  |
| 2020 | 0   | 0    | 0    | 0  | 0  | 0  | 0   | 0  | 0  | 0  | 0   | 0  |
| 2021 | 0   | 0    | 0    | 0  | 0  | 0  | 0   | 0  | 0  | 0  | 0   | 0  |
| 2022 | 0   | 0    | 0    | 0  | 0  | 0  | 0   | 0  | 0  | 0  | 0   | 0  |
| 2023 | 0   | 0    | 0    | 0  | 0  | 0  | 0   | 0  | 0  | 0  | 0   | 0  |
| 2024 | 0   | 0    | 0    | 0  | 0  | 0  | 0   | 0  | 0  | 0  | 0   | 0  |
| 2025 | 186 | 249  | 233  | 0  | 0  | 0  | 0   | 0  | 0  | 0  | 0   | 0  |
| 2026 | 302 | 493  | 447  | 0  | 0  | 0  | 0   | 0  | 0  | 0  | 0   | 0  |
| 2027 | 367 | 744  | 654  | 0  | 0  | 0  | 0   | 0  | 0  | 0  | 0   | 0  |
| 2028 | 364 | 979  | 847  | 0  | 0  | 0  | 0   | 0  | 0  | 0  | 0   | 0  |
| 2029 | 329 | 1180 | 984  | 0  | 0  | 0  | 0   | 0  | 0  | 0  | 0   | 0  |
| 2030 | 332 | 1405 | 1090 | 0  | 0  | 0  | 0   | 0  | 0  | 0  | 0   | 0  |
| 2031 | 252 | 1613 | 1155 | 0  | 0  | 0  | 0   | 0  | 0  | 0  | 0   | 0  |
| 2032 | 217 | 1812 | 1197 | 0  | 0  | 0  | 0   | 0  | 0  | 0  | 7   | 0  |
| 2033 | 217 | 1989 | 1212 | 0  | 0  | 0  | 7   | 0  | 0  | 0  | 9   | 0  |
| 2034 | 252 | 2171 | 1173 | 0  | 0  | 0  | 19  | 0  | 0  | 0  | 44  | 0  |
| 2035 | 237 | 2350 | 1129 | 0  | 0  | 0  | 26  | 0  | 0  | 0  | 83  | 0  |
| 2036 | 203 | 2489 | 1048 | 0  | 1  | 0  | 56  | 2  | 0  | 0  | 160 | 1  |
| 2037 | 171 | 2634 | 990  | 2  | 3  | 0  | 70  | 4  | 0  | 0  | 203 | 3  |
| 2038 | 185 | 2730 | 935  | 4  | 6  | 0  | 98  | 9  | 2  | 0  | 256 | 6  |
| 2039 | 170 | 2789 | 896  | 9  | 11 | 0  | 151 | 17 | 7  | 0  | 294 | 11 |
| 2040 | 194 | 2885 | 901  | 12 | 18 | 0  | 175 | 33 | 13 | 0  | 350 | 14 |
| 2041 | 190 | 2934 | 897  | 43 | 49 | 0  | 148 | 32 | 30 | 0  | 427 | 47 |
| 2042 | 170 | 3006 | 903  | 56 | 62 | 1  | 121 | 56 | 48 | 0  | 443 | 60 |
| 2043 | 161 | 2970 | 841  | 45 | 47 | 2  | 89  | 35 | 58 | 0  | 399 | 45 |
| 2044 | 130 | 2912 | 813  | 26 | 28 | 27 | 61  | 16 | 38 | 0  | 351 | 26 |
| 2045 | 153 | 2864 | 741  | 11 | 14 | 17 | 40  | 3  | 22 | 0  | 271 | 12 |
| 2046 | 132 | 2691 | 673  | 2  | 4  | 8  | 27  | 1  | 9  | 0  | 246 | 4  |
| 2047 | 104 | 2406 | 553  | 0  | 0  | 0  | 18  | 0  | 5  | 0  | 201 | 0  |
| 2048 | 66  | 2191 | 420  | 0  | 0  | 0  | 9   | 0  | 1  | 0  | 170 | 0  |
| 2049 | 50  | 1988 | 332  | 0  | 0  | 0  | 9   | 0  | 0  | 0  | 146 | 0  |
| 2050 | 33  | 1733 | 268  | 0  | 0  | 0  | 0   | 0  | 0  | 0  | 110 | 0  |
| 2051 | 22  | 1549 | 201  | 0  | 0  | 0  | 0   | 0  | 0  | 0  | 87  | 0  |
| 2052 | 13  | 1403 | 172  | 0  | 0  | 0  | 0   | 0  | 0  | 0  | 65  | 0  |
| 2053 | 0   | 1180 | 139  | 0  | 0  | 0  | 0   | 0  | 0  | 0  | 45  | 0  |
| 2054 | 0   | 1026 | 101  | 0  | 0  | 0  | 0   | 0  | 0  | 0  | 30  | 0  |
| 2055 | 0   | 868  | 90   | 0  | 0  | 0  | 0   | 0  | 0  | 0  | 15  | 0  |
| 2056 | 0   | 747  | 77   | 0  | 0  | 0  | 0   | 0  | 0  | 0  | 8   | 0  |
| 2057 | 0   | 628  | 60   | 0  | 0  | 0  | 0   | 0  | 0  | 0  | 3   | 0  |
| 2058 | 0   | 552  | 51   | 0  | 0  | 0  | 0   | 0  | 0  | 0  | 0   | 0  |
| 2059 | 0   | 485  | 37   | 0  | 0  | 0  | 0   | 0  | 0  | 0  | 0   | 0  |
| 2060 | 0   | 387  | 28   | 0  | 0  | 0  | 0   | 0  | 0  | 0  | 0   | 0  |
| 2061 | 0   | 325  | 19   | 0  | 0  | 0  | 0   | 0  | 0  | 0  | 0   | 0  |
| 2062 | 0   | 265  | 2    | 0  | 0  | 0  | 0   | 0  | 0  | 0  | 0   | 0  |
| 2063 | 0   | 217  | 0    | 0  | 0  | 0  | 0   | 0  | 0  | 0  | 0   | 0  |
| 2064 | 0   | 178  | 0    | 0  | 0  | 0  | 0   | 0  | 0  | 0  | 0   | 0  |
| 2065 | 0   | 134  | 0    | 0  | 0  | 0  | 0   | 0  | 0  | 0  | 0   | 0  |
| 2066 | 0   | 112  | 0    | 0  | 0  | 0  | 0   | 0  | 0  | 0  | 0   | 0  |
| 2067 | 0   | 98   | 0    | 0  | 0  | 0  | 0   | 0  | 0  | 0  | 0   | 0  |
| 2068 | 0   | 80   | 0    | 0  | 0  | 0  | 0   | 0  | 0  | 0  | 0   | 0  |

|      | 25 | 26 | 27 | 28 | 29 | 30 | 31 | 32 | 33 | 34 | 35 | 36 |
|------|----|----|----|----|----|----|----|----|----|----|----|----|
| 2069 | 0  | 69 | 0  | 0  | 0  | 0  | 0  | 0  | 0  | 0  | 0  | 0  |
| 2070 | 0  | 59 | 0  | 0  | 0  | 0  | 0  | 0  | 0  | 0  | 0  | 0  |
| 2071 | 0  | 50 | 0  | 0  | 0  | 0  | 0  | 0  | 0  | 0  | 0  | 0  |
| 2072 | 0  | 36 | 0  | 0  | 0  | 0  | 0  | 0  | 0  | 0  | 0  | 0  |
| 2073 | 0  | 26 | 0  | 0  | 0  | 0  | 0  | 0  | 0  | 0  | 0  | 0  |
| 2074 | 0  | 17 | 0  | 0  | 0  | 0  | 0  | 0  | 0  | 0  | 0  | 0  |
| 2075 | 0  | 3  | 0  | 0  | 0  | 0  | 0  | 0  | 0  | 0  | 0  | 0  |
| 2076 | 0  | 0  | 0  | 0  | 0  | 0  | 0  | 0  | 0  | 0  | 0  | 0  |
| 2077 | 0  | 0  | 0  | 0  | 0  | 0  | 0  | 0  | 0  | 0  | 0  | 0  |
| 2078 | 0  | 0  | 0  | 0  | 0  | 0  | 0  | 0  | 0  | 0  | 0  | 0  |
| 2079 | 0  | 0  | 0  | 0  | 0  | 0  | 0  | 0  | 0  | 0  | 0  | 0  |
| 2080 | 0  | 0  | 0  | 0  | 0  | 0  | 0  | 0  | 0  | 0  | 0  | 0  |
| 2081 | 0  | 0  | 0  | 0  | 0  | 0  | 0  | 0  | 0  | 0  | 0  | 0  |
| 2082 | 0  | 0  | 0  | 0  | 0  | 0  | 0  | 0  | 0  | 0  | 0  | 0  |
| 2083 | 0  | 0  | 0  | 0  | 0  | 0  | 0  | 0  | 0  | 0  | 0  | 0  |
| 2084 | 0  | 0  | 0  | 0  | 0  | 0  | 0  | 0  | 0  | 0  | 0  | 0  |
| 2085 | 0  | 0  | 0  | 0  | 0  | 0  | 0  | 0  | 0  | 0  | 0  | 0  |
| 2086 | 0  | 0  | 0  | 0  | 0  | 0  | 0  | 0  | 0  | 0  | 0  | 0  |
| 2087 | 0  | 0  | 0  | 0  | 0  | 0  | 0  | 0  | 0  | 0  | 0  | 0  |
| 2088 | 0  | 0  | 0  | 0  | 0  | 0  | 0  | 0  | 0  | 0  | 0  | 0  |
| 2089 | 0  | 0  | 0  | 0  | 0  | 0  | 0  | 0  | 0  | 0  | 0  | 0  |
| 2090 | 0  | 0  | 0  | 0  | 0  | 0  | 0  | 0  | 0  | 0  | 0  | 0  |

|      | 37  | 38  | 39  | 40  | 41  | 42  | 43  | 44   | 45  | 46   | 47   | 48   |
|------|-----|-----|-----|-----|-----|-----|-----|------|-----|------|------|------|
| 2002 | 0   | 0   | 0   | 0   | 0   | 0   | 0   | 0    | 0   | 0    | 0    | 0    |
| 2003 | 0   | 0   | 0   | 0   | 0   | 0   | 0   | 0    | 0   | 0    | 0    | 0    |
| 2004 | 0   | 0   | 0   | 0   | 0   | 0   | 0   | 0    | 0   | 0    | 0    | 0    |
| 2005 | 0   | 0   | 0   | 0   | 0   | 0   | 0   | 0    | 0   | 0    | 0    | 0    |
| 2006 | 0   | 0   | 0   | 0   | 0   | 0   | 0   | 0    | 0   | 0    | 0    | 0    |
| 2007 | 0   | 0   | 0   | 0   | 0   | 0   | 0   | 0    | 0   | 0    | 0    | 0    |
| 2008 | 0   | 0   | 0   | 0   | 0   | 0   | 0   | 0    | 0   | 0    | 0    | 0    |
| 2009 | 0   | 0   | 0   | 0   | 0   | 0   | 0   | 0    | 0   | 0    | 0    | 0    |
| 2010 | 0   | 0   | 0   | 0   | 0   | 0   | 0   | 0    | 0   | 0    | 0    | 0    |
| 2011 | 0   | 0   | 0   | 0   | 0   | 0   | 0   | 0    | 0   | 0    | 0    | 0    |
| 2012 | 0   | 0   | 0   | 0   | 0   | 0   | 0   | 0    | 0   | 0    | 0    | 0    |
| 2013 | 0   | 0   | 0   | 0   | 0   | 0   | 0   | 0    | 0   | 0    | 0    | 0    |
| 2014 | 0   | 0   | 0   | 0   | 0   | 0   | 0   | 0    | 0   | 0    | 0    | 0    |
| 2015 | 0   | 0   | 0   | 0   | 0   | 0   | 0   | 0    | 0   | 0    | 0    | 0    |
| 2016 | 0   | 0   | 0   | 0   | 0   | 0   | 0   | 0    | 0   | 0    | 0    | 0    |
| 2017 | 0   | 0   | 0   | 0   | 0   | 0   | 0   | 0    | 0   | 0    | 0    | 0    |
| 2018 | 0   | 0   | 0   | 0   | 0   | 0   | 0   | 0    | 0   | 0    | 0    | 0    |
| 2019 | 0   | 0   | 0   | 0   | 0   | 0   | 0   | 0    | 0   | 0    | 0    | 0    |
| 2020 | 0   | 0   | 0   | 160 | 0   | 0   | 0   | 0    | 0   | 0    | 0    | 0    |
| 2021 | 0   | 0   | 0   | 317 | 0   | 0   | 0   | 0    | 0   | 0    | 0    | 0    |
| 2022 | 0   | 0   | 0   | 407 | 0   | 0   | 0   | 0    | 0   | 0    | 0    | 0    |
| 2023 | 0   | 0   | 0   | 426 | 0   | 0   | 0   | 0    | 0   | 0    | 0    | 0    |
| 2024 | 0   | 0   | 0   | 396 | 0   | 0   | 0   | 0    | 0   | 0    | 0    | 0    |
| 2025 | 179 | 179 | 0   | 414 | 186 | 74  | 6   | 246  | 179 | 233  | 233  | 0    |
| 2026 | 324 | 317 | 0   | 371 | 332 | 154 | 11  | 469  | 319 | 445  | 443  | 0    |
| 2027 | 462 | 455 | 0   | 373 | 465 | 177 | 15  | 715  | 462 | 647  | 642  | 0    |
| 2028 | 512 | 499 | 0   | 348 | 562 | 191 | 16  | 922  | 508 | 838  | 827  | 0    |
| 2029 | 543 | 534 | 0   | 335 | 638 | 216 | 9   | 1102 | 537 | 979  | 970  | 0    |
| 2030 | 543 | 539 | 184 | 292 | 677 | 235 | 13  | 1288 | 535 | 1089 | 1067 | 240  |
| 2031 | 469 | 465 | 327 | 287 | 621 | 248 | 20  | 1428 | 460 | 1162 | 1141 | 441  |
| 2032 | 443 | 439 | 442 | 262 | 603 | 264 | 17  | 1575 | 436 | 1203 | 1192 | 622  |
| 2033 | 397 | 394 | 532 | 287 | 517 | 261 | 17  | 1642 | 394 | 1219 | 1220 | 793  |
| 2034 | 401 | 399 | 588 | 310 | 450 | 280 | 24  | 1764 | 406 | 1163 | 1163 | 899  |
| 2035 | 419 | 420 | 589 | 329 | 399 | 330 | 26  | 1885 | 418 | 1130 | 1127 | 1003 |
| 2036 | 369 | 370 | 538 | 381 | 387 | 331 | 37  | 1948 | 361 | 1049 | 1049 | 1093 |
| 2037 | 380 | 378 | 484 | 397 | 420 | 320 | 72  | 1978 | 372 | 1002 | 999  | 1136 |
| 2038 | 399 | 403 | 474 | 394 | 471 | 285 | 80  | 1994 | 378 | 943  | 934  | 1169 |
| 2039 | 412 | 419 | 491 | 427 | 502 | 294 | 84  | 1975 | 374 | 905  | 884  | 1120 |
| 2040 | 411 | 423 | 504 | 486 | 539 | 310 | 106 | 1968 | 398 | 939  | 884  | 1046 |
| 2041 | 433 | 450 | 512 | 512 | 558 | 325 | 105 | 1950 | 434 | 920  | 878  | 995  |
| 2042 | 421 | 444 | 453 | 528 | 584 | 274 | 110 | 1889 | 427 | 902  | 871  | 994  |
| 2043 | 394 | 417 | 430 | 538 | 616 | 252 | 111 | 1779 | 410 | 840  | 831  | 972  |
| 2044 | 391 | 407 | 397 | 622 | 648 | 266 | 115 | 1680 | 406 | 814  | 816  | 936  |
| 2045 | 406 | 415 | 392 | 670 | 653 | 278 | 129 | 1578 | 417 | 756  | 762  | 877  |
| 2046 | 403 | 402 | 387 | 703 | 670 | 325 | 148 | 1520 | 419 | 685  | 716  | 847  |
| 2047 | 460 | 446 | 386 | 683 | 665 | 269 | 182 | 1511 | 469 | 564  | 582  | 744  |
| 2048 | 479 | 460 | 291 | 605 | 587 | 202 | 180 | 1429 | 473 | 425  | 438  | 561  |
| 2049 | 447 | 435 | 254 | 559 | 554 | 151 | 156 | 1262 | 442 | 335  | 353  | 436  |
| 2050 | 408 | 397 | 222 | 518 | 497 | 126 | 121 | 1149 | 400 | 280  | 282  | 340  |
| 2051 | 379 | 372 | 196 | 478 | 450 | 96  | 99  | 1061 | 374 | 209  | 212  | 273  |
| 2052 | 341 | 332 | 172 | 423 | 405 | 66  | 73  | 985  | 330 | 178  | 184  | 218  |
| 2053 | 294 | 295 | 137 | 375 | 360 | 48  | 52  | 881  | 288 | 144  | 144  | 165  |
| 2054 | 256 | 264 | 108 | 332 | 317 | 30  | 17  | 786  | 258 | 108  | 105  | 100  |
| 2055 | 226 | 230 | 86  | 284 | 292 | 17  | 4   | 704  | 232 | 90   | 86   | 78   |
| 2056 | 207 | 212 | 80  | 238 | 245 | 4   | 0   | 670  | 211 | 72   | 70   | 50   |
| 2057 | 175 | 185 | 61  | 196 | 206 | 0   | 0   | 624  | 179 | 56   | 51   | 29   |
| 2058 | 155 | 168 | 55  | 151 | 192 | 0   | 0   | 577  | 159 | 42   | 41   | 17   |
| 2059 | 128 | 143 | 41  | 115 | 153 | 0   | 0   | 529  | 130 | 30   | 29   | 12   |
| 2060 | 108 | 121 | 33  | 84  | 135 | 0   | 0   | 494  | 106 | 24   | 24   | 12   |
| 2061 | 83  | 92  | 28  | 49  | 115 | 0   | 0   | 452  | 82  | 15   | 15   | 12   |
| 2062 | 56  | 63  | 14  | 17  | 97  | 0   | 0   | 419  | 56  | 1    | 2    | 10   |
| 2063 | 27  | 31  | 6   | 3   | 74  | 0   | 0   | 388  | 29  | 0    | 0    | 5    |
| 2064 | 5   | 7   | 0   | 0   | 54  | 0   | 0   | 360  | 7   | 0    | 0    | 0    |
| 2065 | 0   | 0   | 0   | 0   | 35  | 0   | 0   | 306  | 0   | 0    | 0    | 0    |
| 2066 | 0   | 0   | 0   | 0   | 18  | 0   | 0   | 281  | 0   | 0    | 0    | 0    |
| 2067 | 0   | 0   | 0   | 0   | 4   | 0   | 0   | 251  | 0   | 0    | 0    | 0    |
| 2068 | 0   | 0   | 0   | 0   | 0   | 0   | 0   | 225  | 0   | 0    | 0    | 0    |

|      | 37 | 38 | 39 | 40 | 41 | 42 | 43 | 44  | 45 | 46 | 47 | 48 |
|------|----|----|----|----|----|----|----|-----|----|----|----|----|
| 2069 | 0  | 0  | 0  | 0  | 0  | 0  | 0  | 205 | 0  | 0  | 0  | 0  |
| 2070 | 0  | 0  | 0  | 0  | 0  | 0  | 0  | 178 | 0  | 0  | 0  | 0  |
| 2071 | 0  | 0  | 0  | 0  | 0  | 0  | 0  | 157 | 0  | 0  | 0  | 0  |
| 2072 | 0  | 0  | 0  | 0  | 0  | 0  | 0  | 129 | 0  | 0  | 0  | 0  |
| 2073 | 0  | 0  | 0  | 0  | 0  | 0  | 0  | 105 | 0  | 0  | 0  | 0  |
| 2074 | 0  | 0  | 0  | 0  | 0  | 0  | 0  | 83  | 0  | 0  | 0  | 0  |
| 2075 | 0  | 0  | 0  | 0  | 0  | 0  | 0  | 56  | 0  | 0  | 0  | 0  |
| 2076 | 0  | 0  | 0  | 0  | 0  | 0  | 0  | 34  | 0  | 0  | 0  | 0  |
| 2077 | 0  | 0  | 0  | 0  | 0  | 0  | 0  | 10  | 0  | 0  | 0  | 0  |
| 2078 | 0  | 0  | 0  | 0  | 0  | 0  | 0  | 0   | 0  | 0  | 0  | 0  |
| 2079 | 0  | 0  | 0  | 0  | 0  | 0  | 0  | 0   | 0  | 0  | 0  | 0  |
| 2080 | 0  | 0  | 0  | 0  | 0  | 0  | 0  | 0   | 0  | 0  | 0  | 0  |
| 2081 | 0  | 0  | 0  | 0  | 0  | 0  | 0  | 0   | 0  | 0  | 0  | 0  |
| 2082 | 0  | 0  | 0  | 0  | 0  | 0  | 0  | 0   | 0  | 0  | 0  | 0  |
| 2083 | 0  | 0  | 0  | 0  | 0  | 0  | 0  | 0   | 0  | 0  | 0  | 0  |
| 2084 | 0  | 0  | 0  | 0  | 0  | 0  | 0  | 0   | 0  | 0  | 0  | 0  |
| 2085 | 0  | 0  | 0  | 0  | 0  | 0  | 0  | 0   | 0  | 0  | 0  | 0  |
| 2086 | 0  | 0  | 0  | 0  | 0  | 0  | 0  | 0   | 0  | 0  | 0  | 0  |
| 2087 | 0  | 0  | 0  | 0  | 0  | 0  | 0  | 0   | 0  | 0  | 0  | 0  |
| 2088 | 0  | 0  | 0  | 0  | 0  | 0  | 0  | 0   | 0  | 0  | 0  | 0  |
| 2089 | 0  | 0  | 0  | 0  | 0  | 0  | 0  | 0   | 0  | 0  | 0  | 0  |
| 2090 | 0  | 0  | 0  | 0  | 0  | 0  | 0  | 0   | 0  | 0  | 0  | 0  |

|      | 49   | 50   | 51  | 52  | 53   | 54   | 55 | 56 | 57 | 58  | 59 | 60 |
|------|------|------|-----|-----|------|------|----|----|----|-----|----|----|
| 2002 | 0    | 0    | 0   | 0   | 0    | 0    | 0  | 0  | 0  | 0   | 0  | 0  |
| 2003 | 0    | 0    | 0   | 0   | 0    | 0    | 0  | 0  | 0  | 0   | 0  | 0  |
| 2004 | 0    | 0    | 0   | 0   | 0    | 0    | 0  | 0  | 0  | 0   | 0  | 0  |
| 2005 | 0    | 0    | 0   | 0   | 0    | 0    | 0  | 0  | 0  | 0   | 0  | 0  |
| 2006 | 0    | 0    | 0   | 0   | 0    | 0    | 0  | 0  | 0  | 0   | 0  | 0  |
| 2007 | 0    | 0    | 0   | 0   | 0    | 0    | 0  | 0  | 0  | 0   | 0  | 0  |
| 2008 | 0    | 0    | 0   | 0   | 0    | 0    | 0  | 0  | 0  | 0   | 0  | 0  |
| 2009 | 0    | 0    | 0   | 0   | 0    | 0    | 0  | 0  | 0  | 0   | 0  | 0  |
| 2010 | 0    | 0    | 0   | 0   | 0    | 0    | 0  | 0  | 0  | 0   | 0  | 0  |
| 2011 | 0    | 0    | 0   | 0   | 0    | 0    | 0  | 0  | 0  | 0   | 0  | 0  |
| 2012 | 0    | 0    | 0   | 0   | 0    | 0    | 0  | 0  | 0  | 0   | 0  | 0  |
| 2013 | 0    | 0    | 0   | 0   | 0    | 0    | 0  | 0  | 0  | 0   | 0  | 0  |
| 2014 | 0    | 0    | 0   | 0   | 0    | 0    | 0  | 0  | 0  | 0   | 0  | 0  |
| 2015 | 0    | 0    | 0   | 0   | 0    | 0    | 0  | 0  | 0  | 0   | 0  | 0  |
| 2016 | 0    | 0    | 0   | 0   | 0    | 0    | 0  | 0  | 0  | 0   | 0  | 0  |
| 2017 | 0    | 0    | 0   | 0   | 0    | 0    | 0  | 0  | 0  | 0   | 0  | 0  |
| 2018 | 0    | 0    | 0   | 0   | 0    | 0    | 0  | 0  | 0  | 0   | 0  | 0  |
| 2019 | 0    | 0    | 0   | 0   | 0    | 0    | 0  | 0  | 0  | 0   | 0  | 0  |
| 2020 | 240  | 0    | 0   | 0   | 0    | 0    | 0  | 0  | 0  | 0   | 0  | 0  |
| 2021 | 474  | 0    | 0   | 0   | 0    | 0    | 0  | 0  | 0  | 0   | 0  | 0  |
| 2022 | 671  | 0    | 0   | 0   | 0    | 0    | 0  | 0  | 0  | 0   | 0  | 0  |
| 2023 | 844  | 0    | 0   | 0   | 0    | 0    | 0  | 0  | 0  | 0   | 0  | 0  |
| 2024 | 1007 | 0    | 0   | 0   | 0    | 0    | 0  | 0  | 0  | 0   | 0  | 0  |
| 2025 | 1122 | 238  | 187 | 186 | 249  | 233  | 0  | 0  | 0  | 0   | 0  | 0  |
| 2026 | 1165 | 475  | 311 | 302 | 491  | 445  | 0  | 0  | 0  | 0   | 0  | 0  |
| 2027 | 1181 | 711  | 438 | 362 | 735  | 646  | 0  | 0  | 0  | 0   | 0  | 0  |
| 2028 | 1160 | 921  | 482 | 354 | 959  | 833  | 0  | 0  | 0  | 0   | 0  | 0  |
| 2029 | 1172 | 1106 | 477 | 327 | 1164 | 975  | 0  | 0  | 0  | 0   | 0  | 0  |
| 2030 | 1135 | 1266 | 502 | 335 | 1385 | 1077 | 0  | 0  | 0  | 0   | 0  | 0  |
| 2031 | 1147 | 1378 | 486 | 256 | 1593 | 1147 | 0  | 0  | 0  | 0   | 0  | 0  |
| 2032 | 1093 | 1461 | 490 | 219 | 1790 | 1196 | 0  | 0  | 0  | 0   | 0  | 0  |
| 2033 | 1071 | 1545 | 523 | 216 | 1965 | 1213 | 0  | 0  | 0  | 4   | 0  | 0  |
| 2034 | 1008 | 1607 | 507 | 248 | 2149 | 1169 | 0  | 0  | 0  | 13  | 0  | 0  |
| 2035 | 958  | 1673 | 563 | 236 | 2335 | 1133 | 0  | 0  | 0  | 14  | 0  | 0  |
| 2036 | 923  | 1640 | 596 | 206 | 2452 | 1041 | 0  | 0  | 0  | 25  | 0  | 0  |
| 2037 | 882  | 1509 | 586 | 175 | 2595 | 998  | 0  | 0  | 0  | 37  | 1  | 0  |
| 2038 | 837  | 1421 | 591 | 181 | 2704 | 936  | 0  | 0  | 0  | 85  | 2  | 2  |
| 2039 | 826  | 1323 | 577 | 171 | 2767 | 887  | 0  | 0  | 0  | 116 | 1  | 3  |
| 2040 | 838  | 1282 | 551 | 200 | 2875 | 905  | 0  | 0  | 0  | 155 | 3  | 5  |
| 2041 | 810  | 1222 | 541 | 187 | 2926 | 894  | 6  | 5  | 0  | 159 | 9  | 8  |
| 2042 | 809  | 1228 | 462 | 160 | 2997 | 894  | 11 | 14 | 0  | 137 | 21 | 30 |
| 2043 | 813  | 1184 | 435 | 167 | 2967 | 840  | 27 | 20 | 0  | 111 | 43 | 52 |
| 2044 | 726  | 1170 | 386 | 139 | 2932 | 822  | 31 | 32 | 0  | 84  | 69 | 70 |
| 2045 | 584  | 1146 | 384 | 157 | 2889 | 770  | 16 | 20 | 0  | 66  | 48 | 44 |
| 2046 | 489  | 1014 | 363 | 132 | 2714 | 694  | 12 | 11 | 4  | 43  | 30 | 28 |
| 2047 | 356  | 808  | 269 | 98  | 2417 | 569  | 6  | 7  | 0  | 20  | 18 | 10 |
| 2048 | 266  | 633  | 221 | 60  | 2201 | 429  | 4  | 3  | 0  | 12  | 10 | 3  |
| 2049 | 231  | 546  | 176 | 41  | 1997 | 337  | 0  | 0  | 0  | 6   | 4  | 1  |
| 2050 | 205  | 481  | 118 | 27  | 1743 | 286  | 0  | 0  | 0  | 0   | 1  | 0  |
| 2051 | 171  | 419  | 81  | 19  | 1562 | 207  | 0  | 0  | 0  | 0   | 0  | 0  |
| 2052 | 155  | 331  | 48  | 11  | 1415 | 175  | 0  | 0  | 0  | 0   | 0  | 0  |
| 2053 | 139  | 257  | 30  | 0   | 1195 | 142  | 0  | 0  | 0  | 0   | 0  | 0  |
| 2054 | 114  | 213  | 15  | 0   | 1048 | 108  | 0  | 0  | 0  | 0   | 0  | 0  |
| 2055 | 96   | 166  | 0   | 0   | 892  | 89   | 0  | 0  | 0  | 0   | 0  | 0  |
| 2056 | 76   | 158  | 0   | 0   | 772  | 69   | 0  | 0  | 0  | 0   | 0  | 0  |
| 2057 | 49   | 106  | 0   | 0   | 655  | 51   | 0  | 0  | 0  | 0   | 0  | 0  |
| 2058 | 34   | 82   | 0   | 0   | 575  | 40   | 0  | 0  | 0  | 0   | 0  | 0  |
| 2059 | 9    | 67   | 0   | 0   | 495  | 31   | 0  | 0  | 0  | 0   | 0  | 0  |
| 2060 | 5    | 48   | 0   | 0   | 396  | 25   | 0  | 0  | 0  | 0   | 0  | 0  |
| 2061 | 0    | 44   | 0   | 0   | 334  | 15   | 0  | 0  | 0  | 0   | 0  | 0  |
| 2062 | 0    | 34   | 0   | 0   | 281  | 2    | 0  | 0  | 0  | 0   | 0  | 0  |
| 2063 | 0    | 32   | 0   | 0   | 222  | 0    | 0  | 0  | 0  | 0   | 0  | 0  |
| 2064 | 0    | 23   | 0   | 0   | 184  | 0    | 0  | 0  | 0  | 0   | 0  | 0  |
| 2065 | 0    | 15   | 0   | 0   | 137  | 0    | 0  | 0  | 0  | 0   | 0  | 0  |
| 2066 | 0    | 8    | 0   | 0   | 117  | 0    | 0  | 0  | 0  | 0   | 0  | 0  |
| 2067 | 0    | 0    | 0   | 0   | 105  | 0    | 0  | 0  | 0  | 0   | 0  | 0  |
| 2068 | 0    | 0    | 0   | 0   | 77   | 0    | 0  | 0  | 0  | 0   | 0  | 0  |

|      | 49 | 50 | 51 | 52 | 53 | 54 | 55 | 56 | 57 | 58 | 59 | 60 |
|------|----|----|----|----|----|----|----|----|----|----|----|----|
| 2069 | 0  | 0  | 0  | 0  | 62 | 0  | 0  | 0  | 0  | 0  | 0  | 0  |
| 2070 | 0  | 0  | 0  | 0  | 50 | 0  | 0  | 0  | 0  | 0  | 0  | 0  |
| 2071 | 0  | 0  | 0  | 0  | 39 | 0  | 0  | 0  | 0  | 0  | 0  | 0  |
| 2072 | 0  | 0  | 0  | 0  | 29 | 0  | 0  | 0  | 0  | 0  | 0  | 0  |
| 2073 | 0  | 0  | 0  | 0  | 23 | 0  | 0  | 0  | 0  | 0  | 0  | 0  |
| 2074 | 0  | 0  | 0  | 0  | 15 | 0  | 0  | 0  | 0  | 0  | 0  | 0  |
| 2075 | 0  | 0  | 0  | 0  | 3  | 0  | 0  | 0  | 0  | 0  | 0  | 0  |
| 2076 | 0  | 0  | 0  | 0  | 0  | 0  | 0  | 0  | 0  | 0  | 0  | 0  |
| 2077 | 0  | 0  | 0  | 0  | 0  | 0  | 0  | 0  | 0  | 0  | 0  | 0  |
| 2078 | 0  | 0  | 0  | 0  | 0  | 0  | 0  | 0  | 0  | 0  | 0  | 0  |
| 2079 | 0  | 0  | 0  | 0  | 0  | 0  | 0  | 0  | 0  | 0  | 0  | 0  |
| 2080 | 0  | 0  | 0  | 0  | 0  | 0  | 0  | 0  | 0  | 0  | 0  | 0  |
| 2081 | 0  | 0  | 0  | 0  | 0  | 0  | 0  | 0  | 0  | 0  | 0  | 0  |
| 2082 | 0  | 0  | 0  | 0  | 0  | 0  | 0  | 0  | 0  | 0  | 0  | 0  |
| 2083 | 0  | 0  | 0  | 0  | 0  | 0  | 0  | 0  | 0  | 0  | 0  | 0  |
| 2084 | 0  | 0  | 0  | 0  | 0  | 0  | 0  | 0  | 0  | 0  | 0  | 0  |
| 2085 | 0  | 0  | 0  | 0  | 0  | 0  | 0  | 0  | 0  | 0  | 0  | 0  |
| 2086 | 0  | 0  | 0  | 0  | 0  | 0  | 0  | 0  | 0  | 0  | 0  | 0  |
| 2087 | 0  | 0  | 0  | 0  | 0  | 0  | 0  | 0  | 0  | 0  | 0  | 0  |
| 2088 | 0  | 0  | 0  | 0  | 0  | 0  | 0  | 0  | 0  | 0  | 0  | 0  |
| 2089 | 0  | 0  | 0  | 0  | 0  | 0  | 0  | 0  | 0  | 0  | 0  | 0  |
| 2090 | 0  | 0  | 0  | 0  | 0  | 0  | 0  | 0  | 0  | 0  | 0  | 0  |

|      | 61 | 62  | 63 | 64  | 65  | 66  | 67  | 68  | 69  | 70  | 71   | 72  |
|------|----|-----|----|-----|-----|-----|-----|-----|-----|-----|------|-----|
| 2002 | 0  | 0   | 0  | 0   | 0   | 0   | 0   | 0   | 0   | 0   | 0    | 0   |
| 2003 | 0  | 0   | 0  | 0   | 0   | 0   | 0   | 0   | 0   | 0   | 0    | 0   |
| 2004 | 0  | 0   | 0  | 0   | 0   | 0   | 0   | 0   | 0   | 0   | 0    | 0   |
| 2005 | 0  | 0   | 0  | 0   | 0   | 0   | 0   | 0   | 0   | 0   | 0    | 0   |
| 2006 | 0  | 0   | 0  | 0   | 0   | 0   | 0   | 0   | 0   | 0   | 0    | 0   |
| 2007 | 0  | 0   | 0  | 0   | 0   | 0   | 0   | 0   | 0   | 0   | 0    | 0   |
| 2008 | 0  | 0   | 0  | 0   | 0   | 0   | 0   | 0   | 0   | 0   | 0    | 0   |
| 2009 | 0  | 0   | 0  | 0   | 0   | 0   | 0   | 0   | 0   | 0   | 0    | 0   |
| 2010 | 0  | 0   | 0  | 0   | 0   | 0   | 0   | 0   | 0   | 0   | 0    | 0   |
| 2011 | 0  | 0   | 0  | 0   | 0   | 0   | 0   | 0   | 0   | 0   | 0    | 0   |
| 2012 | 0  | 0   | 0  | 0   | 0   | 0   | 0   | 0   | 0   | 0   | 0    | 0   |
| 2013 | 0  | 0   | 0  | 0   | 0   | 0   | 0   | 0   | 0   | 0   | 0    | 0   |
| 2014 | 0  | 0   | 0  | 0   | 0   | 0   | 0   | 0   | 0   | 0   | 0    | 0   |
| 2015 | 0  | 0   | 0  | 0   | 0   | 0   | 0   | 0   | 0   | 0   | 0    | 0   |
| 2016 | 0  | 0   | 0  | 0   | 0   | 0   | 0   | 0   | 0   | 0   | 0    | 0   |
| 2017 | 0  | 0   | 0  | 0   | 0   | 0   | 0   | 0   | 0   | 0   | 0    | 0   |
| 2018 | 0  | 0   | 0  | 0   | 0   | 0   | 0   | 0   | 0   | 0   | 0    | 0   |
| 2019 | 0  | 0   | 0  | 0   | 0   | 0   | 0   | 0   | 0   | 0   | 0    | 0   |
| 2020 | 0  | 0   | 0  | 0   | 0   | 0   | 160 | 0   | 0   | 0   | 0    | 0   |
| 2021 | 0  | 0   | 0  | 0   | 0   | 0   | 313 | 0   | 0   | 0   | 0    | 0   |
| 2022 | 0  | 0   | 0  | 0   | 0   | 0   | 375 | 0   | 0   | 0   | 0    | 0   |
| 2023 | 0  | 0   | 0  | 0   | 0   | 0   | 398 | 0   | 0   | 0   | 0    | 0   |
| 2024 | 0  | 0   | 0  | 0   | 0   | 0   | 394 | 0   | 0   | 0   | 0    | 0   |
| 2025 | 0  | 0   | 0  | 179 | 179 | 0   | 444 | 186 | 74  | 6   | 246  | 179 |
| 2026 | 0  | 0   | 0  | 338 | 291 | 0   | 411 | 339 | 134 | 6   | 573  | 297 |
| 2027 | 0  | 0   | 0  | 459 | 411 | 0   | 411 | 494 | 146 | 7   | 875  | 429 |
| 2028 | 0  | 0   | 0  | 506 | 475 | 0   | 383 | 649 | 172 | 15  | 1181 | 495 |
| 2029 | 0  | 0   | 0  | 534 | 531 | 0   | 368 | 728 | 201 | 10  | 1367 | 532 |
| 2030 | 0  | 0   | 0  | 546 | 548 | 184 | 311 | 759 | 231 | 12  | 1541 | 546 |
| 2031 | 0  | 0   | 0  | 502 | 504 | 302 | 309 | 707 | 277 | 23  | 1686 | 499 |
| 2032 | 0  | 0   | 0  | 505 | 504 | 422 | 285 | 698 | 308 | 17  | 1840 | 502 |
| 2033 | 0  | 1   | 0  | 470 | 475 | 538 | 337 | 614 | 297 | 17  | 1926 | 470 |
| 2034 | 0  | 7   | 0  | 457 | 467 | 611 | 361 | 554 | 318 | 20  | 2017 | 459 |
| 2035 | 0  | 18  | 0  | 461 | 461 | 626 | 364 | 488 | 347 | 23  | 2153 | 461 |
| 2036 | 0  | 32  | 0  | 416 | 419 | 564 | 378 | 477 | 324 | 36  | 2167 | 416 |
| 2037 | 0  | 51  | 0  | 385 | 399 | 519 | 360 | 488 | 325 | 55  | 2170 | 384 |
| 2038 | 0  | 103 | 0  | 379 | 399 | 530 | 368 | 504 | 297 | 61  | 2111 | 388 |
| 2039 | 0  | 157 | 0  | 395 | 410 | 534 | 395 | 523 | 307 | 69  | 2079 | 398 |
| 2040 | 0  | 233 | 0  | 437 | 448 | 542 | 451 | 571 | 312 | 92  | 2073 | 433 |
| 2041 | 0  | 276 | 8  | 468 | 477 | 560 | 480 | 582 | 311 | 82  | 2036 | 462 |
| 2042 | 0  | 281 | 11 | 494 | 483 | 486 | 506 | 594 | 262 | 94  | 2022 | 487 |
| 2043 | 4  | 310 | 28 | 476 | 468 | 460 | 530 | 605 | 265 | 107 | 1985 | 469 |
| 2044 | 0  | 316 | 26 | 484 | 471 | 434 | 598 | 628 | 280 | 112 | 1985 | 480 |
| 2045 | 0  | 241 | 14 | 520 | 509 | 430 | 545 | 638 | 288 | 122 | 1944 | 524 |
| 2046 | 0  | 219 | 12 | 486 | 480 | 405 | 497 | 657 | 272 | 126 | 1870 | 485 |
| 2047 | 0  | 176 | 6  | 459 | 486 | 429 | 462 | 624 | 207 | 123 | 1723 | 452 |
| 2048 | 0  | 146 | 4  | 383 | 407 | 381 | 409 | 532 | 165 | 99  | 1524 | 376 |
| 2049 | 0  | 127 | 0  | 346 | 371 | 340 | 372 | 475 | 109 | 78  | 1316 | 341 |
| 2050 | 0  | 93  | 0  | 282 | 303 | 288 | 333 | 412 | 88  | 58  | 1174 | 278 |
| 2051 | 0  | 68  | 0  | 249 | 264 | 252 | 293 | 368 | 63  | 43  | 1081 | 236 |
| 2052 | 0  | 48  | 0  | 209 | 229 | 200 | 251 | 334 | 38  | 23  | 978  | 203 |
| 2053 | 0  | 32  | 0  | 180 | 196 | 160 | 216 | 311 | 26  | 10  | 872  | 177 |
| 2054 | 0  | 23  | 0  | 161 | 176 | 124 | 183 | 285 | 11  | 1   | 783  | 155 |
| 2055 | 0  | 18  | 0  | 144 | 152 | 91  | 137 | 262 | 0   | 0   | 709  | 139 |
| 2056 | 0  | 13  | 0  | 129 | 139 | 83  | 107 | 215 | 0   | 0   | 655  | 126 |
| 2057 | 0  | 6   | 0  | 100 | 108 | 63  | 67  | 176 | 0   | 0   | 600  | 98  |
| 2058 | 0  | 4   | 0  | 82  | 92  | 60  | 41  | 160 | 0   | 0   | 512  | 81  |
| 2059 | 0  | 2   | 0  | 61  | 72  | 48  | 20  | 131 | 0   | 0   | 430  | 62  |
| 2060 | 0  | 0   | 0  | 47  | 57  | 44  | 5   | 110 | 0   | 0   | 398  | 47  |
| 2061 | 0  | 0   | 0  | 29  | 41  | 40  | 0   | 96  | 0   | 0   | 350  | 30  |
| 2062 | 0  | 0   | 0  | 9   | 18  | 23  | 0   | 76  | 0   | 0   | 296  | 10  |
| 2063 | 0  | 0   | 0  | 3   | 10  | 11  | 0   | 62  | 0   | 0   | 240  | 4   |
| 2064 | 0  | 0   | 0  | 0   | 0   | 1   | 0   | 38  | 0   | 0   | 217  | 0   |
| 2065 | 0  | 0   | 0  | 0   | 0   | 0   | 0   | 25  | 0   | 0   | 186  | 0   |
| 2066 | 0  | 0   | 0  | 0   | 0   | 0   | 0   | 12  | 0   | 0   | 168  | 0   |
| 2067 | 0  | 0   | 0  | 0   | 0   | 0   | 0   | 1   | 0   | 0   | 152  | 0   |
| 2068 | 0  | 0   | 0  | 0   | 0   | 0   | 0   | 0   | 0   | 0   | 138  | 0   |

|      | 61 | 62 | 63 | 64 | 65 | 66 | 67 | 68 | 69 | 70 | 71  | 72 |
|------|----|----|----|----|----|----|----|----|----|----|-----|----|
| 2069 | 0  | 0  | 0  | 0  | 0  | 0  | 0  | 0  | 0  | 0  | 122 | 0  |
| 2070 | 0  | 0  | 0  | 0  | 0  | 0  | 0  | 0  | 0  | 0  | 97  | 0  |
| 2071 | 0  | 0  | 0  | 0  | 0  | 0  | 0  | 0  | 0  | 0  | 79  | 0  |
| 2072 | 0  | 0  | 0  | 0  | 0  | 0  | 0  | 0  | 0  | 0  | 62  | 0  |
| 2073 | 0  | 0  | 0  | 0  | 0  | 0  | 0  | 0  | 0  | 0  | 45  | 0  |
| 2074 | 0  | 0  | 0  | 0  | 0  | 0  | 0  | 0  | 0  | 0  | 29  | 0  |
| 2075 | 0  | 0  | 0  | 0  | 0  | 0  | 0  | 0  | 0  | 0  | 11  | 0  |
| 2076 | 0  | 0  | 0  | 0  | 0  | 0  | 0  | 0  | 0  | 0  | 4   | 0  |
| 2077 | 0  | 0  | 0  | 0  | 0  | 0  | 0  | 0  | 0  | 0  | 0   | 0  |
| 2078 | 0  | 0  | 0  | 0  | 0  | 0  | 0  | 0  | 0  | 0  | 0   | 0  |
| 2079 | 0  | 0  | 0  | 0  | 0  | 0  | 0  | 0  | 0  | 0  | 0   | 0  |
| 2080 | 0  | 0  | 0  | 0  | 0  | 0  | 0  | 0  | 0  | 0  | 0   | 0  |
| 2081 | 0  | 0  | 0  | 0  | 0  | 0  | 0  | 0  | 0  | 0  | 0   | 0  |
| 2082 | 0  | 0  | 0  | 0  | 0  | 0  | 0  | 0  | 0  | 0  | 0   | 0  |
| 2083 | 0  | 0  | 0  | 0  | 0  | 0  | 0  | 0  | 0  | 0  | 0   | 0  |
| 2084 | 0  | 0  | 0  | 0  | 0  | 0  | 0  | 0  | 0  | 0  | 0   | 0  |
| 2085 | 0  | 0  | 0  | 0  | 0  | 0  | 0  | 0  | 0  | 0  | 0   | 0  |
| 2086 | 0  | 0  | 0  | 0  | 0  | 0  | 0  | 0  | 0  | 0  | 0   | 0  |
| 2087 | 0  | 0  | 0  | 0  | 0  | 0  | 0  | 0  | 0  | 0  | 0   | 0  |
| 2088 | 0  | 0  | 0  | 0  | 0  | 0  | 0  | 0  | 0  | 0  | 0   | 0  |
| 2089 | 0  | 0  | 0  | 0  | 0  | 0  | 0  | 0  | 0  | 0  | 0   | 0  |
| 2090 | 0  | 0  | 0  | 0  | 0  | 0  | 0  | 0  | 0  | 0  | 0   | 0  |



|      | 73   | 74   | 75   | 76   | 77   | 78  | 79  | 80   | 81   | 82 | 83 | 84 |
|------|------|------|------|------|------|-----|-----|------|------|----|----|----|
| 2002 | 0    | 0    | 0    | 0    | 0    | 0   | 0   | 0    | 0    | 0  | 0  | 0  |
| 2003 | 0    | 0    | 0    | 0    | 0    | 0   | 0   | 0    | 0    | 0  | 0  | 0  |
| 2004 | 0    | 0    | 0    | 0    | 0    | 0   | 0   | 0    | 0    | 0  | 0  | 0  |
| 2005 | 0    | 0    | 0    | 0    | 0    | 0   | 0   | 0    | 0    | 0  | 0  | 0  |
| 2006 | 0    | 0    | 0    | 0    | 0    | 0   | 0   | 0    | 0    | 0  | 0  | 0  |
| 2007 | 0    | 0    | 0    | 0    | 0    | 0   | 0   | 0    | 0    | 0  | 0  | 0  |
| 2008 | 0    | 0    | 0    | 0    | 0    | 0   | 0   | 0    | 0    | 0  | 0  | 0  |
| 2009 | 0    | 0    | 0    | 0    | 0    | 0   | 0   | 0    | 0    | 0  | 0  | 0  |
| 2010 | 0    | 0    | 0    | 0    | 0    | 0   | 0   | 0    | 0    | 0  | 0  | 0  |
| 2011 | 0    | 0    | 0    | 0    | 0    | 0   | 0   | 0    | 0    | 0  | 0  | 0  |
| 2012 | 0    | 0    | 0    | 0    | 0    | 0   | 0   | 0    | 0    | 0  | 0  | 0  |
| 2013 | 0    | 0    | 0    | 0    | 0    | 0   | 0   | 0    | 0    | 0  | 0  | 0  |
| 2014 | 0    | 0    | 0    | 0    | 0    | 0   | 0   | 0    | 0    | 0  | 0  | 0  |
| 2015 | 0    | 0    | 0    | 0    | 0    | 0   | 0   | 0    | 0    | 0  | 0  | 0  |
| 2016 | 0    | 0    | 0    | 0    | 0    | 0   | 0   | 0    | 0    | 0  | 0  | 0  |
| 2017 | 0    | 0    | 0    | 0    | 0    | 0   | 0   | 0    | 0    | 0  | 0  | 0  |
| 2018 | 0    | 0    | 0    | 0    | 0    | 0   | 0   | 0    | 0    | 0  | 0  | 0  |
| 2019 | 0    | 0    | 0    | 0    | 0    | 0   | 0   | 0    | 0    | 0  | 0  | 0  |
| 2020 | 0    | 0    | 0    | 240  | 0    | 0   | 0   | 0    | 0    | 0  | 0  | 0  |
| 2021 | 0    | 0    | 0    | 537  | 0    | 0   | 0   | 0    | 0    | 0  | 0  | 0  |
| 2022 | 0    | 0    | 0    | 758  | 0    | 0   | 0   | 0    | 0    | 0  | 0  | 0  |
| 2023 | 0    | 0    | 0    | 907  | 0    | 0   | 0   | 0    | 0    | 0  | 0  | 0  |
| 2024 | 0    | 0    | 0    | 1031 | 0    | 0   | 0   | 0    | 0    | 0  | 0  | 0  |
| 2025 | 233  | 233  | 0    | 1100 | 238  | 187 | 186 | 249  | 233  | 0  | 0  | 0  |
| 2026 | 522  | 425  | 0    | 1165 | 526  | 299 | 277 | 588  | 452  | 0  | 0  | 0  |
| 2027 | 756  | 626  | 0    | 1187 | 769  | 421 | 310 | 919  | 665  | 0  | 0  | 0  |
| 2028 | 942  | 820  | 0    | 1187 | 1029 | 454 | 317 | 1249 | 884  | 0  | 0  | 0  |
| 2029 | 1030 | 969  | 0    | 1214 | 1221 | 450 | 310 | 1519 | 1011 | 0  | 0  | 0  |
| 2030 | 1110 | 1077 | 240  | 1184 | 1326 | 485 | 338 | 1758 | 1089 | 0  | 0  | 0  |
| 2031 | 1175 | 1167 | 420  | 1201 | 1436 | 494 | 281 | 1996 | 1168 | 0  | 0  | 0  |
| 2032 | 1182 | 1175 | 580  | 1184 | 1566 | 564 | 252 | 2188 | 1173 | 0  | 0  | 0  |
| 2033 | 1215 | 1211 | 777  | 1158 | 1627 | 589 | 255 | 2336 | 1212 | 0  | 0  | 0  |
| 2034 | 1190 | 1176 | 930  | 1099 | 1662 | 598 | 268 | 2518 | 1182 | 0  | 0  | 0  |
| 2035 | 1194 | 1187 | 1032 | 1052 | 1735 | 628 | 253 | 2680 | 1185 | 0  | 0  | 0  |
| 2036 | 1184 | 1172 | 1079 | 1004 | 1731 | 647 | 224 | 2796 | 1169 | 0  | 0  | 0  |
| 2037 | 1169 | 1158 | 1122 | 984  | 1622 | 627 | 185 | 2888 | 1156 | 0  | 0  | 0  |
| 2038 | 1067 | 1060 | 1166 | 937  | 1584 | 608 | 179 | 2979 | 1057 | 0  | 0  | 0  |
| 2039 | 1002 | 1010 | 1156 | 955  | 1523 | 603 | 193 | 3041 | 1008 | 0  | 0  | 0  |
| 2040 | 993  | 1013 | 1097 | 941  | 1507 | 596 | 207 | 3138 | 1005 | 0  | 0  | 0  |
| 2041 | 976  | 998  | 1082 | 945  | 1429 | 586 | 192 | 3164 | 972  | 8  | 8  | 0  |
| 2042 | 973  | 981  | 1075 | 890  | 1433 | 514 | 176 | 3223 | 959  | 14 | 14 | 0  |
| 2043 | 902  | 937  | 1059 | 731  | 1382 | 435 | 172 | 3198 | 892  | 29 | 29 | 0  |
| 2044 | 903  | 928  | 1078 | 609  | 1344 | 407 | 142 | 3187 | 886  | 46 | 46 | 0  |
| 2045 | 814  | 820  | 1004 | 496  | 1242 | 412 | 151 | 3048 | 807  | 34 | 34 | 0  |
| 2046 | 652  | 648  | 977  | 361  | 1007 | 330 | 91  | 2771 | 649  | 21 | 21 | 4  |
| 2047 | 523  | 534  | 915  | 249  | 794  | 223 | 64  | 2482 | 525  | 10 | 10 | 1  |
| 2048 | 384  | 382  | 704  | 184  | 633  | 177 | 33  | 2295 | 384  | 4  | 4  | 0  |
| 2049 | 307  | 297  | 524  | 156  | 521  | 123 | 15  | 2080 | 311  | 0  | 0  | 0  |
| 2050 | 221  | 219  | 414  | 132  | 446  | 70  | 9   | 1845 | 232  | 0  | 0  | 0  |
| 2051 | 157  | 162  | 323  | 102  | 367  | 43  | 5   | 1636 | 170  | 0  | 0  | 0  |
| 2052 | 129  | 135  | 241  | 86   | 279  | 21  | 0   | 1451 | 143  | 0  | 0  | 0  |
| 2053 | 98   | 99   | 190  | 74   | 203  | 14  | 0   | 1210 | 108  | 0  | 0  | 0  |
| 2054 | 68   | 71   | 126  | 60   | 145  | 3   | 0   | 1059 | 77   | 0  | 0  | 0  |
| 2055 | 56   | 59   | 91   | 45   | 86   | 0   | 0   | 903  | 61   | 0  | 0  | 0  |
| 2056 | 32   | 35   | 53   | 32   | 78   | 0   | 0   | 788  | 36   | 0  | 0  | 0  |
| 2057 | 18   | 19   | 31   | 17   | 54   | 0   | 0   | 643  | 21   | 0  | 0  | 0  |
| 2058 | 13   | 15   | 10   | 8    | 40   | 0   | 0   | 560  | 16   | 0  | 0  | 0  |
| 2059 | 8    | 8    | 5    | 1    | 33   | 0   | 0   | 473  | 9    | 0  | 0  | 0  |
| 2060 | 7    | 6    | 4    | 0    | 19   | 0   | 0   | 383  | 6    | 0  | 0  | 0  |
| 2061 | 3    | 3    | 2    | 0    | 14   | 0   | 0   | 301  | 3    | 0  | 0  | 0  |
| 2062 | 0    | 0    | 1    | 0    | 9    | 0   | 0   | 239  | 0    | 0  | 0  | 0  |
| 2063 | 0    | 0    | 0    | 0    | 7    | 0   | 0   | 180  | 0    | 0  | 0  | 0  |
| 2064 | 0    | 0    | 0    | 0    | 3    | 0   | 0   | 150  | 0    | 0  | 0  | 0  |
| 2065 | 0    | 0    | 0    | 0    | 2    | 0   | 0   | 110  | 0    | 0  | 0  | 0  |
| 2066 | 0    | 0    | 0    | 0    | 0    | 0   | 0   | 87   | 0    | 0  | 0  | 0  |
| 2067 | 0    | 0    | 0    | 0    | 0    | 0   | 0   | 74   | 0    | 0  | 0  | 0  |
| 2068 | 0    | 0    | 0    | 0    | 0    | 0   | 0   | 41   | 0    | 0  | 0  | 0  |

|      | 73 | 74 | 75 | 76 | 77 | 78 | 79 | 80 | 81 | 82 | 83 | 84 |
|------|----|----|----|----|----|----|----|----|----|----|----|----|
| 2069 | 0  | 0  | 0  | 0  | 0  | 0  | 0  | 31 | 0  | 0  | 0  | 0  |
| 2070 | 0  | 0  | 0  | 0  | 0  | 0  | 0  | 21 | 0  | 0  | 0  | 0  |
| 2071 | 0  | 0  | 0  | 0  | 0  | 0  | 0  | 15 | 0  | 0  | 0  | 0  |
| 2072 | 0  | 0  | 0  | 0  | 0  | 0  | 0  | 9  | 0  | 0  | 0  | 0  |
| 2073 | 0  | 0  | 0  | 0  | 0  | 0  | 0  | 6  | 0  | 0  | 0  | 0  |
| 2074 | 0  | 0  | 0  | 0  | 0  | 0  | 0  | 4  | 0  | 0  | 0  | 0  |
| 2075 | 0  | 0  | 0  | 0  | 0  | 0  | 0  | 0  | 0  | 0  | 0  | 0  |
| 2076 | 0  | 0  | 0  | 0  | 0  | 0  | 0  | 0  | 0  | 0  | 0  | 0  |
| 2077 | 0  | 0  | 0  | 0  | 0  | 0  | 0  | 0  | 0  | 0  | 0  | 0  |
| 2078 | 0  | 0  | 0  | 0  | 0  | 0  | 0  | 0  | 0  | 0  | 0  | 0  |
| 2079 | 0  | 0  | 0  | 0  | 0  | 0  | 0  | 0  | 0  | 0  | 0  | 0  |
| 2080 | 0  | 0  | 0  | 0  | 0  | 0  | 0  | 0  | 0  | 0  | 0  | 0  |
| 2081 | 0  | 0  | 0  | 0  | 0  | 0  | 0  | 0  | 0  | 0  | 0  | 0  |
| 2082 | 0  | 0  | 0  | 0  | 0  | 0  | 0  | 0  | 0  | 0  | 0  | 0  |
| 2083 | 0  | 0  | 0  | 0  | 0  | 0  | 0  | 0  | 0  | 0  | 0  | 0  |
| 2084 | 0  | 0  | 0  | 0  | 0  | 0  | 0  | 0  | 0  | 0  | 0  | 0  |
| 2085 | 0  | 0  | 0  | 0  | 0  | 0  | 0  | 0  | 0  | 0  | 0  | 0  |
| 2086 | 0  | 0  | 0  | 0  | 0  | 0  | 0  | 0  | 0  | 0  | 0  | 0  |
| 2087 | 0  | 0  | 0  | 0  | 0  | 0  | 0  | 0  | 0  | 0  | 0  | 0  |
| 2088 | 0  | 0  | 0  | 0  | 0  | 0  | 0  | 0  | 0  | 0  | 0  | 0  |
| 2089 | 0  | 0  | 0  | 0  | 0  | 0  | 0  | 0  | 0  | 0  | 0  | 0  |
| 2090 | 0  | 0  | 0  | 0  | 0  | 0  | 0  | 0  | 0  | 0  | 0  | 0  |

|      | 85  | 86 | 87 | 88 | 89  | 90 | 91  | 92  | 93  | 94  | 95  | 96  |
|------|-----|----|----|----|-----|----|-----|-----|-----|-----|-----|-----|
| 2002 | 0   | 0  | 0  | 0  | 0   | 0  | 0   | 0   | 0   | 0   | 0   | 0   |
| 2003 | 0   | 0  | 0  | 0  | 0   | 0  | 0   | 0   | 0   | 0   | 0   | 0   |
| 2004 | 0   | 0  | 0  | 0  | 0   | 0  | 0   | 0   | 0   | 0   | 0   | 0   |
| 2005 | 0   | 0  | 0  | 0  | 0   | 0  | 0   | 0   | 0   | 0   | 0   | 0   |
| 2006 | 0   | 0  | 0  | 0  | 0   | 0  | 0   | 0   | 0   | 0   | 0   | 0   |
| 2007 | 0   | 0  | 0  | 0  | 0   | 0  | 0   | 0   | 0   | 0   | 0   | 0   |
| 2008 | 0   | 0  | 0  | 0  | 0   | 0  | 0   | 0   | 0   | 0   | 0   | 0   |
| 2009 | 0   | 0  | 0  | 0  | 0   | 0  | 0   | 0   | 0   | 0   | 0   | 0   |
| 2010 | 0   | 0  | 0  | 0  | 0   | 0  | 0   | 0   | 0   | 0   | 0   | 0   |
| 2011 | 0   | 0  | 0  | 0  | 0   | 0  | 0   | 0   | 0   | 0   | 0   | 0   |
| 2012 | 0   | 0  | 0  | 0  | 0   | 0  | 0   | 0   | 0   | 0   | 0   | 0   |
| 2013 | 0   | 0  | 0  | 0  | 0   | 0  | 0   | 0   | 0   | 0   | 0   | 0   |
| 2014 | 0   | 0  | 0  | 0  | 0   | 0  | 0   | 0   | 0   | 0   | 0   | 0   |
| 2015 | 0   | 0  | 0  | 0  | 0   | 0  | 0   | 0   | 0   | 0   | 0   | 0   |
| 2016 | 0   | 0  | 0  | 0  | 0   | 0  | 0   | 0   | 0   | 0   | 0   | 0   |
| 2017 | 0   | 0  | 0  | 0  | 0   | 0  | 0   | 0   | 0   | 0   | 0   | 0   |
| 2018 | 0   | 0  | 0  | 0  | 0   | 0  | 0   | 0   | 0   | 0   | 0   | 0   |
| 2019 | 0   | 0  | 0  | 0  | 0   | 0  | 0   | 0   | 0   | 0   | 0   | 0   |
| 2020 | 0   | 0  | 0  | 0  | 0   | 0  | 0   | 0   | 0   | 160 | 0   | 0   |
| 2021 | 0   | 0  | 0  | 0  | 0   | 0  | 0   | 0   | 0   | 304 | 0   | 0   |
| 2022 | 0   | 0  | 0  | 0  | 0   | 0  | 0   | 0   | 0   | 364 | 0   | 0   |
| 2023 | 0   | 0  | 0  | 0  | 0   | 0  | 0   | 0   | 0   | 387 | 0   | 0   |
| 2024 | 0   | 0  | 0  | 0  | 0   | 0  | 0   | 0   | 0   | 395 | 0   | 0   |
| 2025 | 0   | 0  | 0  | 0  | 0   | 0  | 179 | 179 | 0   | 448 | 186 | 74  |
| 2026 | 0   | 0  | 0  | 0  | 0   | 0  | 301 | 291 | 0   | 410 | 323 | 130 |
| 2027 | 0   | 0  | 0  | 0  | 0   | 0  | 418 | 408 | 0   | 418 | 466 | 137 |
| 2028 | 0   | 0  | 0  | 0  | 0   | 0  | 478 | 467 | 0   | 390 | 601 | 160 |
| 2029 | 0   | 0  | 0  | 0  | 0   | 0  | 526 | 521 | 0   | 375 | 691 | 195 |
| 2030 | 0   | 0  | 0  | 0  | 0   | 0  | 543 | 541 | 184 | 320 | 739 | 230 |
| 2031 | 0   | 0  | 0  | 0  | 0   | 0  | 497 | 497 | 302 | 318 | 701 | 278 |
| 2032 | 0   | 0  | 0  | 0  | 0   | 0  | 504 | 504 | 421 | 294 | 699 | 298 |
| 2033 | 0   | 0  | 0  | 0  | 1   | 0  | 476 | 476 | 525 | 342 | 620 | 287 |
| 2034 | 6   | 0  | 0  | 0  | 5   | 0  | 465 | 465 | 587 | 376 | 563 | 306 |
| 2035 | 8   | 0  | 0  | 0  | 13  | 0  | 459 | 459 | 605 | 369 | 500 | 354 |
| 2036 | 23  | 0  | 0  | 0  | 23  | 0  | 419 | 419 | 548 | 394 | 483 | 322 |
| 2037 | 33  | 1  | 0  | 0  | 50  | 0  | 394 | 394 | 518 | 369 | 493 | 319 |
| 2038 | 70  | 2  | 2  | 0  | 78  | 0  | 405 | 405 | 522 | 371 | 499 | 293 |
| 2039 | 119 | 1  | 3  | 0  | 134 | 0  | 410 | 410 | 528 | 410 | 517 | 311 |
| 2040 | 151 | 2  | 5  | 0  | 217 | 0  | 447 | 447 | 538 | 469 | 547 | 317 |
| 2041 | 163 | 5  | 8  | 0  | 285 | 8  | 481 | 481 | 554 | 492 | 572 | 308 |
| 2042 | 143 | 27 | 20 | 0  | 298 | 14 | 482 | 482 | 481 | 550 | 587 | 264 |
| 2043 | 114 | 37 | 42 | 3  | 320 | 29 | 461 | 461 | 465 | 565 | 619 | 254 |
| 2044 | 88  | 63 | 68 | 0  | 369 | 46 | 460 | 460 | 433 | 647 | 639 | 281 |
| 2045 | 66  | 37 | 42 | 0  | 292 | 34 | 487 | 487 | 433 | 704 | 640 | 281 |
| 2046 | 47  | 19 | 23 | 0  | 270 | 21 | 448 | 448 | 405 | 723 | 664 | 287 |
| 2047 | 25  | 5  | 8  | 0  | 226 | 10 | 503 | 503 | 426 | 677 | 648 | 221 |
| 2048 | 14  | 4  | 4  | 0  | 195 | 4  | 440 | 440 | 416 | 608 | 555 | 163 |
| 2049 | 8   | 0  | 0  | 0  | 173 | 0  | 402 | 402 | 382 | 560 | 511 | 110 |
| 2050 | 0   | 0  | 0  | 0  | 138 | 0  | 348 | 348 | 328 | 513 | 439 | 90  |
| 2051 | 0   | 0  | 0  | 0  | 109 | 0  | 308 | 308 | 278 | 472 | 396 | 61  |
| 2052 | 0   | 0  | 0  | 0  | 84  | 0  | 267 | 267 | 220 | 413 | 358 | 37  |
| 2053 | 0   | 0  | 0  | 0  | 64  | 0  | 228 | 228 | 180 | 370 | 331 | 25  |
| 2054 | 0   | 0  | 0  | 0  | 48  | 0  | 200 | 200 | 144 | 322 | 302 | 11  |
| 2055 | 0   | 0  | 0  | 0  | 38  | 0  | 171 | 171 | 102 | 269 | 281 | 0   |
| 2056 | 0   | 0  | 0  | 0  | 29  | 0  | 161 | 161 | 93  | 227 | 240 | 0   |
| 2057 | 0   | 0  | 0  | 0  | 15  | 0  | 128 | 128 | 66  | 176 | 204 | 0   |
| 2058 | 0   | 0  | 0  | 0  | 8   | 0  | 111 | 111 | 63  | 133 | 188 | 0   |
| 2059 | 0   | 0  | 0  | 0  | 1   | 0  | 91  | 91  | 50  | 99  | 157 | 0   |
| 2060 | 0   | 0  | 0  | 0  | 0   | 0  | 72  | 72  | 44  | 64  | 130 | 0   |
| 2061 | 0   | 0  | 0  | 0  | 0   | 0  | 51  | 51  | 37  | 32  | 109 | 0   |
| 2062 | 0   | 0  | 0  | 0  | 0   | 0  | 25  | 25  | 20  | 4   | 89  | 0   |
| 2063 | 0   | 0  | 0  | 0  | 0   | 0  | 13  | 13  | 10  | 0   | 67  | 0   |
| 2064 | 0   | 0  | 0  | 0  | 0   | 0  | 0   | 0   | 1   | 0   | 43  | 0   |
| 2065 | 0   | 0  | 0  | 0  | 0   | 0  | 0   | 0   | 0   | 0   | 27  | 0   |
| 2066 | 0   | 0  | 0  | 0  | 0   | 0  | 0   | 0   | 0   | 0   | 11  | 0   |
| 2067 | 0   | 0  | 0  | 0  | 0   | 0  | 0   | 0   | 0   | 0   | 2   | 0   |
| 2068 | 0   | 0  | 0  | 0  | 0   | 0  | 0   | 0   | 0   | 0   | 0   | 0   |

|      | 85 | 86 | 87 | 88 | 89 | 90 | 91 | 92 | 93 | 94 | 95 | 96 |
|------|----|----|----|----|----|----|----|----|----|----|----|----|
| 2069 | 0  | 0  | 0  | 0  | 0  | 0  | 0  | 0  | 0  | 0  | 0  | 0  |
| 2070 | 0  | 0  | 0  | 0  | 0  | 0  | 0  | 0  | 0  | 0  | 0  | 0  |
| 2071 | 0  | 0  | 0  | 0  | 0  | 0  | 0  | 0  | 0  | 0  | 0  | 0  |
| 2072 | 0  | 0  | 0  | 0  | 0  | 0  | 0  | 0  | 0  | 0  | 0  | 0  |
| 2073 | 0  | 0  | 0  | 0  | 0  | 0  | 0  | 0  | 0  | 0  | 0  | 0  |
| 2074 | 0  | 0  | 0  | 0  | 0  | 0  | 0  | 0  | 0  | 0  | 0  | 0  |
| 2075 | 0  | 0  | 0  | 0  | 0  | 0  | 0  | 0  | 0  | 0  | 0  | 0  |
| 2076 | 0  | 0  | 0  | 0  | 0  | 0  | 0  | 0  | 0  | 0  | 0  | 0  |
| 2077 | 0  | 0  | 0  | 0  | 0  | 0  | 0  | 0  | 0  | 0  | 0  | 0  |
| 2078 | 0  | 0  | 0  | 0  | 0  | 0  | 0  | 0  | 0  | 0  | 0  | 0  |
| 2079 | 0  | 0  | 0  | 0  | 0  | 0  | 0  | 0  | 0  | 0  | 0  | 0  |
| 2080 | 0  | 0  | 0  | 0  | 0  | 0  | 0  | 0  | 0  | 0  | 0  | 0  |
| 2081 | 0  | 0  | 0  | 0  | 0  | 0  | 0  | 0  | 0  | 0  | 0  | 0  |
| 2082 | 0  | 0  | 0  | 0  | 0  | 0  | 0  | 0  | 0  | 0  | 0  | 0  |
| 2083 | 0  | 0  | 0  | 0  | 0  | 0  | 0  | 0  | 0  | 0  | 0  | 0  |
| 2084 | 0  | 0  | 0  | 0  | 0  | 0  | 0  | 0  | 0  | 0  | 0  | 0  |
| 2085 | 0  | 0  | 0  | 0  | 0  | 0  | 0  | 0  | 0  | 0  | 0  | 0  |
| 2086 | 0  | 0  | 0  | 0  | 0  | 0  | 0  | 0  | 0  | 0  | 0  | 0  |
| 2087 | 0  | 0  | 0  | 0  | 0  | 0  | 0  | 0  | 0  | 0  | 0  | 0  |
| 2088 | 0  | 0  | 0  | 0  | 0  | 0  | 0  | 0  | 0  | 0  | 0  | 0  |
| 2089 | 0  | 0  | 0  | 0  | 0  | 0  | 0  | 0  | 0  | 0  | 0  | 0  |
| 2090 | 0  | 0  | 0  | 0  | 0  | 0  | 0  | 0  | 0  | 0  | 0  | 0  |

|      | 97  | 98   | 99  | 100  | 101  | 102  | 103  | 104  | 105 | 106 | 107  | 108  |
|------|-----|------|-----|------|------|------|------|------|-----|-----|------|------|
| 2002 | 0   | 0    | 0   | 0    | 0    | 0    | 0    | 0    | 0   | 0   | 0    | 0    |
| 2003 | 0   | 0    | 0   | 0    | 0    | 0    | 0    | 0    | 0   | 0   | 0    | 0    |
| 2004 | 0   | 0    | 0   | 0    | 0    | 0    | 0    | 0    | 0   | 0   | 0    | 0    |
| 2005 | 0   | 0    | 0   | 0    | 0    | 0    | 0    | 0    | 0   | 0   | 0    | 0    |
| 2006 | 0   | 0    | 0   | 0    | 0    | 0    | 0    | 0    | 0   | 0   | 0    | 0    |
| 2007 | 0   | 0    | 0   | 0    | 0    | 0    | 0    | 0    | 0   | 0   | 0    | 0    |
| 2008 | 0   | 0    | 0   | 0    | 0    | 0    | 0    | 0    | 0   | 0   | 0    | 0    |
| 2009 | 0   | 0    | 0   | 0    | 0    | 0    | 0    | 0    | 0   | 0   | 0    | 0    |
| 2010 | 0   | 0    | 0   | 0    | 0    | 0    | 0    | 0    | 0   | 0   | 0    | 0    |
| 2011 | 0   | 0    | 0   | 0    | 0    | 0    | 0    | 0    | 0   | 0   | 0    | 0    |
| 2012 | 0   | 0    | 0   | 0    | 0    | 0    | 0    | 0    | 0   | 0   | 0    | 0    |
| 2013 | 0   | 0    | 0   | 0    | 0    | 0    | 0    | 0    | 0   | 0   | 0    | 0    |
| 2014 | 0   | 0    | 0   | 0    | 0    | 0    | 0    | 0    | 0   | 0   | 0    | 0    |
| 2015 | 0   | 0    | 0   | 0    | 0    | 0    | 0    | 0    | 0   | 0   | 0    | 0    |
| 2016 | 0   | 0    | 0   | 0    | 0    | 0    | 0    | 0    | 0   | 0   | 0    | 0    |
| 2017 | 0   | 0    | 0   | 0    | 0    | 0    | 0    | 0    | 0   | 0   | 0    | 0    |
| 2018 | 0   | 0    | 0   | 0    | 0    | 0    | 0    | 0    | 0   | 0   | 0    | 0    |
| 2019 | 0   | 0    | 0   | 0    | 0    | 0    | 0    | 0    | 0   | 0   | 0    | 0    |
| 2020 | 0   | 0    | 0   | 0    | 0    | 0    | 240  | 0    | 0   | 0   | 0    | 0    |
| 2021 | 0   | 0    | 0   | 0    | 0    | 0    | 481  | 0    | 0   | 0   | 0    | 0    |
| 2022 | 0   | 0    | 0   | 0    | 0    | 0    | 676  | 0    | 0   | 0   | 0    | 0    |
| 2023 | 0   | 0    | 0   | 0    | 0    | 0    | 840  | 0    | 0   | 0   | 0    | 0    |
| 2024 | 0   | 0    | 0   | 0    | 0    | 0    | 977  | 0    | 0   | 0   | 0    | 0    |
| 2025 | 6   | 246  | 179 | 233  | 233  | 0    | 1080 | 238  | 187 | 186 | 249  | 233  |
| 2026 | 6   | 526  | 292 | 448  | 423  | 0    | 1148 | 488  | 290 | 273 | 541  | 431  |
| 2027 | 5   | 796  | 409 | 649  | 617  | 0    | 1169 | 706  | 399 | 307 | 830  | 627  |
| 2028 | 15  | 1068 | 468 | 843  | 807  | 0    | 1177 | 948  | 430 | 311 | 1127 | 815  |
| 2029 | 10  | 1266 | 523 | 970  | 947  | 0    | 1212 | 1145 | 433 | 308 | 1403 | 957  |
| 2030 | 12  | 1447 | 541 | 1064 | 1052 | 240  | 1180 | 1273 | 461 | 337 | 1649 | 1056 |
| 2031 | 21  | 1601 | 497 | 1156 | 1153 | 420  | 1221 | 1412 | 482 | 279 | 1895 | 1155 |
| 2032 | 18  | 1757 | 504 | 1161 | 1163 | 573  | 1205 | 1539 | 531 | 253 | 2095 | 1163 |
| 2033 | 18  | 1872 | 476 | 1204 | 1204 | 751  | 1172 | 1594 | 568 | 256 | 2248 | 1204 |
| 2034 | 21  | 1982 | 465 | 1179 | 1179 | 887  | 1081 | 1654 | 581 | 265 | 2441 | 1179 |
| 2035 | 23  | 2104 | 459 | 1186 | 1186 | 990  | 1036 | 1722 | 623 | 255 | 2617 | 1186 |
| 2036 | 36  | 2145 | 419 | 1165 | 1165 | 1047 | 1015 | 1723 | 645 | 234 | 2747 | 1165 |
| 2037 | 58  | 2158 | 394 | 1161 | 1161 | 1106 | 977  | 1617 | 638 | 197 | 2847 | 1161 |
| 2038 | 61  | 2122 | 405 | 1057 | 1057 | 1151 | 928  | 1574 | 620 | 188 | 2953 | 1057 |
| 2039 | 74  | 2089 | 410 | 997  | 997  | 1146 | 928  | 1523 | 615 | 196 | 3009 | 997  |
| 2040 | 99  | 2070 | 447 | 1004 | 1004 | 1087 | 913  | 1506 | 602 | 214 | 3109 | 1004 |
| 2041 | 88  | 2040 | 481 | 995  | 995  | 1067 | 897  | 1436 | 603 | 202 | 3156 | 995  |
| 2042 | 98  | 2022 | 482 | 987  | 987  | 1059 | 886  | 1447 | 513 | 173 | 3228 | 987  |
| 2043 | 110 | 1977 | 461 | 918  | 918  | 1039 | 806  | 1384 | 451 | 161 | 3208 | 918  |
| 2044 | 116 | 1951 | 460 | 907  | 907  | 1043 | 681  | 1351 | 415 | 132 | 3205 | 907  |
| 2045 | 133 | 1881 | 487 | 821  | 821  | 980  | 553  | 1253 | 423 | 145 | 3066 | 821  |
| 2046 | 145 | 1811 | 448 | 658  | 658  | 965  | 430  | 1031 | 337 | 85  | 2787 | 658  |
| 2047 | 163 | 1757 | 503 | 533  | 533  | 920  | 293  | 815  | 232 | 57  | 2497 | 533  |
| 2048 | 130 | 1570 | 440 | 388  | 388  | 742  | 214  | 641  | 182 | 25  | 2306 | 388  |
| 2049 | 108 | 1370 | 402 | 306  | 306  | 548  | 181  | 524  | 127 | 8   | 2092 | 306  |
| 2050 | 87  | 1243 | 348 | 220  | 220  | 433  | 152  | 450  | 70  | 5   | 1867 | 220  |
| 2051 | 66  | 1118 | 308 | 154  | 154  | 347  | 121  | 362  | 45  | 4   | 1667 | 154  |
| 2052 | 46  | 1011 | 267 | 128  | 128  | 263  | 106  | 284  | 21  | 0   | 1481 | 128  |
| 2053 | 25  | 904  | 228 | 97   | 97   | 202  | 93   | 203  | 14  | 0   | 1241 | 97   |
| 2054 | 2   | 796  | 200 | 69   | 69   | 141  | 75   | 145  | 3   | 0   | 1088 | 69   |
| 2055 | 0   | 712  | 171 | 55   | 55   | 107  | 60   | 91   | 0   | 0   | 932  | 55   |
| 2056 | 0   | 670  | 161 | 28   | 28   | 63   | 44   | 75   | 0   | 0   | 805  | 28   |
| 2057 | 0   | 623  | 128 | 12   | 12   | 35   | 27   | 51   | 0   | 0   | 655  | 12   |
| 2058 | 0   | 556  | 111 | 10   | 10   | 15   | 14   | 37   | 0   | 0   | 568  | 10   |
| 2059 | 0   | 494  | 91  | 6    | 6    | 9    | 1    | 31   | 0   | 0   | 482  | 6    |
| 2060 | 0   | 460  | 72  | 4    | 4    | 6    | 0    | 18   | 0   | 0   | 385  | 4    |
| 2061 | 0   | 410  | 51  | 2    | 2    | 4    | 0    | 12   | 0   | 0   | 301  | 2    |
| 2062 | 0   | 362  | 25  | 0    | 0    | 3    | 0    | 8    | 0   | 0   | 230  | 0    |
| 2063 | 0   | 310  | 13  | 0    | 0    | 1    | 0    | 5    | 0   | 0   | 164  | 0    |
| 2064 | 0   | 282  | 0   | 0    | 0    | 1    | 0    | 3    | 0   | 0   | 134  | 0    |
| 2065 | 0   | 239  | 0   | 0    | 0    | 0    | 0    | 2    | 0   | 0   | 98   | 0    |
| 2066 | 0   | 214  | 0   | 0    | 0    | 0    | 0    | 0    | 0   | 0   | 80   | 0    |
| 2067 | 0   | 189  | 0   | 0    | 0    | 0    | 0    | 0    | 0   | 0   | 66   | 0    |
| 2068 | 0   | 170  | 0   | 0    | 0    | 0    | 0    | 0    | 0   | 0   | 36   | 0    |

|      | 97 | 98  | 99 | 100 | 101 | 102 | 103 | 104 | 105 | 106 | 107 | 108 |
|------|----|-----|----|-----|-----|-----|-----|-----|-----|-----|-----|-----|
| 2069 | 0  | 156 | 0  | 0   | 0   | 0   | 0   | 0   | 0   | 0   | 23  | 0   |
| 2070 | 0  | 127 | 0  | 0   | 0   | 0   | 0   | 0   | 0   | 0   | 12  | 0   |
| 2071 | 0  | 110 | 0  | 0   | 0   | 0   | 0   | 0   | 0   | 0   | 10  | 0   |
| 2072 | 0  | 89  | 0  | 0   | 0   | 0   | 0   | 0   | 0   | 0   | 5   | 0   |
| 2073 | 0  | 72  | 0  | 0   | 0   | 0   | 0   | 0   | 0   | 0   | 4   | 0   |
| 2074 | 0  | 51  | 0  | 0   | 0   | 0   | 0   | 0   | 0   | 0   | 3   | 0   |
| 2075 | 0  | 26  | 0  | 0   | 0   | 0   | 0   | 0   | 0   | 0   | 0   | 0   |
| 2076 | 0  | 14  | 0  | 0   | 0   | 0   | 0   | 0   | 0   | 0   | 0   | 0   |
| 2077 | 0  | 0   | 0  | 0   | 0   | 0   | 0   | 0   | 0   | 0   | 0   | 0   |
| 2078 | 0  | 0   | 0  | 0   | 0   | 0   | 0   | 0   | 0   | 0   | 0   | 0   |
| 2079 | 0  | 0   | 0  | 0   | 0   | 0   | 0   | 0   | 0   | 0   | 0   | 0   |
| 2080 | 0  | 0   | 0  | 0   | 0   | 0   | 0   | 0   | 0   | 0   | 0   | 0   |
| 2081 | 0  | 0   | 0  | 0   | 0   | 0   | 0   | 0   | 0   | 0   | 0   | 0   |
| 2082 | 0  | 0   | 0  | 0   | 0   | 0   | 0   | 0   | 0   | 0   | 0   | 0   |
| 2083 | 0  | 0   | 0  | 0   | 0   | 0   | 0   | 0   | 0   | 0   | 0   | 0   |
| 2084 | 0  | 0   | 0  | 0   | 0   | 0   | 0   | 0   | 0   | 0   | 0   | 0   |
| 2085 | 0  | 0   | 0  | 0   | 0   | 0   | 0   | 0   | 0   | 0   | 0   | 0   |
| 2086 | 0  | 0   | 0  | 0   | 0   | 0   | 0   | 0   | 0   | 0   | 0   | 0   |
| 2087 | 0  | 0   | 0  | 0   | 0   | 0   | 0   | 0   | 0   | 0   | 0   | 0   |
| 2088 | 0  | 0   | 0  | 0   | 0   | 0   | 0   | 0   | 0   | 0   | 0   | 0   |
| 2089 | 0  | 0   | 0  | 0   | 0   | 0   | 0   | 0   | 0   | 0   | 0   | 0   |
| 2090 | 0  | 0   | 0  | 0   | 0   | 0   | 0   | 0   | 0   | 0   | 0   | 0   |

|      | 109 | 110 | 111 | 112 | 113 | 114 | 115 | 116 | 117 | 118 | 119 | 120 |
|------|-----|-----|-----|-----|-----|-----|-----|-----|-----|-----|-----|-----|
| 2002 | 0   | 0   | 0   | 0   | 0   | 0   | 0   | 0   | 0   | 0   | 0   | 0   |
| 2003 | 0   | 0   | 0   | 0   | 0   | 0   | 0   | 0   | 0   | 0   | 0   | 0   |
| 2004 | 0   | 0   | 0   | 0   | 0   | 0   | 0   | 0   | 0   | 0   | 0   | 0   |
| 2005 | 0   | 0   | 0   | 0   | 0   | 0   | 0   | 0   | 0   | 0   | 0   | 0   |
| 2006 | 0   | 0   | 0   | 0   | 0   | 0   | 0   | 0   | 0   | 0   | 0   | 0   |
| 2007 | 0   | 0   | 0   | 0   | 0   | 0   | 0   | 0   | 0   | 0   | 0   | 0   |
| 2008 | 0   | 0   | 0   | 0   | 0   | 0   | 0   | 0   | 0   | 0   | 0   | 0   |
| 2009 | 0   | 0   | 0   | 0   | 0   | 0   | 0   | 0   | 0   | 0   | 0   | 0   |
| 2010 | 0   | 0   | 0   | 0   | 0   | 0   | 0   | 0   | 0   | 0   | 0   | 0   |
| 2011 | 0   | 0   | 0   | 0   | 0   | 0   | 0   | 0   | 0   | 0   | 0   | 0   |
| 2012 | 0   | 0   | 0   | 0   | 0   | 0   | 0   | 0   | 0   | 0   | 0   | 0   |
| 2013 | 0   | 0   | 0   | 0   | 0   | 0   | 0   | 0   | 0   | 0   | 0   | 0   |
| 2014 | 0   | 0   | 0   | 0   | 0   | 0   | 0   | 0   | 0   | 0   | 0   | 0   |
| 2015 | 0   | 0   | 0   | 0   | 0   | 0   | 0   | 0   | 0   | 0   | 0   | 0   |
| 2016 | 0   | 0   | 0   | 0   | 0   | 0   | 0   | 0   | 0   | 0   | 0   | 0   |
| 2017 | 0   | 0   | 0   | 0   | 0   | 0   | 0   | 0   | 0   | 0   | 0   | 0   |
| 2018 | 0   | 0   | 0   | 0   | 0   | 0   | 0   | 0   | 0   | 0   | 0   | 0   |
| 2019 | 0   | 0   | 0   | 0   | 0   | 0   | 0   | 0   | 0   | 0   | 0   | 0   |
| 2020 | 0   | 0   | 0   | 0   | 0   | 0   | 0   | 0   | 0   | 0   | 0   | 0   |
| 2021 | 0   | 0   | 0   | 0   | 0   | 0   | 0   | 0   | 0   | 0   | 0   | 0   |
| 2022 | 0   | 0   | 0   | 0   | 0   | 0   | 0   | 0   | 0   | 0   | 0   | 0   |
| 2023 | 0   | 0   | 0   | 0   | 0   | 0   | 0   | 0   | 0   | 0   | 0   | 0   |
| 2024 | 0   | 0   | 0   | 0   | 0   | 0   | 0   | 0   | 0   | 0   | 0   | 0   |
| 2025 | 0   | 0   | 0   | 0   | 0   | 0   | 0   | 0   | 0   | 179 | 179 | 0   |
| 2026 | 0   | 0   | 0   | 0   | 0   | 0   | 0   | 0   | 0   | 318 | 318 | 0   |
| 2027 | 0   | 0   | 0   | 0   | 0   | 0   | 0   | 0   | 0   | 454 | 454 | 0   |
| 2028 | 0   | 0   | 0   | 0   | 0   | 0   | 0   | 0   | 0   | 501 | 501 | 0   |
| 2029 | 0   | 0   | 0   | 0   | 0   | 0   | 0   | 0   | 0   | 536 | 534 | 0   |
| 2030 | 0   | 0   | 0   | 0   | 0   | 0   | 0   | 0   | 0   | 540 | 530 | 184 |
| 2031 | 0   | 0   | 0   | 0   | 0   | 0   | 0   | 0   | 0   | 469 | 462 | 327 |
| 2032 | 0   | 0   | 0   | 1   | 0   | 0   | 0   | 7   | 0   | 441 | 446 | 444 |
| 2033 | 0   | 0   | 0   | 7   | 0   | 0   | 0   | 9   | 0   | 401 | 408 | 534 |
| 2034 | 0   | 0   | 0   | 24  | 0   | 0   | 0   | 44  | 0   | 406 | 417 | 587 |
| 2035 | 0   | 0   | 0   | 18  | 0   | 0   | 0   | 83  | 0   | 435 | 441 | 580 |
| 2036 | 3   | 1   | 0   | 58  | 2   | 0   | 0   | 160 | 1   | 382 | 395 | 537 |
| 2037 | 5   | 3   | 0   | 71  | 4   | 1   | 0   | 210 | 3   | 386 | 398 | 491 |
| 2038 | 7   | 6   | 0   | 105 | 9   | 2   | 0   | 265 | 6   | 403 | 422 | 479 |
| 2039 | 16  | 17  | 0   | 153 | 19  | 10  | 0   | 311 | 11  | 420 | 443 | 501 |
| 2040 | 25  | 24  | 0   | 173 | 38  | 33  | 1   | 376 | 31  | 424 | 444 | 512 |
| 2041 | 48  | 51  | 0   | 148 | 42  | 52  | 0   | 449 | 57  | 446 | 466 | 515 |
| 2042 | 68  | 67  | 1   | 121 | 78  | 88  | 2   | 475 | 73  | 434 | 454 | 460 |
| 2043 | 51  | 51  | 5   | 89  | 47  | 65  | 0   | 412 | 53  | 396 | 411 | 447 |
| 2044 | 26  | 26  | 35  | 61  | 28  | 43  | 0   | 368 | 30  | 395 | 415 | 419 |
| 2045 | 12  | 12  | 20  | 42  | 11  | 21  | 0   | 291 | 15  | 438 | 433 | 403 |
| 2046 | 3   | 3   | 11  | 28  | 8   | 11  | 0   | 266 | 7   | 448 | 424 | 386 |
| 2047 | 0   | 0   | 3   | 18  | 0   | 3   | 0   | 222 | 4   | 481 | 477 | 374 |
| 2048 | 0   | 0   | 0   | 8   | 0   | 0   | 0   | 192 | 2   | 500 | 489 | 295 |
| 2049 | 0   | 0   | 0   | 8   | 0   | 0   | 0   | 168 | 0   | 466 | 459 | 257 |
| 2050 | 0   | 0   | 0   | 0   | 0   | 0   | 0   | 130 | 0   | 423 | 417 | 226 |
| 2051 | 0   | 0   | 0   | 0   | 0   | 0   | 0   | 100 | 0   | 390 | 381 | 189 |
| 2052 | 0   | 0   | 0   | 0   | 0   | 0   | 0   | 77  | 0   | 347 | 339 | 167 |
| 2053 | 0   | 0   | 0   | 0   | 0   | 0   | 0   | 55  | 0   | 304 | 300 | 141 |
| 2054 | 0   | 0   | 0   | 0   | 0   | 0   | 0   | 37  | 0   | 276 | 270 | 121 |
| 2055 | 0   | 0   | 0   | 0   | 0   | 0   | 0   | 20  | 0   | 250 | 239 | 98  |
| 2056 | 0   | 0   | 0   | 0   | 0   | 0   | 0   | 11  | 0   | 231 | 220 | 94  |
| 2057 | 0   | 0   | 0   | 0   | 0   | 0   | 0   | 6   | 0   | 207 | 191 | 74  |
| 2058 | 0   | 0   | 0   | 0   | 0   | 0   | 0   | 3   | 0   | 194 | 178 | 69  |
| 2059 | 0   | 0   | 0   | 0   | 0   | 0   | 0   | 0   | 0   | 168 | 157 | 56  |
| 2060 | 0   | 0   | 0   | 0   | 0   | 0   | 0   | 0   | 0   | 142 | 129 | 46  |
| 2061 | 0   | 0   | 0   | 0   | 0   | 0   | 0   | 0   | 0   | 108 | 103 | 41  |
| 2062 | 0   | 0   | 0   | 0   | 0   | 0   | 0   | 0   | 0   | 73  | 71  | 21  |
| 2063 | 0   | 0   | 0   | 0   | 0   | 0   | 0   | 0   | 0   | 36  | 32  | 8   |
| 2064 | 0   | 0   | 0   | 0   | 0   | 0   | 0   | 0   | 0   | 7   | 7   | 0   |
| 2065 | 0   | 0   | 0   | 0   | 0   | 0   | 0   | 0   | 0   | 0   | 0   | 0   |
| 2066 | 0   | 0   | 0   | 0   | 0   | 0   | 0   | 0   | 0   | 0   | 0   | 0   |
| 2067 | 0   | 0   | 0   | 0   | 0   | 0   | 0   | 0   | 0   | 0   | 0   | 0   |
| 2068 | 0   | 0   | 0   | 0   | 0   | 0   | 0   | 0   | 0   | 0   | 0   | 0   |

|      | 109 | 110 | 111 | 112 | 113 | 114 | 115 | 116 | 117 | 118 | 119 | 120 |
|------|-----|-----|-----|-----|-----|-----|-----|-----|-----|-----|-----|-----|
| 2069 | 0   | 0   | 0   | 0   | 0   | 0   | 0   | 0   | 0   | 0   | 0   | 0   |
| 2070 | 0   | 0   | 0   | 0   | 0   | 0   | 0   | 0   | 0   | 0   | 0   | 0   |
| 2071 | 0   | 0   | 0   | 0   | 0   | 0   | 0   | 0   | 0   | 0   | 0   | 0   |
| 2072 | 0   | 0   | 0   | 0   | 0   | 0   | 0   | 0   | 0   | 0   | 0   | 0   |
| 2073 | 0   | 0   | 0   | 0   | 0   | 0   | 0   | 0   | 0   | 0   | 0   | 0   |
| 2074 | 0   | 0   | 0   | 0   | 0   | 0   | 0   | 0   | 0   | 0   | 0   | 0   |
| 2075 | 0   | 0   | 0   | 0   | 0   | 0   | 0   | 0   | 0   | 0   | 0   | 0   |
| 2076 | 0   | 0   | 0   | 0   | 0   | 0   | 0   | 0   | 0   | 0   | 0   | 0   |
| 2077 | 0   | 0   | 0   | 0   | 0   | 0   | 0   | 0   | 0   | 0   | 0   | 0   |
| 2078 | 0   | 0   | 0   | 0   | 0   | 0   | 0   | 0   | 0   | 0   | 0   | 0   |
| 2079 | 0   | 0   | 0   | 0   | 0   | 0   | 0   | 0   | 0   | 0   | 0   | 0   |
| 2080 | 0   | 0   | 0   | 0   | 0   | 0   | 0   | 0   | 0   | 0   | 0   | 0   |
| 2081 | 0   | 0   | 0   | 0   | 0   | 0   | 0   | 0   | 0   | 0   | 0   | 0   |
| 2082 | 0   | 0   | 0   | 0   | 0   | 0   | 0   | 0   | 0   | 0   | 0   | 0   |
| 2083 | 0   | 0   | 0   | 0   | 0   | 0   | 0   | 0   | 0   | 0   | 0   | 0   |
| 2084 | 0   | 0   | 0   | 0   | 0   | 0   | 0   | 0   | 0   | 0   | 0   | 0   |
| 2085 | 0   | 0   | 0   | 0   | 0   | 0   | 0   | 0   | 0   | 0   | 0   | 0   |
| 2086 | 0   | 0   | 0   | 0   | 0   | 0   | 0   | 0   | 0   | 0   | 0   | 0   |
| 2087 | 0   | 0   | 0   | 0   | 0   | 0   | 0   | 0   | 0   | 0   | 0   | 0   |
| 2088 | 0   | 0   | 0   | 0   | 0   | 0   | 0   | 0   | 0   | 0   | 0   | 0   |
| 2089 | 0   | 0   | 0   | 0   | 0   | 0   | 0   | 0   | 0   | 0   | 0   | 0   |
| 2090 | 0   | 0   | 0   | 0   | 0   | 0   | 0   | 0   | 0   | 0   | 0   | 0   |



|      | 121 | 122 | 123 | 124 | 125  | 126 | 127  | 128  | 129  | 130  | 131  | 132 |
|------|-----|-----|-----|-----|------|-----|------|------|------|------|------|-----|
| 2002 | 0   | 0   | 0   | 0   | 0    | 0   | 0    | 0    | 0    | 0    | 0    | 0   |
| 2003 | 0   | 0   | 0   | 0   | 0    | 0   | 0    | 0    | 0    | 0    | 0    | 0   |
| 2004 | 0   | 0   | 0   | 0   | 0    | 0   | 0    | 0    | 0    | 0    | 0    | 0   |
| 2005 | 0   | 0   | 0   | 0   | 0    | 0   | 0    | 0    | 0    | 0    | 0    | 0   |
| 2006 | 0   | 0   | 0   | 0   | 0    | 0   | 0    | 0    | 0    | 0    | 0    | 0   |
| 2007 | 0   | 0   | 0   | 0   | 0    | 0   | 0    | 0    | 0    | 0    | 0    | 0   |
| 2008 | 0   | 0   | 0   | 0   | 0    | 0   | 0    | 0    | 0    | 0    | 0    | 0   |
| 2009 | 0   | 0   | 0   | 0   | 0    | 0   | 0    | 0    | 0    | 0    | 0    | 0   |
| 2010 | 0   | 0   | 0   | 0   | 0    | 0   | 0    | 0    | 0    | 0    | 0    | 0   |
| 2011 | 0   | 0   | 0   | 0   | 0    | 0   | 0    | 0    | 0    | 0    | 0    | 0   |
| 2012 | 0   | 0   | 0   | 0   | 0    | 0   | 0    | 0    | 0    | 0    | 0    | 0   |
| 2013 | 0   | 0   | 0   | 0   | 0    | 0   | 0    | 0    | 0    | 0    | 0    | 0   |
| 2014 | 0   | 0   | 0   | 0   | 0    | 0   | 0    | 0    | 0    | 0    | 0    | 0   |
| 2015 | 0   | 0   | 0   | 0   | 0    | 0   | 0    | 0    | 0    | 0    | 0    | 0   |
| 2016 | 0   | 0   | 0   | 0   | 0    | 0   | 0    | 0    | 0    | 0    | 0    | 0   |
| 2017 | 0   | 0   | 0   | 0   | 0    | 0   | 0    | 0    | 0    | 0    | 0    | 0   |
| 2018 | 0   | 0   | 0   | 0   | 0    | 0   | 0    | 0    | 0    | 0    | 0    | 0   |
| 2019 | 0   | 0   | 0   | 0   | 0    | 0   | 0    | 0    | 0    | 0    | 0    | 0   |
| 2020 | 160 | 0   | 0   | 0   | 0    | 0   | 0    | 0    | 0    | 240  | 0    | 0   |
| 2021 | 312 | 0   | 0   | 0   | 0    | 0   | 0    | 0    | 0    | 469  | 0    | 0   |
| 2022 | 402 | 0   | 0   | 0   | 0    | 0   | 0    | 0    | 0    | 664  | 0    | 0   |
| 2023 | 424 | 0   | 0   | 0   | 0    | 0   | 0    | 0    | 0    | 839  | 0    | 0   |
| 2024 | 398 | 0   | 0   | 0   | 0    | 0   | 0    | 0    | 0    | 1006 | 0    | 0   |
| 2025 | 419 | 186 | 74  | 6   | 246  | 179 | 233  | 233  | 0    | 1119 | 238  | 187 |
| 2026 | 373 | 336 | 149 | 12  | 464  | 318 | 442  | 442  | 0    | 1165 | 471  | 306 |
| 2027 | 375 | 466 | 168 | 14  | 701  | 454 | 640  | 645  | 0    | 1178 | 703  | 423 |
| 2028 | 346 | 561 | 187 | 19  | 898  | 501 | 827  | 830  | 0    | 1149 | 915  | 465 |
| 2029 | 335 | 633 | 215 | 14  | 1075 | 531 | 958  | 973  | 0    | 1150 | 1106 | 458 |
| 2030 | 294 | 686 | 236 | 15  | 1259 | 530 | 1066 | 1080 | 240  | 1112 | 1273 | 487 |
| 2031 | 302 | 647 | 243 | 27  | 1405 | 461 | 1138 | 1151 | 446  | 1127 | 1381 | 462 |
| 2032 | 306 | 626 | 238 | 22  | 1556 | 441 | 1189 | 1195 | 623  | 1088 | 1459 | 468 |
| 2033 | 319 | 540 | 240 | 26  | 1627 | 406 | 1215 | 1216 | 791  | 1060 | 1550 | 506 |
| 2034 | 329 | 484 | 259 | 42  | 1743 | 416 | 1163 | 1157 | 891  | 967  | 1611 | 498 |
| 2035 | 352 | 431 | 312 | 52  | 1858 | 440 | 1118 | 1117 | 1000 | 915  | 1671 | 553 |
| 2036 | 391 | 416 | 344 | 60  | 1913 | 386 | 1039 | 1039 | 1096 | 875  | 1620 | 583 |
| 2037 | 399 | 449 | 330 | 88  | 1938 | 390 | 969  | 986  | 1144 | 842  | 1484 | 573 |
| 2038 | 410 | 507 | 295 | 100 | 1958 | 417 | 907  | 928  | 1179 | 792  | 1407 | 588 |
| 2039 | 469 | 533 | 306 | 116 | 1958 | 439 | 870  | 891  | 1128 | 752  | 1301 | 556 |
| 2040 | 534 | 562 | 312 | 126 | 1978 | 442 | 863  | 879  | 1050 | 777  | 1260 | 519 |
| 2041 | 573 | 592 | 328 | 119 | 1960 | 463 | 883  | 896  | 993  | 750  | 1222 | 504 |
| 2042 | 596 | 617 | 281 | 120 | 1900 | 452 | 888  | 876  | 974  | 774  | 1229 | 414 |
| 2043 | 599 | 668 | 259 | 110 | 1802 | 419 | 852  | 844  | 956  | 735  | 1190 | 388 |
| 2044 | 630 | 701 | 276 | 118 | 1717 | 416 | 830  | 824  | 937  | 743  | 1153 | 397 |
| 2045 | 665 | 701 | 266 | 132 | 1612 | 443 | 744  | 743  | 885  | 735  | 1113 | 367 |
| 2046 | 669 | 724 | 304 | 150 | 1575 | 445 | 696  | 693  | 864  | 624  | 1011 | 383 |
| 2047 | 714 | 724 | 325 | 196 | 1542 | 488 | 561  | 556  | 729  | 517  | 801  | 338 |
| 2048 | 802 | 652 | 293 | 207 | 1483 | 499 | 426  | 424  | 557  | 410  | 632  | 267 |
| 2049 | 767 | 610 | 248 | 187 | 1310 | 464 | 341  | 345  | 445  | 361  | 543  | 218 |
| 2050 | 704 | 550 | 211 | 160 | 1192 | 420 | 281  | 283  | 347  | 307  | 483  | 162 |
| 2051 | 642 | 496 | 176 | 129 | 1085 | 379 | 206  | 208  | 269  | 266  | 425  | 128 |
| 2052 | 563 | 443 | 130 | 100 | 1007 | 336 | 172  | 173  | 212  | 243  | 346  | 84  |
| 2053 | 508 | 405 | 100 | 67  | 930  | 302 | 136  | 138  | 164  | 223  | 284  | 56  |
| 2054 | 453 | 358 | 76  | 18  | 824  | 278 | 99   | 103  | 93   | 195  | 238  | 30  |
| 2055 | 401 | 327 | 51  | 4   | 730  | 252 | 86   | 89   | 71   | 164  | 181  | 14  |
| 2056 | 353 | 285 | 24  | 0   | 696  | 230 | 72   | 74   | 44   | 133  | 171  | 5   |
| 2057 | 295 | 241 | 1   | 0   | 656  | 203 | 55   | 58   | 24   | 100  | 113  | 0   |
| 2058 | 251 | 227 | 0   | 0   | 604  | 189 | 48   | 49   | 15   | 76   | 94   | 0   |
| 2059 | 201 | 189 | 0   | 0   | 552  | 157 | 34   | 39   | 13   | 48   | 76   | 0   |
| 2060 | 163 | 171 | 0   | 0   | 512  | 135 | 28   | 26   | 13   | 28   | 64   | 0   |
| 2061 | 120 | 152 | 0   | 0   | 466  | 103 | 20   | 18   | 13   | 14   | 59   | 0   |
| 2062 | 77  | 128 | 0   | 0   | 433  | 72  | 2    | 2    | 9    | 0    | 50   | 0   |
| 2063 | 40  | 102 | 0   | 0   | 391  | 34  | 0    | 0    | 7    | 0    | 42   | 0   |
| 2064 | 7   | 74  | 0   | 0   | 365  | 7   | 0    | 0    | 0    | 0    | 31   | 0   |
| 2065 | 0   | 45  | 0   | 0   | 322  | 0   | 0    | 0    | 0    | 0    | 20   | 0   |
| 2066 | 0   | 25  | 0   | 0   | 297  | 0   | 0    | 0    | 0    | 0    | 11   | 0   |
| 2067 | 0   | 8   | 0   | 0   | 272  | 0   | 0    | 0    | 0    | 0    | 0    | 0   |
| 2068 | 0   | 0   | 0   | 0   | 243  | 0   | 0    | 0    | 0    | 0    | 0    | 0   |

|      | 121 | 122 | 123 | 124 | 125 | 126 | 127 | 128 | 129 | 130 | 131 | 132 |
|------|-----|-----|-----|-----|-----|-----|-----|-----|-----|-----|-----|-----|
| 2069 | 0   | 0   | 0   | 0   | 225 | 0   | 0   | 0   | 0   | 0   | 0   | 0   |
| 2070 | 0   | 0   | 0   | 0   | 199 | 0   | 0   | 0   | 0   | 0   | 0   | 0   |
| 2071 | 0   | 0   | 0   | 0   | 187 | 0   | 0   | 0   | 0   | 0   | 0   | 0   |
| 2072 | 0   | 0   | 0   | 0   | 155 | 0   | 0   | 0   | 0   | 0   | 0   | 0   |
| 2073 | 0   | 0   | 0   | 0   | 131 | 0   | 0   | 0   | 0   | 0   | 0   | 0   |
| 2074 | 0   | 0   | 0   | 0   | 104 | 0   | 0   | 0   | 0   | 0   | 0   | 0   |
| 2075 | 0   | 0   | 0   | 0   | 66  | 0   | 0   | 0   | 0   | 0   | 0   | 0   |
| 2076 | 0   | 0   | 0   | 0   | 39  | 0   | 0   | 0   | 0   | 0   | 0   | 0   |
| 2077 | 0   | 0   | 0   | 0   | 11  | 0   | 0   | 0   | 0   | 0   | 0   | 0   |
| 2078 | 0   | 0   | 0   | 0   | 0   | 0   | 0   | 0   | 0   | 0   | 0   | 0   |
| 2079 | 0   | 0   | 0   | 0   | 0   | 0   | 0   | 0   | 0   | 0   | 0   | 0   |
| 2080 | 0   | 0   | 0   | 0   | 0   | 0   | 0   | 0   | 0   | 0   | 0   | 0   |
| 2081 | 0   | 0   | 0   | 0   | 0   | 0   | 0   | 0   | 0   | 0   | 0   | 0   |
| 2082 | 0   | 0   | 0   | 0   | 0   | 0   | 0   | 0   | 0   | 0   | 0   | 0   |
| 2083 | 0   | 0   | 0   | 0   | 0   | 0   | 0   | 0   | 0   | 0   | 0   | 0   |
| 2084 | 0   | 0   | 0   | 0   | 0   | 0   | 0   | 0   | 0   | 0   | 0   | 0   |
| 2085 | 0   | 0   | 0   | 0   | 0   | 0   | 0   | 0   | 0   | 0   | 0   | 0   |
| 2086 | 0   | 0   | 0   | 0   | 0   | 0   | 0   | 0   | 0   | 0   | 0   | 0   |
| 2087 | 0   | 0   | 0   | 0   | 0   | 0   | 0   | 0   | 0   | 0   | 0   | 0   |
| 2088 | 0   | 0   | 0   | 0   | 0   | 0   | 0   | 0   | 0   | 0   | 0   | 0   |
| 2089 | 0   | 0   | 0   | 0   | 0   | 0   | 0   | 0   | 0   | 0   | 0   | 0   |
| 2090 | 0   | 0   | 0   | 0   | 0   | 0   | 0   | 0   | 0   | 0   | 0   | 0   |

|      | 133 | 134  | 135  | 136 | 137 | 138 | 139 | 140 | 141 | 142 |
|------|-----|------|------|-----|-----|-----|-----|-----|-----|-----|
| 2002 | 0   | 0    | 0    | 0   | 0   | 0   | 0   | 0   | 0   | 0   |
| 2003 | 0   | 0    | 0    | 0   | 0   | 0   | 0   | 0   | 0   | 0   |
| 2004 | 0   | 0    | 0    | 0   | 0   | 0   | 0   | 0   | 0   | 0   |
| 2005 | 0   | 0    | 0    | 0   | 0   | 0   | 0   | 0   | 0   | 0   |
| 2006 | 0   | 0    | 0    | 0   | 0   | 0   | 0   | 0   | 0   | 0   |
| 2007 | 0   | 0    | 0    | 0   | 0   | 0   | 0   | 0   | 0   | 0   |
| 2008 | 0   | 0    | 0    | 0   | 0   | 0   | 0   | 0   | 0   | 0   |
| 2009 | 0   | 0    | 0    | 0   | 0   | 0   | 0   | 0   | 0   | 0   |
| 2010 | 0   | 0    | 0    | 0   | 0   | 0   | 0   | 0   | 0   | 0   |
| 2011 | 0   | 0    | 0    | 0   | 0   | 0   | 0   | 0   | 0   | 0   |
| 2012 | 0   | 0    | 0    | 0   | 0   | 0   | 0   | 0   | 0   | 0   |
| 2013 | 0   | 0    | 0    | 0   | 0   | 0   | 0   | 0   | 0   | 0   |
| 2014 | 0   | 0    | 0    | 0   | 0   | 0   | 0   | 0   | 0   | 0   |
| 2015 | 0   | 0    | 0    | 0   | 0   | 0   | 0   | 0   | 0   | 0   |
| 2016 | 0   | 0    | 0    | 0   | 0   | 0   | 0   | 0   | 0   | 0   |
| 2017 | 0   | 0    | 0    | 0   | 0   | 0   | 0   | 0   | 0   | 0   |
| 2018 | 0   | 0    | 0    | 0   | 0   | 0   | 0   | 0   | 0   | 0   |
| 2019 | 0   | 0    | 0    | 0   | 0   | 0   | 0   | 0   | 0   | 0   |
| 2020 | 0   | 0    | 0    | 0   | 0   | 0   | 0   | 0   | 0   | 0   |
| 2021 | 0   | 0    | 0    | 0   | 0   | 0   | 0   | 0   | 0   | 0   |
| 2022 | 0   | 0    | 0    | 0   | 0   | 0   | 0   | 0   | 0   | 0   |
| 2023 | 0   | 0    | 0    | 0   | 0   | 0   | 0   | 0   | 0   | 0   |
| 2024 | 0   | 0    | 0    | 0   | 0   | 0   | 0   | 0   | 0   | 0   |
| 2025 | 186 | 249  | 233  | 0   | 0   | 0   | 0   | 0   | 0   | 0   |
| 2026 | 302 | 486  | 442  | 0   | 0   | 0   | 0   | 0   | 0   | 0   |
| 2027 | 358 | 724  | 640  | 0   | 0   | 0   | 0   | 0   | 0   | 0   |
| 2028 | 352 | 945  | 827  | 0   | 0   | 0   | 0   | 0   | 0   | 0   |
| 2029 | 319 | 1147 | 968  | 0   | 0   | 0   | 0   | 0   | 0   | 0   |
| 2030 | 326 | 1356 | 1072 | 0   | 0   | 0   | 0   | 0   | 0   | 0   |
| 2031 | 256 | 1563 | 1149 | 0   | 0   | 0   | 0   | 0   | 0   | 0   |
| 2032 | 215 | 1750 | 1193 | 0   | 0   | 0   | 0   | 0   | 0   | 0   |
| 2033 | 215 | 1949 | 1219 | 0   | 0   | 0   | 0   | 0   | 0   | 0   |
| 2034 | 230 | 2125 | 1158 | 0   | 0   | 0   | 8   | 0   | 0   | 0   |
| 2035 | 221 | 2318 | 1117 | 0   | 0   | 0   | 6   | 0   | 0   | 0   |
| 2036 | 198 | 2442 | 1041 | 0   | 0   | 0   | 20  | 0   | 0   | 0   |
| 2037 | 171 | 2565 | 982  | 0   | 0   | 0   | 36  | 0   | 0   | 0   |
| 2038 | 187 | 2662 | 923  | 0   | 0   | 0   | 70  | 2   | 2   | 0   |
| 2039 | 172 | 2725 | 883  | 0   | 0   | 0   | 101 | 1   | 3   | 0   |
| 2040 | 190 | 2816 | 872  | 0   | 0   | 0   | 137 | 2   | 6   | 0   |
| 2041 | 199 | 2887 | 885  | 2   | 6   | 0   | 148 | 6   | 9   | 0   |
| 2042 | 172 | 2949 | 877  | 4   | 7   | 0   | 131 | 19  | 13  | 0   |
| 2043 | 167 | 2935 | 845  | 12  | 18  | 0   | 105 | 40  | 35  | 2   |
| 2044 | 131 | 2885 | 823  | 35  | 40  | 0   | 79  | 58  | 58  | 0   |
| 2045 | 138 | 2831 | 743  | 23  | 28  | 0   | 61  | 37  | 36  | 0   |
| 2046 | 122 | 2680 | 695  | 12  | 21  | 2   | 36  | 22  | 21  | 0   |
| 2047 | 91  | 2398 | 559  | 3   | 12  | 5   | 15  | 10  | 9   | 0   |
| 2048 | 55  | 2179 | 427  | 0   | 5   | 2   | 8   | 7   | 4   | 0   |
| 2049 | 40  | 1987 | 346  | 0   | 0   | 1   | 6   | 1   | 0   | 0   |
| 2050 | 26  | 1727 | 281  | 0   | 0   | 0   | 0   | 0   | 0   | 0   |
| 2051 | 19  | 1532 | 204  | 0   | 0   | 0   | 0   | 0   | 0   | 0   |
| 2052 | 11  | 1394 | 165  | 0   | 0   | 0   | 0   | 0   | 0   | 0   |
| 2053 | 0   | 1183 | 129  | 0   | 0   | 0   | 0   | 0   | 0   | 0   |
| 2054 | 0   | 1028 | 91   | 0   | 0   | 0   | 0   | 0   | 0   | 0   |
| 2055 | 0   | 878  | 79   | 0   | 0   | 0   | 0   | 0   | 0   | 0   |
| 2056 | 0   | 744  | 65   | 0   | 0   | 0   | 0   | 0   | 0   | 0   |
| 2057 | 0   | 623  | 48   | 0   | 0   | 0   | 0   | 0   | 0   | 0   |
| 2058 | 0   | 544  | 41   | 0   | 0   | 0   | 0   | 0   | 0   | 0   |
| 2059 | 0   | 484  | 30   | 0   | 0   | 0   | 0   | 0   | 0   | 0   |
| 2060 | 0   | 400  | 23   | 0   | 0   | 0   | 0   | 0   | 0   | 0   |
| 2061 | 0   | 334  | 17   | 0   | 0   | 0   | 0   | 0   | 0   | 0   |
| 2062 | 0   | 276  | 2    | 0   | 0   | 0   | 0   | 0   | 0   | 0   |
| 2063 | 0   | 219  | 0    | 0   | 0   | 0   | 0   | 0   | 0   | 0   |
| 2064 | 0   | 172  | 0    | 0   | 0   | 0   | 0   | 0   | 0   | 0   |
| 2065 | 0   | 125  | 0    | 0   | 0   | 0   | 0   | 0   | 0   | 0   |
| 2066 | 0   | 106  | 0    | 0   | 0   | 0   | 0   | 0   | 0   | 0   |
| 2067 | 0   | 87   | 0    | 0   | 0   | 0   | 0   | 0   | 0   | 0   |
| 2068 | 0   | 68   | 0    | 0   | 0   | 0   | 0   | 0   | 0   | 0   |

|      | 133 | 134 | 135 | 136 | 137 | 138 | 139 | 140 | 141 | 142 |
|------|-----|-----|-----|-----|-----|-----|-----|-----|-----|-----|
| 2069 | 0   | 57  | 0   | 0   | 0   | 0   | 0   | 0   | 0   | 0   |
| 2070 | 0   | 47  | 0   | 0   | 0   | 0   | 0   | 0   | 0   | 0   |
| 2071 | 0   | 41  | 0   | 0   | 0   | 0   | 0   | 0   | 0   | 0   |
| 2072 | 0   | 29  | 0   | 0   | 0   | 0   | 0   | 0   | 0   | 0   |
| 2073 | 0   | 22  | 0   | 0   | 0   | 0   | 0   | 0   | 0   | 0   |
| 2074 | 0   | 16  | 0   | 0   | 0   | 0   | 0   | 0   | 0   | 0   |
| 2075 | 0   | 3   | 0   | 0   | 0   | 0   | 0   | 0   | 0   | 0   |
| 2076 | 0   | 0   | 0   | 0   | 0   | 0   | 0   | 0   | 0   | 0   |
| 2077 | 0   | 0   | 0   | 0   | 0   | 0   | 0   | 0   | 0   | 0   |
| 2078 | 0   | 0   | 0   | 0   | 0   | 0   | 0   | 0   | 0   | 0   |
| 2079 | 0   | 0   | 0   | 0   | 0   | 0   | 0   | 0   | 0   | 0   |
| 2080 | 0   | 0   | 0   | 0   | 0   | 0   | 0   | 0   | 0   | 0   |
| 2081 | 0   | 0   | 0   | 0   | 0   | 0   | 0   | 0   | 0   | 0   |
| 2082 | 0   | 0   | 0   | 0   | 0   | 0   | 0   | 0   | 0   | 0   |
| 2083 | 0   | 0   | 0   | 0   | 0   | 0   | 0   | 0   | 0   | 0   |
| 2084 | 0   | 0   | 0   | 0   | 0   | 0   | 0   | 0   | 0   | 0   |
| 2085 | 0   | 0   | 0   | 0   | 0   | 0   | 0   | 0   | 0   | 0   |
| 2086 | 0   | 0   | 0   | 0   | 0   | 0   | 0   | 0   | 0   | 0   |
| 2087 | 0   | 0   | 0   | 0   | 0   | 0   | 0   | 0   | 0   | 0   |
| 2088 | 0   | 0   | 0   | 0   | 0   | 0   | 0   | 0   | 0   | 0   |
| 2089 | 0   | 0   | 0   | 0   | 0   | 0   | 0   | 0   | 0   | 0   |
| 2090 | 0   | 0   | 0   | 0   | 0   | 0   | 0   | 0   | 0   | 0   |

|      | 143 | 144 | 145 | 146 | 147 | 148 | 149 | 150 | 151 | 152  | 153 |
|------|-----|-----|-----|-----|-----|-----|-----|-----|-----|------|-----|
| 2002 | 0   | 0   | 0   | 0   | 0   | 0   | 0   | 0   | 0   | 0    | 0   |
| 2003 | 0   | 0   | 0   | 0   | 0   | 0   | 0   | 0   | 0   | 0    | 0   |
| 2004 | 0   | 0   | 0   | 0   | 0   | 0   | 0   | 0   | 0   | 0    | 0   |
| 2005 | 0   | 0   | 0   | 0   | 0   | 0   | 0   | 0   | 0   | 0    | 0   |
| 2006 | 0   | 0   | 0   | 0   | 0   | 0   | 0   | 0   | 0   | 0    | 0   |
| 2007 | 0   | 0   | 0   | 0   | 0   | 0   | 0   | 0   | 0   | 0    | 0   |
| 2008 | 0   | 0   | 0   | 0   | 0   | 0   | 0   | 0   | 0   | 0    | 0   |
| 2009 | 0   | 0   | 0   | 0   | 0   | 0   | 0   | 0   | 0   | 0    | 0   |
| 2010 | 0   | 0   | 0   | 0   | 0   | 0   | 0   | 0   | 0   | 0    | 0   |
| 2011 | 0   | 0   | 0   | 0   | 0   | 0   | 0   | 0   | 0   | 0    | 0   |
| 2012 | 0   | 0   | 0   | 0   | 0   | 0   | 0   | 0   | 0   | 0    | 0   |
| 2013 | 0   | 0   | 0   | 0   | 0   | 0   | 0   | 0   | 0   | 0    | 0   |
| 2014 | 0   | 0   | 0   | 0   | 0   | 0   | 0   | 0   | 0   | 0    | 0   |
| 2015 | 0   | 0   | 0   | 0   | 0   | 0   | 0   | 0   | 0   | 0    | 0   |
| 2016 | 0   | 0   | 0   | 0   | 0   | 0   | 0   | 0   | 0   | 0    | 0   |
| 2017 | 0   | 0   | 0   | 0   | 0   | 0   | 0   | 0   | 0   | 0    | 0   |
| 2018 | 0   | 0   | 0   | 0   | 0   | 0   | 0   | 0   | 0   | 0    | 0   |
| 2019 | 0   | 0   | 0   | 0   | 0   | 0   | 0   | 0   | 0   | 0    | 0   |
| 2020 | 0   | 0   | 0   | 0   | 0   | 160 | 0   | 0   | 0   | 0    | 0   |
| 2021 | 0   | 0   | 0   | 0   | 0   | 293 | 0   | 0   | 0   | 0    | 0   |
| 2022 | 0   | 0   | 0   | 0   | 0   | 358 | 0   | 0   | 0   | 0    | 0   |
| 2023 | 0   | 0   | 0   | 0   | 0   | 378 | 0   | 0   | 0   | 0    | 0   |
| 2024 | 0   | 0   | 0   | 0   | 0   | 393 | 0   | 0   | 0   | 0    | 0   |
| 2025 | 0   | 0   | 179 | 179 | 0   | 443 | 186 | 74  | 6   | 246  | 179 |
| 2026 | 0   | 0   | 289 | 298 | 0   | 414 | 324 | 134 | 6   | 453  | 295 |
| 2027 | 0   | 0   | 396 | 419 | 0   | 414 | 457 | 134 | 5   | 677  | 405 |
| 2028 | 0   | 0   | 458 | 457 | 0   | 392 | 581 | 156 | 15  | 957  | 463 |
| 2029 | 0   | 0   | 512 | 502 | 0   | 369 | 668 | 192 | 10  | 1204 | 512 |
| 2030 | 0   | 0   | 535 | 513 | 184 | 319 | 727 | 223 | 12  | 1392 | 532 |
| 2031 | 0   | 0   | 486 | 472 | 307 | 319 | 689 | 275 | 21  | 1561 | 487 |
| 2032 | 0   | 0   | 501 | 489 | 422 | 308 | 689 | 294 | 18  | 1728 | 503 |
| 2033 | 1   | 0   | 479 | 470 | 524 | 352 | 613 | 291 | 18  | 1854 | 477 |
| 2034 | 6   | 0   | 462 | 458 | 597 | 399 | 552 | 310 | 21  | 1954 | 461 |
| 2035 | 10  | 0   | 461 | 446 | 601 | 388 | 506 | 342 | 23  | 2077 | 463 |
| 2036 | 18  | 0   | 418 | 411 | 547 | 418 | 502 | 339 | 38  | 2132 | 428 |
| 2037 | 49  | 0   | 401 | 393 | 510 | 389 | 502 | 334 | 55  | 2146 | 407 |
| 2038 | 87  | 0   | 411 | 410 | 520 | 387 | 508 | 300 | 62  | 2114 | 409 |
| 2039 | 133 | 0   | 397 | 413 | 533 | 439 | 513 | 313 | 66  | 2095 | 408 |
| 2040 | 222 | 0   | 423 | 453 | 550 | 489 | 541 | 334 | 92  | 2063 | 437 |
| 2041 | 264 | 3   | 460 | 489 | 558 | 517 | 556 | 331 | 85  | 2043 | 470 |
| 2042 | 284 | 10  | 462 | 492 | 490 | 573 | 589 | 264 | 98  | 2033 | 472 |
| 2043 | 304 | 25  | 446 | 459 | 468 | 580 | 609 | 264 | 111 | 1982 | 447 |
| 2044 | 363 | 40  | 446 | 453 | 449 | 635 | 633 | 285 | 121 | 1943 | 445 |
| 2045 | 286 | 28  | 486 | 470 | 444 | 639 | 631 | 301 | 134 | 1881 | 461 |
| 2046 | 264 | 17  | 460 | 444 | 404 | 580 | 643 | 299 | 141 | 1791 | 440 |
| 2047 | 221 | 5   | 511 | 503 | 403 | 535 | 635 | 250 | 169 | 1752 | 504 |
| 2048 | 189 | 2   | 444 | 447 | 425 | 491 | 543 | 197 | 133 | 1576 | 451 |
| 2049 | 171 | 0   | 401 | 409 | 400 | 452 | 492 | 133 | 109 | 1362 | 413 |
| 2050 | 135 | 0   | 342 | 357 | 350 | 415 | 432 | 113 | 86  | 1228 | 365 |
| 2051 | 106 | 0   | 303 | 316 | 300 | 373 | 391 | 84  | 66  | 1126 | 328 |
| 2052 | 79  | 0   | 266 | 272 | 245 | 324 | 353 | 53  | 46  | 1022 | 286 |
| 2053 | 61  | 0   | 236 | 232 | 202 | 281 | 326 | 38  | 25  | 911  | 245 |
| 2054 | 43  | 0   | 208 | 203 | 167 | 244 | 297 | 25  | 2   | 799  | 209 |
| 2055 | 33  | 0   | 183 | 174 | 133 | 196 | 262 | 13  | 0   | 704  | 179 |
| 2056 | 26  | 0   | 167 | 160 | 118 | 159 | 233 | 4   | 0   | 661  | 164 |
| 2057 | 11  | 0   | 137 | 127 | 88  | 110 | 196 | 0   | 0   | 616  | 131 |
| 2058 | 4   | 0   | 121 | 110 | 81  | 80  | 184 | 0   | 0   | 560  | 112 |
| 2059 | 0   | 0   | 99  | 90  | 67  | 48  | 154 | 0   | 0   | 503  | 91  |
| 2060 | 0   | 0   | 79  | 72  | 59  | 24  | 127 | 0   | 0   | 472  | 72  |
| 2061 | 0   | 0   | 53  | 51  | 52  | 6   | 112 | 0   | 0   | 421  | 51  |
| 2062 | 0   | 0   | 25  | 25  | 34  | 0   | 90  | 0   | 0   | 378  | 25  |
| 2063 | 0   | 0   | 11  | 13  | 19  | 0   | 69  | 0   | 0   | 331  | 13  |
| 2064 | 0   | 0   | 0   | 0   | 8   | 0   | 48  | 0   | 0   | 301  | 0   |
| 2065 | 0   | 0   | 0   | 0   | 2   | 0   | 31  | 0   | 0   | 256  | 0   |
| 2066 | 0   | 0   | 0   | 0   | 0   | 0   | 17  | 0   | 0   | 228  | 0   |
| 2067 | 0   | 0   | 0   | 0   | 0   | 0   | 6   | 0   | 0   | 198  | 0   |
| 2068 | 0   | 0   | 0   | 0   | 0   | 0   | 0   | 0   | 0   | 174  | 0   |

|      | 143 | 144 | 145 | 146 | 147 | 148 | 149 | 150 | 151 | 152 | 153 |
|------|-----|-----|-----|-----|-----|-----|-----|-----|-----|-----|-----|
| 2069 | 0   | 0   | 0   | 0   | 0   | 0   | 0   | 0   | 0   | 159 | 0   |
| 2070 | 0   | 0   | 0   | 0   | 0   | 0   | 0   | 0   | 0   | 130 | 0   |
| 2071 | 0   | 0   | 0   | 0   | 0   | 0   | 0   | 0   | 0   | 111 | 0   |
| 2072 | 0   | 0   | 0   | 0   | 0   | 0   | 0   | 0   | 0   | 89  | 0   |
| 2073 | 0   | 0   | 0   | 0   | 0   | 0   | 0   | 0   | 0   | 72  | 0   |
| 2074 | 0   | 0   | 0   | 0   | 0   | 0   | 0   | 0   | 0   | 51  | 0   |
| 2075 | 0   | 0   | 0   | 0   | 0   | 0   | 0   | 0   | 0   | 26  | 0   |
| 2076 | 0   | 0   | 0   | 0   | 0   | 0   | 0   | 0   | 0   | 14  | 0   |
| 2077 | 0   | 0   | 0   | 0   | 0   | 0   | 0   | 0   | 0   | 0   | 0   |
| 2078 | 0   | 0   | 0   | 0   | 0   | 0   | 0   | 0   | 0   | 0   | 0   |
| 2079 | 0   | 0   | 0   | 0   | 0   | 0   | 0   | 0   | 0   | 0   | 0   |
| 2080 | 0   | 0   | 0   | 0   | 0   | 0   | 0   | 0   | 0   | 0   | 0   |
| 2081 | 0   | 0   | 0   | 0   | 0   | 0   | 0   | 0   | 0   | 0   | 0   |
| 2082 | 0   | 0   | 0   | 0   | 0   | 0   | 0   | 0   | 0   | 0   | 0   |
| 2083 | 0   | 0   | 0   | 0   | 0   | 0   | 0   | 0   | 0   | 0   | 0   |
| 2084 | 0   | 0   | 0   | 0   | 0   | 0   | 0   | 0   | 0   | 0   | 0   |
| 2085 | 0   | 0   | 0   | 0   | 0   | 0   | 0   | 0   | 0   | 0   | 0   |
| 2086 | 0   | 0   | 0   | 0   | 0   | 0   | 0   | 0   | 0   | 0   | 0   |
| 2087 | 0   | 0   | 0   | 0   | 0   | 0   | 0   | 0   | 0   | 0   | 0   |
| 2088 | 0   | 0   | 0   | 0   | 0   | 0   | 0   | 0   | 0   | 0   | 0   |
| 2089 | 0   | 0   | 0   | 0   | 0   | 0   | 0   | 0   | 0   | 0   | 0   |
| 2090 | 0   | 0   | 0   | 0   | 0   | 0   | 0   | 0   | 0   | 0   | 0   |

|      | 154  | 155  | 156  | 157  | 158  | 159 | 160 | 161  | 162  |
|------|------|------|------|------|------|-----|-----|------|------|
| 2002 | 0    | 0    | 0    | 0    | 0    | 0   | 0   | 0    | 0    |
| 2003 | 0    | 0    | 0    | 0    | 0    | 0   | 0   | 0    | 0    |
| 2004 | 0    | 0    | 0    | 0    | 0    | 0   | 0   | 0    | 0    |
| 2005 | 0    | 0    | 0    | 0    | 0    | 0   | 0   | 0    | 0    |
| 2006 | 0    | 0    | 0    | 0    | 0    | 0   | 0   | 0    | 0    |
| 2007 | 0    | 0    | 0    | 0    | 0    | 0   | 0   | 0    | 0    |
| 2008 | 0    | 0    | 0    | 0    | 0    | 0   | 0   | 0    | 0    |
| 2009 | 0    | 0    | 0    | 0    | 0    | 0   | 0   | 0    | 0    |
| 2010 | 0    | 0    | 0    | 0    | 0    | 0   | 0   | 0    | 0    |
| 2011 | 0    | 0    | 0    | 0    | 0    | 0   | 0   | 0    | 0    |
| 2012 | 0    | 0    | 0    | 0    | 0    | 0   | 0   | 0    | 0    |
| 2013 | 0    | 0    | 0    | 0    | 0    | 0   | 0   | 0    | 0    |
| 2014 | 0    | 0    | 0    | 0    | 0    | 0   | 0   | 0    | 0    |
| 2015 | 0    | 0    | 0    | 0    | 0    | 0   | 0   | 0    | 0    |
| 2016 | 0    | 0    | 0    | 0    | 0    | 0   | 0   | 0    | 0    |
| 2017 | 0    | 0    | 0    | 0    | 0    | 0   | 0   | 0    | 0    |
| 2018 | 0    | 0    | 0    | 0    | 0    | 0   | 0   | 0    | 0    |
| 2019 | 0    | 0    | 0    | 0    | 0    | 0   | 0   | 0    | 0    |
| 2020 | 0    | 0    | 0    | 240  | 0    | 0   | 0   | 0    | 0    |
| 2021 | 0    | 0    | 0    | 433  | 0    | 0   | 0   | 0    | 0    |
| 2022 | 0    | 0    | 0    | 621  | 0    | 0   | 0   | 0    | 0    |
| 2023 | 0    | 0    | 0    | 808  | 0    | 0   | 0   | 0    | 0    |
| 2024 | 0    | 0    | 0    | 969  | 0    | 0   | 0   | 0    | 0    |
| 2025 | 233  | 233  | 0    | 1079 | 238  | 187 | 186 | 249  | 233  |
| 2026 | 398  | 421  | 0    | 1154 | 454  | 286 | 277 | 463  | 420  |
| 2027 | 569  | 616  | 0    | 1172 | 653  | 385 | 303 | 694  | 600  |
| 2028 | 772  | 807  | 0    | 1170 | 894  | 411 | 307 | 982  | 789  |
| 2029 | 909  | 926  | 0    | 1202 | 1095 | 419 | 298 | 1277 | 929  |
| 2030 | 1038 | 1027 | 240  | 1179 | 1240 | 449 | 329 | 1526 | 1044 |
| 2031 | 1133 | 1132 | 425  | 1219 | 1388 | 469 | 278 | 1794 | 1144 |
| 2032 | 1154 | 1149 | 571  | 1193 | 1519 | 521 | 252 | 2012 | 1158 |
| 2033 | 1186 | 1189 | 743  | 1171 | 1573 | 570 | 255 | 2174 | 1198 |
| 2034 | 1165 | 1174 | 880  | 1087 | 1639 | 586 | 268 | 2378 | 1174 |
| 2035 | 1176 | 1171 | 980  | 1039 | 1719 | 627 | 258 | 2567 | 1179 |
| 2036 | 1164 | 1156 | 1035 | 1015 | 1713 | 646 | 233 | 2711 | 1158 |
| 2037 | 1144 | 1151 | 1094 | 974  | 1607 | 641 | 195 | 2828 | 1156 |
| 2038 | 1061 | 1057 | 1146 | 924  | 1578 | 621 | 192 | 2937 | 1070 |
| 2039 | 1002 | 1001 | 1133 | 921  | 1525 | 620 | 194 | 3007 | 1006 |
| 2040 | 1011 | 1007 | 1085 | 914  | 1500 | 610 | 209 | 3113 | 1010 |
| 2041 | 999  | 984  | 1054 | 919  | 1423 | 611 | 202 | 3145 | 1003 |
| 2042 | 967  | 978  | 1058 | 918  | 1460 | 520 | 166 | 3213 | 978  |
| 2043 | 900  | 911  | 1018 | 837  | 1398 | 468 | 157 | 3182 | 908  |
| 2044 | 896  | 907  | 993  | 695  | 1361 | 420 | 122 | 3165 | 889  |
| 2045 | 838  | 840  | 949  | 570  | 1264 | 446 | 137 | 3090 | 831  |
| 2046 | 674  | 693  | 950  | 439  | 1023 | 378 | 81  | 2814 | 667  |
| 2047 | 545  | 561  | 915  | 299  | 811  | 266 | 59  | 2520 | 538  |
| 2048 | 393  | 408  | 786  | 221  | 639  | 205 | 26  | 2328 | 385  |
| 2049 | 308  | 324  | 592  | 187  | 529  | 142 | 9   | 2114 | 299  |
| 2050 | 232  | 235  | 469  | 157  | 455  | 83  | 7   | 1886 | 215  |
| 2051 | 167  | 169  | 361  | 124  | 370  | 54  | 6   | 1687 | 151  |
| 2052 | 133  | 140  | 274  | 103  | 286  | 28  | 0   | 1491 | 120  |
| 2053 | 99   | 108  | 215  | 92   | 208  | 17  | 0   | 1254 | 91   |
| 2054 | 71   | 78   | 151  | 79   | 155  | 6   | 0   | 1104 | 71   |
| 2055 | 56   | 60   | 113  | 64   | 95   | 0   | 0   | 953  | 54   |
| 2056 | 32   | 33   | 72   | 48   | 82   | 0   | 0   | 812  | 29   |
| 2057 | 16   | 16   | 40   | 28   | 55   | 0   | 0   | 667  | 12   |
| 2058 | 14   | 13   | 16   | 15   | 37   | 0   | 0   | 576  | 11   |
| 2059 | 9    | 9    | 10   | 1    | 30   | 0   | 0   | 486  | 7    |
| 2060 | 8    | 8    | 5    | 0    | 18   | 0   | 0   | 384  | 7    |
| 2061 | 2    | 4    | 3    | 0    | 12   | 0   | 0   | 296  | 4    |
| 2062 | 0    | 0    | 2    | 0    | 8    | 0   | 0   | 221  | 0    |
| 2063 | 0    | 0    | 1    | 0    | 5    | 0   | 0   | 162  | 0    |
| 2064 | 0    | 0    | 1    | 0    | 3    | 0   | 0   | 127  | 0    |
| 2065 | 0    | 0    | 0    | 0    | 2    | 0   | 0   | 92   | 0    |
| 2066 | 0    | 0    | 0    | 0    | 0    | 0   | 0   | 82   | 0    |
| 2067 | 0    | 0    | 0    | 0    | 0    | 0   | 0   | 65   | 0    |
| 2068 | 0    | 0    | 0    | 0    | 0    | 0   | 0   | 35   | 0    |

|      | 154 | 155 | 156 | 157 | 158 | 159 | 160 | 161 | 162 |
|------|-----|-----|-----|-----|-----|-----|-----|-----|-----|
| 2069 | 0   | 0   | 0   | 0   | 0   | 0   | 0   | 23  | 0   |
| 2070 | 0   | 0   | 0   | 0   | 0   | 0   | 0   | 12  | 0   |
| 2071 | 0   | 0   | 0   | 0   | 0   | 0   | 0   | 11  | 0   |
| 2072 | 0   | 0   | 0   | 0   | 0   | 0   | 0   | 7   | 0   |
| 2073 | 0   | 0   | 0   | 0   | 0   | 0   | 0   | 7   | 0   |
| 2074 | 0   | 0   | 0   | 0   | 0   | 0   | 0   | 5   | 0   |
| 2075 | 0   | 0   | 0   | 0   | 0   | 0   | 0   | 0   | 0   |
| 2076 | 0   | 0   | 0   | 0   | 0   | 0   | 0   | 0   | 0   |
| 2077 | 0   | 0   | 0   | 0   | 0   | 0   | 0   | 0   | 0   |
| 2078 | 0   | 0   | 0   | 0   | 0   | 0   | 0   | 0   | 0   |
| 2079 | 0   | 0   | 0   | 0   | 0   | 0   | 0   | 0   | 0   |
| 2080 | 0   | 0   | 0   | 0   | 0   | 0   | 0   | 0   | 0   |
| 2081 | 0   | 0   | 0   | 0   | 0   | 0   | 0   | 0   | 0   |
| 2082 | 0   | 0   | 0   | 0   | 0   | 0   | 0   | 0   | 0   |
| 2083 | 0   | 0   | 0   | 0   | 0   | 0   | 0   | 0   | 0   |
| 2084 | 0   | 0   | 0   | 0   | 0   | 0   | 0   | 0   | 0   |
| 2085 | 0   | 0   | 0   | 0   | 0   | 0   | 0   | 0   | 0   |
| 2086 | 0   | 0   | 0   | 0   | 0   | 0   | 0   | 0   | 0   |
| 2087 | 0   | 0   | 0   | 0   | 0   | 0   | 0   | 0   | 0   |
| 2088 | 0   | 0   | 0   | 0   | 0   | 0   | 0   | 0   | 0   |
| 2089 | 0   | 0   | 0   | 0   | 0   | 0   | 0   | 0   | 0   |
| 2090 | 0   | 0   | 0   | 0   | 0   | 0   | 0   | 0   | 0   |



|      | 1    | 2   | 3   | 4   | 5   | 6   | 7   | 8   | 9   | 10   | 11  | 12  |
|------|------|-----|-----|-----|-----|-----|-----|-----|-----|------|-----|-----|
| 2002 | 0    | 0   | 0   | 0   | 0   | 0   | 0   | 0   | 0   | 0    | 0   | 0   |
| 2003 | 0    | 0   | 0   | 0   | 0   | 0   | 0   | 0   | 0   | 0    | 0   | 0   |
| 2004 | 0    | 0   | 0   | 0   | 0   | 0   | 0   | 0   | 0   | 0    | 0   | 0   |
| 2005 | 0    | 0   | 0   | 0   | 0   | 0   | 0   | 0   | 0   | 0    | 0   | 0   |
| 2006 | 0    | 0   | 0   | 0   | 0   | 0   | 0   | 0   | 0   | 0    | 0   | 0   |
| 2007 | 0    | 0   | 0   | 0   | 0   | 0   | 0   | 0   | 0   | 0    | 0   | 0   |
| 2008 | 0    | 0   | 0   | 0   | 0   | 0   | 0   | 0   | 0   | 0    | 0   | 0   |
| 2009 | 0    | 0   | 0   | 0   | 0   | 0   | 0   | 0   | 0   | 0    | 0   | 0   |
| 2010 | 0    | 0   | 0   | 0   | 0   | 0   | 0   | 0   | 0   | 0    | 0   | 0   |
| 2011 | 0    | 0   | 0   | 0   | 0   | 0   | 0   | 0   | 0   | 0    | 0   | 0   |
| 2012 | 0    | 0   | 0   | 0   | 0   | 0   | 0   | 0   | 0   | 0    | 0   | 0   |
| 2013 | 0    | 0   | 0   | 0   | 0   | 0   | 0   | 0   | 0   | 0    | 0   | 0   |
| 2014 | 0    | 0   | 0   | 0   | 0   | 0   | 0   | 0   | 0   | 0    | 0   | 0   |
| 2015 | 0    | 0   | 0   | 0   | 0   | 0   | 0   | 0   | 0   | 0    | 0   | 0   |
| 2016 | 0    | 0   | 0   | 0   | 0   | 0   | 0   | 0   | 0   | 0    | 0   | 0   |
| 2017 | 0    | 0   | 0   | 0   | 0   | 0   | 0   | 0   | 0   | 0    | 0   | 0   |
| 2018 | 0    | 0   | 0   | 0   | 0   | 0   | 0   | 0   | 0   | 0    | 0   | 0   |
| 2019 | 0    | 0   | 0   | 0   | 0   | 0   | 0   | 0   | 0   | 0    | 0   | 0   |
| 2020 | 0    | 0   | 0   | 0   | 0   | 0   | 0   | 0   | 0   | 0    | 0   | 0   |
| 2021 | 0    | 0   | 0   | 0   | 0   | 0   | 0   | 0   | 0   | 0    | 0   | 0   |
| 2022 | 0    | 0   | 0   | 0   | 0   | 0   | 0   | 0   | 0   | 0    | 0   | 0   |
| 2023 | 0    | 0   | 0   | 0   | 0   | 0   | 0   | 0   | 0   | 0    | 0   | 0   |
| 2024 | 0    | 0   | 0   | 0   | 0   | 0   | 0   | 0   | 0   | 0    | 0   | 0   |
| 2025 | 0    | 0   | 0   | 0   | 0   | 0   | 0   | 0   | 0   | 0    | 0   | 0   |
| 2026 | 0    | 0   | 0   | 0   | 0   | 0   | 0   | 0   | 0   | 0    | 0   | 0   |
| 2027 | 0    | 0   | 0   | 0   | 0   | 0   | 0   | 0   | 0   | 10   | 0   | 0   |
| 2028 | 0    | 0   | 0   | 0   | 0   | 0   | 0   | 0   | 0   | 10   | 0   | 0   |
| 2029 | 0    | 0   | 0   | 0   | 0   | 0   | 0   | 0   | 0   | 24   | 4   | 0   |
| 2030 | 0    | 0   | 0   | 0   | 0   | 0   | 0   | 0   | 0   | 38   | 4   | 0   |
| 2031 | 0    | 0   | 0   | 0   | 0   | 0   | 0   | 0   | 0   | 54   | 4   | 0   |
| 2032 | 0    | 0   | 0   | 0   | 0   | 0   | 0   | 0   | 0   | 94   | 9   | 0   |
| 2033 | 6    | 0   | 0   | 9   | 0   | 0   | 0   | 0   | 0   | 130  | 17  | 0   |
| 2034 | 6    | 0   | 0   | 9   | 0   | 0   | 0   | 0   | 0   | 146  | 22  | 0   |
| 2035 | 6    | 0   | 0   | 13  | 0   | 0   | 0   | 0   | 0   | 163  | 27  | 10  |
| 2036 | 26   | 0   | 0   | 22  | 0   | 0   | 0   | 0   | 0   | 216  | 27  | 11  |
| 2037 | 31   | 0   | 0   | 29  | 0   | 10  | 0   | 0   | 0   | 265  | 27  | 21  |
| 2038 | 38   | 0   | 0   | 35  | 0   | 24  | 0   | 0   | 0   | 297  | 47  | 31  |
| 2039 | 64   | 0   | 0   | 56  | 0   | 24  | 10  | 10  | 10  | 331  | 58  | 34  |
| 2040 | 89   | 0   | 0   | 66  | 0   | 25  | 16  | 16  | 16  | 350  | 61  | 44  |
| 2041 | 95   | 0   | 0   | 94  | 0   | 25  | 35  | 35  | 35  | 373  | 84  | 52  |
| 2042 | 123  | 12  | 0   | 170 | 0   | 34  | 49  | 49  | 49  | 405  | 105 | 62  |
| 2043 | 145  | 12  | 0   | 287 | 11  | 34  | 66  | 66  | 66  | 439  | 120 | 94  |
| 2044 | 227  | 12  | 0   | 381 | 31  | 52  | 92  | 92  | 92  | 458  | 122 | 117 |
| 2045 | 334  | 24  | 1   | 528 | 68  | 89  | 127 | 127 | 127 | 493  | 122 | 146 |
| 2046 | 456  | 25  | 1   | 660 | 118 | 150 | 162 | 162 | 162 | 522  | 123 | 154 |
| 2047 | 621  | 25  | 1   | 739 | 171 | 210 | 212 | 212 | 212 | 545  | 123 | 154 |
| 2048 | 773  | 45  | 35  | 775 | 247 | 303 | 305 | 305 | 305 | 565  | 126 | 180 |
| 2049 | 849  | 75  | 72  | 807 | 324 | 391 | 393 | 393 | 393 | 602  | 133 | 210 |
| 2050 | 983  | 107 | 115 | 807 | 383 | 424 | 437 | 437 | 437 | 684  | 149 | 275 |
| 2051 | 1159 | 130 | 155 | 814 | 449 | 509 | 512 | 512 | 512 | 785  | 169 | 332 |
| 2052 | 1284 | 170 | 245 | 814 | 571 | 609 | 603 | 603 | 603 | 925  | 171 | 364 |
| 2053 | 1365 | 192 | 287 | 814 | 681 | 698 | 698 | 698 | 698 | 1104 | 181 | 401 |
| 2054 | 1427 | 251 | 369 | 814 | 755 | 765 | 765 | 765 | 765 | 1255 | 215 | 429 |
| 2055 | 1434 | 289 | 411 | 814 | 790 | 789 | 789 | 789 | 789 | 1350 | 242 | 479 |
| 2056 | 1442 | 290 | 444 | 814 | 797 | 797 | 797 | 797 | 797 | 1395 | 256 | 542 |
| 2057 | 1442 | 308 | 535 | 814 | 807 | 806 | 806 | 806 | 806 | 1431 | 272 | 600 |
| 2058 | 1449 | 308 | 626 | 814 | 807 | 807 | 807 | 807 | 807 | 1442 | 301 | 653 |
| 2059 | 1449 | 313 | 683 | 814 | 814 | 814 | 807 | 807 | 807 | 1442 | 311 | 680 |
| 2060 | 1449 | 313 | 755 | 814 | 814 | 814 | 807 | 807 | 807 | 1448 | 312 | 683 |
| 2061 | 1449 | 313 | 770 | 814 | 814 | 814 | 807 | 807 | 807 | 1448 | 312 | 713 |
| 2062 | 1449 | 313 | 800 | 814 | 814 | 814 | 807 | 807 | 807 | 1448 | 312 | 753 |
| 2063 | 1449 | 313 | 806 | 814 | 814 | 814 | 807 | 807 | 807 | 1448 | 312 | 789 |
| 2064 | 1449 | 313 | 812 | 814 | 814 | 814 | 807 | 807 | 807 | 1448 | 312 | 808 |
| 2065 | 1449 | 313 | 812 | 814 | 814 | 814 | 807 | 807 | 807 | 1448 | 312 | 808 |
| 2066 | 1449 | 313 | 814 | 814 | 814 | 814 | 807 | 807 | 807 | 1448 | 312 | 808 |
| 2067 | 1449 | 313 | 814 | 814 | 814 | 814 | 807 | 807 | 807 | 1448 | 312 | 808 |
| 2068 | 1449 | 313 | 814 | 814 | 814 | 814 | 807 | 807 | 807 | 1448 | 312 | 808 |

|      | 1    | 2   | 3   | 4   | 5   | 6   | 7   | 8   | 9   | 10   | 11  | 12  |
|------|------|-----|-----|-----|-----|-----|-----|-----|-----|------|-----|-----|
| 2069 | 1449 | 313 | 814 | 814 | 814 | 814 | 807 | 807 | 807 | 1448 | 312 | 808 |
| 2070 | 1449 | 313 | 814 | 814 | 814 | 814 | 807 | 807 | 807 | 1448 | 312 | 808 |
| 2071 | 1449 | 313 | 814 | 814 | 814 | 814 | 807 | 807 | 807 | 1448 | 312 | 808 |
| 2072 | 1449 | 313 | 814 | 814 | 814 | 814 | 807 | 807 | 807 | 1448 | 312 | 808 |
| 2073 | 1449 | 313 | 814 | 814 | 814 | 814 | 807 | 807 | 807 | 1448 | 312 | 808 |
| 2074 | 1449 | 313 | 814 | 814 | 814 | 814 | 807 | 807 | 807 | 1448 | 312 | 808 |
| 2075 | 1449 | 313 | 814 | 814 | 814 | 814 | 807 | 807 | 807 | 1448 | 312 | 808 |
| 2076 | 1449 | 313 | 814 | 814 | 814 | 814 | 807 | 807 | 807 | 1448 | 312 | 808 |
| 2077 | 1449 | 313 | 814 | 814 | 814 | 814 | 807 | 807 | 807 | 1448 | 312 | 808 |
| 2078 | 1449 | 313 | 814 | 814 | 814 | 814 | 807 | 807 | 807 | 1448 | 312 | 808 |
| 2079 | 1449 | 313 | 814 | 814 | 814 | 814 | 807 | 807 | 807 | 1448 | 312 | 808 |
| 2080 | 1449 | 313 | 814 | 814 | 814 | 814 | 807 | 807 | 807 | 1448 | 312 | 808 |
| 2081 | 1449 | 313 | 814 | 814 | 814 | 814 | 807 | 807 | 807 | 1448 | 312 | 808 |
| 2082 | 1449 | 313 | 814 | 814 | 814 | 814 | 807 | 807 | 807 | 1448 | 312 | 808 |
| 2083 | 1449 | 313 | 814 | 814 | 814 | 814 | 807 | 807 | 807 | 1448 | 312 | 808 |
| 2084 | 1449 | 313 | 814 | 814 | 814 | 814 | 807 | 807 | 807 | 1448 | 312 | 808 |
| 2085 | 1449 | 313 | 814 | 814 | 814 | 814 | 807 | 807 | 807 | 1448 | 312 | 808 |
| 2086 | 1449 | 313 | 814 | 814 | 814 | 814 | 807 | 807 | 807 | 1448 | 312 | 808 |
| 2087 | 1449 | 313 | 814 | 814 | 814 | 814 | 807 | 807 | 807 | 1448 | 312 | 808 |
| 2088 | 1449 | 313 | 814 | 814 | 814 | 814 | 807 | 807 | 807 | 1448 | 312 | 808 |
| 2089 | 1449 | 313 | 814 | 814 | 814 | 814 | 807 | 807 | 807 | 1448 | 312 | 808 |
| 2090 | 1449 | 313 | 814 | 814 | 814 | 814 | 807 | 807 | 807 | 1448 | 312 | 808 |

|      | 13  | 14  | 15  | 16  | 17  | 18  | 19   | 20  | 21  | 22  | 23  | 24  |
|------|-----|-----|-----|-----|-----|-----|------|-----|-----|-----|-----|-----|
| 2002 | 0   | 0   | 0   | 0   | 0   | 0   | 0    | 0   | 0   | 0   | 0   | 0   |
| 2003 | 0   | 0   | 0   | 0   | 0   | 0   | 0    | 0   | 0   | 0   | 0   | 0   |
| 2004 | 0   | 0   | 0   | 0   | 0   | 0   | 0    | 0   | 0   | 0   | 0   | 0   |
| 2005 | 0   | 0   | 0   | 0   | 0   | 0   | 0    | 0   | 0   | 0   | 0   | 0   |
| 2006 | 0   | 0   | 0   | 0   | 0   | 0   | 0    | 0   | 0   | 0   | 0   | 0   |
| 2007 | 0   | 0   | 0   | 0   | 0   | 0   | 0    | 0   | 0   | 0   | 0   | 0   |
| 2008 | 0   | 0   | 0   | 0   | 0   | 0   | 0    | 0   | 0   | 0   | 0   | 0   |
| 2009 | 0   | 0   | 0   | 0   | 0   | 0   | 0    | 0   | 0   | 0   | 0   | 0   |
| 2010 | 0   | 0   | 0   | 0   | 0   | 0   | 0    | 0   | 0   | 0   | 0   | 0   |
| 2011 | 0   | 0   | 0   | 0   | 0   | 0   | 0    | 0   | 0   | 0   | 0   | 0   |
| 2012 | 0   | 0   | 0   | 0   | 0   | 0   | 0    | 0   | 0   | 0   | 0   | 0   |
| 2013 | 0   | 0   | 0   | 0   | 0   | 0   | 0    | 0   | 0   | 0   | 0   | 0   |
| 2014 | 0   | 0   | 0   | 0   | 0   | 0   | 0    | 0   | 0   | 0   | 0   | 0   |
| 2015 | 0   | 0   | 0   | 0   | 0   | 0   | 0    | 0   | 0   | 0   | 0   | 0   |
| 2016 | 0   | 0   | 0   | 0   | 0   | 0   | 0    | 0   | 0   | 0   | 0   | 0   |
| 2017 | 0   | 0   | 0   | 0   | 0   | 0   | 0    | 0   | 0   | 0   | 0   | 0   |
| 2018 | 0   | 0   | 0   | 0   | 0   | 0   | 0    | 0   | 0   | 0   | 0   | 0   |
| 2019 | 0   | 0   | 0   | 0   | 0   | 0   | 0    | 0   | 0   | 0   | 0   | 0   |
| 2020 | 0   | 0   | 0   | 0   | 0   | 0   | 0    | 0   | 0   | 0   | 0   | 0   |
| 2021 | 5   | 0   | 0   | 0   | 0   | 0   | 0    | 0   | 0   | 1   | 0   | 0   |
| 2022 | 5   | 0   | 0   | 0   | 0   | 0   | 0    | 0   | 0   | 1   | 0   | 0   |
| 2023 | 11  | 0   | 0   | 0   | 0   | 0   | 0    | 0   | 0   | 3   | 0   | 0   |
| 2024 | 16  | 0   | 0   | 0   | 0   | 0   | 0    | 0   | 0   | 12  | 0   | 0   |
| 2025 | 30  | 0   | 0   | 0   | 0   | 0   | 0    | 0   | 0   | 19  | 0   | 0   |
| 2026 | 51  | 0   | 0   | 0   | 0   | 0   | 0    | 0   | 0   | 37  | 0   | 0   |
| 2027 | 71  | 0   | 10  | 10  | 4   | 10  | 8    | 0   | 0   | 53  | 0   | 9   |
| 2028 | 85  | 0   | 10  | 10  | 4   | 10  | 10   | 0   | 0   | 76  | 0   | 10  |
| 2029 | 92  | 8   | 10  | 11  | 6   | 11  | 19   | 4   | 0   | 81  | 8   | 18  |
| 2030 | 119 | 20  | 31  | 20  | 15  | 20  | 25   | 4   | 0   | 90  | 11  | 41  |
| 2031 | 159 | 20  | 43  | 28  | 23  | 28  | 35   | 4   | 0   | 100 | 11  | 51  |
| 2032 | 197 | 28  | 74  | 45  | 41  | 45  | 54   | 4   | 0   | 109 | 29  | 70  |
| 2033 | 230 | 32  | 91  | 70  | 68  | 70  | 88   | 16  | 0   | 149 | 47  | 84  |
| 2034 | 278 | 32  | 109 | 77  | 75  | 77  | 104  | 22  | 0   | 176 | 57  | 84  |
| 2035 | 305 | 32  | 116 | 78  | 78  | 78  | 117  | 27  | 10  | 212 | 57  | 93  |
| 2036 | 325 | 33  | 134 | 88  | 88  | 88  | 131  | 27  | 11  | 232 | 58  | 103 |
| 2037 | 331 | 60  | 152 | 113 | 113 | 113 | 158  | 27  | 11  | 249 | 58  | 152 |
| 2038 | 359 | 69  | 188 | 142 | 142 | 142 | 182  | 27  | 11  | 276 | 71  | 187 |
| 2039 | 362 | 82  | 225 | 170 | 170 | 170 | 246  | 36  | 21  | 307 | 72  | 217 |
| 2040 | 373 | 86  | 252 | 187 | 187 | 187 | 295  | 51  | 23  | 346 | 84  | 256 |
| 2041 | 373 | 94  | 278 | 206 | 206 | 206 | 325  | 54  | 33  | 369 | 85  | 284 |
| 2042 | 377 | 116 | 300 | 231 | 231 | 231 | 348  | 61  | 41  | 375 | 94  | 303 |
| 2043 | 390 | 140 | 312 | 262 | 262 | 262 | 383  | 77  | 41  | 375 | 117 | 303 |
| 2044 | 404 | 168 | 321 | 283 | 283 | 283 | 426  | 102 | 52  | 375 | 156 | 329 |
| 2045 | 423 | 181 | 337 | 292 | 292 | 292 | 448  | 112 | 78  | 415 | 185 | 331 |
| 2046 | 435 | 199 | 342 | 292 | 292 | 292 | 468  | 112 | 105 | 486 | 208 | 351 |
| 2047 | 436 | 214 | 359 | 313 | 313 | 313 | 537  | 127 | 130 | 623 | 229 | 375 |
| 2048 | 441 | 251 | 368 | 322 | 322 | 322 | 617  | 141 | 140 | 733 | 318 | 406 |
| 2049 | 508 | 359 | 392 | 349 | 349 | 349 | 742  | 159 | 155 | 774 | 371 | 419 |
| 2050 | 643 | 396 | 405 | 385 | 385 | 385 | 852  | 171 | 247 | 794 | 406 | 484 |
| 2051 | 729 | 409 | 445 | 407 | 407 | 407 | 1015 | 171 | 301 | 807 | 439 | 590 |
| 2052 | 769 | 444 | 540 | 464 | 464 | 464 | 1190 | 201 | 349 | 807 | 520 | 661 |
| 2053 | 789 | 549 | 624 | 533 | 533 | 533 | 1311 | 228 | 382 | 813 | 587 | 718 |
| 2054 | 808 | 642 | 698 | 607 | 607 | 607 | 1374 | 251 | 417 | 813 | 650 | 760 |
| 2055 | 814 | 690 | 747 | 689 | 689 | 689 | 1411 | 256 | 439 | 813 | 720 | 789 |
| 2056 | 814 | 737 | 780 | 743 | 743 | 743 | 1432 | 282 | 494 | 813 | 760 | 804 |
| 2057 | 814 | 770 | 808 | 780 | 780 | 780 | 1447 | 309 | 557 | 813 | 789 | 810 |
| 2058 | 814 | 798 | 808 | 805 | 805 | 805 | 1447 | 310 | 630 | 813 | 808 | 810 |
| 2059 | 814 | 808 | 808 | 811 | 811 | 811 | 1448 | 311 | 663 | 813 | 808 | 810 |
| 2060 | 814 | 808 | 808 | 811 | 811 | 811 | 1448 | 311 | 690 | 813 | 808 | 810 |
| 2061 | 814 | 808 | 808 | 811 | 811 | 811 | 1448 | 312 | 723 | 813 | 808 | 810 |
| 2062 | 814 | 808 | 808 | 811 | 811 | 811 | 1448 | 312 | 760 | 813 | 808 | 810 |
| 2063 | 814 | 808 | 808 | 811 | 811 | 811 | 1448 | 312 | 790 | 813 | 808 | 810 |
| 2064 | 814 | 808 | 808 | 811 | 811 | 811 | 1448 | 312 | 808 | 813 | 808 | 810 |
| 2065 | 814 | 808 | 808 | 811 | 811 | 811 | 1448 | 312 | 808 | 813 | 808 | 810 |
| 2066 | 814 | 808 | 808 | 811 | 811 | 811 | 1448 | 312 | 808 | 813 | 808 | 810 |
| 2067 | 814 | 808 | 808 | 811 | 811 | 811 | 1448 | 312 | 808 | 813 | 808 | 810 |
| 2068 | 814 | 808 | 808 | 811 | 811 | 811 | 1448 | 312 | 808 | 813 | 808 | 810 |

|      | 13  | 14  | 15  | 16  | 17  | 18  | 19   | 20  | 21  | 22  | 23  | 24  |
|------|-----|-----|-----|-----|-----|-----|------|-----|-----|-----|-----|-----|
| 2069 | 814 | 808 | 808 | 811 | 811 | 811 | 1448 | 312 | 808 | 813 | 808 | 810 |
| 2070 | 814 | 808 | 808 | 811 | 811 | 811 | 1448 | 312 | 808 | 813 | 808 | 810 |
| 2071 | 814 | 808 | 808 | 811 | 811 | 811 | 1448 | 312 | 808 | 813 | 808 | 810 |
| 2072 | 814 | 808 | 808 | 811 | 811 | 811 | 1448 | 312 | 808 | 813 | 808 | 810 |
| 2073 | 814 | 808 | 808 | 811 | 811 | 811 | 1448 | 312 | 808 | 813 | 808 | 810 |
| 2074 | 814 | 808 | 808 | 811 | 811 | 811 | 1448 | 312 | 808 | 813 | 808 | 810 |
| 2075 | 814 | 808 | 808 | 811 | 811 | 811 | 1448 | 312 | 808 | 813 | 808 | 810 |
| 2076 | 814 | 808 | 808 | 811 | 811 | 811 | 1448 | 312 | 808 | 813 | 808 | 810 |
| 2077 | 814 | 808 | 808 | 811 | 811 | 811 | 1448 | 312 | 808 | 813 | 808 | 810 |
| 2078 | 814 | 808 | 808 | 811 | 811 | 811 | 1448 | 312 | 808 | 813 | 808 | 810 |
| 2079 | 814 | 808 | 808 | 811 | 811 | 811 | 1448 | 312 | 808 | 813 | 808 | 810 |
| 2080 | 814 | 808 | 808 | 811 | 811 | 811 | 1448 | 312 | 808 | 813 | 808 | 810 |
| 2081 | 814 | 808 | 808 | 811 | 811 | 811 | 1448 | 312 | 808 | 813 | 808 | 810 |
| 2082 | 814 | 808 | 808 | 811 | 811 | 811 | 1448 | 312 | 808 | 813 | 808 | 810 |
| 2083 | 814 | 808 | 808 | 811 | 811 | 811 | 1448 | 312 | 808 | 813 | 808 | 810 |
| 2084 | 814 | 808 | 808 | 811 | 811 | 811 | 1448 | 312 | 808 | 813 | 808 | 810 |
| 2085 | 814 | 808 | 808 | 811 | 811 | 811 | 1448 | 312 | 808 | 813 | 808 | 810 |
| 2086 | 814 | 808 | 808 | 811 | 811 | 811 | 1448 | 312 | 808 | 813 | 808 | 810 |
| 2087 | 814 | 808 | 808 | 811 | 811 | 811 | 1448 | 312 | 808 | 813 | 808 | 810 |
| 2088 | 814 | 808 | 808 | 811 | 811 | 811 | 1448 | 312 | 808 | 813 | 808 | 810 |
| 2089 | 814 | 808 | 808 | 811 | 811 | 811 | 1448 | 312 | 808 | 813 | 808 | 810 |
| 2090 | 814 | 808 | 808 | 811 | 811 | 811 | 1448 | 312 | 808 | 813 | 808 | 810 |

|      | 25  | 26  | 27  | 28   | 29  | 30  | 31  | 32  | 33  | 34  | 35  | 36  |
|------|-----|-----|-----|------|-----|-----|-----|-----|-----|-----|-----|-----|
| 2002 | 0   | 0   | 0   | 0    | 0   | 0   | 0   | 0   | 0   | 0   | 0   | 0   |
| 2003 | 0   | 0   | 0   | 0    | 0   | 0   | 0   | 0   | 0   | 0   | 0   | 0   |
| 2004 | 0   | 0   | 0   | 0    | 0   | 0   | 0   | 0   | 0   | 0   | 0   | 0   |
| 2005 | 0   | 0   | 0   | 0    | 0   | 0   | 0   | 0   | 0   | 0   | 0   | 0   |
| 2006 | 0   | 0   | 0   | 0    | 0   | 0   | 0   | 0   | 0   | 0   | 0   | 0   |
| 2007 | 0   | 0   | 0   | 0    | 0   | 0   | 0   | 0   | 0   | 0   | 0   | 0   |
| 2008 | 0   | 0   | 0   | 0    | 0   | 0   | 0   | 0   | 0   | 0   | 0   | 0   |
| 2009 | 0   | 0   | 0   | 0    | 0   | 0   | 0   | 0   | 0   | 0   | 0   | 0   |
| 2010 | 0   | 0   | 0   | 0    | 0   | 0   | 0   | 0   | 0   | 0   | 0   | 0   |
| 2011 | 0   | 0   | 0   | 0    | 0   | 0   | 0   | 0   | 0   | 0   | 0   | 0   |
| 2012 | 0   | 0   | 0   | 0    | 0   | 0   | 0   | 0   | 0   | 0   | 0   | 0   |
| 2013 | 0   | 0   | 0   | 0    | 0   | 0   | 0   | 0   | 0   | 0   | 0   | 0   |
| 2014 | 0   | 0   | 0   | 0    | 0   | 0   | 0   | 0   | 0   | 0   | 0   | 0   |
| 2015 | 0   | 0   | 0   | 0    | 0   | 0   | 0   | 0   | 0   | 0   | 0   | 0   |
| 2016 | 0   | 0   | 0   | 0    | 0   | 0   | 0   | 0   | 0   | 0   | 0   | 0   |
| 2017 | 0   | 0   | 0   | 0    | 0   | 0   | 0   | 0   | 0   | 0   | 0   | 0   |
| 2018 | 0   | 0   | 0   | 0    | 0   | 0   | 0   | 0   | 0   | 0   | 0   | 0   |
| 2019 | 0   | 0   | 0   | 0    | 0   | 0   | 0   | 0   | 0   | 0   | 0   | 0   |
| 2020 | 0   | 0   | 0   | 0    | 0   | 0   | 0   | 0   | 0   | 0   | 0   | 0   |
| 2021 | 0   | 0   | 0   | 0    | 0   | 0   | 0   | 0   | 0   | 0   | 0   | 0   |
| 2022 | 0   | 0   | 0   | 0    | 0   | 0   | 0   | 0   | 0   | 0   | 0   | 0   |
| 2023 | 0   | 0   | 0   | 0    | 0   | 0   | 0   | 0   | 0   | 0   | 0   | 0   |
| 2024 | 0   | 0   | 0   | 0    | 0   | 0   | 0   | 0   | 0   | 0   | 0   | 0   |
| 2025 | 0   | 0   | 0   | 0    | 0   | 0   | 0   | 0   | 0   | 0   | 0   | 0   |
| 2026 | 0   | 0   | 0   | 0    | 0   | 0   | 0   | 0   | 0   | 0   | 0   | 0   |
| 2027 | 10  | 0   | 8   | 0    | 0   | 0   | 0   | 0   | 0   | 0   | 0   | 0   |
| 2028 | 10  | 0   | 10  | 0    | 0   | 0   | 2   | 0   | 0   | 0   | 0   | 0   |
| 2029 | 11  | 1   | 11  | 0    | 0   | 0   | 4   | 0   | 0   | 0   | 0   | 0   |
| 2030 | 11  | 1   | 11  | 0    | 0   | 0   | 19  | 0   | 0   | 0   | 0   | 0   |
| 2031 | 20  | 10  | 20  | 0    | 0   | 0   | 26  | 0   | 1   | 0   | 0   | 0   |
| 2032 | 35  | 25  | 35  | 0    | 0   | 0   | 44  | 0   | 15  | 0   | 0   | 0   |
| 2033 | 65  | 55  | 65  | 12   | 0   | 0   | 67  | 0   | 39  | 1   | 1   | 1   |
| 2034 | 72  | 62  | 72  | 13   | 1   | 0   | 91  | 0   | 72  | 2   | 2   | 2   |
| 2035 | 80  | 72  | 80  | 19   | 4   | 0   | 95  | 0   | 103 | 8   | 8   | 8   |
| 2036 | 81  | 74  | 81  | 47   | 11  | 0   | 102 | 1   | 132 | 35  | 35  | 35  |
| 2037 | 100 | 93  | 100 | 85   | 23  | 0   | 107 | 1   | 136 | 60  | 60  | 60  |
| 2038 | 120 | 117 | 120 | 90   | 26  | 0   | 117 | 16  | 140 | 65  | 65  | 65  |
| 2039 | 148 | 146 | 148 | 138  | 34  | 2   | 124 | 23  | 146 | 93  | 93  | 93  |
| 2040 | 168 | 168 | 168 | 168  | 34  | 16  | 136 | 47  | 151 | 107 | 107 | 107 |
| 2041 | 179 | 179 | 179 | 178  | 38  | 25  | 165 | 59  | 164 | 116 | 116 | 116 |
| 2042 | 196 | 196 | 196 | 212  | 47  | 58  | 238 | 107 | 175 | 129 | 129 | 129 |
| 2043 | 223 | 223 | 223 | 235  | 47  | 65  | 354 | 143 | 194 | 136 | 136 | 136 |
| 2044 | 263 | 263 | 263 | 349  | 56  | 96  | 439 | 196 | 230 | 178 | 178 | 178 |
| 2045 | 273 | 273 | 273 | 474  | 69  | 113 | 541 | 241 | 291 | 224 | 224 | 224 |
| 2046 | 293 | 293 | 293 | 581  | 80  | 138 | 659 | 276 | 343 | 266 | 266 | 266 |
| 2047 | 303 | 303 | 303 | 689  | 96  | 177 | 739 | 318 | 388 | 319 | 319 | 319 |
| 2048 | 361 | 361 | 361 | 794  | 113 | 218 | 768 | 378 | 439 | 385 | 385 | 385 |
| 2049 | 400 | 400 | 400 | 898  | 129 | 255 | 795 | 438 | 513 | 445 | 445 | 445 |
| 2050 | 439 | 439 | 439 | 1020 | 162 | 298 | 804 | 521 | 591 | 525 | 525 | 525 |
| 2051 | 494 | 494 | 494 | 1150 | 191 | 341 | 807 | 595 | 654 | 601 | 601 | 601 |
| 2052 | 585 | 585 | 585 | 1254 | 224 | 389 | 811 | 667 | 710 | 669 | 669 | 669 |
| 2053 | 657 | 657 | 657 | 1336 | 251 | 435 | 814 | 722 | 753 | 722 | 722 | 722 |
| 2054 | 720 | 720 | 720 | 1392 | 274 | 495 | 814 | 764 | 789 | 766 | 766 | 766 |
| 2055 | 760 | 760 | 760 | 1430 | 293 | 550 | 814 | 794 | 802 | 799 | 799 | 799 |
| 2056 | 789 | 789 | 789 | 1435 | 302 | 602 | 814 | 803 | 804 | 803 | 803 | 803 |
| 2057 | 808 | 808 | 808 | 1443 | 306 | 653 | 814 | 805 | 811 | 809 | 809 | 809 |
| 2058 | 808 | 808 | 808 | 1444 | 310 | 697 | 814 | 811 | 811 | 809 | 809 | 809 |
| 2059 | 808 | 808 | 808 | 1448 | 311 | 733 | 814 | 813 | 811 | 809 | 809 | 809 |
| 2060 | 808 | 808 | 808 | 1448 | 311 | 766 | 814 | 813 | 811 | 809 | 809 | 809 |
| 2061 | 808 | 808 | 808 | 1448 | 311 | 790 | 814 | 813 | 811 | 809 | 809 | 809 |
| 2062 | 808 | 808 | 808 | 1448 | 311 | 806 | 814 | 813 | 811 | 809 | 809 | 809 |
| 2063 | 808 | 808 | 808 | 1448 | 311 | 809 | 814 | 813 | 811 | 809 | 809 | 809 |
| 2064 | 808 | 808 | 808 | 1448 | 311 | 810 | 814 | 813 | 811 | 809 | 809 | 809 |
| 2065 | 808 | 808 | 808 | 1448 | 311 | 812 | 814 | 813 | 811 | 809 | 809 | 809 |
| 2066 | 808 | 808 | 808 | 1448 | 311 | 814 | 814 | 813 | 811 | 809 | 809 | 809 |
| 2067 | 808 | 808 | 808 | 1448 | 311 | 814 | 814 | 813 | 811 | 809 | 809 | 809 |
| 2068 | 808 | 808 | 808 | 1448 | 311 | 814 | 814 | 813 | 811 | 809 | 809 | 809 |

|      | 25  | 26  | 27  | 28   | 29  | 30  | 31  | 32  | 33  | 34  | 35  | 36  |
|------|-----|-----|-----|------|-----|-----|-----|-----|-----|-----|-----|-----|
| 2069 | 808 | 808 | 808 | 1448 | 311 | 814 | 814 | 813 | 811 | 809 | 809 | 809 |
| 2070 | 808 | 808 | 808 | 1448 | 311 | 814 | 814 | 813 | 811 | 809 | 809 | 809 |
| 2071 | 808 | 808 | 808 | 1448 | 311 | 814 | 814 | 813 | 811 | 809 | 809 | 809 |
| 2072 | 808 | 808 | 808 | 1448 | 311 | 814 | 814 | 813 | 811 | 809 | 809 | 809 |
| 2073 | 808 | 808 | 808 | 1448 | 311 | 814 | 814 | 813 | 811 | 809 | 809 | 809 |
| 2074 | 808 | 808 | 808 | 1448 | 311 | 814 | 814 | 813 | 811 | 809 | 809 | 809 |
| 2075 | 808 | 808 | 808 | 1448 | 311 | 814 | 814 | 813 | 811 | 809 | 809 | 809 |
| 2076 | 808 | 808 | 808 | 1448 | 311 | 814 | 814 | 813 | 811 | 809 | 809 | 809 |
| 2077 | 808 | 808 | 808 | 1448 | 311 | 814 | 814 | 813 | 811 | 809 | 809 | 809 |
| 2078 | 808 | 808 | 808 | 1448 | 311 | 814 | 814 | 813 | 811 | 809 | 809 | 809 |
| 2079 | 808 | 808 | 808 | 1448 | 311 | 814 | 814 | 813 | 811 | 809 | 809 | 809 |
| 2080 | 808 | 808 | 808 | 1448 | 311 | 814 | 814 | 813 | 811 | 809 | 809 | 809 |
| 2081 | 808 | 808 | 808 | 1448 | 311 | 814 | 814 | 813 | 811 | 809 | 809 | 809 |
| 2082 | 808 | 808 | 808 | 1448 | 311 | 814 | 814 | 813 | 811 | 809 | 809 | 809 |
| 2083 | 808 | 808 | 808 | 1448 | 311 | 814 | 814 | 813 | 811 | 809 | 809 | 809 |
| 2084 | 808 | 808 | 808 | 1448 | 311 | 814 | 814 | 813 | 811 | 809 | 809 | 809 |
| 2085 | 808 | 808 | 808 | 1448 | 311 | 814 | 814 | 813 | 811 | 809 | 809 | 809 |
| 2086 | 808 | 808 | 808 | 1448 | 311 | 814 | 814 | 813 | 811 | 809 | 809 | 809 |
| 2087 | 808 | 808 | 808 | 1448 | 311 | 814 | 814 | 813 | 811 | 809 | 809 | 809 |
| 2088 | 808 | 808 | 808 | 1448 | 311 | 814 | 814 | 813 | 811 | 809 | 809 | 809 |
| 2089 | 808 | 808 | 808 | 1448 | 311 | 814 | 814 | 813 | 811 | 809 | 809 | 809 |
| 2090 | 808 | 808 | 808 | 1448 | 311 | 814 | 814 | 813 | 811 | 809 | 809 | 809 |

|      | 37   | 38  | 39  | 40  | 41  | 42  | 43  | 44  | 45  | 46   | 47  | 48  |
|------|------|-----|-----|-----|-----|-----|-----|-----|-----|------|-----|-----|
| 2002 | 0    | 0   | 0   | 0   | 0   | 0   | 0   | 0   | 0   | 0    | 0   | 0   |
| 2003 | 0    | 0   | 0   | 0   | 0   | 0   | 0   | 0   | 0   | 0    | 0   | 0   |
| 2004 | 0    | 0   | 0   | 0   | 0   | 0   | 0   | 0   | 0   | 0    | 0   | 0   |
| 2005 | 0    | 0   | 0   | 0   | 0   | 0   | 0   | 0   | 0   | 0    | 0   | 0   |
| 2006 | 0    | 0   | 0   | 0   | 0   | 0   | 0   | 0   | 0   | 0    | 0   | 0   |
| 2007 | 0    | 0   | 0   | 0   | 0   | 0   | 0   | 0   | 0   | 0    | 0   | 0   |
| 2008 | 0    | 0   | 0   | 0   | 0   | 0   | 0   | 0   | 0   | 0    | 0   | 0   |
| 2009 | 0    | 0   | 0   | 0   | 0   | 0   | 0   | 0   | 0   | 0    | 0   | 0   |
| 2010 | 0    | 0   | 0   | 0   | 0   | 0   | 0   | 0   | 0   | 0    | 0   | 0   |
| 2011 | 0    | 0   | 0   | 0   | 0   | 0   | 0   | 0   | 0   | 0    | 0   | 0   |
| 2012 | 0    | 0   | 0   | 0   | 0   | 0   | 0   | 0   | 0   | 0    | 0   | 0   |
| 2013 | 0    | 0   | 0   | 0   | 0   | 0   | 0   | 0   | 0   | 0    | 0   | 0   |
| 2014 | 0    | 0   | 0   | 0   | 0   | 0   | 0   | 0   | 0   | 0    | 0   | 0   |
| 2015 | 0    | 0   | 0   | 0   | 0   | 0   | 0   | 0   | 0   | 0    | 0   | 0   |
| 2016 | 0    | 0   | 0   | 0   | 0   | 0   | 0   | 0   | 0   | 0    | 0   | 0   |
| 2017 | 0    | 0   | 0   | 0   | 0   | 0   | 0   | 0   | 0   | 0    | 0   | 0   |
| 2018 | 0    | 0   | 0   | 0   | 0   | 0   | 0   | 0   | 0   | 0    | 0   | 0   |
| 2019 | 0    | 0   | 0   | 0   | 0   | 0   | 0   | 0   | 0   | 0    | 0   | 0   |
| 2020 | 0    | 0   | 0   | 0   | 0   | 0   | 0   | 0   | 0   | 0    | 0   | 0   |
| 2021 | 0    | 0   | 0   | 5   | 0   | 0   | 0   | 0   | 0   | 0    | 0   | 0   |
| 2022 | 0    | 0   | 0   | 5   | 0   | 0   | 0   | 0   | 0   | 0    | 0   | 0   |
| 2023 | 0    | 0   | 0   | 16  | 0   | 0   | 0   | 0   | 0   | 0    | 0   | 0   |
| 2024 | 0    | 0   | 0   | 28  | 0   | 0   | 0   | 0   | 0   | 0    | 0   | 0   |
| 2025 | 0    | 0   | 0   | 41  | 0   | 0   | 0   | 0   | 0   | 0    | 0   | 0   |
| 2026 | 7    | 4   | 0   | 62  | 4   | 23  | 7   | 1   | 7   | 7    | 6   | 0   |
| 2027 | 16   | 6   | 0   | 78  | 13  | 44  | 13  | 6   | 13  | 13   | 9   | 0   |
| 2028 | 25   | 15  | 0   | 103 | 18  | 60  | 22  | 15  | 22  | 19   | 13  | 0   |
| 2029 | 47   | 32  | 0   | 124 | 34  | 84  | 42  | 37  | 42  | 24   | 17  | 0   |
| 2030 | 60   | 39  | 0   | 164 | 52  | 99  | 57  | 52  | 57  | 39   | 29  | 0   |
| 2031 | 77   | 51  | 2   | 209 | 68  | 117 | 73  | 68  | 73  | 54   | 36  | 5   |
| 2032 | 121  | 68  | 16  | 240 | 89  | 125 | 107 | 103 | 107 | 76   | 39  | 10  |
| 2033 | 157  | 84  | 29  | 271 | 104 | 149 | 132 | 130 | 132 | 99   | 44  | 22  |
| 2034 | 197  | 102 | 42  | 303 | 123 | 164 | 157 | 155 | 157 | 120  | 50  | 29  |
| 2035 | 225  | 120 | 62  | 318 | 139 | 185 | 182 | 182 | 182 | 148  | 59  | 44  |
| 2036 | 276  | 145 | 91  | 335 | 172 | 227 | 223 | 223 | 223 | 178  | 83  | 56  |
| 2037 | 310  | 151 | 126 | 346 | 202 | 258 | 248 | 248 | 248 | 207  | 92  | 83  |
| 2038 | 328  | 151 | 159 | 368 | 214 | 279 | 264 | 264 | 264 | 256  | 106 | 103 |
| 2039 | 361  | 151 | 187 | 375 | 227 | 307 | 279 | 279 | 279 | 309  | 119 | 128 |
| 2040 | 390  | 151 | 201 | 375 | 232 | 331 | 298 | 298 | 298 | 338  | 132 | 149 |
| 2041 | 421  | 153 | 233 | 375 | 254 | 341 | 316 | 316 | 316 | 367  | 151 | 172 |
| 2042 | 459  | 154 | 260 | 388 | 288 | 352 | 328 | 328 | 328 | 391  | 153 | 182 |
| 2043 | 496  | 158 | 278 | 409 | 310 | 356 | 338 | 338 | 338 | 427  | 153 | 203 |
| 2044 | 538  | 158 | 283 | 422 | 328 | 357 | 352 | 352 | 352 | 474  | 154 | 227 |
| 2045 | 564  | 161 | 283 | 429 | 337 | 362 | 361 | 361 | 361 | 496  | 154 | 239 |
| 2046 | 581  | 164 | 286 | 434 | 346 | 375 | 368 | 368 | 368 | 522  | 158 | 243 |
| 2047 | 596  | 165 | 296 | 445 | 355 | 391 | 377 | 377 | 377 | 594  | 163 | 244 |
| 2048 | 612  | 171 | 314 | 451 | 368 | 415 | 389 | 389 | 389 | 710  | 174 | 267 |
| 2049 | 639  | 173 | 346 | 564 | 417 | 476 | 405 | 405 | 405 | 822  | 190 | 299 |
| 2050 | 773  | 185 | 377 | 678 | 465 | 539 | 459 | 459 | 459 | 937  | 205 | 341 |
| 2051 | 886  | 200 | 411 | 748 | 523 | 614 | 522 | 522 | 522 | 1065 | 224 | 382 |
| 2052 | 1014 | 218 | 446 | 775 | 591 | 680 | 590 | 590 | 590 | 1208 | 247 | 416 |
| 2053 | 1141 | 239 | 486 | 794 | 663 | 737 | 655 | 655 | 655 | 1309 | 270 | 457 |
| 2054 | 1268 | 262 | 534 | 806 | 728 | 771 | 721 | 721 | 721 | 1372 | 286 | 506 |
| 2055 | 1347 | 281 | 586 | 813 | 766 | 791 | 762 | 762 | 762 | 1409 | 298 | 553 |
| 2056 | 1395 | 295 | 647 | 813 | 787 | 805 | 788 | 788 | 788 | 1432 | 303 | 611 |
| 2057 | 1424 | 303 | 697 | 813 | 802 | 810 | 805 | 805 | 805 | 1443 | 311 | 666 |
| 2058 | 1438 | 311 | 731 | 813 | 810 | 814 | 810 | 810 | 810 | 1443 | 313 | 713 |
| 2059 | 1445 | 313 | 752 | 813 | 810 | 814 | 810 | 810 | 810 | 1443 | 313 | 744 |
| 2060 | 1445 | 313 | 768 | 813 | 813 | 814 | 810 | 810 | 810 | 1443 | 313 | 764 |
| 2061 | 1448 | 313 | 781 | 813 | 813 | 814 | 810 | 810 | 810 | 1443 | 313 | 779 |
| 2062 | 1448 | 313 | 793 | 813 | 813 | 814 | 810 | 810 | 810 | 1443 | 313 | 790 |
| 2063 | 1448 | 313 | 806 | 813 | 813 | 814 | 810 | 810 | 810 | 1443 | 313 | 803 |
| 2064 | 1448 | 313 | 811 | 813 | 813 | 814 | 810 | 810 | 810 | 1443 | 313 | 810 |
| 2065 | 1448 | 313 | 811 | 813 | 813 | 814 | 810 | 810 | 810 | 1443 | 313 | 812 |
| 2066 | 1448 | 313 | 811 | 813 | 813 | 814 | 810 | 810 | 810 | 1443 | 313 | 812 |
| 2067 | 1448 | 313 | 811 | 813 | 813 | 814 | 810 | 810 | 810 | 1443 | 313 | 814 |
| 2068 | 1448 | 313 | 811 | 813 | 813 | 814 | 810 | 810 | 810 | 1443 | 313 | 814 |

|      | 37   | 38  | 39  | 40  | 41  | 42  | 43  | 44  | 45  | 46   | 47  | 48  |
|------|------|-----|-----|-----|-----|-----|-----|-----|-----|------|-----|-----|
| 2069 | 1448 | 313 | 811 | 813 | 813 | 814 | 810 | 810 | 810 | 1443 | 313 | 814 |
| 2070 | 1448 | 313 | 811 | 813 | 813 | 814 | 810 | 810 | 810 | 1443 | 313 | 814 |
| 2071 | 1448 | 313 | 811 | 813 | 813 | 814 | 810 | 810 | 810 | 1443 | 313 | 814 |
| 2072 | 1448 | 313 | 811 | 813 | 813 | 814 | 810 | 810 | 810 | 1443 | 313 | 814 |
| 2073 | 1448 | 313 | 811 | 813 | 813 | 814 | 810 | 810 | 810 | 1443 | 313 | 814 |
| 2074 | 1448 | 313 | 811 | 813 | 813 | 814 | 810 | 810 | 810 | 1443 | 313 | 814 |
| 2075 | 1448 | 313 | 811 | 813 | 813 | 814 | 810 | 810 | 810 | 1443 | 313 | 814 |
| 2076 | 1448 | 313 | 811 | 813 | 813 | 814 | 810 | 810 | 810 | 1443 | 313 | 814 |
| 2077 | 1448 | 313 | 811 | 813 | 813 | 814 | 810 | 810 | 810 | 1443 | 313 | 814 |
| 2078 | 1448 | 313 | 811 | 813 | 813 | 814 | 810 | 810 | 810 | 1443 | 313 | 814 |
| 2079 | 1448 | 313 | 811 | 813 | 813 | 814 | 810 | 810 | 810 | 1443 | 313 | 814 |
| 2080 | 1448 | 313 | 811 | 813 | 813 | 814 | 810 | 810 | 810 | 1443 | 313 | 814 |
| 2081 | 1448 | 313 | 811 | 813 | 813 | 814 | 810 | 810 | 810 | 1443 | 313 | 814 |
| 2082 | 1448 | 313 | 811 | 813 | 813 | 814 | 810 | 810 | 810 | 1443 | 313 | 814 |
| 2083 | 1448 | 313 | 811 | 813 | 813 | 814 | 810 | 810 | 810 | 1443 | 313 | 814 |
| 2084 | 1448 | 313 | 811 | 813 | 813 | 814 | 810 | 810 | 810 | 1443 | 313 | 814 |
| 2085 | 1448 | 313 | 811 | 813 | 813 | 814 | 810 | 810 | 810 | 1443 | 313 | 814 |
| 2086 | 1448 | 313 | 811 | 813 | 813 | 814 | 810 | 810 | 810 | 1443 | 313 | 814 |
| 2087 | 1448 | 313 | 811 | 813 | 813 | 814 | 810 | 810 | 810 | 1443 | 313 | 814 |
| 2088 | 1448 | 313 | 811 | 813 | 813 | 814 | 810 | 810 | 810 | 1443 | 313 | 814 |
| 2089 | 1448 | 313 | 811 | 813 | 813 | 814 | 810 | 810 | 810 | 1443 | 313 | 814 |
| 2090 | 1448 | 313 | 811 | 813 | 813 | 814 | 810 | 810 | 810 | 1443 | 313 | 814 |



|      | 49  | 50  | 51  | 52  | 53  | 54  | 55   | 56  | 57  | 58  | 59  | 60  |
|------|-----|-----|-----|-----|-----|-----|------|-----|-----|-----|-----|-----|
| 2002 | 0   | 0   | 0   | 0   | 0   | 0   | 0    | 0   | 0   | 0   | 0   | 0   |
| 2003 | 0   | 0   | 0   | 0   | 0   | 0   | 0    | 0   | 0   | 0   | 0   | 0   |
| 2004 | 0   | 0   | 0   | 0   | 0   | 0   | 0    | 0   | 0   | 0   | 0   | 0   |
| 2005 | 0   | 0   | 0   | 0   | 0   | 0   | 0    | 0   | 0   | 0   | 0   | 0   |
| 2006 | 0   | 0   | 0   | 0   | 0   | 0   | 0    | 0   | 0   | 0   | 0   | 0   |
| 2007 | 0   | 0   | 0   | 0   | 0   | 0   | 0    | 0   | 0   | 0   | 0   | 0   |
| 2008 | 0   | 0   | 0   | 0   | 0   | 0   | 0    | 0   | 0   | 0   | 0   | 0   |
| 2009 | 0   | 0   | 0   | 0   | 0   | 0   | 0    | 0   | 0   | 0   | 0   | 0   |
| 2010 | 0   | 0   | 0   | 0   | 0   | 0   | 0    | 0   | 0   | 0   | 0   | 0   |
| 2011 | 0   | 0   | 0   | 0   | 0   | 0   | 0    | 0   | 0   | 0   | 0   | 0   |
| 2012 | 0   | 0   | 0   | 0   | 0   | 0   | 0    | 0   | 0   | 0   | 0   | 0   |
| 2013 | 0   | 0   | 0   | 0   | 0   | 0   | 0    | 0   | 0   | 0   | 0   | 0   |
| 2014 | 0   | 0   | 0   | 0   | 0   | 0   | 0    | 0   | 0   | 0   | 0   | 0   |
| 2015 | 0   | 0   | 0   | 0   | 0   | 0   | 0    | 0   | 0   | 0   | 0   | 0   |
| 2016 | 0   | 0   | 0   | 0   | 0   | 0   | 0    | 0   | 0   | 0   | 0   | 0   |
| 2017 | 0   | 0   | 0   | 0   | 0   | 0   | 0    | 0   | 0   | 0   | 0   | 0   |
| 2018 | 0   | 0   | 0   | 0   | 0   | 0   | 0    | 0   | 0   | 0   | 0   | 0   |
| 2019 | 0   | 0   | 0   | 0   | 0   | 0   | 0    | 0   | 0   | 0   | 0   | 0   |
| 2020 | 0   | 0   | 0   | 0   | 0   | 0   | 0    | 0   | 0   | 0   | 0   | 0   |
| 2021 | 3   | 0   | 0   | 0   | 0   | 0   | 0    | 0   | 0   | 30  | 0   | 0   |
| 2022 | 4   | 0   | 0   | 0   | 0   | 0   | 0    | 0   | 0   | 84  | 0   | 0   |
| 2023 | 10  | 0   | 0   | 0   | 0   | 0   | 0    | 0   | 0   | 117 | 0   | 0   |
| 2024 | 17  | 0   | 0   | 0   | 0   | 0   | 0    | 0   | 0   | 165 | 0   | 0   |
| 2025 | 24  | 0   | 0   | 0   | 0   | 0   | 0    | 0   | 0   | 185 | 0   | 0   |
| 2026 | 43  | 4   | 14  | 7   | 2   | 7   | 21   | 0   | 0   | 210 | 0   | 0   |
| 2027 | 60  | 6   | 24  | 15  | 5   | 13  | 63   | 0   | 0   | 248 | 10  | 10  |
| 2028 | 78  | 11  | 43  | 19  | 9   | 19  | 124  | 6   | 0   | 305 | 13  | 13  |
| 2029 | 85  | 18  | 64  | 24  | 14  | 24  | 203  | 6   | 0   | 322 | 48  | 48  |
| 2030 | 93  | 26  | 86  | 39  | 29  | 39  | 284  | 18  | 0   | 342 | 90  | 90  |
| 2031 | 114 | 29  | 106 | 50  | 40  | 50  | 343  | 18  | 0   | 358 | 114 | 114 |
| 2032 | 129 | 49  | 124 | 61  | 49  | 61  | 418  | 37  | 0   | 369 | 162 | 162 |
| 2033 | 177 | 64  | 140 | 80  | 66  | 80  | 496  | 53  | 10  | 379 | 218 | 218 |
| 2034 | 199 | 81  | 155 | 90  | 80  | 90  | 545  | 83  | 23  | 399 | 256 | 256 |
| 2035 | 228 | 100 | 177 | 104 | 96  | 104 | 580  | 84  | 30  | 409 | 277 | 277 |
| 2036 | 255 | 114 | 225 | 133 | 126 | 133 | 598  | 93  | 40  | 439 | 298 | 309 |
| 2037 | 274 | 136 | 250 | 157 | 150 | 157 | 623  | 93  | 90  | 444 | 308 | 319 |
| 2038 | 301 | 157 | 273 | 195 | 192 | 195 | 639  | 103 | 151 | 444 | 319 | 331 |
| 2039 | 327 | 186 | 291 | 223 | 221 | 223 | 669  | 113 | 197 | 473 | 341 | 345 |
| 2040 | 360 | 195 | 317 | 240 | 240 | 240 | 696  | 115 | 238 | 475 | 351 | 351 |
| 2041 | 370 | 217 | 327 | 261 | 261 | 261 | 712  | 117 | 267 | 485 | 351 | 351 |
| 2042 | 375 | 235 | 334 | 281 | 281 | 281 | 726  | 117 | 277 | 492 | 351 | 361 |
| 2043 | 375 | 252 | 348 | 302 | 302 | 302 | 729  | 117 | 289 | 511 | 351 | 361 |
| 2044 | 377 | 268 | 351 | 322 | 322 | 322 | 749  | 117 | 299 | 567 | 351 | 361 |
| 2045 | 434 | 273 | 366 | 328 | 328 | 328 | 774  | 117 | 319 | 661 | 361 | 361 |
| 2046 | 542 | 293 | 376 | 339 | 339 | 339 | 870  | 121 | 340 | 741 | 409 | 408 |
| 2047 | 651 | 327 | 399 | 363 | 363 | 363 | 1018 | 130 | 347 | 808 | 478 | 480 |
| 2048 | 731 | 384 | 454 | 414 | 414 | 414 | 1177 | 156 | 351 | 808 | 528 | 540 |
| 2049 | 775 | 434 | 519 | 469 | 469 | 469 | 1290 | 166 | 361 | 814 | 608 | 620 |
| 2050 | 795 | 478 | 586 | 524 | 524 | 524 | 1372 | 212 | 371 | 814 | 698 | 708 |
| 2051 | 807 | 544 | 654 | 592 | 592 | 592 | 1420 | 281 | 469 | 814 | 775 | 785 |
| 2052 | 807 | 610 | 719 | 663 | 663 | 663 | 1441 | 294 | 486 | 814 | 797 | 797 |
| 2053 | 813 | 677 | 759 | 723 | 723 | 723 | 1444 | 300 | 506 | 814 | 799 | 806 |
| 2054 | 813 | 725 | 785 | 766 | 766 | 766 | 1444 | 307 | 527 | 814 | 811 | 807 |
| 2055 | 813 | 760 | 800 | 787 | 787 | 787 | 1444 | 309 | 590 | 814 | 811 | 813 |
| 2056 | 813 | 785 | 806 | 802 | 802 | 802 | 1444 | 313 | 661 | 814 | 811 | 813 |
| 2057 | 813 | 800 | 812 | 809 | 809 | 809 | 1444 | 313 | 735 | 814 | 811 | 813 |
| 2058 | 813 | 810 | 812 | 809 | 809 | 809 | 1444 | 313 | 787 | 814 | 811 | 813 |
| 2059 | 813 | 810 | 813 | 813 | 813 | 813 | 1444 | 313 | 800 | 814 | 811 | 813 |
| 2060 | 813 | 810 | 813 | 813 | 813 | 813 | 1444 | 313 | 803 | 814 | 811 | 813 |
| 2061 | 813 | 810 | 813 | 813 | 813 | 813 | 1444 | 313 | 812 | 814 | 811 | 813 |
| 2062 | 813 | 810 | 813 | 813 | 813 | 813 | 1444 | 313 | 812 | 814 | 811 | 813 |
| 2063 | 813 | 810 | 813 | 813 | 813 | 813 | 1444 | 313 | 812 | 814 | 811 | 813 |
| 2064 | 813 | 810 | 813 | 813 | 813 | 813 | 1444 | 313 | 812 | 814 | 811 | 813 |
| 2065 | 813 | 810 | 813 | 813 | 813 | 813 | 1444 | 313 | 812 | 814 | 811 | 813 |
| 2066 | 813 | 810 | 813 | 813 | 813 | 813 | 1444 | 313 | 812 | 814 | 811 | 813 |
| 2067 | 813 | 810 | 813 | 813 | 813 | 813 | 1444 | 313 | 812 | 814 | 811 | 813 |
| 2068 | 813 | 810 | 813 | 813 | 813 | 813 | 1444 | 313 | 812 | 814 | 811 | 813 |

|      | 49  | 50  | 51  | 52  | 53  | 54  | 55   | 56  | 57  | 58  | 59  | 60  |
|------|-----|-----|-----|-----|-----|-----|------|-----|-----|-----|-----|-----|
| 2069 | 813 | 810 | 813 | 813 | 813 | 813 | 1444 | 313 | 812 | 814 | 811 | 813 |
| 2070 | 813 | 810 | 813 | 813 | 813 | 813 | 1444 | 313 | 812 | 814 | 811 | 813 |
| 2071 | 813 | 810 | 813 | 813 | 813 | 813 | 1444 | 313 | 812 | 814 | 811 | 813 |
| 2072 | 813 | 810 | 813 | 813 | 813 | 813 | 1444 | 313 | 812 | 814 | 811 | 813 |
| 2073 | 813 | 810 | 813 | 813 | 813 | 813 | 1444 | 313 | 812 | 814 | 811 | 813 |
| 2074 | 813 | 810 | 813 | 813 | 813 | 813 | 1444 | 313 | 812 | 814 | 811 | 813 |
| 2075 | 813 | 810 | 813 | 813 | 813 | 813 | 1444 | 313 | 812 | 814 | 811 | 813 |
| 2076 | 813 | 810 | 813 | 813 | 813 | 813 | 1444 | 313 | 812 | 814 | 811 | 813 |
| 2077 | 813 | 810 | 813 | 813 | 813 | 813 | 1444 | 313 | 812 | 814 | 811 | 813 |
| 2078 | 813 | 810 | 813 | 813 | 813 | 813 | 1444 | 313 | 812 | 814 | 811 | 813 |
| 2079 | 813 | 810 | 813 | 813 | 813 | 813 | 1444 | 313 | 812 | 814 | 811 | 813 |
| 2080 | 813 | 810 | 813 | 813 | 813 | 813 | 1444 | 313 | 812 | 814 | 811 | 813 |
| 2081 | 813 | 810 | 813 | 813 | 813 | 813 | 1444 | 313 | 812 | 814 | 811 | 813 |
| 2082 | 813 | 810 | 813 | 813 | 813 | 813 | 1444 | 313 | 812 | 814 | 811 | 813 |
| 2083 | 813 | 810 | 813 | 813 | 813 | 813 | 1444 | 313 | 812 | 814 | 811 | 813 |
| 2084 | 813 | 810 | 813 | 813 | 813 | 813 | 1444 | 313 | 812 | 814 | 811 | 813 |
| 2085 | 813 | 810 | 813 | 813 | 813 | 813 | 1444 | 313 | 812 | 814 | 811 | 813 |
| 2086 | 813 | 810 | 813 | 813 | 813 | 813 | 1444 | 313 | 812 | 814 | 811 | 813 |
| 2087 | 813 | 810 | 813 | 813 | 813 | 813 | 1444 | 313 | 812 | 814 | 811 | 813 |
| 2088 | 813 | 810 | 813 | 813 | 813 | 813 | 1444 | 313 | 812 | 814 | 811 | 813 |
| 2089 | 813 | 810 | 813 | 813 | 813 | 813 | 1444 | 313 | 812 | 814 | 811 | 813 |
| 2090 | 813 | 810 | 813 | 813 | 813 | 813 | 1444 | 313 | 812 | 814 | 811 | 813 |

|      | 61  | 62  | 63  | 64   | 65  | 66  | 67  | 68  | 69  | 70  | 71  | 72  |
|------|-----|-----|-----|------|-----|-----|-----|-----|-----|-----|-----|-----|
| 2002 | 0   | 0   | 0   | 0    | 0   | 0   | 0   | 0   | 0   | 0   | 0   | 0   |
| 2003 | 0   | 0   | 0   | 0    | 0   | 0   | 0   | 0   | 0   | 0   | 0   | 0   |
| 2004 | 0   | 0   | 0   | 0    | 0   | 0   | 0   | 0   | 0   | 0   | 0   | 0   |
| 2005 | 0   | 0   | 0   | 0    | 0   | 0   | 0   | 0   | 0   | 0   | 0   | 0   |
| 2006 | 0   | 0   | 0   | 0    | 0   | 0   | 0   | 0   | 0   | 0   | 0   | 0   |
| 2007 | 0   | 0   | 0   | 0    | 0   | 0   | 0   | 0   | 0   | 0   | 0   | 0   |
| 2008 | 0   | 0   | 0   | 0    | 0   | 0   | 0   | 0   | 0   | 0   | 0   | 0   |
| 2009 | 0   | 0   | 0   | 0    | 0   | 0   | 0   | 0   | 0   | 0   | 0   | 0   |
| 2010 | 0   | 0   | 0   | 0    | 0   | 0   | 0   | 0   | 0   | 0   | 0   | 0   |
| 2011 | 0   | 0   | 0   | 0    | 0   | 0   | 0   | 0   | 0   | 0   | 0   | 0   |
| 2012 | 0   | 0   | 0   | 0    | 0   | 0   | 0   | 0   | 0   | 0   | 0   | 0   |
| 2013 | 0   | 0   | 0   | 0    | 0   | 0   | 0   | 0   | 0   | 0   | 0   | 0   |
| 2014 | 0   | 0   | 0   | 0    | 0   | 0   | 0   | 0   | 0   | 0   | 0   | 0   |
| 2015 | 0   | 0   | 0   | 0    | 0   | 0   | 0   | 0   | 0   | 0   | 0   | 0   |
| 2016 | 0   | 0   | 0   | 0    | 0   | 0   | 0   | 0   | 0   | 0   | 0   | 0   |
| 2017 | 0   | 0   | 0   | 0    | 0   | 0   | 0   | 0   | 0   | 0   | 0   | 0   |
| 2018 | 0   | 0   | 0   | 0    | 0   | 0   | 0   | 0   | 0   | 0   | 0   | 0   |
| 2019 | 0   | 0   | 0   | 0    | 0   | 0   | 0   | 0   | 0   | 0   | 0   | 0   |
| 2020 | 0   | 0   | 0   | 0    | 0   | 0   | 0   | 0   | 0   | 0   | 0   | 0   |
| 2021 | 0   | 0   | 0   | 0    | 0   | 0   | 85  | 0   | 0   | 0   | 0   | 0   |
| 2022 | 0   | 0   | 0   | 0    | 0   | 0   | 157 | 0   | 0   | 0   | 0   | 0   |
| 2023 | 0   | 0   | 0   | 0    | 0   | 0   | 213 | 0   | 0   | 0   | 0   | 0   |
| 2024 | 0   | 0   | 0   | 0    | 0   | 0   | 259 | 0   | 0   | 0   | 0   | 0   |
| 2025 | 0   | 0   | 0   | 0    | 0   | 0   | 275 | 0   | 0   | 0   | 0   | 0   |
| 2026 | 0   | 0   | 0   | 54   | 0   | 0   | 295 | 1   | 1   | 1   | 0   | 1   |
| 2027 | 10  | 10  | 10  | 139  | 0   | 0   | 321 | 31  | 31  | 31  | 23  | 31  |
| 2028 | 13  | 13  | 13  | 247  | 0   | 0   | 331 | 70  | 70  | 70  | 61  | 70  |
| 2029 | 48  | 48  | 48  | 336  | 30  | 0   | 358 | 139 | 148 | 139 | 123 | 139 |
| 2030 | 90  | 90  | 90  | 402  | 50  | 0   | 382 | 196 | 197 | 196 | 184 | 196 |
| 2031 | 114 | 114 | 114 | 459  | 71  | 0   | 384 | 219 | 220 | 219 | 211 | 219 |
| 2032 | 162 | 162 | 162 | 499  | 77  | 0   | 407 | 232 | 242 | 242 | 235 | 242 |
| 2033 | 218 | 218 | 218 | 552  | 85  | 10  | 418 | 266 | 286 | 283 | 278 | 283 |
| 2034 | 256 | 256 | 256 | 582  | 99  | 33  | 448 | 292 | 318 | 315 | 310 | 315 |
| 2035 | 277 | 277 | 277 | 599  | 109 | 114 | 461 | 312 | 328 | 325 | 325 | 325 |
| 2036 | 298 | 298 | 298 | 630  | 129 | 165 | 468 | 350 | 360 | 357 | 357 | 357 |
| 2037 | 308 | 308 | 308 | 654  | 148 | 206 | 468 | 370 | 372 | 372 | 372 | 372 |
| 2038 | 319 | 319 | 319 | 677  | 160 | 233 | 468 | 380 | 382 | 382 | 382 | 382 |
| 2039 | 341 | 341 | 341 | 694  | 163 | 262 | 478 | 386 | 396 | 386 | 386 | 386 |
| 2040 | 351 | 351 | 351 | 704  | 163 | 274 | 478 | 396 | 407 | 396 | 396 | 396 |
| 2041 | 351 | 351 | 351 | 724  | 173 | 296 | 478 | 416 | 417 | 416 | 416 | 416 |
| 2042 | 361 | 361 | 361 | 745  | 181 | 316 | 488 | 427 | 437 | 427 | 427 | 427 |
| 2043 | 361 | 361 | 361 | 765  | 181 | 366 | 498 | 429 | 459 | 429 | 429 | 429 |
| 2044 | 371 | 371 | 371 | 785  | 185 | 390 | 510 | 449 | 468 | 449 | 449 | 449 |
| 2045 | 381 | 381 | 381 | 795  | 195 | 410 | 514 | 456 | 468 | 461 | 461 | 461 |
| 2046 | 420 | 420 | 420 | 797  | 196 | 412 | 619 | 456 | 468 | 468 | 468 | 468 |
| 2047 | 479 | 479 | 479 | 797  | 196 | 412 | 706 | 464 | 468 | 468 | 468 | 468 |
| 2048 | 548 | 548 | 548 | 805  | 196 | 422 | 750 | 464 | 478 | 468 | 468 | 468 |
| 2049 | 640 | 640 | 640 | 848  | 196 | 431 | 779 | 468 | 560 | 468 | 468 | 468 |
| 2050 | 728 | 728 | 728 | 997  | 196 | 431 | 798 | 495 | 653 | 505 | 505 | 505 |
| 2051 | 785 | 785 | 785 | 1190 | 208 | 441 | 808 | 609 | 683 | 613 | 613 | 613 |
| 2052 | 807 | 807 | 807 | 1313 | 242 | 451 | 814 | 664 | 723 | 674 | 674 | 674 |
| 2053 | 809 | 809 | 809 | 1365 | 262 | 517 | 814 | 710 | 760 | 713 | 713 | 713 |
| 2054 | 812 | 812 | 812 | 1401 | 272 | 587 | 814 | 750 | 789 | 750 | 750 | 750 |
| 2055 | 812 | 812 | 812 | 1428 | 291 | 646 | 814 | 779 | 808 | 779 | 779 | 779 |
| 2056 | 814 | 814 | 814 | 1439 | 302 | 708 | 814 | 798 | 814 | 798 | 798 | 798 |
| 2057 | 814 | 814 | 814 | 1448 | 312 | 740 | 814 | 808 | 814 | 808 | 808 | 808 |
| 2058 | 814 | 814 | 814 | 1448 | 312 | 769 | 814 | 813 | 814 | 813 | 813 | 813 |
| 2059 | 814 | 814 | 814 | 1448 | 312 | 788 | 814 | 813 | 814 | 813 | 813 | 813 |
| 2060 | 814 | 814 | 814 | 1448 | 312 | 798 | 814 | 813 | 814 | 813 | 813 | 813 |
| 2061 | 814 | 814 | 814 | 1448 | 312 | 808 | 814 | 813 | 814 | 813 | 813 | 813 |
| 2062 | 814 | 814 | 814 | 1448 | 312 | 813 | 814 | 813 | 814 | 813 | 813 | 813 |
| 2063 | 814 | 814 | 814 | 1448 | 312 | 813 | 814 | 813 | 814 | 813 | 813 | 813 |
| 2064 | 814 | 814 | 814 | 1448 | 312 | 813 | 814 | 813 | 814 | 813 | 813 | 813 |
| 2065 | 814 | 814 | 814 | 1448 | 312 | 813 | 814 | 813 | 814 | 813 | 813 | 813 |
| 2066 | 814 | 814 | 814 | 1448 | 312 | 813 | 814 | 813 | 814 | 813 | 813 | 813 |
| 2067 | 814 | 814 | 814 | 1448 | 312 | 813 | 814 | 813 | 814 | 813 | 813 | 813 |
| 2068 | 814 | 814 | 814 | 1448 | 312 | 813 | 814 | 813 | 814 | 813 | 813 | 813 |

|      | 61  | 62  | 63  | 64   | 65  | 66  | 67  | 68  | 69  | 70  | 71  | 72  |
|------|-----|-----|-----|------|-----|-----|-----|-----|-----|-----|-----|-----|
| 2069 | 814 | 814 | 814 | 1448 | 312 | 813 | 814 | 813 | 814 | 813 | 813 | 813 |
| 2070 | 814 | 814 | 814 | 1448 | 312 | 813 | 814 | 813 | 814 | 813 | 813 | 813 |
| 2071 | 814 | 814 | 814 | 1448 | 312 | 813 | 814 | 813 | 814 | 813 | 813 | 813 |
| 2072 | 814 | 814 | 814 | 1448 | 312 | 813 | 814 | 813 | 814 | 813 | 813 | 813 |
| 2073 | 814 | 814 | 814 | 1448 | 312 | 813 | 814 | 813 | 814 | 813 | 813 | 813 |
| 2074 | 814 | 814 | 814 | 1448 | 312 | 813 | 814 | 813 | 814 | 813 | 813 | 813 |
| 2075 | 814 | 814 | 814 | 1448 | 312 | 813 | 814 | 813 | 814 | 813 | 813 | 813 |
| 2076 | 814 | 814 | 814 | 1448 | 312 | 813 | 814 | 813 | 814 | 813 | 813 | 813 |
| 2077 | 814 | 814 | 814 | 1448 | 312 | 813 | 814 | 813 | 814 | 813 | 813 | 813 |
| 2078 | 814 | 814 | 814 | 1448 | 312 | 813 | 814 | 813 | 814 | 813 | 813 | 813 |
| 2079 | 814 | 814 | 814 | 1448 | 312 | 813 | 814 | 813 | 814 | 813 | 813 | 813 |
| 2080 | 814 | 814 | 814 | 1448 | 312 | 813 | 814 | 813 | 814 | 813 | 813 | 813 |
| 2081 | 814 | 814 | 814 | 1448 | 312 | 813 | 814 | 813 | 814 | 813 | 813 | 813 |
| 2082 | 814 | 814 | 814 | 1448 | 312 | 813 | 814 | 813 | 814 | 813 | 813 | 813 |
| 2083 | 814 | 814 | 814 | 1448 | 312 | 813 | 814 | 813 | 814 | 813 | 813 | 813 |
| 2084 | 814 | 814 | 814 | 1448 | 312 | 813 | 814 | 813 | 814 | 813 | 813 | 813 |
| 2085 | 814 | 814 | 814 | 1448 | 312 | 813 | 814 | 813 | 814 | 813 | 813 | 813 |
| 2086 | 814 | 814 | 814 | 1448 | 312 | 813 | 814 | 813 | 814 | 813 | 813 | 813 |
| 2087 | 814 | 814 | 814 | 1448 | 312 | 813 | 814 | 813 | 814 | 813 | 813 | 813 |
| 2088 | 814 | 814 | 814 | 1448 | 312 | 813 | 814 | 813 | 814 | 813 | 813 | 813 |
| 2089 | 814 | 814 | 814 | 1448 | 312 | 813 | 814 | 813 | 814 | 813 | 813 | 813 |
| 2090 | 814 | 814 | 814 | 1448 | 312 | 813 | 814 | 813 | 814 | 813 | 813 | 813 |

|      | 73   | 74  | 75  | 76  | 77  | 78  | 79  | 80  | 81  | 82   | 83  | 84  |
|------|------|-----|-----|-----|-----|-----|-----|-----|-----|------|-----|-----|
| 2002 | 0    | 0   | 0   | 0   | 0   | 0   | 0   | 0   | 0   | 0    | 0   | 0   |
| 2003 | 0    | 0   | 0   | 0   | 0   | 0   | 0   | 0   | 0   | 0    | 0   | 0   |
| 2004 | 0    | 0   | 0   | 0   | 0   | 0   | 0   | 0   | 0   | 0    | 0   | 0   |
| 2005 | 0    | 0   | 0   | 0   | 0   | 0   | 0   | 0   | 0   | 0    | 0   | 0   |
| 2006 | 0    | 0   | 0   | 0   | 0   | 0   | 0   | 0   | 0   | 0    | 0   | 0   |
| 2007 | 0    | 0   | 0   | 0   | 0   | 0   | 0   | 0   | 0   | 0    | 0   | 0   |
| 2008 | 0    | 0   | 0   | 0   | 0   | 0   | 0   | 0   | 0   | 0    | 0   | 0   |
| 2009 | 0    | 0   | 0   | 0   | 0   | 0   | 0   | 0   | 0   | 0    | 0   | 0   |
| 2010 | 0    | 0   | 0   | 0   | 0   | 0   | 0   | 0   | 0   | 0    | 0   | 0   |
| 2011 | 0    | 0   | 0   | 0   | 0   | 0   | 0   | 0   | 0   | 0    | 0   | 0   |
| 2012 | 0    | 0   | 0   | 0   | 0   | 0   | 0   | 0   | 0   | 0    | 0   | 0   |
| 2013 | 0    | 0   | 0   | 0   | 0   | 0   | 0   | 0   | 0   | 0    | 0   | 0   |
| 2014 | 0    | 0   | 0   | 0   | 0   | 0   | 0   | 0   | 0   | 0    | 0   | 0   |
| 2015 | 0    | 0   | 0   | 0   | 0   | 0   | 0   | 0   | 0   | 0    | 0   | 0   |
| 2016 | 0    | 0   | 0   | 0   | 0   | 0   | 0   | 0   | 0   | 0    | 0   | 0   |
| 2017 | 0    | 0   | 0   | 0   | 0   | 0   | 0   | 0   | 0   | 0    | 0   | 0   |
| 2018 | 0    | 0   | 0   | 0   | 0   | 0   | 0   | 0   | 0   | 0    | 0   | 0   |
| 2019 | 0    | 0   | 0   | 0   | 0   | 0   | 0   | 0   | 0   | 0    | 0   | 0   |
| 2020 | 0    | 0   | 0   | 0   | 0   | 0   | 0   | 0   | 0   | 0    | 0   | 0   |
| 2021 | 0    | 0   | 0   | 73  | 0   | 0   | 0   | 0   | 0   | 0    | 0   | 0   |
| 2022 | 0    | 0   | 0   | 149 | 0   | 0   | 0   | 0   | 0   | 0    | 0   | 0   |
| 2023 | 0    | 0   | 0   | 202 | 0   | 0   | 0   | 0   | 0   | 0    | 0   | 0   |
| 2024 | 0    | 0   | 0   | 252 | 0   | 0   | 0   | 0   | 0   | 0    | 0   | 0   |
| 2025 | 0    | 0   | 0   | 268 | 0   | 0   | 0   | 0   | 0   | 0    | 0   | 0   |
| 2026 | 48   | 0   | 0   | 292 | 1   | 1   | 1   | 0   | 1   | 41   | 5   | 0   |
| 2027 | 129  | 0   | 0   | 315 | 29  | 30  | 31  | 12  | 29  | 109  | 13  | 0   |
| 2028 | 242  | 0   | 0   | 327 | 70  | 70  | 70  | 36  | 70  | 170  | 22  | 0   |
| 2029 | 331  | 30  | 0   | 354 | 149 | 145 | 139 | 86  | 139 | 245  | 32  | 0   |
| 2030 | 397  | 50  | 0   | 382 | 197 | 197 | 196 | 135 | 196 | 313  | 43  | 0   |
| 2031 | 456  | 71  | 0   | 384 | 220 | 220 | 219 | 187 | 219 | 359  | 51  | 10  |
| 2032 | 495  | 77  | 0   | 398 | 242 | 242 | 232 | 206 | 232 | 427  | 66  | 32  |
| 2033 | 541  | 85  | 10  | 402 | 276 | 286 | 266 | 245 | 266 | 495  | 82  | 56  |
| 2034 | 567  | 89  | 33  | 422 | 293 | 318 | 297 | 284 | 297 | 546  | 93  | 82  |
| 2035 | 590  | 109 | 114 | 432 | 313 | 328 | 317 | 309 | 317 | 575  | 102 | 119 |
| 2036 | 621  | 129 | 165 | 450 | 340 | 360 | 350 | 343 | 350 | 597  | 106 | 157 |
| 2037 | 631  | 138 | 206 | 461 | 350 | 372 | 360 | 353 | 360 | 618  | 110 | 196 |
| 2038 | 661  | 160 | 233 | 468 | 370 | 382 | 380 | 377 | 380 | 635  | 112 | 228 |
| 2039 | 681  | 163 | 262 | 468 | 385 | 386 | 386 | 384 | 386 | 655  | 116 | 262 |
| 2040 | 694  | 163 | 272 | 468 | 395 | 396 | 396 | 396 | 396 | 682  | 120 | 282 |
| 2041 | 711  | 173 | 294 | 478 | 406 | 416 | 406 | 406 | 406 | 705  | 120 | 298 |
| 2042 | 741  | 181 | 316 | 488 | 426 | 427 | 426 | 426 | 426 | 710  | 120 | 303 |
| 2043 | 745  | 181 | 366 | 500 | 439 | 449 | 429 | 429 | 429 | 724  | 120 | 314 |
| 2044 | 755  | 181 | 390 | 520 | 441 | 461 | 429 | 429 | 429 | 750  | 123 | 324 |
| 2045 | 765  | 185 | 410 | 632 | 441 | 468 | 439 | 439 | 439 | 775  | 126 | 332 |
| 2046 | 783  | 185 | 419 | 729 | 451 | 468 | 441 | 441 | 441 | 918  | 155 | 346 |
| 2047 | 856  | 185 | 419 | 779 | 461 | 488 | 451 | 451 | 451 | 1031 | 177 | 358 |
| 2048 | 1015 | 195 | 429 | 798 | 495 | 555 | 498 | 498 | 498 | 1159 | 211 | 365 |
| 2049 | 1202 | 218 | 441 | 808 | 609 | 645 | 619 | 619 | 619 | 1252 | 239 | 401 |
| 2050 | 1317 | 242 | 441 | 808 | 674 | 680 | 666 | 666 | 666 | 1323 | 264 | 445 |
| 2051 | 1365 | 262 | 457 | 808 | 713 | 713 | 710 | 710 | 710 | 1385 | 288 | 490 |
| 2052 | 1401 | 272 | 517 | 808 | 750 | 750 | 750 | 750 | 750 | 1426 | 303 | 538 |
| 2053 | 1428 | 291 | 597 | 808 | 779 | 779 | 779 | 779 | 779 | 1436 | 307 | 595 |
| 2054 | 1439 | 302 | 655 | 808 | 798 | 798 | 798 | 798 | 798 | 1440 | 309 | 644 |
| 2055 | 1448 | 312 | 708 | 808 | 808 | 808 | 798 | 798 | 798 | 1447 | 312 | 691 |
| 2056 | 1448 | 312 | 740 | 808 | 808 | 813 | 798 | 798 | 798 | 1447 | 312 | 730 |
| 2057 | 1448 | 312 | 769 | 808 | 808 | 813 | 798 | 798 | 798 | 1447 | 312 | 767 |
| 2058 | 1448 | 312 | 788 | 808 | 808 | 813 | 798 | 798 | 798 | 1447 | 312 | 789 |
| 2059 | 1448 | 312 | 798 | 808 | 808 | 813 | 798 | 798 | 798 | 1447 | 312 | 810 |
| 2060 | 1448 | 312 | 808 | 808 | 808 | 813 | 798 | 798 | 798 | 1447 | 312 | 812 |
| 2061 | 1448 | 312 | 813 | 808 | 808 | 813 | 798 | 798 | 798 | 1447 | 312 | 814 |
| 2062 | 1448 | 312 | 813 | 808 | 808 | 813 | 798 | 798 | 798 | 1447 | 312 | 814 |
| 2063 | 1448 | 312 | 813 | 808 | 808 | 813 | 798 | 798 | 798 | 1447 | 312 | 814 |
| 2064 | 1448 | 312 | 813 | 808 | 808 | 813 | 798 | 798 | 798 | 1447 | 312 | 814 |
| 2065 | 1448 | 312 | 813 | 808 | 808 | 813 | 798 | 798 | 798 | 1447 | 312 | 814 |
| 2066 | 1448 | 312 | 813 | 808 | 808 | 813 | 798 | 798 | 798 | 1447 | 312 | 814 |
| 2067 | 1448 | 312 | 813 | 808 | 808 | 813 | 798 | 798 | 798 | 1447 | 312 | 814 |
| 2068 | 1448 | 312 | 813 | 808 | 808 | 813 | 798 | 798 | 798 | 1447 | 312 | 814 |

|      | 73   | 74  | 75  | 76  | 77  | 78  | 79  | 80  | 81  | 82   | 83  | 84  |
|------|------|-----|-----|-----|-----|-----|-----|-----|-----|------|-----|-----|
| 2069 | 1448 | 312 | 813 | 808 | 808 | 813 | 798 | 798 | 798 | 1447 | 312 | 814 |
| 2070 | 1448 | 312 | 813 | 808 | 808 | 813 | 798 | 798 | 798 | 1447 | 312 | 814 |
| 2071 | 1448 | 312 | 813 | 808 | 808 | 813 | 798 | 798 | 798 | 1447 | 312 | 814 |
| 2072 | 1448 | 312 | 813 | 808 | 808 | 813 | 798 | 798 | 798 | 1447 | 312 | 814 |
| 2073 | 1448 | 312 | 813 | 808 | 808 | 813 | 798 | 798 | 798 | 1447 | 312 | 814 |
| 2074 | 1448 | 312 | 813 | 808 | 808 | 813 | 798 | 798 | 798 | 1447 | 312 | 814 |
| 2075 | 1448 | 312 | 813 | 808 | 808 | 813 | 798 | 798 | 798 | 1447 | 312 | 814 |
| 2076 | 1448 | 312 | 813 | 808 | 808 | 813 | 798 | 798 | 798 | 1447 | 312 | 814 |
| 2077 | 1448 | 312 | 813 | 808 | 808 | 813 | 798 | 798 | 798 | 1447 | 312 | 814 |
| 2078 | 1448 | 312 | 813 | 808 | 808 | 813 | 798 | 798 | 798 | 1447 | 312 | 814 |
| 2079 | 1448 | 312 | 813 | 808 | 808 | 813 | 798 | 798 | 798 | 1447 | 312 | 814 |
| 2080 | 1448 | 312 | 813 | 808 | 808 | 813 | 798 | 798 | 798 | 1447 | 312 | 814 |
| 2081 | 1448 | 312 | 813 | 808 | 808 | 813 | 798 | 798 | 798 | 1447 | 312 | 814 |
| 2082 | 1448 | 312 | 813 | 808 | 808 | 813 | 798 | 798 | 798 | 1447 | 312 | 814 |
| 2083 | 1448 | 312 | 813 | 808 | 808 | 813 | 798 | 798 | 798 | 1447 | 312 | 814 |
| 2084 | 1448 | 312 | 813 | 808 | 808 | 813 | 798 | 798 | 798 | 1447 | 312 | 814 |
| 2085 | 1448 | 312 | 813 | 808 | 808 | 813 | 798 | 798 | 798 | 1447 | 312 | 814 |
| 2086 | 1448 | 312 | 813 | 808 | 808 | 813 | 798 | 798 | 798 | 1447 | 312 | 814 |
| 2087 | 1448 | 312 | 813 | 808 | 808 | 813 | 798 | 798 | 798 | 1447 | 312 | 814 |
| 2088 | 1448 | 312 | 813 | 808 | 808 | 813 | 798 | 798 | 798 | 1447 | 312 | 814 |
| 2089 | 1448 | 312 | 813 | 808 | 808 | 813 | 798 | 798 | 798 | 1447 | 312 | 814 |
| 2090 | 1448 | 312 | 813 | 808 | 808 | 813 | 798 | 798 | 798 | 1447 | 312 | 814 |

|      | 85  | 86  | 87  | 88  | 89  | 90  | 91   | 92  | 93  | 94  | 95  | 96  |
|------|-----|-----|-----|-----|-----|-----|------|-----|-----|-----|-----|-----|
| 2002 | 0   | 0   | 0   | 0   | 0   | 0   | 0    | 0   | 0   | 0   | 0   | 0   |
| 2003 | 0   | 0   | 0   | 0   | 0   | 0   | 0    | 0   | 0   | 0   | 0   | 0   |
| 2004 | 0   | 0   | 0   | 0   | 0   | 0   | 0    | 0   | 0   | 0   | 0   | 0   |
| 2005 | 0   | 0   | 0   | 0   | 0   | 0   | 0    | 0   | 0   | 0   | 0   | 0   |
| 2006 | 0   | 0   | 0   | 0   | 0   | 0   | 0    | 0   | 0   | 0   | 0   | 0   |
| 2007 | 0   | 0   | 0   | 0   | 0   | 0   | 0    | 0   | 0   | 0   | 0   | 0   |
| 2008 | 0   | 0   | 0   | 0   | 0   | 0   | 0    | 0   | 0   | 0   | 0   | 0   |
| 2009 | 0   | 0   | 0   | 0   | 0   | 0   | 0    | 0   | 0   | 0   | 0   | 0   |
| 2010 | 0   | 0   | 0   | 0   | 0   | 0   | 0    | 0   | 0   | 0   | 0   | 0   |
| 2011 | 0   | 0   | 0   | 0   | 0   | 0   | 0    | 0   | 0   | 0   | 0   | 0   |
| 2012 | 0   | 0   | 0   | 0   | 0   | 0   | 0    | 0   | 0   | 0   | 0   | 0   |
| 2013 | 0   | 0   | 0   | 0   | 0   | 0   | 0    | 0   | 0   | 0   | 0   | 0   |
| 2014 | 0   | 0   | 0   | 0   | 0   | 0   | 0    | 0   | 0   | 0   | 0   | 0   |
| 2015 | 0   | 0   | 0   | 0   | 0   | 0   | 0    | 0   | 0   | 0   | 0   | 0   |
| 2016 | 0   | 0   | 0   | 0   | 0   | 0   | 0    | 0   | 0   | 0   | 0   | 0   |
| 2017 | 0   | 0   | 0   | 0   | 0   | 0   | 0    | 0   | 0   | 0   | 0   | 0   |
| 2018 | 0   | 0   | 0   | 0   | 0   | 0   | 0    | 0   | 0   | 0   | 0   | 0   |
| 2019 | 0   | 0   | 0   | 0   | 0   | 0   | 0    | 0   | 0   | 0   | 0   | 0   |
| 2020 | 0   | 0   | 0   | 0   | 0   | 0   | 0    | 0   | 0   | 0   | 0   | 0   |
| 2021 | 39  | 0   | 0   | 0   | 0   | 0   | 0    | 0   | 0   | 86  | 0   | 0   |
| 2022 | 91  | 0   | 0   | 0   | 0   | 0   | 0    | 0   | 0   | 142 | 0   | 0   |
| 2023 | 120 | 0   | 0   | 0   | 0   | 0   | 0    | 0   | 0   | 211 | 0   | 0   |
| 2024 | 170 | 0   | 0   | 0   | 0   | 0   | 0    | 0   | 0   | 257 | 0   | 0   |
| 2025 | 205 | 0   | 0   | 0   | 0   | 0   | 0    | 0   | 0   | 276 | 0   | 0   |
| 2026 | 233 | 16  | 16  | 16  | 16  | 16  | 98   | 17  | 0   | 295 | 47  | 47  |
| 2027 | 260 | 43  | 43  | 43  | 43  | 43  | 189  | 41  | 0   | 321 | 102 | 102 |
| 2028 | 295 | 74  | 74  | 74  | 74  | 74  | 267  | 57  | 0   | 337 | 141 | 141 |
| 2029 | 316 | 109 | 109 | 109 | 109 | 109 | 351  | 77  | 0   | 358 | 189 | 191 |
| 2030 | 334 | 146 | 146 | 146 | 146 | 146 | 420  | 95  | 0   | 379 | 235 | 237 |
| 2031 | 345 | 169 | 169 | 169 | 169 | 169 | 472  | 109 | 34  | 388 | 268 | 270 |
| 2032 | 356 | 214 | 214 | 214 | 214 | 214 | 509  | 117 | 75  | 408 | 284 | 288 |
| 2033 | 366 | 257 | 257 | 257 | 257 | 257 | 544  | 123 | 122 | 426 | 306 | 315 |
| 2034 | 384 | 286 | 286 | 286 | 286 | 286 | 578  | 133 | 156 | 447 | 324 | 337 |
| 2035 | 395 | 306 | 306 | 306 | 306 | 306 | 599  | 139 | 201 | 456 | 335 | 347 |
| 2036 | 413 | 314 | 320 | 314 | 314 | 314 | 626  | 148 | 236 | 467 | 355 | 364 |
| 2037 | 418 | 327 | 326 | 327 | 327 | 327 | 647  | 156 | 266 | 468 | 367 | 378 |
| 2038 | 419 | 332 | 334 | 332 | 332 | 332 | 670  | 163 | 290 | 468 | 384 | 394 |
| 2039 | 437 | 342 | 349 | 344 | 344 | 344 | 692  | 171 | 308 | 468 | 400 | 412 |
| 2040 | 441 | 353 | 363 | 358 | 358 | 358 | 705  | 174 | 325 | 468 | 411 | 425 |
| 2041 | 441 | 363 | 367 | 368 | 368 | 368 | 725  | 179 | 349 | 468 | 422 | 439 |
| 2042 | 458 | 366 | 373 | 368 | 368 | 368 | 752  | 185 | 374 | 477 | 434 | 452 |
| 2043 | 466 | 366 | 380 | 370 | 370 | 370 | 768  | 189 | 395 | 477 | 444 | 460 |
| 2044 | 593 | 379 | 387 | 385 | 385 | 385 | 781  | 193 | 412 | 477 | 448 | 466 |
| 2045 | 677 | 390 | 394 | 397 | 397 | 397 | 790  | 194 | 422 | 477 | 449 | 472 |
| 2046 | 741 | 461 | 470 | 474 | 474 | 474 | 797  | 196 | 427 | 490 | 449 | 483 |
| 2047 | 797 | 525 | 534 | 539 | 539 | 539 | 797  | 196 | 429 | 490 | 449 | 488 |
| 2048 | 800 | 603 | 611 | 618 | 618 | 618 | 797  | 196 | 432 | 599 | 454 | 558 |
| 2049 | 810 | 667 | 674 | 678 | 678 | 678 | 941  | 216 | 436 | 699 | 523 | 625 |
| 2050 | 810 | 717 | 725 | 728 | 728 | 728 | 1079 | 236 | 484 | 754 | 595 | 693 |
| 2051 | 810 | 762 | 769 | 771 | 771 | 771 | 1210 | 257 | 535 | 775 | 665 | 739 |
| 2052 | 810 | 791 | 796 | 798 | 798 | 798 | 1305 | 276 | 585 | 794 | 724 | 765 |
| 2053 | 810 | 805 | 804 | 805 | 805 | 805 | 1365 | 290 | 642 | 806 | 760 | 780 |
| 2054 | 810 | 807 | 807 | 808 | 808 | 808 | 1395 | 297 | 693 | 806 | 780 | 796 |
| 2055 | 810 | 811 | 813 | 813 | 813 | 813 | 1420 | 303 | 736 | 806 | 796 | 805 |
| 2056 | 810 | 811 | 813 | 813 | 813 | 813 | 1434 | 308 | 762 | 806 | 805 | 810 |
| 2057 | 810 | 811 | 813 | 813 | 813 | 813 | 1442 | 311 | 783 | 806 | 810 | 814 |
| 2058 | 810 | 811 | 813 | 813 | 813 | 813 | 1448 | 313 | 796 | 806 | 814 | 814 |
| 2059 | 810 | 811 | 813 | 813 | 813 | 813 | 1448 | 313 | 804 | 806 | 814 | 814 |
| 2060 | 810 | 811 | 813 | 813 | 813 | 813 | 1448 | 313 | 808 | 806 | 814 | 814 |
| 2061 | 810 | 811 | 813 | 813 | 813 | 813 | 1448 | 313 | 812 | 806 | 814 | 814 |
| 2062 | 810 | 811 | 813 | 813 | 813 | 813 | 1448 | 313 | 814 | 806 | 814 | 814 |
| 2063 | 810 | 811 | 813 | 813 | 813 | 813 | 1448 | 313 | 814 | 806 | 814 | 814 |
| 2064 | 810 | 811 | 813 | 813 | 813 | 813 | 1448 | 313 | 814 | 806 | 814 | 814 |
| 2065 | 810 | 811 | 813 | 813 | 813 | 813 | 1448 | 313 | 814 | 806 | 814 | 814 |
| 2066 | 810 | 811 | 813 | 813 | 813 | 813 | 1448 | 313 | 814 | 806 | 814 | 814 |
| 2067 | 810 | 811 | 813 | 813 | 813 | 813 | 1448 | 313 | 814 | 806 | 814 | 814 |
| 2068 | 810 | 811 | 813 | 813 | 813 | 813 | 1448 | 313 | 814 | 806 | 814 | 814 |

|      | 85  | 86  | 87  | 88  | 89  | 90  | 91   | 92  | 93  | 94  | 95  | 96  |
|------|-----|-----|-----|-----|-----|-----|------|-----|-----|-----|-----|-----|
| 2069 | 810 | 811 | 813 | 813 | 813 | 813 | 1448 | 313 | 814 | 806 | 814 | 814 |
| 2070 | 810 | 811 | 813 | 813 | 813 | 813 | 1448 | 313 | 814 | 806 | 814 | 814 |
| 2071 | 810 | 811 | 813 | 813 | 813 | 813 | 1448 | 313 | 814 | 806 | 814 | 814 |
| 2072 | 810 | 811 | 813 | 813 | 813 | 813 | 1448 | 313 | 814 | 806 | 814 | 814 |
| 2073 | 810 | 811 | 813 | 813 | 813 | 813 | 1448 | 313 | 814 | 806 | 814 | 814 |
| 2074 | 810 | 811 | 813 | 813 | 813 | 813 | 1448 | 313 | 814 | 806 | 814 | 814 |
| 2075 | 810 | 811 | 813 | 813 | 813 | 813 | 1448 | 313 | 814 | 806 | 814 | 814 |
| 2076 | 810 | 811 | 813 | 813 | 813 | 813 | 1448 | 313 | 814 | 806 | 814 | 814 |
| 2077 | 810 | 811 | 813 | 813 | 813 | 813 | 1448 | 313 | 814 | 806 | 814 | 814 |
| 2078 | 810 | 811 | 813 | 813 | 813 | 813 | 1448 | 313 | 814 | 806 | 814 | 814 |
| 2079 | 810 | 811 | 813 | 813 | 813 | 813 | 1448 | 313 | 814 | 806 | 814 | 814 |
| 2080 | 810 | 811 | 813 | 813 | 813 | 813 | 1448 | 313 | 814 | 806 | 814 | 814 |
| 2081 | 810 | 811 | 813 | 813 | 813 | 813 | 1448 | 313 | 814 | 806 | 814 | 814 |
| 2082 | 810 | 811 | 813 | 813 | 813 | 813 | 1448 | 313 | 814 | 806 | 814 | 814 |
| 2083 | 810 | 811 | 813 | 813 | 813 | 813 | 1448 | 313 | 814 | 806 | 814 | 814 |
| 2084 | 810 | 811 | 813 | 813 | 813 | 813 | 1448 | 313 | 814 | 806 | 814 | 814 |
| 2085 | 810 | 811 | 813 | 813 | 813 | 813 | 1448 | 313 | 814 | 806 | 814 | 814 |
| 2086 | 810 | 811 | 813 | 813 | 813 | 813 | 1448 | 313 | 814 | 806 | 814 | 814 |
| 2087 | 810 | 811 | 813 | 813 | 813 | 813 | 1448 | 313 | 814 | 806 | 814 | 814 |
| 2088 | 810 | 811 | 813 | 813 | 813 | 813 | 1448 | 313 | 814 | 806 | 814 | 814 |
| 2089 | 810 | 811 | 813 | 813 | 813 | 813 | 1448 | 313 | 814 | 806 | 814 | 814 |
| 2090 | 810 | 811 | 813 | 813 | 813 | 813 | 1448 | 313 | 814 | 806 | 814 | 814 |



|      | 97  | 98  | 99  | 100  | 101 | 102 | 103 | 104 | 105 | 106 | 107 | 108 |
|------|-----|-----|-----|------|-----|-----|-----|-----|-----|-----|-----|-----|
| 2002 | 0   | 0   | 0   | 0    | 0   | 0   | 0   | 0   | 0   | 0   | 0   | 0   |
| 2003 | 0   | 0   | 0   | 0    | 0   | 0   | 0   | 0   | 0   | 0   | 0   | 0   |
| 2004 | 0   | 0   | 0   | 0    | 0   | 0   | 0   | 0   | 0   | 0   | 0   | 0   |
| 2005 | 0   | 0   | 0   | 0    | 0   | 0   | 0   | 0   | 0   | 0   | 0   | 0   |
| 2006 | 0   | 0   | 0   | 0    | 0   | 0   | 0   | 0   | 0   | 0   | 0   | 0   |
| 2007 | 0   | 0   | 0   | 0    | 0   | 0   | 0   | 0   | 0   | 0   | 0   | 0   |
| 2008 | 0   | 0   | 0   | 0    | 0   | 0   | 0   | 0   | 0   | 0   | 0   | 0   |
| 2009 | 0   | 0   | 0   | 0    | 0   | 0   | 0   | 0   | 0   | 0   | 0   | 0   |
| 2010 | 0   | 0   | 0   | 0    | 0   | 0   | 0   | 0   | 0   | 0   | 0   | 0   |
| 2011 | 0   | 0   | 0   | 0    | 0   | 0   | 0   | 0   | 0   | 0   | 0   | 0   |
| 2012 | 0   | 0   | 0   | 0    | 0   | 0   | 0   | 0   | 0   | 0   | 0   | 0   |
| 2013 | 0   | 0   | 0   | 0    | 0   | 0   | 0   | 0   | 0   | 0   | 0   | 0   |
| 2014 | 0   | 0   | 0   | 0    | 0   | 0   | 0   | 0   | 0   | 0   | 0   | 0   |
| 2015 | 0   | 0   | 0   | 0    | 0   | 0   | 0   | 0   | 0   | 0   | 0   | 0   |
| 2016 | 0   | 0   | 0   | 0    | 0   | 0   | 0   | 0   | 0   | 0   | 0   | 0   |
| 2017 | 0   | 0   | 0   | 0    | 0   | 0   | 0   | 0   | 0   | 0   | 0   | 0   |
| 2018 | 0   | 0   | 0   | 0    | 0   | 0   | 0   | 0   | 0   | 0   | 0   | 0   |
| 2019 | 0   | 0   | 0   | 0    | 0   | 0   | 0   | 0   | 0   | 0   | 0   | 0   |
| 2020 | 0   | 0   | 0   | 0    | 0   | 0   | 0   | 0   | 0   | 0   | 0   | 0   |
| 2021 | 0   | 0   | 0   | 0    | 0   | 0   | 78  | 0   | 0   | 0   | 0   | 0   |
| 2022 | 0   | 0   | 0   | 0    | 0   | 0   | 136 | 0   | 0   | 0   | 0   | 0   |
| 2023 | 0   | 0   | 0   | 0    | 0   | 0   | 200 | 0   | 0   | 0   | 0   | 0   |
| 2024 | 0   | 0   | 0   | 0    | 0   | 0   | 250 | 0   | 0   | 0   | 0   | 0   |
| 2025 | 0   | 0   | 0   | 0    | 0   | 0   | 269 | 0   | 0   | 0   | 0   | 0   |
| 2026 | 47  | 42  | 47  | 96   | 17  | 0   | 292 | 47  | 47  | 47  | 32  | 47  |
| 2027 | 102 | 95  | 102 | 182  | 41  | 0   | 316 | 104 | 102 | 102 | 69  | 100 |
| 2028 | 141 | 130 | 141 | 265  | 57  | 0   | 332 | 145 | 141 | 141 | 98  | 141 |
| 2029 | 189 | 174 | 189 | 346  | 77  | 0   | 348 | 198 | 190 | 189 | 133 | 189 |
| 2030 | 235 | 228 | 235 | 415  | 95  | 0   | 377 | 241 | 236 | 235 | 184 | 235 |
| 2031 | 268 | 260 | 268 | 469  | 109 | 34  | 386 | 274 | 269 | 268 | 240 | 268 |
| 2032 | 288 | 281 | 288 | 506  | 116 | 75  | 395 | 287 | 288 | 287 | 263 | 287 |
| 2033 | 310 | 305 | 310 | 542  | 123 | 122 | 406 | 311 | 315 | 308 | 289 | 308 |
| 2034 | 330 | 325 | 330 | 573  | 132 | 156 | 420 | 328 | 337 | 327 | 314 | 327 |
| 2035 | 341 | 341 | 341 | 593  | 138 | 201 | 434 | 338 | 346 | 338 | 330 | 338 |
| 2036 | 358 | 358 | 358 | 624  | 147 | 236 | 447 | 358 | 363 | 357 | 350 | 357 |
| 2037 | 372 | 372 | 372 | 638  | 153 | 266 | 460 | 370 | 375 | 367 | 360 | 367 |
| 2038 | 387 | 387 | 387 | 665  | 161 | 290 | 467 | 387 | 390 | 384 | 381 | 384 |
| 2039 | 403 | 403 | 403 | 688  | 169 | 308 | 468 | 402 | 403 | 400 | 398 | 400 |
| 2040 | 411 | 411 | 411 | 705  | 174 | 325 | 468 | 413 | 411 | 411 | 411 | 411 |
| 2041 | 423 | 423 | 423 | 721  | 179 | 349 | 468 | 425 | 424 | 421 | 421 | 421 |
| 2042 | 440 | 440 | 440 | 748  | 184 | 374 | 482 | 440 | 441 | 438 | 438 | 438 |
| 2043 | 449 | 449 | 449 | 755  | 186 | 394 | 493 | 446 | 451 | 442 | 442 | 442 |
| 2044 | 458 | 458 | 458 | 761  | 187 | 408 | 514 | 453 | 459 | 445 | 445 | 445 |
| 2045 | 463 | 463 | 463 | 771  | 189 | 418 | 620 | 454 | 472 | 449 | 449 | 449 |
| 2046 | 468 | 468 | 468 | 794  | 193 | 425 | 712 | 459 | 489 | 461 | 461 | 461 |
| 2047 | 468 | 468 | 468 | 932  | 213 | 432 | 760 | 528 | 558 | 529 | 529 | 529 |
| 2048 | 468 | 468 | 468 | 1074 | 234 | 434 | 782 | 601 | 624 | 601 | 601 | 601 |
| 2049 | 536 | 536 | 536 | 1210 | 257 | 440 | 800 | 668 | 693 | 671 | 671 | 671 |
| 2050 | 604 | 604 | 604 | 1304 | 276 | 487 | 807 | 726 | 741 | 726 | 726 | 726 |
| 2051 | 672 | 672 | 672 | 1364 | 290 | 538 | 814 | 762 | 765 | 762 | 762 | 762 |
| 2052 | 728 | 728 | 728 | 1395 | 297 | 591 | 814 | 780 | 780 | 780 | 780 | 780 |
| 2053 | 762 | 762 | 762 | 1420 | 303 | 651 | 814 | 796 | 796 | 796 | 796 | 796 |
| 2054 | 780 | 780 | 780 | 1434 | 308 | 698 | 814 | 805 | 805 | 805 | 805 | 805 |
| 2055 | 796 | 796 | 796 | 1442 | 311 | 741 | 814 | 810 | 810 | 810 | 810 | 810 |
| 2056 | 805 | 805 | 805 | 1448 | 313 | 766 | 814 | 810 | 814 | 814 | 814 | 814 |
| 2057 | 810 | 810 | 810 | 1448 | 313 | 783 | 814 | 810 | 814 | 814 | 814 | 814 |
| 2058 | 814 | 814 | 814 | 1448 | 313 | 796 | 814 | 810 | 814 | 814 | 814 | 814 |
| 2059 | 814 | 814 | 814 | 1448 | 313 | 804 | 814 | 810 | 814 | 814 | 814 | 814 |
| 2060 | 814 | 814 | 814 | 1448 | 313 | 808 | 814 | 810 | 814 | 814 | 814 | 814 |
| 2061 | 814 | 814 | 814 | 1448 | 313 | 812 | 814 | 810 | 814 | 814 | 814 | 814 |
| 2062 | 814 | 814 | 814 | 1448 | 313 | 814 | 814 | 810 | 814 | 814 | 814 | 814 |
| 2063 | 814 | 814 | 814 | 1448 | 313 | 814 | 814 | 810 | 814 | 814 | 814 | 814 |
| 2064 | 814 | 814 | 814 | 1448 | 313 | 814 | 814 | 810 | 814 | 814 | 814 | 814 |
| 2065 | 814 | 814 | 814 | 1448 | 313 | 814 | 814 | 810 | 814 | 814 | 814 | 814 |
| 2066 | 814 | 814 | 814 | 1448 | 313 | 814 | 814 | 810 | 814 | 814 | 814 | 814 |
| 2067 | 814 | 814 | 814 | 1448 | 313 | 814 | 814 | 810 | 814 | 814 | 814 | 814 |
| 2068 | 814 | 814 | 814 | 1448 | 313 | 814 | 814 | 810 | 814 | 814 | 814 | 814 |

|      | 97  | 98  | 99  | 100  | 101 | 102 | 103 | 104 | 105 | 106 | 107 | 108 |
|------|-----|-----|-----|------|-----|-----|-----|-----|-----|-----|-----|-----|
| 2069 | 814 | 814 | 814 | 1448 | 313 | 814 | 814 | 810 | 814 | 814 | 814 | 814 |
| 2070 | 814 | 814 | 814 | 1448 | 313 | 814 | 814 | 810 | 814 | 814 | 814 | 814 |
| 2071 | 814 | 814 | 814 | 1448 | 313 | 814 | 814 | 810 | 814 | 814 | 814 | 814 |
| 2072 | 814 | 814 | 814 | 1448 | 313 | 814 | 814 | 810 | 814 | 814 | 814 | 814 |
| 2073 | 814 | 814 | 814 | 1448 | 313 | 814 | 814 | 810 | 814 | 814 | 814 | 814 |
| 2074 | 814 | 814 | 814 | 1448 | 313 | 814 | 814 | 810 | 814 | 814 | 814 | 814 |
| 2075 | 814 | 814 | 814 | 1448 | 313 | 814 | 814 | 810 | 814 | 814 | 814 | 814 |
| 2076 | 814 | 814 | 814 | 1448 | 313 | 814 | 814 | 810 | 814 | 814 | 814 | 814 |
| 2077 | 814 | 814 | 814 | 1448 | 313 | 814 | 814 | 810 | 814 | 814 | 814 | 814 |
| 2078 | 814 | 814 | 814 | 1448 | 313 | 814 | 814 | 810 | 814 | 814 | 814 | 814 |
| 2079 | 814 | 814 | 814 | 1448 | 313 | 814 | 814 | 810 | 814 | 814 | 814 | 814 |
| 2080 | 814 | 814 | 814 | 1448 | 313 | 814 | 814 | 810 | 814 | 814 | 814 | 814 |
| 2081 | 814 | 814 | 814 | 1448 | 313 | 814 | 814 | 810 | 814 | 814 | 814 | 814 |
| 2082 | 814 | 814 | 814 | 1448 | 313 | 814 | 814 | 810 | 814 | 814 | 814 | 814 |
| 2083 | 814 | 814 | 814 | 1448 | 313 | 814 | 814 | 810 | 814 | 814 | 814 | 814 |
| 2084 | 814 | 814 | 814 | 1448 | 313 | 814 | 814 | 810 | 814 | 814 | 814 | 814 |
| 2085 | 814 | 814 | 814 | 1448 | 313 | 814 | 814 | 810 | 814 | 814 | 814 | 814 |
| 2086 | 814 | 814 | 814 | 1448 | 313 | 814 | 814 | 810 | 814 | 814 | 814 | 814 |
| 2087 | 814 | 814 | 814 | 1448 | 313 | 814 | 814 | 810 | 814 | 814 | 814 | 814 |
| 2088 | 814 | 814 | 814 | 1448 | 313 | 814 | 814 | 810 | 814 | 814 | 814 | 814 |
| 2089 | 814 | 814 | 814 | 1448 | 313 | 814 | 814 | 810 | 814 | 814 | 814 | 814 |
| 2090 | 814 | 814 | 814 | 1448 | 313 | 814 | 814 | 810 | 814 | 814 | 814 | 814 |

|      | 109  | 110 | 111 | 112 | 113 | 114 | 115 | 116 | 117 | 118  | 119 | 120 |
|------|------|-----|-----|-----|-----|-----|-----|-----|-----|------|-----|-----|
| 2002 | 0    | 0   | 0   | 0   | 0   | 0   | 0   | 0   | 0   | 0    | 0   | 0   |
| 2003 | 0    | 0   | 0   | 0   | 0   | 0   | 0   | 0   | 0   | 0    | 0   | 0   |
| 2004 | 0    | 0   | 0   | 0   | 0   | 0   | 0   | 0   | 0   | 0    | 0   | 0   |
| 2005 | 0    | 0   | 0   | 0   | 0   | 0   | 0   | 0   | 0   | 0    | 0   | 0   |
| 2006 | 0    | 0   | 0   | 0   | 0   | 0   | 0   | 0   | 0   | 0    | 0   | 0   |
| 2007 | 0    | 0   | 0   | 0   | 0   | 0   | 0   | 0   | 0   | 0    | 0   | 0   |
| 2008 | 0    | 0   | 0   | 0   | 0   | 0   | 0   | 0   | 0   | 0    | 0   | 0   |
| 2009 | 0    | 0   | 0   | 0   | 0   | 0   | 0   | 0   | 0   | 0    | 0   | 0   |
| 2010 | 0    | 0   | 0   | 0   | 0   | 0   | 0   | 0   | 0   | 0    | 0   | 0   |
| 2011 | 0    | 0   | 0   | 0   | 0   | 0   | 0   | 0   | 0   | 0    | 0   | 0   |
| 2012 | 0    | 0   | 0   | 0   | 0   | 0   | 0   | 0   | 0   | 0    | 0   | 0   |
| 2013 | 0    | 0   | 0   | 0   | 0   | 0   | 0   | 0   | 0   | 0    | 0   | 0   |
| 2014 | 0    | 0   | 0   | 0   | 0   | 0   | 0   | 0   | 0   | 0    | 0   | 0   |
| 2015 | 0    | 0   | 0   | 0   | 0   | 0   | 0   | 0   | 0   | 0    | 0   | 0   |
| 2016 | 0    | 0   | 0   | 0   | 0   | 0   | 0   | 0   | 0   | 0    | 0   | 0   |
| 2017 | 0    | 0   | 0   | 0   | 0   | 0   | 0   | 0   | 0   | 0    | 0   | 0   |
| 2018 | 0    | 0   | 0   | 0   | 0   | 0   | 0   | 0   | 0   | 0    | 0   | 0   |
| 2019 | 0    | 0   | 0   | 0   | 0   | 0   | 0   | 0   | 0   | 0    | 0   | 0   |
| 2020 | 0    | 0   | 0   | 0   | 0   | 0   | 0   | 0   | 0   | 0    | 0   | 0   |
| 2021 | 0    | 0   | 0   | 0   | 0   | 0   | 0   | 0   | 0   | 0    | 0   | 0   |
| 2022 | 0    | 0   | 0   | 0   | 0   | 0   | 0   | 0   | 0   | 0    | 0   | 0   |
| 2023 | 0    | 0   | 0   | 0   | 0   | 0   | 0   | 0   | 0   | 0    | 0   | 0   |
| 2024 | 0    | 0   | 0   | 0   | 0   | 0   | 0   | 0   | 0   | 0    | 0   | 0   |
| 2025 | 0    | 0   | 0   | 0   | 0   | 0   | 0   | 0   | 0   | 0    | 0   | 0   |
| 2026 | 0    | 0   | 0   | 0   | 0   | 0   | 0   | 0   | 0   | 7    | 4   | 0   |
| 2027 | 0    | 0   | 0   | 0   | 0   | 0   | 0   | 0   | 0   | 18   | 6   | 0   |
| 2028 | 0    | 0   | 0   | 2   | 0   | 0   | 0   | 0   | 0   | 27   | 15  | 0   |
| 2029 | 0    | 0   | 0   | 4   | 0   | 0   | 0   | 0   | 0   | 51   | 36  | 0   |
| 2030 | 0    | 0   | 0   | 19  | 0   | 0   | 0   | 0   | 0   | 75   | 46  | 0   |
| 2031 | 0    | 0   | 0   | 29  | 0   | 1   | 0   | 0   | 0   | 97   | 51  | 2   |
| 2032 | 0    | 0   | 0   | 47  | 0   | 15  | 0   | 0   | 0   | 142  | 70  | 16  |
| 2033 | 12   | 0   | 0   | 70  | 0   | 39  | 1   | 1   | 1   | 179  | 89  | 33  |
| 2034 | 13   | 1   | 0   | 87  | 0   | 72  | 2   | 2   | 2   | 208  | 102 | 52  |
| 2035 | 19   | 4   | 0   | 91  | 0   | 86  | 8   | 8   | 8   | 243  | 124 | 78  |
| 2036 | 47   | 11  | 0   | 96  | 1   | 92  | 35  | 35  | 35  | 314  | 145 | 110 |
| 2037 | 82   | 23  | 0   | 102 | 1   | 92  | 60  | 60  | 60  | 362  | 151 | 143 |
| 2038 | 94   | 26  | 0   | 110 | 16  | 96  | 68  | 68  | 68  | 382  | 151 | 177 |
| 2039 | 131  | 34  | 2   | 125 | 23  | 100 | 93  | 93  | 93  | 396  | 151 | 207 |
| 2040 | 153  | 34  | 16  | 137 | 47  | 111 | 109 | 109 | 109 | 414  | 151 | 228 |
| 2041 | 173  | 38  | 25  | 161 | 56  | 130 | 122 | 122 | 122 | 443  | 153 | 260 |
| 2042 | 195  | 44  | 58  | 268 | 99  | 157 | 129 | 129 | 129 | 476  | 154 | 275 |
| 2043 | 220  | 47  | 65  | 393 | 128 | 172 | 149 | 149 | 149 | 513  | 158 | 286 |
| 2044 | 383  | 91  | 99  | 472 | 225 | 277 | 215 | 215 | 215 | 541  | 158 | 292 |
| 2045 | 544  | 133 | 111 | 558 | 310 | 353 | 304 | 304 | 304 | 568  | 161 | 292 |
| 2046 | 641  | 146 | 199 | 646 | 365 | 401 | 372 | 372 | 372 | 586  | 164 | 295 |
| 2047 | 744  | 153 | 290 | 722 | 398 | 438 | 426 | 426 | 426 | 594  | 165 | 306 |
| 2048 | 825  | 160 | 357 | 769 | 437 | 461 | 452 | 452 | 452 | 604  | 167 | 369 |
| 2049 | 889  | 168 | 394 | 809 | 472 | 503 | 490 | 490 | 490 | 639  | 181 | 401 |
| 2050 | 982  | 212 | 417 | 814 | 532 | 573 | 558 | 558 | 558 | 739  | 205 | 411 |
| 2051 | 1093 | 238 | 437 | 814 | 624 | 651 | 648 | 648 | 648 | 800  | 216 | 428 |
| 2052 | 1235 | 284 | 469 | 814 | 711 | 731 | 727 | 727 | 727 | 905  | 248 | 463 |
| 2053 | 1336 | 313 | 485 | 814 | 770 | 777 | 777 | 777 | 777 | 1084 | 290 | 500 |
| 2054 | 1398 | 313 | 513 | 814 | 802 | 809 | 809 | 809 | 809 | 1237 | 306 | 556 |
| 2055 | 1440 | 313 | 595 | 814 | 814 | 814 | 814 | 814 | 814 | 1328 | 307 | 631 |
| 2056 | 1449 | 313 | 680 | 814 | 814 | 814 | 814 | 814 | 814 | 1390 | 313 | 699 |
| 2057 | 1449 | 313 | 742 | 814 | 814 | 814 | 814 | 814 | 814 | 1427 | 313 | 759 |
| 2058 | 1449 | 313 | 784 | 814 | 814 | 814 | 814 | 814 | 814 | 1448 | 313 | 805 |
| 2059 | 1449 | 313 | 812 | 814 | 814 | 814 | 814 | 814 | 814 | 1449 | 313 | 814 |
| 2060 | 1449 | 313 | 814 | 814 | 814 | 814 | 814 | 814 | 814 | 1449 | 313 | 814 |
| 2061 | 1449 | 313 | 814 | 814 | 814 | 814 | 814 | 814 | 814 | 1449 | 313 | 814 |
| 2062 | 1449 | 313 | 814 | 814 | 814 | 814 | 814 | 814 | 814 | 1449 | 313 | 814 |
| 2063 | 1449 | 313 | 814 | 814 | 814 | 814 | 814 | 814 | 814 | 1449 | 313 | 814 |
| 2064 | 1449 | 313 | 814 | 814 | 814 | 814 | 814 | 814 | 814 | 1449 | 313 | 814 |
| 2065 | 1449 | 313 | 814 | 814 | 814 | 814 | 814 | 814 | 814 | 1449 | 313 | 814 |
| 2066 | 1449 | 313 | 814 | 814 | 814 | 814 | 814 | 814 | 814 | 1449 | 313 | 814 |
| 2067 | 1449 | 313 | 814 | 814 | 814 | 814 | 814 | 814 | 814 | 1449 | 313 | 814 |
| 2068 | 1449 | 313 | 814 | 814 | 814 | 814 | 814 | 814 | 814 | 1449 | 313 | 814 |

|      | 109  | 110 | 111 | 112 | 113 | 114 | 115 | 116 | 117 | 118  | 119 | 120 |
|------|------|-----|-----|-----|-----|-----|-----|-----|-----|------|-----|-----|
| 2069 | 1449 | 313 | 814 | 814 | 814 | 814 | 814 | 814 | 814 | 1449 | 313 | 814 |
| 2070 | 1449 | 313 | 814 | 814 | 814 | 814 | 814 | 814 | 814 | 1449 | 313 | 814 |
| 2071 | 1449 | 313 | 814 | 814 | 814 | 814 | 814 | 814 | 814 | 1449 | 313 | 814 |
| 2072 | 1449 | 313 | 814 | 814 | 814 | 814 | 814 | 814 | 814 | 1449 | 313 | 814 |
| 2073 | 1449 | 313 | 814 | 814 | 814 | 814 | 814 | 814 | 814 | 1449 | 313 | 814 |
| 2074 | 1449 | 313 | 814 | 814 | 814 | 814 | 814 | 814 | 814 | 1449 | 313 | 814 |
| 2075 | 1449 | 313 | 814 | 814 | 814 | 814 | 814 | 814 | 814 | 1449 | 313 | 814 |
| 2076 | 1449 | 313 | 814 | 814 | 814 | 814 | 814 | 814 | 814 | 1449 | 313 | 814 |
| 2077 | 1449 | 313 | 814 | 814 | 814 | 814 | 814 | 814 | 814 | 1449 | 313 | 814 |
| 2078 | 1449 | 313 | 814 | 814 | 814 | 814 | 814 | 814 | 814 | 1449 | 313 | 814 |
| 2079 | 1449 | 313 | 814 | 814 | 814 | 814 | 814 | 814 | 814 | 1449 | 313 | 814 |
| 2080 | 1449 | 313 | 814 | 814 | 814 | 814 | 814 | 814 | 814 | 1449 | 313 | 814 |
| 2081 | 1449 | 313 | 814 | 814 | 814 | 814 | 814 | 814 | 814 | 1449 | 313 | 814 |
| 2082 | 1449 | 313 | 814 | 814 | 814 | 814 | 814 | 814 | 814 | 1449 | 313 | 814 |
| 2083 | 1449 | 313 | 814 | 814 | 814 | 814 | 814 | 814 | 814 | 1449 | 313 | 814 |
| 2084 | 1449 | 313 | 814 | 814 | 814 | 814 | 814 | 814 | 814 | 1449 | 313 | 814 |
| 2085 | 1449 | 313 | 814 | 814 | 814 | 814 | 814 | 814 | 814 | 1449 | 313 | 814 |
| 2086 | 1449 | 313 | 814 | 814 | 814 | 814 | 814 | 814 | 814 | 1449 | 313 | 814 |
| 2087 | 1449 | 313 | 814 | 814 | 814 | 814 | 814 | 814 | 814 | 1449 | 313 | 814 |
| 2088 | 1449 | 313 | 814 | 814 | 814 | 814 | 814 | 814 | 814 | 1449 | 313 | 814 |
| 2089 | 1449 | 313 | 814 | 814 | 814 | 814 | 814 | 814 | 814 | 1449 | 313 | 814 |
| 2090 | 1449 | 313 | 814 | 814 | 814 | 814 | 814 | 814 | 814 | 1449 | 313 | 814 |

|      | 121 | 122 | 123 | 124 | 125 | 126 | 127  | 128 | 129 | 130 | 131 | 132 |
|------|-----|-----|-----|-----|-----|-----|------|-----|-----|-----|-----|-----|
| 2002 | 0   | 0   | 0   | 0   | 0   | 0   | 0    | 0   | 0   | 0   | 0   | 0   |
| 2003 | 0   | 0   | 0   | 0   | 0   | 0   | 0    | 0   | 0   | 0   | 0   | 0   |
| 2004 | 0   | 0   | 0   | 0   | 0   | 0   | 0    | 0   | 0   | 0   | 0   | 0   |
| 2005 | 0   | 0   | 0   | 0   | 0   | 0   | 0    | 0   | 0   | 0   | 0   | 0   |
| 2006 | 0   | 0   | 0   | 0   | 0   | 0   | 0    | 0   | 0   | 0   | 0   | 0   |
| 2007 | 0   | 0   | 0   | 0   | 0   | 0   | 0    | 0   | 0   | 0   | 0   | 0   |
| 2008 | 0   | 0   | 0   | 0   | 0   | 0   | 0    | 0   | 0   | 0   | 0   | 0   |
| 2009 | 0   | 0   | 0   | 0   | 0   | 0   | 0    | 0   | 0   | 0   | 0   | 0   |
| 2010 | 0   | 0   | 0   | 0   | 0   | 0   | 0    | 0   | 0   | 0   | 0   | 0   |
| 2011 | 0   | 0   | 0   | 0   | 0   | 0   | 0    | 0   | 0   | 0   | 0   | 0   |
| 2012 | 0   | 0   | 0   | 0   | 0   | 0   | 0    | 0   | 0   | 0   | 0   | 0   |
| 2013 | 0   | 0   | 0   | 0   | 0   | 0   | 0    | 0   | 0   | 0   | 0   | 0   |
| 2014 | 0   | 0   | 0   | 0   | 0   | 0   | 0    | 0   | 0   | 0   | 0   | 0   |
| 2015 | 0   | 0   | 0   | 0   | 0   | 0   | 0    | 0   | 0   | 0   | 0   | 0   |
| 2016 | 0   | 0   | 0   | 0   | 0   | 0   | 0    | 0   | 0   | 0   | 0   | 0   |
| 2017 | 0   | 0   | 0   | 0   | 0   | 0   | 0    | 0   | 0   | 0   | 0   | 0   |
| 2018 | 0   | 0   | 0   | 0   | 0   | 0   | 0    | 0   | 0   | 0   | 0   | 0   |
| 2019 | 0   | 0   | 0   | 0   | 0   | 0   | 0    | 0   | 0   | 0   | 0   | 0   |
| 2020 | 0   | 0   | 0   | 0   | 0   | 0   | 0    | 0   | 0   | 0   | 0   | 0   |
| 2021 | 5   | 0   | 0   | 0   | 0   | 0   | 0    | 0   | 0   | 3   | 0   | 0   |
| 2022 | 5   | 0   | 0   | 0   | 0   | 0   | 0    | 0   | 0   | 6   | 0   | 0   |
| 2023 | 16  | 0   | 0   | 0   | 0   | 0   | 0    | 0   | 0   | 13  | 0   | 0   |
| 2024 | 33  | 0   | 0   | 0   | 0   | 0   | 0    | 0   | 0   | 23  | 0   | 0   |
| 2025 | 51  | 0   | 0   | 0   | 0   | 0   | 0    | 0   | 0   | 34  | 0   | 0   |
| 2026 | 81  | 4   | 23  | 7   | 1   | 7   | 7    | 6   | 0   | 49  | 4   | 14  |
| 2027 | 89  | 16  | 48  | 13  | 6   | 13  | 15   | 10  | 0   | 70  | 9   | 27  |
| 2028 | 104 | 24  | 71  | 22  | 15  | 22  | 23   | 16  | 0   | 82  | 14  | 51  |
| 2029 | 123 | 41  | 93  | 46  | 41  | 46  | 31   | 22  | 0   | 85  | 20  | 74  |
| 2030 | 161 | 56  | 107 | 68  | 63  | 68  | 49   | 30  | 0   | 94  | 30  | 91  |
| 2031 | 200 | 60  | 124 | 89  | 84  | 89  | 67   | 37  | 5   | 115 | 37  | 107 |
| 2032 | 229 | 87  | 133 | 113 | 109 | 113 | 88   | 39  | 13  | 132 | 60  | 127 |
| 2033 | 252 | 111 | 147 | 140 | 138 | 140 | 114  | 44  | 28  | 180 | 71  | 149 |
| 2034 | 292 | 125 | 166 | 159 | 157 | 159 | 124  | 52  | 38  | 208 | 85  | 161 |
| 2035 | 307 | 138 | 188 | 188 | 188 | 188 | 148  | 64  | 46  | 246 | 97  | 186 |
| 2036 | 331 | 177 | 236 | 247 | 247 | 247 | 184  | 86  | 60  | 268 | 116 | 228 |
| 2037 | 332 | 211 | 269 | 273 | 273 | 273 | 226  | 94  | 75  | 281 | 143 | 256 |
| 2038 | 351 | 227 | 285 | 278 | 278 | 278 | 274  | 108 | 93  | 304 | 163 | 272 |
| 2039 | 366 | 247 | 314 | 287 | 287 | 287 | 328  | 126 | 122 | 329 | 191 | 297 |
| 2040 | 375 | 254 | 333 | 300 | 300 | 300 | 355  | 140 | 149 | 350 | 202 | 314 |
| 2041 | 375 | 281 | 336 | 311 | 311 | 311 | 380  | 151 | 182 | 358 | 225 | 329 |
| 2042 | 375 | 304 | 349 | 324 | 324 | 324 | 401  | 153 | 199 | 366 | 239 | 333 |
| 2043 | 383 | 323 | 360 | 340 | 340 | 340 | 435  | 153 | 218 | 370 | 254 | 349 |
| 2044 | 395 | 339 | 362 | 346 | 346 | 346 | 462  | 154 | 235 | 371 | 276 | 357 |
| 2045 | 411 | 346 | 368 | 356 | 356 | 356 | 490  | 154 | 239 | 377 | 291 | 366 |
| 2046 | 423 | 350 | 380 | 363 | 363 | 363 | 516  | 158 | 239 | 453 | 299 | 377 |
| 2047 | 439 | 358 | 395 | 370 | 370 | 370 | 617  | 179 | 240 | 608 | 381 | 392 |
| 2048 | 441 | 398 | 400 | 373 | 373 | 373 | 731  | 195 | 314 | 716 | 440 | 428 |
| 2049 | 441 | 425 | 435 | 405 | 405 | 405 | 787  | 216 | 361 | 782 | 462 | 527 |
| 2050 | 602 | 459 | 544 | 453 | 453 | 453 | 862  | 231 | 393 | 805 | 472 | 632 |
| 2051 | 722 | 505 | 649 | 493 | 493 | 493 | 1024 | 271 | 426 | 811 | 521 | 713 |
| 2052 | 786 | 596 | 723 | 568 | 568 | 568 | 1185 | 301 | 449 | 811 | 636 | 773 |
| 2053 | 806 | 704 | 771 | 674 | 674 | 674 | 1303 | 307 | 493 | 814 | 719 | 801 |
| 2054 | 812 | 768 | 811 | 751 | 751 | 751 | 1370 | 313 | 546 | 814 | 776 | 811 |
| 2055 | 814 | 801 | 814 | 800 | 800 | 800 | 1417 | 313 | 615 | 814 | 811 | 814 |
| 2056 | 814 | 814 | 814 | 814 | 814 | 814 | 1447 | 313 | 677 | 814 | 814 | 814 |
| 2057 | 814 | 814 | 814 | 814 | 814 | 814 | 1449 | 313 | 722 | 814 | 814 | 814 |
| 2058 | 814 | 814 | 814 | 814 | 814 | 814 | 1449 | 313 | 768 | 814 | 814 | 814 |
| 2059 | 814 | 814 | 814 | 814 | 814 | 814 | 1449 | 313 | 797 | 814 | 814 | 814 |
| 2060 | 814 | 814 | 814 | 814 | 814 | 814 | 1449 | 313 | 814 | 814 | 814 | 814 |
| 2061 | 814 | 814 | 814 | 814 | 814 | 814 | 1449 | 313 | 814 | 814 | 814 | 814 |
| 2062 | 814 | 814 | 814 | 814 | 814 | 814 | 1449 | 313 | 814 | 814 | 814 | 814 |
| 2063 | 814 | 814 | 814 | 814 | 814 | 814 | 1449 | 313 | 814 | 814 | 814 | 814 |
| 2064 | 814 | 814 | 814 | 814 | 814 | 814 | 1449 | 313 | 814 | 814 | 814 | 814 |
| 2065 | 814 | 814 | 814 | 814 | 814 | 814 | 1449 | 313 | 814 | 814 | 814 | 814 |
| 2066 | 814 | 814 | 814 | 814 | 814 | 814 | 1449 | 313 | 814 | 814 | 814 | 814 |
| 2067 | 814 | 814 | 814 | 814 | 814 | 814 | 1449 | 313 | 814 | 814 | 814 | 814 |
| 2068 | 814 | 814 | 814 | 814 | 814 | 814 | 1449 | 313 | 814 | 814 | 814 | 814 |

|      | 121 | 122 | 123 | 124 | 125 | 126 | 127  | 128 | 129 | 130 | 131 | 132 |
|------|-----|-----|-----|-----|-----|-----|------|-----|-----|-----|-----|-----|
| 2069 | 814 | 814 | 814 | 814 | 814 | 814 | 1449 | 313 | 814 | 814 | 814 | 814 |
| 2070 | 814 | 814 | 814 | 814 | 814 | 814 | 1449 | 313 | 814 | 814 | 814 | 814 |
| 2071 | 814 | 814 | 814 | 814 | 814 | 814 | 1449 | 313 | 814 | 814 | 814 | 814 |
| 2072 | 814 | 814 | 814 | 814 | 814 | 814 | 1449 | 313 | 814 | 814 | 814 | 814 |
| 2073 | 814 | 814 | 814 | 814 | 814 | 814 | 1449 | 313 | 814 | 814 | 814 | 814 |
| 2074 | 814 | 814 | 814 | 814 | 814 | 814 | 1449 | 313 | 814 | 814 | 814 | 814 |
| 2075 | 814 | 814 | 814 | 814 | 814 | 814 | 1449 | 313 | 814 | 814 | 814 | 814 |
| 2076 | 814 | 814 | 814 | 814 | 814 | 814 | 1449 | 313 | 814 | 814 | 814 | 814 |
| 2077 | 814 | 814 | 814 | 814 | 814 | 814 | 1449 | 313 | 814 | 814 | 814 | 814 |
| 2078 | 814 | 814 | 814 | 814 | 814 | 814 | 1449 | 313 | 814 | 814 | 814 | 814 |
| 2079 | 814 | 814 | 814 | 814 | 814 | 814 | 1449 | 313 | 814 | 814 | 814 | 814 |
| 2080 | 814 | 814 | 814 | 814 | 814 | 814 | 1449 | 313 | 814 | 814 | 814 | 814 |
| 2081 | 814 | 814 | 814 | 814 | 814 | 814 | 1449 | 313 | 814 | 814 | 814 | 814 |
| 2082 | 814 | 814 | 814 | 814 | 814 | 814 | 1449 | 313 | 814 | 814 | 814 | 814 |
| 2083 | 814 | 814 | 814 | 814 | 814 | 814 | 1449 | 313 | 814 | 814 | 814 | 814 |
| 2084 | 814 | 814 | 814 | 814 | 814 | 814 | 1449 | 313 | 814 | 814 | 814 | 814 |
| 2085 | 814 | 814 | 814 | 814 | 814 | 814 | 1449 | 313 | 814 | 814 | 814 | 814 |
| 2086 | 814 | 814 | 814 | 814 | 814 | 814 | 1449 | 313 | 814 | 814 | 814 | 814 |
| 2087 | 814 | 814 | 814 | 814 | 814 | 814 | 1449 | 313 | 814 | 814 | 814 | 814 |
| 2088 | 814 | 814 | 814 | 814 | 814 | 814 | 1449 | 313 | 814 | 814 | 814 | 814 |
| 2089 | 814 | 814 | 814 | 814 | 814 | 814 | 1449 | 313 | 814 | 814 | 814 | 814 |
| 2090 | 814 | 814 | 814 | 814 | 814 | 814 | 1449 | 313 | 814 | 814 | 814 | 814 |

|      | 133 | 134 | 135 | 136  | 137 | 138 | 139 | 140 | 141 | 142 |
|------|-----|-----|-----|------|-----|-----|-----|-----|-----|-----|
| 2002 | 0   | 0   | 0   | 0    | 0   | 0   | 0   | 0   | 0   | 0   |
| 2003 | 0   | 0   | 0   | 0    | 0   | 0   | 0   | 0   | 0   | 0   |
| 2004 | 0   | 0   | 0   | 0    | 0   | 0   | 0   | 0   | 0   | 0   |
| 2005 | 0   | 0   | 0   | 0    | 0   | 0   | 0   | 0   | 0   | 0   |
| 2006 | 0   | 0   | 0   | 0    | 0   | 0   | 0   | 0   | 0   | 0   |
| 2007 | 0   | 0   | 0   | 0    | 0   | 0   | 0   | 0   | 0   | 0   |
| 2008 | 0   | 0   | 0   | 0    | 0   | 0   | 0   | 0   | 0   | 0   |
| 2009 | 0   | 0   | 0   | 0    | 0   | 0   | 0   | 0   | 0   | 0   |
| 2010 | 0   | 0   | 0   | 0    | 0   | 0   | 0   | 0   | 0   | 0   |
| 2011 | 0   | 0   | 0   | 0    | 0   | 0   | 0   | 0   | 0   | 0   |
| 2012 | 0   | 0   | 0   | 0    | 0   | 0   | 0   | 0   | 0   | 0   |
| 2013 | 0   | 0   | 0   | 0    | 0   | 0   | 0   | 0   | 0   | 0   |
| 2014 | 0   | 0   | 0   | 0    | 0   | 0   | 0   | 0   | 0   | 0   |
| 2015 | 0   | 0   | 0   | 0    | 0   | 0   | 0   | 0   | 0   | 0   |
| 2016 | 0   | 0   | 0   | 0    | 0   | 0   | 0   | 0   | 0   | 0   |
| 2017 | 0   | 0   | 0   | 0    | 0   | 0   | 0   | 0   | 0   | 0   |
| 2018 | 0   | 0   | 0   | 0    | 0   | 0   | 0   | 0   | 0   | 0   |
| 2019 | 0   | 0   | 0   | 0    | 0   | 0   | 0   | 0   | 0   | 0   |
| 2020 | 0   | 0   | 0   | 0    | 0   | 0   | 0   | 0   | 0   | 0   |
| 2021 | 0   | 0   | 0   | 0    | 0   | 0   | 67  | 0   | 0   | 0   |
| 2022 | 0   | 0   | 0   | 0    | 0   | 0   | 138 | 0   | 0   | 0   |
| 2023 | 0   | 0   | 0   | 0    | 0   | 0   | 171 | 0   | 0   | 0   |
| 2024 | 0   | 0   | 0   | 0    | 0   | 0   | 210 | 0   | 0   | 0   |
| 2025 | 0   | 0   | 0   | 0    | 0   | 0   | 240 | 0   | 0   | 0   |
| 2026 | 7   | 2   | 7   | 66   | 23  | 0   | 279 | 40  | 40  | 40  |
| 2027 | 17  | 6   | 15  | 158  | 41  | 0   | 305 | 102 | 102 | 102 |
| 2028 | 23  | 12  | 23  | 239  | 56  | 0   | 337 | 144 | 144 | 144 |
| 2029 | 31  | 21  | 31  | 322  | 82  | 0   | 348 | 193 | 193 | 193 |
| 2030 | 49  | 39  | 49  | 383  | 84  | 0   | 350 | 222 | 222 | 222 |
| 2031 | 59  | 47  | 59  | 423  | 94  | 33  | 358 | 247 | 247 | 247 |
| 2032 | 73  | 59  | 73  | 491  | 113 | 96  | 361 | 285 | 285 | 285 |
| 2033 | 83  | 69  | 83  | 555  | 117 | 143 | 365 | 321 | 321 | 321 |
| 2034 | 92  | 82  | 92  | 590  | 117 | 186 | 395 | 339 | 339 | 339 |
| 2035 | 109 | 101 | 109 | 614  | 117 | 244 | 405 | 345 | 345 | 345 |
| 2036 | 144 | 137 | 144 | 628  | 117 | 287 | 429 | 345 | 346 | 345 |
| 2037 | 175 | 168 | 175 | 659  | 117 | 309 | 434 | 346 | 346 | 346 |
| 2038 | 207 | 204 | 207 | 670  | 117 | 329 | 434 | 347 | 347 | 347 |
| 2039 | 237 | 235 | 237 | 680  | 120 | 345 | 476 | 357 | 361 | 358 |
| 2040 | 258 | 258 | 258 | 697  | 122 | 345 | 478 | 369 | 379 | 372 |
| 2041 | 280 | 280 | 280 | 722  | 125 | 345 | 478 | 389 | 389 | 389 |
| 2042 | 295 | 295 | 295 | 740  | 125 | 345 | 505 | 394 | 394 | 394 |
| 2043 | 310 | 310 | 310 | 778  | 125 | 346 | 511 | 394 | 398 | 398 |
| 2044 | 323 | 323 | 323 | 804  | 133 | 357 | 645 | 428 | 428 | 428 |
| 2045 | 335 | 335 | 335 | 824  | 140 | 357 | 741 | 444 | 444 | 454 |
| 2046 | 347 | 347 | 347 | 1005 | 228 | 371 | 807 | 555 | 465 | 566 |
| 2047 | 401 | 401 | 401 | 1106 | 243 | 371 | 814 | 617 | 594 | 628 |
| 2048 | 439 | 439 | 439 | 1210 | 267 | 386 | 814 | 686 | 650 | 697 |
| 2049 | 485 | 485 | 485 | 1312 | 305 | 426 | 814 | 741 | 724 | 752 |
| 2050 | 535 | 535 | 535 | 1380 | 313 | 519 | 814 | 781 | 779 | 792 |
| 2051 | 633 | 633 | 633 | 1424 | 313 | 554 | 814 | 809 | 809 | 811 |
| 2052 | 728 | 728 | 728 | 1449 | 313 | 584 | 814 | 814 | 814 | 814 |
| 2053 | 783 | 783 | 783 | 1449 | 313 | 636 | 814 | 814 | 814 | 814 |
| 2054 | 809 | 809 | 809 | 1449 | 313 | 707 | 814 | 814 | 814 | 814 |
| 2055 | 814 | 814 | 814 | 1449 | 313 | 757 | 814 | 814 | 814 | 814 |
| 2056 | 814 | 814 | 814 | 1449 | 313 | 797 | 814 | 814 | 814 | 814 |
| 2057 | 814 | 814 | 814 | 1449 | 313 | 814 | 814 | 814 | 814 | 814 |
| 2058 | 814 | 814 | 814 | 1449 | 313 | 814 | 814 | 814 | 814 | 814 |
| 2059 | 814 | 814 | 814 | 1449 | 313 | 814 | 814 | 814 | 814 | 814 |
| 2060 | 814 | 814 | 814 | 1449 | 313 | 814 | 814 | 814 | 814 | 814 |
| 2061 | 814 | 814 | 814 | 1449 | 313 | 814 | 814 | 814 | 814 | 814 |
| 2062 | 814 | 814 | 814 | 1449 | 313 | 814 | 814 | 814 | 814 | 814 |
| 2063 | 814 | 814 | 814 | 1449 | 313 | 814 | 814 | 814 | 814 | 814 |
| 2064 | 814 | 814 | 814 | 1449 | 313 | 814 | 814 | 814 | 814 | 814 |
| 2065 | 814 | 814 | 814 | 1449 | 313 | 814 | 814 | 814 | 814 | 814 |
| 2066 | 814 | 814 | 814 | 1449 | 313 | 814 | 814 | 814 | 814 | 814 |
| 2067 | 814 | 814 | 814 | 1449 | 313 | 814 | 814 | 814 | 814 | 814 |
| 2068 | 814 | 814 | 814 | 1449 | 313 | 814 | 814 | 814 | 814 | 814 |

|      | 133 | 134 | 135 | 136  | 137 | 138 | 139 | 140 | 141 | 142 |
|------|-----|-----|-----|------|-----|-----|-----|-----|-----|-----|
| 2069 | 814 | 814 | 814 | 1449 | 313 | 814 | 814 | 814 | 814 | 814 |
| 2070 | 814 | 814 | 814 | 1449 | 313 | 814 | 814 | 814 | 814 | 814 |
| 2071 | 814 | 814 | 814 | 1449 | 313 | 814 | 814 | 814 | 814 | 814 |
| 2072 | 814 | 814 | 814 | 1449 | 313 | 814 | 814 | 814 | 814 | 814 |
| 2073 | 814 | 814 | 814 | 1449 | 313 | 814 | 814 | 814 | 814 | 814 |
| 2074 | 814 | 814 | 814 | 1449 | 313 | 814 | 814 | 814 | 814 | 814 |
| 2075 | 814 | 814 | 814 | 1449 | 313 | 814 | 814 | 814 | 814 | 814 |
| 2076 | 814 | 814 | 814 | 1449 | 313 | 814 | 814 | 814 | 814 | 814 |
| 2077 | 814 | 814 | 814 | 1449 | 313 | 814 | 814 | 814 | 814 | 814 |
| 2078 | 814 | 814 | 814 | 1449 | 313 | 814 | 814 | 814 | 814 | 814 |
| 2079 | 814 | 814 | 814 | 1449 | 313 | 814 | 814 | 814 | 814 | 814 |
| 2080 | 814 | 814 | 814 | 1449 | 313 | 814 | 814 | 814 | 814 | 814 |
| 2081 | 814 | 814 | 814 | 1449 | 313 | 814 | 814 | 814 | 814 | 814 |
| 2082 | 814 | 814 | 814 | 1449 | 313 | 814 | 814 | 814 | 814 | 814 |
| 2083 | 814 | 814 | 814 | 1449 | 313 | 814 | 814 | 814 | 814 | 814 |
| 2084 | 814 | 814 | 814 | 1449 | 313 | 814 | 814 | 814 | 814 | 814 |
| 2085 | 814 | 814 | 814 | 1449 | 313 | 814 | 814 | 814 | 814 | 814 |
| 2086 | 814 | 814 | 814 | 1449 | 313 | 814 | 814 | 814 | 814 | 814 |
| 2087 | 814 | 814 | 814 | 1449 | 313 | 814 | 814 | 814 | 814 | 814 |
| 2088 | 814 | 814 | 814 | 1449 | 313 | 814 | 814 | 814 | 814 | 814 |
| 2089 | 814 | 814 | 814 | 1449 | 313 | 814 | 814 | 814 | 814 | 814 |
| 2090 | 814 | 814 | 814 | 1449 | 313 | 814 | 814 | 814 | 814 | 814 |



|      | 143 | 144 | 145  | 146 | 147 | 148 | 149 | 150 | 151 | 152 |
|------|-----|-----|------|-----|-----|-----|-----|-----|-----|-----|
| 2002 | 0   | 0   | 0    | 0   | 0   | 0   | 0   | 0   | 0   | 0   |
| 2003 | 0   | 0   | 0    | 0   | 0   | 0   | 0   | 0   | 0   | 0   |
| 2004 | 0   | 0   | 0    | 0   | 0   | 0   | 0   | 0   | 0   | 0   |
| 2005 | 0   | 0   | 0    | 0   | 0   | 0   | 0   | 0   | 0   | 0   |
| 2006 | 0   | 0   | 0    | 0   | 0   | 0   | 0   | 0   | 0   | 0   |
| 2007 | 0   | 0   | 0    | 0   | 0   | 0   | 0   | 0   | 0   | 0   |
| 2008 | 0   | 0   | 0    | 0   | 0   | 0   | 0   | 0   | 0   | 0   |
| 2009 | 0   | 0   | 0    | 0   | 0   | 0   | 0   | 0   | 0   | 0   |
| 2010 | 0   | 0   | 0    | 0   | 0   | 0   | 0   | 0   | 0   | 0   |
| 2011 | 0   | 0   | 0    | 0   | 0   | 0   | 0   | 0   | 0   | 0   |
| 2012 | 0   | 0   | 0    | 0   | 0   | 0   | 0   | 0   | 0   | 0   |
| 2013 | 0   | 0   | 0    | 0   | 0   | 0   | 0   | 0   | 0   | 0   |
| 2014 | 0   | 0   | 0    | 0   | 0   | 0   | 0   | 0   | 0   | 0   |
| 2015 | 0   | 0   | 0    | 0   | 0   | 0   | 0   | 0   | 0   | 0   |
| 2016 | 0   | 0   | 0    | 0   | 0   | 0   | 0   | 0   | 0   | 0   |
| 2017 | 0   | 0   | 0    | 0   | 0   | 0   | 0   | 0   | 0   | 0   |
| 2018 | 0   | 0   | 0    | 0   | 0   | 0   | 0   | 0   | 0   | 0   |
| 2019 | 0   | 0   | 0    | 0   | 0   | 0   | 0   | 0   | 0   | 0   |
| 2020 | 0   | 0   | 0    | 0   | 0   | 0   | 0   | 0   | 0   | 0   |
| 2021 | 0   | 0   | 0    | 0   | 0   | 130 | 0   | 0   | 0   | 0   |
| 2022 | 0   | 0   | 0    | 0   | 0   | 207 | 0   | 0   | 0   | 0   |
| 2023 | 0   | 0   | 0    | 0   | 0   | 263 | 0   | 0   | 0   | 0   |
| 2024 | 0   | 0   | 0    | 0   | 0   | 299 | 0   | 0   | 0   | 0   |
| 2025 | 0   | 0   | 0    | 0   | 0   | 315 | 0   | 0   | 0   | 0   |
| 2026 | 40  | 40  | 155  | 54  | 0   | 327 | 110 | 110 | 110 | 81  |
| 2027 | 102 | 102 | 279  | 109 | 0   | 348 | 204 | 204 | 204 | 173 |
| 2028 | 144 | 144 | 375  | 127 | 0   | 368 | 256 | 256 | 256 | 225 |
| 2029 | 193 | 193 | 441  | 140 | 0   | 388 | 278 | 278 | 278 | 252 |
| 2030 | 222 | 222 | 500  | 154 | 0   | 404 | 312 | 312 | 312 | 300 |
| 2031 | 247 | 247 | 531  | 163 | 91  | 414 | 333 | 333 | 333 | 325 |
| 2032 | 285 | 285 | 561  | 163 | 207 | 427 | 348 | 352 | 352 | 345 |
| 2033 | 321 | 321 | 602  | 163 | 270 | 439 | 370 | 380 | 370 | 365 |
| 2034 | 339 | 339 | 624  | 173 | 303 | 459 | 390 | 392 | 390 | 385 |
| 2035 | 345 | 345 | 640  | 173 | 323 | 467 | 390 | 392 | 390 | 390 |
| 2036 | 345 | 345 | 665  | 173 | 340 | 468 | 396 | 396 | 396 | 396 |
| 2037 | 346 | 346 | 682  | 177 | 360 | 468 | 406 | 406 | 406 | 406 |
| 2038 | 347 | 347 | 694  | 177 | 390 | 468 | 416 | 416 | 416 | 416 |
| 2039 | 358 | 358 | 704  | 177 | 412 | 471 | 418 | 428 | 418 | 418 |
| 2040 | 372 | 372 | 724  | 181 | 424 | 471 | 428 | 438 | 428 | 428 |
| 2041 | 389 | 389 | 745  | 191 | 437 | 471 | 439 | 457 | 439 | 439 |
| 2042 | 394 | 394 | 765  | 196 | 439 | 493 | 452 | 468 | 459 | 459 |
| 2043 | 398 | 398 | 785  | 196 | 439 | 508 | 464 | 468 | 468 | 468 |
| 2044 | 428 | 428 | 795  | 196 | 443 | 512 | 464 | 468 | 468 | 468 |
| 2045 | 454 | 454 | 797  | 196 | 443 | 515 | 465 | 468 | 468 | 468 |
| 2046 | 566 | 566 | 797  | 196 | 451 | 540 | 465 | 472 | 468 | 468 |
| 2047 | 628 | 628 | 797  | 196 | 451 | 685 | 468 | 478 | 468 | 468 |
| 2048 | 697 | 697 | 797  | 196 | 451 | 760 | 468 | 527 | 468 | 468 |
| 2049 | 752 | 752 | 1012 | 280 | 451 | 789 | 628 | 680 | 636 | 636 |
| 2050 | 792 | 792 | 1201 | 305 | 451 | 808 | 737 | 754 | 743 | 743 |
| 2051 | 811 | 811 | 1322 | 311 | 603 | 814 | 776 | 793 | 776 | 776 |
| 2052 | 814 | 814 | 1380 | 313 | 702 | 814 | 805 | 814 | 805 | 805 |
| 2053 | 814 | 814 | 1417 | 313 | 753 | 814 | 814 | 814 | 814 | 814 |
| 2054 | 814 | 814 | 1438 | 313 | 779 | 814 | 814 | 814 | 814 | 814 |
| 2055 | 814 | 814 | 1449 | 313 | 805 | 814 | 814 | 814 | 814 | 814 |
| 2056 | 814 | 814 | 1449 | 313 | 814 | 814 | 814 | 814 | 814 | 814 |
| 2057 | 814 | 814 | 1449 | 313 | 814 | 814 | 814 | 814 | 814 | 814 |
| 2058 | 814 | 814 | 1449 | 313 | 814 | 814 | 814 | 814 | 814 | 814 |
| 2059 | 814 | 814 | 1449 | 313 | 814 | 814 | 814 | 814 | 814 | 814 |
| 2060 | 814 | 814 | 1449 | 313 | 814 | 814 | 814 | 814 | 814 | 814 |
| 2061 | 814 | 814 | 1449 | 313 | 814 | 814 | 814 | 814 | 814 | 814 |
| 2062 | 814 | 814 | 1449 | 313 | 814 | 814 | 814 | 814 | 814 | 814 |
| 2063 | 814 | 814 | 1449 | 313 | 814 | 814 | 814 | 814 | 814 | 814 |
| 2064 | 814 | 814 | 1449 | 313 | 814 | 814 | 814 | 814 | 814 | 814 |
| 2065 | 814 | 814 | 1449 | 313 | 814 | 814 | 814 | 814 | 814 | 814 |
| 2066 | 814 | 814 | 1449 | 313 | 814 | 814 | 814 | 814 | 814 | 814 |
| 2067 | 814 | 814 | 1449 | 313 | 814 | 814 | 814 | 814 | 814 | 814 |
| 2068 | 814 | 814 | 1449 | 313 | 814 | 814 | 814 | 814 | 814 | 814 |

|      | 143 | 144 | 145  | 146 | 147 | 148 | 149 | 150 | 151 | 152 |
|------|-----|-----|------|-----|-----|-----|-----|-----|-----|-----|
| 2069 | 814 | 814 | 1449 | 313 | 814 | 814 | 814 | 814 | 814 | 814 |
| 2070 | 814 | 814 | 1449 | 313 | 814 | 814 | 814 | 814 | 814 | 814 |
| 2071 | 814 | 814 | 1449 | 313 | 814 | 814 | 814 | 814 | 814 | 814 |
| 2072 | 814 | 814 | 1449 | 313 | 814 | 814 | 814 | 814 | 814 | 814 |
| 2073 | 814 | 814 | 1449 | 313 | 814 | 814 | 814 | 814 | 814 | 814 |
| 2074 | 814 | 814 | 1449 | 313 | 814 | 814 | 814 | 814 | 814 | 814 |
| 2075 | 814 | 814 | 1449 | 313 | 814 | 814 | 814 | 814 | 814 | 814 |
| 2076 | 814 | 814 | 1449 | 313 | 814 | 814 | 814 | 814 | 814 | 814 |
| 2077 | 814 | 814 | 1449 | 313 | 814 | 814 | 814 | 814 | 814 | 814 |
| 2078 | 814 | 814 | 1449 | 313 | 814 | 814 | 814 | 814 | 814 | 814 |
| 2079 | 814 | 814 | 1449 | 313 | 814 | 814 | 814 | 814 | 814 | 814 |
| 2080 | 814 | 814 | 1449 | 313 | 814 | 814 | 814 | 814 | 814 | 814 |
| 2081 | 814 | 814 | 1449 | 313 | 814 | 814 | 814 | 814 | 814 | 814 |
| 2082 | 814 | 814 | 1449 | 313 | 814 | 814 | 814 | 814 | 814 | 814 |
| 2083 | 814 | 814 | 1449 | 313 | 814 | 814 | 814 | 814 | 814 | 814 |
| 2084 | 814 | 814 | 1449 | 313 | 814 | 814 | 814 | 814 | 814 | 814 |
| 2085 | 814 | 814 | 1449 | 313 | 814 | 814 | 814 | 814 | 814 | 814 |
| 2086 | 814 | 814 | 1449 | 313 | 814 | 814 | 814 | 814 | 814 | 814 |
| 2087 | 814 | 814 | 1449 | 313 | 814 | 814 | 814 | 814 | 814 | 814 |
| 2088 | 814 | 814 | 1449 | 313 | 814 | 814 | 814 | 814 | 814 | 814 |
| 2089 | 814 | 814 | 1449 | 313 | 814 | 814 | 814 | 814 | 814 | 814 |
| 2090 | 814 | 814 | 1449 | 313 | 814 | 814 | 814 | 814 | 814 | 814 |

|      | 153 | 154  | 155 | 156 | 157 | 158 | 159 | 160 | 161 | 162 |
|------|-----|------|-----|-----|-----|-----|-----|-----|-----|-----|
| 2002 | 0   | 0    | 0   | 0   | 0   | 0   | 0   | 0   | 0   | 0   |
| 2003 | 0   | 0    | 0   | 0   | 0   | 0   | 0   | 0   | 0   | 0   |
| 2004 | 0   | 0    | 0   | 0   | 0   | 0   | 0   | 0   | 0   | 0   |
| 2005 | 0   | 0    | 0   | 0   | 0   | 0   | 0   | 0   | 0   | 0   |
| 2006 | 0   | 0    | 0   | 0   | 0   | 0   | 0   | 0   | 0   | 0   |
| 2007 | 0   | 0    | 0   | 0   | 0   | 0   | 0   | 0   | 0   | 0   |
| 2008 | 0   | 0    | 0   | 0   | 0   | 0   | 0   | 0   | 0   | 0   |
| 2009 | 0   | 0    | 0   | 0   | 0   | 0   | 0   | 0   | 0   | 0   |
| 2010 | 0   | 0    | 0   | 0   | 0   | 0   | 0   | 0   | 0   | 0   |
| 2011 | 0   | 0    | 0   | 0   | 0   | 0   | 0   | 0   | 0   | 0   |
| 2012 | 0   | 0    | 0   | 0   | 0   | 0   | 0   | 0   | 0   | 0   |
| 2013 | 0   | 0    | 0   | 0   | 0   | 0   | 0   | 0   | 0   | 0   |
| 2014 | 0   | 0    | 0   | 0   | 0   | 0   | 0   | 0   | 0   | 0   |
| 2015 | 0   | 0    | 0   | 0   | 0   | 0   | 0   | 0   | 0   | 0   |
| 2016 | 0   | 0    | 0   | 0   | 0   | 0   | 0   | 0   | 0   | 0   |
| 2017 | 0   | 0    | 0   | 0   | 0   | 0   | 0   | 0   | 0   | 0   |
| 2018 | 0   | 0    | 0   | 0   | 0   | 0   | 0   | 0   | 0   | 0   |
| 2019 | 0   | 0    | 0   | 0   | 0   | 0   | 0   | 0   | 0   | 0   |
| 2020 | 0   | 0    | 0   | 0   | 0   | 0   | 0   | 0   | 0   | 0   |
| 2021 | 0   | 0    | 0   | 0   | 113 | 0   | 0   | 0   | 0   | 0   |
| 2022 | 0   | 0    | 0   | 0   | 199 | 0   | 0   | 0   | 0   | 0   |
| 2023 | 0   | 0    | 0   | 0   | 252 | 0   | 0   | 0   | 0   | 0   |
| 2024 | 0   | 0    | 0   | 0   | 292 | 0   | 0   | 0   | 0   | 0   |
| 2025 | 0   | 0    | 0   | 0   | 308 | 0   | 0   | 0   | 0   | 0   |
| 2026 | 110 | 146  | 54  | 0   | 324 | 107 | 109 | 110 | 53  | 107 |
| 2027 | 204 | 262  | 109 | 0   | 342 | 210 | 202 | 204 | 111 | 202 |
| 2028 | 256 | 370  | 127 | 0   | 360 | 266 | 256 | 256 | 151 | 256 |
| 2029 | 278 | 436  | 140 | 0   | 380 | 289 | 278 | 278 | 191 | 278 |
| 2030 | 312 | 495  | 154 | 0   | 400 | 322 | 312 | 312 | 245 | 312 |
| 2031 | 333 | 528  | 163 | 91  | 410 | 343 | 333 | 333 | 299 | 333 |
| 2032 | 352 | 557  | 163 | 207 | 413 | 355 | 352 | 352 | 326 | 352 |
| 2033 | 370 | 600  | 163 | 270 | 417 | 384 | 377 | 370 | 349 | 370 |
| 2034 | 390 | 623  | 173 | 303 | 437 | 402 | 392 | 390 | 377 | 390 |
| 2035 | 390 | 639  | 173 | 323 | 450 | 402 | 392 | 390 | 382 | 390 |
| 2036 | 396 | 664  | 173 | 340 | 460 | 406 | 396 | 396 | 389 | 396 |
| 2037 | 406 | 678  | 177 | 360 | 468 | 416 | 406 | 406 | 399 | 406 |
| 2038 | 416 | 694  | 177 | 390 | 468 | 426 | 416 | 416 | 413 | 416 |
| 2039 | 418 | 704  | 177 | 412 | 468 | 428 | 418 | 418 | 416 | 418 |
| 2040 | 428 | 724  | 181 | 424 | 468 | 438 | 428 | 428 | 428 | 428 |
| 2041 | 439 | 737  | 191 | 437 | 468 | 450 | 439 | 438 | 438 | 438 |
| 2042 | 459 | 765  | 196 | 439 | 490 | 461 | 459 | 459 | 459 | 459 |
| 2043 | 468 | 765  | 196 | 439 | 510 | 461 | 468 | 459 | 459 | 459 |
| 2044 | 468 | 775  | 196 | 439 | 540 | 468 | 468 | 461 | 461 | 461 |
| 2045 | 468 | 783  | 196 | 444 | 693 | 468 | 480 | 461 | 461 | 461 |
| 2046 | 468 | 793  | 196 | 451 | 770 | 468 | 509 | 476 | 476 | 476 |
| 2047 | 468 | 1005 | 196 | 451 | 798 | 468 | 529 | 627 | 627 | 627 |
| 2048 | 468 | 1196 | 284 | 451 | 808 | 638 | 675 | 733 | 733 | 733 |
| 2049 | 636 | 1320 | 305 | 451 | 814 | 743 | 752 | 776 | 776 | 776 |
| 2050 | 743 | 1380 | 310 | 603 | 814 | 784 | 791 | 805 | 805 | 805 |
| 2051 | 776 | 1417 | 313 | 701 | 814 | 808 | 813 | 814 | 814 | 814 |
| 2052 | 805 | 1438 | 313 | 763 | 814 | 814 | 814 | 814 | 814 | 814 |
| 2053 | 814 | 1449 | 313 | 795 | 814 | 814 | 814 | 814 | 814 | 814 |
| 2054 | 814 | 1449 | 313 | 801 | 814 | 814 | 814 | 814 | 814 | 814 |
| 2055 | 814 | 1449 | 313 | 811 | 814 | 814 | 814 | 814 | 814 | 814 |
| 2056 | 814 | 1449 | 313 | 814 | 814 | 814 | 814 | 814 | 814 | 814 |
| 2057 | 814 | 1449 | 313 | 814 | 814 | 814 | 814 | 814 | 814 | 814 |
| 2058 | 814 | 1449 | 313 | 814 | 814 | 814 | 814 | 814 | 814 | 814 |
| 2059 | 814 | 1449 | 313 | 814 | 814 | 814 | 814 | 814 | 814 | 814 |
| 2060 | 814 | 1449 | 313 | 814 | 814 | 814 | 814 | 814 | 814 | 814 |
| 2061 | 814 | 1449 | 313 | 814 | 814 | 814 | 814 | 814 | 814 | 814 |
| 2062 | 814 | 1449 | 313 | 814 | 814 | 814 | 814 | 814 | 814 | 814 |
| 2063 | 814 | 1449 | 313 | 814 | 814 | 814 | 814 | 814 | 814 | 814 |
| 2064 | 814 | 1449 | 313 | 814 | 814 | 814 | 814 | 814 | 814 | 814 |
| 2065 | 814 | 1449 | 313 | 814 | 814 | 814 | 814 | 814 | 814 | 814 |
| 2066 | 814 | 1449 | 313 | 814 | 814 | 814 | 814 | 814 | 814 | 814 |
| 2067 | 814 | 1449 | 313 | 814 | 814 | 814 | 814 | 814 | 814 | 814 |
| 2068 | 814 | 1449 | 313 | 814 | 814 | 814 | 814 | 814 | 814 | 814 |

|      | 153 | 154  | 155 | 156 | 157 | 158 | 159 | 160 | 161 | 162 |
|------|-----|------|-----|-----|-----|-----|-----|-----|-----|-----|
| 2069 | 814 | 1449 | 313 | 814 | 814 | 814 | 814 | 814 | 814 | 814 |
| 2070 | 814 | 1449 | 313 | 814 | 814 | 814 | 814 | 814 | 814 | 814 |
| 2071 | 814 | 1449 | 313 | 814 | 814 | 814 | 814 | 814 | 814 | 814 |
| 2072 | 814 | 1449 | 313 | 814 | 814 | 814 | 814 | 814 | 814 | 814 |
| 2073 | 814 | 1449 | 313 | 814 | 814 | 814 | 814 | 814 | 814 | 814 |
| 2074 | 814 | 1449 | 313 | 814 | 814 | 814 | 814 | 814 | 814 | 814 |
| 2075 | 814 | 1449 | 313 | 814 | 814 | 814 | 814 | 814 | 814 | 814 |
| 2076 | 814 | 1449 | 313 | 814 | 814 | 814 | 814 | 814 | 814 | 814 |
| 2077 | 814 | 1449 | 313 | 814 | 814 | 814 | 814 | 814 | 814 | 814 |
| 2078 | 814 | 1449 | 313 | 814 | 814 | 814 | 814 | 814 | 814 | 814 |
| 2079 | 814 | 1449 | 313 | 814 | 814 | 814 | 814 | 814 | 814 | 814 |
| 2080 | 814 | 1449 | 313 | 814 | 814 | 814 | 814 | 814 | 814 | 814 |
| 2081 | 814 | 1449 | 313 | 814 | 814 | 814 | 814 | 814 | 814 | 814 |
| 2082 | 814 | 1449 | 313 | 814 | 814 | 814 | 814 | 814 | 814 | 814 |
| 2083 | 814 | 1449 | 313 | 814 | 814 | 814 | 814 | 814 | 814 | 814 |
| 2084 | 814 | 1449 | 313 | 814 | 814 | 814 | 814 | 814 | 814 | 814 |
| 2085 | 814 | 1449 | 313 | 814 | 814 | 814 | 814 | 814 | 814 | 814 |
| 2086 | 814 | 1449 | 313 | 814 | 814 | 814 | 814 | 814 | 814 | 814 |
| 2087 | 814 | 1449 | 313 | 814 | 814 | 814 | 814 | 814 | 814 | 814 |
| 2088 | 814 | 1449 | 313 | 814 | 814 | 814 | 814 | 814 | 814 | 814 |
| 2089 | 814 | 1449 | 313 | 814 | 814 | 814 | 814 | 814 | 814 | 814 |
| 2090 | 814 | 1449 | 313 | 814 | 814 | 814 | 814 | 814 | 814 | 814 |

|      | 1    | 2   | 3         | 4   | 5      | 6   | 7   | 8   | 9   | 10   | 11  | 12  |
|------|------|-----|-----------|-----|--------|-----|-----|-----|-----|------|-----|-----|
| 2002 | 0    | 0   | 0         | 0   | 0      | 0   | 0   | 0   | 0   | 0    | 0   | 0   |
| 2003 | 0    | 0   | 0         | 0   | 0      | 0   | 0   | 0   | 0   | 0    | 0   | 0   |
| 2004 | 1    | 1   | 1         | 1   | 1      | 1   | 1   | 1   | 1   | 1    | 1   | 1   |
| 2005 | 3    | 3   | 3         | 3   | 3      | 3   | 3   | 3   | 3   | 3    | 3   | 3   |
| 2006 | 14   | 14  | 14        | 14  | 14     | 14  | 14  | 14  | 14  | 14   | 14  | 14  |
| 2007 | 33   | 33  | 33        | 33  | 33     | 33  | 33  | 33  | 33  | 33   | 33  | 33  |
| 2008 | 67   | 67  | 67        | 67  | 67     | 67  | 67  | 67  | 67  | 67   | 67  | 67  |
| 2009 | 128  | 128 | 128       | 128 | 128    | 128 | 128 | 128 | 128 | 128  | 128 | 128 |
| 2010 | 210  | 210 | 210       | 210 | 210    | 210 | 210 | 210 | 210 | 210  | 210 | 210 |
| 2011 | 313  | 313 | 313       | 313 | 313    | 313 | 313 | 313 | 313 | 313  | 313 | 313 |
| 2012 | 418  | 313 | 418       | 418 | 418    | 418 | 418 | 418 | 418 | 418  | 313 | 418 |
| 2013 | 547  | 313 | 547       | 547 | 547    | 547 | 547 | 547 | 547 | 547  | 313 | 547 |
| 2014 | 665  | 313 | 665       | 665 | 665    | 665 | 665 | 665 | 665 | 665  | 313 | 665 |
| 2015 | 814  | 313 | 814       | 814 | 814    | 814 | 814 | 814 | 814 | 814  | 313 | 814 |
| 2016 | 957  | 313 | 814       | 814 | 814    | 814 | 814 | 814 | 814 | 957  | 313 | 814 |
| 2017 | 1109 | 313 | 814       | 814 | 814    | 814 | 814 | 814 | 814 | 1109 | 313 | 814 |
| 2018 | 1276 | 313 | 814       | 814 | 814    | 814 | 814 | 814 | 814 | 1276 | 313 | 814 |
| 2019 | 1449 | 313 | 814       | 814 | 814    | 814 | 814 | 814 | 814 | 1449 | 313 | 814 |
| 2020 | 1449 | 313 | 814       | 814 | 814    | 814 | 814 | 814 | 814 | 1449 | 313 | 814 |
| 2021 | 1449 | 313 | 814       | 814 | 814    | 814 | 814 | 814 | 814 | 1449 | 313 | 814 |
| 2022 | 1449 | 313 | 814       | 814 | 814    | 814 | 814 | 814 | 814 | 1449 | 313 | 814 |
| 2023 | 1449 | 313 | 814       | 814 | 814    | 814 | 814 | 814 | 814 | 1449 | 313 | 814 |
| 2024 | 1449 | 313 | 814       | 814 | 814    | 814 | 814 | 814 | 814 | 1449 | 313 | 814 |
| 2025 | 1449 | 313 | 814       | 814 | 814    | 814 | 814 | 814 | 814 | 1449 | 313 | 814 |
| 2026 | 1449 | 313 | 814       | 814 | 814    | 814 | 814 | 814 | 814 | 1449 | 313 | 814 |
| 2027 | 1449 | 313 | 814       | 814 | 814    | 814 | 814 | 814 | 814 | 1439 | 313 | 814 |
| 2028 | 1449 | 313 | 814       | 814 | 814    | 814 | 814 | 814 | 814 | 1439 | 313 | 814 |
| 2029 | 1449 | 313 | 814       | 814 | 814    | 814 | 814 | 814 | 814 | 1425 | 309 | 814 |
| 2030 | 1449 | 313 | 814       | 814 | 814    | 814 | 814 | 814 | 814 | 1411 | 309 | 814 |
| 2031 | 1449 | 313 | 814       | 814 | 814    | 814 | 814 | 814 | 814 | 1395 | 309 | 814 |
| 2032 | 1449 | 313 | 814       | 814 | 814    | 814 | 814 | 814 | 814 | 1355 | 304 | 814 |
| 2033 | 1443 | 313 | 814       | 805 | 814    | 814 | 814 | 814 | 814 | 1319 | 296 | 814 |
| 2034 | 1443 | 313 | 814       | 805 | 814    | 814 | 814 | 814 | 814 | 1303 | 291 | 814 |
| 2035 | 1443 | 313 | 814       | 801 | 814    | 814 | 814 | 814 | 814 | 1286 | 286 | 804 |
| 2036 | 1423 | 313 | 814       | 792 | 814    | 814 | 814 | 814 | 814 | 1233 | 286 | 803 |
| 2037 | 1418 | 313 | 814       | 785 | 814    | 804 | 814 | 814 | 814 | 1184 | 286 | 793 |
| 2038 | 1411 | 313 | 814       | 779 | 814    | 790 | 814 | 814 | 814 | 1152 | 266 | 783 |
| 2039 | 1385 | 313 | 814       | 758 | 814    | 790 | 804 | 804 | 804 | 1118 | 255 | 780 |
| 2040 | 1360 | 313 | 814       | 748 | 814    | 789 | 798 | 798 | 798 | 1099 | 252 | 770 |
| 2041 | 1354 | 313 | 814       | 720 | 814    | 789 | 779 | 779 | 779 | 1076 | 229 | 762 |
| 2042 | 1326 | 301 | 814       | 644 | 814    | 780 | 765 | 765 | 765 | 1044 | 208 | 752 |
| 2043 | 1304 | 301 | 814       | 527 | 803    | 780 | 748 | 748 | 748 | 1010 | 193 | 720 |
| 2044 | 1222 | 301 | 814       | 433 | 783    | 762 | 722 | 722 | 722 | 991  | 191 | 697 |
| 2045 | 1115 | 289 | 813       | 286 | 746    | 725 | 687 | 687 | 687 | 956  | 191 | 668 |
| 2046 | 993  | 288 | 813       | 154 | 696    | 664 | 652 | 652 | 652 | 927  | 190 | 660 |
| 2047 | 828  | 288 | 813       | 75  | 643    | 604 | 602 | 602 | 602 | 904  | 190 | 660 |
| 2048 | 676  | 268 | 779       | 39  | 567    | 511 | 509 | 509 | 509 | 884  | 187 | 634 |
| 2049 | 600  | 238 | 742       | 7   | 490    | 423 | 421 | 421 | 421 | 847  | 180 | 604 |
| 2050 | 466  | 206 | 699       | 7   | 431    | 390 | 377 | 377 | 377 | 765  | 164 | 539 |
| 2051 | 290  | 183 | 659       | 0   | 365.5  | 305 | 302 | 302 | 302 | 664  | 144 | 482 |
| 2052 | 165  | 143 | 569       | 0   | 243.25 | 205 | 211 | 211 | 211 | 524  | 142 | 450 |
| 2053 | 84   | 121 | 527       | 0   | 133    | 116 | 116 | 116 | 116 | 345  | 132 | 413 |
| 2054 | 22   | 62  | 445       | 0   | 59     | 49  | 49  | 49  | 49  | 194  | 98  | 385 |
| 2055 | 15   | 24  | 403       | 0   | 24     | 25  | 25  | 25  | 25  | 99   | 71  | 335 |
| 2056 | 7    | 23  | 371.66667 | 0   | 17     | 17  | 17  | 17  | 17  | 54   | 57  | 272 |
| 2057 | 7    | 5   | 279.83333 | 0   | 7      | 8   | 8   | 8   | 8   | 18   | 41  | 214 |
| 2058 | 0    | 5   | 188       | 0   | 7      | 7   | 7   | 7   | 7   | 7    | 12  | 161 |
| 2059 | 0    | 0   | 131       | 0   | 0      | 0   | 7   | 7   | 7   | 7    | 2   | 134 |
| 2060 | 0    | 0   | 59        | 0   | 0      | 0   | 7   | 7   | 7   | 1    | 1   | 131 |
| 2061 | 0    | 0   | 44        | 0   | 0      | 0   | 7   | 7   | 7   | 1    | 1   | 101 |
| 2062 | 0    | 0   | 14        | 0   | 0      | 0   | 7   | 7   | 7   | 1    | 1   | 61  |
| 2063 | 0    | 0   | 8         | 0   | 0      | 0   | 7   | 7   | 7   | 1    | 1   | 25  |
| 2064 | 0    | 0   | 2         | 0   | 0      | 0   | 7   | 7   | 7   | 1    | 1   | 6   |
| 2065 | 0    | 0   | 2         | 0   | 0      | 0   | 7   | 7   | 7   | 1    | 1   | 6   |
| 2066 | 0    | 0   | 0         | 0   | 0      | 0   | 7   | 7   | 7   | 1    | 1   | 6   |
| 2067 | 0    | 0   | 0         | 0   | 0      | 0   | 7   | 7   | 7   | 1    | 1   | 6   |
| 2068 | 0    | 0   | 0         | 0   | 0      | 0   | 7   | 7   | 7   | 1    | 1   | 6   |

|      | 1 | 2 | 3 | 4 | 5 | 6 | 7 | 8 | 9 | 10 | 11 | 12 |
|------|---|---|---|---|---|---|---|---|---|----|----|----|
| 2069 | 0 | 0 | 0 | 0 | 0 | 0 | 7 | 7 | 7 | 1  | 1  | 6  |
| 2070 | 0 | 0 | 0 | 0 | 0 | 0 | 7 | 7 | 7 | 1  | 1  | 6  |
| 2071 | 0 | 0 | 0 | 0 | 0 | 0 | 7 | 7 | 7 | 1  | 1  | 6  |
| 2072 | 0 | 0 | 0 | 0 | 0 | 0 | 7 | 7 | 7 | 1  | 1  | 6  |
| 2073 | 0 | 0 | 0 | 0 | 0 | 0 | 7 | 7 | 7 | 1  | 1  | 6  |
| 2074 | 0 | 0 | 0 | 0 | 0 | 0 | 7 | 7 | 7 | 1  | 1  | 6  |
| 2075 | 0 | 0 | 0 | 0 | 0 | 0 | 7 | 7 | 7 | 1  | 1  | 6  |
| 2076 | 0 | 0 | 0 | 0 | 0 | 0 | 7 | 7 | 7 | 1  | 1  | 6  |
| 2077 | 0 | 0 | 0 | 0 | 0 | 0 | 7 | 7 | 7 | 1  | 1  | 6  |
| 2078 | 0 | 0 | 0 | 0 | 0 | 0 | 7 | 7 | 7 | 1  | 1  | 6  |
| 2079 | 0 | 0 | 0 | 0 | 0 | 0 | 7 | 7 | 7 | 1  | 1  | 6  |
| 2080 | 0 | 0 | 0 | 0 | 0 | 0 | 7 | 7 | 7 | 1  | 1  | 6  |
| 2081 | 0 | 0 | 0 | 0 | 0 | 0 | 7 | 7 | 7 | 1  | 1  | 6  |
| 2082 | 0 | 0 | 0 | 0 | 0 | 0 | 7 | 7 | 7 | 1  | 1  | 6  |
| 2083 | 0 | 0 | 0 | 0 | 0 | 0 | 7 | 7 | 7 | 1  | 1  | 6  |
| 2084 | 0 | 0 | 0 | 0 | 0 | 0 | 7 | 7 | 7 | 1  | 1  | 6  |
| 2085 | 0 | 0 | 0 | 0 | 0 | 0 | 7 | 7 | 7 | 1  | 1  | 6  |
| 2086 | 0 | 0 | 0 | 0 | 0 | 0 | 7 | 7 | 7 | 1  | 1  | 6  |
| 2087 | 0 | 0 | 0 | 0 | 0 | 0 | 7 | 7 | 7 | 1  | 1  | 6  |
| 2088 | 0 | 0 | 0 | 0 | 0 | 0 | 7 | 7 | 7 | 1  | 1  | 6  |
| 2089 | 0 | 0 | 0 | 0 | 0 | 0 | 7 | 7 | 7 | 1  | 1  | 6  |
| 2090 | 0 | 0 | 0 | 0 | 0 | 0 | 7 | 7 | 7 | 1  | 1  | 6  |

|      | 13  | 14  | 15  | 16  | 17  | 18  | 19  | 20   | 21  | 22  | 23  | 24  |
|------|-----|-----|-----|-----|-----|-----|-----|------|-----|-----|-----|-----|
| 2002 | 0   | 0   | 0   | 0   | 0   | 0   | 0   | 0    | 0   | 0   | 0   | 0   |
| 2003 | 0   | 0   | 0   | 0   | 0   | 0   | 0   | 0    | 0   | 0   | 0   | 0   |
| 2004 | 1   | 1   | 1   | 1   | 1   | 1   | 1   | 1    | 1   | 1   | 1   | 1   |
| 2005 | 3   | 3   | 3   | 3   | 3   | 3   | 3   | 3    | 3   | 3   | 3   | 3   |
| 2006 | 14  | 14  | 14  | 14  | 14  | 14  | 14  | 14   | 14  | 14  | 14  | 14  |
| 2007 | 33  | 33  | 33  | 33  | 33  | 33  | 33  | 33   | 33  | 33  | 33  | 33  |
| 2008 | 67  | 67  | 67  | 67  | 67  | 67  | 67  | 67   | 67  | 67  | 67  | 67  |
| 2009 | 128 | 128 | 128 | 128 | 128 | 128 | 128 | 128  | 128 | 128 | 128 | 128 |
| 2010 | 210 | 210 | 210 | 210 | 210 | 210 | 210 | 210  | 210 | 210 | 210 | 210 |
| 2011 | 313 | 313 | 313 | 313 | 313 | 313 | 313 | 313  | 313 | 313 | 313 | 313 |
| 2012 | 418 | 418 | 418 | 418 | 418 | 418 | 418 | 313  | 418 | 418 | 418 | 418 |
| 2013 | 547 | 547 | 547 | 547 | 547 | 547 | 547 | 313  | 547 | 547 | 547 | 547 |
| 2014 | 665 | 665 | 665 | 665 | 665 | 665 | 665 | 313  | 665 | 665 | 665 | 665 |
| 2015 | 814 | 814 | 814 | 814 | 814 | 814 | 814 | 313  | 814 | 814 | 814 | 814 |
| 2016 | 814 | 814 | 814 | 814 | 814 | 814 | 814 | 957  | 313 | 814 | 814 | 814 |
| 2017 | 814 | 814 | 814 | 814 | 814 | 814 | 814 | 1109 | 313 | 814 | 814 | 814 |
| 2018 | 814 | 814 | 814 | 814 | 814 | 814 | 814 | 1276 | 313 | 814 | 814 | 814 |
| 2019 | 814 | 814 | 814 | 814 | 814 | 814 | 814 | 1449 | 313 | 814 | 814 | 814 |
| 2020 | 814 | 814 | 814 | 814 | 814 | 814 | 814 | 1449 | 313 | 814 | 814 | 814 |
| 2021 | 809 | 814 | 814 | 814 | 814 | 814 | 814 | 1449 | 313 | 814 | 809 | 814 |
| 2022 | 809 | 814 | 814 | 814 | 814 | 814 | 814 | 1449 | 313 | 814 | 809 | 814 |
| 2023 | 803 | 814 | 814 | 814 | 814 | 814 | 814 | 1449 | 313 | 814 | 803 | 814 |
| 2024 | 798 | 814 | 814 | 814 | 814 | 814 | 814 | 1449 | 313 | 814 | 795 | 814 |
| 2025 | 784 | 814 | 814 | 814 | 814 | 814 | 814 | 1449 | 313 | 814 | 788 | 814 |
| 2026 | 763 | 814 | 814 | 814 | 814 | 814 | 814 | 1449 | 313 | 814 | 774 | 814 |
| 2027 | 743 | 814 | 804 | 804 | 804 | 804 | 804 | 1439 | 313 | 814 | 759 | 814 |
| 2028 | 729 | 814 | 804 | 804 | 804 | 804 | 804 | 1439 | 313 | 814 | 738 | 814 |
| 2029 | 722 | 806 | 804 | 803 | 803 | 803 | 803 | 1425 | 309 | 814 | 733 | 806 |
| 2030 | 695 | 794 | 783 | 794 | 794 | 794 | 794 | 1419 | 309 | 814 | 724 | 803 |
| 2031 | 655 | 794 | 771 | 786 | 786 | 786 | 786 | 1411 | 309 | 814 | 714 | 803 |
| 2032 | 617 | 786 | 740 | 769 | 769 | 769 | 769 | 1393 | 309 | 814 | 705 | 785 |
| 2033 | 584 | 782 | 723 | 744 | 744 | 744 | 744 | 1361 | 297 | 814 | 665 | 767 |
| 2034 | 536 | 782 | 705 | 737 | 737 | 737 | 737 | 1345 | 291 | 814 | 638 | 757 |
| 2035 | 509 | 782 | 698 | 736 | 736 | 736 | 736 | 1332 | 286 | 804 | 602 | 757 |
| 2036 | 489 | 781 | 680 | 726 | 726 | 726 | 726 | 1318 | 286 | 803 | 582 | 756 |
| 2037 | 483 | 754 | 662 | 701 | 701 | 701 | 701 | 1291 | 286 | 803 | 565 | 756 |
| 2038 | 455 | 745 | 626 | 672 | 672 | 672 | 672 | 1267 | 286 | 803 | 538 | 743 |
| 2039 | 452 | 732 | 589 | 644 | 644 | 644 | 644 | 1203 | 277 | 793 | 507 | 742 |
| 2040 | 441 | 728 | 562 | 627 | 627 | 627 | 627 | 1154 | 262 | 791 | 468 | 730 |
| 2041 | 441 | 720 | 536 | 608 | 608 | 608 | 608 | 1124 | 259 | 781 | 445 | 729 |
| 2042 | 437 | 698 | 514 | 583 | 583 | 583 | 583 | 1101 | 252 | 773 | 439 | 720 |
| 2043 | 424 | 674 | 502 | 552 | 552 | 552 | 552 | 1066 | 236 | 773 | 439 | 697 |
| 2044 | 410 | 646 | 493 | 531 | 531 | 531 | 531 | 1023 | 211 | 762 | 439 | 658 |
| 2045 | 391 | 633 | 477 | 522 | 522 | 522 | 522 | 1001 | 201 | 736 | 399 | 629 |
| 2046 | 379 | 615 | 472 | 522 | 522 | 522 | 522 | 981  | 201 | 709 | 328 | 606 |
| 2047 | 378 | 600 | 455 | 501 | 501 | 501 | 501 | 912  | 186 | 684 | 191 | 585 |
| 2048 | 373 | 563 | 446 | 492 | 492 | 492 | 492 | 832  | 172 | 674 | 81  | 496 |
| 2049 | 306 | 455 | 422 | 465 | 465 | 465 | 465 | 707  | 154 | 659 | 40  | 443 |
| 2050 | 171 | 418 | 409 | 429 | 429 | 429 | 429 | 597  | 142 | 567 | 20  | 408 |
| 2051 | 85  | 405 | 369 | 407 | 407 | 407 | 407 | 434  | 142 | 513 | 7   | 375 |
| 2052 | 45  | 370 | 274 | 350 | 350 | 350 | 350 | 259  | 112 | 465 | 7   | 294 |
| 2053 | 25  | 265 | 190 | 281 | 281 | 281 | 281 | 138  | 85  | 432 | 1   | 227 |
| 2054 | 6   | 172 | 116 | 207 | 207 | 207 | 207 | 75   | 62  | 397 | 1   | 164 |
| 2055 | 0   | 124 | 67  | 125 | 125 | 125 | 125 | 38   | 57  | 375 | 1   | 94  |
| 2056 | 0   | 77  | 34  | 71  | 71  | 71  | 71  | 17   | 31  | 320 | 1   | 54  |
| 2057 | 0   | 44  | 6   | 34  | 34  | 34  | 34  | 2    | 4   | 257 | 1   | 25  |
| 2058 | 0   | 16  | 6   | 9   | 9   | 9   | 9   | 2    | 3   | 184 | 1   | 6   |
| 2059 | 0   | 6   | 6   | 3   | 3   | 3   | 3   | 1    | 2   | 151 | 1   | 6   |
| 2060 | 0   | 6   | 6   | 3   | 3   | 3   | 3   | 1    | 2   | 124 | 1   | 6   |
| 2061 | 0   | 6   | 6   | 3   | 3   | 3   | 3   | 1    | 1   | 91  | 1   | 6   |
| 2062 | 0   | 6   | 6   | 3   | 3   | 3   | 3   | 1    | 1   | 54  | 1   | 6   |
| 2063 | 0   | 6   | 6   | 3   | 3   | 3   | 3   | 1    | 1   | 24  | 1   | 6   |
| 2064 | 0   | 6   | 6   | 3   | 3   | 3   | 3   | 1    | 1   | 6   | 1   | 6   |
| 2065 | 0   | 6   | 6   | 3   | 3   | 3   | 3   | 1    | 1   | 6   | 1   | 6   |
| 2066 | 0   | 6   | 6   | 3   | 3   | 3   | 3   | 1    | 1   | 6   | 1   | 6   |
| 2067 | 0   | 6   | 6   | 3   | 3   | 3   | 3   | 1    | 1   | 6   | 1   | 6   |
| 2068 | 0   | 6   | 6   | 3   | 3   | 3   | 3   | 1    | 1   | 6   | 1   | 6   |

|      | 13 | 14 | 15 | 16 | 17 | 18 | 19 | 20 | 21 | 22 | 23 | 24 |
|------|----|----|----|----|----|----|----|----|----|----|----|----|
| 2069 | 0  | 6  | 6  | 3  | 3  | 3  | 1  | 1  | 6  | 1  | 6  | 4  |
| 2070 | 0  | 6  | 6  | 3  | 3  | 3  | 1  | 1  | 6  | 1  | 6  | 4  |
| 2071 | 0  | 6  | 6  | 3  | 3  | 3  | 1  | 1  | 6  | 1  | 6  | 4  |
| 2072 | 0  | 6  | 6  | 3  | 3  | 3  | 1  | 1  | 6  | 1  | 6  | 4  |
| 2073 | 0  | 6  | 6  | 3  | 3  | 3  | 1  | 1  | 6  | 1  | 6  | 4  |
| 2074 | 0  | 6  | 6  | 3  | 3  | 3  | 1  | 1  | 6  | 1  | 6  | 4  |
| 2075 | 0  | 6  | 6  | 3  | 3  | 3  | 1  | 1  | 6  | 1  | 6  | 4  |
| 2076 | 0  | 6  | 6  | 3  | 3  | 3  | 1  | 1  | 6  | 1  | 6  | 4  |
| 2077 | 0  | 6  | 6  | 3  | 3  | 3  | 1  | 1  | 6  | 1  | 6  | 4  |
| 2078 | 0  | 6  | 6  | 3  | 3  | 3  | 1  | 1  | 6  | 1  | 6  | 4  |
| 2079 | 0  | 6  | 6  | 3  | 3  | 3  | 1  | 1  | 6  | 1  | 6  | 4  |
| 2080 | 0  | 6  | 6  | 3  | 3  | 3  | 1  | 1  | 6  | 1  | 6  | 4  |
| 2081 | 0  | 6  | 6  | 3  | 3  | 3  | 1  | 1  | 6  | 1  | 6  | 4  |
| 2082 | 0  | 6  | 6  | 3  | 3  | 3  | 1  | 1  | 6  | 1  | 6  | 4  |
| 2083 | 0  | 6  | 6  | 3  | 3  | 3  | 1  | 1  | 6  | 1  | 6  | 4  |
| 2084 | 0  | 6  | 6  | 3  | 3  | 3  | 1  | 1  | 6  | 1  | 6  | 4  |
| 2085 | 0  | 6  | 6  | 3  | 3  | 3  | 1  | 1  | 6  | 1  | 6  | 4  |
| 2086 | 0  | 6  | 6  | 3  | 3  | 3  | 1  | 1  | 6  | 1  | 6  | 4  |
| 2087 | 0  | 6  | 6  | 3  | 3  | 3  | 1  | 1  | 6  | 1  | 6  | 4  |
| 2088 | 0  | 6  | 6  | 3  | 3  | 3  | 1  | 1  | 6  | 1  | 6  | 4  |
| 2089 | 0  | 6  | 6  | 3  | 3  | 3  | 1  | 1  | 6  | 1  | 6  | 4  |
| 2090 | 0  | 6  | 6  | 3  | 3  | 3  | 1  | 1  | 6  | 1  | 6  | 4  |



|      | 25  | 26  | 27  | 28   | 29  | 30  | 31  | 32  | 33  | 34  | 35  | 36  |
|------|-----|-----|-----|------|-----|-----|-----|-----|-----|-----|-----|-----|
| 2002 | 0   | 0   | 0   | 0    | 0   | 0   | 0   | 0   | 0   | 0   | 0   | 0   |
| 2003 | 0   | 0   | 0   | 0    | 0   | 0   | 0   | 0   | 0   | 0   | 0   | 0   |
| 2004 | 1   | 1   | 1   | 1    | 1   | 1   | 1   | 1   | 1   | 1   | 1   | 1   |
| 2005 | 3   | 3   | 3   | 3    | 3   | 3   | 3   | 3   | 3   | 3   | 3   | 3   |
| 2006 | 14  | 14  | 14  | 14   | 14  | 14  | 14  | 14  | 14  | 14  | 14  | 14  |
| 2007 | 33  | 33  | 33  | 33   | 33  | 33  | 33  | 33  | 33  | 33  | 33  | 33  |
| 2008 | 67  | 67  | 67  | 67   | 67  | 67  | 67  | 67  | 67  | 67  | 67  | 67  |
| 2009 | 128 | 128 | 128 | 128  | 128 | 128 | 128 | 128 | 128 | 128 | 128 | 128 |
| 2010 | 210 | 210 | 210 | 210  | 210 | 210 | 210 | 210 | 210 | 210 | 210 | 210 |
| 2011 | 313 | 313 | 313 | 313  | 313 | 313 | 313 | 313 | 313 | 313 | 313 | 313 |
| 2012 | 418 | 418 | 418 | 418  | 313 | 418 | 418 | 418 | 418 | 418 | 418 | 418 |
| 2013 | 547 | 547 | 547 | 547  | 313 | 547 | 547 | 547 | 547 | 547 | 547 | 547 |
| 2014 | 665 | 665 | 665 | 665  | 313 | 665 | 665 | 665 | 665 | 665 | 665 | 665 |
| 2015 | 814 | 814 | 814 | 814  | 313 | 814 | 814 | 814 | 814 | 814 | 814 | 814 |
| 2016 | 814 | 814 | 814 | 957  | 313 | 814 | 814 | 814 | 814 | 814 | 814 | 814 |
| 2017 | 814 | 814 | 814 | 1109 | 313 | 814 | 814 | 814 | 814 | 814 | 814 | 814 |
| 2018 | 814 | 814 | 814 | 1276 | 313 | 814 | 814 | 814 | 814 | 814 | 814 | 814 |
| 2019 | 814 | 814 | 814 | 1449 | 313 | 814 | 814 | 814 | 814 | 814 | 814 | 814 |
| 2020 | 814 | 814 | 814 | 1449 | 313 | 814 | 814 | 814 | 814 | 814 | 814 | 814 |
| 2021 | 814 | 814 | 814 | 1449 | 313 | 814 | 814 | 814 | 814 | 814 | 814 | 814 |
| 2022 | 814 | 814 | 814 | 1449 | 313 | 814 | 814 | 814 | 814 | 814 | 814 | 814 |
| 2023 | 814 | 814 | 814 | 1449 | 313 | 814 | 814 | 814 | 814 | 814 | 814 | 814 |
| 2024 | 814 | 814 | 814 | 1449 | 313 | 814 | 814 | 814 | 814 | 814 | 814 | 814 |
| 2025 | 814 | 814 | 814 | 1449 | 313 | 814 | 814 | 814 | 814 | 814 | 814 | 814 |
| 2026 | 814 | 814 | 814 | 1449 | 313 | 814 | 814 | 814 | 814 | 814 | 814 | 814 |
| 2027 | 804 | 804 | 804 | 1449 | 313 | 814 | 814 | 814 | 814 | 814 | 814 | 814 |
| 2028 | 804 | 804 | 804 | 1449 | 313 | 814 | 812 | 814 | 814 | 814 | 814 | 814 |
| 2029 | 803 | 803 | 803 | 1449 | 313 | 814 | 810 | 814 | 814 | 814 | 814 | 814 |
| 2030 | 803 | 803 | 803 | 1449 | 313 | 814 | 795 | 814 | 814 | 814 | 814 | 814 |
| 2031 | 794 | 794 | 794 | 1449 | 313 | 814 | 788 | 814 | 813 | 814 | 814 | 814 |
| 2032 | 779 | 779 | 779 | 1449 | 313 | 814 | 770 | 814 | 799 | 814 | 814 | 814 |
| 2033 | 749 | 749 | 749 | 1437 | 313 | 814 | 747 | 814 | 775 | 813 | 813 | 813 |
| 2034 | 742 | 742 | 742 | 1436 | 312 | 814 | 723 | 814 | 742 | 812 | 812 | 812 |
| 2035 | 734 | 734 | 734 | 1430 | 309 | 814 | 719 | 814 | 711 | 806 | 806 | 806 |
| 2036 | 733 | 733 | 733 | 1402 | 302 | 814 | 712 | 813 | 682 | 779 | 779 | 779 |
| 2037 | 714 | 714 | 714 | 1364 | 290 | 814 | 707 | 813 | 678 | 754 | 754 | 754 |
| 2038 | 694 | 694 | 694 | 1359 | 287 | 814 | 697 | 798 | 674 | 749 | 749 | 749 |
| 2039 | 666 | 666 | 666 | 1311 | 279 | 812 | 690 | 791 | 668 | 721 | 721 | 721 |
| 2040 | 646 | 646 | 646 | 1281 | 279 | 798 | 678 | 767 | 663 | 707 | 707 | 707 |
| 2041 | 635 | 635 | 635 | 1271 | 275 | 789 | 649 | 755 | 650 | 698 | 698 | 698 |
| 2042 | 618 | 618 | 618 | 1237 | 266 | 756 | 576 | 707 | 639 | 685 | 685 | 685 |
| 2043 | 591 | 591 | 591 | 1214 | 266 | 749 | 460 | 671 | 620 | 678 | 678 | 678 |
| 2044 | 551 | 551 | 551 | 1100 | 257 | 718 | 375 | 618 | 584 | 636 | 636 | 636 |
| 2045 | 541 | 541 | 541 | 975  | 244 | 701 | 273 | 573 | 523 | 590 | 590 | 590 |
| 2046 | 521 | 521 | 521 | 868  | 233 | 676 | 155 | 538 | 471 | 548 | 548 | 548 |
| 2047 | 511 | 511 | 511 | 760  | 217 | 637 | 75  | 496 | 426 | 495 | 495 | 495 |
| 2048 | 453 | 453 | 453 | 655  | 200 | 596 | 46  | 436 | 375 | 429 | 429 | 429 |
| 2049 | 414 | 414 | 414 | 551  | 184 | 559 | 19  | 376 | 301 | 369 | 369 | 369 |
| 2050 | 375 | 375 | 375 | 429  | 151 | 516 | 10  | 293 | 223 | 289 | 289 | 289 |
| 2051 | 320 | 320 | 320 | 299  | 122 | 473 | 7   | 219 | 160 | 213 | 213 | 213 |
| 2052 | 229 | 229 | 229 | 195  | 89  | 425 | 3   | 147 | 104 | 145 | 145 | 145 |
| 2053 | 157 | 157 | 157 | 113  | 62  | 379 | 0   | 92  | 61  | 92  | 92  | 92  |
| 2054 | 94  | 94  | 94  | 57   | 39  | 319 | 0   | 50  | 25  | 48  | 48  | 48  |
| 2055 | 54  | 54  | 54  | 19   | 20  | 264 | 0   | 20  | 12  | 15  | 15  | 15  |
| 2056 | 25  | 25  | 25  | 14   | 11  | 212 | 0   | 11  | 10  | 11  | 11  | 11  |
| 2057 | 6   | 6   | 6   | 6    | 7   | 161 | 0   | 9   | 3   | 5   | 5   | 5   |
| 2058 | 6   | 6   | 6   | 5    | 3   | 117 | 0   | 3   | 3   | 5   | 5   | 5   |
| 2059 | 6   | 6   | 6   | 1    | 2   | 81  | 0   | 1   | 3   | 5   | 5   | 5   |
| 2060 | 6   | 6   | 6   | 1    | 2   | 48  | 0   | 1   | 3   | 5   | 5   | 5   |
| 2061 | 6   | 6   | 6   | 1    | 2   | 24  | 0   | 1   | 3   | 5   | 5   | 5   |
| 2062 | 6   | 6   | 6   | 1    | 2   | 8   | 0   | 1   | 3   | 5   | 5   | 5   |
| 2063 | 6   | 6   | 6   | 1    | 2   | 5   | 0   | 1   | 3   | 5   | 5   | 5   |
| 2064 | 6   | 6   | 6   | 1    | 2   | 4   | 0   | 1   | 3   | 5   | 5   | 5   |
| 2065 | 6   | 6   | 6   | 1    | 2   | 2   | 0   | 1   | 3   | 5   | 5   | 5   |
| 2066 | 6   | 6   | 6   | 1    | 2   | 0   | 0   | 1   | 3   | 5   | 5   | 5   |
| 2067 | 6   | 6   | 6   | 1    | 2   | 0   | 0   | 1   | 3   | 5   | 5   | 5   |
| 2068 | 6   | 6   | 6   | 1    | 2   | 0   | 0   | 1   | 3   | 5   | 5   | 5   |

|      | 25 | 26 | 27 | 28 | 29 | 30 | 31 | 32 | 33 | 34 | 35 | 36 |
|------|----|----|----|----|----|----|----|----|----|----|----|----|
| 2069 | 6  | 6  | 6  | 1  | 2  | 0  | 0  | 1  | 3  | 5  | 5  | 5  |
| 2070 | 6  | 6  | 6  | 1  | 2  | 0  | 0  | 1  | 3  | 5  | 5  | 5  |
| 2071 | 6  | 6  | 6  | 1  | 2  | 0  | 0  | 1  | 3  | 5  | 5  | 5  |
| 2072 | 6  | 6  | 6  | 1  | 2  | 0  | 0  | 1  | 3  | 5  | 5  | 5  |
| 2073 | 6  | 6  | 6  | 1  | 2  | 0  | 0  | 1  | 3  | 5  | 5  | 5  |
| 2074 | 6  | 6  | 6  | 1  | 2  | 0  | 0  | 1  | 3  | 5  | 5  | 5  |
| 2075 | 6  | 6  | 6  | 1  | 2  | 0  | 0  | 1  | 3  | 5  | 5  | 5  |
| 2076 | 6  | 6  | 6  | 1  | 2  | 0  | 0  | 1  | 3  | 5  | 5  | 5  |
| 2077 | 6  | 6  | 6  | 1  | 2  | 0  | 0  | 1  | 3  | 5  | 5  | 5  |
| 2078 | 6  | 6  | 6  | 1  | 2  | 0  | 0  | 1  | 3  | 5  | 5  | 5  |
| 2079 | 6  | 6  | 6  | 1  | 2  | 0  | 0  | 1  | 3  | 5  | 5  | 5  |
| 2080 | 6  | 6  | 6  | 1  | 2  | 0  | 0  | 1  | 3  | 5  | 5  | 5  |
| 2081 | 6  | 6  | 6  | 1  | 2  | 0  | 0  | 1  | 3  | 5  | 5  | 5  |
| 2082 | 6  | 6  | 6  | 1  | 2  | 0  | 0  | 1  | 3  | 5  | 5  | 5  |
| 2083 | 6  | 6  | 6  | 1  | 2  | 0  | 0  | 1  | 3  | 5  | 5  | 5  |
| 2084 | 6  | 6  | 6  | 1  | 2  | 0  | 0  | 1  | 3  | 5  | 5  | 5  |
| 2085 | 6  | 6  | 6  | 1  | 2  | 0  | 0  | 1  | 3  | 5  | 5  | 5  |
| 2086 | 6  | 6  | 6  | 1  | 2  | 0  | 0  | 1  | 3  | 5  | 5  | 5  |
| 2087 | 6  | 6  | 6  | 1  | 2  | 0  | 0  | 1  | 3  | 5  | 5  | 5  |
| 2088 | 6  | 6  | 6  | 1  | 2  | 0  | 0  | 1  | 3  | 5  | 5  | 5  |
| 2089 | 6  | 6  | 6  | 1  | 2  | 0  | 0  | 1  | 3  | 5  | 5  | 5  |
| 2090 | 6  | 6  | 6  | 1  | 2  | 0  | 0  | 1  | 3  | 5  | 5  | 5  |

|      | 37   | 38  | 39  | 40  | 41  | 42  | 43  | 44  | 45  | 46   | 47  | 48  |
|------|------|-----|-----|-----|-----|-----|-----|-----|-----|------|-----|-----|
| 2002 | 0    | 0   | 0   | 0   | 0   | 0   | 0   | 0   | 0   | 0    | 0   | 0   |
| 2003 | 0    | 0   | 0   | 0   | 0   | 0   | 0   | 0   | 0   | 0    | 0   | 0   |
| 2004 | 1    | 1   | 1   | 1   | 1   | 1   | 1   | 1   | 1   | 1    | 1   | 1   |
| 2005 | 3    | 3   | 3   | 3   | 3   | 3   | 3   | 3   | 3   | 3    | 3   | 3   |
| 2006 | 14   | 14  | 14  | 14  | 14  | 14  | 14  | 14  | 14  | 14   | 14  | 14  |
| 2007 | 33   | 33  | 33  | 33  | 33  | 33  | 33  | 33  | 33  | 33   | 33  | 33  |
| 2008 | 67   | 67  | 67  | 67  | 67  | 67  | 67  | 67  | 67  | 67   | 67  | 67  |
| 2009 | 128  | 128 | 128 | 128 | 128 | 128 | 128 | 128 | 128 | 128  | 128 | 128 |
| 2010 | 210  | 210 | 210 | 210 | 210 | 210 | 210 | 210 | 210 | 210  | 210 | 210 |
| 2011 | 313  | 313 | 313 | 313 | 313 | 313 | 313 | 313 | 313 | 313  | 313 | 313 |
| 2012 | 418  | 313 | 418 | 418 | 418 | 418 | 418 | 418 | 418 | 418  | 313 | 418 |
| 2013 | 547  | 313 | 547 | 547 | 547 | 547 | 547 | 547 | 547 | 547  | 313 | 547 |
| 2014 | 665  | 313 | 665 | 665 | 665 | 665 | 665 | 665 | 665 | 665  | 313 | 665 |
| 2015 | 814  | 313 | 814 | 814 | 814 | 814 | 814 | 814 | 814 | 814  | 313 | 814 |
| 2016 | 957  | 313 | 814 | 814 | 814 | 814 | 814 | 814 | 814 | 957  | 313 | 814 |
| 2017 | 1109 | 313 | 814 | 814 | 814 | 814 | 814 | 814 | 814 | 1109 | 313 | 814 |
| 2018 | 1276 | 313 | 814 | 814 | 814 | 814 | 814 | 814 | 814 | 1276 | 313 | 814 |
| 2019 | 1449 | 313 | 814 | 814 | 814 | 814 | 814 | 814 | 814 | 1449 | 313 | 814 |
| 2020 | 1449 | 313 | 814 | 814 | 814 | 814 | 814 | 814 | 814 | 1449 | 313 | 814 |
| 2021 | 1449 | 313 | 814 | 809 | 814 | 814 | 814 | 814 | 814 | 1449 | 313 | 814 |
| 2022 | 1449 | 313 | 814 | 809 | 814 | 814 | 814 | 814 | 814 | 1449 | 313 | 814 |
| 2023 | 1449 | 313 | 814 | 798 | 814 | 814 | 814 | 814 | 814 | 1449 | 313 | 814 |
| 2024 | 1449 | 313 | 814 | 786 | 814 | 814 | 814 | 814 | 814 | 1449 | 313 | 814 |
| 2025 | 1449 | 313 | 814 | 773 | 814 | 814 | 814 | 814 | 814 | 1449 | 313 | 814 |
| 2026 | 1442 | 309 | 814 | 752 | 810 | 791 | 807 | 807 | 807 | 1442 | 307 | 814 |
| 2027 | 1433 | 307 | 814 | 736 | 801 | 770 | 801 | 801 | 801 | 1434 | 304 | 814 |
| 2028 | 1424 | 298 | 814 | 711 | 796 | 754 | 792 | 792 | 792 | 1430 | 300 | 814 |
| 2029 | 1402 | 281 | 814 | 690 | 780 | 730 | 772 | 772 | 772 | 1420 | 296 | 814 |
| 2030 | 1389 | 274 | 814 | 650 | 762 | 715 | 757 | 757 | 757 | 1405 | 284 | 814 |
| 2031 | 1372 | 262 | 812 | 605 | 746 | 697 | 741 | 741 | 741 | 1392 | 277 | 809 |
| 2032 | 1328 | 245 | 798 | 574 | 725 | 689 | 707 | 707 | 707 | 1371 | 274 | 804 |
| 2033 | 1292 | 229 | 785 | 543 | 710 | 665 | 682 | 682 | 682 | 1350 | 269 | 792 |
| 2034 | 1252 | 211 | 772 | 511 | 691 | 650 | 657 | 657 | 657 | 1329 | 263 | 785 |
| 2035 | 1224 | 193 | 752 | 496 | 675 | 629 | 632 | 632 | 632 | 1301 | 254 | 770 |
| 2036 | 1173 | 168 | 723 | 479 | 642 | 587 | 591 | 591 | 591 | 1271 | 230 | 758 |
| 2037 | 1139 | 162 | 688 | 468 | 612 | 556 | 566 | 566 | 566 | 1242 | 221 | 731 |
| 2038 | 1121 | 162 | 655 | 446 | 600 | 535 | 550 | 550 | 550 | 1193 | 207 | 711 |
| 2039 | 1088 | 162 | 627 | 439 | 587 | 507 | 535 | 535 | 535 | 1140 | 194 | 686 |
| 2040 | 1059 | 162 | 613 | 439 | 582 | 483 | 516 | 516 | 516 | 1111 | 181 | 665 |
| 2041 | 1028 | 160 | 581 | 439 | 560 | 473 | 498 | 498 | 498 | 1082 | 162 | 642 |
| 2042 | 990  | 159 | 554 | 426 | 526 | 462 | 486 | 486 | 486 | 1058 | 160 | 632 |
| 2043 | 953  | 155 | 536 | 405 | 504 | 458 | 476 | 476 | 476 | 1022 | 160 | 611 |
| 2044 | 911  | 155 | 531 | 392 | 486 | 457 | 462 | 462 | 462 | 975  | 159 | 587 |
| 2045 | 885  | 152 | 531 | 385 | 477 | 452 | 453 | 453 | 453 | 953  | 159 | 575 |
| 2046 | 868  | 149 | 528 | 380 | 468 | 439 | 446 | 446 | 446 | 927  | 155 | 571 |
| 2047 | 853  | 148 | 518 | 369 | 459 | 423 | 437 | 437 | 437 | 855  | 150 | 570 |
| 2048 | 837  | 142 | 500 | 363 | 446 | 399 | 425 | 425 | 425 | 739  | 139 | 547 |
| 2049 | 810  | 140 | 468 | 250 | 397 | 338 | 409 | 409 | 409 | 627  | 123 | 515 |
| 2050 | 676  | 128 | 437 | 136 | 349 | 275 | 355 | 355 | 355 | 512  | 108 | 473 |
| 2051 | 563  | 113 | 403 | 66  | 291 | 200 | 292 | 292 | 292 | 384  | 89  | 432 |
| 2052 | 435  | 95  | 368 | 39  | 223 | 134 | 224 | 224 | 224 | 241  | 66  | 398 |
| 2053 | 308  | 74  | 328 | 20  | 151 | 77  | 159 | 159 | 159 | 140  | 43  | 357 |
| 2054 | 181  | 51  | 280 | 8   | 86  | 43  | 93  | 93  | 93  | 77   | 27  | 308 |
| 2055 | 102  | 32  | 228 | 1   | 48  | 23  | 52  | 52  | 52  | 40   | 15  | 261 |
| 2056 | 54   | 18  | 167 | 1   | 27  | 9   | 26  | 26  | 26  | 17   | 10  | 203 |
| 2057 | 25   | 10  | 117 | 1   | 12  | 4   | 9   | 9   | 9   | 6    | 2   | 148 |
| 2058 | 11   | 2   | 83  | 1   | 4   | 0   | 4   | 4   | 4   | 6    | 0   | 101 |
| 2059 | 4    | 0   | 62  | 1   | 4   | 0   | 4   | 4   | 4   | 6    | 0   | 70  |
| 2060 | 4    | 0   | 46  | 1   | 1   | 0   | 4   | 4   | 4   | 6    | 0   | 50  |
| 2061 | 1    | 0   | 33  | 1   | 1   | 0   | 4   | 4   | 4   | 6    | 0   | 35  |
| 2062 | 1    | 0   | 21  | 1   | 1   | 0   | 4   | 4   | 4   | 6    | 0   | 24  |
| 2063 | 1    | 0   | 8   | 1   | 1   | 0   | 4   | 4   | 4   | 6    | 0   | 11  |
| 2064 | 1    | 0   | 3   | 1   | 1   | 0   | 4   | 4   | 4   | 6    | 0   | 4   |
| 2065 | 1    | 0   | 3   | 1   | 1   | 0   | 4   | 4   | 4   | 6    | 0   | 2   |
| 2066 | 1    | 0   | 3   | 1   | 1   | 0   | 4   | 4   | 4   | 6    | 0   | 2   |
| 2067 | 1    | 0   | 3   | 1   | 1   | 0   | 4   | 4   | 4   | 6    | 0   | 0   |
| 2068 | 1    | 0   | 3   | 1   | 1   | 0   | 4   | 4   | 4   | 6    | 0   | 0   |

|      | 37 | 38 | 39 | 40 | 41 | 42 | 43 | 44 | 45 | 46 | 47 | 48 |
|------|----|----|----|----|----|----|----|----|----|----|----|----|
| 2069 | 1  | 0  | 3  | 1  | 1  | 0  | 4  | 4  | 4  | 6  | 0  | 0  |
| 2070 | 1  | 0  | 3  | 1  | 1  | 0  | 4  | 4  | 4  | 6  | 0  | 0  |
| 2071 | 1  | 0  | 3  | 1  | 1  | 0  | 4  | 4  | 4  | 6  | 0  | 0  |
| 2072 | 1  | 0  | 3  | 1  | 1  | 0  | 4  | 4  | 4  | 6  | 0  | 0  |
| 2073 | 1  | 0  | 3  | 1  | 1  | 0  | 4  | 4  | 4  | 6  | 0  | 0  |
| 2074 | 1  | 0  | 3  | 1  | 1  | 0  | 4  | 4  | 4  | 6  | 0  | 0  |
| 2075 | 1  | 0  | 3  | 1  | 1  | 0  | 4  | 4  | 4  | 6  | 0  | 0  |
| 2076 | 1  | 0  | 3  | 1  | 1  | 0  | 4  | 4  | 4  | 6  | 0  | 0  |
| 2077 | 1  | 0  | 3  | 1  | 1  | 0  | 4  | 4  | 4  | 6  | 0  | 0  |
| 2078 | 1  | 0  | 3  | 1  | 1  | 0  | 4  | 4  | 4  | 6  | 0  | 0  |
| 2079 | 1  | 0  | 3  | 1  | 1  | 0  | 4  | 4  | 4  | 6  | 0  | 0  |
| 2080 | 1  | 0  | 3  | 1  | 1  | 0  | 4  | 4  | 4  | 6  | 0  | 0  |
| 2081 | 1  | 0  | 3  | 1  | 1  | 0  | 4  | 4  | 4  | 6  | 0  | 0  |
| 2082 | 1  | 0  | 3  | 1  | 1  | 0  | 4  | 4  | 4  | 6  | 0  | 0  |
| 2083 | 1  | 0  | 3  | 1  | 1  | 0  | 4  | 4  | 4  | 6  | 0  | 0  |
| 2084 | 1  | 0  | 3  | 1  | 1  | 0  | 4  | 4  | 4  | 6  | 0  | 0  |
| 2085 | 1  | 0  | 3  | 1  | 1  | 0  | 4  | 4  | 4  | 6  | 0  | 0  |
| 2086 | 1  | 0  | 3  | 1  | 1  | 0  | 4  | 4  | 4  | 6  | 0  | 0  |
| 2087 | 1  | 0  | 3  | 1  | 1  | 0  | 4  | 4  | 4  | 6  | 0  | 0  |
| 2088 | 1  | 0  | 3  | 1  | 1  | 0  | 4  | 4  | 4  | 6  | 0  | 0  |
| 2089 | 1  | 0  | 3  | 1  | 1  | 0  | 4  | 4  | 4  | 6  | 0  | 0  |
| 2090 | 1  | 0  | 3  | 1  | 1  | 0  | 4  | 4  | 4  | 6  | 0  | 0  |

|      | 49  | 50  | 51  | 52  | 53  | 54  | 55  | 56   | 57  | 58  | 59  | 60  |
|------|-----|-----|-----|-----|-----|-----|-----|------|-----|-----|-----|-----|
| 2002 | 0   | 0   | 0   | 0   | 0   | 0   | 0   | 0    | 0   | 0   | 0   | 0   |
| 2003 | 0   | 0   | 0   | 0   | 0   | 0   | 0   | 0    | 0   | 0   | 0   | 0   |
| 2004 | 1   | 1   | 1   | 1   | 1   | 1   | 1   | 1    | 1   | 1   | 1   | 1   |
| 2005 | 3   | 3   | 3   | 3   | 3   | 3   | 3   | 3    | 3   | 3   | 3   | 3   |
| 2006 | 14  | 14  | 14  | 14  | 14  | 14  | 14  | 14   | 14  | 14  | 14  | 14  |
| 2007 | 33  | 33  | 33  | 33  | 33  | 33  | 33  | 33   | 33  | 33  | 33  | 33  |
| 2008 | 67  | 67  | 67  | 67  | 67  | 67  | 67  | 67   | 67  | 67  | 67  | 67  |
| 2009 | 128 | 128 | 128 | 128 | 128 | 128 | 128 | 128  | 128 | 128 | 128 | 128 |
| 2010 | 210 | 210 | 210 | 210 | 210 | 210 | 210 | 210  | 210 | 210 | 210 | 210 |
| 2011 | 313 | 313 | 313 | 313 | 313 | 313 | 313 | 313  | 313 | 313 | 313 | 313 |
| 2012 | 418 | 418 | 418 | 418 | 418 | 418 | 418 | 313  | 418 | 418 | 418 | 418 |
| 2013 | 547 | 547 | 547 | 547 | 547 | 547 | 547 | 313  | 547 | 547 | 547 | 547 |
| 2014 | 665 | 665 | 665 | 665 | 665 | 665 | 665 | 313  | 665 | 665 | 665 | 665 |
| 2015 | 814 | 814 | 814 | 814 | 814 | 814 | 814 | 313  | 814 | 814 | 814 | 814 |
| 2016 | 814 | 814 | 814 | 814 | 814 | 814 | 814 | 957  | 313 | 814 | 814 | 814 |
| 2017 | 814 | 814 | 814 | 814 | 814 | 814 | 814 | 1109 | 313 | 814 | 814 | 814 |
| 2018 | 814 | 814 | 814 | 814 | 814 | 814 | 814 | 1276 | 313 | 814 | 814 | 814 |
| 2019 | 814 | 814 | 814 | 814 | 814 | 814 | 814 | 1449 | 313 | 814 | 814 | 814 |
| 2020 | 814 | 814 | 814 | 814 | 814 | 814 | 814 | 1449 | 313 | 814 | 814 | 814 |
| 2021 | 807 | 814 | 814 | 814 | 814 | 814 | 814 | 1449 | 313 | 814 | 784 | 814 |
| 2022 | 806 | 814 | 814 | 814 | 814 | 814 | 814 | 1449 | 313 | 814 | 730 | 814 |
| 2023 | 796 | 814 | 814 | 814 | 814 | 814 | 814 | 1449 | 313 | 814 | 697 | 814 |
| 2024 | 790 | 814 | 814 | 814 | 814 | 814 | 814 | 1449 | 313 | 814 | 649 | 814 |
| 2025 | 783 | 814 | 814 | 814 | 814 | 814 | 814 | 1449 | 313 | 814 | 629 | 814 |
| 2026 | 768 | 810 | 800 | 807 | 807 | 807 | 807 | 1428 | 313 | 814 | 604 | 814 |
| 2027 | 752 | 806 | 788 | 799 | 799 | 799 | 799 | 1386 | 313 | 814 | 566 | 804 |
| 2028 | 736 | 803 | 771 | 795 | 795 | 795 | 795 | 1325 | 307 | 814 | 509 | 801 |
| 2029 | 729 | 796 | 750 | 790 | 790 | 790 | 790 | 1246 | 307 | 814 | 492 | 766 |
| 2030 | 721 | 788 | 728 | 775 | 775 | 775 | 775 | 1165 | 295 | 814 | 472 | 724 |
| 2031 | 700 | 785 | 708 | 764 | 764 | 764 | 764 | 1106 | 295 | 814 | 456 | 700 |
| 2032 | 685 | 765 | 690 | 753 | 753 | 753 | 753 | 1031 | 276 | 814 | 445 | 652 |
| 2033 | 637 | 750 | 674 | 734 | 734 | 734 | 734 | 953  | 260 | 804 | 435 | 596 |
| 2034 | 615 | 733 | 659 | 724 | 724 | 724 | 724 | 904  | 230 | 791 | 415 | 558 |
| 2035 | 586 | 714 | 637 | 710 | 710 | 710 | 710 | 869  | 229 | 784 | 405 | 537 |
| 2036 | 559 | 700 | 589 | 681 | 681 | 681 | 681 | 851  | 220 | 774 | 375 | 516 |
| 2037 | 540 | 678 | 564 | 657 | 657 | 657 | 657 | 826  | 220 | 724 | 370 | 506 |
| 2038 | 513 | 657 | 541 | 619 | 619 | 619 | 619 | 810  | 210 | 663 | 370 | 495 |
| 2039 | 487 | 628 | 523 | 591 | 591 | 591 | 591 | 780  | 200 | 617 | 341 | 473 |
| 2040 | 454 | 619 | 497 | 574 | 574 | 574 | 574 | 753  | 198 | 576 | 339 | 463 |
| 2041 | 444 | 597 | 487 | 553 | 553 | 553 | 553 | 737  | 196 | 547 | 329 | 463 |
| 2042 | 439 | 579 | 480 | 533 | 533 | 533 | 533 | 723  | 196 | 537 | 322 | 463 |
| 2043 | 439 | 562 | 466 | 512 | 512 | 512 | 512 | 720  | 196 | 525 | 303 | 463 |
| 2044 | 437 | 546 | 463 | 492 | 492 | 492 | 492 | 700  | 196 | 515 | 247 | 463 |
| 2045 | 380 | 541 | 448 | 486 | 486 | 486 | 486 | 675  | 196 | 495 | 153 | 453 |
| 2046 | 272 | 521 | 438 | 475 | 475 | 475 | 475 | 579  | 192 | 474 | 73  | 405 |
| 2047 | 163 | 487 | 415 | 451 | 451 | 451 | 451 | 431  | 183 | 467 | 6   | 336 |
| 2048 | 83  | 430 | 360 | 400 | 400 | 400 | 400 | 272  | 157 | 463 | 6   | 286 |
| 2049 | 39  | 380 | 295 | 345 | 345 | 345 | 345 | 159  | 147 | 453 | 0   | 206 |
| 2050 | 19  | 336 | 228 | 290 | 290 | 290 | 290 | 77   | 101 | 443 | 0   | 116 |
| 2051 | 7   | 270 | 160 | 222 | 222 | 222 | 222 | 29   | 32  | 345 | 0   | 39  |
| 2052 | 7   | 204 | 95  | 151 | 151 | 151 | 151 | 8    | 19  | 328 | 0   | 17  |
| 2053 | 1   | 137 | 55  | 91  | 91  | 91  | 91  | 5    | 13  | 308 | 0   | 15  |
| 2054 | 1   | 89  | 29  | 48  | 48  | 48  | 48  | 5    | 6   | 287 | 0   | 3   |
| 2055 | 1   | 54  | 14  | 27  | 27  | 27  | 27  | 5    | 4   | 224 | 0   | 3   |
| 2056 | 1   | 29  | 8   | 12  | 12  | 12  | 12  | 5    | 0   | 153 | 0   | 3   |
| 2057 | 1   | 14  | 2   | 5   | 5   | 5   | 5   | 5    | 0   | 79  | 0   | 3   |
| 2058 | 1   | 4   | 2   | 5   | 5   | 5   | 5   | 5    | 0   | 27  | 0   | 3   |
| 2059 | 1   | 4   | 1   | 1   | 1   | 1   | 1   | 5    | 0   | 14  | 0   | 3   |
| 2060 | 1   | 4   | 1   | 1   | 1   | 1   | 1   | 5    | 0   | 11  | 0   | 3   |
| 2061 | 1   | 4   | 1   | 1   | 1   | 1   | 1   | 5    | 0   | 2   | 0   | 3   |
| 2062 | 1   | 4   | 1   | 1   | 1   | 1   | 1   | 5    | 0   | 2   | 0   | 3   |
| 2063 | 1   | 4   | 1   | 1   | 1   | 1   | 1   | 5    | 0   | 2   | 0   | 3   |
| 2064 | 1   | 4   | 1   | 1   | 1   | 1   | 1   | 5    | 0   | 2   | 0   | 3   |
| 2065 | 1   | 4   | 1   | 1   | 1   | 1   | 1   | 5    | 0   | 2   | 0   | 3   |
| 2066 | 1   | 4   | 1   | 1   | 1   | 1   | 1   | 5    | 0   | 2   | 0   | 3   |
| 2067 | 1   | 4   | 1   | 1   | 1   | 1   | 1   | 5    | 0   | 2   | 0   | 3   |
| 2068 | 1   | 4   | 1   | 1   | 1   | 1   | 1   | 5    | 0   | 2   | 0   | 3   |

|      | 49 | 50 | 51 | 52 | 53 | 54 | 55 | 56 | 57 | 58 | 59 | 60 |
|------|----|----|----|----|----|----|----|----|----|----|----|----|
| 2069 | 1  | 4  | 1  | 1  | 1  | 1  | 5  | 0  | 2  | 0  | 3  | 1  |
| 2070 | 1  | 4  | 1  | 1  | 1  | 1  | 5  | 0  | 2  | 0  | 3  | 1  |
| 2071 | 1  | 4  | 1  | 1  | 1  | 1  | 5  | 0  | 2  | 0  | 3  | 1  |
| 2072 | 1  | 4  | 1  | 1  | 1  | 1  | 5  | 0  | 2  | 0  | 3  | 1  |
| 2073 | 1  | 4  | 1  | 1  | 1  | 1  | 5  | 0  | 2  | 0  | 3  | 1  |
| 2074 | 1  | 4  | 1  | 1  | 1  | 1  | 5  | 0  | 2  | 0  | 3  | 1  |
| 2075 | 1  | 4  | 1  | 1  | 1  | 1  | 5  | 0  | 2  | 0  | 3  | 1  |
| 2076 | 1  | 4  | 1  | 1  | 1  | 1  | 5  | 0  | 2  | 0  | 3  | 1  |
| 2077 | 1  | 4  | 1  | 1  | 1  | 1  | 5  | 0  | 2  | 0  | 3  | 1  |
| 2078 | 1  | 4  | 1  | 1  | 1  | 1  | 5  | 0  | 2  | 0  | 3  | 1  |
| 2079 | 1  | 4  | 1  | 1  | 1  | 1  | 5  | 0  | 2  | 0  | 3  | 1  |
| 2080 | 1  | 4  | 1  | 1  | 1  | 1  | 5  | 0  | 2  | 0  | 3  | 1  |
| 2081 | 1  | 4  | 1  | 1  | 1  | 1  | 5  | 0  | 2  | 0  | 3  | 1  |
| 2082 | 1  | 4  | 1  | 1  | 1  | 1  | 5  | 0  | 2  | 0  | 3  | 1  |
| 2083 | 1  | 4  | 1  | 1  | 1  | 1  | 5  | 0  | 2  | 0  | 3  | 1  |
| 2084 | 1  | 4  | 1  | 1  | 1  | 1  | 5  | 0  | 2  | 0  | 3  | 1  |
| 2085 | 1  | 4  | 1  | 1  | 1  | 1  | 5  | 0  | 2  | 0  | 3  | 1  |
| 2086 | 1  | 4  | 1  | 1  | 1  | 1  | 5  | 0  | 2  | 0  | 3  | 1  |
| 2087 | 1  | 4  | 1  | 1  | 1  | 1  | 5  | 0  | 2  | 0  | 3  | 1  |
| 2088 | 1  | 4  | 1  | 1  | 1  | 1  | 5  | 0  | 2  | 0  | 3  | 1  |
| 2089 | 1  | 4  | 1  | 1  | 1  | 1  | 5  | 0  | 2  | 0  | 3  | 1  |
| 2090 | 1  | 4  | 1  | 1  | 1  | 1  | 5  | 0  | 2  | 0  | 3  | 1  |

|      | 61  | 62  | 63  | 64   | 65  | 66  | 67  | 68  | 69  | 70  | 71  | 72  |
|------|-----|-----|-----|------|-----|-----|-----|-----|-----|-----|-----|-----|
| 2002 | 0   | 0   | 0   | 0    | 0   | 0   | 0   | 0   | 0   | 0   | 0   | 0   |
| 2003 | 0   | 0   | 0   | 0    | 0   | 0   | 0   | 0   | 0   | 0   | 0   | 0   |
| 2004 | 1   | 1   | 1   | 1    | 1   | 1   | 1   | 1   | 1   | 1   | 1   | 1   |
| 2005 | 3   | 3   | 3   | 3    | 3   | 3   | 3   | 3   | 3   | 3   | 3   | 3   |
| 2006 | 14  | 14  | 14  | 14   | 14  | 14  | 14  | 14  | 14  | 14  | 14  | 14  |
| 2007 | 33  | 33  | 33  | 33   | 33  | 33  | 33  | 33  | 33  | 33  | 33  | 33  |
| 2008 | 67  | 67  | 67  | 67   | 67  | 67  | 67  | 67  | 67  | 67  | 67  | 67  |
| 2009 | 128 | 128 | 128 | 128  | 128 | 128 | 128 | 128 | 128 | 128 | 128 | 128 |
| 2010 | 210 | 210 | 210 | 210  | 210 | 210 | 210 | 210 | 210 | 210 | 210 | 210 |
| 2011 | 313 | 313 | 313 | 313  | 313 | 313 | 313 | 313 | 313 | 313 | 313 | 313 |
| 2012 | 418 | 418 | 418 | 418  | 313 | 418 | 418 | 418 | 418 | 418 | 418 | 418 |
| 2013 | 547 | 547 | 547 | 547  | 313 | 547 | 547 | 547 | 547 | 547 | 547 | 547 |
| 2014 | 665 | 665 | 665 | 665  | 313 | 665 | 665 | 665 | 665 | 665 | 665 | 665 |
| 2015 | 814 | 814 | 814 | 814  | 313 | 814 | 814 | 814 | 814 | 814 | 814 | 814 |
| 2016 | 814 | 814 | 814 | 957  | 313 | 814 | 814 | 814 | 814 | 814 | 814 | 814 |
| 2017 | 814 | 814 | 814 | 1109 | 313 | 814 | 814 | 814 | 814 | 814 | 814 | 814 |
| 2018 | 814 | 814 | 814 | 1276 | 313 | 814 | 814 | 814 | 814 | 814 | 814 | 814 |
| 2019 | 814 | 814 | 814 | 1449 | 313 | 814 | 814 | 814 | 814 | 814 | 814 | 814 |
| 2020 | 814 | 814 | 814 | 1449 | 313 | 814 | 814 | 814 | 814 | 814 | 814 | 814 |
| 2021 | 814 | 814 | 814 | 1449 | 313 | 814 | 725 | 814 | 814 | 814 | 814 | 814 |
| 2022 | 814 | 814 | 814 | 1449 | 313 | 814 | 653 | 814 | 814 | 814 | 814 | 814 |
| 2023 | 814 | 814 | 814 | 1449 | 313 | 814 | 601 | 814 | 814 | 814 | 814 | 814 |
| 2024 | 814 | 814 | 814 | 1449 | 313 | 814 | 555 | 814 | 814 | 814 | 814 | 814 |
| 2025 | 814 | 814 | 814 | 1449 | 313 | 814 | 539 | 814 | 814 | 814 | 814 | 814 |
| 2026 | 814 | 814 | 814 | 1395 | 313 | 814 | 519 | 813 | 813 | 813 | 813 | 813 |
| 2027 | 804 | 804 | 804 | 1310 | 313 | 814 | 493 | 783 | 783 | 783 | 783 | 783 |
| 2028 | 801 | 801 | 801 | 1202 | 313 | 814 | 483 | 744 | 744 | 744 | 744 | 744 |
| 2029 | 766 | 766 | 766 | 1113 | 283 | 814 | 456 | 675 | 666 | 675 | 675 | 675 |
| 2030 | 724 | 724 | 724 | 1047 | 263 | 814 | 432 | 618 | 617 | 618 | 618 | 618 |
| 2031 | 700 | 700 | 700 | 990  | 242 | 814 | 430 | 595 | 594 | 595 | 595 | 595 |
| 2032 | 652 | 652 | 652 | 950  | 236 | 814 | 407 | 582 | 572 | 572 | 572 | 572 |
| 2033 | 596 | 596 | 596 | 897  | 228 | 804 | 396 | 548 | 528 | 531 | 531 | 531 |
| 2034 | 558 | 558 | 558 | 867  | 214 | 781 | 366 | 522 | 496 | 499 | 499 | 499 |
| 2035 | 537 | 537 | 537 | 850  | 204 | 700 | 353 | 502 | 486 | 489 | 489 | 489 |
| 2036 | 516 | 516 | 516 | 819  | 184 | 649 | 346 | 464 | 454 | 457 | 457 | 457 |
| 2037 | 506 | 506 | 506 | 795  | 165 | 608 | 346 | 444 | 442 | 442 | 442 | 442 |
| 2038 | 495 | 495 | 495 | 772  | 153 | 581 | 346 | 434 | 432 | 432 | 432 | 432 |
| 2039 | 473 | 473 | 473 | 755  | 150 | 552 | 336 | 428 | 418 | 428 | 428 | 428 |
| 2040 | 463 | 463 | 463 | 745  | 150 | 540 | 336 | 418 | 407 | 418 | 418 | 418 |
| 2041 | 463 | 463 | 463 | 725  | 140 | 518 | 336 | 398 | 397 | 398 | 398 | 398 |
| 2042 | 453 | 453 | 453 | 704  | 132 | 498 | 326 | 387 | 377 | 387 | 387 | 387 |
| 2043 | 453 | 453 | 453 | 684  | 132 | 448 | 316 | 385 | 355 | 385 | 385 | 385 |
| 2044 | 443 | 443 | 443 | 664  | 128 | 424 | 304 | 365 | 346 | 365 | 365 | 365 |
| 2045 | 433 | 433 | 433 | 654  | 118 | 404 | 300 | 358 | 346 | 353 | 353 | 353 |
| 2046 | 394 | 394 | 394 | 652  | 117 | 402 | 195 | 358 | 346 | 346 | 346 | 346 |
| 2047 | 335 | 335 | 335 | 652  | 117 | 402 | 108 | 350 | 346 | 346 | 346 | 346 |
| 2048 | 266 | 266 | 266 | 644  | 117 | 392 | 64  | 350 | 336 | 346 | 346 | 346 |
| 2049 | 174 | 174 | 174 | 601  | 117 | 383 | 35  | 346 | 254 | 346 | 346 | 346 |
| 2050 | 86  | 86  | 86  | 452  | 117 | 383 | 16  | 319 | 161 | 309 | 309 | 309 |
| 2051 | 29  | 29  | 29  | 259  | 105 | 373 | 6   | 205 | 131 | 201 | 201 | 201 |
| 2052 | 7   | 7   | 7   | 136  | 71  | 363 | 0   | 150 | 91  | 140 | 140 | 140 |
| 2053 | 5   | 5   | 5   | 84   | 51  | 297 | 0   | 104 | 54  | 101 | 101 | 101 |
| 2054 | 2   | 2   | 2   | 48   | 41  | 227 | 0   | 64  | 25  | 64  | 64  | 64  |
| 2055 | 2   | 2   | 2   | 21   | 22  | 168 | 0   | 35  | 6   | 35  | 35  | 35  |
| 2056 | 0   | 0   | 0   | 10   | 11  | 106 | 0   | 16  | 0   | 16  | 16  | 16  |
| 2057 | 0   | 0   | 0   | 1    | 1   | 74  | 0   | 6   | 0   | 6   | 6   | 6   |
| 2058 | 0   | 0   | 0   | 1    | 1   | 45  | 0   | 1   | 0   | 1   | 1   | 1   |
| 2059 | 0   | 0   | 0   | 1    | 1   | 26  | 0   | 1   | 0   | 1   | 1   | 1   |
| 2060 | 0   | 0   | 0   | 1    | 1   | 16  | 0   | 1   | 0   | 1   | 1   | 1   |
| 2061 | 0   | 0   | 0   | 1    | 1   | 6   | 0   | 1   | 0   | 1   | 1   | 1   |
| 2062 | 0   | 0   | 0   | 1    | 1   | 1   | 0   | 1   | 0   | 1   | 1   | 1   |
| 2063 | 0   | 0   | 0   | 1    | 1   | 1   | 0   | 1   | 0   | 1   | 1   | 1   |
| 2064 | 0   | 0   | 0   | 1    | 1   | 1   | 0   | 1   | 0   | 1   | 1   | 1   |
| 2065 | 0   | 0   | 0   | 1    | 1   | 1   | 0   | 1   | 0   | 1   | 1   | 1   |
| 2066 | 0   | 0   | 0   | 1    | 1   | 1   | 0   | 1   | 0   | 1   | 1   | 1   |
| 2067 | 0   | 0   | 0   | 1    | 1   | 1   | 0   | 1   | 0   | 1   | 1   | 1   |
| 2068 | 0   | 0   | 0   | 1    | 1   | 1   | 0   | 1   | 0   | 1   | 1   | 1   |

|      | 61 | 62 | 63 | 64 | 65 | 66 | 67 | 68 | 69 | 70 | 71 | 72 |
|------|----|----|----|----|----|----|----|----|----|----|----|----|
| 2069 | 0  | 0  | 0  | 1  | 1  | 1  | 0  | 1  | 0  | 1  | 1  | 1  |
| 2070 | 0  | 0  | 0  | 1  | 1  | 1  | 0  | 1  | 0  | 1  | 1  | 1  |
| 2071 | 0  | 0  | 0  | 1  | 1  | 1  | 0  | 1  | 0  | 1  | 1  | 1  |
| 2072 | 0  | 0  | 0  | 1  | 1  | 1  | 0  | 1  | 0  | 1  | 1  | 1  |
| 2073 | 0  | 0  | 0  | 1  | 1  | 1  | 0  | 1  | 0  | 1  | 1  | 1  |
| 2074 | 0  | 0  | 0  | 1  | 1  | 1  | 0  | 1  | 0  | 1  | 1  | 1  |
| 2075 | 0  | 0  | 0  | 1  | 1  | 1  | 0  | 1  | 0  | 1  | 1  | 1  |
| 2076 | 0  | 0  | 0  | 1  | 1  | 1  | 0  | 1  | 0  | 1  | 1  | 1  |
| 2077 | 0  | 0  | 0  | 1  | 1  | 1  | 0  | 1  | 0  | 1  | 1  | 1  |
| 2078 | 0  | 0  | 0  | 1  | 1  | 1  | 0  | 1  | 0  | 1  | 1  | 1  |
| 2079 | 0  | 0  | 0  | 1  | 1  | 1  | 0  | 1  | 0  | 1  | 1  | 1  |
| 2080 | 0  | 0  | 0  | 1  | 1  | 1  | 0  | 1  | 0  | 1  | 1  | 1  |
| 2081 | 0  | 0  | 0  | 1  | 1  | 1  | 0  | 1  | 0  | 1  | 1  | 1  |
| 2082 | 0  | 0  | 0  | 1  | 1  | 1  | 0  | 1  | 0  | 1  | 1  | 1  |
| 2083 | 0  | 0  | 0  | 1  | 1  | 1  | 0  | 1  | 0  | 1  | 1  | 1  |
| 2084 | 0  | 0  | 0  | 1  | 1  | 1  | 0  | 1  | 0  | 1  | 1  | 1  |
| 2085 | 0  | 0  | 0  | 1  | 1  | 1  | 0  | 1  | 0  | 1  | 1  | 1  |
| 2086 | 0  | 0  | 0  | 1  | 1  | 1  | 0  | 1  | 0  | 1  | 1  | 1  |
| 2087 | 0  | 0  | 0  | 1  | 1  | 1  | 0  | 1  | 0  | 1  | 1  | 1  |
| 2088 | 0  | 0  | 0  | 1  | 1  | 1  | 0  | 1  | 0  | 1  | 1  | 1  |
| 2089 | 0  | 0  | 0  | 1  | 1  | 1  | 0  | 1  | 0  | 1  | 1  | 1  |
| 2090 | 0  | 0  | 0  | 1  | 1  | 1  | 0  | 1  | 0  | 1  | 1  | 1  |



|      | 73   | 74  | 75  | 76  | 77  | 78  | 79  | 80  | 81  | 82   | 83  | 84  |
|------|------|-----|-----|-----|-----|-----|-----|-----|-----|------|-----|-----|
| 2002 | 0    | 0   | 0   | 0   | 0   | 0   | 0   | 0   | 0   | 0    | 0   | 0   |
| 2003 | 0    | 0   | 0   | 0   | 0   | 0   | 0   | 0   | 0   | 0    | 0   | 0   |
| 2004 | 1    | 1   | 1   | 1   | 1   | 1   | 1   | 1   | 1   | 1    | 1   | 1   |
| 2005 | 3    | 3   | 3   | 3   | 3   | 3   | 3   | 3   | 3   | 3    | 3   | 3   |
| 2006 | 14   | 14  | 14  | 14  | 14  | 14  | 14  | 14  | 14  | 14   | 14  | 14  |
| 2007 | 33   | 33  | 33  | 33  | 33  | 33  | 33  | 33  | 33  | 33   | 33  | 33  |
| 2008 | 67   | 67  | 67  | 67  | 67  | 67  | 67  | 67  | 67  | 67   | 67  | 67  |
| 2009 | 128  | 128 | 128 | 128 | 128 | 128 | 128 | 128 | 128 | 128  | 128 | 128 |
| 2010 | 210  | 210 | 210 | 210 | 210 | 210 | 210 | 210 | 210 | 210  | 210 | 210 |
| 2011 | 313  | 313 | 313 | 313 | 313 | 313 | 313 | 313 | 313 | 313  | 313 | 313 |
| 2012 | 418  | 313 | 418 | 418 | 418 | 418 | 418 | 418 | 418 | 418  | 313 | 418 |
| 2013 | 547  | 313 | 547 | 547 | 547 | 547 | 547 | 547 | 547 | 547  | 313 | 547 |
| 2014 | 665  | 313 | 665 | 665 | 665 | 665 | 665 | 665 | 665 | 665  | 313 | 665 |
| 2015 | 814  | 313 | 814 | 814 | 814 | 814 | 814 | 814 | 814 | 814  | 313 | 814 |
| 2016 | 957  | 313 | 814 | 814 | 814 | 814 | 814 | 814 | 814 | 957  | 313 | 814 |
| 2017 | 1109 | 313 | 814 | 814 | 814 | 814 | 814 | 814 | 814 | 1109 | 313 | 814 |
| 2018 | 1276 | 313 | 814 | 814 | 814 | 814 | 814 | 814 | 814 | 1276 | 313 | 814 |
| 2019 | 1449 | 313 | 814 | 814 | 814 | 814 | 814 | 814 | 814 | 1449 | 313 | 814 |
| 2020 | 1449 | 313 | 814 | 814 | 814 | 814 | 814 | 814 | 814 | 1449 | 313 | 814 |
| 2021 | 1449 | 313 | 814 | 725 | 814 | 814 | 814 | 814 | 814 | 1449 | 313 | 814 |
| 2022 | 1449 | 313 | 814 | 653 | 814 | 814 | 814 | 814 | 814 | 1449 | 313 | 814 |
| 2023 | 1449 | 313 | 814 | 601 | 814 | 814 | 814 | 814 | 814 | 1449 | 313 | 814 |
| 2024 | 1449 | 313 | 814 | 555 | 814 | 814 | 814 | 814 | 814 | 1449 | 313 | 814 |
| 2025 | 1449 | 313 | 814 | 539 | 814 | 814 | 814 | 814 | 814 | 1449 | 313 | 814 |
| 2026 | 1395 | 313 | 814 | 519 | 813 | 813 | 813 | 813 | 813 | 1408 | 308 | 814 |
| 2027 | 1310 | 313 | 814 | 497 | 783 | 783 | 783 | 783 | 783 | 1340 | 300 | 814 |
| 2028 | 1202 | 313 | 814 | 487 | 744 | 744 | 744 | 744 | 744 | 1279 | 291 | 814 |
| 2029 | 1113 | 283 | 814 | 460 | 665 | 669 | 675 | 675 | 675 | 1204 | 281 | 814 |
| 2030 | 1047 | 263 | 814 | 432 | 617 | 617 | 618 | 618 | 618 | 1136 | 270 | 814 |
| 2031 | 990  | 242 | 814 | 430 | 594 | 594 | 595 | 595 | 595 | 1090 | 262 | 804 |
| 2032 | 952  | 236 | 814 | 416 | 572 | 572 | 582 | 582 | 582 | 1022 | 247 | 782 |
| 2033 | 908  | 228 | 804 | 412 | 538 | 528 | 548 | 548 | 548 | 954  | 231 | 758 |
| 2034 | 882  | 224 | 781 | 392 | 521 | 496 | 517 | 517 | 517 | 903  | 220 | 732 |
| 2035 | 859  | 204 | 700 | 382 | 501 | 486 | 497 | 497 | 497 | 874  | 211 | 695 |
| 2036 | 828  | 184 | 649 | 364 | 474 | 454 | 464 | 464 | 464 | 852  | 207 | 657 |
| 2037 | 818  | 175 | 608 | 353 | 464 | 442 | 454 | 454 | 454 | 831  | 203 | 618 |
| 2038 | 788  | 153 | 581 | 346 | 444 | 432 | 434 | 434 | 434 | 814  | 201 | 586 |
| 2039 | 768  | 150 | 552 | 346 | 429 | 428 | 428 | 428 | 428 | 794  | 197 | 552 |
| 2040 | 755  | 150 | 542 | 346 | 419 | 418 | 418 | 418 | 418 | 767  | 193 | 532 |
| 2041 | 738  | 140 | 520 | 336 | 408 | 398 | 408 | 408 | 408 | 744  | 193 | 516 |
| 2042 | 708  | 132 | 498 | 326 | 388 | 387 | 388 | 388 | 388 | 739  | 193 | 511 |
| 2043 | 704  | 132 | 448 | 314 | 375 | 365 | 385 | 385 | 385 | 725  | 193 | 500 |
| 2044 | 694  | 132 | 424 | 294 | 373 | 353 | 385 | 385 | 385 | 699  | 190 | 490 |
| 2045 | 684  | 128 | 404 | 182 | 373 | 346 | 375 | 375 | 375 | 674  | 187 | 482 |
| 2046 | 666  | 128 | 395 | 85  | 363 | 346 | 373 | 373 | 373 | 531  | 158 | 468 |
| 2047 | 593  | 128 | 395 | 35  | 353 | 326 | 363 | 363 | 363 | 418  | 136 | 456 |
| 2048 | 434  | 118 | 385 | 16  | 319 | 259 | 316 | 316 | 316 | 290  | 102 | 449 |
| 2049 | 247  | 95  | 373 | 6   | 205 | 169 | 195 | 195 | 195 | 197  | 74  | 413 |
| 2050 | 132  | 71  | 373 | 6   | 140 | 134 | 148 | 148 | 148 | 126  | 49  | 369 |
| 2051 | 84   | 51  | 357 | 6   | 101 | 101 | 104 | 104 | 104 | 64   | 25  | 324 |
| 2052 | 48   | 41  | 297 | 6   | 64  | 64  | 64  | 64  | 64  | 23   | 10  | 276 |
| 2053 | 21   | 22  | 217 | 6   | 35  | 35  | 35  | 35  | 35  | 13   | 6   | 219 |
| 2054 | 10   | 11  | 159 | 6   | 16  | 16  | 16  | 16  | 16  | 9    | 4   | 170 |
| 2055 | 1    | 1   | 106 | 6   | 6   | 6   | 16  | 16  | 16  | 2    | 1   | 123 |
| 2056 | 1    | 1   | 74  | 6   | 6   | 1   | 16  | 16  | 16  | 2    | 1   | 84  |
| 2057 | 1    | 1   | 45  | 6   | 6   | 1   | 16  | 16  | 16  | 2    | 1   | 47  |
| 2058 | 1    | 1   | 26  | 6   | 6   | 1   | 16  | 16  | 16  | 2    | 1   | 25  |
| 2059 | 1    | 1   | 16  | 6   | 6   | 1   | 16  | 16  | 16  | 2    | 1   | 4   |
| 2060 | 1    | 1   | 6   | 6   | 6   | 1   | 16  | 16  | 16  | 2    | 1   | 2   |
| 2061 | 1    | 1   | 1   | 6   | 6   | 1   | 16  | 16  | 16  | 2    | 1   | 0   |
| 2062 | 1    | 1   | 1   | 6   | 6   | 1   | 16  | 16  | 16  | 2    | 1   | 0   |
| 2063 | 1    | 1   | 1   | 6   | 6   | 1   | 16  | 16  | 16  | 2    | 1   | 0   |
| 2064 | 1    | 1   | 1   | 6   | 6   | 1   | 16  | 16  | 16  | 2    | 1   | 0   |
| 2065 | 1    | 1   | 1   | 6   | 6   | 1   | 16  | 16  | 16  | 2    | 1   | 0   |
| 2066 | 1    | 1   | 1   | 6   | 6   | 1   | 16  | 16  | 16  | 2    | 1   | 0   |
| 2067 | 1    | 1   | 1   | 6   | 6   | 1   | 16  | 16  | 16  | 2    | 1   | 0   |
| 2068 | 1    | 1   | 1   | 6   | 6   | 1   | 16  | 16  | 16  | 2    | 1   | 0   |

|      | 73 | 74 | 75 | 76 | 77 | 78 | 79 | 80 | 81 | 82 | 83 | 84 |
|------|----|----|----|----|----|----|----|----|----|----|----|----|
| 2069 | 1  | 1  | 1  | 6  | 6  | 1  | 16 | 16 | 16 | 2  | 1  | 0  |
| 2070 | 1  | 1  | 1  | 6  | 6  | 1  | 16 | 16 | 16 | 2  | 1  | 0  |
| 2071 | 1  | 1  | 1  | 6  | 6  | 1  | 16 | 16 | 16 | 2  | 1  | 0  |
| 2072 | 1  | 1  | 1  | 6  | 6  | 1  | 16 | 16 | 16 | 2  | 1  | 0  |
| 2073 | 1  | 1  | 1  | 6  | 6  | 1  | 16 | 16 | 16 | 2  | 1  | 0  |
| 2074 | 1  | 1  | 1  | 6  | 6  | 1  | 16 | 16 | 16 | 2  | 1  | 0  |
| 2075 | 1  | 1  | 1  | 6  | 6  | 1  | 16 | 16 | 16 | 2  | 1  | 0  |
| 2076 | 1  | 1  | 1  | 6  | 6  | 1  | 16 | 16 | 16 | 2  | 1  | 0  |
| 2077 | 1  | 1  | 1  | 6  | 6  | 1  | 16 | 16 | 16 | 2  | 1  | 0  |
| 2078 | 1  | 1  | 1  | 6  | 6  | 1  | 16 | 16 | 16 | 2  | 1  | 0  |
| 2079 | 1  | 1  | 1  | 6  | 6  | 1  | 16 | 16 | 16 | 2  | 1  | 0  |
| 2080 | 1  | 1  | 1  | 6  | 6  | 1  | 16 | 16 | 16 | 2  | 1  | 0  |
| 2081 | 1  | 1  | 1  | 6  | 6  | 1  | 16 | 16 | 16 | 2  | 1  | 0  |
| 2082 | 1  | 1  | 1  | 6  | 6  | 1  | 16 | 16 | 16 | 2  | 1  | 0  |
| 2083 | 1  | 1  | 1  | 6  | 6  | 1  | 16 | 16 | 16 | 2  | 1  | 0  |
| 2084 | 1  | 1  | 1  | 6  | 6  | 1  | 16 | 16 | 16 | 2  | 1  | 0  |
| 2085 | 1  | 1  | 1  | 6  | 6  | 1  | 16 | 16 | 16 | 2  | 1  | 0  |
| 2086 | 1  | 1  | 1  | 6  | 6  | 1  | 16 | 16 | 16 | 2  | 1  | 0  |
| 2087 | 1  | 1  | 1  | 6  | 6  | 1  | 16 | 16 | 16 | 2  | 1  | 0  |
| 2088 | 1  | 1  | 1  | 6  | 6  | 1  | 16 | 16 | 16 | 2  | 1  | 0  |
| 2089 | 1  | 1  | 1  | 6  | 6  | 1  | 16 | 16 | 16 | 2  | 1  | 0  |
| 2090 | 1  | 1  | 1  | 6  | 6  | 1  | 16 | 16 | 16 | 2  | 1  | 0  |

|      | 85  | 86  | 87  | 88  | 89  | 90  | 91  | 92   | 93  | 94  | 95  | 96  |
|------|-----|-----|-----|-----|-----|-----|-----|------|-----|-----|-----|-----|
| 2002 | 0   | 0   | 0   | 0   | 0   | 0   | 0   | 0    | 0   | 0   | 0   | 0   |
| 2003 | 0   | 0   | 0   | 0   | 0   | 0   | 0   | 0    | 0   | 0   | 0   | 0   |
| 2004 | 1   | 1   | 1   | 1   | 1   | 1   | 1   | 1    | 1   | 1   | 1   | 1   |
| 2005 | 3   | 3   | 3   | 3   | 3   | 3   | 3   | 3    | 3   | 3   | 3   | 3   |
| 2006 | 14  | 14  | 14  | 14  | 14  | 14  | 14  | 14   | 14  | 14  | 14  | 14  |
| 2007 | 33  | 33  | 33  | 33  | 33  | 33  | 33  | 33   | 33  | 33  | 33  | 33  |
| 2008 | 67  | 67  | 67  | 67  | 67  | 67  | 67  | 67   | 67  | 67  | 67  | 67  |
| 2009 | 128 | 128 | 128 | 128 | 128 | 128 | 128 | 128  | 128 | 128 | 128 | 128 |
| 2010 | 210 | 210 | 210 | 210 | 210 | 210 | 210 | 210  | 210 | 210 | 210 | 210 |
| 2011 | 313 | 313 | 313 | 313 | 313 | 313 | 313 | 313  | 313 | 313 | 313 | 313 |
| 2012 | 418 | 418 | 418 | 418 | 418 | 418 | 418 | 313  | 418 | 418 | 418 | 418 |
| 2013 | 547 | 547 | 547 | 547 | 547 | 547 | 547 | 313  | 547 | 547 | 547 | 547 |
| 2014 | 665 | 665 | 665 | 665 | 665 | 665 | 665 | 313  | 665 | 665 | 665 | 665 |
| 2015 | 814 | 814 | 814 | 814 | 814 | 814 | 814 | 313  | 814 | 814 | 814 | 814 |
| 2016 | 814 | 814 | 814 | 814 | 814 | 814 | 814 | 957  | 313 | 814 | 814 | 814 |
| 2017 | 814 | 814 | 814 | 814 | 814 | 814 | 814 | 1109 | 313 | 814 | 814 | 814 |
| 2018 | 814 | 814 | 814 | 814 | 814 | 814 | 814 | 1276 | 313 | 814 | 814 | 814 |
| 2019 | 814 | 814 | 814 | 814 | 814 | 814 | 814 | 1449 | 313 | 814 | 814 | 814 |
| 2020 | 814 | 814 | 814 | 814 | 814 | 814 | 814 | 1449 | 313 | 814 | 814 | 814 |
| 2021 | 775 | 814 | 814 | 814 | 814 | 814 | 814 | 1449 | 313 | 814 | 728 | 814 |
| 2022 | 723 | 814 | 814 | 814 | 814 | 814 | 814 | 1449 | 313 | 814 | 669 | 814 |
| 2023 | 694 | 814 | 814 | 814 | 814 | 814 | 814 | 1449 | 313 | 814 | 603 | 814 |
| 2024 | 644 | 814 | 814 | 814 | 814 | 814 | 814 | 1449 | 313 | 814 | 557 | 814 |
| 2025 | 609 | 814 | 814 | 814 | 814 | 814 | 814 | 1449 | 313 | 814 | 538 | 814 |
| 2026 | 581 | 798 | 798 | 798 | 798 | 798 | 798 | 1351 | 296 | 814 | 519 | 767 |
| 2027 | 554 | 771 | 771 | 771 | 771 | 771 | 771 | 1260 | 272 | 814 | 493 | 712 |
| 2028 | 519 | 740 | 740 | 740 | 740 | 740 | 740 | 1182 | 256 | 814 | 477 | 673 |
| 2029 | 498 | 705 | 705 | 705 | 705 | 705 | 705 | 1098 | 236 | 814 | 456 | 625 |
| 2030 | 480 | 668 | 668 | 668 | 668 | 668 | 668 | 1029 | 218 | 814 | 435 | 579 |
| 2031 | 469 | 645 | 645 | 645 | 645 | 645 | 645 | 977  | 204 | 780 | 426 | 546 |
| 2032 | 458 | 600 | 600 | 600 | 600 | 600 | 600 | 940  | 196 | 739 | 406 | 530 |
| 2033 | 448 | 557 | 557 | 557 | 557 | 557 | 557 | 905  | 190 | 692 | 388 | 508 |
| 2034 | 430 | 528 | 528 | 528 | 528 | 528 | 528 | 871  | 180 | 658 | 367 | 490 |
| 2035 | 419 | 508 | 508 | 508 | 508 | 508 | 508 | 850  | 174 | 613 | 358 | 479 |
| 2036 | 401 | 500 | 494 | 500 | 500 | 500 | 500 | 823  | 165 | 578 | 347 | 459 |
| 2037 | 396 | 487 | 488 | 487 | 487 | 487 | 487 | 802  | 157 | 548 | 346 | 447 |
| 2038 | 395 | 482 | 480 | 482 | 482 | 482 | 482 | 779  | 150 | 524 | 346 | 430 |
| 2039 | 377 | 472 | 465 | 470 | 470 | 470 | 470 | 757  | 142 | 506 | 346 | 414 |
| 2040 | 373 | 461 | 451 | 456 | 456 | 456 | 456 | 744  | 139 | 489 | 346 | 403 |
| 2041 | 373 | 451 | 447 | 446 | 446 | 446 | 446 | 724  | 134 | 465 | 346 | 392 |
| 2042 | 356 | 448 | 441 | 446 | 446 | 446 | 446 | 697  | 128 | 440 | 337 | 380 |
| 2043 | 348 | 448 | 434 | 444 | 444 | 444 | 444 | 681  | 124 | 419 | 337 | 370 |
| 2044 | 221 | 435 | 427 | 429 | 429 | 429 | 429 | 668  | 120 | 402 | 337 | 366 |
| 2045 | 137 | 424 | 420 | 417 | 417 | 417 | 417 | 659  | 119 | 392 | 337 | 365 |
| 2046 | 73  | 353 | 344 | 340 | 340 | 340 | 340 | 652  | 117 | 387 | 324 | 365 |
| 2047 | 17  | 289 | 280 | 275 | 275 | 275 | 275 | 652  | 117 | 385 | 324 | 365 |
| 2048 | 14  | 211 | 203 | 196 | 196 | 196 | 196 | 652  | 117 | 382 | 215 | 360 |
| 2049 | 4   | 147 | 140 | 136 | 136 | 136 | 136 | 508  | 97  | 378 | 115 | 291 |
| 2050 | 4   | 97  | 89  | 86  | 86  | 86  | 86  | 370  | 77  | 330 | 60  | 219 |
| 2051 | 4   | 52  | 45  | 43  | 43  | 43  | 43  | 239  | 56  | 279 | 39  | 149 |
| 2052 | 4   | 23  | 18  | 16  | 16  | 16  | 16  | 144  | 37  | 229 | 20  | 90  |
| 2053 | 4   | 9   | 10  | 9   | 9   | 9   | 9   | 84   | 23  | 172 | 8   | 54  |
| 2054 | 4   | 7   | 7   | 6   | 6   | 6   | 6   | 54   | 16  | 121 | 8   | 34  |
| 2055 | 4   | 3   | 1   | 1   | 1   | 1   | 1   | 29   | 10  | 78  | 8   | 18  |
| 2056 | 4   | 3   | 1   | 1   | 1   | 1   | 1   | 15   | 5   | 52  | 8   | 9   |
| 2057 | 4   | 3   | 1   | 1   | 1   | 1   | 1   | 7    | 2   | 31  | 8   | 4   |
| 2058 | 4   | 3   | 1   | 1   | 1   | 1   | 1   | 1    | 0   | 18  | 8   | 0   |
| 2059 | 4   | 3   | 1   | 1   | 1   | 1   | 1   | 1    | 0   | 10  | 8   | 0   |
| 2060 | 4   | 3   | 1   | 1   | 1   | 1   | 1   | 1    | 0   | 6   | 8   | 0   |
| 2061 | 4   | 3   | 1   | 1   | 1   | 1   | 1   | 1    | 0   | 2   | 8   | 0   |
| 2062 | 4   | 3   | 1   | 1   | 1   | 1   | 1   | 1    | 0   | 0   | 8   | 0   |
| 2063 | 4   | 3   | 1   | 1   | 1   | 1   | 1   | 1    | 0   | 0   | 8   | 0   |
| 2064 | 4   | 3   | 1   | 1   | 1   | 1   | 1   | 1    | 0   | 0   | 8   | 0   |
| 2065 | 4   | 3   | 1   | 1   | 1   | 1   | 1   | 1    | 0   | 0   | 8   | 0   |
| 2066 | 4   | 3   | 1   | 1   | 1   | 1   | 1   | 1    | 0   | 0   | 8   | 0   |
| 2067 | 4   | 3   | 1   | 1   | 1   | 1   | 1   | 1    | 0   | 0   | 8   | 0   |
| 2068 | 4   | 3   | 1   | 1   | 1   | 1   | 1   | 1    | 0   | 0   | 8   | 0   |

|      | 85 | 86 | 87 | 88 | 89 | 90 | 91 | 92 | 93 | 94 | 95 | 96 |
|------|----|----|----|----|----|----|----|----|----|----|----|----|
| 2069 | 4  | 3  | 1  | 1  | 1  | 1  | 1  | 0  | 0  | 8  | 0  | 0  |
| 2070 | 4  | 3  | 1  | 1  | 1  | 1  | 1  | 0  | 0  | 8  | 0  | 0  |
| 2071 | 4  | 3  | 1  | 1  | 1  | 1  | 1  | 0  | 0  | 8  | 0  | 0  |
| 2072 | 4  | 3  | 1  | 1  | 1  | 1  | 1  | 0  | 0  | 8  | 0  | 0  |
| 2073 | 4  | 3  | 1  | 1  | 1  | 1  | 1  | 0  | 0  | 8  | 0  | 0  |
| 2074 | 4  | 3  | 1  | 1  | 1  | 1  | 1  | 0  | 0  | 8  | 0  | 0  |
| 2075 | 4  | 3  | 1  | 1  | 1  | 1  | 1  | 0  | 0  | 8  | 0  | 0  |
| 2076 | 4  | 3  | 1  | 1  | 1  | 1  | 1  | 0  | 0  | 8  | 0  | 0  |
| 2077 | 4  | 3  | 1  | 1  | 1  | 1  | 1  | 0  | 0  | 8  | 0  | 0  |
| 2078 | 4  | 3  | 1  | 1  | 1  | 1  | 1  | 0  | 0  | 8  | 0  | 0  |
| 2079 | 4  | 3  | 1  | 1  | 1  | 1  | 1  | 0  | 0  | 8  | 0  | 0  |
| 2080 | 4  | 3  | 1  | 1  | 1  | 1  | 1  | 0  | 0  | 8  | 0  | 0  |
| 2081 | 4  | 3  | 1  | 1  | 1  | 1  | 1  | 0  | 0  | 8  | 0  | 0  |
| 2082 | 4  | 3  | 1  | 1  | 1  | 1  | 1  | 0  | 0  | 8  | 0  | 0  |
| 2083 | 4  | 3  | 1  | 1  | 1  | 1  | 1  | 0  | 0  | 8  | 0  | 0  |
| 2084 | 4  | 3  | 1  | 1  | 1  | 1  | 1  | 0  | 0  | 8  | 0  | 0  |
| 2085 | 4  | 3  | 1  | 1  | 1  | 1  | 1  | 0  | 0  | 8  | 0  | 0  |
| 2086 | 4  | 3  | 1  | 1  | 1  | 1  | 1  | 0  | 0  | 8  | 0  | 0  |
| 2087 | 4  | 3  | 1  | 1  | 1  | 1  | 1  | 0  | 0  | 8  | 0  | 0  |
| 2088 | 4  | 3  | 1  | 1  | 1  | 1  | 1  | 0  | 0  | 8  | 0  | 0  |
| 2089 | 4  | 3  | 1  | 1  | 1  | 1  | 1  | 0  | 0  | 8  | 0  | 0  |
| 2090 | 4  | 3  | 1  | 1  | 1  | 1  | 1  | 0  | 0  | 8  | 0  | 0  |

|      | 97  | 98  | 99  | 100  | 101 | 102 | 103 | 104 | 105 | 106 | 107 | 108 |
|------|-----|-----|-----|------|-----|-----|-----|-----|-----|-----|-----|-----|
| 2002 | 0   | 0   | 0   | 0    | 0   | 0   | 0   | 0   | 0   | 0   | 0   | 0   |
| 2003 | 0   | 0   | 0   | 0    | 0   | 0   | 0   | 0   | 0   | 0   | 0   | 0   |
| 2004 | 1   | 1   | 1   | 1    | 1   | 1   | 1   | 1   | 1   | 1   | 1   | 1   |
| 2005 | 3   | 3   | 3   | 3    | 3   | 3   | 3   | 3   | 3   | 3   | 3   | 3   |
| 2006 | 14  | 14  | 14  | 14   | 14  | 14  | 14  | 14  | 14  | 14  | 14  | 14  |
| 2007 | 33  | 33  | 33  | 33   | 33  | 33  | 33  | 33  | 33  | 33  | 33  | 33  |
| 2008 | 67  | 67  | 67  | 67   | 67  | 67  | 67  | 67  | 67  | 67  | 67  | 67  |
| 2009 | 128 | 128 | 128 | 128  | 128 | 128 | 128 | 128 | 128 | 128 | 128 | 128 |
| 2010 | 210 | 210 | 210 | 210  | 210 | 210 | 210 | 210 | 210 | 210 | 210 | 210 |
| 2011 | 313 | 313 | 313 | 313  | 313 | 313 | 313 | 313 | 313 | 313 | 313 | 313 |
| 2012 | 418 | 418 | 418 | 418  | 313 | 418 | 418 | 418 | 418 | 418 | 418 | 418 |
| 2013 | 547 | 547 | 547 | 547  | 313 | 547 | 547 | 547 | 547 | 547 | 547 | 547 |
| 2014 | 665 | 665 | 665 | 665  | 313 | 665 | 665 | 665 | 665 | 665 | 665 | 665 |
| 2015 | 814 | 814 | 814 | 814  | 313 | 814 | 814 | 814 | 814 | 814 | 814 | 814 |
| 2016 | 814 | 814 | 814 | 957  | 313 | 814 | 814 | 814 | 814 | 814 | 814 | 814 |
| 2017 | 814 | 814 | 814 | 1109 | 313 | 814 | 814 | 814 | 814 | 814 | 814 | 814 |
| 2018 | 814 | 814 | 814 | 1276 | 313 | 814 | 814 | 814 | 814 | 814 | 814 | 814 |
| 2019 | 814 | 814 | 814 | 1449 | 313 | 814 | 814 | 814 | 814 | 814 | 814 | 814 |
| 2020 | 814 | 814 | 814 | 1449 | 313 | 814 | 814 | 814 | 814 | 814 | 814 | 814 |
| 2021 | 814 | 814 | 814 | 1449 | 313 | 814 | 728 | 814 | 814 | 814 | 814 | 814 |
| 2022 | 814 | 814 | 814 | 1449 | 313 | 814 | 669 | 814 | 814 | 814 | 814 | 814 |
| 2023 | 814 | 814 | 814 | 1449 | 313 | 814 | 603 | 814 | 814 | 814 | 814 | 814 |
| 2024 | 814 | 814 | 814 | 1449 | 313 | 814 | 557 | 814 | 814 | 814 | 814 | 814 |
| 2025 | 814 | 814 | 814 | 1449 | 313 | 814 | 538 | 814 | 814 | 814 | 814 | 814 |
| 2026 | 767 | 767 | 767 | 1351 | 296 | 814 | 519 | 767 | 767 | 767 | 767 | 767 |
| 2027 | 712 | 712 | 712 | 1260 | 272 | 814 | 496 | 708 | 712 | 712 | 712 | 712 |
| 2028 | 673 | 673 | 673 | 1182 | 256 | 814 | 482 | 669 | 673 | 673 | 673 | 673 |
| 2029 | 625 | 625 | 625 | 1098 | 236 | 814 | 466 | 616 | 624 | 625 | 625 | 625 |
| 2030 | 579 | 579 | 579 | 1029 | 218 | 814 | 437 | 573 | 578 | 579 | 579 | 579 |
| 2031 | 546 | 546 | 546 | 977  | 204 | 780 | 428 | 540 | 545 | 546 | 546 | 546 |
| 2032 | 526 | 526 | 526 | 941  | 197 | 739 | 419 | 527 | 526 | 527 | 527 | 527 |
| 2033 | 504 | 504 | 504 | 907  | 190 | 692 | 408 | 503 | 499 | 506 | 506 | 506 |
| 2034 | 484 | 484 | 484 | 876  | 181 | 658 | 394 | 486 | 477 | 487 | 487 | 487 |
| 2035 | 473 | 473 | 473 | 856  | 175 | 613 | 380 | 476 | 468 | 476 | 476 | 476 |
| 2036 | 456 | 456 | 456 | 825  | 166 | 578 | 367 | 456 | 451 | 457 | 457 | 457 |
| 2037 | 442 | 442 | 442 | 811  | 160 | 548 | 354 | 444 | 439 | 447 | 447 | 447 |
| 2038 | 427 | 427 | 427 | 784  | 152 | 524 | 347 | 427 | 424 | 430 | 430 | 430 |
| 2039 | 411 | 411 | 411 | 761  | 144 | 506 | 346 | 412 | 411 | 414 | 414 | 414 |
| 2040 | 403 | 403 | 403 | 744  | 139 | 489 | 346 | 401 | 403 | 403 | 403 | 403 |
| 2041 | 391 | 391 | 391 | 728  | 134 | 465 | 346 | 389 | 390 | 393 | 393 | 393 |
| 2042 | 374 | 374 | 374 | 701  | 129 | 440 | 332 | 374 | 373 | 376 | 376 | 376 |
| 2043 | 365 | 365 | 365 | 694  | 127 | 420 | 321 | 368 | 363 | 372 | 372 | 372 |
| 2044 | 356 | 356 | 356 | 688  | 126 | 406 | 300 | 361 | 355 | 369 | 369 | 369 |
| 2045 | 351 | 351 | 351 | 678  | 124 | 396 | 194 | 360 | 342 | 365 | 365 | 365 |
| 2046 | 346 | 346 | 346 | 655  | 120 | 389 | 102 | 355 | 325 | 353 | 353 | 353 |
| 2047 | 346 | 346 | 346 | 517  | 100 | 382 | 54  | 286 | 256 | 285 | 285 | 285 |
| 2048 | 346 | 346 | 346 | 375  | 79  | 380 | 32  | 213 | 190 | 213 | 213 | 213 |
| 2049 | 278 | 278 | 278 | 239  | 56  | 374 | 14  | 146 | 121 | 143 | 143 | 143 |
| 2050 | 210 | 210 | 210 | 145  | 37  | 327 | 7   | 88  | 73  | 88  | 88  | 88  |
| 2051 | 142 | 142 | 142 | 85   | 23  | 276 | 0   | 52  | 49  | 52  | 52  | 52  |
| 2052 | 86  | 86  | 86  | 54   | 16  | 223 | 0   | 34  | 34  | 34  | 34  | 34  |
| 2053 | 52  | 52  | 52  | 29   | 10  | 163 | 0   | 18  | 18  | 18  | 18  | 18  |
| 2054 | 34  | 34  | 34  | 15   | 5   | 116 | 0   | 9   | 9   | 9   | 9   | 9   |
| 2055 | 18  | 18  | 18  | 7    | 2   | 73  | 0   | 4   | 4   | 4   | 4   | 4   |
| 2056 | 9   | 9   | 9   | 1    | 0   | 48  | 0   | 4   | 0   | 0   | 0   | 0   |
| 2057 | 4   | 4   | 4   | 1    | 0   | 31  | 0   | 4   | 0   | 0   | 0   | 0   |
| 2058 | 0   | 0   | 0   | 1    | 0   | 18  | 0   | 4   | 0   | 0   | 0   | 0   |
| 2059 | 0   | 0   | 0   | 1    | 0   | 10  | 0   | 4   | 0   | 0   | 0   | 0   |
| 2060 | 0   | 0   | 0   | 1    | 0   | 6   | 0   | 4   | 0   | 0   | 0   | 0   |
| 2061 | 0   | 0   | 0   | 1    | 0   | 2   | 0   | 4   | 0   | 0   | 0   | 0   |
| 2062 | 0   | 0   | 0   | 1    | 0   | 0   | 0   | 4   | 0   | 0   | 0   | 0   |
| 2063 | 0   | 0   | 0   | 1    | 0   | 0   | 0   | 4   | 0   | 0   | 0   | 0   |
| 2064 | 0   | 0   | 0   | 1    | 0   | 0   | 0   | 4   | 0   | 0   | 0   | 0   |
| 2065 | 0   | 0   | 0   | 1    | 0   | 0   | 0   | 4   | 0   | 0   | 0   | 0   |
| 2066 | 0   | 0   | 0   | 1    | 0   | 0   | 0   | 4   | 0   | 0   | 0   | 0   |
| 2067 | 0   | 0   | 0   | 1    | 0   | 0   | 0   | 4   | 0   | 0   | 0   | 0   |
| 2068 | 0   | 0   | 0   | 1    | 0   | 0   | 0   | 4   | 0   | 0   | 0   | 0   |

|      | 97 | 98 | 99 | 100 | 101 | 102 | 103 | 104 | 105 | 106 | 107 | 108 |
|------|----|----|----|-----|-----|-----|-----|-----|-----|-----|-----|-----|
| 2069 | 0  | 0  | 0  | 1   | 0   | 0   | 0   | 4   | 0   | 0   | 0   | 0   |
| 2070 | 0  | 0  | 0  | 1   | 0   | 0   | 0   | 4   | 0   | 0   | 0   | 0   |
| 2071 | 0  | 0  | 0  | 1   | 0   | 0   | 0   | 4   | 0   | 0   | 0   | 0   |
| 2072 | 0  | 0  | 0  | 1   | 0   | 0   | 0   | 4   | 0   | 0   | 0   | 0   |
| 2073 | 0  | 0  | 0  | 1   | 0   | 0   | 0   | 4   | 0   | 0   | 0   | 0   |
| 2074 | 0  | 0  | 0  | 1   | 0   | 0   | 0   | 4   | 0   | 0   | 0   | 0   |
| 2075 | 0  | 0  | 0  | 1   | 0   | 0   | 0   | 4   | 0   | 0   | 0   | 0   |
| 2076 | 0  | 0  | 0  | 1   | 0   | 0   | 0   | 4   | 0   | 0   | 0   | 0   |
| 2077 | 0  | 0  | 0  | 1   | 0   | 0   | 0   | 4   | 0   | 0   | 0   | 0   |
| 2078 | 0  | 0  | 0  | 1   | 0   | 0   | 0   | 4   | 0   | 0   | 0   | 0   |
| 2079 | 0  | 0  | 0  | 1   | 0   | 0   | 0   | 4   | 0   | 0   | 0   | 0   |
| 2080 | 0  | 0  | 0  | 1   | 0   | 0   | 0   | 4   | 0   | 0   | 0   | 0   |
| 2081 | 0  | 0  | 0  | 1   | 0   | 0   | 0   | 4   | 0   | 0   | 0   | 0   |
| 2082 | 0  | 0  | 0  | 1   | 0   | 0   | 0   | 4   | 0   | 0   | 0   | 0   |
| 2083 | 0  | 0  | 0  | 1   | 0   | 0   | 0   | 4   | 0   | 0   | 0   | 0   |
| 2084 | 0  | 0  | 0  | 1   | 0   | 0   | 0   | 4   | 0   | 0   | 0   | 0   |
| 2085 | 0  | 0  | 0  | 1   | 0   | 0   | 0   | 4   | 0   | 0   | 0   | 0   |
| 2086 | 0  | 0  | 0  | 1   | 0   | 0   | 0   | 4   | 0   | 0   | 0   | 0   |
| 2087 | 0  | 0  | 0  | 1   | 0   | 0   | 0   | 4   | 0   | 0   | 0   | 0   |
| 2088 | 0  | 0  | 0  | 1   | 0   | 0   | 0   | 4   | 0   | 0   | 0   | 0   |
| 2089 | 0  | 0  | 0  | 1   | 0   | 0   | 0   | 4   | 0   | 0   | 0   | 0   |
| 2090 | 0  | 0  | 0  | 1   | 0   | 0   | 0   | 4   | 0   | 0   | 0   | 0   |

|      | 109  | 110 | 111 | 112 | 113 | 114  | 115 | 116 | 117 | 118  | 119 | 120 |
|------|------|-----|-----|-----|-----|------|-----|-----|-----|------|-----|-----|
| 2002 | 0    | 0   | 0   | 0   | 0   | 0    | 0   | 0   | 0   | 0    | 0   | 0   |
| 2003 | 0    | 0   | 0   | 0   | 0   | 0    | 0   | 0   | 0   | 0    | 0   | 0   |
| 2004 | 1    | 1   | 1   | 1   | 1   | 1    | 1   | 1   | 1   | 1    | 1   | 1   |
| 2005 | 3    | 3   | 3   | 3   | 3   | 3    | 3   | 3   | 3   | 3    | 3   | 3   |
| 2006 | 14   | 14  | 14  | 14  | 14  | 14   | 14  | 14  | 14  | 14   | 14  | 14  |
| 2007 | 33   | 33  | 33  | 33  | 33  | 33   | 33  | 33  | 33  | 33   | 33  | 33  |
| 2008 | 67   | 67  | 67  | 67  | 67  | 67   | 67  | 67  | 67  | 67   | 67  | 67  |
| 2009 | 128  | 128 | 128 | 128 | 128 | 128  | 128 | 128 | 128 | 128  | 128 | 128 |
| 2010 | 210  | 210 | 210 | 210 | 210 | 210  | 210 | 210 | 210 | 210  | 210 | 210 |
| 2011 | 313  | 313 | 313 | 313 | 313 | 313  | 313 | 313 | 313 | 313  | 313 | 313 |
| 2012 | 418  | 313 | 418 | 418 | 418 | 418  | 418 | 418 | 418 | 418  | 313 | 418 |
| 2013 | 547  | 313 | 547 | 547 | 547 | 547  | 547 | 547 | 547 | 547  | 313 | 547 |
| 2014 | 665  | 313 | 665 | 665 | 665 | 665  | 665 | 665 | 665 | 665  | 313 | 665 |
| 2015 | 814  | 313 | 814 | 814 | 814 | 814  | 814 | 814 | 814 | 814  | 313 | 814 |
| 2016 | 957  | 313 | 814 | 814 | 814 | 814  | 814 | 814 | 814 | 957  | 313 | 814 |
| 2017 | 1109 | 313 | 814 | 814 | 814 | 814  | 814 | 814 | 814 | 1109 | 313 | 814 |
| 2018 | 1276 | 313 | 814 | 814 | 814 | 814  | 814 | 814 | 814 | 1276 | 313 | 814 |
| 2019 | 1449 | 313 | 814 | 814 | 814 | 814  | 814 | 814 | 814 | 1449 | 313 | 814 |
| 2020 | 1449 | 313 | 814 | 814 | 814 | 814  | 814 | 814 | 814 | 1449 | 313 | 814 |
| 2021 | 1449 | 313 | 814 | 814 | 814 | 814  | 814 | 814 | 814 | 1449 | 313 | 814 |
| 2022 | 1449 | 313 | 814 | 814 | 814 | 814  | 814 | 814 | 814 | 1449 | 313 | 814 |
| 2023 | 1449 | 313 | 814 | 814 | 814 | 814  | 814 | 814 | 814 | 1449 | 313 | 814 |
| 2024 | 1449 | 313 | 814 | 814 | 814 | 814  | 814 | 814 | 814 | 1449 | 313 | 814 |
| 2025 | 1449 | 313 | 814 | 814 | 814 | 814  | 814 | 814 | 814 | 1449 | 313 | 814 |
| 2026 | 1449 | 313 | 814 | 814 | 814 | 814  | 814 | 814 | 814 | 1442 | 309 | 814 |
| 2027 | 1449 | 313 | 814 | 814 | 814 | 814  | 814 | 814 | 814 | 1431 | 307 | 814 |
| 2028 | 1449 | 313 | 814 | 812 | 814 | 814  | 814 | 814 | 814 | 1422 | 298 | 814 |
| 2029 | 1449 | 313 | 814 | 810 | 814 | 814  | 814 | 814 | 814 | 1398 | 277 | 814 |
| 2030 | 1449 | 313 | 814 | 795 | 814 | 814  | 814 | 814 | 814 | 1374 | 267 | 814 |
| 2031 | 1449 | 313 | 814 | 785 | 814 | 813  | 814 | 814 | 814 | 1352 | 262 | 812 |
| 2032 | 1449 | 313 | 814 | 767 | 814 | 799  | 814 | 814 | 814 | 1307 | 243 | 798 |
| 2033 | 1437 | 313 | 814 | 744 | 814 | 775  | 813 | 813 | 813 | 1270 | 224 | 781 |
| 2034 | 1436 | 312 | 814 | 727 | 814 | 742  | 812 | 812 | 812 | 1241 | 211 | 762 |
| 2035 | 1430 | 309 | 814 | 723 | 814 | 728  | 806 | 806 | 806 | 1206 | 189 | 736 |
| 2036 | 1402 | 302 | 814 | 718 | 813 | 722  | 779 | 779 | 779 | 1135 | 168 | 704 |
| 2037 | 1367 | 290 | 814 | 712 | 813 | 722  | 754 | 754 | 754 | 1087 | 162 | 671 |
| 2038 | 1355 | 287 | 814 | 704 | 798 | 718  | 746 | 746 | 746 | 1067 | 162 | 637 |
| 2039 | 1318 | 279 | 812 | 689 | 791 | 714  | 721 | 721 | 721 | 1053 | 162 | 607 |
| 2040 | 1296 | 279 | 798 | 677 | 767 | 703  | 705 | 705 | 705 | 1035 | 162 | 586 |
| 2041 | 1276 | 275 | 789 | 653 | 758 | 684  | 692 | 692 | 692 | 1006 | 160 | 554 |
| 2042 | 1254 | 269 | 756 | 546 | 715 | 657  | 685 | 685 | 685 | 973  | 159 | 539 |
| 2043 | 1229 | 266 | 749 | 421 | 686 | 642  | 665 | 665 | 665 | 936  | 155 | 528 |
| 2044 | 1066 | 222 | 715 | 342 | 589 | 537  | 599 | 599 | 599 | 908  | 155 | 522 |
| 2045 | 905  | 180 | 703 | 256 | 504 | 461  | 510 | 510 | 510 | 881  | 152 | 522 |
| 2046 | 808  | 167 | 615 | 168 | 449 | 413  | 442 | 442 | 442 | 863  | 149 | 519 |
| 2047 | 705  | 160 | 524 | 92  | 416 | 376  | 388 | 388 | 388 | 855  | 148 | 508 |
| 2048 | 624  | 153 | 457 | 45  | 377 | 353  | 362 | 362 | 362 | 845  | 146 | 445 |
| 2049 | 560  | 145 | 420 | 5   | 342 | 311  | 324 | 324 | 324 | 810  | 132 | 413 |
| 2050 | 467  | 101 | 397 | 0   | 282 | 241  | 256 | 256 | 256 | 710  | 108 | 403 |
| 2051 | 356  | 75  | 377 | 0   | 190 | 163  | 166 | 166 | 166 | 649  | 97  | 386 |
| 2052 | 214  | 29  | 345 | 0   | 103 | 83.4 | 87  | 87  | 87  | 544  | 65  | 351 |
| 2053 | 113  | 0   | 329 | 0   | 44  | 37   | 37  | 37  | 37  | 365  | 23  | 314 |
| 2054 | 51   | 0   | 301 | 0   | 12  | 5    | 5   | 5   | 5   | 212  | 7   | 258 |
| 2055 | 9    | 0   | 219 | 0   | 0   | 0    | 0   | 0   | 0   | 121  | 6   | 183 |
| 2056 | 0    | 0   | 134 | 0   | 0   | 0    | 0   | 0   | 0   | 59   | 0   | 115 |
| 2057 | 0    | 0   | 72  | 0   | 0   | 0    | 0   | 0   | 0   | 22   | 0   | 55  |
| 2058 | 0    | 0   | 30  | 0   | 0   | 0    | 0   | 0   | 0   | 1    | 0   | 9   |
| 2059 | 0    | 0   | 2   | 0   | 0   | 0    | 0   | 0   | 0   | 0    | 0   | 0   |
| 2060 | 0    | 0   | 0   | 0   | 0   | 0    | 0   | 0   | 0   | 0    | 0   | 0   |
| 2061 | 0    | 0   | 0   | 0   | 0   | 0    | 0   | 0   | 0   | 0    | 0   | 0   |
| 2062 | 0    | 0   | 0   | 0   | 0   | 0    | 0   | 0   | 0   | 0    | 0   | 0   |
| 2063 | 0    | 0   | 0   | 0   | 0   | 0    | 0   | 0   | 0   | 0    | 0   | 0   |
| 2064 | 0    | 0   | 0   | 0   | 0   | 0    | 0   | 0   | 0   | 0    | 0   | 0   |
| 2065 | 0    | 0   | 0   | 0   | 0   | 0    | 0   | 0   | 0   | 0    | 0   | 0   |
| 2066 | 0    | 0   | 0   | 0   | 0   | 0    | 0   | 0   | 0   | 0    | 0   | 0   |
| 2067 | 0    | 0   | 0   | 0   | 0   | 0    | 0   | 0   | 0   | 0    | 0   | 0   |
| 2068 | 0    | 0   | 0   | 0   | 0   | 0    | 0   | 0   | 0   | 0    | 0   | 0   |

|      | 109 | 110 | 111 | 112 | 113 | 114 | 115 | 116 | 117 | 118 | 119 | 120 |
|------|-----|-----|-----|-----|-----|-----|-----|-----|-----|-----|-----|-----|
| 2069 | 0   | 0   | 0   | 0   | 0   | 0   | 0   | 0   | 0   | 0   | 0   | 0   |
| 2070 | 0   | 0   | 0   | 0   | 0   | 0   | 0   | 0   | 0   | 0   | 0   | 0   |
| 2071 | 0   | 0   | 0   | 0   | 0   | 0   | 0   | 0   | 0   | 0   | 0   | 0   |
| 2072 | 0   | 0   | 0   | 0   | 0   | 0   | 0   | 0   | 0   | 0   | 0   | 0   |
| 2073 | 0   | 0   | 0   | 0   | 0   | 0   | 0   | 0   | 0   | 0   | 0   | 0   |
| 2074 | 0   | 0   | 0   | 0   | 0   | 0   | 0   | 0   | 0   | 0   | 0   | 0   |
| 2075 | 0   | 0   | 0   | 0   | 0   | 0   | 0   | 0   | 0   | 0   | 0   | 0   |
| 2076 | 0   | 0   | 0   | 0   | 0   | 0   | 0   | 0   | 0   | 0   | 0   | 0   |
| 2077 | 0   | 0   | 0   | 0   | 0   | 0   | 0   | 0   | 0   | 0   | 0   | 0   |
| 2078 | 0   | 0   | 0   | 0   | 0   | 0   | 0   | 0   | 0   | 0   | 0   | 0   |
| 2079 | 0   | 0   | 0   | 0   | 0   | 0   | 0   | 0   | 0   | 0   | 0   | 0   |
| 2080 | 0   | 0   | 0   | 0   | 0   | 0   | 0   | 0   | 0   | 0   | 0   | 0   |
| 2081 | 0   | 0   | 0   | 0   | 0   | 0   | 0   | 0   | 0   | 0   | 0   | 0   |
| 2082 | 0   | 0   | 0   | 0   | 0   | 0   | 0   | 0   | 0   | 0   | 0   | 0   |
| 2083 | 0   | 0   | 0   | 0   | 0   | 0   | 0   | 0   | 0   | 0   | 0   | 0   |
| 2084 | 0   | 0   | 0   | 0   | 0   | 0   | 0   | 0   | 0   | 0   | 0   | 0   |
| 2085 | 0   | 0   | 0   | 0   | 0   | 0   | 0   | 0   | 0   | 0   | 0   | 0   |
| 2086 | 0   | 0   | 0   | 0   | 0   | 0   | 0   | 0   | 0   | 0   | 0   | 0   |
| 2087 | 0   | 0   | 0   | 0   | 0   | 0   | 0   | 0   | 0   | 0   | 0   | 0   |
| 2088 | 0   | 0   | 0   | 0   | 0   | 0   | 0   | 0   | 0   | 0   | 0   | 0   |
| 2089 | 0   | 0   | 0   | 0   | 0   | 0   | 0   | 0   | 0   | 0   | 0   | 0   |
| 2090 | 0   | 0   | 0   | 0   | 0   | 0   | 0   | 0   | 0   | 0   | 0   | 0   |



|      | 121 | 122 | 123 | 124 | 125 | 126 | 127 | 128  | 129 | 130 | 131 | 132 |
|------|-----|-----|-----|-----|-----|-----|-----|------|-----|-----|-----|-----|
| 2002 | 0   | 0   | 0   | 0   | 0   | 0   | 0   | 0    | 0   | 0   | 0   | 0   |
| 2003 | 0   | 0   | 0   | 0   | 0   | 0   | 0   | 0    | 0   | 0   | 0   | 0   |
| 2004 | 1   | 1   | 1   | 1   | 1   | 1   | 1   | 1    | 1   | 1   | 1   | 1   |
| 2005 | 3   | 3   | 3   | 3   | 3   | 3   | 3   | 3    | 3   | 3   | 3   | 3   |
| 2006 | 14  | 14  | 14  | 14  | 14  | 14  | 14  | 14   | 14  | 14  | 14  | 14  |
| 2007 | 33  | 33  | 33  | 33  | 33  | 33  | 33  | 33   | 33  | 33  | 33  | 33  |
| 2008 | 67  | 67  | 67  | 67  | 67  | 67  | 67  | 67   | 67  | 67  | 67  | 67  |
| 2009 | 128 | 128 | 128 | 128 | 128 | 128 | 128 | 128  | 128 | 128 | 128 | 128 |
| 2010 | 210 | 210 | 210 | 210 | 210 | 210 | 210 | 210  | 210 | 210 | 210 | 210 |
| 2011 | 313 | 313 | 313 | 313 | 313 | 313 | 313 | 313  | 313 | 313 | 313 | 313 |
| 2012 | 418 | 418 | 418 | 418 | 418 | 418 | 418 | 313  | 418 | 418 | 418 | 418 |
| 2013 | 547 | 547 | 547 | 547 | 547 | 547 | 547 | 313  | 547 | 547 | 547 | 547 |
| 2014 | 665 | 665 | 665 | 665 | 665 | 665 | 665 | 313  | 665 | 665 | 665 | 665 |
| 2015 | 814 | 814 | 814 | 814 | 814 | 814 | 814 | 313  | 814 | 814 | 814 | 814 |
| 2016 | 814 | 814 | 814 | 814 | 814 | 814 | 814 | 957  | 313 | 814 | 814 | 814 |
| 2017 | 814 | 814 | 814 | 814 | 814 | 814 | 814 | 1109 | 313 | 814 | 814 | 814 |
| 2018 | 814 | 814 | 814 | 814 | 814 | 814 | 814 | 1276 | 313 | 814 | 814 | 814 |
| 2019 | 814 | 814 | 814 | 814 | 814 | 814 | 814 | 1449 | 313 | 814 | 814 | 814 |
| 2020 | 814 | 814 | 814 | 814 | 814 | 814 | 814 | 1449 | 313 | 814 | 814 | 814 |
| 2021 | 809 | 814 | 814 | 814 | 814 | 814 | 814 | 1449 | 313 | 814 | 807 | 814 |
| 2022 | 809 | 814 | 814 | 814 | 814 | 814 | 814 | 1449 | 313 | 814 | 804 | 814 |
| 2023 | 798 | 814 | 814 | 814 | 814 | 814 | 814 | 1449 | 313 | 814 | 793 | 814 |
| 2024 | 781 | 814 | 814 | 814 | 814 | 814 | 814 | 1449 | 313 | 814 | 784 | 814 |
| 2025 | 763 | 814 | 814 | 814 | 814 | 814 | 814 | 1449 | 313 | 814 | 773 | 814 |
| 2026 | 733 | 810 | 791 | 807 | 807 | 807 | 807 | 1442 | 307 | 814 | 762 | 810 |
| 2027 | 725 | 798 | 766 | 801 | 801 | 801 | 801 | 1428 | 303 | 814 | 742 | 803 |
| 2028 | 710 | 790 | 743 | 792 | 792 | 792 | 792 | 1422 | 297 | 814 | 732 | 800 |
| 2029 | 691 | 773 | 721 | 768 | 768 | 768 | 768 | 1413 | 291 | 814 | 729 | 794 |
| 2030 | 653 | 758 | 707 | 746 | 746 | 746 | 746 | 1395 | 283 | 814 | 720 | 784 |
| 2031 | 614 | 754 | 690 | 725 | 725 | 725 | 725 | 1379 | 276 | 809 | 699 | 777 |
| 2032 | 585 | 727 | 681 | 701 | 701 | 701 | 701 | 1359 | 274 | 801 | 682 | 754 |
| 2033 | 562 | 703 | 667 | 674 | 674 | 674 | 674 | 1335 | 269 | 786 | 634 | 743 |
| 2034 | 522 | 689 | 648 | 655 | 655 | 655 | 655 | 1325 | 261 | 776 | 606 | 729 |
| 2035 | 507 | 676 | 626 | 626 | 626 | 626 | 626 | 1301 | 249 | 768 | 568 | 717 |
| 2036 | 483 | 637 | 578 | 567 | 567 | 567 | 567 | 1265 | 227 | 754 | 546 | 698 |
| 2037 | 482 | 603 | 545 | 541 | 541 | 541 | 541 | 1223 | 219 | 739 | 533 | 671 |
| 2038 | 463 | 587 | 529 | 536 | 536 | 536 | 536 | 1175 | 205 | 721 | 510 | 651 |
| 2039 | 448 | 567 | 500 | 527 | 527 | 527 | 527 | 1121 | 187 | 692 | 485 | 623 |
| 2040 | 439 | 560 | 481 | 514 | 514 | 514 | 514 | 1094 | 173 | 665 | 464 | 612 |
| 2041 | 439 | 533 | 478 | 503 | 503 | 503 | 503 | 1069 | 162 | 632 | 456 | 589 |
| 2042 | 439 | 510 | 465 | 490 | 490 | 490 | 490 | 1048 | 160 | 615 | 448 | 575 |
| 2043 | 431 | 491 | 454 | 474 | 474 | 474 | 474 | 1014 | 160 | 596 | 444 | 560 |
| 2044 | 419 | 475 | 452 | 468 | 468 | 468 | 468 | 987  | 159 | 579 | 443 | 538 |
| 2045 | 403 | 468 | 446 | 458 | 458 | 458 | 458 | 959  | 159 | 575 | 437 | 523 |
| 2046 | 391 | 464 | 434 | 451 | 451 | 451 | 451 | 933  | 155 | 575 | 361 | 515 |
| 2047 | 375 | 456 | 419 | 444 | 444 | 444 | 444 | 832  | 134 | 574 | 206 | 433 |
| 2048 | 373 | 416 | 414 | 441 | 441 | 441 | 441 | 718  | 118 | 500 | 98  | 374 |
| 2049 | 373 | 389 | 379 | 409 | 409 | 409 | 409 | 662  | 97  | 453 | 32  | 352 |
| 2050 | 212 | 355 | 270 | 361 | 361 | 361 | 361 | 587  | 82  | 421 | 9   | 342 |
| 2051 | 92  | 309 | 165 | 321 | 321 | 321 | 321 | 425  | 42  | 388 | 3   | 293 |
| 2052 | 28  | 218 | 91  | 246 | 246 | 246 | 246 | 264  | 12  | 365 | 3   | 178 |
| 2053 | 8   | 110 | 43  | 140 | 140 | 140 | 140 | 146  | 6   | 321 | 0   | 95  |
| 2054 | 2   | 46  | 3   | 63  | 63  | 63  | 63  | 79   | 0   | 268 | 0   | 38  |
| 2055 | 0   | 13  | 0   | 14  | 14  | 14  | 14  | 32   | 0   | 199 | 0   | 3   |
| 2056 | 0   | 0   | 0   | 0   | 0   | 0   | 0   | 2    | 0   | 137 | 0   | 0   |
| 2057 | 0   | 0   | 0   | 0   | 0   | 0   | 0   | 0    | 0   | 92  | 0   | 0   |
| 2058 | 0   | 0   | 0   | 0   | 0   | 0   | 0   | 0    | 0   | 46  | 0   | 0   |
| 2059 | 0   | 0   | 0   | 0   | 0   | 0   | 0   | 0    | 0   | 17  | 0   | 0   |
| 2060 | 0   | 0   | 0   | 0   | 0   | 0   | 0   | 0    | 0   | 0   | 0   | 0   |
| 2061 | 0   | 0   | 0   | 0   | 0   | 0   | 0   | 0    | 0   | 0   | 0   | 0   |
| 2062 | 0   | 0   | 0   | 0   | 0   | 0   | 0   | 0    | 0   | 0   | 0   | 0   |
| 2063 | 0   | 0   | 0   | 0   | 0   | 0   | 0   | 0    | 0   | 0   | 0   | 0   |
| 2064 | 0   | 0   | 0   | 0   | 0   | 0   | 0   | 0    | 0   | 0   | 0   | 0   |
| 2065 | 0   | 0   | 0   | 0   | 0   | 0   | 0   | 0    | 0   | 0   | 0   | 0   |
| 2066 | 0   | 0   | 0   | 0   | 0   | 0   | 0   | 0    | 0   | 0   | 0   | 0   |
| 2067 | 0   | 0   | 0   | 0   | 0   | 0   | 0   | 0    | 0   | 0   | 0   | 0   |
| 2068 | 0   | 0   | 0   | 0   | 0   | 0   | 0   | 0    | 0   | 0   | 0   | 0   |

|      | 121 | 122 | 123 | 124 | 125 | 126 | 127 | 128 | 129 | 130 | 131 | 132 |
|------|-----|-----|-----|-----|-----|-----|-----|-----|-----|-----|-----|-----|
| 2069 | 0   | 0   | 0   | 0   | 0   | 0   | 0   | 0   | 0   | 0   | 0   | 0   |
| 2070 | 0   | 0   | 0   | 0   | 0   | 0   | 0   | 0   | 0   | 0   | 0   | 0   |
| 2071 | 0   | 0   | 0   | 0   | 0   | 0   | 0   | 0   | 0   | 0   | 0   | 0   |
| 2072 | 0   | 0   | 0   | 0   | 0   | 0   | 0   | 0   | 0   | 0   | 0   | 0   |
| 2073 | 0   | 0   | 0   | 0   | 0   | 0   | 0   | 0   | 0   | 0   | 0   | 0   |
| 2074 | 0   | 0   | 0   | 0   | 0   | 0   | 0   | 0   | 0   | 0   | 0   | 0   |
| 2075 | 0   | 0   | 0   | 0   | 0   | 0   | 0   | 0   | 0   | 0   | 0   | 0   |
| 2076 | 0   | 0   | 0   | 0   | 0   | 0   | 0   | 0   | 0   | 0   | 0   | 0   |
| 2077 | 0   | 0   | 0   | 0   | 0   | 0   | 0   | 0   | 0   | 0   | 0   | 0   |
| 2078 | 0   | 0   | 0   | 0   | 0   | 0   | 0   | 0   | 0   | 0   | 0   | 0   |
| 2079 | 0   | 0   | 0   | 0   | 0   | 0   | 0   | 0   | 0   | 0   | 0   | 0   |
| 2080 | 0   | 0   | 0   | 0   | 0   | 0   | 0   | 0   | 0   | 0   | 0   | 0   |
| 2081 | 0   | 0   | 0   | 0   | 0   | 0   | 0   | 0   | 0   | 0   | 0   | 0   |
| 2082 | 0   | 0   | 0   | 0   | 0   | 0   | 0   | 0   | 0   | 0   | 0   | 0   |
| 2083 | 0   | 0   | 0   | 0   | 0   | 0   | 0   | 0   | 0   | 0   | 0   | 0   |
| 2084 | 0   | 0   | 0   | 0   | 0   | 0   | 0   | 0   | 0   | 0   | 0   | 0   |
| 2085 | 0   | 0   | 0   | 0   | 0   | 0   | 0   | 0   | 0   | 0   | 0   | 0   |
| 2086 | 0   | 0   | 0   | 0   | 0   | 0   | 0   | 0   | 0   | 0   | 0   | 0   |
| 2087 | 0   | 0   | 0   | 0   | 0   | 0   | 0   | 0   | 0   | 0   | 0   | 0   |
| 2088 | 0   | 0   | 0   | 0   | 0   | 0   | 0   | 0   | 0   | 0   | 0   | 0   |
| 2089 | 0   | 0   | 0   | 0   | 0   | 0   | 0   | 0   | 0   | 0   | 0   | 0   |
| 2090 | 0   | 0   | 0   | 0   | 0   | 0   | 0   | 0   | 0   | 0   | 0   | 0   |

|      | 133 | 134 | 135 | 136  | 137 | 138 | 139 | 140 | 141 |
|------|-----|-----|-----|------|-----|-----|-----|-----|-----|
| 2002 | 0   | 0   | 0   | 0    | 0   | 0   | 0   | 0   | 0   |
| 2003 | 0   | 0   | 0   | 0    | 0   | 0   | 0   | 0   | 0   |
| 2004 | 1   | 1   | 1   | 1    | 1   | 1   | 1   | 1   | 1   |
| 2005 | 3   | 3   | 3   | 3    | 3   | 3   | 3   | 3   | 3   |
| 2006 | 14  | 14  | 14  | 14   | 14  | 14  | 14  | 14  | 14  |
| 2007 | 33  | 33  | 33  | 33   | 33  | 33  | 33  | 33  | 33  |
| 2008 | 67  | 67  | 67  | 67   | 67  | 67  | 67  | 67  | 67  |
| 2009 | 128 | 128 | 128 | 128  | 128 | 128 | 128 | 128 | 128 |
| 2010 | 210 | 210 | 210 | 210  | 210 | 210 | 210 | 210 | 210 |
| 2011 | 313 | 313 | 313 | 313  | 313 | 313 | 313 | 313 | 313 |
| 2012 | 418 | 418 | 418 | 418  | 313 | 418 | 418 | 418 | 418 |
| 2013 | 547 | 547 | 547 | 547  | 313 | 547 | 547 | 547 | 547 |
| 2014 | 665 | 665 | 665 | 665  | 313 | 665 | 665 | 665 | 665 |
| 2015 | 814 | 814 | 814 | 814  | 313 | 814 | 814 | 814 | 814 |
| 2016 | 814 | 814 | 814 | 957  | 313 | 814 | 814 | 814 | 814 |
| 2017 | 814 | 814 | 814 | 1109 | 313 | 814 | 814 | 814 | 814 |
| 2018 | 814 | 814 | 814 | 1276 | 313 | 814 | 814 | 814 | 814 |
| 2019 | 814 | 814 | 814 | 1449 | 313 | 814 | 814 | 814 | 814 |
| 2020 | 814 | 814 | 814 | 1449 | 313 | 814 | 814 | 814 | 814 |
| 2021 | 814 | 814 | 814 | 1449 | 313 | 814 | 747 | 814 | 814 |
| 2022 | 814 | 814 | 814 | 1449 | 313 | 814 | 676 | 814 | 814 |
| 2023 | 814 | 814 | 814 | 1449 | 313 | 814 | 643 | 814 | 814 |
| 2024 | 814 | 814 | 814 | 1449 | 313 | 814 | 604 | 814 | 814 |
| 2025 | 814 | 814 | 814 | 1449 | 313 | 814 | 574 | 814 | 814 |
| 2026 | 807 | 807 | 807 | 1383 | 290 | 814 | 535 | 774 | 774 |
| 2027 | 797 | 797 | 797 | 1291 | 272 | 814 | 509 | 712 | 712 |
| 2028 | 791 | 791 | 791 | 1210 | 257 | 814 | 477 | 670 | 670 |
| 2029 | 783 | 783 | 783 | 1127 | 231 | 814 | 466 | 621 | 621 |
| 2030 | 765 | 765 | 765 | 1066 | 229 | 814 | 464 | 592 | 592 |
| 2031 | 755 | 755 | 755 | 1026 | 219 | 781 | 456 | 567 | 567 |
| 2032 | 741 | 741 | 741 | 958  | 200 | 718 | 453 | 529 | 529 |
| 2033 | 731 | 731 | 731 | 894  | 196 | 671 | 449 | 493 | 493 |
| 2034 | 722 | 722 | 722 | 859  | 196 | 628 | 419 | 475 | 475 |
| 2035 | 705 | 705 | 705 | 835  | 196 | 570 | 409 | 469 | 469 |
| 2036 | 670 | 670 | 670 | 821  | 196 | 527 | 385 | 469 | 468 |
| 2037 | 639 | 639 | 639 | 790  | 196 | 505 | 380 | 468 | 468 |
| 2038 | 607 | 607 | 607 | 779  | 196 | 485 | 380 | 467 | 467 |
| 2039 | 577 | 577 | 577 | 769  | 193 | 469 | 338 | 457 | 453 |
| 2040 | 556 | 556 | 556 | 752  | 191 | 469 | 336 | 445 | 435 |
| 2041 | 534 | 534 | 534 | 727  | 188 | 469 | 336 | 425 | 425 |
| 2042 | 519 | 519 | 519 | 709  | 188 | 469 | 309 | 420 | 420 |
| 2043 | 504 | 504 | 504 | 671  | 188 | 468 | 303 | 420 | 416 |
| 2044 | 491 | 491 | 491 | 645  | 180 | 457 | 169 | 386 | 386 |
| 2045 | 479 | 479 | 479 | 625  | 173 | 457 | 73  | 370 | 370 |
| 2046 | 467 | 467 | 467 | 444  | 85  | 443 | 7   | 259 | 349 |
| 2047 | 413 | 413 | 413 | 343  | 70  | 443 | 0   | 197 | 220 |
| 2048 | 375 | 375 | 375 | 239  | 46  | 428 | 0   | 128 | 164 |
| 2049 | 329 | 329 | 329 | 137  | 8   | 388 | 0   | 73  | 90  |
| 2050 | 279 | 279 | 279 | 69   | 0   | 295 | 0   | 33  | 35  |
| 2051 | 181 | 181 | 181 | 25   | 0   | 260 | 0   | 5   | 5   |
| 2052 | 86  | 86  | 86  | 0    | 0   | 230 | 0   | 0   | 0   |
| 2053 | 31  | 31  | 31  | 0    | 0   | 178 | 0   | 0   | 0   |
| 2054 | 5   | 5   | 5   | 0    | 0   | 107 | 0   | 0   | 0   |
| 2055 | 0   | 0   | 0   | 0    | 0   | 57  | 0   | 0   | 0   |
| 2056 | 0   | 0   | 0   | 0    | 0   | 17  | 0   | 0   | 0   |
| 2057 | 0   | 0   | 0   | 0    | 0   | 0   | 0   | 0   | 0   |
| 2058 | 0   | 0   | 0   | 0    | 0   | 0   | 0   | 0   | 0   |
| 2059 | 0   | 0   | 0   | 0    | 0   | 0   | 0   | 0   | 0   |
| 2060 | 0   | 0   | 0   | 0    | 0   | 0   | 0   | 0   | 0   |
| 2061 | 0   | 0   | 0   | 0    | 0   | 0   | 0   | 0   | 0   |
| 2062 | 0   | 0   | 0   | 0    | 0   | 0   | 0   | 0   | 0   |
| 2063 | 0   | 0   | 0   | 0    | 0   | 0   | 0   | 0   | 0   |
| 2064 | 0   | 0   | 0   | 0    | 0   | 0   | 0   | 0   | 0   |
| 2065 | 0   | 0   | 0   | 0    | 0   | 0   | 0   | 0   | 0   |
| 2066 | 0   | 0   | 0   | 0    | 0   | 0   | 0   | 0   | 0   |
| 2067 | 0   | 0   | 0   | 0    | 0   | 0   | 0   | 0   | 0   |
| 2068 | 0   | 0   | 0   | 0    | 0   | 0   | 0   | 0   | 0   |

|      | 133 | 134 | 135 | 136 | 137 | 138 | 139 | 140 | 141 |
|------|-----|-----|-----|-----|-----|-----|-----|-----|-----|
| 2069 | 0   | 0   | 0   | 0   | 0   | 0   | 0   | 0   | 0   |
| 2070 | 0   | 0   | 0   | 0   | 0   | 0   | 0   | 0   | 0   |
| 2071 | 0   | 0   | 0   | 0   | 0   | 0   | 0   | 0   | 0   |
| 2072 | 0   | 0   | 0   | 0   | 0   | 0   | 0   | 0   | 0   |
| 2073 | 0   | 0   | 0   | 0   | 0   | 0   | 0   | 0   | 0   |
| 2074 | 0   | 0   | 0   | 0   | 0   | 0   | 0   | 0   | 0   |
| 2075 | 0   | 0   | 0   | 0   | 0   | 0   | 0   | 0   | 0   |
| 2076 | 0   | 0   | 0   | 0   | 0   | 0   | 0   | 0   | 0   |
| 2077 | 0   | 0   | 0   | 0   | 0   | 0   | 0   | 0   | 0   |
| 2078 | 0   | 0   | 0   | 0   | 0   | 0   | 0   | 0   | 0   |
| 2079 | 0   | 0   | 0   | 0   | 0   | 0   | 0   | 0   | 0   |
| 2080 | 0   | 0   | 0   | 0   | 0   | 0   | 0   | 0   | 0   |
| 2081 | 0   | 0   | 0   | 0   | 0   | 0   | 0   | 0   | 0   |
| 2082 | 0   | 0   | 0   | 0   | 0   | 0   | 0   | 0   | 0   |
| 2083 | 0   | 0   | 0   | 0   | 0   | 0   | 0   | 0   | 0   |
| 2084 | 0   | 0   | 0   | 0   | 0   | 0   | 0   | 0   | 0   |
| 2085 | 0   | 0   | 0   | 0   | 0   | 0   | 0   | 0   | 0   |
| 2086 | 0   | 0   | 0   | 0   | 0   | 0   | 0   | 0   | 0   |
| 2087 | 0   | 0   | 0   | 0   | 0   | 0   | 0   | 0   | 0   |
| 2088 | 0   | 0   | 0   | 0   | 0   | 0   | 0   | 0   | 0   |
| 2089 | 0   | 0   | 0   | 0   | 0   | 0   | 0   | 0   | 0   |
| 2090 | 0   | 0   | 0   | 0   | 0   | 0   | 0   | 0   | 0   |

|      | 142 | 143 | 144 | 145  | 146 | 147 | 148 | 149 | 150 | 151 | 152 |
|------|-----|-----|-----|------|-----|-----|-----|-----|-----|-----|-----|
| 2002 | 0   | 0   | 0   | 0    | 0   | 0   | 0   | 0   | 0   | 0   | 0   |
| 2003 | 0   | 0   | 0   | 0    | 0   | 0   | 0   | 0   | 0   | 0   | 0   |
| 2004 | 1   | 1   | 1   | 1    | 1   | 1   | 1   | 1   | 1   | 1   | 1   |
| 2005 | 3   | 3   | 3   | 3    | 3   | 3   | 3   | 3   | 3   | 3   | 3   |
| 2006 | 14  | 14  | 14  | 14   | 14  | 14  | 14  | 14  | 14  | 14  | 14  |
| 2007 | 33  | 33  | 33  | 33   | 33  | 33  | 33  | 33  | 33  | 33  | 33  |
| 2008 | 67  | 67  | 67  | 67   | 67  | 67  | 67  | 67  | 67  | 67  | 67  |
| 2009 | 128 | 128 | 128 | 128  | 128 | 128 | 128 | 128 | 128 | 128 | 128 |
| 2010 | 210 | 210 | 210 | 210  | 210 | 210 | 210 | 210 | 210 | 210 | 210 |
| 2011 | 313 | 313 | 313 | 313  | 313 | 313 | 313 | 313 | 313 | 313 | 313 |
| 2012 | 418 | 418 | 418 | 418  | 313 | 418 | 418 | 418 | 418 | 418 | 418 |
| 2013 | 547 | 547 | 547 | 547  | 313 | 547 | 547 | 547 | 547 | 547 | 547 |
| 2014 | 665 | 665 | 665 | 665  | 313 | 665 | 665 | 665 | 665 | 665 | 665 |
| 2015 | 814 | 814 | 814 | 814  | 313 | 814 | 814 | 814 | 814 | 814 | 814 |
| 2016 | 814 | 814 | 814 | 957  | 313 | 814 | 814 | 814 | 814 | 814 | 814 |
| 2017 | 814 | 814 | 814 | 1109 | 313 | 814 | 814 | 814 | 814 | 814 | 814 |
| 2018 | 814 | 814 | 814 | 1276 | 313 | 814 | 814 | 814 | 814 | 814 | 814 |
| 2019 | 814 | 814 | 814 | 1449 | 313 | 814 | 814 | 814 | 814 | 814 | 814 |
| 2020 | 814 | 814 | 814 | 1449 | 313 | 814 | 814 | 814 | 814 | 814 | 814 |
| 2021 | 814 | 814 | 814 | 1449 | 313 | 814 | 680 | 814 | 814 | 814 | 814 |
| 2022 | 814 | 814 | 814 | 1449 | 313 | 814 | 603 | 814 | 814 | 814 | 814 |
| 2023 | 814 | 814 | 814 | 1449 | 313 | 814 | 551 | 814 | 814 | 814 | 814 |
| 2024 | 814 | 814 | 814 | 1449 | 313 | 814 | 515 | 814 | 814 | 814 | 814 |
| 2025 | 814 | 814 | 814 | 1449 | 313 | 814 | 499 | 814 | 814 | 814 | 814 |
| 2026 | 774 | 774 | 774 | 1294 | 259 | 814 | 487 | 704 | 704 | 704 | 704 |
| 2027 | 712 | 712 | 712 | 1170 | 204 | 814 | 466 | 610 | 610 | 610 | 610 |
| 2028 | 670 | 670 | 670 | 1074 | 186 | 814 | 446 | 558 | 558 | 558 | 558 |
| 2029 | 621 | 621 | 621 | 1008 | 173 | 814 | 426 | 536 | 536 | 536 | 536 |
| 2030 | 592 | 592 | 592 | 949  | 159 | 814 | 410 | 502 | 502 | 502 | 502 |
| 2031 | 567 | 567 | 567 | 918  | 150 | 723 | 400 | 481 | 481 | 481 | 481 |
| 2032 | 529 | 529 | 529 | 888  | 150 | 607 | 387 | 466 | 462 | 462 | 462 |
| 2033 | 493 | 493 | 493 | 847  | 150 | 544 | 375 | 444 | 434 | 444 | 444 |
| 2034 | 475 | 475 | 475 | 825  | 140 | 511 | 355 | 424 | 422 | 424 | 424 |
| 2035 | 469 | 469 | 469 | 809  | 140 | 491 | 347 | 424 | 422 | 424 | 424 |
| 2036 | 469 | 469 | 469 | 784  | 140 | 474 | 346 | 418 | 418 | 418 | 418 |
| 2037 | 468 | 468 | 468 | 767  | 136 | 454 | 346 | 408 | 408 | 408 | 408 |
| 2038 | 467 | 467 | 467 | 755  | 136 | 424 | 346 | 398 | 398 | 398 | 398 |
| 2039 | 456 | 456 | 456 | 745  | 136 | 402 | 343 | 396 | 386 | 396 | 396 |
| 2040 | 442 | 442 | 442 | 725  | 132 | 390 | 343 | 386 | 376 | 386 | 386 |
| 2041 | 425 | 425 | 425 | 704  | 122 | 377 | 343 | 375 | 357 | 375 | 375 |
| 2042 | 420 | 420 | 420 | 684  | 117 | 375 | 321 | 362 | 346 | 355 | 355 |
| 2043 | 416 | 416 | 416 | 664  | 117 | 375 | 306 | 350 | 346 | 346 | 346 |
| 2044 | 386 | 386 | 386 | 654  | 117 | 371 | 302 | 350 | 346 | 346 | 346 |
| 2045 | 360 | 360 | 360 | 652  | 117 | 371 | 299 | 349 | 346 | 346 | 346 |
| 2046 | 248 | 248 | 248 | 652  | 117 | 363 | 274 | 349 | 342 | 346 | 346 |
| 2047 | 186 | 186 | 186 | 652  | 117 | 363 | 129 | 346 | 336 | 346 | 346 |
| 2048 | 117 | 117 | 117 | 652  | 117 | 363 | 54  | 346 | 287 | 346 | 346 |
| 2049 | 62  | 62  | 62  | 437  | 33  | 363 | 25  | 186 | 134 | 178 | 178 |
| 2050 | 22  | 22  | 22  | 248  | 8   | 363 | 6   | 77  | 60  | 71  | 71  |
| 2051 | 3   | 3   | 3   | 127  | 2   | 211 | 0   | 38  | 21  | 38  | 38  |
| 2052 | 0   | 0   | 0   | 69   | 0   | 112 | 0   | 9   | 0   | 9   | 9   |
| 2053 | 0   | 0   | 0   | 32   | 0   | 61  | 0   | 0   | 0   | 0   | 0   |
| 2054 | 0   | 0   | 0   | 11   | 0   | 35  | 0   | 0   | 0   | 0   | 0   |
| 2055 | 0   | 0   | 0   | 0    | 0   | 9   | 0   | 0   | 0   | 0   | 0   |
| 2056 | 0   | 0   | 0   | 0    | 0   | 0   | 0   | 0   | 0   | 0   | 0   |
| 2057 | 0   | 0   | 0   | 0    | 0   | 0   | 0   | 0   | 0   | 0   | 0   |
| 2058 | 0   | 0   | 0   | 0    | 0   | 0   | 0   | 0   | 0   | 0   | 0   |
| 2059 | 0   | 0   | 0   | 0    | 0   | 0   | 0   | 0   | 0   | 0   | 0   |
| 2060 | 0   | 0   | 0   | 0    | 0   | 0   | 0   | 0   | 0   | 0   | 0   |
| 2061 | 0   | 0   | 0   | 0    | 0   | 0   | 0   | 0   | 0   | 0   | 0   |
| 2062 | 0   | 0   | 0   | 0    | 0   | 0   | 0   | 0   | 0   | 0   | 0   |
| 2063 | 0   | 0   | 0   | 0    | 0   | 0   | 0   | 0   | 0   | 0   | 0   |
| 2064 | 0   | 0   | 0   | 0    | 0   | 0   | 0   | 0   | 0   | 0   | 0   |
| 2065 | 0   | 0   | 0   | 0    | 0   | 0   | 0   | 0   | 0   | 0   | 0   |
| 2066 | 0   | 0   | 0   | 0    | 0   | 0   | 0   | 0   | 0   | 0   | 0   |
| 2067 | 0   | 0   | 0   | 0    | 0   | 0   | 0   | 0   | 0   | 0   | 0   |
| 2068 | 0   | 0   | 0   | 0    | 0   | 0   | 0   | 0   | 0   | 0   | 0   |

|      | 142 | 143 | 144 | 145 | 146 | 147 | 148 | 149 | 150 | 151 | 152 |
|------|-----|-----|-----|-----|-----|-----|-----|-----|-----|-----|-----|
| 2069 | 0   | 0   | 0   | 0   | 0   | 0   | 0   | 0   | 0   | 0   | 0   |
| 2070 | 0   | 0   | 0   | 0   | 0   | 0   | 0   | 0   | 0   | 0   | 0   |
| 2071 | 0   | 0   | 0   | 0   | 0   | 0   | 0   | 0   | 0   | 0   | 0   |
| 2072 | 0   | 0   | 0   | 0   | 0   | 0   | 0   | 0   | 0   | 0   | 0   |
| 2073 | 0   | 0   | 0   | 0   | 0   | 0   | 0   | 0   | 0   | 0   | 0   |
| 2074 | 0   | 0   | 0   | 0   | 0   | 0   | 0   | 0   | 0   | 0   | 0   |
| 2075 | 0   | 0   | 0   | 0   | 0   | 0   | 0   | 0   | 0   | 0   | 0   |
| 2076 | 0   | 0   | 0   | 0   | 0   | 0   | 0   | 0   | 0   | 0   | 0   |
| 2077 | 0   | 0   | 0   | 0   | 0   | 0   | 0   | 0   | 0   | 0   | 0   |
| 2078 | 0   | 0   | 0   | 0   | 0   | 0   | 0   | 0   | 0   | 0   | 0   |
| 2079 | 0   | 0   | 0   | 0   | 0   | 0   | 0   | 0   | 0   | 0   | 0   |
| 2080 | 0   | 0   | 0   | 0   | 0   | 0   | 0   | 0   | 0   | 0   | 0   |
| 2081 | 0   | 0   | 0   | 0   | 0   | 0   | 0   | 0   | 0   | 0   | 0   |
| 2082 | 0   | 0   | 0   | 0   | 0   | 0   | 0   | 0   | 0   | 0   | 0   |
| 2083 | 0   | 0   | 0   | 0   | 0   | 0   | 0   | 0   | 0   | 0   | 0   |
| 2084 | 0   | 0   | 0   | 0   | 0   | 0   | 0   | 0   | 0   | 0   | 0   |
| 2085 | 0   | 0   | 0   | 0   | 0   | 0   | 0   | 0   | 0   | 0   | 0   |
| 2086 | 0   | 0   | 0   | 0   | 0   | 0   | 0   | 0   | 0   | 0   | 0   |
| 2087 | 0   | 0   | 0   | 0   | 0   | 0   | 0   | 0   | 0   | 0   | 0   |
| 2088 | 0   | 0   | 0   | 0   | 0   | 0   | 0   | 0   | 0   | 0   | 0   |
| 2089 | 0   | 0   | 0   | 0   | 0   | 0   | 0   | 0   | 0   | 0   | 0   |
| 2090 | 0   | 0   | 0   | 0   | 0   | 0   | 0   | 0   | 0   | 0   | 0   |

|      | 153 | 154  | 155 | 156 | 157 | 158 | 159 | 160 | 161 | 162 |
|------|-----|------|-----|-----|-----|-----|-----|-----|-----|-----|
| 2002 | 0   | 0    | 0   | 0   | 0   | 0   | 0   | 0   | 0   | 0   |
| 2003 | 0   | 0    | 0   | 0   | 0   | 0   | 0   | 0   | 0   | 0   |
| 2004 | 1   | 1    | 1   | 1   | 1   | 1   | 1   | 1   | 1   | 1   |
| 2005 | 3   | 3    | 3   | 3   | 3   | 3   | 3   | 3   | 3   | 3   |
| 2006 | 14  | 14   | 14  | 14  | 14  | 14  | 14  | 14  | 14  | 14  |
| 2007 | 33  | 33   | 33  | 33  | 33  | 33  | 33  | 33  | 33  | 33  |
| 2008 | 67  | 67   | 67  | 67  | 67  | 67  | 67  | 67  | 67  | 67  |
| 2009 | 128 | 128  | 128 | 128 | 128 | 128 | 128 | 128 | 128 | 128 |
| 2010 | 210 | 210  | 210 | 210 | 210 | 210 | 210 | 210 | 210 | 210 |
| 2011 | 313 | 313  | 313 | 313 | 313 | 313 | 313 | 313 | 313 | 313 |
| 2012 | 418 | 418  | 313 | 418 | 418 | 418 | 418 | 418 | 418 | 418 |
| 2013 | 547 | 547  | 313 | 547 | 547 | 547 | 547 | 547 | 547 | 547 |
| 2014 | 665 | 665  | 313 | 665 | 665 | 665 | 665 | 665 | 665 | 665 |
| 2015 | 814 | 814  | 313 | 814 | 814 | 814 | 814 | 814 | 814 | 814 |
| 2016 | 814 | 957  | 313 | 814 | 814 | 814 | 814 | 814 | 814 | 814 |
| 2017 | 814 | 1109 | 313 | 814 | 814 | 814 | 814 | 814 | 814 | 814 |
| 2018 | 814 | 1276 | 313 | 814 | 814 | 814 | 814 | 814 | 814 | 814 |
| 2019 | 814 | 1449 | 313 | 814 | 814 | 814 | 814 | 814 | 814 | 814 |
| 2020 | 814 | 1449 | 313 | 814 | 814 | 814 | 814 | 814 | 814 | 814 |
| 2021 | 814 | 1449 | 313 | 814 | 680 | 814 | 814 | 814 | 814 | 814 |
| 2022 | 814 | 1449 | 313 | 814 | 603 | 814 | 814 | 814 | 814 | 814 |
| 2023 | 814 | 1449 | 313 | 814 | 551 | 814 | 814 | 814 | 814 | 814 |
| 2024 | 814 | 1449 | 313 | 814 | 515 | 814 | 814 | 814 | 814 | 814 |
| 2025 | 814 | 1449 | 313 | 814 | 499 | 814 | 814 | 814 | 814 | 814 |
| 2026 | 704 | 1294 | 259 | 814 | 487 | 704 | 704 | 704 | 704 | 704 |
| 2027 | 610 | 1170 | 204 | 814 | 470 | 600 | 610 | 610 | 610 | 610 |
| 2028 | 558 | 1074 | 186 | 814 | 454 | 548 | 558 | 558 | 558 | 558 |
| 2029 | 536 | 1008 | 173 | 814 | 434 | 525 | 536 | 536 | 536 | 536 |
| 2030 | 502 | 949  | 159 | 814 | 414 | 492 | 502 | 502 | 502 | 502 |
| 2031 | 481 | 918  | 150 | 723 | 404 | 471 | 481 | 481 | 481 | 481 |
| 2032 | 462 | 890  | 150 | 607 | 401 | 459 | 462 | 462 | 462 | 462 |
| 2033 | 444 | 849  | 150 | 544 | 397 | 430 | 437 | 444 | 444 | 444 |
| 2034 | 424 | 826  | 140 | 511 | 377 | 412 | 422 | 424 | 424 | 424 |
| 2035 | 424 | 810  | 140 | 491 | 364 | 412 | 422 | 424 | 424 | 424 |
| 2036 | 418 | 785  | 140 | 474 | 354 | 408 | 418 | 418 | 418 | 418 |
| 2037 | 408 | 771  | 136 | 454 | 346 | 398 | 408 | 408 | 408 | 408 |
| 2038 | 398 | 755  | 136 | 424 | 346 | 388 | 398 | 398 | 398 | 398 |
| 2039 | 396 | 745  | 136 | 402 | 346 | 386 | 396 | 396 | 396 | 396 |
| 2040 | 386 | 725  | 132 | 390 | 346 | 376 | 386 | 386 | 386 | 386 |
| 2041 | 375 | 712  | 122 | 377 | 346 | 364 | 375 | 376 | 376 | 376 |
| 2042 | 355 | 684  | 117 | 375 | 324 | 353 | 355 | 355 | 355 | 355 |
| 2043 | 346 | 684  | 117 | 375 | 304 | 353 | 346 | 355 | 355 | 355 |
| 2044 | 346 | 674  | 117 | 375 | 274 | 346 | 346 | 353 | 353 | 353 |
| 2045 | 346 | 666  | 117 | 370 | 121 | 346 | 334 | 353 | 353 | 353 |
| 2046 | 346 | 656  | 117 | 363 | 44  | 346 | 305 | 338 | 338 | 338 |
| 2047 | 346 | 444  | 117 | 363 | 16  | 346 | 285 | 187 | 187 | 187 |
| 2048 | 346 | 253  | 29  | 363 | 6   | 176 | 139 | 81  | 81  | 81  |
| 2049 | 178 | 129  | 8   | 363 | 0   | 71  | 62  | 38  | 38  | 38  |
| 2050 | 71  | 69   | 3   | 211 | 0   | 30  | 23  | 9   | 9   | 9   |
| 2051 | 38  | 32   | 0   | 113 | 0   | 6   | 1   | 0   | 0   | 0   |
| 2052 | 9   | 11   | 0   | 51  | 0   | 0   | 0   | 0   | 0   | 0   |
| 2053 | 0   | 0    | 0   | 19  | 0   | 0   | 0   | 0   | 0   | 0   |
| 2054 | 0   | 0    | 0   | 13  | 0   | 0   | 0   | 0   | 0   | 0   |
| 2055 | 0   | 0    | 0   | 3   | 0   | 0   | 0   | 0   | 0   | 0   |
| 2056 | 0   | 0    | 0   | 0   | 0   | 0   | 0   | 0   | 0   | 0   |
| 2057 | 0   | 0    | 0   | 0   | 0   | 0   | 0   | 0   | 0   | 0   |
| 2058 | 0   | 0    | 0   | 0   | 0   | 0   | 0   | 0   | 0   | 0   |
| 2059 | 0   | 0    | 0   | 0   | 0   | 0   | 0   | 0   | 0   | 0   |
| 2060 | 0   | 0    | 0   | 0   | 0   | 0   | 0   | 0   | 0   | 0   |
| 2061 | 0   | 0    | 0   | 0   | 0   | 0   | 0   | 0   | 0   | 0   |
| 2062 | 0   | 0    | 0   | 0   | 0   | 0   | 0   | 0   | 0   | 0   |
| 2063 | 0   | 0    | 0   | 0   | 0   | 0   | 0   | 0   | 0   | 0   |
| 2064 | 0   | 0    | 0   | 0   | 0   | 0   | 0   | 0   | 0   | 0   |
| 2065 | 0   | 0    | 0   | 0   | 0   | 0   | 0   | 0   | 0   | 0   |
| 2066 | 0   | 0    | 0   | 0   | 0   | 0   | 0   | 0   | 0   | 0   |
| 2067 | 0   | 0    | 0   | 0   | 0   | 0   | 0   | 0   | 0   | 0   |
| 2068 | 0   | 0    | 0   | 0   | 0   | 0   | 0   | 0   | 0   | 0   |

|      | 153 | 154 | 155 | 156 | 157 | 158 | 159 | 160 | 161 | 162 |
|------|-----|-----|-----|-----|-----|-----|-----|-----|-----|-----|
| 2069 | 0   | 0   | 0   | 0   | 0   | 0   | 0   | 0   | 0   | 0   |
| 2070 | 0   | 0   | 0   | 0   | 0   | 0   | 0   | 0   | 0   | 0   |
| 2071 | 0   | 0   | 0   | 0   | 0   | 0   | 0   | 0   | 0   | 0   |
| 2072 | 0   | 0   | 0   | 0   | 0   | 0   | 0   | 0   | 0   | 0   |
| 2073 | 0   | 0   | 0   | 0   | 0   | 0   | 0   | 0   | 0   | 0   |
| 2074 | 0   | 0   | 0   | 0   | 0   | 0   | 0   | 0   | 0   | 0   |
| 2075 | 0   | 0   | 0   | 0   | 0   | 0   | 0   | 0   | 0   | 0   |
| 2076 | 0   | 0   | 0   | 0   | 0   | 0   | 0   | 0   | 0   | 0   |
| 2077 | 0   | 0   | 0   | 0   | 0   | 0   | 0   | 0   | 0   | 0   |
| 2078 | 0   | 0   | 0   | 0   | 0   | 0   | 0   | 0   | 0   | 0   |
| 2079 | 0   | 0   | 0   | 0   | 0   | 0   | 0   | 0   | 0   | 0   |
| 2080 | 0   | 0   | 0   | 0   | 0   | 0   | 0   | 0   | 0   | 0   |
| 2081 | 0   | 0   | 0   | 0   | 0   | 0   | 0   | 0   | 0   | 0   |
| 2082 | 0   | 0   | 0   | 0   | 0   | 0   | 0   | 0   | 0   | 0   |
| 2083 | 0   | 0   | 0   | 0   | 0   | 0   | 0   | 0   | 0   | 0   |
| 2084 | 0   | 0   | 0   | 0   | 0   | 0   | 0   | 0   | 0   | 0   |
| 2085 | 0   | 0   | 0   | 0   | 0   | 0   | 0   | 0   | 0   | 0   |
| 2086 | 0   | 0   | 0   | 0   | 0   | 0   | 0   | 0   | 0   | 0   |
| 2087 | 0   | 0   | 0   | 0   | 0   | 0   | 0   | 0   | 0   | 0   |
| 2088 | 0   | 0   | 0   | 0   | 0   | 0   | 0   | 0   | 0   | 0   |
| 2089 | 0   | 0   | 0   | 0   | 0   | 0   | 0   | 0   | 0   | 0   |
| 2090 | 0   | 0   | 0   | 0   | 0   | 0   | 0   | 0   | 0   | 0   |



EmplacedTAD

|      | 1    | 2    | 3    | 4    | 5    | 6    | 7    | 8    | 9    | 10   |
|------|------|------|------|------|------|------|------|------|------|------|
| 2002 | 0    | 0    | 0    | 0    | 0    | 0    | 0    | 0    | 0    | 0    |
| 2003 | 0    | 0    | 0    | 0    | 0    | 0    | 0    | 0    | 0    | 0    |
| 2004 | 0    | 0    | 0    | 0    | 0    | 0    | 0    | 0    | 0    | 0    |
| 2005 | 0    | 0    | 0    | 0    | 0    | 0    | 0    | 0    | 0    | 0    |
| 2006 | 0    | 0    | 0    | 0    | 0    | 0    | 0    | 0    | 0    | 0    |
| 2007 | 0    | 0    | 0    | 0    | 0    | 0    | 0    | 0    | 0    | 0    |
| 2008 | 0    | 0    | 0    | 0    | 0    | 0    | 0    | 0    | 0    | 0    |
| 2009 | 0    | 0    | 0    | 0    | 0    | 0    | 0    | 0    | 0    | 0    |
| 2010 | 0    | 0    | 0    | 0    | 0    | 0    | 0    | 0    | 0    | 0    |
| 2011 | 0    | 0    | 0    | 0    | 0    | 0    | 0    | 0    | 0    | 0    |
| 2012 | 0    | 0    | 0    | 0    | 0    | 0    | 0    | 0    | 0    | 0    |
| 2013 | 0    | 0    | 0    | 0    | 0    | 0    | 0    | 0    | 0    | 0    |
| 2014 | 0    | 0    | 0    | 0    | 0    | 0    | 0    | 0    | 0    | 0    |
| 2015 | 0    | 0    | 0    | 0    | 0    | 0    | 0    | 0    | 0    | 0    |
| 2016 | 0    | 0    | 0    | 0    | 0    | 0    | 0    | 0    | 0    | 0    |
| 2017 | 0    | 0    | 0    | 0    | 0    | 0    | 0    | 0    | 0    | 0    |
| 2018 | 0    | 0    | 0    | 0    | 0    | 0    | 0    | 0    | 0    | 0    |
| 2019 | 0    | 0    | 0    | 0    | 0    | 0    | 0    | 0    | 0    | 0    |
| 2020 | 0    | 0    | 0    | 254  | 0    | 0    | 0    | 0    | 0    | 0    |
| 2021 | 0    | 0    | 0    | 506  | 0    | 0    | 0    | 0    | 0    | 0    |
| 2022 | 0    | 0    | 0    | 760  | 0    | 0    | 0    | 0    | 0    | 0    |
| 2023 | 0    | 0    | 0    | 1017 | 0    | 0    | 0    | 0    | 0    | 0    |
| 2024 | 0    | 0    | 0    | 1268 | 0    | 0    | 0    | 0    | 0    | 0    |
| 2025 | 256  | 256  | 0    | 1537 | 256  | 256  | 256  | 256  | 256  | 71   |
| 2026 | 506  | 506  | 0    | 1793 | 506  | 506  | 506  | 506  | 506  | 175  |
| 2027 | 757  | 757  | 0    | 2050 | 757  | 757  | 757  | 757  | 757  | 291  |
| 2028 | 1011 | 1011 | 0    | 2306 | 1011 | 1011 | 1011 | 1011 | 1011 | 487  |
| 2029 | 1261 | 1261 | 0    | 2592 | 1261 | 1261 | 1261 | 1261 | 1261 | 705  |
| 2030 | 1513 | 1513 | 256  | 2875 | 1513 | 1513 | 1513 | 1513 | 1513 | 961  |
| 2031 | 1771 | 1771 | 509  | 3143 | 1771 | 1775 | 1771 | 1771 | 1771 | 1272 |
| 2032 | 2027 | 2027 | 759  | 3443 | 2027 | 2054 | 2027 | 2020 | 2027 | 1543 |
| 2033 | 2289 | 2292 | 1016 | 3761 | 2277 | 2333 | 2292 | 2283 | 2292 | 1833 |
| 2034 | 2553 | 2556 | 1271 | 4021 | 2536 | 2606 | 2556 | 2512 | 2556 | 2098 |
| 2035 | 2830 | 2833 | 1523 | 4353 | 2803 | 2880 | 2833 | 2750 | 2833 | 2331 |
| 2036 | 3142 | 3146 | 1790 | 4624 | 3087 | 3148 | 3147 | 2987 | 3146 | 2594 |
| 2037 | 3440 | 3451 | 2052 | 4843 | 3362 | 3443 | 3454 | 3244 | 3451 | 2796 |
| 2038 | 3766 | 3783 | 2314 | 5095 | 3706 | 3752 | 3789 | 3528 | 3783 | 2971 |
| 2039 | 4014 | 4058 | 2577 | 5364 | 3993 | 4020 | 4070 | 3758 | 4053 | 3158 |
| 2040 | 4328 | 4391 | 2858 | 5622 | 4328 | 4339 | 4404 | 4037 | 4380 | 3393 |
| 2041 | 4572 | 4649 | 3141 | 5833 | 4602 | 4593 | 4677 | 4243 | 4626 | 3608 |
| 2042 | 4844 | 4983 | 3464 | 5959 | 4964 | 4926 | 5020 | 4565 | 4953 | 3847 |
| 2043 | 5015 | 5123 | 3780 | 6125 | 5039 | 5100 | 5153 | 4751 | 5102 | 4087 |
| 2044 | 5169 | 5328 | 4046 | 6235 | 5227 | 5282 | 5315 | 4959 | 5289 | 4275 |
| 2045 | 5325 | 5563 | 4176 | 6326 | 5436 | 5510 | 5513 | 5236 | 5501 | 4410 |
| 2046 | 5443 | 5761 | 4389 | 6401 | 5624 | 5673 | 5696 | 5444 | 5693 | 4569 |
| 2047 | 5519 | 5968 | 4635 | 6422 | 5788 | 5841 | 5872 | 5665 | 5872 | 4692 |
| 2048 | 5565 | 6137 | 4839 | 6431 | 5912 | 5960 | 5981 | 5803 | 5981 | 4778 |
| 2049 | 5649 | 6275 | 5026 | 6431 | 6013 | 6039 | 6076 | 5922 | 6076 | 4854 |
| 2050 | 5765 | 6440 | 5203 | 6441 | 6148 | 6183 | 6212 | 6098 | 6212 | 5060 |
| 2051 | 5801 | 6609 | 5385 | 6441 | 6307 | 6345 | 6360 | 6268 | 6360 | 5198 |
| 2052 | 5801 | 6762 | 5528 | 6441 | 6422 | 6419 | 6426 | 6356 | 6426 | 5336 |
| 2053 | 5801 | 6863 | 5641 | 6441 | 6441 | 6436 | 6443 | 6395 | 6443 | 5451 |
| 2054 | 5801 | 6927 | 5803 | 6441 | 6441 | 6436 | 6443 | 6410 | 6443 | 5527 |
| 2055 | 5801 | 6939 | 5965 | 6441 | 6441 | 6436 | 6443 | 6429 | 6443 | 5563 |
| 2056 | 5801 | 6939 | 6164 | 6441 | 6441 | 6436 | 6443 | 6436 | 6443 | 5580 |
| 2057 | 5801 | 6939 | 6298 | 6441 | 6441 | 6436 | 6443 | 6441 | 6443 | 5607 |
| 2058 | 5801 | 6939 | 6374 | 6441 | 6441 | 6436 | 6443 | 6443 | 6443 | 5626 |
| 2059 | 5801 | 6939 | 6420 | 6441 | 6441 | 6436 | 6443 | 6443 | 6443 | 5651 |

EmplacedTAD

|      | 1    | 2    | 3    | 4    | 5    | 6    | 7    | 8    | 9    | 10   |
|------|------|------|------|------|------|------|------|------|------|------|
| 2060 | 5801 | 6939 | 6437 | 6441 | 6441 | 6436 | 6443 | 6443 | 6443 | 5677 |
| 2061 | 5801 | 6939 | 6437 | 6441 | 6441 | 6436 | 6443 | 6443 | 6443 | 5706 |
| 2062 | 5801 | 6939 | 6437 | 6441 | 6441 | 6436 | 6443 | 6443 | 6443 | 5736 |
| 2063 | 5801 | 6939 | 6437 | 6441 | 6441 | 6436 | 6443 | 6443 | 6443 | 5767 |
| 2064 | 5801 | 6939 | 6437 | 6441 | 6441 | 6436 | 6443 | 6443 | 6443 | 5794 |
| 2065 | 5801 | 6939 | 6437 | 6441 | 6441 | 6436 | 6443 | 6443 | 6443 | 5801 |
| 2066 | 5801 | 6939 | 6437 | 6441 | 6441 | 6436 | 6443 | 6443 | 6443 | 5801 |
| 2067 | 5801 | 6939 | 6437 | 6441 | 6441 | 6436 | 6443 | 6443 | 6443 | 5801 |
| 2068 | 5801 | 6939 | 6437 | 6441 | 6441 | 6436 | 6443 | 6443 | 6443 | 5801 |
| 2069 | 5801 | 6939 | 6437 | 6441 | 6441 | 6436 | 6443 | 6443 | 6443 | 5801 |
| 2070 | 5801 | 6939 | 6437 | 6441 | 6441 | 6436 | 6443 | 6443 | 6443 | 5801 |
| 2071 | 5801 | 6939 | 6437 | 6441 | 6441 | 6436 | 6443 | 6443 | 6443 | 5801 |
| 2072 | 5801 | 6939 | 6437 | 6441 | 6441 | 6436 | 6443 | 6443 | 6443 | 5801 |
| 2073 | 5801 | 6939 | 6437 | 6441 | 6441 | 6436 | 6443 | 6443 | 6443 | 5801 |
| 2074 | 5801 | 6939 | 6437 | 6441 | 6441 | 6436 | 6443 | 6443 | 6443 | 5801 |
| 2075 | 5801 | 6939 | 6437 | 6441 | 6441 | 6436 | 6443 | 6443 | 6443 | 5801 |
| 2076 | 5801 | 6939 | 6437 | 6441 | 6441 | 6436 | 6443 | 6443 | 6443 | 5801 |
| 2077 | 5801 | 6939 | 6437 | 6441 | 6441 | 6436 | 6443 | 6443 | 6443 | 5801 |
| 2078 | 5801 | 6939 | 6437 | 6441 | 6441 | 6436 | 6443 | 6443 | 6443 | 5801 |
| 2079 | 5801 | 6939 | 6437 | 6441 | 6441 | 6436 | 6443 | 6443 | 6443 | 5801 |
| 2080 | 5801 | 6939 | 6437 | 6441 | 6441 | 6436 | 6443 | 6443 | 6443 | 5801 |
| 2081 | 5801 | 6939 | 6437 | 6441 | 6441 | 6436 | 6443 | 6443 | 6443 | 5801 |
| 2082 | 5801 | 6939 | 6437 | 6441 | 6441 | 6436 | 6443 | 6443 | 6443 | 5801 |
| 2083 | 5801 | 6939 | 6437 | 6441 | 6441 | 6436 | 6443 | 6443 | 6443 | 5801 |
| 2084 | 5801 | 6939 | 6437 | 6441 | 6441 | 6436 | 6443 | 6443 | 6443 | 5801 |
| 2085 | 5801 | 6939 | 6437 | 6441 | 6441 | 6436 | 6443 | 6443 | 6443 | 5801 |
| 2086 | 5801 | 6939 | 6437 | 6441 | 6441 | 6436 | 6443 | 6443 | 6443 | 5801 |
| 2087 | 5801 | 6939 | 6437 | 6441 | 6441 | 6436 | 6443 | 6443 | 6443 | 5801 |
| 2088 | 5801 | 6939 | 6437 | 6441 | 6441 | 6436 | 6443 | 6443 | 6443 | 5801 |
| 2089 | 5801 | 6939 | 6437 | 6441 | 6441 | 6436 | 6443 | 6443 | 6443 | 5801 |
| 2090 | 5801 | 6939 | 6437 | 6441 | 6441 | 6436 | 6443 | 6443 | 6443 | 5801 |

EmplacedTAD

|      | 11   | 12   | 13   | 14   | 15   | 16   | 17   | 18   | 19   | 20   |
|------|------|------|------|------|------|------|------|------|------|------|
| 2002 | 0    | 0    | 0    | 0    | 0    | 0    | 0    | 0    | 0    | 0    |
| 2003 | 0    | 0    | 0    | 0    | 0    | 0    | 0    | 0    | 0    | 0    |
| 2004 | 0    | 0    | 0    | 0    | 0    | 0    | 0    | 0    | 0    | 0    |
| 2005 | 0    | 0    | 0    | 0    | 0    | 0    | 0    | 0    | 0    | 0    |
| 2006 | 0    | 0    | 0    | 0    | 0    | 0    | 0    | 0    | 0    | 0    |
| 2007 | 0    | 0    | 0    | 0    | 0    | 0    | 0    | 0    | 0    | 0    |
| 2008 | 0    | 0    | 0    | 0    | 0    | 0    | 0    | 0    | 0    | 0    |
| 2009 | 0    | 0    | 0    | 0    | 0    | 0    | 0    | 0    | 0    | 0    |
| 2010 | 0    | 0    | 0    | 0    | 0    | 0    | 0    | 0    | 0    | 0    |
| 2011 | 0    | 0    | 0    | 0    | 0    | 0    | 0    | 0    | 0    | 0    |
| 2012 | 0    | 0    | 0    | 0    | 0    | 0    | 0    | 0    | 0    | 0    |
| 2013 | 0    | 0    | 0    | 0    | 0    | 0    | 0    | 0    | 0    | 0    |
| 2014 | 0    | 0    | 0    | 0    | 0    | 0    | 0    | 0    | 0    | 0    |
| 2015 | 0    | 0    | 0    | 0    | 0    | 0    | 0    | 0    | 0    | 0    |
| 2016 | 0    | 0    | 0    | 0    | 0    | 0    | 0    | 0    | 0    | 0    |
| 2017 | 0    | 0    | 0    | 0    | 0    | 0    | 0    | 0    | 0    | 0    |
| 2018 | 0    | 0    | 0    | 0    | 0    | 0    | 0    | 0    | 0    | 0    |
| 2019 | 0    | 0    | 0    | 0    | 0    | 0    | 0    | 0    | 0    | 0    |
| 2020 | 0    | 0    | 90   | 0    | 0    | 0    | 0    | 0    | 0    | 0    |
| 2021 | 0    | 0    | 188  | 0    | 0    | 0    | 0    | 0    | 0    | 0    |
| 2022 | 0    | 0    | 343  | 0    | 0    | 0    | 0    | 0    | 0    | 0    |
| 2023 | 0    | 0    | 574  | 0    | 0    | 0    | 0    | 0    | 0    | 0    |
| 2024 | 0    | 0    | 881  | 0    | 0    | 0    | 0    | 0    | 0    | 0    |
| 2025 | 71   | 0    | 1106 | 64   | 174  | 244  | 4    | 71   | 17   | 17   |
| 2026 | 182  | 0    | 1388 | 164  | 351  | 488  | 29   | 180  | 53   | 55   |
| 2027 | 303  | 0    | 1641 | 285  | 588  | 743  | 42   | 296  | 102  | 110  |
| 2028 | 503  | 0    | 1947 | 436  | 821  | 991  | 81   | 500  | 152  | 168  |
| 2029 | 724  | 0    | 2225 | 611  | 1047 | 1253 | 156  | 726  | 258  | 279  |
| 2030 | 992  | 66   | 2504 | 825  | 1289 | 1520 | 228  | 996  | 407  | 439  |
| 2031 | 1316 | 175  | 2760 | 1114 | 1532 | 1764 | 330  | 1317 | 576  | 618  |
| 2032 | 1609 | 313  | 3030 | 1377 | 1771 | 2018 | 438  | 1596 | 772  | 820  |
| 2033 | 1909 | 484  | 3232 | 1718 | 2015 | 2263 | 628  | 1886 | 1004 | 1058 |
| 2034 | 2176 | 695  | 3444 | 2049 | 2273 | 2528 | 788  | 2152 | 1309 | 1370 |
| 2035 | 2425 | 963  | 3655 | 2340 | 2492 | 2795 | 948  | 2406 | 1621 | 1691 |
| 2036 | 2728 | 1275 | 3816 | 2595 | 2728 | 3027 | 1127 | 2706 | 1941 | 2016 |
| 2037 | 2981 | 1582 | 4011 | 2794 | 2985 | 3232 | 1345 | 2935 | 2231 | 2327 |
| 2038 | 3180 | 1888 | 4194 | 2972 | 3235 | 3423 | 1536 | 3118 | 2522 | 2647 |
| 2039 | 3379 | 2140 | 4381 | 3163 | 3459 | 3623 | 1756 | 3318 | 2774 | 2943 |
| 2040 | 3633 | 2406 | 4525 | 3375 | 3691 | 3856 | 1988 | 3546 | 3006 | 3201 |
| 2041 | 3864 | 2675 | 4684 | 3591 | 3915 | 4097 | 2254 | 3767 | 3248 | 3458 |
| 2042 | 4109 | 2985 | 4826 | 3809 | 4200 | 4329 | 2557 | 4011 | 3511 | 3735 |
| 2043 | 4367 | 3260 | 4976 | 4000 | 4430 | 4552 | 2880 | 4256 | 3775 | 4033 |
| 2044 | 4572 | 3533 | 5087 | 4189 | 4608 | 4737 | 3171 | 4448 | 4008 | 4276 |
| 2045 | 4746 | 3765 | 5186 | 4387 | 4816 | 4913 | 3470 | 4612 | 4290 | 4565 |
| 2046 | 4929 | 3984 | 5266 | 4573 | 4986 | 5064 | 3682 | 4779 | 4494 | 4794 |
| 2047 | 5073 | 4164 | 5330 | 4704 | 5231 | 5219 | 3881 | 4927 | 4734 | 5062 |
| 2048 | 5185 | 4394 | 5402 | 4889 | 5347 | 5325 | 4049 | 5028 | 4995 | 5384 |
| 2049 | 5276 | 4640 | 5670 | 5065 | 5511 | 5397 | 4284 | 5108 | 5194 | 5647 |
| 2050 | 5528 | 4855 | 5799 | 5218 | 5764 | 5621 | 4587 | 5342 | 5353 | 5883 |
| 2051 | 5730 | 5014 | 5848 | 5460 | 5998 | 5821 | 4856 | 5541 | 5514 | 6162 |
| 2052 | 5941 | 5199 | 5911 | 5700 | 6183 | 6029 | 5111 | 5761 | 5606 | 6418 |
| 2053 | 6198 | 5428 | 5960 | 5902 | 6335 | 6204 | 5369 | 5951 | 5662 | 6607 |
| 2054 | 6428 | 5611 | 6014 | 6049 | 6405 | 6365 | 5589 | 6113 | 5699 | 6729 |
| 2055 | 6575 | 5828 | 6069 | 6125 | 6429 | 6425 | 5719 | 6190 | 5712 | 6799 |
| 2056 | 6656 | 6008 | 6128 | 6177 | 6449 | 6439 | 5761 | 6222 | 5726 | 6850 |
| 2057 | 6726 | 6167 | 6178 | 6218 | 6459 | 6439 | 5800 | 6252 | 5743 | 6876 |
| 2058 | 6763 | 6269 | 6229 | 6232 | 6459 | 6439 | 5849 | 6267 | 5753 | 6887 |
| 2059 | 6785 | 6338 | 6275 | 6271 | 6459 | 6439 | 5890 | 6298 | 5767 | 6901 |

EmplacedTAD

|      | 11   | 12   | 13   | 14   | 15   | 16   | 17   | 18   | 19   | 20   |
|------|------|------|------|------|------|------|------|------|------|------|
| 2060 | 6811 | 6389 | 6312 | 6291 | 6459 | 6439 | 5931 | 6323 | 5775 | 6910 |
| 2061 | 6837 | 6409 | 6362 | 6309 | 6459 | 6439 | 5972 | 6352 | 5784 | 6919 |
| 2062 | 6870 | 6433 | 6397 | 6329 | 6459 | 6439 | 6004 | 6379 | 5799 | 6935 |
| 2063 | 6904 | 6443 | 6423 | 6350 | 6459 | 6439 | 6043 | 6408 | 5801 | 6937 |
| 2064 | 6930 | 6451 | 6438 | 6379 | 6459 | 6439 | 6061 | 6432 | 5801 | 6937 |
| 2065 | 6937 | 6451 | 6438 | 6400 | 6459 | 6439 | 6114 | 6439 | 5801 | 6937 |
| 2066 | 6937 | 6451 | 6438 | 6419 | 6459 | 6439 | 6142 | 6439 | 5801 | 6937 |
| 2067 | 6937 | 6451 | 6438 | 6436 | 6459 | 6439 | 6178 | 6439 | 5801 | 6937 |
| 2068 | 6937 | 6451 | 6438 | 6444 | 6459 | 6439 | 6207 | 6439 | 5801 | 6937 |
| 2069 | 6937 | 6451 | 6438 | 6444 | 6459 | 6439 | 6227 | 6439 | 5801 | 6937 |
| 2070 | 6937 | 6451 | 6438 | 6444 | 6459 | 6439 | 6252 | 6439 | 5801 | 6937 |
| 2071 | 6937 | 6451 | 6438 | 6444 | 6459 | 6439 | 6268 | 6439 | 5801 | 6937 |
| 2072 | 6937 | 6451 | 6438 | 6444 | 6459 | 6439 | 6301 | 6439 | 5801 | 6937 |
| 2073 | 6937 | 6451 | 6438 | 6444 | 6459 | 6439 | 6323 | 6439 | 5801 | 6937 |
| 2074 | 6937 | 6451 | 6438 | 6444 | 6459 | 6439 | 6350 | 6439 | 5801 | 6937 |
| 2075 | 6937 | 6451 | 6438 | 6444 | 6459 | 6439 | 6381 | 6439 | 5801 | 6937 |
| 2076 | 6937 | 6451 | 6438 | 6444 | 6459 | 6439 | 6403 | 6439 | 5801 | 6937 |
| 2077 | 6937 | 6451 | 6438 | 6444 | 6459 | 6439 | 6429 | 6439 | 5801 | 6937 |
| 2078 | 6937 | 6451 | 6438 | 6444 | 6459 | 6439 | 6439 | 6439 | 5801 | 6937 |
| 2079 | 6937 | 6451 | 6438 | 6444 | 6459 | 6439 | 6439 | 6439 | 5801 | 6937 |
| 2080 | 6937 | 6451 | 6438 | 6444 | 6459 | 6439 | 6439 | 6439 | 5801 | 6937 |
| 2081 | 6937 | 6451 | 6438 | 6444 | 6459 | 6439 | 6439 | 6439 | 5801 | 6937 |
| 2082 | 6937 | 6451 | 6438 | 6444 | 6459 | 6439 | 6439 | 6439 | 5801 | 6937 |
| 2083 | 6937 | 6451 | 6438 | 6444 | 6459 | 6439 | 6439 | 6439 | 5801 | 6937 |
| 2084 | 6937 | 6451 | 6438 | 6444 | 6459 | 6439 | 6439 | 6439 | 5801 | 6937 |
| 2085 | 6937 | 6451 | 6438 | 6444 | 6459 | 6439 | 6439 | 6439 | 5801 | 6937 |
| 2086 | 6937 | 6451 | 6438 | 6444 | 6459 | 6439 | 6439 | 6439 | 5801 | 6937 |
| 2087 | 6937 | 6451 | 6438 | 6444 | 6459 | 6439 | 6439 | 6439 | 5801 | 6937 |
| 2088 | 6937 | 6451 | 6438 | 6444 | 6459 | 6439 | 6439 | 6439 | 5801 | 6937 |
| 2089 | 6937 | 6451 | 6438 | 6444 | 6459 | 6439 | 6439 | 6439 | 5801 | 6937 |
| 2090 | 6937 | 6451 | 6438 | 6444 | 6459 | 6439 | 6439 | 6439 | 5801 | 6937 |

EmplacedTAD

|      | 21   | 22   | 23   | 24   | 25   | 26   | 27   | 28   | 29   | 30   |
|------|------|------|------|------|------|------|------|------|------|------|
| 2002 | 0    | 0    | 0    | 0    | 0    | 0    | 0    | 0    | 0    | 0    |
| 2003 | 0    | 0    | 0    | 0    | 0    | 0    | 0    | 0    | 0    | 0    |
| 2004 | 0    | 0    | 0    | 0    | 0    | 0    | 0    | 0    | 0    | 0    |
| 2005 | 0    | 0    | 0    | 0    | 0    | 0    | 0    | 0    | 0    | 0    |
| 2006 | 0    | 0    | 0    | 0    | 0    | 0    | 0    | 0    | 0    | 0    |
| 2007 | 0    | 0    | 0    | 0    | 0    | 0    | 0    | 0    | 0    | 0    |
| 2008 | 0    | 0    | 0    | 0    | 0    | 0    | 0    | 0    | 0    | 0    |
| 2009 | 0    | 0    | 0    | 0    | 0    | 0    | 0    | 0    | 0    | 0    |
| 2010 | 0    | 0    | 0    | 0    | 0    | 0    | 0    | 0    | 0    | 0    |
| 2011 | 0    | 0    | 0    | 0    | 0    | 0    | 0    | 0    | 0    | 0    |
| 2012 | 0    | 0    | 0    | 0    | 0    | 0    | 0    | 0    | 0    | 0    |
| 2013 | 0    | 0    | 0    | 0    | 0    | 0    | 0    | 0    | 0    | 0    |
| 2014 | 0    | 0    | 0    | 0    | 0    | 0    | 0    | 0    | 0    | 0    |
| 2015 | 0    | 0    | 0    | 0    | 0    | 0    | 0    | 0    | 0    | 0    |
| 2016 | 0    | 0    | 0    | 0    | 0    | 0    | 0    | 0    | 0    | 0    |
| 2017 | 0    | 0    | 0    | 0    | 0    | 0    | 0    | 0    | 0    | 0    |
| 2018 | 0    | 0    | 0    | 0    | 0    | 0    | 0    | 0    | 0    | 0    |
| 2019 | 0    | 0    | 0    | 0    | 0    | 0    | 0    | 0    | 0    | 0    |
| 2020 | 0    | 10   | 0    | 0    | 0    | 0    | 0    | 0    | 0    | 0    |
| 2021 | 0    | 29   | 0    | 0    | 0    | 0    | 0    | 0    | 0    | 0    |
| 2022 | 0    | 76   | 0    | 0    | 0    | 0    | 0    | 0    | 0    | 0    |
| 2023 | 0    | 154  | 0    | 0    | 0    | 0    | 0    | 0    | 0    | 0    |
| 2024 | 0    | 257  | 0    | 0    | 0    | 0    | 0    | 0    | 0    | 0    |
| 2025 | 0    | 385  | 12   | 63   | 64   | 1    | 17   | 256  | 256  | 0    |
| 2026 | 0    | 594  | 25   | 192  | 198  | 7    | 53   | 506  | 506  | 0    |
| 2027 | 0    | 823  | 43   | 324  | 392  | 15   | 105  | 757  | 757  | 0    |
| 2028 | 0    | 1112 | 84   | 532  | 646  | 31   | 163  | 1011 | 1011 | 0    |
| 2029 | 0    | 1364 | 145  | 789  | 932  | 81   | 277  | 1261 | 1261 | 0    |
| 2030 | 10   | 1667 | 239  | 1015 | 1190 | 117  | 432  | 1513 | 1513 | 256  |
| 2031 | 54   | 1932 | 375  | 1291 | 1511 | 150  | 608  | 1771 | 1771 | 509  |
| 2032 | 126  | 2237 | 529  | 1532 | 1790 | 195  | 810  | 2027 | 2027 | 759  |
| 2033 | 215  | 2500 | 700  | 1753 | 2038 | 266  | 1043 | 2289 | 2292 | 1016 |
| 2034 | 371  | 2806 | 884  | 2048 | 2271 | 352  | 1350 | 2553 | 2556 | 1271 |
| 2035 | 523  | 3083 | 1074 | 2289 | 2558 | 445  | 1666 | 2830 | 2833 | 1523 |
| 2036 | 682  | 3342 | 1353 | 2521 | 2843 | 557  | 1998 | 3142 | 3146 | 1790 |
| 2037 | 896  | 3601 | 1728 | 2768 | 3126 | 663  | 2307 | 3433 | 3448 | 2052 |
| 2038 | 1136 | 3859 | 2050 | 2981 | 3343 | 798  | 2593 | 3760 | 3776 | 2314 |
| 2039 | 1453 | 4114 | 2398 | 3224 | 3597 | 978  | 2871 | 4014 | 4046 | 2577 |
| 2040 | 1807 | 4330 | 2692 | 3501 | 3834 | 1143 | 3127 | 4330 | 4387 | 2858 |
| 2041 | 2140 | 4600 | 2987 | 3762 | 4092 | 1348 | 3385 | 4572 | 4631 | 3141 |
| 2042 | 2415 | 4867 | 3232 | 4112 | 4385 | 1549 | 3652 | 4837 | 4942 | 3457 |
| 2043 | 2698 | 5133 | 3510 | 4378 | 4620 | 1811 | 3940 | 5039 | 5126 | 3777 |
| 2044 | 2987 | 5344 | 3775 | 4645 | 4867 | 2085 | 4184 | 5118 | 5307 | 4026 |
| 2045 | 3279 | 5583 | 4047 | 4915 | 5072 | 2361 | 4484 | 5215 | 5520 | 4192 |
| 2046 | 3528 | 5847 | 4282 | 5127 | 5250 | 2691 | 4709 | 5323 | 5715 | 4384 |
| 2047 | 3732 | 6047 | 4641 | 5363 | 5413 | 3111 | 4964 | 5421 | 5907 | 4582 |
| 2048 | 4055 | 6157 | 4982 | 5613 | 5631 | 3506 | 5277 | 5494 | 6081 | 4760 |
| 2049 | 4383 | 6194 | 5166 | 5846 | 5805 | 3867 | 5523 | 5557 | 6222 | 4937 |
| 2050 | 4661 | 6224 | 5383 | 6089 | 5989 | 4289 | 5754 | 5626 | 6388 | 5094 |
| 2051 | 4841 | 6259 | 5619 | 6262 | 6166 | 4639 | 5987 | 5690 | 6547 | 5263 |
| 2052 | 5075 | 6273 | 5868 | 6365 | 6326 | 4936 | 6167 | 5735 | 6687 | 5414 |
| 2053 | 5304 | 6290 | 6066 | 6411 | 6420 | 5240 | 6281 | 5768 | 6788 | 5535 |
| 2054 | 5535 | 6315 | 6199 | 6428 | 6446 | 5420 | 6345 | 5786 | 6850 | 5681 |
| 2055 | 5750 | 6334 | 6275 | 6443 | 6446 | 5578 | 6356 | 5800 | 6906 | 5831 |
| 2056 | 5966 | 6353 | 6284 | 6443 | 6446 | 5699 | 6369 | 5802 | 6925 | 5976 |
| 2057 | 6157 | 6383 | 6339 | 6443 | 6446 | 5818 | 6386 | 5804 | 6932 | 6113 |
| 2058 | 6304 | 6400 | 6361 | 6443 | 6446 | 5894 | 6395 | 5804 | 6939 | 6213 |
| 2059 | 6375 | 6426 | 6378 | 6443 | 6446 | 5961 | 6409 | 5805 | 6942 | 6294 |

EmplacedTAD

|      | 21   | 22   | 23   | 24   | 25   | 26   | 27   | 28   | 29   | 30   |
|------|------|------|------|------|------|------|------|------|------|------|
| 2060 | 6416 | 6433 | 6388 | 6443 | 6446 | 6059 | 6418 | 5805 | 6942 | 6358 |
| 2061 | 6440 | 6438 | 6393 | 6443 | 6446 | 6121 | 6427 | 5805 | 6942 | 6403 |
| 2062 | 6449 | 6438 | 6404 | 6443 | 6446 | 6181 | 6444 | 5805 | 6942 | 6425 |
| 2063 | 6451 | 6438 | 6407 | 6443 | 6446 | 6229 | 6446 | 5805 | 6942 | 6430 |
| 2064 | 6457 | 6438 | 6418 | 6443 | 6446 | 6268 | 6446 | 5805 | 6942 | 6432 |
| 2065 | 6457 | 6438 | 6428 | 6443 | 6446 | 6312 | 6446 | 5805 | 6942 | 6435 |
| 2066 | 6457 | 6438 | 6435 | 6443 | 6446 | 6334 | 6446 | 5805 | 6942 | 6436 |
| 2067 | 6457 | 6438 | 6446 | 6443 | 6446 | 6348 | 6446 | 5805 | 6942 | 6436 |
| 2068 | 6457 | 6438 | 6446 | 6443 | 6446 | 6366 | 6446 | 5805 | 6942 | 6436 |
| 2069 | 6457 | 6438 | 6446 | 6443 | 6446 | 6377 | 6446 | 5805 | 6942 | 6436 |
| 2070 | 6457 | 6438 | 6446 | 6443 | 6446 | 6387 | 6446 | 5805 | 6942 | 6436 |
| 2071 | 6457 | 6438 | 6446 | 6443 | 6446 | 6396 | 6446 | 5805 | 6942 | 6436 |
| 2072 | 6457 | 6438 | 6446 | 6443 | 6446 | 6410 | 6446 | 5805 | 6942 | 6436 |
| 2073 | 6457 | 6438 | 6446 | 6443 | 6446 | 6420 | 6446 | 5805 | 6942 | 6436 |
| 2074 | 6457 | 6438 | 6446 | 6443 | 6446 | 6429 | 6446 | 5805 | 6942 | 6436 |
| 2075 | 6457 | 6438 | 6446 | 6443 | 6446 | 6443 | 6446 | 5805 | 6942 | 6436 |
| 2076 | 6457 | 6438 | 6446 | 6443 | 6446 | 6446 | 6446 | 5805 | 6942 | 6436 |
| 2077 | 6457 | 6438 | 6446 | 6443 | 6446 | 6446 | 6446 | 5805 | 6942 | 6436 |
| 2078 | 6457 | 6438 | 6446 | 6443 | 6446 | 6446 | 6446 | 5805 | 6942 | 6436 |
| 2079 | 6457 | 6438 | 6446 | 6443 | 6446 | 6446 | 6446 | 5805 | 6942 | 6436 |
| 2080 | 6457 | 6438 | 6446 | 6443 | 6446 | 6446 | 6446 | 5805 | 6942 | 6436 |
| 2081 | 6457 | 6438 | 6446 | 6443 | 6446 | 6446 | 6446 | 5805 | 6942 | 6436 |
| 2082 | 6457 | 6438 | 6446 | 6443 | 6446 | 6446 | 6446 | 5805 | 6942 | 6436 |
| 2083 | 6457 | 6438 | 6446 | 6443 | 6446 | 6446 | 6446 | 5805 | 6942 | 6436 |
| 2084 | 6457 | 6438 | 6446 | 6443 | 6446 | 6446 | 6446 | 5805 | 6942 | 6436 |
| 2085 | 6457 | 6438 | 6446 | 6443 | 6446 | 6446 | 6446 | 5805 | 6942 | 6436 |
| 2086 | 6457 | 6438 | 6446 | 6443 | 6446 | 6446 | 6446 | 5805 | 6942 | 6436 |
| 2087 | 6457 | 6438 | 6446 | 6443 | 6446 | 6446 | 6446 | 5805 | 6942 | 6436 |
| 2088 | 6457 | 6438 | 6446 | 6443 | 6446 | 6446 | 6446 | 5805 | 6942 | 6436 |
| 2089 | 6457 | 6438 | 6446 | 6443 | 6446 | 6446 | 6446 | 5805 | 6942 | 6436 |
| 2090 | 6457 | 6438 | 6446 | 6443 | 6446 | 6446 | 6446 | 5805 | 6942 | 6436 |

EmplacedTAD

|      | 31   | 32   | 33   | 34   | 35   | 36   | 37   | 38   | 39   | 40   |
|------|------|------|------|------|------|------|------|------|------|------|
| 2002 | 0    | 0    | 0    | 0    | 0    | 0    | 0    | 0    | 0    | 0    |
| 2003 | 0    | 0    | 0    | 0    | 0    | 0    | 0    | 0    | 0    | 0    |
| 2004 | 0    | 0    | 0    | 0    | 0    | 0    | 0    | 0    | 0    | 0    |
| 2005 | 0    | 0    | 0    | 0    | 0    | 0    | 0    | 0    | 0    | 0    |
| 2006 | 0    | 0    | 0    | 0    | 0    | 0    | 0    | 0    | 0    | 0    |
| 2007 | 0    | 0    | 0    | 0    | 0    | 0    | 0    | 0    | 0    | 0    |
| 2008 | 0    | 0    | 0    | 0    | 0    | 0    | 0    | 0    | 0    | 0    |
| 2009 | 0    | 0    | 0    | 0    | 0    | 0    | 0    | 0    | 0    | 0    |
| 2010 | 0    | 0    | 0    | 0    | 0    | 0    | 0    | 0    | 0    | 0    |
| 2011 | 0    | 0    | 0    | 0    | 0    | 0    | 0    | 0    | 0    | 0    |
| 2012 | 0    | 0    | 0    | 0    | 0    | 0    | 0    | 0    | 0    | 0    |
| 2013 | 0    | 0    | 0    | 0    | 0    | 0    | 0    | 0    | 0    | 0    |
| 2014 | 0    | 0    | 0    | 0    | 0    | 0    | 0    | 0    | 0    | 0    |
| 2015 | 0    | 0    | 0    | 0    | 0    | 0    | 0    | 0    | 0    | 0    |
| 2016 | 0    | 0    | 0    | 0    | 0    | 0    | 0    | 0    | 0    | 0    |
| 2017 | 0    | 0    | 0    | 0    | 0    | 0    | 0    | 0    | 0    | 0    |
| 2018 | 0    | 0    | 0    | 0    | 0    | 0    | 0    | 0    | 0    | 0    |
| 2019 | 0    | 0    | 0    | 0    | 0    | 0    | 0    | 0    | 0    | 0    |
| 2020 | 254  | 0    | 0    | 0    | 0    | 0    | 0    | 0    | 0    | 90   |
| 2021 | 506  | 0    | 0    | 0    | 0    | 0    | 0    | 0    | 0    | 188  |
| 2022 | 760  | 0    | 0    | 0    | 0    | 0    | 0    | 0    | 0    | 343  |
| 2023 | 1017 | 0    | 0    | 0    | 0    | 0    | 0    | 0    | 0    | 574  |
| 2024 | 1268 | 0    | 0    | 0    | 0    | 0    | 0    | 0    | 0    | 872  |
| 2025 | 1537 | 256  | 256  | 256  | 256  | 256  | 71   | 71   | 0    | 1097 |
| 2026 | 1793 | 506  | 506  | 506  | 506  | 506  | 173  | 180  | 0    | 1382 |
| 2027 | 2050 | 757  | 757  | 757  | 757  | 757  | 289  | 301  | 0    | 1636 |
| 2028 | 2306 | 1011 | 1011 | 1011 | 1011 | 1011 | 484  | 500  | 0    | 1941 |
| 2029 | 2592 | 1261 | 1261 | 1261 | 1261 | 1261 | 697  | 711  | 0    | 2221 |
| 2030 | 2872 | 1513 | 1513 | 1513 | 1513 | 1513 | 952  | 968  | 66   | 2494 |
| 2031 | 3137 | 1771 | 1775 | 1771 | 1771 | 1771 | 1269 | 1290 | 175  | 2752 |
| 2032 | 3436 | 2027 | 2053 | 2027 | 2020 | 2027 | 1532 | 1575 | 307  | 3027 |
| 2033 | 3752 | 2277 | 2327 | 2292 | 2283 | 2292 | 1817 | 1877 | 471  | 3237 |
| 2034 | 4026 | 2536 | 2591 | 2556 | 2512 | 2556 | 2081 | 2153 | 676  | 3453 |
| 2035 | 4355 | 2803 | 2864 | 2833 | 2750 | 2833 | 2314 | 2405 | 931  | 3670 |
| 2036 | 4626 | 3087 | 3119 | 3147 | 2987 | 3146 | 2582 | 2697 | 1230 | 3845 |
| 2037 | 4845 | 3362 | 3407 | 3447 | 3244 | 3444 | 2804 | 2946 | 1527 | 4038 |
| 2038 | 5107 | 3706 | 3678 | 3776 | 3520 | 3770 | 2992 | 3149 | 1831 | 4233 |
| 2039 | 5370 | 3993 | 3965 | 4053 | 3759 | 4042 | 3186 | 3369 | 2077 | 4398 |
| 2040 | 5627 | 4328 | 4273 | 4389 | 4039 | 4375 | 3420 | 3628 | 2330 | 4549 |
| 2041 | 5827 | 4595 | 4561 | 4660 | 4233 | 4613 | 3628 | 3859 | 2597 | 4762 |
| 2042 | 5930 | 4969 | 4859 | 5008 | 4565 | 4948 | 3853 | 4103 | 2900 | 4903 |
| 2043 | 6048 | 5068 | 5184 | 5155 | 4756 | 5110 | 4081 | 4367 | 3177 | 5051 |
| 2044 | 6167 | 5228 | 5330 | 5284 | 4933 | 5258 | 4258 | 4588 | 3485 | 5139 |
| 2045 | 6263 | 5397 | 5517 | 5449 | 5178 | 5437 | 4408 | 4772 | 3735 | 5251 |
| 2046 | 6346 | 5565 | 5709 | 5605 | 5359 | 5601 | 4574 | 4964 | 3971 | 5363 |
| 2047 | 6390 | 5706 | 5852 | 5764 | 5563 | 5764 | 4698 | 5109 | 4149 | 5434 |
| 2048 | 6410 | 5836 | 5973 | 5886 | 5716 | 5886 | 4795 | 5230 | 4367 | 5525 |
| 2049 | 6423 | 5946 | 6077 | 5998 | 5852 | 5998 | 4856 | 5316 | 4611 | 5697 |
| 2050 | 6434 | 6064 | 6188 | 6098 | 5988 | 6098 | 4995 | 5564 | 4818 | 5833 |
| 2051 | 6435 | 6181 | 6278 | 6211 | 6124 | 6211 | 5108 | 5750 | 4987 | 5922 |
| 2052 | 6437 | 6290 | 6345 | 6297 | 6232 | 6297 | 5227 | 5977 | 5173 | 5994 |
| 2053 | 6438 | 6352 | 6389 | 6360 | 6315 | 6360 | 5348 | 6210 | 5374 | 6050 |
| 2054 | 6438 | 6391 | 6420 | 6400 | 6370 | 6400 | 5462 | 6426 | 5550 | 6101 |
| 2055 | 6438 | 6419 | 6433 | 6432 | 6417 | 6432 | 5529 | 6568 | 5736 | 6152 |
| 2056 | 6438 | 6428 | 6437 | 6437 | 6429 | 6437 | 5568 | 6649 | 5919 | 6198 |
| 2057 | 6438 | 6430 | 6442 | 6443 | 6440 | 6443 | 5615 | 6719 | 6089 | 6240 |
| 2058 | 6438 | 6436 | 6442 | 6443 | 6443 | 6443 | 5643 | 6764 | 6198 | 6285 |
| 2059 | 6438 | 6437 | 6442 | 6443 | 6443 | 6443 | 5672 | 6796 | 6271 | 6321 |

EmplacedTAD

|      | 31   | 32   | 33   | 34   | 35   | 36   | 37   | 38   | 39   | 40   |
|------|------|------|------|------|------|------|------|------|------|------|
| 2060 | 6438 | 6437 | 6442 | 6443 | 6443 | 6443 | 5692 | 6818 | 6315 | 6352 |
| 2061 | 6438 | 6437 | 6442 | 6443 | 6443 | 6443 | 5718 | 6847 | 6347 | 6387 |
| 2062 | 6438 | 6437 | 6442 | 6443 | 6443 | 6443 | 5745 | 6876 | 6389 | 6419 |
| 2063 | 6438 | 6437 | 6442 | 6443 | 6443 | 6443 | 5774 | 6908 | 6424 | 6433 |
| 2064 | 6438 | 6437 | 6442 | 6443 | 6443 | 6443 | 5796 | 6932 | 6440 | 6436 |
| 2065 | 6438 | 6437 | 6442 | 6443 | 6443 | 6443 | 5801 | 6939 | 6440 | 6436 |
| 2066 | 6438 | 6437 | 6442 | 6443 | 6443 | 6443 | 5801 | 6939 | 6440 | 6436 |
| 2067 | 6438 | 6437 | 6442 | 6443 | 6443 | 6443 | 5801 | 6939 | 6440 | 6436 |
| 2068 | 6438 | 6437 | 6442 | 6443 | 6443 | 6443 | 5801 | 6939 | 6440 | 6436 |
| 2069 | 6438 | 6437 | 6442 | 6443 | 6443 | 6443 | 5801 | 6939 | 6440 | 6436 |
| 2070 | 6438 | 6437 | 6442 | 6443 | 6443 | 6443 | 5801 | 6939 | 6440 | 6436 |
| 2071 | 6438 | 6437 | 6442 | 6443 | 6443 | 6443 | 5801 | 6939 | 6440 | 6436 |
| 2072 | 6438 | 6437 | 6442 | 6443 | 6443 | 6443 | 5801 | 6939 | 6440 | 6436 |
| 2073 | 6438 | 6437 | 6442 | 6443 | 6443 | 6443 | 5801 | 6939 | 6440 | 6436 |
| 2074 | 6438 | 6437 | 6442 | 6443 | 6443 | 6443 | 5801 | 6939 | 6440 | 6436 |
| 2075 | 6438 | 6437 | 6442 | 6443 | 6443 | 6443 | 5801 | 6939 | 6440 | 6436 |
| 2076 | 6438 | 6437 | 6442 | 6443 | 6443 | 6443 | 5801 | 6939 | 6440 | 6436 |
| 2077 | 6438 | 6437 | 6442 | 6443 | 6443 | 6443 | 5801 | 6939 | 6440 | 6436 |
| 2078 | 6438 | 6437 | 6442 | 6443 | 6443 | 6443 | 5801 | 6939 | 6440 | 6436 |
| 2079 | 6438 | 6437 | 6442 | 6443 | 6443 | 6443 | 5801 | 6939 | 6440 | 6436 |
| 2080 | 6438 | 6437 | 6442 | 6443 | 6443 | 6443 | 5801 | 6939 | 6440 | 6436 |
| 2081 | 6438 | 6437 | 6442 | 6443 | 6443 | 6443 | 5801 | 6939 | 6440 | 6436 |
| 2082 | 6438 | 6437 | 6442 | 6443 | 6443 | 6443 | 5801 | 6939 | 6440 | 6436 |
| 2083 | 6438 | 6437 | 6442 | 6443 | 6443 | 6443 | 5801 | 6939 | 6440 | 6436 |
| 2084 | 6438 | 6437 | 6442 | 6443 | 6443 | 6443 | 5801 | 6939 | 6440 | 6436 |
| 2085 | 6438 | 6437 | 6442 | 6443 | 6443 | 6443 | 5801 | 6939 | 6440 | 6436 |
| 2086 | 6438 | 6437 | 6442 | 6443 | 6443 | 6443 | 5801 | 6939 | 6440 | 6436 |
| 2087 | 6438 | 6437 | 6442 | 6443 | 6443 | 6443 | 5801 | 6939 | 6440 | 6436 |
| 2088 | 6438 | 6437 | 6442 | 6443 | 6443 | 6443 | 5801 | 6939 | 6440 | 6436 |
| 2089 | 6438 | 6437 | 6442 | 6443 | 6443 | 6443 | 5801 | 6939 | 6440 | 6436 |
| 2090 | 6438 | 6437 | 6442 | 6443 | 6443 | 6443 | 5801 | 6939 | 6440 | 6436 |



EmplacedTAD

|      | 41   | 42   | 43   | 44   | 45   | 46   | 47   | 48   | 49   | 50   |
|------|------|------|------|------|------|------|------|------|------|------|
| 2002 | 0    | 0    | 0    | 0    | 0    | 0    | 0    | 0    | 0    | 0    |
| 2003 | 0    | 0    | 0    | 0    | 0    | 0    | 0    | 0    | 0    | 0    |
| 2004 | 0    | 0    | 0    | 0    | 0    | 0    | 0    | 0    | 0    | 0    |
| 2005 | 0    | 0    | 0    | 0    | 0    | 0    | 0    | 0    | 0    | 0    |
| 2006 | 0    | 0    | 0    | 0    | 0    | 0    | 0    | 0    | 0    | 0    |
| 2007 | 0    | 0    | 0    | 0    | 0    | 0    | 0    | 0    | 0    | 0    |
| 2008 | 0    | 0    | 0    | 0    | 0    | 0    | 0    | 0    | 0    | 0    |
| 2009 | 0    | 0    | 0    | 0    | 0    | 0    | 0    | 0    | 0    | 0    |
| 2010 | 0    | 0    | 0    | 0    | 0    | 0    | 0    | 0    | 0    | 0    |
| 2011 | 0    | 0    | 0    | 0    | 0    | 0    | 0    | 0    | 0    | 0    |
| 2012 | 0    | 0    | 0    | 0    | 0    | 0    | 0    | 0    | 0    | 0    |
| 2013 | 0    | 0    | 0    | 0    | 0    | 0    | 0    | 0    | 0    | 0    |
| 2014 | 0    | 0    | 0    | 0    | 0    | 0    | 0    | 0    | 0    | 0    |
| 2015 | 0    | 0    | 0    | 0    | 0    | 0    | 0    | 0    | 0    | 0    |
| 2016 | 0    | 0    | 0    | 0    | 0    | 0    | 0    | 0    | 0    | 0    |
| 2017 | 0    | 0    | 0    | 0    | 0    | 0    | 0    | 0    | 0    | 0    |
| 2018 | 0    | 0    | 0    | 0    | 0    | 0    | 0    | 0    | 0    | 0    |
| 2019 | 0    | 0    | 0    | 0    | 0    | 0    | 0    | 0    | 0    | 0    |
| 2020 | 0    | 0    | 0    | 0    | 0    | 0    | 0    | 0    | 10   | 0    |
| 2021 | 0    | 0    | 0    | 0    | 0    | 0    | 0    | 0    | 29   | 0    |
| 2022 | 0    | 0    | 0    | 0    | 0    | 0    | 0    | 0    | 76   | 0    |
| 2023 | 0    | 0    | 0    | 0    | 0    | 0    | 0    | 0    | 154  | 0    |
| 2024 | 0    | 0    | 0    | 0    | 0    | 0    | 0    | 0    | 255  | 0    |
| 2025 | 64   | 174  | 244  | 4    | 71   | 17   | 17   | 0    | 383  | 12   |
| 2026 | 164  | 345  | 486  | 28   | 178  | 48   | 51   | 0    | 584  | 21   |
| 2027 | 280  | 574  | 741  | 41   | 294  | 97   | 105  | 0    | 813  | 39   |
| 2028 | 426  | 798  | 987  | 81   | 495  | 150  | 163  | 0    | 1102 | 83   |
| 2029 | 592  | 1021 | 1240 | 147  | 712  | 251  | 268  | 0    | 1351 | 143  |
| 2030 | 805  | 1250 | 1493 | 218  | 971  | 400  | 424  | 10   | 1654 | 235  |
| 2031 | 1101 | 1494 | 1732 | 324  | 1292 | 566  | 595  | 54   | 1920 | 367  |
| 2032 | 1356 | 1734 | 1985 | 427  | 1566 | 759  | 794  | 119  | 2224 | 520  |
| 2033 | 1689 | 1979 | 2233 | 608  | 1856 | 984  | 1030 | 204  | 2476 | 689  |
| 2034 | 2028 | 2235 | 2506 | 766  | 2124 | 1292 | 1354 | 356  | 2782 | 873  |
| 2035 | 2339 | 2458 | 2780 | 921  | 2388 | 1595 | 1667 | 512  | 3058 | 1068 |
| 2036 | 2586 | 2714 | 3019 | 1108 | 2695 | 1912 | 1982 | 668  | 3325 | 1336 |
| 2037 | 2804 | 2968 | 3233 | 1327 | 2933 | 2195 | 2275 | 880  | 3595 | 1705 |
| 2038 | 2975 | 3228 | 3442 | 1528 | 3144 | 2490 | 2590 | 1123 | 3850 | 2028 |
| 2039 | 3171 | 3444 | 3656 | 1765 | 3366 | 2741 | 2884 | 1433 | 4102 | 2369 |
| 2040 | 3392 | 3688 | 3877 | 2015 | 3585 | 2981 | 3142 | 1768 | 4328 | 2676 |
| 2041 | 3619 | 3918 | 4121 | 2276 | 3792 | 3237 | 3405 | 2082 | 4606 | 2982 |
| 2042 | 3847 | 4217 | 4347 | 2568 | 4030 | 3506 | 3685 | 2336 | 4879 | 3232 |
| 2043 | 4036 | 4466 | 4570 | 2902 | 4271 | 3782 | 3986 | 2609 | 5153 | 3504 |
| 2044 | 4231 | 4657 | 4752 | 3187 | 4461 | 4013 | 4250 | 2888 | 5351 | 3759 |
| 2045 | 4442 | 4855 | 4930 | 3481 | 4642 | 4302 | 4556 | 3183 | 5556 | 4031 |
| 2046 | 4632 | 5009 | 5088 | 3716 | 4817 | 4517 | 4786 | 3463 | 5767 | 4262 |
| 2047 | 4743 | 5274 | 5254 | 3925 | 4967 | 4713 | 5074 | 3697 | 5987 | 4586 |
| 2048 | 4914 | 5432 | 5362 | 4113 | 5069 | 4942 | 5397 | 4011 | 6133 | 4933 |
| 2049 | 5107 | 5655 | 5447 | 4341 | 5161 | 5124 | 5672 | 4321 | 6195 | 5139 |
| 2050 | 5307 | 5830 | 5646 | 4618 | 5367 | 5254 | 5909 | 4594 | 6231 | 5330 |
| 2051 | 5477 | 6004 | 5818 | 4856 | 5543 | 5403 | 6163 | 4804 | 6271 | 5541 |
| 2052 | 5669 | 6173 | 5997 | 5085 | 5740 | 5514 | 6395 | 5014 | 6287 | 5774 |
| 2053 | 5856 | 6292 | 6152 | 5323 | 5916 | 5608 | 6598 | 5240 | 6307 | 5988 |
| 2054 | 6002 | 6357 | 6307 | 5538 | 6066 | 5673 | 6722 | 5460 | 6332 | 6119 |
| 2055 | 6079 | 6396 | 6375 | 5675 | 6147 | 5706 | 6789 | 5647 | 6350 | 6216 |
| 2056 | 6157 | 6425 | 6417 | 5747 | 6206 | 5737 | 6840 | 5836 | 6370 | 6256 |
| 2057 | 6217 | 6435 | 6438 | 5814 | 6259 | 5756 | 6882 | 6028 | 6397 | 6329 |
| 2058 | 6241 | 6439 | 6444 | 5867 | 6285 | 5770 | 6899 | 6188 | 6412 | 6363 |
| 2059 | 6280 | 6439 | 6444 | 5915 | 6314 | 5782 | 6911 | 6272 | 6437 | 6378 |

EmplacedTAD

|      | 41   | 42   | 43   | 44   | 45   | 46   | 47   | 48   | 49   | 50   |
|------|------|------|------|------|------|------|------|------|------|------|
| 2060 | 6302 | 6439 | 6444 | 5950 | 6338 | 5788 | 6916 | 6317 | 6441 | 6397 |
| 2061 | 6322 | 6439 | 6444 | 5992 | 6362 | 5797 | 6925 | 6349 | 6446 | 6401 |
| 2062 | 6340 | 6439 | 6444 | 6025 | 6388 | 5811 | 6938 | 6380 | 6446 | 6411 |
| 2063 | 6363 | 6439 | 6444 | 6056 | 6415 | 5812 | 6940 | 6408 | 6446 | 6413 |
| 2064 | 6383 | 6439 | 6444 | 6084 | 6437 | 5812 | 6940 | 6430 | 6446 | 6422 |
| 2065 | 6402 | 6439 | 6444 | 6138 | 6444 | 5812 | 6940 | 6433 | 6446 | 6430 |
| 2066 | 6419 | 6439 | 6444 | 6163 | 6444 | 5812 | 6940 | 6433 | 6446 | 6437 |
| 2067 | 6433 | 6439 | 6444 | 6193 | 6444 | 5812 | 6940 | 6435 | 6446 | 6445 |
| 2068 | 6437 | 6439 | 6444 | 6219 | 6444 | 5812 | 6940 | 6435 | 6446 | 6445 |
| 2069 | 6437 | 6439 | 6444 | 6239 | 6444 | 5812 | 6940 | 6435 | 6446 | 6445 |
| 2070 | 6437 | 6439 | 6444 | 6266 | 6444 | 5812 | 6940 | 6435 | 6446 | 6445 |
| 2071 | 6437 | 6439 | 6444 | 6287 | 6444 | 5812 | 6940 | 6435 | 6446 | 6445 |
| 2072 | 6437 | 6439 | 6444 | 6315 | 6444 | 5812 | 6940 | 6435 | 6446 | 6445 |
| 2073 | 6437 | 6439 | 6444 | 6339 | 6444 | 5812 | 6940 | 6435 | 6446 | 6445 |
| 2074 | 6437 | 6439 | 6444 | 6361 | 6444 | 5812 | 6940 | 6435 | 6446 | 6445 |
| 2075 | 6437 | 6439 | 6444 | 6388 | 6444 | 5812 | 6940 | 6435 | 6446 | 6445 |
| 2076 | 6437 | 6439 | 6444 | 6410 | 6444 | 5812 | 6940 | 6435 | 6446 | 6445 |
| 2077 | 6437 | 6439 | 6444 | 6434 | 6444 | 5812 | 6940 | 6435 | 6446 | 6445 |
| 2078 | 6437 | 6439 | 6444 | 6444 | 6444 | 5812 | 6940 | 6435 | 6446 | 6445 |
| 2079 | 6437 | 6439 | 6444 | 6444 | 6444 | 5812 | 6940 | 6435 | 6446 | 6445 |
| 2080 | 6437 | 6439 | 6444 | 6444 | 6444 | 5812 | 6940 | 6435 | 6446 | 6445 |
| 2081 | 6437 | 6439 | 6444 | 6444 | 6444 | 5812 | 6940 | 6435 | 6446 | 6445 |
| 2082 | 6437 | 6439 | 6444 | 6444 | 6444 | 5812 | 6940 | 6435 | 6446 | 6445 |
| 2083 | 6437 | 6439 | 6444 | 6444 | 6444 | 5812 | 6940 | 6435 | 6446 | 6445 |
| 2084 | 6437 | 6439 | 6444 | 6444 | 6444 | 5812 | 6940 | 6435 | 6446 | 6445 |
| 2085 | 6437 | 6439 | 6444 | 6444 | 6444 | 5812 | 6940 | 6435 | 6446 | 6445 |
| 2086 | 6437 | 6439 | 6444 | 6444 | 6444 | 5812 | 6940 | 6435 | 6446 | 6445 |
| 2087 | 6437 | 6439 | 6444 | 6444 | 6444 | 5812 | 6940 | 6435 | 6446 | 6445 |
| 2088 | 6437 | 6439 | 6444 | 6444 | 6444 | 5812 | 6940 | 6435 | 6446 | 6445 |
| 2089 | 6437 | 6439 | 6444 | 6444 | 6444 | 5812 | 6940 | 6435 | 6446 | 6445 |
| 2090 | 6437 | 6439 | 6444 | 6444 | 6444 | 5812 | 6940 | 6435 | 6446 | 6445 |

EmplacedTAD

|      | 51   | 52   | 53   | 54   | 55   | 56   | 57   | 58   | 59   | 60   |
|------|------|------|------|------|------|------|------|------|------|------|
| 2002 | 0    | 0    | 0    | 0    | 0    | 0    | 0    | 0    | 0    | 0    |
| 2003 | 0    | 0    | 0    | 0    | 0    | 0    | 0    | 0    | 0    | 0    |
| 2004 | 0    | 0    | 0    | 0    | 0    | 0    | 0    | 0    | 0    | 0    |
| 2005 | 0    | 0    | 0    | 0    | 0    | 0    | 0    | 0    | 0    | 0    |
| 2006 | 0    | 0    | 0    | 0    | 0    | 0    | 0    | 0    | 0    | 0    |
| 2007 | 0    | 0    | 0    | 0    | 0    | 0    | 0    | 0    | 0    | 0    |
| 2008 | 0    | 0    | 0    | 0    | 0    | 0    | 0    | 0    | 0    | 0    |
| 2009 | 0    | 0    | 0    | 0    | 0    | 0    | 0    | 0    | 0    | 0    |
| 2010 | 0    | 0    | 0    | 0    | 0    | 0    | 0    | 0    | 0    | 0    |
| 2011 | 0    | 0    | 0    | 0    | 0    | 0    | 0    | 0    | 0    | 0    |
| 2012 | 0    | 0    | 0    | 0    | 0    | 0    | 0    | 0    | 0    | 0    |
| 2013 | 0    | 0    | 0    | 0    | 0    | 0    | 0    | 0    | 0    | 0    |
| 2014 | 0    | 0    | 0    | 0    | 0    | 0    | 0    | 0    | 0    | 0    |
| 2015 | 0    | 0    | 0    | 0    | 0    | 0    | 0    | 0    | 0    | 0    |
| 2016 | 0    | 0    | 0    | 0    | 0    | 0    | 0    | 0    | 0    | 0    |
| 2017 | 0    | 0    | 0    | 0    | 0    | 0    | 0    | 0    | 0    | 0    |
| 2018 | 0    | 0    | 0    | 0    | 0    | 0    | 0    | 0    | 0    | 0    |
| 2019 | 0    | 0    | 0    | 0    | 0    | 0    | 0    | 0    | 0    | 0    |
| 2020 | 0    | 0    | 0    | 0    | 0    | 0    | 0    | 254  | 0    | 0    |
| 2021 | 0    | 0    | 0    | 0    | 0    | 0    | 0    | 527  | 0    | 0    |
| 2022 | 0    | 0    | 0    | 0    | 0    | 0    | 0    | 825  | 0    | 0    |
| 2023 | 0    | 0    | 0    | 0    | 0    | 0    | 0    | 1067 | 0    | 0    |
| 2024 | 0    | 0    | 0    | 0    | 0    | 0    | 0    | 1324 | 0    | 0    |
| 2025 | 63   | 64   | 1    | 17   | 256  | 256  | 0    | 1586 | 256  | 256  |
| 2026 | 185  | 191  | 2    | 48   | 508  | 518  | 0    | 1882 | 518  | 518  |
| 2027 | 311  | 383  | 10   | 99   | 804  | 831  | 0    | 2147 | 826  | 826  |
| 2028 | 516  | 635  | 30   | 156  | 1054 | 1108 | 0    | 2380 | 1106 | 1106 |
| 2029 | 764  | 909  | 72   | 261  | 1293 | 1414 | 0    | 2635 | 1393 | 1393 |
| 2030 | 991  | 1159 | 109  | 417  | 1519 | 1721 | 256  | 2917 | 1681 | 1681 |
| 2031 | 1265 | 1479 | 142  | 588  | 1748 | 2015 | 528  | 3199 | 1947 | 1947 |
| 2032 | 1513 | 1760 | 189  | 783  | 1968 | 2292 | 824  | 3503 | 2196 | 2196 |
| 2033 | 1725 | 2007 | 258  | 1010 | 2209 | 2594 | 1153 | 3809 | 2449 | 2449 |
| 2034 | 2019 | 2238 | 337  | 1317 | 2447 | 2876 | 1465 | 4103 | 2707 | 2707 |
| 2035 | 2245 | 2525 | 426  | 1628 | 2699 | 3137 | 1832 | 4397 | 2978 | 2977 |
| 2036 | 2469 | 2784 | 538  | 1949 | 2990 | 3443 | 2175 | 4763 | 3284 | 3275 |
| 2037 | 2712 | 3060 | 640  | 2237 | 3288 | 3730 | 2475 | 5016 | 3529 | 3560 |
| 2038 | 2947 | 3297 | 774  | 2542 | 3548 | 4043 | 2729 | 5251 | 3833 | 3903 |
| 2039 | 3193 | 3545 | 949  | 2829 | 3848 | 4353 | 2987 | 5541 | 4146 | 4186 |
| 2040 | 3481 | 3780 | 1105 | 3075 | 4195 | 4717 | 3224 | 5787 | 4454 | 4498 |
| 2041 | 3745 | 4048 | 1309 | 3341 | 4562 | 5063 | 3486 | 6065 | 4833 | 4860 |
| 2042 | 4095 | 4340 | 1503 | 3606 | 4847 | 5348 | 3747 | 6153 | 5109 | 5156 |
| 2043 | 4368 | 4562 | 1762 | 3889 | 5271 | 5755 | 4014 | 6216 | 5453 | 5516 |
| 2044 | 4664 | 4822 | 2029 | 4139 | 5477 | 6052 | 4294 | 6330 | 5755 | 5764 |
| 2045 | 4903 | 5050 | 2318 | 4437 | 5504 | 6088 | 4626 | 6370 | 5815 | 5830 |
| 2046 | 5129 | 5235 | 2653 | 4673 | 5690 | 6339 | 4971 | 6393 | 6054 | 6069 |
| 2047 | 5347 | 5378 | 3059 | 4907 | 5769 | 6525 | 5219 | 6416 | 6208 | 6226 |
| 2048 | 5554 | 5578 | 3437 | 5209 | 5799 | 6704 | 5275 | 6424 | 6348 | 6361 |
| 2049 | 5745 | 5754 | 3798 | 5458 | 5807 | 6821 | 5495 | 6430 | 6422 | 6425 |
| 2050 | 5944 | 5894 | 4178 | 5635 | 5807 | 6900 | 5712 | 6436 | 6441 | 6440 |
| 2051 | 6113 | 6039 | 4496 | 5851 | 5807 | 6937 | 5881 | 6436 | 6442 | 6440 |
| 2052 | 6262 | 6200 | 4796 | 6036 | 5807 | 6937 | 6000 | 6436 | 6442 | 6440 |
| 2053 | 6334 | 6316 | 5121 | 6174 | 5807 | 6937 | 6169 | 6436 | 6442 | 6440 |
| 2054 | 6385 | 6371 | 5323 | 6263 | 5807 | 6937 | 6314 | 6436 | 6442 | 6440 |
| 2055 | 6421 | 6402 | 5510 | 6313 | 5807 | 6937 | 6396 | 6436 | 6442 | 6440 |
| 2056 | 6429 | 6423 | 5651 | 6354 | 5807 | 6937 | 6435 | 6436 | 6442 | 6440 |
| 2057 | 6436 | 6431 | 5776 | 6380 | 5807 | 6937 | 6439 | 6436 | 6442 | 6440 |
| 2058 | 6436 | 6431 | 5856 | 6391 | 5807 | 6937 | 6439 | 6436 | 6442 | 6440 |
| 2059 | 6437 | 6436 | 5941 | 6405 | 5807 | 6937 | 6439 | 6436 | 6442 | 6440 |

EmplacedTAD

|      | 51   | 52   | 53   | 54   | 55   | 56   | 57   | 58   | 59   | 60   |
|------|------|------|------|------|------|------|------|------|------|------|
| 2060 | 6437 | 6436 | 6040 | 6411 | 5807 | 6937 | 6439 | 6436 | 6442 | 6440 |
| 2061 | 6437 | 6436 | 6102 | 6421 | 5807 | 6937 | 6439 | 6436 | 6442 | 6440 |
| 2062 | 6437 | 6436 | 6155 | 6434 | 5807 | 6937 | 6439 | 6436 | 6442 | 6440 |
| 2063 | 6437 | 6436 | 6214 | 6436 | 5807 | 6937 | 6439 | 6436 | 6442 | 6440 |
| 2064 | 6437 | 6436 | 6252 | 6436 | 5807 | 6937 | 6439 | 6436 | 6442 | 6440 |
| 2065 | 6437 | 6436 | 6299 | 6436 | 5807 | 6937 | 6439 | 6436 | 6442 | 6440 |
| 2066 | 6437 | 6436 | 6319 | 6436 | 5807 | 6937 | 6439 | 6436 | 6442 | 6440 |
| 2067 | 6437 | 6436 | 6331 | 6436 | 5807 | 6937 | 6439 | 6436 | 6442 | 6440 |
| 2068 | 6437 | 6436 | 6359 | 6436 | 5807 | 6937 | 6439 | 6436 | 6442 | 6440 |
| 2069 | 6437 | 6436 | 6374 | 6436 | 5807 | 6937 | 6439 | 6436 | 6442 | 6440 |
| 2070 | 6437 | 6436 | 6386 | 6436 | 5807 | 6937 | 6439 | 6436 | 6442 | 6440 |
| 2071 | 6437 | 6436 | 6397 | 6436 | 5807 | 6937 | 6439 | 6436 | 6442 | 6440 |
| 2072 | 6437 | 6436 | 6407 | 6436 | 5807 | 6937 | 6439 | 6436 | 6442 | 6440 |
| 2073 | 6437 | 6436 | 6413 | 6436 | 5807 | 6937 | 6439 | 6436 | 6442 | 6440 |
| 2074 | 6437 | 6436 | 6421 | 6436 | 5807 | 6937 | 6439 | 6436 | 6442 | 6440 |
| 2075 | 6437 | 6436 | 6433 | 6436 | 5807 | 6937 | 6439 | 6436 | 6442 | 6440 |
| 2076 | 6437 | 6436 | 6436 | 6436 | 5807 | 6937 | 6439 | 6436 | 6442 | 6440 |
| 2077 | 6437 | 6436 | 6436 | 6436 | 5807 | 6937 | 6439 | 6436 | 6442 | 6440 |
| 2078 | 6437 | 6436 | 6436 | 6436 | 5807 | 6937 | 6439 | 6436 | 6442 | 6440 |
| 2079 | 6437 | 6436 | 6436 | 6436 | 5807 | 6937 | 6439 | 6436 | 6442 | 6440 |
| 2080 | 6437 | 6436 | 6436 | 6436 | 5807 | 6937 | 6439 | 6436 | 6442 | 6440 |
| 2081 | 6437 | 6436 | 6436 | 6436 | 5807 | 6937 | 6439 | 6436 | 6442 | 6440 |
| 2082 | 6437 | 6436 | 6436 | 6436 | 5807 | 6937 | 6439 | 6436 | 6442 | 6440 |
| 2083 | 6437 | 6436 | 6436 | 6436 | 5807 | 6937 | 6439 | 6436 | 6442 | 6440 |
| 2084 | 6437 | 6436 | 6436 | 6436 | 5807 | 6937 | 6439 | 6436 | 6442 | 6440 |
| 2085 | 6437 | 6436 | 6436 | 6436 | 5807 | 6937 | 6439 | 6436 | 6442 | 6440 |
| 2086 | 6437 | 6436 | 6436 | 6436 | 5807 | 6937 | 6439 | 6436 | 6442 | 6440 |
| 2087 | 6437 | 6436 | 6436 | 6436 | 5807 | 6937 | 6439 | 6436 | 6442 | 6440 |
| 2088 | 6437 | 6436 | 6436 | 6436 | 5807 | 6937 | 6439 | 6436 | 6442 | 6440 |
| 2089 | 6437 | 6436 | 6436 | 6436 | 5807 | 6937 | 6439 | 6436 | 6442 | 6440 |
| 2090 | 6437 | 6436 | 6436 | 6436 | 5807 | 6937 | 6439 | 6436 | 6442 | 6440 |

EmplacedTAD

|      | 61   | 62   | 63   | 64   | 65   | 66   | 67   | 68   | 69   | 70   |
|------|------|------|------|------|------|------|------|------|------|------|
| 2002 | 0    | 0    | 0    | 0    | 0    | 0    | 0    | 0    | 0    | 0    |
| 2003 | 0    | 0    | 0    | 0    | 0    | 0    | 0    | 0    | 0    | 0    |
| 2004 | 0    | 0    | 0    | 0    | 0    | 0    | 0    | 0    | 0    | 0    |
| 2005 | 0    | 0    | 0    | 0    | 0    | 0    | 0    | 0    | 0    | 0    |
| 2006 | 0    | 0    | 0    | 0    | 0    | 0    | 0    | 0    | 0    | 0    |
| 2007 | 0    | 0    | 0    | 0    | 0    | 0    | 0    | 0    | 0    | 0    |
| 2008 | 0    | 0    | 0    | 0    | 0    | 0    | 0    | 0    | 0    | 0    |
| 2009 | 0    | 0    | 0    | 0    | 0    | 0    | 0    | 0    | 0    | 0    |
| 2010 | 0    | 0    | 0    | 0    | 0    | 0    | 0    | 0    | 0    | 0    |
| 2011 | 0    | 0    | 0    | 0    | 0    | 0    | 0    | 0    | 0    | 0    |
| 2012 | 0    | 0    | 0    | 0    | 0    | 0    | 0    | 0    | 0    | 0    |
| 2013 | 0    | 0    | 0    | 0    | 0    | 0    | 0    | 0    | 0    | 0    |
| 2014 | 0    | 0    | 0    | 0    | 0    | 0    | 0    | 0    | 0    | 0    |
| 2015 | 0    | 0    | 0    | 0    | 0    | 0    | 0    | 0    | 0    | 0    |
| 2016 | 0    | 0    | 0    | 0    | 0    | 0    | 0    | 0    | 0    | 0    |
| 2017 | 0    | 0    | 0    | 0    | 0    | 0    | 0    | 0    | 0    | 0    |
| 2018 | 0    | 0    | 0    | 0    | 0    | 0    | 0    | 0    | 0    | 0    |
| 2019 | 0    | 0    | 0    | 0    | 0    | 0    | 0    | 0    | 0    | 0    |
| 2020 | 0    | 0    | 0    | 0    | 0    | 0    | 90   | 0    | 0    | 0    |
| 2021 | 0    | 0    | 0    | 0    | 0    | 0    | 248  | 0    | 0    | 0    |
| 2022 | 0    | 0    | 0    | 0    | 0    | 0    | 480  | 0    | 0    | 0    |
| 2023 | 0    | 0    | 0    | 0    | 0    | 0    | 736  | 0    | 0    | 0    |
| 2024 | 0    | 0    | 0    | 0    | 0    | 0    | 1010 | 0    | 0    | 0    |
| 2025 | 256  | 256  | 256  | 71   | 71   | 0    | 1212 | 64   | 174  | 244  |
| 2026 | 518  | 518  | 518  | 237  | 299  | 0    | 1491 | 251  | 454  | 584  |
| 2027 | 826  | 826  | 826  | 414  | 526  | 0    | 1751 | 430  | 776  | 917  |
| 2028 | 1106 | 1106 | 1106 | 654  | 819  | 0    | 2063 | 627  | 1102 | 1261 |
| 2029 | 1393 | 1393 | 1393 | 859  | 1082 | 0    | 2343 | 834  | 1353 | 1552 |
| 2030 | 1681 | 1681 | 1681 | 1105 | 1375 | 66   | 2646 | 1076 | 1590 | 1821 |
| 2031 | 1947 | 1947 | 1947 | 1405 | 1713 | 317  | 2910 | 1400 | 1826 | 2089 |
| 2032 | 2196 | 2196 | 2196 | 1647 | 1995 | 570  | 3198 | 1675 | 2069 | 2368 |
| 2033 | 2449 | 2448 | 2449 | 1915 | 2300 | 829  | 3413 | 2025 | 2332 | 2619 |
| 2034 | 2707 | 2700 | 2707 | 2213 | 2630 | 1137 | 3676 | 2374 | 2603 | 2907 |
| 2035 | 2978 | 2960 | 2978 | 2504 | 2929 | 1426 | 3895 | 2710 | 2862 | 3204 |
| 2036 | 3284 | 3252 | 3284 | 2786 | 3237 | 1748 | 4089 | 2964 | 3133 | 3432 |
| 2037 | 3530 | 3479 | 3530 | 3042 | 3488 | 2065 | 4304 | 3183 | 3403 | 3639 |
| 2038 | 3835 | 3732 | 3835 | 3251 | 3712 | 2392 | 4496 | 3392 | 3703 | 3852 |
| 2039 | 4145 | 3988 | 4145 | 3448 | 3933 | 2659 | 4710 | 3603 | 3951 | 4066 |
| 2040 | 4508 | 4275 | 4508 | 3687 | 4182 | 2915 | 4873 | 3834 | 4200 | 4324 |
| 2041 | 4886 | 4610 | 4878 | 3899 | 4418 | 3229 | 5056 | 4079 | 4449 | 4584 |
| 2042 | 5183 | 4902 | 5172 | 4127 | 4673 | 3546 | 5291 | 4349 | 4709 | 4834 |
| 2043 | 5625 | 5319 | 5601 | 4358 | 4911 | 3806 | 5522 | 4563 | 4906 | 5044 |
| 2044 | 5856 | 5540 | 5830 | 4541 | 5111 | 4079 | 5644 | 4721 | 5114 | 5234 |
| 2045 | 5883 | 5642 | 5869 | 4687 | 5263 | 4295 | 5697 | 4881 | 5398 | 5414 |
| 2046 | 6097 | 5878 | 6085 | 4886 | 5458 | 4536 | 5906 | 5045 | 5530 | 5576 |
| 2047 | 6259 | 6083 | 6253 | 4949 | 5519 | 4742 | 5970 | 5107 | 5654 | 5621 |
| 2048 | 6377 | 6231 | 6373 | 5028 | 5608 | 4886 | 6027 | 5199 | 5934 | 5650 |
| 2049 | 6427 | 6300 | 6427 | 5293 | 5889 | 4927 | 6064 | 5502 | 6181 | 5915 |
| 2050 | 6437 | 6344 | 6437 | 5472 | 6175 | 5220 | 6103 | 5780 | 6291 | 6147 |
| 2051 | 6437 | 6369 | 6437 | 5552 | 6428 | 5483 | 6143 | 5968 | 6360 | 6300 |
| 2052 | 6437 | 6389 | 6437 | 5592 | 6587 | 5762 | 6185 | 6072 | 6400 | 6383 |
| 2053 | 6437 | 6405 | 6437 | 5621 | 6676 | 5991 | 6220 | 6124 | 6412 | 6424 |
| 2054 | 6437 | 6414 | 6437 | 5640 | 6736 | 6146 | 6253 | 6153 | 6427 | 6436 |
| 2055 | 6437 | 6419 | 6437 | 5657 | 6777 | 6282 | 6299 | 6176 | 6438 | 6437 |
| 2056 | 6437 | 6424 | 6437 | 5672 | 6798 | 6340 | 6329 | 6223 | 6438 | 6437 |
| 2057 | 6437 | 6431 | 6437 | 5701 | 6829 | 6373 | 6369 | 6262 | 6438 | 6437 |
| 2058 | 6437 | 6433 | 6437 | 5719 | 6845 | 6377 | 6395 | 6278 | 6438 | 6437 |
| 2059 | 6437 | 6435 | 6437 | 5740 | 6865 | 6389 | 6416 | 6307 | 6438 | 6437 |

EmplacedTAD

|      | 61   | 62   | 63   | 64   | 65   | 66   | 67   | 68   | 69   | 70   |
|------|------|------|------|------|------|------|------|------|------|------|
| 2060 | 6437 | 6437 | 6437 | 5754 | 6880 | 6393 | 6431 | 6328 | 6438 | 6437 |
| 2061 | 6437 | 6437 | 6437 | 5772 | 6896 | 6397 | 6436 | 6342 | 6438 | 6437 |
| 2062 | 6437 | 6437 | 6437 | 5792 | 6919 | 6414 | 6436 | 6362 | 6438 | 6437 |
| 2063 | 6437 | 6437 | 6437 | 5798 | 6927 | 6426 | 6436 | 6376 | 6438 | 6437 |
| 2064 | 6437 | 6437 | 6437 | 5801 | 6937 | 6436 | 6436 | 6400 | 6438 | 6437 |
| 2065 | 6437 | 6437 | 6437 | 5801 | 6937 | 6437 | 6436 | 6413 | 6438 | 6437 |
| 2066 | 6437 | 6437 | 6437 | 5801 | 6937 | 6437 | 6436 | 6426 | 6438 | 6437 |
| 2067 | 6437 | 6437 | 6437 | 5801 | 6937 | 6437 | 6436 | 6437 | 6438 | 6437 |
| 2068 | 6437 | 6437 | 6437 | 5801 | 6937 | 6437 | 6436 | 6438 | 6438 | 6437 |
| 2069 | 6437 | 6437 | 6437 | 5801 | 6937 | 6437 | 6436 | 6438 | 6438 | 6437 |
| 2070 | 6437 | 6437 | 6437 | 5801 | 6937 | 6437 | 6436 | 6438 | 6438 | 6437 |
| 2071 | 6437 | 6437 | 6437 | 5801 | 6937 | 6437 | 6436 | 6438 | 6438 | 6437 |
| 2072 | 6437 | 6437 | 6437 | 5801 | 6937 | 6437 | 6436 | 6438 | 6438 | 6437 |
| 2073 | 6437 | 6437 | 6437 | 5801 | 6937 | 6437 | 6436 | 6438 | 6438 | 6437 |
| 2074 | 6437 | 6437 | 6437 | 5801 | 6937 | 6437 | 6436 | 6438 | 6438 | 6437 |
| 2075 | 6437 | 6437 | 6437 | 5801 | 6937 | 6437 | 6436 | 6438 | 6438 | 6437 |
| 2076 | 6437 | 6437 | 6437 | 5801 | 6937 | 6437 | 6436 | 6438 | 6438 | 6437 |
| 2077 | 6437 | 6437 | 6437 | 5801 | 6937 | 6437 | 6436 | 6438 | 6438 | 6437 |
| 2078 | 6437 | 6437 | 6437 | 5801 | 6937 | 6437 | 6436 | 6438 | 6438 | 6437 |
| 2079 | 6437 | 6437 | 6437 | 5801 | 6937 | 6437 | 6436 | 6438 | 6438 | 6437 |
| 2080 | 6437 | 6437 | 6437 | 5801 | 6937 | 6437 | 6436 | 6438 | 6438 | 6437 |
| 2081 | 6437 | 6437 | 6437 | 5801 | 6937 | 6437 | 6436 | 6438 | 6438 | 6437 |
| 2082 | 6437 | 6437 | 6437 | 5801 | 6937 | 6437 | 6436 | 6438 | 6438 | 6437 |
| 2083 | 6437 | 6437 | 6437 | 5801 | 6937 | 6437 | 6436 | 6438 | 6438 | 6437 |
| 2084 | 6437 | 6437 | 6437 | 5801 | 6937 | 6437 | 6436 | 6438 | 6438 | 6437 |
| 2085 | 6437 | 6437 | 6437 | 5801 | 6937 | 6437 | 6436 | 6438 | 6438 | 6437 |
| 2086 | 6437 | 6437 | 6437 | 5801 | 6937 | 6437 | 6436 | 6438 | 6438 | 6437 |
| 2087 | 6437 | 6437 | 6437 | 5801 | 6937 | 6437 | 6436 | 6438 | 6438 | 6437 |
| 2088 | 6437 | 6437 | 6437 | 5801 | 6937 | 6437 | 6436 | 6438 | 6438 | 6437 |
| 2089 | 6437 | 6437 | 6437 | 5801 | 6937 | 6437 | 6436 | 6438 | 6438 | 6437 |
| 2090 | 6437 | 6437 | 6437 | 5801 | 6937 | 6437 | 6436 | 6438 | 6438 | 6437 |

EmplacedTAD

|      | 71   | 72   | 73   | 74   | 75   | 76   | 77   | 78   | 79   | 80   |
|------|------|------|------|------|------|------|------|------|------|------|
| 2002 | 0    | 0    | 0    | 0    | 0    | 0    | 0    | 0    | 0    | 0    |
| 2003 | 0    | 0    | 0    | 0    | 0    | 0    | 0    | 0    | 0    | 0    |
| 2004 | 0    | 0    | 0    | 0    | 0    | 0    | 0    | 0    | 0    | 0    |
| 2005 | 0    | 0    | 0    | 0    | 0    | 0    | 0    | 0    | 0    | 0    |
| 2006 | 0    | 0    | 0    | 0    | 0    | 0    | 0    | 0    | 0    | 0    |
| 2007 | 0    | 0    | 0    | 0    | 0    | 0    | 0    | 0    | 0    | 0    |
| 2008 | 0    | 0    | 0    | 0    | 0    | 0    | 0    | 0    | 0    | 0    |
| 2009 | 0    | 0    | 0    | 0    | 0    | 0    | 0    | 0    | 0    | 0    |
| 2010 | 0    | 0    | 0    | 0    | 0    | 0    | 0    | 0    | 0    | 0    |
| 2011 | 0    | 0    | 0    | 0    | 0    | 0    | 0    | 0    | 0    | 0    |
| 2012 | 0    | 0    | 0    | 0    | 0    | 0    | 0    | 0    | 0    | 0    |
| 2013 | 0    | 0    | 0    | 0    | 0    | 0    | 0    | 0    | 0    | 0    |
| 2014 | 0    | 0    | 0    | 0    | 0    | 0    | 0    | 0    | 0    | 0    |
| 2015 | 0    | 0    | 0    | 0    | 0    | 0    | 0    | 0    | 0    | 0    |
| 2016 | 0    | 0    | 0    | 0    | 0    | 0    | 0    | 0    | 0    | 0    |
| 2017 | 0    | 0    | 0    | 0    | 0    | 0    | 0    | 0    | 0    | 0    |
| 2018 | 0    | 0    | 0    | 0    | 0    | 0    | 0    | 0    | 0    | 0    |
| 2019 | 0    | 0    | 0    | 0    | 0    | 0    | 0    | 0    | 0    | 0    |
| 2020 | 0    | 0    | 0    | 0    | 0    | 10   | 0    | 0    | 0    | 0    |
| 2021 | 0    | 0    | 0    | 0    | 0    | 24   | 0    | 0    | 0    | 0    |
| 2022 | 0    | 0    | 0    | 0    | 0    | 97   | 0    | 0    | 0    | 0    |
| 2023 | 0    | 0    | 0    | 0    | 0    | 227  | 0    | 0    | 0    | 0    |
| 2024 | 0    | 0    | 0    | 0    | 0    | 373  | 0    | 0    | 0    | 0    |
| 2025 | 4    | 71   | 17   | 17   | 0    | 556  | 12   | 63   | 64   | 1    |
| 2026 | 17   | 293  | 53   | 165  | 0    | 737  | 73   | 291  | 313  | 2    |
| 2027 | 49   | 495  | 117  | 311  | 0    | 963  | 174  | 503  | 614  | 5    |
| 2028 | 95   | 781  | 218  | 474  | 0    | 1244 | 266  | 822  | 959  | 27   |
| 2029 | 195  | 1030 | 363  | 644  | 0    | 1482 | 354  | 1106 | 1252 | 43   |
| 2030 | 292  | 1287 | 541  | 846  | 10   | 1775 | 515  | 1338 | 1495 | 75   |
| 2031 | 426  | 1613 | 732  | 1050 | 199  | 2029 | 677  | 1611 | 1831 | 116  |
| 2032 | 545  | 1883 | 972  | 1324 | 412  | 2326 | 814  | 1815 | 2133 | 197  |
| 2033 | 710  | 2166 | 1185 | 1568 | 590  | 2602 | 1032 | 2041 | 2393 | 312  |
| 2034 | 910  | 2468 | 1497 | 1924 | 818  | 2952 | 1279 | 2324 | 2676 | 426  |
| 2035 | 1074 | 2766 | 1769 | 2199 | 1020 | 3252 | 1480 | 2583 | 2969 | 542  |
| 2036 | 1301 | 3052 | 2029 | 2494 | 1233 | 3543 | 1732 | 2812 | 3251 | 679  |
| 2037 | 1524 | 3310 | 2304 | 2768 | 1462 | 3806 | 2086 | 3077 | 3550 | 847  |
| 2038 | 1802 | 3525 | 2637 | 3112 | 1756 | 4076 | 2357 | 3342 | 3799 | 999  |
| 2039 | 2056 | 3737 | 2940 | 3423 | 2037 | 4320 | 2662 | 3617 | 4029 | 1181 |
| 2040 | 2343 | 3983 | 3224 | 3715 | 2360 | 4584 | 2975 | 3929 | 4295 | 1364 |
| 2041 | 2630 | 4204 | 3497 | 4013 | 2709 | 4915 | 3317 | 4229 | 4573 | 1601 |
| 2042 | 2906 | 4441 | 3797 | 4336 | 2968 | 5294 | 3629 | 4568 | 4889 | 1842 |
| 2043 | 3166 | 4682 | 4105 | 4621 | 3234 | 5514 | 3928 | 4884 | 5131 | 2105 |
| 2044 | 3361 | 4866 | 4340 | 4890 | 3498 | 5667 | 4214 | 5171 | 5404 | 2359 |
| 2045 | 3592 | 5012 | 4605 | 5174 | 3805 | 5927 | 4511 | 5387 | 5592 | 2695 |
| 2046 | 3832 | 5217 | 4783 | 5367 | 4080 | 6087 | 4754 | 5499 | 5679 | 2999 |
| 2047 | 4021 | 5292 | 5119 | 5731 | 4348 | 6199 | 5202 | 5842 | 5938 | 3520 |
| 2048 | 4225 | 5373 | 5373 | 6109 | 4580 | 6264 | 5569 | 6078 | 6171 | 3909 |
| 2049 | 4677 | 5652 | 5503 | 6397 | 4996 | 6292 | 5828 | 6238 | 6335 | 4270 |
| 2050 | 5031 | 5927 | 5589 | 6593 | 5323 | 6316 | 5972 | 6342 | 6411 | 4575 |
| 2051 | 5262 | 6107 | 5653 | 6713 | 5647 | 6346 | 6079 | 6391 | 6445 | 4814 |
| 2052 | 5428 | 6203 | 5681 | 6780 | 5918 | 6362 | 6170 | 6415 | 6453 | 5002 |
| 2053 | 5562 | 6257 | 5712 | 6833 | 6099 | 6374 | 6246 | 6422 | 6453 | 5243 |
| 2054 | 5654 | 6282 | 5742 | 6869 | 6246 | 6388 | 6304 | 6433 | 6453 | 5394 |
| 2055 | 5728 | 6298 | 5754 | 6881 | 6331 | 6403 | 6363 | 6436 | 6453 | 5550 |
| 2056 | 5782 | 6311 | 5778 | 6905 | 6382 | 6416 | 6371 | 6436 | 6453 | 5665 |
| 2057 | 5837 | 6339 | 5792 | 6921 | 6405 | 6431 | 6395 | 6436 | 6453 | 5810 |
| 2058 | 5925 | 6356 | 5797 | 6925 | 6426 | 6440 | 6409 | 6436 | 6453 | 5893 |
| 2059 | 6007 | 6375 | 5802 | 6932 | 6431 | 6447 | 6416 | 6436 | 6453 | 5980 |

EmplacedTAD

|      | 71   | 72   | 73   | 74   | 75   | 76   | 77   | 78   | 79   | 80   |
|------|------|------|------|------|------|------|------|------|------|------|
| 2060 | 6039 | 6390 | 5803 | 6934 | 6432 | 6448 | 6430 | 6436 | 6453 | 6070 |
| 2061 | 6087 | 6407 | 5807 | 6937 | 6434 | 6448 | 6435 | 6436 | 6453 | 6152 |
| 2062 | 6141 | 6427 | 5810 | 6940 | 6435 | 6448 | 6440 | 6436 | 6453 | 6214 |
| 2063 | 6197 | 6433 | 5810 | 6940 | 6436 | 6448 | 6442 | 6436 | 6453 | 6273 |
| 2064 | 6220 | 6437 | 5810 | 6940 | 6436 | 6448 | 6446 | 6436 | 6453 | 6303 |
| 2065 | 6251 | 6437 | 5810 | 6940 | 6436 | 6448 | 6447 | 6436 | 6453 | 6343 |
| 2066 | 6269 | 6437 | 5810 | 6940 | 6436 | 6448 | 6449 | 6436 | 6453 | 6366 |
| 2067 | 6285 | 6437 | 5810 | 6940 | 6436 | 6448 | 6449 | 6436 | 6453 | 6379 |
| 2068 | 6299 | 6437 | 5810 | 6940 | 6436 | 6448 | 6449 | 6436 | 6453 | 6412 |
| 2069 | 6315 | 6437 | 5810 | 6940 | 6436 | 6448 | 6449 | 6436 | 6453 | 6422 |
| 2070 | 6340 | 6437 | 5810 | 6940 | 6436 | 6448 | 6449 | 6436 | 6453 | 6432 |
| 2071 | 6358 | 6437 | 5810 | 6940 | 6436 | 6448 | 6449 | 6436 | 6453 | 6438 |
| 2072 | 6375 | 6437 | 5810 | 6940 | 6436 | 6448 | 6449 | 6436 | 6453 | 6444 |
| 2073 | 6392 | 6437 | 5810 | 6940 | 6436 | 6448 | 6449 | 6436 | 6453 | 6447 |
| 2074 | 6408 | 6437 | 5810 | 6940 | 6436 | 6448 | 6449 | 6436 | 6453 | 6449 |
| 2075 | 6426 | 6437 | 5810 | 6940 | 6436 | 6448 | 6449 | 6436 | 6453 | 6453 |
| 2076 | 6433 | 6437 | 5810 | 6940 | 6436 | 6448 | 6449 | 6436 | 6453 | 6453 |
| 2077 | 6437 | 6437 | 5810 | 6940 | 6436 | 6448 | 6449 | 6436 | 6453 | 6453 |
| 2078 | 6437 | 6437 | 5810 | 6940 | 6436 | 6448 | 6449 | 6436 | 6453 | 6453 |
| 2079 | 6437 | 6437 | 5810 | 6940 | 6436 | 6448 | 6449 | 6436 | 6453 | 6453 |
| 2080 | 6437 | 6437 | 5810 | 6940 | 6436 | 6448 | 6449 | 6436 | 6453 | 6453 |
| 2081 | 6437 | 6437 | 5810 | 6940 | 6436 | 6448 | 6449 | 6436 | 6453 | 6453 |
| 2082 | 6437 | 6437 | 5810 | 6940 | 6436 | 6448 | 6449 | 6436 | 6453 | 6453 |
| 2083 | 6437 | 6437 | 5810 | 6940 | 6436 | 6448 | 6449 | 6436 | 6453 | 6453 |
| 2084 | 6437 | 6437 | 5810 | 6940 | 6436 | 6448 | 6449 | 6436 | 6453 | 6453 |
| 2085 | 6437 | 6437 | 5810 | 6940 | 6436 | 6448 | 6449 | 6436 | 6453 | 6453 |
| 2086 | 6437 | 6437 | 5810 | 6940 | 6436 | 6448 | 6449 | 6436 | 6453 | 6453 |
| 2087 | 6437 | 6437 | 5810 | 6940 | 6436 | 6448 | 6449 | 6436 | 6453 | 6453 |
| 2088 | 6437 | 6437 | 5810 | 6940 | 6436 | 6448 | 6449 | 6436 | 6453 | 6453 |
| 2089 | 6437 | 6437 | 5810 | 6940 | 6436 | 6448 | 6449 | 6436 | 6453 | 6453 |
| 2090 | 6437 | 6437 | 5810 | 6940 | 6436 | 6448 | 6449 | 6436 | 6453 | 6453 |



EmplacedTAD

|      | 81   | 82   | 83   | 84   | 85   | 86   | 87   | 88   | 89   | 90   |
|------|------|------|------|------|------|------|------|------|------|------|
| 2002 | 0    | 0    | 0    | 0    | 0    | 0    | 0    | 0    | 0    | 0    |
| 2003 | 0    | 0    | 0    | 0    | 0    | 0    | 0    | 0    | 0    | 0    |
| 2004 | 0    | 0    | 0    | 0    | 0    | 0    | 0    | 0    | 0    | 0    |
| 2005 | 0    | 0    | 0    | 0    | 0    | 0    | 0    | 0    | 0    | 0    |
| 2006 | 0    | 0    | 0    | 0    | 0    | 0    | 0    | 0    | 0    | 0    |
| 2007 | 0    | 0    | 0    | 0    | 0    | 0    | 0    | 0    | 0    | 0    |
| 2008 | 0    | 0    | 0    | 0    | 0    | 0    | 0    | 0    | 0    | 0    |
| 2009 | 0    | 0    | 0    | 0    | 0    | 0    | 0    | 0    | 0    | 0    |
| 2010 | 0    | 0    | 0    | 0    | 0    | 0    | 0    | 0    | 0    | 0    |
| 2011 | 0    | 0    | 0    | 0    | 0    | 0    | 0    | 0    | 0    | 0    |
| 2012 | 0    | 0    | 0    | 0    | 0    | 0    | 0    | 0    | 0    | 0    |
| 2013 | 0    | 0    | 0    | 0    | 0    | 0    | 0    | 0    | 0    | 0    |
| 2014 | 0    | 0    | 0    | 0    | 0    | 0    | 0    | 0    | 0    | 0    |
| 2015 | 0    | 0    | 0    | 0    | 0    | 0    | 0    | 0    | 0    | 0    |
| 2016 | 0    | 0    | 0    | 0    | 0    | 0    | 0    | 0    | 0    | 0    |
| 2017 | 0    | 0    | 0    | 0    | 0    | 0    | 0    | 0    | 0    | 0    |
| 2018 | 0    | 0    | 0    | 0    | 0    | 0    | 0    | 0    | 0    | 0    |
| 2019 | 0    | 0    | 0    | 0    | 0    | 0    | 0    | 0    | 0    | 0    |
| 2020 | 0    | 0    | 0    | 0    | 254  | 0    | 0    | 0    | 0    | 0    |
| 2021 | 0    | 0    | 0    | 0    | 491  | 0    | 0    | 0    | 0    | 0    |
| 2022 | 0    | 0    | 0    | 0    | 756  | 0    | 0    | 0    | 0    | 0    |
| 2023 | 0    | 0    | 0    | 0    | 1011 | 0    | 0    | 0    | 0    | 0    |
| 2024 | 0    | 0    | 0    | 0    | 1264 | 0    | 0    | 0    | 0    | 0    |
| 2025 | 17   | 256  | 256  | 0    | 1524 | 256  | 256  | 256  | 256  | 256  |
| 2026 | 138  | 477  | 513  | 0    | 1806 | 502  | 502  | 502  | 502  | 502  |
| 2027 | 259  | 722  | 818  | 0    | 2063 | 788  | 788  | 788  | 788  | 788  |
| 2028 | 392  | 944  | 1092 | 0    | 2316 | 1040 | 1040 | 1040 | 1040 | 1040 |
| 2029 | 551  | 1175 | 1388 | 0    | 2572 | 1311 | 1311 | 1311 | 1311 | 1311 |
| 2030 | 744  | 1422 | 1692 | 256  | 2876 | 1589 | 1589 | 1589 | 1589 | 1589 |
| 2031 | 944  | 1670 | 1978 | 518  | 3159 | 1860 | 1860 | 1860 | 1860 | 1860 |
| 2032 | 1212 | 1893 | 2254 | 792  | 3413 | 2106 | 2106 | 2106 | 2106 | 2106 |
| 2033 | 1436 | 2128 | 2541 | 1103 | 3726 | 2366 | 2366 | 2366 | 2365 | 2366 |
| 2034 | 1762 | 2377 | 2830 | 1394 | 4061 | 2637 | 2637 | 2637 | 2632 | 2637 |
| 2035 | 2037 | 2625 | 3098 | 1731 | 4345 | 2894 | 2894 | 2894 | 2881 | 2894 |
| 2036 | 2306 | 2915 | 3406 | 2038 | 4721 | 3198 | 3216 | 3198 | 3175 | 3198 |
| 2037 | 2579 | 3181 | 3689 | 2330 | 4993 | 3471 | 3496 | 3472 | 3422 | 3472 |
| 2038 | 2921 | 3480 | 4003 | 2592 | 5213 | 3781 | 3825 | 3783 | 3705 | 3783 |
| 2039 | 3214 | 3794 | 4333 | 2866 | 5500 | 4106 | 4101 | 4105 | 3971 | 4105 |
| 2040 | 3497 | 4107 | 4669 | 3128 | 5777 | 4424 | 4423 | 4431 | 4214 | 4431 |
| 2041 | 3793 | 4460 | 5045 | 3404 | 6015 | 4754 | 4732 | 4805 | 4520 | 4797 |
| 2042 | 4106 | 4717 | 5307 | 3667 | 6119 | 5066 | 5074 | 5073 | 4775 | 5059 |
| 2043 | 4411 | 5056 | 5660 | 3949 | 6154 | 5383 | 5411 | 5436 | 5119 | 5410 |
| 2044 | 4660 | 5385 | 6012 | 4226 | 6255 | 5726 | 5729 | 5796 | 5427 | 5750 |
| 2045 | 4936 | 5416 | 6065 | 4595 | 6312 | 5782 | 5776 | 5828 | 5536 | 5794 |
| 2046 | 5121 | 5532 | 6295 | 4889 | 6363 | 5968 | 5964 | 5997 | 5727 | 5976 |
| 2047 | 5477 | 5615 | 6469 | 5201 | 6410 | 6102 | 6103 | 6117 | 5891 | 6107 |
| 2048 | 5820 | 5689 | 6637 | 5252 | 6423 | 6221 | 6220 | 6234 | 6039 | 6230 |
| 2049 | 6039 | 5734 | 6747 | 5439 | 6433 | 6303 | 6302 | 6308 | 6135 | 6308 |
| 2050 | 6188 | 5761 | 6820 | 5617 | 6441 | 6354 | 6352 | 6356 | 6218 | 6356 |
| 2051 | 6280 | 5786 | 6883 | 5784 | 6441 | 6396 | 6395 | 6400 | 6291 | 6400 |
| 2052 | 6310 | 5798 | 6921 | 5912 | 6441 | 6426 | 6422 | 6426 | 6342 | 6426 |
| 2053 | 6345 | 5801 | 6930 | 6041 | 6441 | 6437 | 6430 | 6432 | 6368 | 6432 |
| 2054 | 6376 | 5802 | 6933 | 6155 | 6441 | 6440 | 6432 | 6434 | 6386 | 6434 |
| 2055 | 6392 | 5805 | 6940 | 6246 | 6441 | 6443 | 6437 | 6439 | 6401 | 6439 |
| 2056 | 6417 | 5805 | 6940 | 6322 | 6441 | 6443 | 6437 | 6439 | 6410 | 6439 |
| 2057 | 6432 | 5805 | 6940 | 6374 | 6441 | 6443 | 6437 | 6439 | 6424 | 6439 |
| 2058 | 6437 | 5805 | 6940 | 6409 | 6441 | 6443 | 6437 | 6439 | 6431 | 6439 |
| 2059 | 6444 | 5805 | 6940 | 6432 | 6441 | 6443 | 6437 | 6439 | 6438 | 6439 |

EmplacedTAD

|      | 81   | 82   | 83   | 84   | 85   | 86   | 87   | 88   | 89   | 90   |
|------|------|------|------|------|------|------|------|------|------|------|
| 2060 | 6447 | 5805 | 6940 | 6437 | 6441 | 6443 | 6437 | 6439 | 6439 | 6439 |
| 2061 | 6450 | 5805 | 6940 | 6440 | 6441 | 6443 | 6437 | 6439 | 6439 | 6439 |
| 2062 | 6453 | 5805 | 6940 | 6440 | 6441 | 6443 | 6437 | 6439 | 6439 | 6439 |
| 2063 | 6453 | 5805 | 6940 | 6440 | 6441 | 6443 | 6437 | 6439 | 6439 | 6439 |
| 2064 | 6453 | 5805 | 6940 | 6440 | 6441 | 6443 | 6437 | 6439 | 6439 | 6439 |
| 2065 | 6453 | 5805 | 6940 | 6440 | 6441 | 6443 | 6437 | 6439 | 6439 | 6439 |
| 2066 | 6453 | 5805 | 6940 | 6440 | 6441 | 6443 | 6437 | 6439 | 6439 | 6439 |
| 2067 | 6453 | 5805 | 6940 | 6440 | 6441 | 6443 | 6437 | 6439 | 6439 | 6439 |
| 2068 | 6453 | 5805 | 6940 | 6440 | 6441 | 6443 | 6437 | 6439 | 6439 | 6439 |
| 2069 | 6453 | 5805 | 6940 | 6440 | 6441 | 6443 | 6437 | 6439 | 6439 | 6439 |
| 2070 | 6453 | 5805 | 6940 | 6440 | 6441 | 6443 | 6437 | 6439 | 6439 | 6439 |
| 2071 | 6453 | 5805 | 6940 | 6440 | 6441 | 6443 | 6437 | 6439 | 6439 | 6439 |
| 2072 | 6453 | 5805 | 6940 | 6440 | 6441 | 6443 | 6437 | 6439 | 6439 | 6439 |
| 2073 | 6453 | 5805 | 6940 | 6440 | 6441 | 6443 | 6437 | 6439 | 6439 | 6439 |
| 2074 | 6453 | 5805 | 6940 | 6440 | 6441 | 6443 | 6437 | 6439 | 6439 | 6439 |
| 2075 | 6453 | 5805 | 6940 | 6440 | 6441 | 6443 | 6437 | 6439 | 6439 | 6439 |
| 2076 | 6453 | 5805 | 6940 | 6440 | 6441 | 6443 | 6437 | 6439 | 6439 | 6439 |
| 2077 | 6453 | 5805 | 6940 | 6440 | 6441 | 6443 | 6437 | 6439 | 6439 | 6439 |
| 2078 | 6453 | 5805 | 6940 | 6440 | 6441 | 6443 | 6437 | 6439 | 6439 | 6439 |
| 2079 | 6453 | 5805 | 6940 | 6440 | 6441 | 6443 | 6437 | 6439 | 6439 | 6439 |
| 2080 | 6453 | 5805 | 6940 | 6440 | 6441 | 6443 | 6437 | 6439 | 6439 | 6439 |
| 2081 | 6453 | 5805 | 6940 | 6440 | 6441 | 6443 | 6437 | 6439 | 6439 | 6439 |
| 2082 | 6453 | 5805 | 6940 | 6440 | 6441 | 6443 | 6437 | 6439 | 6439 | 6439 |
| 2083 | 6453 | 5805 | 6940 | 6440 | 6441 | 6443 | 6437 | 6439 | 6439 | 6439 |
| 2084 | 6453 | 5805 | 6940 | 6440 | 6441 | 6443 | 6437 | 6439 | 6439 | 6439 |
| 2085 | 6453 | 5805 | 6940 | 6440 | 6441 | 6443 | 6437 | 6439 | 6439 | 6439 |
| 2086 | 6453 | 5805 | 6940 | 6440 | 6441 | 6443 | 6437 | 6439 | 6439 | 6439 |
| 2087 | 6453 | 5805 | 6940 | 6440 | 6441 | 6443 | 6437 | 6439 | 6439 | 6439 |
| 2088 | 6453 | 5805 | 6940 | 6440 | 6441 | 6443 | 6437 | 6439 | 6439 | 6439 |
| 2089 | 6453 | 5805 | 6940 | 6440 | 6441 | 6443 | 6437 | 6439 | 6439 | 6439 |
| 2090 | 6453 | 5805 | 6940 | 6440 | 6441 | 6443 | 6437 | 6439 | 6439 | 6439 |

EmplacedTAD

|      | 91   | 92   | 93   | 94   | 95   | 96   | 97   | 98   | 99   | 100  |
|------|------|------|------|------|------|------|------|------|------|------|
| 2002 | 0    | 0    | 0    | 0    | 0    | 0    | 0    | 0    | 0    | 0    |
| 2003 | 0    | 0    | 0    | 0    | 0    | 0    | 0    | 0    | 0    | 0    |
| 2004 | 0    | 0    | 0    | 0    | 0    | 0    | 0    | 0    | 0    | 0    |
| 2005 | 0    | 0    | 0    | 0    | 0    | 0    | 0    | 0    | 0    | 0    |
| 2006 | 0    | 0    | 0    | 0    | 0    | 0    | 0    | 0    | 0    | 0    |
| 2007 | 0    | 0    | 0    | 0    | 0    | 0    | 0    | 0    | 0    | 0    |
| 2008 | 0    | 0    | 0    | 0    | 0    | 0    | 0    | 0    | 0    | 0    |
| 2009 | 0    | 0    | 0    | 0    | 0    | 0    | 0    | 0    | 0    | 0    |
| 2010 | 0    | 0    | 0    | 0    | 0    | 0    | 0    | 0    | 0    | 0    |
| 2011 | 0    | 0    | 0    | 0    | 0    | 0    | 0    | 0    | 0    | 0    |
| 2012 | 0    | 0    | 0    | 0    | 0    | 0    | 0    | 0    | 0    | 0    |
| 2013 | 0    | 0    | 0    | 0    | 0    | 0    | 0    | 0    | 0    | 0    |
| 2014 | 0    | 0    | 0    | 0    | 0    | 0    | 0    | 0    | 0    | 0    |
| 2015 | 0    | 0    | 0    | 0    | 0    | 0    | 0    | 0    | 0    | 0    |
| 2016 | 0    | 0    | 0    | 0    | 0    | 0    | 0    | 0    | 0    | 0    |
| 2017 | 0    | 0    | 0    | 0    | 0    | 0    | 0    | 0    | 0    | 0    |
| 2018 | 0    | 0    | 0    | 0    | 0    | 0    | 0    | 0    | 0    | 0    |
| 2019 | 0    | 0    | 0    | 0    | 0    | 0    | 0    | 0    | 0    | 0    |
| 2020 | 0    | 0    | 0    | 90   | 0    | 0    | 0    | 0    | 0    | 0    |
| 2021 | 0    | 0    | 0    | 201  | 0    | 0    | 0    | 0    | 0    | 0    |
| 2022 | 0    | 0    | 0    | 408  | 0    | 0    | 0    | 0    | 0    | 0    |
| 2023 | 0    | 0    | 0    | 657  | 0    | 0    | 0    | 0    | 0    | 0    |
| 2024 | 0    | 0    | 0    | 922  | 0    | 0    | 0    | 0    | 0    | 0    |
| 2025 | 71   | 71   | 0    | 1124 | 64   | 174  | 244  | 4    | 71   | 17   |
| 2026 | 191  | 282  | 0    | 1417 | 220  | 411  | 537  | 17   | 251  | 44   |
| 2027 | 330  | 488  | 0    | 1677 | 369  | 696  | 830  | 39   | 426  | 99   |
| 2028 | 549  | 770  | 0    | 1988 | 554  | 990  | 1138 | 85   | 685  | 184  |
| 2029 | 753  | 1032 | 0    | 2270 | 752  | 1241 | 1431 | 175  | 918  | 309  |
| 2030 | 991  | 1318 | 66   | 2576 | 982  | 1483 | 1707 | 272  | 1178 | 470  |
| 2031 | 1302 | 1665 | 283  | 2836 | 1297 | 1722 | 1982 | 402  | 1506 | 643  |
| 2032 | 1547 | 1939 | 496  | 3126 | 1565 | 1973 | 2254 | 515  | 1768 | 891  |
| 2033 | 1823 | 2244 | 720  | 3344 | 1907 | 2237 | 2515 | 661  | 2057 | 1101 |
| 2034 | 2127 | 2572 | 1008 | 3622 | 2256 | 2523 | 2819 | 858  | 2375 | 1418 |
| 2035 | 2410 | 2870 | 1304 | 3855 | 2601 | 2777 | 3104 | 1023 | 2668 | 1689 |
| 2036 | 2698 | 3176 | 1629 | 4034 | 2883 | 3076 | 3349 | 1240 | 2966 | 1967 |
| 2037 | 2953 | 3444 | 1943 | 4252 | 3111 | 3338 | 3564 | 1464 | 3228 | 2227 |
| 2038 | 3164 | 3671 | 2273 | 4443 | 3341 | 3603 | 3791 | 1730 | 3447 | 2573 |
| 2039 | 3374 | 3895 | 2552 | 4586 | 3562 | 3834 | 3999 | 1984 | 3663 | 2877 |
| 2040 | 3594 | 4125 | 2800 | 4718 | 3803 | 4099 | 4236 | 2265 | 3888 | 3154 |
| 2041 | 3809 | 4355 | 3102 | 4877 | 4045 | 4363 | 4504 | 2552 | 4111 | 3430 |
| 2042 | 4059 | 4626 | 3423 | 5033 | 4286 | 4630 | 4755 | 2831 | 4371 | 3729 |
| 2043 | 4298 | 4877 | 3688 | 5170 | 4492 | 4849 | 4968 | 3101 | 4617 | 4032 |
| 2044 | 4474 | 5062 | 3968 | 5253 | 4656 | 5038 | 5141 | 3306 | 4797 | 4288 |
| 2045 | 4615 | 5211 | 4191 | 5373 | 4823 | 5292 | 5296 | 3548 | 4942 | 4574 |
| 2046 | 4801 | 5402 | 4433 | 5450 | 4984 | 5483 | 5433 | 3767 | 5130 | 4751 |
| 2047 | 4901 | 5502 | 4640 | 5501 | 5059 | 5572 | 5570 | 3976 | 5230 | 4976 |
| 2048 | 4964 | 5565 | 4833 | 5694 | 5157 | 5809 | 5603 | 4163 | 5293 | 5206 |
| 2049 | 5108 | 5833 | 4876 | 5820 | 5382 | 6018 | 5807 | 4545 | 5513 | 5374 |
| 2050 | 5250 | 6093 | 5120 | 5901 | 5616 | 6165 | 5986 | 4830 | 5725 | 5515 |
| 2051 | 5374 | 6327 | 5347 | 5957 | 5806 | 6266 | 6154 | 5102 | 5912 | 5611 |
| 2052 | 5472 | 6501 | 5588 | 6024 | 5950 | 6332 | 6270 | 5305 | 6049 | 5653 |
| 2053 | 5539 | 6614 | 5796 | 6075 | 6033 | 6369 | 6345 | 5466 | 6142 | 5695 |
| 2054 | 5583 | 6681 | 5983 | 6123 | 6092 | 6403 | 6396 | 5602 | 6198 | 5729 |
| 2055 | 5623 | 6740 | 6148 | 6176 | 6133 | 6425 | 6418 | 5706 | 6247 | 5746 |
| 2056 | 5639 | 6765 | 6238 | 6218 | 6185 | 6431 | 6429 | 5759 | 6268 | 5775 |
| 2057 | 5675 | 6806 | 6309 | 6269 | 6227 | 6435 | 6435 | 5812 | 6307 | 5791 |
| 2058 | 5694 | 6829 | 6339 | 6312 | 6247 | 6435 | 6439 | 5883 | 6328 | 5793 |
| 2059 | 5714 | 6849 | 6365 | 6346 | 6278 | 6435 | 6439 | 5945 | 6348 | 5797 |

EmplacedTAD

|      | 91   | 92   | 93   | 94   | 95   | 96   | 97   | 98   | 99   | 100  |
|------|------|------|------|------|------|------|------|------|------|------|
| 2060 | 5733 | 6868 | 6381 | 6381 | 6305 | 6435 | 6439 | 5979 | 6367 | 5799 |
| 2061 | 5754 | 6889 | 6394 | 6413 | 6326 | 6435 | 6439 | 6029 | 6388 | 5801 |
| 2062 | 5780 | 6915 | 6415 | 6441 | 6346 | 6435 | 6439 | 6077 | 6414 | 5803 |
| 2063 | 5792 | 6927 | 6425 | 6445 | 6368 | 6435 | 6439 | 6129 | 6426 | 5803 |
| 2064 | 5805 | 6940 | 6434 | 6445 | 6392 | 6435 | 6439 | 6157 | 6439 | 5803 |
| 2065 | 5805 | 6940 | 6435 | 6445 | 6408 | 6435 | 6439 | 6200 | 6439 | 5803 |
| 2066 | 5805 | 6940 | 6435 | 6445 | 6424 | 6435 | 6439 | 6225 | 6439 | 5803 |
| 2067 | 5805 | 6940 | 6435 | 6445 | 6433 | 6435 | 6439 | 6250 | 6439 | 5803 |
| 2068 | 5805 | 6940 | 6435 | 6445 | 6435 | 6435 | 6439 | 6269 | 6439 | 5803 |
| 2069 | 5805 | 6940 | 6435 | 6445 | 6435 | 6435 | 6439 | 6283 | 6439 | 5803 |
| 2070 | 5805 | 6940 | 6435 | 6445 | 6435 | 6435 | 6439 | 6312 | 6439 | 5803 |
| 2071 | 5805 | 6940 | 6435 | 6445 | 6435 | 6435 | 6439 | 6329 | 6439 | 5803 |
| 2072 | 5805 | 6940 | 6435 | 6445 | 6435 | 6435 | 6439 | 6350 | 6439 | 5803 |
| 2073 | 5805 | 6940 | 6435 | 6445 | 6435 | 6435 | 6439 | 6367 | 6439 | 5803 |
| 2074 | 5805 | 6940 | 6435 | 6445 | 6435 | 6435 | 6439 | 6388 | 6439 | 5803 |
| 2075 | 5805 | 6940 | 6435 | 6445 | 6435 | 6435 | 6439 | 6413 | 6439 | 5803 |
| 2076 | 5805 | 6940 | 6435 | 6445 | 6435 | 6435 | 6439 | 6425 | 6439 | 5803 |
| 2077 | 5805 | 6940 | 6435 | 6445 | 6435 | 6435 | 6439 | 6439 | 6439 | 5803 |
| 2078 | 5805 | 6940 | 6435 | 6445 | 6435 | 6435 | 6439 | 6439 | 6439 | 5803 |
| 2079 | 5805 | 6940 | 6435 | 6445 | 6435 | 6435 | 6439 | 6439 | 6439 | 5803 |
| 2080 | 5805 | 6940 | 6435 | 6445 | 6435 | 6435 | 6439 | 6439 | 6439 | 5803 |
| 2081 | 5805 | 6940 | 6435 | 6445 | 6435 | 6435 | 6439 | 6439 | 6439 | 5803 |
| 2082 | 5805 | 6940 | 6435 | 6445 | 6435 | 6435 | 6439 | 6439 | 6439 | 5803 |
| 2083 | 5805 | 6940 | 6435 | 6445 | 6435 | 6435 | 6439 | 6439 | 6439 | 5803 |
| 2084 | 5805 | 6940 | 6435 | 6445 | 6435 | 6435 | 6439 | 6439 | 6439 | 5803 |
| 2085 | 5805 | 6940 | 6435 | 6445 | 6435 | 6435 | 6439 | 6439 | 6439 | 5803 |
| 2086 | 5805 | 6940 | 6435 | 6445 | 6435 | 6435 | 6439 | 6439 | 6439 | 5803 |
| 2087 | 5805 | 6940 | 6435 | 6445 | 6435 | 6435 | 6439 | 6439 | 6439 | 5803 |
| 2088 | 5805 | 6940 | 6435 | 6445 | 6435 | 6435 | 6439 | 6439 | 6439 | 5803 |
| 2089 | 5805 | 6940 | 6435 | 6445 | 6435 | 6435 | 6439 | 6439 | 6439 | 5803 |
| 2090 | 5805 | 6940 | 6435 | 6445 | 6435 | 6435 | 6439 | 6439 | 6439 | 5803 |

EmplacedTAD

|      | 101  | 102  | 103  | 104  | 105  | 106  | 107  | 108  | 109  | 110  |
|------|------|------|------|------|------|------|------|------|------|------|
| 2002 | 0    | 0    | 0    | 0    | 0    | 0    | 0    | 0    | 0    | 0    |
| 2003 | 0    | 0    | 0    | 0    | 0    | 0    | 0    | 0    | 0    | 0    |
| 2004 | 0    | 0    | 0    | 0    | 0    | 0    | 0    | 0    | 0    | 0    |
| 2005 | 0    | 0    | 0    | 0    | 0    | 0    | 0    | 0    | 0    | 0    |
| 2006 | 0    | 0    | 0    | 0    | 0    | 0    | 0    | 0    | 0    | 0    |
| 2007 | 0    | 0    | 0    | 0    | 0    | 0    | 0    | 0    | 0    | 0    |
| 2008 | 0    | 0    | 0    | 0    | 0    | 0    | 0    | 0    | 0    | 0    |
| 2009 | 0    | 0    | 0    | 0    | 0    | 0    | 0    | 0    | 0    | 0    |
| 2010 | 0    | 0    | 0    | 0    | 0    | 0    | 0    | 0    | 0    | 0    |
| 2011 | 0    | 0    | 0    | 0    | 0    | 0    | 0    | 0    | 0    | 0    |
| 2012 | 0    | 0    | 0    | 0    | 0    | 0    | 0    | 0    | 0    | 0    |
| 2013 | 0    | 0    | 0    | 0    | 0    | 0    | 0    | 0    | 0    | 0    |
| 2014 | 0    | 0    | 0    | 0    | 0    | 0    | 0    | 0    | 0    | 0    |
| 2015 | 0    | 0    | 0    | 0    | 0    | 0    | 0    | 0    | 0    | 0    |
| 2016 | 0    | 0    | 0    | 0    | 0    | 0    | 0    | 0    | 0    | 0    |
| 2017 | 0    | 0    | 0    | 0    | 0    | 0    | 0    | 0    | 0    | 0    |
| 2018 | 0    | 0    | 0    | 0    | 0    | 0    | 0    | 0    | 0    | 0    |
| 2019 | 0    | 0    | 0    | 0    | 0    | 0    | 0    | 0    | 0    | 0    |
| 2020 | 0    | 0    | 10   | 0    | 0    | 0    | 0    | 0    | 0    | 0    |
| 2021 | 0    | 0    | 24   | 0    | 0    | 0    | 0    | 0    | 0    | 0    |
| 2022 | 0    | 0    | 96   | 0    | 0    | 0    | 0    | 0    | 0    | 0    |
| 2023 | 0    | 0    | 204  | 0    | 0    | 0    | 0    | 0    | 0    | 0    |
| 2024 | 0    | 0    | 340  | 0    | 0    | 0    | 0    | 0    | 0    | 0    |
| 2025 | 17   | 0    | 492  | 12   | 63   | 64   | 1    | 17   | 256  | 256  |
| 2026 | 150  | 0    | 679  | 64   | 253  | 270  | 2    | 112  | 506  | 506  |
| 2027 | 279  | 0    | 913  | 144  | 436  | 528  | 5    | 208  | 757  | 757  |
| 2028 | 430  | 0    | 1186 | 222  | 722  | 842  | 26   | 338  | 1011 | 1011 |
| 2029 | 606  | 0    | 1423 | 308  | 1006 | 1133 | 38   | 484  | 1261 | 1261 |
| 2030 | 807  | 10   | 1717 | 452  | 1255 | 1382 | 70   | 663  | 1513 | 1513 |
| 2031 | 1009 | 165  | 1944 | 590  | 1521 | 1724 | 108  | 848  | 1771 | 1771 |
| 2032 | 1281 | 344  | 2241 | 732  | 1742 | 2020 | 178  | 1110 | 2027 | 2027 |
| 2033 | 1520 | 494  | 2528 | 943  | 1958 | 2283 | 291  | 1335 | 2277 | 2292 |
| 2034 | 1859 | 708  | 2883 | 1177 | 2253 | 2578 | 402  | 1664 | 2540 | 2555 |
| 2035 | 2144 | 919  | 3177 | 1393 | 2501 | 2875 | 513  | 1944 | 2811 | 2826 |
| 2036 | 2444 | 1130 | 3475 | 1662 | 2744 | 3165 | 652  | 2234 | 3094 | 3118 |
| 2037 | 2712 | 1355 | 3754 | 2020 | 3000 | 3462 | 812  | 2498 | 3362 | 3410 |
| 2038 | 3077 | 1644 | 4017 | 2303 | 3264 | 3723 | 958  | 2854 | 3681 | 3735 |
| 2039 | 3396 | 1934 | 4254 | 2603 | 3519 | 3966 | 1153 | 3165 | 3923 | 4002 |
| 2040 | 3685 | 2251 | 4509 | 2914 | 3835 | 4238 | 1343 | 3448 | 4227 | 4335 |
| 2041 | 3972 | 2595 | 4803 | 3263 | 4122 | 4523 | 1569 | 3730 | 4468 | 4589 |
| 2042 | 4293 | 2860 | 5131 | 3565 | 4503 | 4853 | 1798 | 4039 | 4783 | 4929 |
| 2043 | 4601 | 3136 | 5381 | 3875 | 4807 | 5102 | 2055 | 4345 | 4905 | 5063 |
| 2044 | 4862 | 3407 | 5527 | 4155 | 5109 | 5379 | 2306 | 4604 | 4934 | 5204 |
| 2045 | 5156 | 3717 | 5758 | 4486 | 5357 | 5572 | 2651 | 4896 | 5005 | 5395 |
| 2046 | 5352 | 3978 | 5949 | 4719 | 5466 | 5657 | 2955 | 5084 | 5087 | 5561 |
| 2047 | 5695 | 4276 | 6118 | 5110 | 5742 | 5855 | 3415 | 5379 | 5182 | 5730 |
| 2048 | 6046 | 4511 | 6211 | 5438 | 5949 | 6042 | 3761 | 5679 | 5267 | 5913 |
| 2049 | 6327 | 4729 | 6253 | 5702 | 6138 | 6211 | 4127 | 5913 | 5346 | 6057 |
| 2050 | 6543 | 5038 | 6286 | 5873 | 6272 | 6308 | 4446 | 6093 | 5430 | 6191 |
| 2051 | 6685 | 5295 | 6320 | 6016 | 6329 | 6363 | 4700 | 6213 | 5488 | 6344 |
| 2052 | 6751 | 5555 | 6335 | 6123 | 6378 | 6396 | 4915 | 6268 | 5542 | 6503 |
| 2053 | 6812 | 5792 | 6348 | 6224 | 6405 | 6416 | 5175 | 6319 | 5613 | 6631 |
| 2054 | 6855 | 6009 | 6366 | 6293 | 6427 | 6427 | 5339 | 6358 | 5682 | 6758 |
| 2055 | 6877 | 6156 | 6381 | 6353 | 6436 | 6433 | 5501 | 6378 | 5704 | 6842 |
| 2056 | 6910 | 6272 | 6397 | 6369 | 6440 | 6437 | 5632 | 6409 | 5742 | 6911 |
| 2057 | 6926 | 6338 | 6414 | 6393 | 6440 | 6437 | 5782 | 6425 | 5791 | 6911 |
| 2058 | 6928 | 6388 | 6427 | 6407 | 6440 | 6437 | 5869 | 6427 | 5792 | 6938 |
| 2059 | 6932 | 6407 | 6440 | 6413 | 6440 | 6437 | 5955 | 6431 | 5805 | 6938 |

EmplacedTAD

|      | 101  | 102  | 103  | 104  | 105  | 106  | 107  | 108  | 109  | 110  |
|------|------|------|------|------|------|------|------|------|------|------|
| 2060 | 6934 | 6420 | 6441 | 6426 | 6440 | 6437 | 6052 | 6433 | 5805 | 6938 |
| 2061 | 6936 | 6428 | 6441 | 6432 | 6440 | 6437 | 6136 | 6435 | 5805 | 6938 |
| 2062 | 6938 | 6433 | 6441 | 6436 | 6440 | 6437 | 6207 | 6437 | 5805 | 6938 |
| 2063 | 6938 | 6435 | 6441 | 6439 | 6440 | 6437 | 6273 | 6437 | 5805 | 6938 |
| 2064 | 6938 | 6435 | 6441 | 6441 | 6440 | 6437 | 6303 | 6437 | 5805 | 6938 |
| 2065 | 6938 | 6436 | 6441 | 6442 | 6440 | 6437 | 6339 | 6437 | 5805 | 6938 |
| 2066 | 6938 | 6436 | 6441 | 6444 | 6440 | 6437 | 6357 | 6437 | 5805 | 6938 |
| 2067 | 6938 | 6436 | 6441 | 6444 | 6440 | 6437 | 6371 | 6437 | 5805 | 6938 |
| 2068 | 6938 | 6436 | 6441 | 6444 | 6440 | 6437 | 6401 | 6437 | 5805 | 6938 |
| 2069 | 6938 | 6436 | 6441 | 6444 | 6440 | 6437 | 6414 | 6437 | 5805 | 6938 |
| 2070 | 6938 | 6436 | 6441 | 6444 | 6440 | 6437 | 6425 | 6437 | 5805 | 6938 |
| 2071 | 6938 | 6436 | 6441 | 6444 | 6440 | 6437 | 6427 | 6437 | 5805 | 6938 |
| 2072 | 6938 | 6436 | 6441 | 6444 | 6440 | 6437 | 6432 | 6437 | 5805 | 6938 |
| 2073 | 6938 | 6436 | 6441 | 6444 | 6440 | 6437 | 6433 | 6437 | 5805 | 6938 |
| 2074 | 6938 | 6436 | 6441 | 6444 | 6440 | 6437 | 6434 | 6437 | 5805 | 6938 |
| 2075 | 6938 | 6436 | 6441 | 6444 | 6440 | 6437 | 6437 | 6437 | 5805 | 6938 |
| 2076 | 6938 | 6436 | 6441 | 6444 | 6440 | 6437 | 6437 | 6437 | 5805 | 6938 |
| 2077 | 6938 | 6436 | 6441 | 6444 | 6440 | 6437 | 6437 | 6437 | 5805 | 6938 |
| 2078 | 6938 | 6436 | 6441 | 6444 | 6440 | 6437 | 6437 | 6437 | 5805 | 6938 |
| 2079 | 6938 | 6436 | 6441 | 6444 | 6440 | 6437 | 6437 | 6437 | 5805 | 6938 |
| 2080 | 6938 | 6436 | 6441 | 6444 | 6440 | 6437 | 6437 | 6437 | 5805 | 6938 |
| 2081 | 6938 | 6436 | 6441 | 6444 | 6440 | 6437 | 6437 | 6437 | 5805 | 6938 |
| 2082 | 6938 | 6436 | 6441 | 6444 | 6440 | 6437 | 6437 | 6437 | 5805 | 6938 |
| 2083 | 6938 | 6436 | 6441 | 6444 | 6440 | 6437 | 6437 | 6437 | 5805 | 6938 |
| 2084 | 6938 | 6436 | 6441 | 6444 | 6440 | 6437 | 6437 | 6437 | 5805 | 6938 |
| 2085 | 6938 | 6436 | 6441 | 6444 | 6440 | 6437 | 6437 | 6437 | 5805 | 6938 |
| 2086 | 6938 | 6436 | 6441 | 6444 | 6440 | 6437 | 6437 | 6437 | 5805 | 6938 |
| 2087 | 6938 | 6436 | 6441 | 6444 | 6440 | 6437 | 6437 | 6437 | 5805 | 6938 |
| 2088 | 6938 | 6436 | 6441 | 6444 | 6440 | 6437 | 6437 | 6437 | 5805 | 6938 |
| 2089 | 6938 | 6436 | 6441 | 6444 | 6440 | 6437 | 6437 | 6437 | 5805 | 6938 |
| 2090 | 6938 | 6436 | 6441 | 6444 | 6440 | 6437 | 6437 | 6437 | 5805 | 6938 |

EmplacedTAD

|      | 111  | 112  | 113  | 114  | 115  | 116  | 117  | 118  | 119  | 120  |
|------|------|------|------|------|------|------|------|------|------|------|
| 2002 | 0    | 0    | 0    | 0    | 0    | 0    | 0    | 0    | 0    | 0    |
| 2003 | 0    | 0    | 0    | 0    | 0    | 0    | 0    | 0    | 0    | 0    |
| 2004 | 0    | 0    | 0    | 0    | 0    | 0    | 0    | 0    | 0    | 0    |
| 2005 | 0    | 0    | 0    | 0    | 0    | 0    | 0    | 0    | 0    | 0    |
| 2006 | 0    | 0    | 0    | 0    | 0    | 0    | 0    | 0    | 0    | 0    |
| 2007 | 0    | 0    | 0    | 0    | 0    | 0    | 0    | 0    | 0    | 0    |
| 2008 | 0    | 0    | 0    | 0    | 0    | 0    | 0    | 0    | 0    | 0    |
| 2009 | 0    | 0    | 0    | 0    | 0    | 0    | 0    | 0    | 0    | 0    |
| 2010 | 0    | 0    | 0    | 0    | 0    | 0    | 0    | 0    | 0    | 0    |
| 2011 | 0    | 0    | 0    | 0    | 0    | 0    | 0    | 0    | 0    | 0    |
| 2012 | 0    | 0    | 0    | 0    | 0    | 0    | 0    | 0    | 0    | 0    |
| 2013 | 0    | 0    | 0    | 0    | 0    | 0    | 0    | 0    | 0    | 0    |
| 2014 | 0    | 0    | 0    | 0    | 0    | 0    | 0    | 0    | 0    | 0    |
| 2015 | 0    | 0    | 0    | 0    | 0    | 0    | 0    | 0    | 0    | 0    |
| 2016 | 0    | 0    | 0    | 0    | 0    | 0    | 0    | 0    | 0    | 0    |
| 2017 | 0    | 0    | 0    | 0    | 0    | 0    | 0    | 0    | 0    | 0    |
| 2018 | 0    | 0    | 0    | 0    | 0    | 0    | 0    | 0    | 0    | 0    |
| 2019 | 0    | 0    | 0    | 0    | 0    | 0    | 0    | 0    | 0    | 0    |
| 2020 | 0    | 254  | 0    | 0    | 0    | 0    | 0    | 0    | 0    | 0    |
| 2021 | 0    | 506  | 0    | 0    | 0    | 0    | 0    | 0    | 0    | 0    |
| 2022 | 0    | 760  | 0    | 0    | 0    | 0    | 0    | 0    | 0    | 0    |
| 2023 | 0    | 1017 | 0    | 0    | 0    | 0    | 0    | 0    | 0    | 0    |
| 2024 | 0    | 1268 | 0    | 0    | 0    | 0    | 0    | 0    | 0    | 0    |
| 2025 | 0    | 1537 | 256  | 256  | 256  | 256  | 256  | 71   | 71   | 0    |
| 2026 | 0    | 1793 | 506  | 506  | 506  | 506  | 506  | 175  | 175  | 0    |
| 2027 | 0    | 2050 | 757  | 757  | 757  | 757  | 757  | 289  | 299  | 0    |
| 2028 | 0    | 2304 | 1011 | 1011 | 1011 | 1011 | 1011 | 478  | 488  | 0    |
| 2029 | 0    | 2588 | 1261 | 1261 | 1261 | 1261 | 1261 | 677  | 690  | 0    |
| 2030 | 256  | 2855 | 1513 | 1513 | 1513 | 1513 | 1513 | 921  | 942  | 66   |
| 2031 | 509  | 3113 | 1771 | 1771 | 1771 | 1771 | 1771 | 1224 | 1258 | 173  |
| 2032 | 759  | 3395 | 2027 | 2036 | 2027 | 2020 | 2027 | 1467 | 1522 | 297  |
| 2033 | 1016 | 3686 | 2277 | 2289 | 2286 | 2277 | 2286 | 1743 | 1820 | 450  |
| 2034 | 1271 | 3929 | 2536 | 2529 | 2549 | 2505 | 2549 | 1987 | 2076 | 642  |
| 2035 | 1523 | 4261 | 2803 | 2789 | 2820 | 2737 | 2820 | 2200 | 2311 | 894  |
| 2036 | 1790 | 4532 | 3086 | 3051 | 3106 | 2946 | 3105 | 2440 | 2590 | 1167 |
| 2037 | 2052 | 4751 | 3361 | 3350 | 3388 | 3178 | 3385 | 2638 | 2814 | 1437 |
| 2038 | 2314 | 5006 | 3690 | 3653 | 3715 | 3450 | 3709 | 2813 | 3000 | 1696 |
| 2039 | 2575 | 5269 | 3969 | 3922 | 3968 | 3657 | 3957 | 3008 | 3208 | 1912 |
| 2040 | 2840 | 5519 | 4281 | 4221 | 4293 | 3918 | 4263 | 3249 | 3470 | 2157 |
| 2041 | 3114 | 5704 | 4546 | 4482 | 4578 | 4129 | 4521 | 3458 | 3706 | 2405 |
| 2042 | 3404 | 5786 | 4862 | 4786 | 4944 | 4471 | 4873 | 3683 | 3975 | 2709 |
| 2043 | 3710 | 5891 | 4906 | 4927 | 4993 | 4581 | 4940 | 3921 | 4255 | 2981 |
| 2044 | 3931 | 5994 | 4970 | 4999 | 5079 | 4711 | 5049 | 4112 | 4468 | 3263 |
| 2045 | 4044 | 6087 | 5115 | 5162 | 5199 | 4908 | 5184 | 4228 | 4640 | 3510 |
| 2046 | 4142 | 6148 | 5277 | 5338 | 5323 | 5057 | 5316 | 4375 | 4816 | 3734 |
| 2047 | 4268 | 6280 | 5427 | 5477 | 5455 | 5233 | 5451 | 4494 | 4944 | 3915 |
| 2048 | 4408 | 6366 | 5565 | 5634 | 5603 | 5411 | 5601 | 4588 | 5054 | 4079 |
| 2049 | 4596 | 6380 | 5686 | 5742 | 5720 | 5552 | 5720 | 4702 | 5145 | 4309 |
| 2050 | 4780 | 6411 | 5797 | 5846 | 5834 | 5704 | 5834 | 4808 | 5374 | 4536 |
| 2051 | 4925 | 6429 | 5893 | 5944 | 5911 | 5811 | 5911 | 4963 | 5561 | 4741 |
| 2052 | 5105 | 6429 | 5969 | 6049 | 5997 | 5920 | 5997 | 5049 | 5752 | 4898 |
| 2053 | 5276 | 6439 | 6106 | 6172 | 6146 | 6091 | 6146 | 5115 | 5930 | 5067 |
| 2054 | 5414 | 6439 | 6243 | 6259 | 6252 | 6215 | 6252 | 5167 | 6150 | 5228 |
| 2055 | 5529 | 6439 | 6312 | 6330 | 6324 | 6304 | 6324 | 5309 | 6366 | 5359 |
| 2056 | 5605 | 6439 | 6375 | 6393 | 6387 | 6376 | 6387 | 5425 | 6522 | 5476 |
| 2057 | 5771 | 6439 | 6425 | 6423 | 6415 | 6409 | 6415 | 5502 | 6631 | 5667 |
| 2058 | 5931 | 6439 | 6430 | 6431 | 6423 | 6420 | 6423 | 5535 | 6695 | 5849 |
| 2059 | 6088 | 6439 | 6439 | 6434 | 6428 | 6428 | 6428 | 5598 | 6748 | 6026 |

EmplacedTAD

|      | 111  | 112  | 113  | 114  | 115  | 116  | 117  | 118  | 119  | 120  |
|------|------|------|------|------|------|------|------|------|------|------|
| 2060 | 6211 | 6439 | 6439 | 6442 | 6436 | 6436 | 6436 | 5647 | 6797 | 6160 |
| 2061 | 6307 | 6439 | 6439 | 6442 | 6436 | 6436 | 6436 | 5698 | 6833 | 6231 |
| 2062 | 6372 | 6439 | 6439 | 6442 | 6436 | 6436 | 6436 | 5733 | 6872 | 6295 |
| 2063 | 6421 | 6439 | 6439 | 6442 | 6436 | 6436 | 6436 | 5770 | 6911 | 6348 |
| 2064 | 6431 | 6439 | 6439 | 6442 | 6436 | 6436 | 6436 | 5799 | 6936 | 6396 |
| 2065 | 6436 | 6439 | 6439 | 6442 | 6436 | 6436 | 6436 | 5806 | 6943 | 6427 |
| 2066 | 6436 | 6439 | 6439 | 6442 | 6436 | 6436 | 6436 | 5806 | 6943 | 6442 |
| 2067 | 6436 | 6439 | 6439 | 6442 | 6436 | 6436 | 6436 | 5806 | 6943 | 6442 |
| 2068 | 6436 | 6439 | 6439 | 6442 | 6436 | 6436 | 6436 | 5806 | 6943 | 6442 |
| 2069 | 6436 | 6439 | 6439 | 6442 | 6436 | 6436 | 6436 | 5806 | 6943 | 6442 |
| 2070 | 6436 | 6439 | 6439 | 6442 | 6436 | 6436 | 6436 | 5806 | 6943 | 6442 |
| 2071 | 6436 | 6439 | 6439 | 6442 | 6436 | 6436 | 6436 | 5806 | 6943 | 6442 |
| 2072 | 6436 | 6439 | 6439 | 6442 | 6436 | 6436 | 6436 | 5806 | 6943 | 6442 |
| 2073 | 6436 | 6439 | 6439 | 6442 | 6436 | 6436 | 6436 | 5806 | 6943 | 6442 |
| 2074 | 6436 | 6439 | 6439 | 6442 | 6436 | 6436 | 6436 | 5806 | 6943 | 6442 |
| 2075 | 6436 | 6439 | 6439 | 6442 | 6436 | 6436 | 6436 | 5806 | 6943 | 6442 |
| 2076 | 6436 | 6439 | 6439 | 6442 | 6436 | 6436 | 6436 | 5806 | 6943 | 6442 |
| 2077 | 6436 | 6439 | 6439 | 6442 | 6436 | 6436 | 6436 | 5806 | 6943 | 6442 |
| 2078 | 6436 | 6439 | 6439 | 6442 | 6436 | 6436 | 6436 | 5806 | 6943 | 6442 |
| 2079 | 6436 | 6439 | 6439 | 6442 | 6436 | 6436 | 6436 | 5806 | 6943 | 6442 |
| 2080 | 6436 | 6439 | 6439 | 6442 | 6436 | 6436 | 6436 | 5806 | 6943 | 6442 |
| 2081 | 6436 | 6439 | 6439 | 6442 | 6436 | 6436 | 6436 | 5806 | 6943 | 6442 |
| 2082 | 6436 | 6439 | 6439 | 6442 | 6436 | 6436 | 6436 | 5806 | 6943 | 6442 |
| 2083 | 6436 | 6439 | 6439 | 6442 | 6436 | 6436 | 6436 | 5806 | 6943 | 6442 |
| 2084 | 6436 | 6439 | 6439 | 6442 | 6436 | 6436 | 6436 | 5806 | 6943 | 6442 |
| 2085 | 6436 | 6439 | 6439 | 6442 | 6436 | 6436 | 6436 | 5806 | 6943 | 6442 |
| 2086 | 6436 | 6439 | 6439 | 6442 | 6436 | 6436 | 6436 | 5806 | 6943 | 6442 |
| 2087 | 6436 | 6439 | 6439 | 6442 | 6436 | 6436 | 6436 | 5806 | 6943 | 6442 |
| 2088 | 6436 | 6439 | 6439 | 6442 | 6436 | 6436 | 6436 | 5806 | 6943 | 6442 |
| 2089 | 6436 | 6439 | 6439 | 6442 | 6436 | 6436 | 6436 | 5806 | 6943 | 6442 |
| 2090 | 6436 | 6439 | 6439 | 6442 | 6436 | 6436 | 6436 | 5806 | 6943 | 6442 |



EmplacedTAD

|      | 121  | 122  | 123  | 124  | 125  | 126  | 127  | 128  | 129  | 130  |
|------|------|------|------|------|------|------|------|------|------|------|
| 2002 | 0    | 0    | 0    | 0    | 0    | 0    | 0    | 0    | 0    | 0    |
| 2003 | 0    | 0    | 0    | 0    | 0    | 0    | 0    | 0    | 0    | 0    |
| 2004 | 0    | 0    | 0    | 0    | 0    | 0    | 0    | 0    | 0    | 0    |
| 2005 | 0    | 0    | 0    | 0    | 0    | 0    | 0    | 0    | 0    | 0    |
| 2006 | 0    | 0    | 0    | 0    | 0    | 0    | 0    | 0    | 0    | 0    |
| 2007 | 0    | 0    | 0    | 0    | 0    | 0    | 0    | 0    | 0    | 0    |
| 2008 | 0    | 0    | 0    | 0    | 0    | 0    | 0    | 0    | 0    | 0    |
| 2009 | 0    | 0    | 0    | 0    | 0    | 0    | 0    | 0    | 0    | 0    |
| 2010 | 0    | 0    | 0    | 0    | 0    | 0    | 0    | 0    | 0    | 0    |
| 2011 | 0    | 0    | 0    | 0    | 0    | 0    | 0    | 0    | 0    | 0    |
| 2012 | 0    | 0    | 0    | 0    | 0    | 0    | 0    | 0    | 0    | 0    |
| 2013 | 0    | 0    | 0    | 0    | 0    | 0    | 0    | 0    | 0    | 0    |
| 2014 | 0    | 0    | 0    | 0    | 0    | 0    | 0    | 0    | 0    | 0    |
| 2015 | 0    | 0    | 0    | 0    | 0    | 0    | 0    | 0    | 0    | 0    |
| 2016 | 0    | 0    | 0    | 0    | 0    | 0    | 0    | 0    | 0    | 0    |
| 2017 | 0    | 0    | 0    | 0    | 0    | 0    | 0    | 0    | 0    | 0    |
| 2018 | 0    | 0    | 0    | 0    | 0    | 0    | 0    | 0    | 0    | 0    |
| 2019 | 0    | 0    | 0    | 0    | 0    | 0    | 0    | 0    | 0    | 0    |
| 2020 | 90   | 0    | 0    | 0    | 0    | 0    | 0    | 0    | 0    | 10   |
| 2021 | 188  | 0    | 0    | 0    | 0    | 0    | 0    | 0    | 0    | 29   |
| 2022 | 343  | 0    | 0    | 0    | 0    | 0    | 0    | 0    | 0    | 76   |
| 2023 | 569  | 0    | 0    | 0    | 0    | 0    | 0    | 0    | 0    | 149  |
| 2024 | 858  | 0    | 0    | 0    | 0    | 0    | 0    | 0    | 0    | 248  |
| 2025 | 1072 | 64   | 174  | 244  | 4    | 71   | 17   | 17   | 0    | 374  |
| 2026 | 1347 | 160  | 333  | 481  | 29   | 175  | 51   | 51   | 0    | 572  |
| 2027 | 1599 | 275  | 546  | 729  | 42   | 289  | 99   | 104  | 0    | 796  |
| 2028 | 1897 | 416  | 747  | 960  | 81   | 478  | 149  | 156  | 0    | 1090 |
| 2029 | 2167 | 581  | 952  | 1199 | 138  | 682  | 252  | 259  | 0    | 1349 |
| 2030 | 2427 | 778  | 1183 | 1441 | 197  | 926  | 394  | 402  | 10   | 1656 |
| 2031 | 2679 | 1060 | 1414 | 1662 | 284  | 1228 | 555  | 574  | 49   | 1905 |
| 2032 | 2919 | 1302 | 1672 | 1907 | 373  | 1488 | 736  | 779  | 115  | 2189 |
| 2033 | 3137 | 1627 | 1923 | 2151 | 550  | 1771 | 957  | 1021 | 193  | 2423 |
| 2034 | 3331 | 1932 | 2155 | 2390 | 689  | 2016 | 1258 | 1336 | 339  | 2714 |
| 2035 | 3515 | 2212 | 2380 | 2635 | 829  | 2247 | 1563 | 1649 | 488  | 2957 |
| 2036 | 3696 | 2427 | 2574 | 2814 | 961  | 2488 | 1847 | 1943 | 633  | 3221 |
| 2037 | 3865 | 2597 | 2819 | 3013 | 1163 | 2711 | 2127 | 2242 | 819  | 3483 |
| 2038 | 4022 | 2764 | 3079 | 3209 | 1351 | 2892 | 2394 | 2542 | 1039 | 3714 |
| 2039 | 4154 | 2940 | 3282 | 3413 | 1571 | 3090 | 2623 | 2812 | 1329 | 3946 |
| 2040 | 4280 | 3145 | 3512 | 3650 | 1798 | 3334 | 2874 | 3065 | 1649 | 4146 |
| 2041 | 4454 | 3341 | 3763 | 3894 | 2053 | 3550 | 3093 | 3304 | 1956 | 4396 |
| 2042 | 4588 | 3544 | 4066 | 4138 | 2358 | 3806 | 3356 | 3595 | 2214 | 4647 |
| 2043 | 4753 | 3726 | 4319 | 4358 | 2666 | 4049 | 3607 | 3890 | 2483 | 4916 |
| 2044 | 4867 | 3932 | 4510 | 4559 | 2960 | 4261 | 3848 | 4161 | 2747 | 5132 |
| 2045 | 4980 | 4145 | 4723 | 4724 | 3244 | 4413 | 4137 | 4474 | 3042 | 5332 |
| 2046 | 5090 | 4333 | 4882 | 4873 | 3448 | 4578 | 4369 | 4707 | 3317 | 5453 |
| 2047 | 5181 | 4453 | 5064 | 4984 | 3638 | 4692 | 4558 | 4960 | 3542 | 5610 |
| 2048 | 5269 | 4634 | 5203 | 5087 | 3811 | 4795 | 4730 | 5280 | 3802 | 5780 |
| 2049 | 5323 | 4830 | 5336 | 5185 | 4062 | 4908 | 4958 | 5514 | 4064 | 5935 |
| 2050 | 5441 | 5032 | 5463 | 5364 | 4332 | 5104 | 5088 | 5740 | 4333 | 6050 |
| 2051 | 5567 | 5183 | 5576 | 5527 | 4571 | 5277 | 5192 | 5947 | 4577 | 6130 |
| 2052 | 5733 | 5326 | 5740 | 5648 | 4741 | 5412 | 5259 | 6158 | 4788 | 6174 |
| 2053 | 5859 | 5460 | 5920 | 5760 | 4897 | 5525 | 5365 | 6379 | 4965 | 6206 |
| 2054 | 5941 | 5634 | 6092 | 5912 | 5106 | 5652 | 5536 | 6585 | 5185 | 6238 |
| 2055 | 6013 | 5831 | 6236 | 6098 | 5372 | 5850 | 5604 | 6712 | 5342 | 6272 |
| 2056 | 6075 | 5987 | 6334 | 6229 | 5533 | 5999 | 5659 | 6795 | 5494 | 6303 |
| 2057 | 6137 | 6112 | 6401 | 6316 | 5660 | 6113 | 5706 | 6849 | 5654 | 6336 |
| 2058 | 6181 | 6170 | 6420 | 6361 | 5757 | 6172 | 5743 | 6879 | 5836 | 6360 |
| 2059 | 6235 | 6229 | 6435 | 6400 | 5848 | 6243 | 5774 | 6904 | 6032 | 6388 |

EmplacedTAD

|      | 121  | 122  | 123  | 124  | 125  | 126  | 127  | 128  | 129  | 130  |
|------|------|------|------|------|------|------|------|------|------|------|
| 2060 | 6273 | 6259 | 6437 | 6421 | 5909 | 6286 | 5780 | 6917 | 6152 | 6408 |
| 2061 | 6316 | 6288 | 6437 | 6433 | 5967 | 6330 | 5788 | 6925 | 6235 | 6422 |
| 2062 | 6359 | 6312 | 6437 | 6435 | 6002 | 6363 | 5806 | 6941 | 6298 | 6436 |
| 2063 | 6396 | 6338 | 6437 | 6435 | 6044 | 6401 | 5808 | 6943 | 6344 | 6436 |
| 2064 | 6429 | 6366 | 6437 | 6435 | 6070 | 6428 | 5808 | 6943 | 6391 | 6436 |
| 2065 | 6436 | 6395 | 6437 | 6435 | 6113 | 6435 | 5808 | 6943 | 6430 | 6436 |
| 2066 | 6436 | 6415 | 6437 | 6435 | 6138 | 6435 | 5808 | 6943 | 6436 | 6436 |
| 2067 | 6436 | 6432 | 6437 | 6435 | 6163 | 6435 | 5808 | 6943 | 6436 | 6436 |
| 2068 | 6436 | 6440 | 6437 | 6435 | 6192 | 6435 | 5808 | 6943 | 6436 | 6436 |
| 2069 | 6436 | 6440 | 6437 | 6435 | 6210 | 6435 | 5808 | 6943 | 6436 | 6436 |
| 2070 | 6436 | 6440 | 6437 | 6435 | 6236 | 6435 | 5808 | 6943 | 6436 | 6436 |
| 2071 | 6436 | 6440 | 6437 | 6435 | 6248 | 6435 | 5808 | 6943 | 6436 | 6436 |
| 2072 | 6436 | 6440 | 6437 | 6435 | 6280 | 6435 | 5808 | 6943 | 6436 | 6436 |
| 2073 | 6436 | 6440 | 6437 | 6435 | 6304 | 6435 | 5808 | 6943 | 6436 | 6436 |
| 2074 | 6436 | 6440 | 6437 | 6435 | 6331 | 6435 | 5808 | 6943 | 6436 | 6436 |
| 2075 | 6436 | 6440 | 6437 | 6435 | 6369 | 6435 | 5808 | 6943 | 6436 | 6436 |
| 2076 | 6436 | 6440 | 6437 | 6435 | 6396 | 6435 | 5808 | 6943 | 6436 | 6436 |
| 2077 | 6436 | 6440 | 6437 | 6435 | 6424 | 6435 | 5808 | 6943 | 6436 | 6436 |
| 2078 | 6436 | 6440 | 6437 | 6435 | 6435 | 6435 | 5808 | 6943 | 6436 | 6436 |
| 2079 | 6436 | 6440 | 6437 | 6435 | 6435 | 6435 | 5808 | 6943 | 6436 | 6436 |
| 2080 | 6436 | 6440 | 6437 | 6435 | 6435 | 6435 | 5808 | 6943 | 6436 | 6436 |
| 2081 | 6436 | 6440 | 6437 | 6435 | 6435 | 6435 | 5808 | 6943 | 6436 | 6436 |
| 2082 | 6436 | 6440 | 6437 | 6435 | 6435 | 6435 | 5808 | 6943 | 6436 | 6436 |
| 2083 | 6436 | 6440 | 6437 | 6435 | 6435 | 6435 | 5808 | 6943 | 6436 | 6436 |
| 2084 | 6436 | 6440 | 6437 | 6435 | 6435 | 6435 | 5808 | 6943 | 6436 | 6436 |
| 2085 | 6436 | 6440 | 6437 | 6435 | 6435 | 6435 | 5808 | 6943 | 6436 | 6436 |
| 2086 | 6436 | 6440 | 6437 | 6435 | 6435 | 6435 | 5808 | 6943 | 6436 | 6436 |
| 2087 | 6436 | 6440 | 6437 | 6435 | 6435 | 6435 | 5808 | 6943 | 6436 | 6436 |
| 2088 | 6436 | 6440 | 6437 | 6435 | 6435 | 6435 | 5808 | 6943 | 6436 | 6436 |
| 2089 | 6436 | 6440 | 6437 | 6435 | 6435 | 6435 | 5808 | 6943 | 6436 | 6436 |
| 2090 | 6436 | 6440 | 6437 | 6435 | 6435 | 6435 | 5808 | 6943 | 6436 | 6436 |

EmplacedTAD

|      | 131  | 132  | 133  | 134  | 135  | 136  | 137  | 138  | 139  | 140  |
|------|------|------|------|------|------|------|------|------|------|------|
| 2002 | 0    | 0    | 0    | 0    | 0    | 0    | 0    | 0    | 0    | 0    |
| 2003 | 0    | 0    | 0    | 0    | 0    | 0    | 0    | 0    | 0    | 0    |
| 2004 | 0    | 0    | 0    | 0    | 0    | 0    | 0    | 0    | 0    | 0    |
| 2005 | 0    | 0    | 0    | 0    | 0    | 0    | 0    | 0    | 0    | 0    |
| 2006 | 0    | 0    | 0    | 0    | 0    | 0    | 0    | 0    | 0    | 0    |
| 2007 | 0    | 0    | 0    | 0    | 0    | 0    | 0    | 0    | 0    | 0    |
| 2008 | 0    | 0    | 0    | 0    | 0    | 0    | 0    | 0    | 0    | 0    |
| 2009 | 0    | 0    | 0    | 0    | 0    | 0    | 0    | 0    | 0    | 0    |
| 2010 | 0    | 0    | 0    | 0    | 0    | 0    | 0    | 0    | 0    | 0    |
| 2011 | 0    | 0    | 0    | 0    | 0    | 0    | 0    | 0    | 0    | 0    |
| 2012 | 0    | 0    | 0    | 0    | 0    | 0    | 0    | 0    | 0    | 0    |
| 2013 | 0    | 0    | 0    | 0    | 0    | 0    | 0    | 0    | 0    | 0    |
| 2014 | 0    | 0    | 0    | 0    | 0    | 0    | 0    | 0    | 0    | 0    |
| 2015 | 0    | 0    | 0    | 0    | 0    | 0    | 0    | 0    | 0    | 0    |
| 2016 | 0    | 0    | 0    | 0    | 0    | 0    | 0    | 0    | 0    | 0    |
| 2017 | 0    | 0    | 0    | 0    | 0    | 0    | 0    | 0    | 0    | 0    |
| 2018 | 0    | 0    | 0    | 0    | 0    | 0    | 0    | 0    | 0    | 0    |
| 2019 | 0    | 0    | 0    | 0    | 0    | 0    | 0    | 0    | 0    | 0    |
| 2020 | 0    | 0    | 0    | 0    | 0    | 0    | 0    | 0    | 254  | 0    |
| 2021 | 0    | 0    | 0    | 0    | 0    | 0    | 0    | 0    | 462  | 0    |
| 2022 | 0    | 0    | 0    | 0    | 0    | 0    | 0    | 0    | 700  | 0    |
| 2023 | 0    | 0    | 0    | 0    | 0    | 0    | 0    | 0    | 950  | 0    |
| 2024 | 0    | 0    | 0    | 0    | 0    | 0    | 0    | 0    | 1210 | 0    |
| 2025 | 12   | 63   | 64   | 1    | 17   | 256  | 256  | 0    | 1461 | 256  |
| 2026 | 25   | 183  | 191  | 7    | 51   | 452  | 493  | 0    | 1743 | 478  |
| 2027 | 43   | 307  | 381  | 15   | 99   | 665  | 775  | 0    | 2000 | 712  |
| 2028 | 81   | 489  | 624  | 31   | 149  | 867  | 1038 | 0    | 2255 | 952  |
| 2029 | 136  | 728  | 901  | 73   | 252  | 1079 | 1314 | 0    | 2519 | 1212 |
| 2030 | 220  | 943  | 1140 | 110  | 394  | 1327 | 1616 | 256  | 2838 | 1494 |
| 2031 | 351  | 1217 | 1450 | 143  | 557  | 1587 | 1894 | 495  | 3125 | 1766 |
| 2032 | 493  | 1450 | 1724 | 189  | 746  | 1814 | 2165 | 710  | 3402 | 2036 |
| 2033 | 656  | 1657 | 1983 | 249  | 979  | 2050 | 2445 | 978  | 3678 | 2303 |
| 2034 | 820  | 1934 | 2221 | 326  | 1293 | 2300 | 2749 | 1252 | 4009 | 2567 |
| 2035 | 999  | 2154 | 2504 | 407  | 1608 | 2576 | 3030 | 1566 | 4279 | 2836 |
| 2036 | 1259 | 2345 | 2741 | 497  | 1898 | 2830 | 3345 | 1861 | 4644 | 3146 |
| 2037 | 1602 | 2572 | 2988 | 594  | 2177 | 3127 | 3632 | 2170 | 4910 | 3453 |
| 2038 | 1896 | 2786 | 3188 | 713  | 2452 | 3394 | 3948 | 2453 | 5128 | 3727 |
| 2039 | 2210 | 3043 | 3414 | 861  | 2703 | 3718 | 4257 | 2741 | 5404 | 4037 |
| 2040 | 2497 | 3336 | 3636 | 1010 | 2954 | 4017 | 4567 | 3033 | 5682 | 4335 |
| 2041 | 2758 | 3609 | 3879 | 1191 | 3193 | 4347 | 4884 | 3325 | 5923 | 4650 |
| 2042 | 3002 | 3960 | 4165 | 1388 | 3460 | 4640 | 5240 | 3593 | 6060 | 4995 |
| 2043 | 3272 | 4225 | 4409 | 1641 | 3731 | 5003 | 5609 | 3876 | 6095 | 5286 |
| 2044 | 3564 | 4458 | 4681 | 1927 | 3989 | 5323 | 5942 | 4143 | 6193 | 5661 |
| 2045 | 3832 | 4732 | 4901 | 2208 | 4296 | 5342 | 5983 | 4498 | 6241 | 5683 |
| 2046 | 4069 | 4955 | 5105 | 2547 | 4532 | 5396 | 6124 | 4823 | 6298 | 5815 |
| 2047 | 4360 | 5142 | 5226 | 2919 | 4758 | 5479 | 6300 | 5137 | 6370 | 5932 |
| 2048 | 4658 | 5306 | 5415 | 3291 | 5043 | 5548 | 6483 | 5211 | 6412 | 6045 |
| 2049 | 4925 | 5446 | 5577 | 3630 | 5271 | 5605 | 6615 | 5233 | 6419 | 6153 |
| 2050 | 5119 | 5590 | 5683 | 3982 | 5428 | 5666 | 6719 | 5343 | 6441 | 6237 |
| 2051 | 5281 | 5702 | 5764 | 4251 | 5579 | 5699 | 6808 | 5506 | 6441 | 6302 |
| 2052 | 5442 | 5907 | 5878 | 4495 | 5724 | 5736 | 6884 | 5681 | 6441 | 6349 |
| 2053 | 5593 | 6099 | 6054 | 4871 | 5925 | 5780 | 6914 | 5806 | 6441 | 6400 |
| 2054 | 5792 | 6248 | 6213 | 5185 | 6122 | 5786 | 6914 | 5886 | 6441 | 6417 |
| 2055 | 5999 | 6333 | 6305 | 5427 | 6226 | 5798 | 6936 | 6005 | 6441 | 6429 |
| 2056 | 6116 | 6393 | 6367 | 5623 | 6302 | 5798 | 6937 | 6120 | 6441 | 6431 |
| 2057 | 6243 | 6419 | 6411 | 5788 | 6363 | 5804 | 6937 | 6199 | 6441 | 6434 |
| 2058 | 6306 | 6431 | 6432 | 5888 | 6391 | 5804 | 6937 | 6282 | 6441 | 6436 |
| 2059 | 6345 | 6434 | 6444 | 5960 | 6414 | 5804 | 6937 | 6346 | 6441 | 6436 |

EmplacedTAD

|      | 131  | 132  | 133  | 134  | 135  | 136  | 137  | 138  | 139  | 140  |
|------|------|------|------|------|------|------|------|------|------|------|
| 2060 | 6369 | 6435 | 6444 | 6044 | 6421 | 5804 | 6937 | 6394 | 6441 | 6436 |
| 2061 | 6376 | 6438 | 6444 | 6110 | 6427 | 5804 | 6937 | 6427 | 6441 | 6436 |
| 2062 | 6385 | 6438 | 6444 | 6168 | 6442 | 5804 | 6937 | 6437 | 6441 | 6436 |
| 2063 | 6393 | 6438 | 6444 | 6225 | 6444 | 5804 | 6937 | 6437 | 6441 | 6436 |
| 2064 | 6404 | 6438 | 6444 | 6272 | 6444 | 5804 | 6937 | 6437 | 6441 | 6436 |
| 2065 | 6415 | 6438 | 6444 | 6319 | 6444 | 5804 | 6937 | 6437 | 6441 | 6436 |
| 2066 | 6424 | 6438 | 6444 | 6338 | 6444 | 5804 | 6937 | 6437 | 6441 | 6436 |
| 2067 | 6435 | 6438 | 6444 | 6357 | 6444 | 5804 | 6937 | 6437 | 6441 | 6436 |
| 2068 | 6435 | 6438 | 6444 | 6376 | 6444 | 5804 | 6937 | 6437 | 6441 | 6436 |
| 2069 | 6435 | 6438 | 6444 | 6387 | 6444 | 5804 | 6937 | 6437 | 6441 | 6436 |
| 2070 | 6435 | 6438 | 6444 | 6397 | 6444 | 5804 | 6937 | 6437 | 6441 | 6436 |
| 2071 | 6435 | 6438 | 6444 | 6403 | 6444 | 5804 | 6937 | 6437 | 6441 | 6436 |
| 2072 | 6435 | 6438 | 6444 | 6415 | 6444 | 5804 | 6937 | 6437 | 6441 | 6436 |
| 2073 | 6435 | 6438 | 6444 | 6422 | 6444 | 5804 | 6937 | 6437 | 6441 | 6436 |
| 2074 | 6435 | 6438 | 6444 | 6428 | 6444 | 5804 | 6937 | 6437 | 6441 | 6436 |
| 2075 | 6435 | 6438 | 6444 | 6441 | 6444 | 5804 | 6937 | 6437 | 6441 | 6436 |
| 2076 | 6435 | 6438 | 6444 | 6444 | 6444 | 5804 | 6937 | 6437 | 6441 | 6436 |
| 2077 | 6435 | 6438 | 6444 | 6444 | 6444 | 5804 | 6937 | 6437 | 6441 | 6436 |
| 2078 | 6435 | 6438 | 6444 | 6444 | 6444 | 5804 | 6937 | 6437 | 6441 | 6436 |
| 2079 | 6435 | 6438 | 6444 | 6444 | 6444 | 5804 | 6937 | 6437 | 6441 | 6436 |
| 2080 | 6435 | 6438 | 6444 | 6444 | 6444 | 5804 | 6937 | 6437 | 6441 | 6436 |
| 2081 | 6435 | 6438 | 6444 | 6444 | 6444 | 5804 | 6937 | 6437 | 6441 | 6436 |
| 2082 | 6435 | 6438 | 6444 | 6444 | 6444 | 5804 | 6937 | 6437 | 6441 | 6436 |
| 2083 | 6435 | 6438 | 6444 | 6444 | 6444 | 5804 | 6937 | 6437 | 6441 | 6436 |
| 2084 | 6435 | 6438 | 6444 | 6444 | 6444 | 5804 | 6937 | 6437 | 6441 | 6436 |
| 2085 | 6435 | 6438 | 6444 | 6444 | 6444 | 5804 | 6937 | 6437 | 6441 | 6436 |
| 2086 | 6435 | 6438 | 6444 | 6444 | 6444 | 5804 | 6937 | 6437 | 6441 | 6436 |
| 2087 | 6435 | 6438 | 6444 | 6444 | 6444 | 5804 | 6937 | 6437 | 6441 | 6436 |
| 2088 | 6435 | 6438 | 6444 | 6444 | 6444 | 5804 | 6937 | 6437 | 6441 | 6436 |
| 2089 | 6435 | 6438 | 6444 | 6444 | 6444 | 5804 | 6937 | 6437 | 6441 | 6436 |
| 2090 | 6435 | 6438 | 6444 | 6444 | 6444 | 5804 | 6937 | 6437 | 6441 | 6436 |

EmplacedTAD

|      | 141  | 142  | 143  | 144  | 145  | 146  | 147  | 148  | 149  | 150  |
|------|------|------|------|------|------|------|------|------|------|------|
| 2002 | 0    | 0    | 0    | 0    | 0    | 0    | 0    | 0    | 0    | 0    |
| 2003 | 0    | 0    | 0    | 0    | 0    | 0    | 0    | 0    | 0    | 0    |
| 2004 | 0    | 0    | 0    | 0    | 0    | 0    | 0    | 0    | 0    | 0    |
| 2005 | 0    | 0    | 0    | 0    | 0    | 0    | 0    | 0    | 0    | 0    |
| 2006 | 0    | 0    | 0    | 0    | 0    | 0    | 0    | 0    | 0    | 0    |
| 2007 | 0    | 0    | 0    | 0    | 0    | 0    | 0    | 0    | 0    | 0    |
| 2008 | 0    | 0    | 0    | 0    | 0    | 0    | 0    | 0    | 0    | 0    |
| 2009 | 0    | 0    | 0    | 0    | 0    | 0    | 0    | 0    | 0    | 0    |
| 2010 | 0    | 0    | 0    | 0    | 0    | 0    | 0    | 0    | 0    | 0    |
| 2011 | 0    | 0    | 0    | 0    | 0    | 0    | 0    | 0    | 0    | 0    |
| 2012 | 0    | 0    | 0    | 0    | 0    | 0    | 0    | 0    | 0    | 0    |
| 2013 | 0    | 0    | 0    | 0    | 0    | 0    | 0    | 0    | 0    | 0    |
| 2014 | 0    | 0    | 0    | 0    | 0    | 0    | 0    | 0    | 0    | 0    |
| 2015 | 0    | 0    | 0    | 0    | 0    | 0    | 0    | 0    | 0    | 0    |
| 2016 | 0    | 0    | 0    | 0    | 0    | 0    | 0    | 0    | 0    | 0    |
| 2017 | 0    | 0    | 0    | 0    | 0    | 0    | 0    | 0    | 0    | 0    |
| 2018 | 0    | 0    | 0    | 0    | 0    | 0    | 0    | 0    | 0    | 0    |
| 2019 | 0    | 0    | 0    | 0    | 0    | 0    | 0    | 0    | 0    | 0    |
| 2020 | 0    | 0    | 0    | 0    | 0    | 0    | 0    | 90   | 0    | 0    |
| 2021 | 0    | 0    | 0    | 0    | 0    | 0    | 0    | 163  | 0    | 0    |
| 2022 | 0    | 0    | 0    | 0    | 0    | 0    | 0    | 331  | 0    | 0    |
| 2023 | 0    | 0    | 0    | 0    | 0    | 0    | 0    | 574  | 0    | 0    |
| 2024 | 0    | 0    | 0    | 0    | 0    | 0    | 0    | 848  | 0    | 0    |
| 2025 | 256  | 256  | 256  | 256  | 71   | 71   | 0    | 1075 | 64   | 174  |
| 2026 | 478  | 478  | 478  | 478  | 130  | 209  | 0    | 1376 | 141  | 329  |
| 2027 | 712  | 712  | 712  | 712  | 232  | 358  | 0    | 1645 | 242  | 563  |
| 2028 | 952  | 952  | 952  | 952  | 410  | 639  | 0    | 1950 | 415  | 830  |
| 2029 | 1212 | 1212 | 1212 | 1212 | 615  | 908  | 0    | 2241 | 637  | 1104 |
| 2030 | 1494 | 1494 | 1494 | 1494 | 853  | 1202 | 66   | 2548 | 859  | 1353 |
| 2031 | 1766 | 1766 | 1766 | 1766 | 1199 | 1558 | 207  | 2816 | 1187 | 1599 |
| 2032 | 2036 | 2036 | 2036 | 2036 | 1457 | 1854 | 331  | 3099 | 1456 | 1852 |
| 2033 | 2303 | 2303 | 2302 | 2303 | 1718 | 2165 | 503  | 3329 | 1786 | 2104 |
| 2034 | 2567 | 2567 | 2561 | 2567 | 2027 | 2497 | 767  | 3590 | 2142 | 2397 |
| 2035 | 2836 | 2836 | 2826 | 2836 | 2306 | 2811 | 1103 | 3837 | 2481 | 2663 |
| 2036 | 3159 | 3146 | 3128 | 3146 | 2616 | 3131 | 1458 | 4028 | 2769 | 2945 |
| 2037 | 3454 | 3453 | 3404 | 3453 | 2874 | 3395 | 1791 | 4261 | 3019 | 3205 |
| 2038 | 3760 | 3729 | 3642 | 3729 | 3104 | 3629 | 2109 | 4455 | 3256 | 3487 |
| 2039 | 4040 | 4042 | 3909 | 4042 | 3342 | 3862 | 2391 | 4605 | 3510 | 3727 |
| 2040 | 4366 | 4351 | 4129 | 4351 | 3574 | 4082 | 2640 | 4752 | 3755 | 3979 |
| 2041 | 4676 | 4687 | 4423 | 4684 | 3778 | 4301 | 2957 | 4931 | 4004 | 4248 |
| 2042 | 5022 | 5002 | 4718 | 4992 | 4035 | 4555 | 3287 | 5102 | 4249 | 4529 |
| 2043 | 5333 | 5359 | 5057 | 5336 | 4262 | 4822 | 3582 | 5313 | 4450 | 4739 |
| 2044 | 5668 | 5720 | 5357 | 5680 | 4438 | 5016 | 3854 | 5451 | 4626 | 4932 |
| 2045 | 5719 | 5730 | 5444 | 5702 | 4579 | 5181 | 4088 | 5522 | 4810 | 5141 |
| 2046 | 5746 | 5837 | 5573 | 5820 | 4779 | 5361 | 4339 | 5581 | 4986 | 5373 |
| 2047 | 5856 | 5952 | 5731 | 5947 | 4888 | 5496 | 4569 | 5666 | 5071 | 5521 |
| 2048 | 5981 | 6062 | 5873 | 6060 | 4955 | 5556 | 4765 | 5785 | 5163 | 5574 |
| 2049 | 6103 | 6154 | 5983 | 6154 | 5019 | 5720 | 4840 | 5910 | 5277 | 5707 |
| 2050 | 6177 | 6237 | 6102 | 6237 | 5106 | 5958 | 4893 | 5968 | 5442 | 5845 |
| 2051 | 6251 | 6312 | 6206 | 6312 | 5210 | 6192 | 5020 | 6028 | 5639 | 6046 |
| 2052 | 6325 | 6369 | 6290 | 6369 | 5353 | 6401 | 5182 | 6097 | 5836 | 6198 |
| 2053 | 6387 | 6415 | 6354 | 6415 | 5458 | 6557 | 5378 | 6152 | 5960 | 6291 |
| 2054 | 6423 | 6417 | 6374 | 6417 | 5521 | 6642 | 5602 | 6193 | 6059 | 6349 |
| 2055 | 6425 | 6431 | 6398 | 6431 | 5573 | 6709 | 5829 | 6241 | 6138 | 6400 |
| 2056 | 6437 | 6436 | 6410 | 6436 | 5612 | 6744 | 6008 | 6278 | 6188 | 6430 |
| 2057 | 6437 | 6436 | 6425 | 6436 | 5662 | 6797 | 6161 | 6327 | 6237 | 6446 |
| 2058 | 6437 | 6436 | 6432 | 6436 | 5686 | 6824 | 6245 | 6357 | 6259 | 6446 |
| 2059 | 6437 | 6436 | 6436 | 6436 | 5708 | 6851 | 6312 | 6389 | 6289 | 6446 |

EmplacedTAD

|      | 141  | 142  | 143  | 144  | 145  | 146  | 147  | 148  | 149  | 150  |
|------|------|------|------|------|------|------|------|------|------|------|
| 2060 | 6437 | 6436 | 6436 | 6436 | 5728 | 6869 | 6342 | 6413 | 6316 | 6446 |
| 2061 | 6437 | 6436 | 6436 | 6436 | 5754 | 6890 | 6364 | 6431 | 6331 | 6446 |
| 2062 | 6437 | 6436 | 6436 | 6436 | 5782 | 6916 | 6392 | 6437 | 6353 | 6446 |
| 2063 | 6437 | 6436 | 6436 | 6436 | 5796 | 6928 | 6417 | 6437 | 6374 | 6446 |
| 2064 | 6437 | 6436 | 6436 | 6436 | 5807 | 6941 | 6428 | 6437 | 6395 | 6446 |
| 2065 | 6437 | 6436 | 6436 | 6436 | 5807 | 6941 | 6434 | 6437 | 6412 | 6446 |
| 2066 | 6437 | 6436 | 6436 | 6436 | 5807 | 6941 | 6436 | 6437 | 6426 | 6446 |
| 2067 | 6437 | 6436 | 6436 | 6436 | 5807 | 6941 | 6436 | 6437 | 6437 | 6446 |
| 2068 | 6437 | 6436 | 6436 | 6436 | 5807 | 6941 | 6436 | 6437 | 6443 | 6446 |
| 2069 | 6437 | 6436 | 6436 | 6436 | 5807 | 6941 | 6436 | 6437 | 6443 | 6446 |
| 2070 | 6437 | 6436 | 6436 | 6436 | 5807 | 6941 | 6436 | 6437 | 6443 | 6446 |
| 2071 | 6437 | 6436 | 6436 | 6436 | 5807 | 6941 | 6436 | 6437 | 6443 | 6446 |
| 2072 | 6437 | 6436 | 6436 | 6436 | 5807 | 6941 | 6436 | 6437 | 6443 | 6446 |
| 2073 | 6437 | 6436 | 6436 | 6436 | 5807 | 6941 | 6436 | 6437 | 6443 | 6446 |
| 2074 | 6437 | 6436 | 6436 | 6436 | 5807 | 6941 | 6436 | 6437 | 6443 | 6446 |
| 2075 | 6437 | 6436 | 6436 | 6436 | 5807 | 6941 | 6436 | 6437 | 6443 | 6446 |
| 2076 | 6437 | 6436 | 6436 | 6436 | 5807 | 6941 | 6436 | 6437 | 6443 | 6446 |
| 2077 | 6437 | 6436 | 6436 | 6436 | 5807 | 6941 | 6436 | 6437 | 6443 | 6446 |
| 2078 | 6437 | 6436 | 6436 | 6436 | 5807 | 6941 | 6436 | 6437 | 6443 | 6446 |
| 2079 | 6437 | 6436 | 6436 | 6436 | 5807 | 6941 | 6436 | 6437 | 6443 | 6446 |
| 2080 | 6437 | 6436 | 6436 | 6436 | 5807 | 6941 | 6436 | 6437 | 6443 | 6446 |
| 2081 | 6437 | 6436 | 6436 | 6436 | 5807 | 6941 | 6436 | 6437 | 6443 | 6446 |
| 2082 | 6437 | 6436 | 6436 | 6436 | 5807 | 6941 | 6436 | 6437 | 6443 | 6446 |
| 2083 | 6437 | 6436 | 6436 | 6436 | 5807 | 6941 | 6436 | 6437 | 6443 | 6446 |
| 2084 | 6437 | 6436 | 6436 | 6436 | 5807 | 6941 | 6436 | 6437 | 6443 | 6446 |
| 2085 | 6437 | 6436 | 6436 | 6436 | 5807 | 6941 | 6436 | 6437 | 6443 | 6446 |
| 2086 | 6437 | 6436 | 6436 | 6436 | 5807 | 6941 | 6436 | 6437 | 6443 | 6446 |
| 2087 | 6437 | 6436 | 6436 | 6436 | 5807 | 6941 | 6436 | 6437 | 6443 | 6446 |
| 2088 | 6437 | 6436 | 6436 | 6436 | 5807 | 6941 | 6436 | 6437 | 6443 | 6446 |
| 2089 | 6437 | 6436 | 6436 | 6436 | 5807 | 6941 | 6436 | 6437 | 6443 | 6446 |
| 2090 | 6437 | 6436 | 6436 | 6436 | 5807 | 6941 | 6436 | 6437 | 6443 | 6446 |

EmplacedTAD

|      | 151  | 152  | 153  | 154  | 155  | 156  | 157  | 158  | 159  | 160  |
|------|------|------|------|------|------|------|------|------|------|------|
| 2002 | 0    | 0    | 0    | 0    | 0    | 0    | 0    | 0    | 0    | 0    |
| 2003 | 0    | 0    | 0    | 0    | 0    | 0    | 0    | 0    | 0    | 0    |
| 2004 | 0    | 0    | 0    | 0    | 0    | 0    | 0    | 0    | 0    | 0    |
| 2005 | 0    | 0    | 0    | 0    | 0    | 0    | 0    | 0    | 0    | 0    |
| 2006 | 0    | 0    | 0    | 0    | 0    | 0    | 0    | 0    | 0    | 0    |
| 2007 | 0    | 0    | 0    | 0    | 0    | 0    | 0    | 0    | 0    | 0    |
| 2008 | 0    | 0    | 0    | 0    | 0    | 0    | 0    | 0    | 0    | 0    |
| 2009 | 0    | 0    | 0    | 0    | 0    | 0    | 0    | 0    | 0    | 0    |
| 2010 | 0    | 0    | 0    | 0    | 0    | 0    | 0    | 0    | 0    | 0    |
| 2011 | 0    | 0    | 0    | 0    | 0    | 0    | 0    | 0    | 0    | 0    |
| 2012 | 0    | 0    | 0    | 0    | 0    | 0    | 0    | 0    | 0    | 0    |
| 2013 | 0    | 0    | 0    | 0    | 0    | 0    | 0    | 0    | 0    | 0    |
| 2014 | 0    | 0    | 0    | 0    | 0    | 0    | 0    | 0    | 0    | 0    |
| 2015 | 0    | 0    | 0    | 0    | 0    | 0    | 0    | 0    | 0    | 0    |
| 2016 | 0    | 0    | 0    | 0    | 0    | 0    | 0    | 0    | 0    | 0    |
| 2017 | 0    | 0    | 0    | 0    | 0    | 0    | 0    | 0    | 0    | 0    |
| 2018 | 0    | 0    | 0    | 0    | 0    | 0    | 0    | 0    | 0    | 0    |
| 2019 | 0    | 0    | 0    | 0    | 0    | 0    | 0    | 0    | 0    | 0    |
| 2020 | 0    | 0    | 0    | 0    | 0    | 0    | 10   | 0    | 0    | 0    |
| 2021 | 0    | 0    | 0    | 0    | 0    | 0    | 23   | 0    | 0    | 0    |
| 2022 | 0    | 0    | 0    | 0    | 0    | 0    | 68   | 0    | 0    | 0    |
| 2023 | 0    | 0    | 0    | 0    | 0    | 0    | 144  | 0    | 0    | 0    |
| 2024 | 0    | 0    | 0    | 0    | 0    | 0    | 272  | 0    | 0    | 0    |
| 2025 | 244  | 4    | 71   | 17   | 17   | 0    | 439  | 12   | 63   | 64   |
| 2026 | 459  | 12   | 170  | 21   | 88   | 0    | 636  | 20   | 179  | 188  |
| 2027 | 694  | 22   | 294  | 59   | 163  | 0    | 881  | 55   | 314  | 396  |
| 2028 | 979  | 37   | 531  | 96   | 289  | 0    | 1166 | 111  | 580  | 687  |
| 2029 | 1293 | 99   | 791  | 218  | 484  | 0    | 1402 | 218  | 881  | 1005 |
| 2030 | 1572 | 192  | 1052 | 350  | 688  | 10   | 1687 | 360  | 1131 | 1255 |
| 2031 | 1858 | 318  | 1392 | 552  | 898  | 89   | 1926 | 502  | 1409 | 1601 |
| 2032 | 2133 | 423  | 1648 | 806  | 1194 | 182  | 2238 | 643  | 1629 | 1899 |
| 2033 | 2395 | 559  | 1936 | 1018 | 1449 | 284  | 2519 | 840  | 1832 | 2162 |
| 2034 | 2701 | 768  | 2261 | 1325 | 1781 | 484  | 2861 | 1070 | 2128 | 2456 |
| 2035 | 2997 | 943  | 2557 | 1596 | 2086 | 724  | 3157 | 1284 | 2386 | 2764 |
| 2036 | 3258 | 1164 | 2868 | 1882 | 2399 | 970  | 3462 | 1580 | 2649 | 3072 |
| 2037 | 3493 | 1402 | 3141 | 2160 | 2664 | 1207 | 3742 | 1950 | 2909 | 3374 |
| 2038 | 3716 | 1664 | 3369 | 2497 | 3031 | 1483 | 4013 | 2234 | 3180 | 3646 |
| 2039 | 3952 | 1923 | 3610 | 2819 | 3350 | 1791 | 4254 | 2555 | 3439 | 3909 |
| 2040 | 4186 | 2215 | 3841 | 3094 | 3629 | 2109 | 4501 | 2870 | 3749 | 4184 |
| 2041 | 4451 | 2493 | 4066 | 3369 | 3915 | 2467 | 4787 | 3226 | 4020 | 4464 |
| 2042 | 4700 | 2765 | 4326 | 3691 | 4219 | 2734 | 5082 | 3505 | 4398 | 4797 |
| 2043 | 4906 | 3035 | 4570 | 3999 | 4527 | 3046 | 5326 | 3831 | 4700 | 5047 |
| 2044 | 5084 | 3262 | 4760 | 4243 | 4781 | 3344 | 5482 | 4113 | 4999 | 5322 |
| 2045 | 5255 | 3508 | 4928 | 4541 | 5107 | 3652 | 5643 | 4446 | 5269 | 5558 |
| 2046 | 5402 | 3752 | 5103 | 4718 | 5317 | 3909 | 5830 | 4708 | 5380 | 5633 |
| 2047 | 5558 | 3975 | 5223 | 4861 | 5463 | 4215 | 6064 | 4930 | 5515 | 5709 |
| 2048 | 5596 | 4153 | 5278 | 5036 | 5739 | 4443 | 6175 | 5152 | 5662 | 5844 |
| 2049 | 5673 | 4420 | 5369 | 5190 | 6020 | 4671 | 6227 | 5354 | 5831 | 6020 |
| 2050 | 5797 | 4655 | 5518 | 5370 | 6311 | 4874 | 6269 | 5599 | 6054 | 6172 |
| 2051 | 5987 | 4927 | 5725 | 5517 | 6538 | 5079 | 6312 | 5826 | 6189 | 6272 |
| 2052 | 6150 | 5174 | 5910 | 5589 | 6673 | 5302 | 6333 | 6000 | 6281 | 6346 |
| 2053 | 6251 | 5365 | 6031 | 5650 | 6761 | 5558 | 6344 | 6143 | 6337 | 6390 |
| 2054 | 6344 | 5547 | 6137 | 5701 | 6829 | 5842 | 6357 | 6235 | 6387 | 6411 |
| 2055 | 6390 | 5686 | 6211 | 5736 | 6868 | 6049 | 6372 | 6316 | 6414 | 6423 |
| 2056 | 6411 | 5750 | 6247 | 5768 | 6915 | 6194 | 6388 | 6341 | 6426 | 6433 |
| 2057 | 6423 | 5807 | 6292 | 5784 | 6932 | 6293 | 6408 | 6378 | 6436 | 6435 |
| 2058 | 6433 | 5873 | 6321 | 5786 | 6935 | 6368 | 6421 | 6398 | 6436 | 6435 |
| 2059 | 6435 | 5932 | 6344 | 5791 | 6939 | 6400 | 6435 | 6405 | 6436 | 6435 |

EmplacedTAD

|      | 151  | 152  | 153  | 154  | 155  | 156  | 157  | 158  | 159  | 160  |
|------|------|------|------|------|------|------|------|------|------|------|
| 2060 | 6435 | 5963 | 6363 | 5792 | 6940 | 6420 | 6436 | 6417 | 6436 | 6435 |
| 2061 | 6435 | 6014 | 6384 | 5798 | 6944 | 6432 | 6436 | 6423 | 6436 | 6435 |
| 2062 | 6435 | 6057 | 6410 | 5800 | 6948 | 6443 | 6436 | 6427 | 6436 | 6435 |
| 2063 | 6435 | 6104 | 6422 | 5800 | 6948 | 6444 | 6436 | 6430 | 6436 | 6435 |
| 2064 | 6435 | 6134 | 6435 | 5800 | 6948 | 6444 | 6436 | 6432 | 6436 | 6435 |
| 2065 | 6435 | 6179 | 6435 | 5800 | 6948 | 6445 | 6436 | 6433 | 6436 | 6435 |
| 2066 | 6435 | 6207 | 6435 | 5800 | 6948 | 6445 | 6436 | 6435 | 6436 | 6435 |
| 2067 | 6435 | 6237 | 6435 | 5800 | 6948 | 6445 | 6436 | 6435 | 6436 | 6435 |
| 2068 | 6435 | 6261 | 6435 | 5800 | 6948 | 6445 | 6436 | 6435 | 6436 | 6435 |
| 2069 | 6435 | 6276 | 6435 | 5800 | 6948 | 6445 | 6436 | 6435 | 6436 | 6435 |
| 2070 | 6435 | 6305 | 6435 | 5800 | 6948 | 6445 | 6436 | 6435 | 6436 | 6435 |
| 2071 | 6435 | 6324 | 6435 | 5800 | 6948 | 6445 | 6436 | 6435 | 6436 | 6435 |
| 2072 | 6435 | 6346 | 6435 | 5800 | 6948 | 6445 | 6436 | 6435 | 6436 | 6435 |
| 2073 | 6435 | 6363 | 6435 | 5800 | 6948 | 6445 | 6436 | 6435 | 6436 | 6435 |
| 2074 | 6435 | 6384 | 6435 | 5800 | 6948 | 6445 | 6436 | 6435 | 6436 | 6435 |
| 2075 | 6435 | 6409 | 6435 | 5800 | 6948 | 6445 | 6436 | 6435 | 6436 | 6435 |
| 2076 | 6435 | 6421 | 6435 | 5800 | 6948 | 6445 | 6436 | 6435 | 6436 | 6435 |
| 2077 | 6435 | 6435 | 6435 | 5800 | 6948 | 6445 | 6436 | 6435 | 6436 | 6435 |
| 2078 | 6435 | 6435 | 6435 | 5800 | 6948 | 6445 | 6436 | 6435 | 6436 | 6435 |
| 2079 | 6435 | 6435 | 6435 | 5800 | 6948 | 6445 | 6436 | 6435 | 6436 | 6435 |
| 2080 | 6435 | 6435 | 6435 | 5800 | 6948 | 6445 | 6436 | 6435 | 6436 | 6435 |
| 2081 | 6435 | 6435 | 6435 | 5800 | 6948 | 6445 | 6436 | 6435 | 6436 | 6435 |
| 2082 | 6435 | 6435 | 6435 | 5800 | 6948 | 6445 | 6436 | 6435 | 6436 | 6435 |
| 2083 | 6435 | 6435 | 6435 | 5800 | 6948 | 6445 | 6436 | 6435 | 6436 | 6435 |
| 2084 | 6435 | 6435 | 6435 | 5800 | 6948 | 6445 | 6436 | 6435 | 6436 | 6435 |
| 2085 | 6435 | 6435 | 6435 | 5800 | 6948 | 6445 | 6436 | 6435 | 6436 | 6435 |
| 2086 | 6435 | 6435 | 6435 | 5800 | 6948 | 6445 | 6436 | 6435 | 6436 | 6435 |
| 2087 | 6435 | 6435 | 6435 | 5800 | 6948 | 6445 | 6436 | 6435 | 6436 | 6435 |
| 2088 | 6435 | 6435 | 6435 | 5800 | 6948 | 6445 | 6436 | 6435 | 6436 | 6435 |
| 2089 | 6435 | 6435 | 6435 | 5800 | 6948 | 6445 | 6436 | 6435 | 6436 | 6435 |
| 2090 | 6435 | 6435 | 6435 | 5800 | 6948 | 6445 | 6436 | 6435 | 6436 | 6435 |



|      | 161  | 162  |
|------|------|------|
| 2002 | 0    | 0    |
| 2003 | 0    | 0    |
| 2004 | 0    | 0    |
| 2005 | 0    | 0    |
| 2006 | 0    | 0    |
| 2007 | 0    | 0    |
| 2008 | 0    | 0    |
| 2009 | 0    | 0    |
| 2010 | 0    | 0    |
| 2011 | 0    | 0    |
| 2012 | 0    | 0    |
| 2013 | 0    | 0    |
| 2014 | 0    | 0    |
| 2015 | 0    | 0    |
| 2016 | 0    | 0    |
| 2017 | 0    | 0    |
| 2018 | 0    | 0    |
| 2019 | 0    | 0    |
| 2020 | 0    | 0    |
| 2021 | 0    | 0    |
| 2022 | 0    | 0    |
| 2023 | 0    | 0    |
| 2024 | 0    | 0    |
| 2025 | 1    | 17   |
| 2026 | 2    | 45   |
| 2027 | 5    | 99   |
| 2028 | 12   | 205  |
| 2029 | 26   | 374  |
| 2030 | 58   | 540  |
| 2031 | 85   | 735  |
| 2032 | 139  | 993  |
| 2033 | 243  | 1219 |
| 2034 | 346  | 1550 |
| 2035 | 455  | 1843 |
| 2036 | 594  | 2147 |
| 2037 | 741  | 2413 |
| 2038 | 901  | 2768 |
| 2039 | 1096 | 3097 |
| 2040 | 1280 | 3383 |
| 2041 | 1521 | 3663 |
| 2042 | 1750 | 3985 |
| 2043 | 2022 | 4296 |
| 2044 | 2279 | 4555 |
| 2045 | 2605 | 4864 |
| 2046 | 2900 | 5047 |
| 2047 | 3248 | 5230 |
| 2048 | 3542 | 5485 |
| 2049 | 3915 | 5730 |
| 2050 | 4293 | 5964 |
| 2051 | 4591 | 6127 |
| 2052 | 4855 | 6226 |
| 2053 | 5136 | 6299 |
| 2054 | 5307 | 6340 |
| 2055 | 5470 | 6369 |
| 2056 | 5621 | 6404 |
| 2057 | 5768 | 6423 |
| 2058 | 5859 | 6424 |
| 2059 | 5949 | 6428 |

|      | 161  | 162  |
|------|------|------|
| 2060 | 6051 | 6428 |
| 2061 | 6139 | 6431 |
| 2062 | 6214 | 6435 |
| 2063 | 6273 | 6435 |
| 2064 | 6308 | 6435 |
| 2065 | 6343 | 6435 |
| 2066 | 6353 | 6435 |
| 2067 | 6370 | 6435 |
| 2068 | 6400 | 6435 |
| 2069 | 6412 | 6435 |
| 2070 | 6423 | 6435 |
| 2071 | 6424 | 6435 |
| 2072 | 6428 | 6435 |
| 2073 | 6428 | 6435 |
| 2074 | 6430 | 6435 |
| 2075 | 6435 | 6435 |
| 2076 | 6435 | 6435 |
| 2077 | 6435 | 6435 |
| 2078 | 6435 | 6435 |
| 2079 | 6435 | 6435 |
| 2080 | 6435 | 6435 |
| 2081 | 6435 | 6435 |
| 2082 | 6435 | 6435 |
| 2083 | 6435 | 6435 |
| 2084 | 6435 | 6435 |
| 2085 | 6435 | 6435 |
| 2086 | 6435 | 6435 |
| 2087 | 6435 | 6435 |
| 2088 | 6435 | 6435 |
| 2089 | 6435 | 6435 |
| 2090 | 6435 | 6435 |

|      | 1   | 2    | 3         | 4   | 5     | 6    | 7    | 8    | 9    | 10  | 11   | 12   |
|------|-----|------|-----------|-----|-------|------|------|------|------|-----|------|------|
| 2002 | 0   | 0    | 0         | 0   | 0     | 0    | 0    | 0    | 0    | 0   | 0    | 0    |
| 2003 | 0   | 0    | 0         | 0   | 0     | 0    | 0    | 0    | 0    | 0   | 0    | 0    |
| 2004 | 0   | 0    | 0         | 0   | 0     | 0    | 0    | 0    | 0    | 0   | 0    | 0    |
| 2005 | 0   | 0    | 0         | 0   | 0     | 0    | 0    | 0    | 0    | 0   | 0    | 0    |
| 2006 | 0   | 0    | 0         | 0   | 0     | 0    | 0    | 0    | 0    | 0   | 0    | 0    |
| 2007 | 0   | 0    | 0         | 0   | 0     | 0    | 0    | 0    | 0    | 0   | 0    | 0    |
| 2008 | 0   | 0    | 0         | 0   | 0     | 0    | 0    | 0    | 0    | 0   | 0    | 0    |
| 2009 | 0   | 0    | 0         | 0   | 0     | 0    | 0    | 0    | 0    | 0   | 0    | 0    |
| 2010 | 0   | 0    | 0         | 0   | 0     | 0    | 0    | 0    | 0    | 0   | 0    | 0    |
| 2011 | 0   | 0    | 0         | 0   | 0     | 0    | 0    | 0    | 0    | 0   | 0    | 0    |
| 2012 | 0   | 105  | 0         | 0   | 0     | 0    | 0    | 0    | 0    | 0   | 105  | 0    |
| 2013 | 0   | 234  | 0         | 0   | 0     | 0    | 0    | 0    | 0    | 0   | 234  | 0    |
| 2014 | 0   | 352  | 0         | 0   | 0     | 0    | 0    | 0    | 0    | 0   | 352  | 0    |
| 2015 | 0   | 501  | 0         | 0   | 0     | 0    | 0    | 0    | 0    | 0   | 501  | 0    |
| 2016 | 0   | 644  | 143       | 143 | 143   | 143  | 143  | 143  | 143  | 0   | 644  | 143  |
| 2017 | 0   | 796  | 295       | 295 | 295   | 295  | 295  | 295  | 295  | 0   | 796  | 295  |
| 2018 | 0   | 963  | 462       | 462 | 462   | 462  | 462  | 462  | 462  | 0   | 963  | 462  |
| 2019 | 0   | 1136 | 635       | 635 | 635   | 635  | 635  | 635  | 635  | 0   | 1136 | 635  |
| 2020 | 173 | 1309 | 808       | 635 | 808   | 808  | 808  | 808  | 808  | 173 | 1309 | 808  |
| 2021 | 359 | 1495 | 994       | 635 | 994   | 994  | 994  | 994  | 994  | 359 | 1495 | 994  |
| 2022 | 525 | 1661 | 1160      | 635 | 1160  | 1160 | 1160 | 1160 | 1160 | 525 | 1661 | 1160 |
| 2023 | 715 | 1851 | 1350      | 635 | 1350  | 1350 | 1350 | 1350 | 1350 | 715 | 1851 | 1350 |
| 2024 | 914 | 2050 | 1549      | 635 | 1549  | 1549 | 1549 | 1549 | 1549 | 914 | 2050 | 1549 |
| 2025 | 914 | 2050 | 1741      | 635 | 1549  | 1549 | 1549 | 1549 | 1549 | 914 | 2050 | 1741 |
| 2026 | 914 | 2050 | 1924      | 635 | 1549  | 1549 | 1549 | 1549 | 1549 | 907 | 2043 | 1924 |
| 2027 | 914 | 2050 | 2117      | 635 | 1549  | 1549 | 1549 | 1549 | 1549 | 903 | 2031 | 2117 |
| 2028 | 914 | 2050 | 2311      | 633 | 1549  | 1549 | 1549 | 1549 | 1549 | 894 | 2022 | 2311 |
| 2029 | 914 | 2050 | 2483      | 621 | 1549  | 1549 | 1549 | 1549 | 1549 | 871 | 1994 | 2483 |
| 2030 | 914 | 2050 | 2483      | 605 | 1549  | 1549 | 1549 | 1549 | 1549 | 854 | 1965 | 2483 |
| 2031 | 914 | 2050 | 2483      | 595 | 1549  | 1545 | 1549 | 1549 | 1549 | 843 | 1939 | 2481 |
| 2032 | 914 | 2050 | 2483      | 577 | 1549  | 1516 | 1549 | 1549 | 1549 | 810 | 1882 | 2467 |
| 2033 | 902 | 2035 | 2483      | 544 | 1549  | 1477 | 1534 | 1534 | 1534 | 783 | 1845 | 2445 |
| 2034 | 897 | 2030 | 2483      | 526 | 1549  | 1430 | 1529 | 1529 | 1529 | 757 | 1816 | 2426 |
| 2035 | 887 | 2020 | 2483      | 524 | 1549  | 1406 | 1519 | 1519 | 1519 | 737 | 1773 | 2396 |
| 2036 | 861 | 1992 | 2483      | 519 | 1548  | 1386 | 1491 | 1491 | 1491 | 700 | 1699 | 2350 |
| 2037 | 816 | 1950 | 2483      | 518 | 1544  | 1380 | 1449 | 1449 | 1449 | 685 | 1633 | 2296 |
| 2038 | 799 | 1930 | 2480      | 507 | 1521  | 1370 | 1429 | 1429 | 1429 | 685 | 1610 | 2225 |
| 2039 | 771 | 1878 | 2475      | 488 | 1503  | 1366 | 1382 | 1382 | 1382 | 678 | 1588 | 2157 |
| 2040 | 753 | 1844 | 2452      | 479 | 1451  | 1343 | 1353 | 1353 | 1353 | 678 | 1570 | 2102 |
| 2041 | 749 | 1819 | 2414      | 457 | 1437  | 1329 | 1335 | 1335 | 1335 | 671 | 1547 | 2060 |
| 2042 | 739 | 1790 | 2348      | 358 | 1385  | 1285 | 1314 | 1314 | 1314 | 650 | 1526 | 2009 |
| 2043 | 734 | 1765 | 2314      | 223 | 1354  | 1268 | 1290 | 1290 | 1290 | 622 | 1483 | 1975 |
| 2044 | 602 | 1585 | 2275      | 138 | 1186  | 1108 | 1128 | 1128 | 1128 | 592 | 1435 | 1952 |
| 2045 | 460 | 1364 | 2243      | 68  | 994   | 901  | 930  | 930  | 930  | 571 | 1375 | 1931 |
| 2046 | 354 | 1175 | 2040      | 9   | 809   | 750  | 747  | 747  | 747  | 551 | 1331 | 1914 |
| 2047 | 282 | 971  | 1802      | 0   | 653   | 592  | 571  | 571  | 571  | 543 | 1299 | 1896 |
| 2048 | 236 | 802  | 1598      | 0   | 529   | 476  | 462  | 462  | 462  | 535 | 1271 | 1748 |
| 2049 | 152 | 664  | 1411      | 0   | 428   | 397  | 367  | 367  | 367  | 488 | 1209 | 1545 |
| 2050 | 36  | 499  | 1234      | 0   | 293   | 253  | 231  | 231  | 231  | 324 | 998  | 1361 |
| 2051 | 0   | 330  | 1052      | 0   | 134.5 | 91   | 83   | 83   | 83   | 212 | 824  | 1235 |
| 2052 | 0   | 177  | 909       | 0   | 19    | 17   | 17   | 17   | 17   | 114 | 654  | 1073 |
| 2053 | 0   | 76   | 796       | 0   | 0     | 0    | 0    | 0    | 0    | 41  | 437  | 880  |
| 2054 | 0   | 12   | 634       | 0   | 0     | 0    | 0    | 0    | 0    | 0   | 241  | 722  |
| 2055 | 0   | 0    | 472       | 0   | 0     | 0    | 0    | 0    | 0    | 0   | 125  | 534  |
| 2056 | 0   | 0    | 276.33333 | 0   | 0     | 0    | 0    | 0    | 0    | 0   | 62   | 360  |
| 2057 | 0   | 0    | 139       | 0   | 0     | 0    | 0    | 0    | 0    | 0   | 20   | 221  |
| 2058 | 0   | 0    | 63        | 0   | 0     | 0    | 0    | 0    | 0    | 0   | 0    | 124  |
| 2059 | 0   | 0    | 17        | 0   | 0     | 0    | 0    | 0    | 0    | 0   | 0    | 68   |
| 2060 | 0   | 0    | 0         | 0   | 0     | 0    | 0    | 0    | 0    | 0   | 0    | 27   |
| 2061 | 0   | 0    | 0         | 0   | 0     | 0    | 0    | 0    | 0    | 0   | 0    | 9    |
| 2062 | 0   | 0    | 0         | 0   | 0     | 0    | 0    | 0    | 0    | 0   | 0    | 0    |
| 2063 | 0   | 0    | 0         | 0   | 0     | 0    | 0    | 0    | 0    | 0   | 0    | 0    |
| 2064 | 0   | 0    | 0         | 0   | 0     | 0    | 0    | 0    | 0    | 0   | 0    | 0    |
| 2065 | 0   | 0    | 0         | 0   | 0     | 0    | 0    | 0    | 0    | 0   | 0    | 0    |
| 2066 | 0   | 0    | 0         | 0   | 0     | 0    | 0    | 0    | 0    | 0   | 0    | 0    |
| 2067 | 0   | 0    | 0         | 0   | 0     | 0    | 0    | 0    | 0    | 0   | 0    | 0    |
| 2068 | 0   | 0    | 0         | 0   | 0     | 0    | 0    | 0    | 0    | 0   | 0    | 0    |

|      | 1 | 2 | 3 | 4 | 5 | 6 | 7 | 8 | 9 | 10 | 11 | 12 |
|------|---|---|---|---|---|---|---|---|---|----|----|----|
| 2069 | 0 | 0 | 0 | 0 | 0 | 0 | 0 | 0 | 0 | 0  | 0  | 0  |
| 2070 | 0 | 0 | 0 | 0 | 0 | 0 | 0 | 0 | 0 | 0  | 0  | 0  |
| 2071 | 0 | 0 | 0 | 0 | 0 | 0 | 0 | 0 | 0 | 0  | 0  | 0  |
| 2072 | 0 | 0 | 0 | 0 | 0 | 0 | 0 | 0 | 0 | 0  | 0  | 0  |
| 2073 | 0 | 0 | 0 | 0 | 0 | 0 | 0 | 0 | 0 | 0  | 0  | 0  |
| 2074 | 0 | 0 | 0 | 0 | 0 | 0 | 0 | 0 | 0 | 0  | 0  | 0  |
| 2075 | 0 | 0 | 0 | 0 | 0 | 0 | 0 | 0 | 0 | 0  | 0  | 0  |
| 2076 | 0 | 0 | 0 | 0 | 0 | 0 | 0 | 0 | 0 | 0  | 0  | 0  |
| 2077 | 0 | 0 | 0 | 0 | 0 | 0 | 0 | 0 | 0 | 0  | 0  | 0  |
| 2078 | 0 | 0 | 0 | 0 | 0 | 0 | 0 | 0 | 0 | 0  | 0  | 0  |
| 2079 | 0 | 0 | 0 | 0 | 0 | 0 | 0 | 0 | 0 | 0  | 0  | 0  |
| 2080 | 0 | 0 | 0 | 0 | 0 | 0 | 0 | 0 | 0 | 0  | 0  | 0  |
| 2081 | 0 | 0 | 0 | 0 | 0 | 0 | 0 | 0 | 0 | 0  | 0  | 0  |
| 2082 | 0 | 0 | 0 | 0 | 0 | 0 | 0 | 0 | 0 | 0  | 0  | 0  |
| 2083 | 0 | 0 | 0 | 0 | 0 | 0 | 0 | 0 | 0 | 0  | 0  | 0  |
| 2084 | 0 | 0 | 0 | 0 | 0 | 0 | 0 | 0 | 0 | 0  | 0  | 0  |
| 2085 | 0 | 0 | 0 | 0 | 0 | 0 | 0 | 0 | 0 | 0  | 0  | 0  |
| 2086 | 0 | 0 | 0 | 0 | 0 | 0 | 0 | 0 | 0 | 0  | 0  | 0  |
| 2087 | 0 | 0 | 0 | 0 | 0 | 0 | 0 | 0 | 0 | 0  | 0  | 0  |
| 2088 | 0 | 0 | 0 | 0 | 0 | 0 | 0 | 0 | 0 | 0  | 0  | 0  |
| 2089 | 0 | 0 | 0 | 0 | 0 | 0 | 0 | 0 | 0 | 0  | 0  | 0  |
| 2090 | 0 | 0 | 0 | 0 | 0 | 0 | 0 | 0 | 0 | 0  | 0  | 0  |
|      |   |   |   |   |   |   |   |   |   |    |    |    |

|      | 13  | 14   | 15   | 16   | 17   | 18   | 19  | 20   | 21   | 22  | 23   | 24   |
|------|-----|------|------|------|------|------|-----|------|------|-----|------|------|
| 2002 | 0   | 0    | 0    | 0    | 0    | 0    | 0   | 0    | 0    | 0   | 0    | 0    |
| 2003 | 0   | 0    | 0    | 0    | 0    | 0    | 0   | 0    | 0    | 0   | 0    | 0    |
| 2004 | 0   | 0    | 0    | 0    | 0    | 0    | 0   | 0    | 0    | 0   | 0    | 0    |
| 2005 | 0   | 0    | 0    | 0    | 0    | 0    | 0   | 0    | 0    | 0   | 0    | 0    |
| 2006 | 0   | 0    | 0    | 0    | 0    | 0    | 0   | 0    | 0    | 0   | 0    | 0    |
| 2007 | 0   | 0    | 0    | 0    | 0    | 0    | 0   | 0    | 0    | 0   | 0    | 0    |
| 2008 | 0   | 0    | 0    | 0    | 0    | 0    | 0   | 0    | 0    | 0   | 0    | 0    |
| 2009 | 0   | 0    | 0    | 0    | 0    | 0    | 0   | 0    | 0    | 0   | 0    | 0    |
| 2010 | 0   | 0    | 0    | 0    | 0    | 0    | 0   | 0    | 0    | 0   | 0    | 0    |
| 2011 | 0   | 0    | 0    | 0    | 0    | 0    | 0   | 0    | 0    | 0   | 0    | 0    |
| 2012 | 0   | 0    | 0    | 0    | 0    | 0    | 0   | 105  | 0    | 0   | 0    | 0    |
| 2013 | 0   | 0    | 0    | 0    | 0    | 0    | 0   | 234  | 0    | 0   | 0    | 0    |
| 2014 | 0   | 0    | 0    | 0    | 0    | 0    | 0   | 352  | 0    | 0   | 0    | 0    |
| 2015 | 0   | 0    | 0    | 0    | 0    | 0    | 0   | 501  | 0    | 0   | 0    | 0    |
| 2016 | 143 | 143  | 143  | 143  | 143  | 143  | 0   | 644  | 143  | 143 | 143  | 143  |
| 2017 | 295 | 295  | 295  | 295  | 295  | 295  | 0   | 796  | 295  | 295 | 295  | 295  |
| 2018 | 462 | 462  | 462  | 462  | 462  | 462  | 0   | 963  | 462  | 462 | 462  | 462  |
| 2019 | 635 | 635  | 635  | 635  | 635  | 635  | 0   | 1136 | 635  | 635 | 635  | 635  |
| 2020 | 635 | 808  | 808  | 808  | 808  | 808  | 173 | 1309 | 808  | 635 | 808  | 808  |
| 2021 | 630 | 994  | 994  | 994  | 994  | 994  | 359 | 1495 | 994  | 628 | 994  | 994  |
| 2022 | 630 | 1160 | 1160 | 1160 | 1160 | 1160 | 525 | 1661 | 1160 | 625 | 1160 | 1160 |
| 2023 | 625 | 1350 | 1350 | 1350 | 1350 | 1350 | 715 | 1851 | 1350 | 620 | 1350 | 1350 |
| 2024 | 608 | 1549 | 1549 | 1549 | 1549 | 1549 | 914 | 2050 | 1549 | 615 | 1549 | 1549 |
| 2025 | 596 | 1549 | 1549 | 1549 | 1549 | 1549 | 914 | 2050 | 1741 | 612 | 1549 | 1549 |
| 2026 | 590 | 1545 | 1526 | 1542 | 1542 | 1542 | 907 | 2043 | 1924 | 601 | 1545 | 1535 |
| 2027 | 584 | 1532 | 1498 | 1533 | 1533 | 1533 | 899 | 2029 | 2117 | 598 | 1537 | 1517 |
| 2028 | 570 | 1524 | 1475 | 1524 | 1524 | 1524 | 893 | 2023 | 2311 | 591 | 1534 | 1495 |
| 2029 | 556 | 1505 | 1443 | 1500 | 1500 | 1500 | 891 | 2009 | 2483 | 589 | 1526 | 1466 |
| 2030 | 521 | 1483 | 1423 | 1467 | 1467 | 1467 | 880 | 1991 | 2483 | 585 | 1516 | 1440 |
| 2031 | 498 | 1474 | 1394 | 1443 | 1443 | 1443 | 866 | 1968 | 2478 | 559 | 1509 | 1416 |
| 2032 | 465 | 1440 | 1377 | 1400 | 1400 | 1400 | 855 | 1944 | 2470 | 547 | 1485 | 1386 |
| 2033 | 455 | 1409 | 1357 | 1375 | 1375 | 1375 | 837 | 1911 | 2452 | 514 | 1471 | 1364 |
| 2034 | 445 | 1387 | 1315 | 1344 | 1344 | 1344 | 827 | 1900 | 2442 | 496 | 1448 | 1340 |
| 2035 | 442 | 1365 | 1278 | 1305 | 1305 | 1305 | 804 | 1872 | 2428 | 473 | 1436 | 1292 |
| 2036 | 423 | 1311 | 1226 | 1242 | 1242 | 1242 | 772 | 1828 | 2414 | 466 | 1415 | 1235 |
| 2037 | 408 | 1265 | 1187 | 1200 | 1200 | 1200 | 752 | 1783 | 2385 | 457 | 1382 | 1204 |
| 2038 | 390 | 1245 | 1162 | 1191 | 1191 | 1191 | 724 | 1724 | 2356 | 440 | 1332 | 1188 |
| 2039 | 382 | 1215 | 1121 | 1173 | 1173 | 1173 | 687 | 1652 | 2296 | 425 | 1285 | 1159 |
| 2040 | 377 | 1202 | 1109 | 1164 | 1164 | 1164 | 678 | 1618 | 2227 | 401 | 1258 | 1144 |
| 2041 | 371 | 1180 | 1075 | 1155 | 1155 | 1155 | 678 | 1589 | 2179 | 383 | 1232 | 1126 |
| 2042 | 358 | 1160 | 1032 | 1130 | 1130 | 1130 | 674 | 1569 | 2136 | 377 | 1217 | 1103 |
| 2043 | 343 | 1143 | 1009 | 1089 | 1089 | 1089 | 666 | 1534 | 2094 | 377 | 1203 | 1060 |
| 2044 | 333 | 1115 | 973  | 1054 | 1054 | 1054 | 648 | 1506 | 2057 | 371 | 1185 | 1007 |
| 2045 | 327 | 1077 | 943  | 1006 | 1006 | 1006 | 627 | 1475 | 2018 | 264 | 1181 | 967  |
| 2046 | 327 | 1052 | 913  | 979  | 979  | 979  | 606 | 1437 | 2003 | 96  | 1165 | 936  |
| 2047 | 323 | 1030 | 893  | 953  | 953  | 953  | 492 | 1296 | 1993 | 11  | 1015 | 807  |
| 2048 | 313 | 926  | 863  | 926  | 926  | 926  | 377 | 1113 | 1847 | 0   | 838  | 606  |
| 2049 | 86  | 794  | 749  | 874  | 874  | 874  | 263 | 937  | 1633 | 0   | 743  | 417  |
| 2050 | 7   | 699  | 529  | 683  | 683  | 683  | 169 | 768  | 1450 | 0   | 586  | 230  |
| 2051 | 0   | 515  | 333  | 510  | 510  | 510  | 75  | 559  | 1348 | 0   | 410  | 96   |
| 2052 | 0   | 325  | 183  | 329  | 329  | 329  | 16  | 338  | 1171 | 0   | 245  | 28   |
| 2053 | 0   | 158  | 57   | 179  | 179  | 179  | 0   | 185  | 994  | 0   | 117  | 1    |
| 2054 | 0   | 56   | 6    | 54   | 54   | 54   | 0   | 101  | 827  | 0   | 20   | 0    |
| 2055 | 0   | 9    | 0    | 10   | 10   | 10   | 0   | 44   | 633  | 0   | 0    | 0    |
| 2056 | 0   | 0    | 0    | 0    | 0    | 0    | 0   | 7    | 444  | 0   | 0    | 0    |
| 2057 | 0   | 0    | 0    | 0    | 0    | 0    | 0   | 0    | 273  | 0   | 0    | 0    |
| 2058 | 0   | 0    | 0    | 0    | 0    | 0    | 0   | 0    | 137  | 0   | 0    | 0    |
| 2059 | 0   | 0    | 0    | 0    | 0    | 0    | 0   | 0    | 70   | 0   | 0    | 0    |
| 2060 | 0   | 0    | 0    | 0    | 0    | 0    | 0   | 0    | 29   | 0   | 0    | 0    |
| 2061 | 0   | 0    | 0    | 0    | 0    | 0    | 0   | 0    | 5    | 0   | 0    | 0    |
| 2062 | 0   | 0    | 0    | 0    | 0    | 0    | 0   | 0    | 0    | 0   | 0    | 0    |
| 2063 | 0   | 0    | 0    | 0    | 0    | 0    | 0   | 0    | 0    | 0   | 0    | 0    |
| 2064 | 0   | 0    | 0    | 0    | 0    | 0    | 0   | 0    | 0    | 0   | 0    | 0    |
| 2065 | 0   | 0    | 0    | 0    | 0    | 0    | 0   | 0    | 0    | 0   | 0    | 0    |
| 2066 | 0   | 0    | 0    | 0    | 0    | 0    | 0   | 0    | 0    | 0   | 0    | 0    |
| 2067 | 0   | 0    | 0    | 0    | 0    | 0    | 0   | 0    | 0    | 0   | 0    | 0    |
| 2068 | 0   | 0    | 0    | 0    | 0    | 0    | 0   | 0    | 0    | 0   | 0    | 0    |

|      | 13 | 14 | 15 | 16 | 17 | 18 | 19 | 20 | 21 | 22 | 23 | 24 |
|------|----|----|----|----|----|----|----|----|----|----|----|----|
| 2069 | 0  | 0  | 0  | 0  | 0  | 0  | 0  | 0  | 0  | 0  | 0  | 0  |
| 2070 | 0  | 0  | 0  | 0  | 0  | 0  | 0  | 0  | 0  | 0  | 0  | 0  |
| 2071 | 0  | 0  | 0  | 0  | 0  | 0  | 0  | 0  | 0  | 0  | 0  | 0  |
| 2072 | 0  | 0  | 0  | 0  | 0  | 0  | 0  | 0  | 0  | 0  | 0  | 0  |
| 2073 | 0  | 0  | 0  | 0  | 0  | 0  | 0  | 0  | 0  | 0  | 0  | 0  |
| 2074 | 0  | 0  | 0  | 0  | 0  | 0  | 0  | 0  | 0  | 0  | 0  | 0  |
| 2075 | 0  | 0  | 0  | 0  | 0  | 0  | 0  | 0  | 0  | 0  | 0  | 0  |
| 2076 | 0  | 0  | 0  | 0  | 0  | 0  | 0  | 0  | 0  | 0  | 0  | 0  |
| 2077 | 0  | 0  | 0  | 0  | 0  | 0  | 0  | 0  | 0  | 0  | 0  | 0  |
| 2078 | 0  | 0  | 0  | 0  | 0  | 0  | 0  | 0  | 0  | 0  | 0  | 0  |
| 2079 | 0  | 0  | 0  | 0  | 0  | 0  | 0  | 0  | 0  | 0  | 0  | 0  |
| 2080 | 0  | 0  | 0  | 0  | 0  | 0  | 0  | 0  | 0  | 0  | 0  | 0  |
| 2081 | 0  | 0  | 0  | 0  | 0  | 0  | 0  | 0  | 0  | 0  | 0  | 0  |
| 2082 | 0  | 0  | 0  | 0  | 0  | 0  | 0  | 0  | 0  | 0  | 0  | 0  |
| 2083 | 0  | 0  | 0  | 0  | 0  | 0  | 0  | 0  | 0  | 0  | 0  | 0  |
| 2084 | 0  | 0  | 0  | 0  | 0  | 0  | 0  | 0  | 0  | 0  | 0  | 0  |
| 2085 | 0  | 0  | 0  | 0  | 0  | 0  | 0  | 0  | 0  | 0  | 0  | 0  |
| 2086 | 0  | 0  | 0  | 0  | 0  | 0  | 0  | 0  | 0  | 0  | 0  | 0  |
| 2087 | 0  | 0  | 0  | 0  | 0  | 0  | 0  | 0  | 0  | 0  | 0  | 0  |
| 2088 | 0  | 0  | 0  | 0  | 0  | 0  | 0  | 0  | 0  | 0  | 0  | 0  |
| 2089 | 0  | 0  | 0  | 0  | 0  | 0  | 0  | 0  | 0  | 0  | 0  | 0  |
| 2090 | 0  | 0  | 0  | 0  | 0  | 0  | 0  | 0  | 0  | 0  | 0  | 0  |
|      |    |    |    |    |    |    |    |    |    |    |    |    |

|      | 25   | 26   | 27   | 28  | 29   | 30   | 31  | 32   | 33   | 34   | 35   | 36   |
|------|------|------|------|-----|------|------|-----|------|------|------|------|------|
| 2002 | 0    | 0    | 0    | 0   | 0    | 0    | 0   | 0    | 0    | 0    | 0    | 0    |
| 2003 | 0    | 0    | 0    | 0   | 0    | 0    | 0   | 0    | 0    | 0    | 0    | 0    |
| 2004 | 0    | 0    | 0    | 0   | 0    | 0    | 0   | 0    | 0    | 0    | 0    | 0    |
| 2005 | 0    | 0    | 0    | 0   | 0    | 0    | 0   | 0    | 0    | 0    | 0    | 0    |
| 2006 | 0    | 0    | 0    | 0   | 0    | 0    | 0   | 0    | 0    | 0    | 0    | 0    |
| 2007 | 0    | 0    | 0    | 0   | 0    | 0    | 0   | 0    | 0    | 0    | 0    | 0    |
| 2008 | 0    | 0    | 0    | 0   | 0    | 0    | 0   | 0    | 0    | 0    | 0    | 0    |
| 2009 | 0    | 0    | 0    | 0   | 0    | 0    | 0   | 0    | 0    | 0    | 0    | 0    |
| 2010 | 0    | 0    | 0    | 0   | 0    | 0    | 0   | 0    | 0    | 0    | 0    | 0    |
| 2011 | 0    | 0    | 0    | 0   | 0    | 0    | 0   | 0    | 0    | 0    | 0    | 0    |
| 2012 | 0    | 0    | 0    | 0   | 105  | 0    | 0   | 0    | 0    | 0    | 0    | 0    |
| 2013 | 0    | 0    | 0    | 0   | 234  | 0    | 0   | 0    | 0    | 0    | 0    | 0    |
| 2014 | 0    | 0    | 0    | 0   | 352  | 0    | 0   | 0    | 0    | 0    | 0    | 0    |
| 2015 | 0    | 0    | 0    | 0   | 501  | 0    | 0   | 0    | 0    | 0    | 0    | 0    |
| 2016 | 143  | 143  | 143  | 0   | 644  | 143  | 143 | 143  | 143  | 143  | 143  | 143  |
| 2017 | 295  | 295  | 295  | 0   | 796  | 295  | 295 | 295  | 295  | 295  | 295  | 295  |
| 2018 | 462  | 462  | 462  | 0   | 963  | 462  | 462 | 462  | 462  | 462  | 462  | 462  |
| 2019 | 635  | 635  | 635  | 0   | 1136 | 635  | 635 | 635  | 635  | 635  | 635  | 635  |
| 2020 | 808  | 808  | 808  | 173 | 1309 | 808  | 635 | 808  | 808  | 808  | 808  | 808  |
| 2021 | 994  | 994  | 994  | 359 | 1495 | 994  | 635 | 994  | 994  | 994  | 994  | 994  |
| 2022 | 1160 | 1160 | 1160 | 525 | 1661 | 1160 | 635 | 1160 | 1160 | 1160 | 1160 | 1160 |
| 2023 | 1350 | 1350 | 1350 | 715 | 1851 | 1350 | 635 | 1350 | 1350 | 1350 | 1350 | 1350 |
| 2024 | 1549 | 1549 | 1549 | 914 | 2050 | 1549 | 635 | 1549 | 1549 | 1549 | 1549 | 1549 |
| 2025 | 1549 | 1549 | 1549 | 914 | 2050 | 1741 | 635 | 1549 | 1549 | 1549 | 1549 | 1549 |
| 2026 | 1542 | 1542 | 1542 | 914 | 2050 | 1924 | 635 | 1549 | 1549 | 1549 | 1549 | 1549 |
| 2027 | 1529 | 1529 | 1529 | 914 | 2050 | 2117 | 635 | 1549 | 1549 | 1549 | 1549 | 1549 |
| 2028 | 1523 | 1523 | 1523 | 914 | 2050 | 2311 | 633 | 1549 | 1549 | 1549 | 1549 | 1549 |
| 2029 | 1515 | 1515 | 1515 | 914 | 2050 | 2483 | 621 | 1549 | 1549 | 1549 | 1549 | 1549 |
| 2030 | 1497 | 1497 | 1497 | 914 | 2050 | 2483 | 605 | 1549 | 1549 | 1549 | 1549 | 1549 |
| 2031 | 1482 | 1482 | 1482 | 914 | 2050 | 2483 | 598 | 1549 | 1545 | 1549 | 1549 | 1549 |
| 2032 | 1457 | 1457 | 1457 | 914 | 2050 | 2483 | 580 | 1549 | 1516 | 1549 | 1549 | 1549 |
| 2033 | 1432 | 1432 | 1432 | 902 | 2035 | 2483 | 548 | 1549 | 1478 | 1534 | 1534 | 1534 |
| 2034 | 1421 | 1421 | 1421 | 897 | 2030 | 2483 | 521 | 1549 | 1431 | 1529 | 1529 | 1529 |
| 2035 | 1394 | 1394 | 1394 | 887 | 2020 | 2483 | 519 | 1549 | 1386 | 1519 | 1519 | 1519 |
| 2036 | 1351 | 1351 | 1351 | 861 | 1992 | 2483 | 514 | 1548 | 1344 | 1491 | 1491 | 1491 |
| 2037 | 1310 | 1310 | 1310 | 816 | 1950 | 2483 | 513 | 1544 | 1318 | 1449 | 1449 | 1449 |
| 2038 | 1281 | 1281 | 1281 | 803 | 1933 | 2480 | 501 | 1521 | 1293 | 1436 | 1436 | 1436 |
| 2039 | 1219 | 1219 | 1219 | 764 | 1884 | 2475 | 488 | 1503 | 1277 | 1379 | 1379 | 1379 |
| 2040 | 1190 | 1190 | 1190 | 745 | 1844 | 2452 | 479 | 1450 | 1259 | 1350 | 1350 | 1350 |
| 2041 | 1175 | 1175 | 1175 | 740 | 1825 | 2414 | 463 | 1433 | 1245 | 1340 | 1340 | 1340 |
| 2042 | 1166 | 1166 | 1166 | 730 | 1791 | 2348 | 387 | 1374 | 1220 | 1309 | 1309 | 1309 |
| 2043 | 1149 | 1149 | 1149 | 721 | 1772 | 2310 | 301 | 1335 | 1203 | 1292 | 1292 | 1292 |
| 2044 | 1124 | 1124 | 1124 | 661 | 1610 | 2264 | 210 | 1194 | 1077 | 1163 | 1163 | 1163 |
| 2045 | 1102 | 1102 | 1102 | 579 | 1411 | 2227 | 135 | 1038 | 906  | 998  | 998  | 998  |
| 2046 | 1064 | 1064 | 1064 | 480 | 1226 | 2044 | 65  | 872  | 727  | 842  | 842  | 842  |
| 2047 | 929  | 929  | 929  | 384 | 1038 | 1854 | 30  | 732  | 588  | 683  | 683  | 683  |
| 2048 | 749  | 749  | 749  | 311 | 864  | 1676 | 19  | 602  | 471  | 561  | 561  | 561  |
| 2049 | 591  | 591  | 591  | 248 | 723  | 1499 | 6   | 492  | 368  | 449  | 449  | 449  |
| 2050 | 424  | 424  | 424  | 179 | 557  | 1342 | 4   | 374  | 257  | 349  | 349  | 349  |
| 2051 | 258  | 258  | 258  | 115 | 398  | 1173 | 3   | 257  | 167  | 236  | 236  | 236  |
| 2052 | 107  | 107  | 107  | 70  | 258  | 1022 | 1   | 148  | 100  | 150  | 150  | 150  |
| 2053 | 26   | 26   | 26   | 37  | 157  | 901  | 0   | 86   | 56   | 87   | 87   | 87   |
| 2054 | 0    | 0    | 0    | 19  | 95   | 755  | 0   | 47   | 25   | 47   | 47   | 47   |
| 2055 | 0    | 0    | 0    | 5   | 39   | 605  | 0   | 19   | 12   | 15   | 15   | 15   |
| 2056 | 0    | 0    | 0    | 3   | 20   | 460  | 0   | 10   | 8    | 10   | 10   | 10   |
| 2057 | 0    | 0    | 0    | 1   | 13   | 323  | 0   | 8    | 3    | 4    | 4    | 4    |
| 2058 | 0    | 0    | 0    | 1   | 6    | 223  | 0   | 2    | 3    | 4    | 4    | 4    |
| 2059 | 0    | 0    | 0    | 0   | 3    | 142  | 0   | 1    | 3    | 4    | 4    | 4    |
| 2060 | 0    | 0    | 0    | 0   | 3    | 78   | 0   | 1    | 3    | 4    | 4    | 4    |
| 2061 | 0    | 0    | 0    | 0   | 3    | 33   | 0   | 1    | 3    | 4    | 4    | 4    |
| 2062 | 0    | 0    | 0    | 0   | 3    | 11   | 0   | 1    | 3    | 4    | 4    | 4    |
| 2063 | 0    | 0    | 0    | 0   | 3    | 6    | 0   | 1    | 3    | 4    | 4    | 4    |
| 2064 | 0    | 0    | 0    | 0   | 3    | 4    | 0   | 1    | 3    | 4    | 4    | 4    |
| 2065 | 0    | 0    | 0    | 0   | 3    | 1    | 0   | 1    | 3    | 4    | 4    | 4    |
| 2066 | 0    | 0    | 0    | 0   | 3    | 0    | 0   | 1    | 3    | 4    | 4    | 4    |
| 2067 | 0    | 0    | 0    | 0   | 3    | 0    | 0   | 1    | 3    | 4    | 4    | 4    |
| 2068 | 0    | 0    | 0    | 0   | 3    | 0    | 0   | 1    | 3    | 4    | 4    | 4    |

|      | 25 | 26 | 27 | 28 | 29 | 30 | 31 | 32 | 33 | 34 | 35 | 36 |
|------|----|----|----|----|----|----|----|----|----|----|----|----|
| 2069 | 0  | 0  | 0  | 0  | 3  | 0  | 0  | 1  | 3  | 4  | 4  | 4  |
| 2070 | 0  | 0  | 0  | 0  | 3  | 0  | 0  | 1  | 3  | 4  | 4  | 4  |
| 2071 | 0  | 0  | 0  | 0  | 3  | 0  | 0  | 1  | 3  | 4  | 4  | 4  |
| 2072 | 0  | 0  | 0  | 0  | 3  | 0  | 0  | 1  | 3  | 4  | 4  | 4  |
| 2073 | 0  | 0  | 0  | 0  | 3  | 0  | 0  | 1  | 3  | 4  | 4  | 4  |
| 2074 | 0  | 0  | 0  | 0  | 3  | 0  | 0  | 1  | 3  | 4  | 4  | 4  |
| 2075 | 0  | 0  | 0  | 0  | 3  | 0  | 0  | 1  | 3  | 4  | 4  | 4  |
| 2076 | 0  | 0  | 0  | 0  | 3  | 0  | 0  | 1  | 3  | 4  | 4  | 4  |
| 2077 | 0  | 0  | 0  | 0  | 3  | 0  | 0  | 1  | 3  | 4  | 4  | 4  |
| 2078 | 0  | 0  | 0  | 0  | 3  | 0  | 0  | 1  | 3  | 4  | 4  | 4  |
| 2079 | 0  | 0  | 0  | 0  | 3  | 0  | 0  | 1  | 3  | 4  | 4  | 4  |
| 2080 | 0  | 0  | 0  | 0  | 3  | 0  | 0  | 1  | 3  | 4  | 4  | 4  |
| 2081 | 0  | 0  | 0  | 0  | 3  | 0  | 0  | 1  | 3  | 4  | 4  | 4  |
| 2082 | 0  | 0  | 0  | 0  | 3  | 0  | 0  | 1  | 3  | 4  | 4  | 4  |
| 2083 | 0  | 0  | 0  | 0  | 3  | 0  | 0  | 1  | 3  | 4  | 4  | 4  |
| 2084 | 0  | 0  | 0  | 0  | 3  | 0  | 0  | 1  | 3  | 4  | 4  | 4  |
| 2085 | 0  | 0  | 0  | 0  | 3  | 0  | 0  | 1  | 3  | 4  | 4  | 4  |
| 2086 | 0  | 0  | 0  | 0  | 3  | 0  | 0  | 1  | 3  | 4  | 4  | 4  |
| 2087 | 0  | 0  | 0  | 0  | 3  | 0  | 0  | 1  | 3  | 4  | 4  | 4  |
| 2088 | 0  | 0  | 0  | 0  | 3  | 0  | 0  | 1  | 3  | 4  | 4  | 4  |
| 2089 | 0  | 0  | 0  | 0  | 3  | 0  | 0  | 1  | 3  | 4  | 4  | 4  |
| 2090 | 0  | 0  | 0  | 0  | 3  | 0  | 0  | 1  | 3  | 4  | 4  | 4  |
|      |    |    |    |    |    |    |    |    |    |    |    |    |

-379



|      | 37  | 38   | 39   | 40  | 41   | 42   | 43   | 44   | 45   | 46  | 47   | 48   |
|------|-----|------|------|-----|------|------|------|------|------|-----|------|------|
| 2002 | 0   | 0    | 0    | 0   | 0    | 0    | 0    | 0    | 0    | 0   | 0    | 0    |
| 2003 | 0   | 0    | 0    | 0   | 0    | 0    | 0    | 0    | 0    | 0   | 0    | 0    |
| 2004 | 0   | 0    | 0    | 0   | 0    | 0    | 0    | 0    | 0    | 0   | 0    | 0    |
| 2005 | 0   | 0    | 0    | 0   | 0    | 0    | 0    | 0    | 0    | 0   | 0    | 0    |
| 2006 | 0   | 0    | 0    | 0   | 0    | 0    | 0    | 0    | 0    | 0   | 0    | 0    |
| 2007 | 0   | 0    | 0    | 0   | 0    | 0    | 0    | 0    | 0    | 0   | 0    | 0    |
| 2008 | 0   | 0    | 0    | 0   | 0    | 0    | 0    | 0    | 0    | 0   | 0    | 0    |
| 2009 | 0   | 0    | 0    | 0   | 0    | 0    | 0    | 0    | 0    | 0   | 0    | 0    |
| 2010 | 0   | 0    | 0    | 0   | 0    | 0    | 0    | 0    | 0    | 0   | 0    | 0    |
| 2011 | 0   | 0    | 0    | 0   | 0    | 0    | 0    | 0    | 0    | 0   | 0    | 0    |
| 2012 | 0   | 105  | 0    | 0   | 0    | 0    | 0    | 0    | 0    | 0   | 105  | 0    |
| 2013 | 0   | 234  | 0    | 0   | 0    | 0    | 0    | 0    | 0    | 0   | 234  | 0    |
| 2014 | 0   | 352  | 0    | 0   | 0    | 0    | 0    | 0    | 0    | 0   | 352  | 0    |
| 2015 | 0   | 501  | 0    | 0   | 0    | 0    | 0    | 0    | 0    | 0   | 501  | 0    |
| 2016 | 0   | 644  | 143  | 143 | 143  | 143  | 143  | 143  | 143  | 0   | 644  | 143  |
| 2017 | 0   | 796  | 295  | 295 | 295  | 295  | 295  | 295  | 295  | 0   | 796  | 295  |
| 2018 | 0   | 963  | 462  | 462 | 462  | 462  | 462  | 462  | 462  | 0   | 963  | 462  |
| 2019 | 0   | 1136 | 635  | 635 | 635  | 635  | 635  | 635  | 635  | 0   | 1136 | 635  |
| 2020 | 173 | 1309 | 808  | 635 | 808  | 808  | 808  | 808  | 808  | 173 | 1309 | 808  |
| 2021 | 359 | 1495 | 994  | 630 | 994  | 994  | 994  | 994  | 994  | 359 | 1495 | 994  |
| 2022 | 525 | 1661 | 1160 | 630 | 1160 | 1160 | 1160 | 1160 | 1160 | 525 | 1661 | 1160 |
| 2023 | 715 | 1851 | 1350 | 625 | 1350 | 1350 | 1350 | 1350 | 1350 | 715 | 1851 | 1350 |
| 2024 | 914 | 2050 | 1549 | 613 | 1549 | 1549 | 1549 | 1549 | 1549 | 914 | 2050 | 1549 |
| 2025 | 914 | 2050 | 1741 | 600 | 1549 | 1549 | 1549 | 1549 | 1549 | 914 | 2050 | 1741 |
| 2026 | 907 | 2043 | 1924 | 591 | 1545 | 1526 | 1542 | 1542 | 1542 | 907 | 2043 | 1924 |
| 2027 | 903 | 2034 | 2117 | 585 | 1536 | 1502 | 1533 | 1533 | 1533 | 900 | 2034 | 2117 |
| 2028 | 894 | 2025 | 2311 | 570 | 1531 | 1486 | 1524 | 1524 | 1524 | 896 | 2030 | 2311 |
| 2029 | 874 | 1998 | 2483 | 556 | 1512 | 1458 | 1504 | 1504 | 1504 | 892 | 2016 | 2483 |
| 2030 | 858 | 1980 | 2483 | 523 | 1489 | 1434 | 1484 | 1484 | 1484 | 880 | 2001 | 2483 |
| 2031 | 843 | 1959 | 2481 | 496 | 1468 | 1408 | 1463 | 1463 | 1463 | 867 | 1983 | 2478 |
| 2032 | 813 | 1908 | 2467 | 468 | 1432 | 1385 | 1417 | 1417 | 1417 | 855 | 1959 | 2473 |
| 2033 | 789 | 1865 | 2453 | 455 | 1415 | 1355 | 1383 | 1383 | 1383 | 841 | 1926 | 2461 |
| 2034 | 755 | 1828 | 2440 | 445 | 1390 | 1318 | 1347 | 1347 | 1347 | 832 | 1903 | 2454 |
| 2035 | 740 | 1788 | 2412 | 442 | 1361 | 1284 | 1309 | 1309 | 1309 | 811 | 1878 | 2430 |
| 2036 | 710 | 1724 | 2378 | 423 | 1319 | 1240 | 1257 | 1257 | 1257 | 777 | 1840 | 2418 |
| 2037 | 687 | 1669 | 2333 | 407 | 1271 | 1199 | 1214 | 1214 | 1214 | 756 | 1806 | 2389 |
| 2038 | 686 | 1646 | 2261 | 386 | 1258 | 1173 | 1201 | 1201 | 1201 | 728 | 1755 | 2351 |
| 2039 | 679 | 1611 | 2198 | 377 | 1230 | 1132 | 1179 | 1179 | 1179 | 696 | 1684 | 2290 |
| 2040 | 676 | 1584 | 2151 | 377 | 1225 | 1117 | 1166 | 1166 | 1166 | 684 | 1647 | 2227 |
| 2041 | 668 | 1561 | 2109 | 371 | 1202 | 1085 | 1153 | 1153 | 1153 | 681 | 1616 | 2189 |
| 2042 | 649 | 1541 | 2061 | 358 | 1168 | 1040 | 1129 | 1129 | 1129 | 677 | 1596 | 2159 |
| 2043 | 620 | 1498 | 2021 | 341 | 1152 | 1016 | 1094 | 1094 | 1094 | 669 | 1556 | 2128 |
| 2044 | 586 | 1433 | 1982 | 333 | 1127 | 979  | 1044 | 1044 | 1044 | 651 | 1519 | 2091 |
| 2045 | 562 | 1368 | 1957 | 328 | 1093 | 952  | 995  | 995  | 995  | 634 | 1481 | 2052 |
| 2046 | 547 | 1322 | 1929 | 326 | 1051 | 924  | 959  | 959  | 959  | 613 | 1439 | 2019 |
| 2047 | 538 | 1290 | 1914 | 319 | 1029 | 897  | 929  | 929  | 929  | 538 | 1285 | 1995 |
| 2048 | 527 | 1250 | 1791 | 306 | 936  | 806  | 907  | 907  | 907  | 448 | 1106 | 1864 |
| 2049 | 498 | 1189 | 1584 | 180 | 776  | 634  | 846  | 846  | 846  | 356 | 916  | 1679 |
| 2050 | 398 | 979  | 1409 | 85  | 633  | 484  | 682  | 682  | 682  | 281 | 750  | 1502 |
| 2051 | 314 | 818  | 1266 | 36  | 510  | 340  | 532  | 532  | 532  | 203 | 566  | 1359 |
| 2052 | 233 | 631  | 1104 | 19  | 363  | 201  | 379  | 379  | 379  | 123 | 362  | 1204 |
| 2053 | 159 | 435  | 938  | 11  | 221  | 100  | 245  | 245  | 245  | 63  | 199  | 1031 |
| 2054 | 83  | 250  | 791  | 3   | 118  | 53   | 125  | 125  | 125  | 34  | 114  | 876  |
| 2055 | 46  | 142  | 627  | 0   | 66   | 27   | 70   | 70   | 70   | 19  | 66   | 711  |
| 2056 | 26  | 79   | 450  | 0   | 35   | 11   | 32   | 32   | 32   | 6   | 31   | 550  |
| 2057 | 11  | 36   | 299  | 0   | 14   | 5    | 11   | 11   | 11   | 3   | 8    | 379  |
| 2058 | 3   | 8    | 196  | 0   | 4    | 1    | 5    | 5    | 5    | 3   | 1    | 231  |
| 2059 | 1   | 1    | 137  | 0   | 4    | 1    | 5    | 5    | 5    | 3   | 1    | 152  |
| 2060 | 1   | 1    | 101  | 0   | 0    | 1    | 5    | 5    | 5    | 3   | 1    | 107  |
| 2061 | 0   | 1    | 74   | 0   | 0    | 1    | 5    | 5    | 5    | 3   | 1    | 75   |
| 2062 | 0   | 1    | 46   | 0   | 0    | 1    | 5    | 5    | 5    | 3   | 1    | 46   |
| 2063 | 0   | 1    | 19   | 0   | 0    | 1    | 5    | 5    | 5    | 3   | 1    | 23   |
| 2064 | 0   | 1    | 9    | 0   | 0    | 1    | 5    | 5    | 5    | 3   | 1    | 6    |
| 2065 | 0   | 1    | 9    | 0   | 0    | 1    | 5    | 5    | 5    | 3   | 1    | 3    |
| 2066 | 0   | 1    | 9    | 0   | 0    | 1    | 5    | 5    | 5    | 3   | 1    | 3    |
| 2067 | 0   | 1    | 9    | 0   | 0    | 1    | 5    | 5    | 5    | 3   | 1    | 1    |
| 2068 | 0   | 1    | 9    | 0   | 0    | 1    | 5    | 5    | 5    | 3   | 1    | 1    |

|      | 37 | 38 | 39 | 40 | 41 | 42 | 43 | 44 | 45 | 46 | 47 | 48 |
|------|----|----|----|----|----|----|----|----|----|----|----|----|
| 2069 | 0  | 1  | 9  | 0  | 0  | 1  | 5  | 5  | 5  | 3  | 1  | 1  |
| 2070 | 0  | 1  | 9  | 0  | 0  | 1  | 5  | 5  | 5  | 3  | 1  | 1  |
| 2071 | 0  | 1  | 9  | 0  | 0  | 1  | 5  | 5  | 5  | 3  | 1  | 1  |
| 2072 | 0  | 1  | 9  | 0  | 0  | 1  | 5  | 5  | 5  | 3  | 1  | 1  |
| 2073 | 0  | 1  | 9  | 0  | 0  | 1  | 5  | 5  | 5  | 3  | 1  | 1  |
| 2074 | 0  | 1  | 9  | 0  | 0  | 1  | 5  | 5  | 5  | 3  | 1  | 1  |
| 2075 | 0  | 1  | 9  | 0  | 0  | 1  | 5  | 5  | 5  | 3  | 1  | 1  |
| 2076 | 0  | 1  | 9  | 0  | 0  | 1  | 5  | 5  | 5  | 3  | 1  | 1  |
| 2077 | 0  | 1  | 9  | 0  | 0  | 1  | 5  | 5  | 5  | 3  | 1  | 1  |
| 2078 | 0  | 1  | 9  | 0  | 0  | 1  | 5  | 5  | 5  | 3  | 1  | 1  |
| 2079 | 0  | 1  | 9  | 0  | 0  | 1  | 5  | 5  | 5  | 3  | 1  | 1  |
| 2080 | 0  | 1  | 9  | 0  | 0  | 1  | 5  | 5  | 5  | 3  | 1  | 1  |
| 2081 | 0  | 1  | 9  | 0  | 0  | 1  | 5  | 5  | 5  | 3  | 1  | 1  |
| 2082 | 0  | 1  | 9  | 0  | 0  | 1  | 5  | 5  | 5  | 3  | 1  | 1  |
| 2083 | 0  | 1  | 9  | 0  | 0  | 1  | 5  | 5  | 5  | 3  | 1  | 1  |
| 2084 | 0  | 1  | 9  | 0  | 0  | 1  | 5  | 5  | 5  | 3  | 1  | 1  |
| 2085 | 0  | 1  | 9  | 0  | 0  | 1  | 5  | 5  | 5  | 3  | 1  | 1  |
| 2086 | 0  | 1  | 9  | 0  | 0  | 1  | 5  | 5  | 5  | 3  | 1  | 1  |
| 2087 | 0  | 1  | 9  | 0  | 0  | 1  | 5  | 5  | 5  | 3  | 1  | 1  |
| 2088 | 0  | 1  | 9  | 0  | 0  | 1  | 5  | 5  | 5  | 3  | 1  | 1  |
| 2089 | 0  | 1  | 9  | 0  | 0  | 1  | 5  | 5  | 5  | 3  | 1  | 1  |
| 2090 | 0  | 1  | 9  | 0  | 0  | 1  | 5  | 5  | 5  | 3  | 1  | 1  |
|      |    |    |    |    |    |    |    |    |    |    |    |    |

|      | 49  | 50   | 51   | 52   | 53   | 54   | 55  | 56   | 57   | 58  | 59   | 60   |
|------|-----|------|------|------|------|------|-----|------|------|-----|------|------|
| 2002 | 0   | 0    | 0    | 0    | 0    | 0    | 0   | 0    | 0    | 0   | 0    | 0    |
| 2003 | 0   | 0    | 0    | 0    | 0    | 0    | 0   | 0    | 0    | 0   | 0    | 0    |
| 2004 | 0   | 0    | 0    | 0    | 0    | 0    | 0   | 0    | 0    | 0   | 0    | 0    |
| 2005 | 0   | 0    | 0    | 0    | 0    | 0    | 0   | 0    | 0    | 0   | 0    | 0    |
| 2006 | 0   | 0    | 0    | 0    | 0    | 0    | 0   | 0    | 0    | 0   | 0    | 0    |
| 2007 | 0   | 0    | 0    | 0    | 0    | 0    | 0   | 0    | 0    | 0   | 0    | 0    |
| 2008 | 0   | 0    | 0    | 0    | 0    | 0    | 0   | 0    | 0    | 0   | 0    | 0    |
| 2009 | 0   | 0    | 0    | 0    | 0    | 0    | 0   | 0    | 0    | 0   | 0    | 0    |
| 2010 | 0   | 0    | 0    | 0    | 0    | 0    | 0   | 0    | 0    | 0   | 0    | 0    |
| 2011 | 0   | 0    | 0    | 0    | 0    | 0    | 0   | 0    | 0    | 0   | 0    | 0    |
| 2012 | 0   | 0    | 0    | 0    | 0    | 0    | 0   | 105  | 0    | 0   | 0    | 0    |
| 2013 | 0   | 0    | 0    | 0    | 0    | 0    | 0   | 234  | 0    | 0   | 0    | 0    |
| 2014 | 0   | 0    | 0    | 0    | 0    | 0    | 0   | 352  | 0    | 0   | 0    | 0    |
| 2015 | 0   | 0    | 0    | 0    | 0    | 0    | 0   | 501  | 0    | 0   | 0    | 0    |
| 2016 | 143 | 143  | 143  | 143  | 143  | 143  | 0   | 644  | 143  | 143 | 143  | 143  |
| 2017 | 295 | 295  | 295  | 295  | 295  | 295  | 0   | 796  | 295  | 295 | 295  | 295  |
| 2018 | 462 | 462  | 462  | 462  | 462  | 462  | 0   | 963  | 462  | 462 | 462  | 462  |
| 2019 | 635 | 635  | 635  | 635  | 635  | 635  | 0   | 1136 | 635  | 635 | 635  | 635  |
| 2020 | 635 | 808  | 808  | 808  | 808  | 808  | 173 | 1309 | 808  | 635 | 808  | 808  |
| 2021 | 628 | 994  | 994  | 994  | 994  | 994  | 359 | 1495 | 994  | 536 | 994  | 994  |
| 2022 | 627 | 1160 | 1160 | 1160 | 1160 | 1160 | 525 | 1661 | 1160 | 456 | 1160 | 1160 |
| 2023 | 623 | 1350 | 1350 | 1350 | 1350 | 1350 | 715 | 1851 | 1350 | 444 | 1350 | 1350 |
| 2024 | 617 | 1549 | 1549 | 1549 | 1549 | 1549 | 914 | 2050 | 1549 | 412 | 1549 | 1549 |
| 2025 | 613 | 1549 | 1549 | 1549 | 1549 | 1549 | 914 | 2050 | 1741 | 390 | 1549 | 1549 |
| 2026 | 603 | 1545 | 1535 | 1542 | 1542 | 1542 | 822 | 1948 | 1924 | 363 | 1447 | 1447 |
| 2027 | 598 | 1541 | 1520 | 1534 | 1534 | 1534 | 729 | 1834 | 2117 | 343 | 1338 | 1338 |
| 2028 | 591 | 1538 | 1503 | 1530 | 1530 | 1530 | 671 | 1740 | 2311 | 332 | 1246 | 1246 |
| 2029 | 589 | 1528 | 1482 | 1522 | 1522 | 1522 | 623 | 1619 | 2483 | 324 | 1144 | 1144 |
| 2030 | 585 | 1520 | 1453 | 1507 | 1507 | 1507 | 603 | 1519 | 2483 | 310 | 1073 | 1073 |
| 2031 | 560 | 1517 | 1426 | 1489 | 1489 | 1489 | 591 | 1451 | 2380 | 295 | 1028 | 1028 |
| 2032 | 549 | 1495 | 1394 | 1471 | 1471 | 1471 | 556 | 1359 | 2244 | 282 | 963  | 963  |
| 2033 | 518 | 1479 | 1375 | 1446 | 1446 | 1446 | 524 | 1256 | 2120 | 264 | 911  | 911  |
| 2034 | 498 | 1453 | 1350 | 1433 | 1433 | 1433 | 514 | 1205 | 2012 | 250 | 881  | 881  |
| 2035 | 475 | 1434 | 1303 | 1407 | 1407 | 1407 | 511 | 1185 | 1872 | 238 | 861  | 858  |
| 2036 | 467 | 1418 | 1245 | 1369 | 1369 | 1369 | 494 | 1152 | 1734 | 212 | 831  | 827  |
| 2037 | 459 | 1390 | 1222 | 1337 | 1337 | 1337 | 477 | 1122 | 1624 | 210 | 831  | 815  |
| 2038 | 440 | 1340 | 1200 | 1296 | 1296 | 1296 | 472 | 1084 | 1551 | 202 | 801  | 775  |
| 2039 | 426 | 1296 | 1168 | 1236 | 1236 | 1236 | 449 | 1052 | 1485 | 181 | 776  | 765  |
| 2040 | 403 | 1268 | 1145 | 1210 | 1210 | 1210 | 432 | 1019 | 1448 | 171 | 756  | 745  |
| 2041 | 386 | 1246 | 1125 | 1187 | 1187 | 1187 | 397 | 992  | 1410 | 163 | 718  | 705  |
| 2042 | 377 | 1222 | 1104 | 1172 | 1172 | 1172 | 387 | 973  | 1390 | 146 | 708  | 677  |
| 2043 | 377 | 1209 | 1066 | 1160 | 1160 | 1160 | 326 | 914  | 1369 | 109 | 669  | 634  |
| 2044 | 369 | 1197 | 1025 | 1134 | 1134 | 1134 | 299 | 853  | 1345 | 22  | 618  | 606  |
| 2045 | 306 | 1193 | 978  | 1106 | 1106 | 1106 | 287 | 829  | 1309 | 0   | 579  | 566  |
| 2046 | 190 | 1175 | 945  | 1069 | 1069 | 1069 | 105 | 587  | 1253 | 0   | 358  | 343  |
| 2047 | 103 | 1057 | 821  | 960  | 960  | 960  | 32  | 405  | 1220 | 0   | 216  | 204  |
| 2048 | 47  | 885  | 662  | 798  | 798  | 798  | 4   | 230  | 1164 | 0   | 84   | 76   |
| 2049 | 20  | 766  | 516  | 641  | 641  | 641  | 0   | 116  | 944  | 0   | 16   | 14   |
| 2050 | 10  | 640  | 375  | 515  | 515  | 515  | 0   | 37   | 727  | 0   | 0    | 0    |
| 2051 | 4   | 491  | 243  | 378  | 378  | 378  | 0   | 0    | 558  | 0   | 0    | 0    |
| 2052 | 4   | 346  | 127  | 225  | 225  | 225  | 0   | 0    | 439  | 0   | 0    | 0    |
| 2053 | 0   | 206  | 73   | 120  | 120  | 120  | 0   | 0    | 270  | 0   | 0    | 0    |
| 2054 | 0   | 119  | 37   | 65   | 65   | 65   | 0   | 0    | 125  | 0   | 0    | 0    |
| 2055 | 0   | 69   | 16   | 34   | 34   | 34   | 0   | 0    | 43   | 0   | 0    | 0    |
| 2056 | 0   | 37   | 8    | 13   | 13   | 13   | 0   | 0    | 4    | 0   | 0    | 0    |
| 2057 | 0   | 16   | 1    | 5    | 5    | 5    | 0   | 0    | 0    | 0   | 0    | 0    |
| 2058 | 0   | 6    | 1    | 5    | 5    | 5    | 0   | 0    | 0    | 0   | 0    | 0    |
| 2059 | 0   | 6    | 0    | 0    | 0    | 0    | 0   | 0    | 0    | 0   | 0    | 0    |
| 2060 | 0   | 6    | 0    | 0    | 0    | 0    | 0   | 0    | 0    | 0   | 0    | 0    |
| 2061 | 0   | 6    | 0    | 0    | 0    | 0    | 0   | 0    | 0    | 0   | 0    | 0    |
| 2062 | 0   | 6    | 0    | 0    | 0    | 0    | 0   | 0    | 0    | 0   | 0    | 0    |
| 2063 | 0   | 6    | 0    | 0    | 0    | 0    | 0   | 0    | 0    | 0   | 0    | 0    |
| 2064 | 0   | 6    | 0    | 0    | 0    | 0    | 0   | 0    | 0    | 0   | 0    | 0    |
| 2065 | 0   | 6    | 0    | 0    | 0    | 0    | 0   | 0    | 0    | 0   | 0    | 0    |
| 2066 | 0   | 6    | 0    | 0    | 0    | 0    | 0   | 0    | 0    | 0   | 0    | 0    |
| 2067 | 0   | 6    | 0    | 0    | 0    | 0    | 0   | 0    | 0    | 0   | 0    | 0    |
| 2068 | 0   | 6    | 0    | 0    | 0    | 0    | 0   | 0    | 0    | 0   | 0    | 0    |

|      | 49 | 50 | 51 | 52 | 53 | 54 | 55 | 56 | 57 | 58 | 59 | 60 |
|------|----|----|----|----|----|----|----|----|----|----|----|----|
| 2069 | 0  | 6  | 0  | 0  | 0  | 0  | 0  | 0  | 0  | 0  | 0  | 0  |
| 2070 | 0  | 6  | 0  | 0  | 0  | 0  | 0  | 0  | 0  | 0  | 0  | 0  |
| 2071 | 0  | 6  | 0  | 0  | 0  | 0  | 0  | 0  | 0  | 0  | 0  | 0  |
| 2072 | 0  | 6  | 0  | 0  | 0  | 0  | 0  | 0  | 0  | 0  | 0  | 0  |
| 2073 | 0  | 6  | 0  | 0  | 0  | 0  | 0  | 0  | 0  | 0  | 0  | 0  |
| 2074 | 0  | 6  | 0  | 0  | 0  | 0  | 0  | 0  | 0  | 0  | 0  | 0  |
| 2075 | 0  | 6  | 0  | 0  | 0  | 0  | 0  | 0  | 0  | 0  | 0  | 0  |
| 2076 | 0  | 6  | 0  | 0  | 0  | 0  | 0  | 0  | 0  | 0  | 0  | 0  |
| 2077 | 0  | 6  | 0  | 0  | 0  | 0  | 0  | 0  | 0  | 0  | 0  | 0  |
| 2078 | 0  | 6  | 0  | 0  | 0  | 0  | 0  | 0  | 0  | 0  | 0  | 0  |
| 2079 | 0  | 6  | 0  | 0  | 0  | 0  | 0  | 0  | 0  | 0  | 0  | 0  |
| 2080 | 0  | 6  | 0  | 0  | 0  | 0  | 0  | 0  | 0  | 0  | 0  | 0  |
| 2081 | 0  | 6  | 0  | 0  | 0  | 0  | 0  | 0  | 0  | 0  | 0  | 0  |
| 2082 | 0  | 6  | 0  | 0  | 0  | 0  | 0  | 0  | 0  | 0  | 0  | 0  |
| 2083 | 0  | 6  | 0  | 0  | 0  | 0  | 0  | 0  | 0  | 0  | 0  | 0  |
| 2084 | 0  | 6  | 0  | 0  | 0  | 0  | 0  | 0  | 0  | 0  | 0  | 0  |
| 2085 | 0  | 6  | 0  | 0  | 0  | 0  | 0  | 0  | 0  | 0  | 0  | 0  |
| 2086 | 0  | 6  | 0  | 0  | 0  | 0  | 0  | 0  | 0  | 0  | 0  | 0  |
| 2087 | 0  | 6  | 0  | 0  | 0  | 0  | 0  | 0  | 0  | 0  | 0  | 0  |
| 2088 | 0  | 6  | 0  | 0  | 0  | 0  | 0  | 0  | 0  | 0  | 0  | 0  |
| 2089 | 0  | 6  | 0  | 0  | 0  | 0  | 0  | 0  | 0  | 0  | 0  | 0  |
| 2090 | 0  | 6  | 0  | 0  | 0  | 0  | 0  | 0  | 0  | 0  | 0  | 0  |
|      |    |    |    |    |    |    |    |    |    |    |    |    |

|      | 61   | 62   | 63   | 64  | 65   | 66   | 67  | 68   | 69   | 70   | 71   | 72   |
|------|------|------|------|-----|------|------|-----|------|------|------|------|------|
| 2002 | 0    | 0    | 0    | 0   | 0    | 0    | 0   | 0    | 0    | 0    | 0    | 0    |
| 2003 | 0    | 0    | 0    | 0   | 0    | 0    | 0   | 0    | 0    | 0    | 0    | 0    |
| 2004 | 0    | 0    | 0    | 0   | 0    | 0    | 0   | 0    | 0    | 0    | 0    | 0    |
| 2005 | 0    | 0    | 0    | 0   | 0    | 0    | 0   | 0    | 0    | 0    | 0    | 0    |
| 2006 | 0    | 0    | 0    | 0   | 0    | 0    | 0   | 0    | 0    | 0    | 0    | 0    |
| 2007 | 0    | 0    | 0    | 0   | 0    | 0    | 0   | 0    | 0    | 0    | 0    | 0    |
| 2008 | 0    | 0    | 0    | 0   | 0    | 0    | 0   | 0    | 0    | 0    | 0    | 0    |
| 2009 | 0    | 0    | 0    | 0   | 0    | 0    | 0   | 0    | 0    | 0    | 0    | 0    |
| 2010 | 0    | 0    | 0    | 0   | 0    | 0    | 0   | 0    | 0    | 0    | 0    | 0    |
| 2011 | 0    | 0    | 0    | 0   | 0    | 0    | 0   | 0    | 0    | 0    | 0    | 0    |
| 2012 | 0    | 0    | 0    | 0   | 105  | 0    | 0   | 0    | 0    | 0    | 0    | 0    |
| 2013 | 0    | 0    | 0    | 0   | 234  | 0    | 0   | 0    | 0    | 0    | 0    | 0    |
| 2014 | 0    | 0    | 0    | 0   | 352  | 0    | 0   | 0    | 0    | 0    | 0    | 0    |
| 2015 | 0    | 0    | 0    | 0   | 501  | 0    | 0   | 0    | 0    | 0    | 0    | 0    |
| 2016 | 143  | 143  | 143  | 0   | 644  | 143  | 143 | 143  | 143  | 143  | 143  | 143  |
| 2017 | 295  | 295  | 295  | 0   | 796  | 295  | 295 | 295  | 295  | 295  | 295  | 295  |
| 2018 | 462  | 462  | 462  | 0   | 963  | 462  | 462 | 462  | 462  | 462  | 462  | 462  |
| 2019 | 635  | 635  | 635  | 0   | 1136 | 635  | 635 | 635  | 635  | 635  | 635  | 635  |
| 2020 | 808  | 808  | 808  | 173 | 1309 | 808  | 635 | 808  | 808  | 808  | 808  | 808  |
| 2021 | 994  | 994  | 994  | 359 | 1495 | 994  | 514 | 994  | 994  | 994  | 994  | 994  |
| 2022 | 1160 | 1160 | 1160 | 525 | 1661 | 1160 | 434 | 1160 | 1160 | 1160 | 1160 | 1160 |
| 2023 | 1350 | 1350 | 1350 | 715 | 1851 | 1350 | 385 | 1350 | 1350 | 1350 | 1350 | 1350 |
| 2024 | 1549 | 1549 | 1549 | 914 | 2050 | 1549 | 373 | 1549 | 1549 | 1549 | 1549 | 1549 |
| 2025 | 1549 | 1549 | 1549 | 914 | 2050 | 1741 | 371 | 1549 | 1549 | 1549 | 1549 | 1549 |
| 2026 | 1447 | 1447 | 1447 | 740 | 1861 | 1924 | 368 | 1360 | 1360 | 1360 | 1360 | 1360 |
| 2027 | 1338 | 1338 | 1338 | 623 | 1695 | 2117 | 362 | 1207 | 1207 | 1207 | 1207 | 1207 |
| 2028 | 1246 | 1246 | 1246 | 557 | 1552 | 2311 | 352 | 1073 | 1073 | 1073 | 1073 | 1073 |
| 2029 | 1144 | 1144 | 1144 | 535 | 1431 | 2483 | 348 | 1001 | 998  | 999  | 999  | 999  |
| 2030 | 1073 | 1073 | 1073 | 499 | 1339 | 2483 | 345 | 945  | 944  | 943  | 943  | 943  |
| 2031 | 1028 | 1028 | 1028 | 489 | 1294 | 2276 | 335 | 915  | 914  | 913  | 913  | 913  |
| 2032 | 963  | 963  | 963  | 485 | 1248 | 2062 | 328 | 885  | 879  | 878  | 878  | 878  |
| 2033 | 911  | 911  | 911  | 477 | 1199 | 1889 | 318 | 855  | 851  | 851  | 851  | 851  |
| 2034 | 881  | 881  | 881  | 467 | 1154 | 1738 | 298 | 836  | 836  | 836  | 836  | 836  |
| 2035 | 861  | 861  | 861  | 458 | 1137 | 1643 | 298 | 824  | 824  | 823  | 823  | 823  |
| 2036 | 831  | 831  | 831  | 453 | 1103 | 1563 | 298 | 815  | 815  | 814  | 814  | 814  |
| 2037 | 831  | 831  | 831  | 444 | 1093 | 1502 | 298 | 805  | 795  | 804  | 804  | 804  |
| 2038 | 801  | 801  | 801  | 444 | 1077 | 1425 | 298 | 792  | 772  | 791  | 791  | 791  |
| 2039 | 776  | 776  | 776  | 444 | 1060 | 1393 | 279 | 782  | 743  | 781  | 781  | 781  |
| 2040 | 745  | 745  | 745  | 426 | 1036 | 1353 | 279 | 770  | 722  | 760  | 760  | 760  |
| 2041 | 705  | 705  | 705  | 414 | 1006 | 1286 | 270 | 751  | 702  | 741  | 741  | 741  |
| 2042 | 687  | 687  | 687  | 396 | 980  | 1255 | 229 | 731  | 689  | 721  | 721  | 721  |
| 2043 | 621  | 621  | 621  | 393 | 960  | 1214 | 207 | 711  | 688  | 701  | 701  | 701  |
| 2044 | 581  | 581  | 581  | 393 | 941  | 1195 | 194 | 707  | 688  | 697  | 697  | 697  |
| 2045 | 554  | 554  | 554  | 393 | 932  | 1192 | 194 | 707  | 666  | 697  | 697  | 697  |
| 2046 | 340  | 340  | 340  | 393 | 932  | 1182 | 33  | 707  | 636  | 697  | 697  | 697  |
| 2047 | 178  | 178  | 178  | 393 | 932  | 1172 | 4   | 707  | 577  | 693  | 693  | 693  |
| 2048 | 60   | 60   | 60   | 390 | 922  | 1170 | 0   | 707  | 339  | 688  | 688  | 688  |
| 2049 | 10   | 10   | 10   | 162 | 677  | 1170 | 0   | 461  | 148  | 444  | 444  | 444  |
| 2050 | 0    | 0    | 0    | 47  | 459  | 929  | 0   | 246  | 59   | 232  | 232  | 232  |
| 2051 | 0    | 0    | 0    | 0   | 245  | 702  | 0   | 102  | 15   | 94   | 94   | 94   |
| 2052 | 0    | 0    | 0    | 0   | 121  | 475  | 0   | 32   | 0    | 31   | 31   | 31   |
| 2053 | 0    | 0    | 0    | 0   | 65   | 286  | 0   | 3    | 0    | 3    | 3    | 3    |
| 2054 | 0    | 0    | 0    | 0   | 25   | 167  | 0   | 0    | 0    | 0    | 0    | 0    |
| 2055 | 0    | 0    | 0    | 0   | 8    | 64   | 0   | 0    | 0    | 0    | 0    | 0    |
| 2056 | 0    | 0    | 0    | 0   | 0    | 14   | 0   | 0    | 0    | 0    | 0    | 0    |
| 2057 | 0    | 0    | 0    | 0   | 0    | 1    | 0   | 0    | 0    | 0    | 0    | 0    |
| 2058 | 0    | 0    | 0    | 0   | 0    | 0    | 0   | 0    | 0    | 0    | 0    | 0    |
| 2059 | 0    | 0    | 0    | 0   | 0    | 0    | 0   | 0    | 0    | 0    | 0    | 0    |
| 2060 | 0    | 0    | 0    | 0   | 0    | 0    | 0   | 0    | 0    | 0    | 0    | 0    |
| 2061 | 0    | 0    | 0    | 0   | 0    | 0    | 0   | 0    | 0    | 0    | 0    | 0    |
| 2062 | 0    | 0    | 0    | 0   | 0    | 0    | 0   | 0    | 0    | 0    | 0    | 0    |
| 2063 | 0    | 0    | 0    | 0   | 0    | 0    | 0   | 0    | 0    | 0    | 0    | 0    |
| 2064 | 0    | 0    | 0    | 0   | 0    | 0    | 0   | 0    | 0    | 0    | 0    | 0    |
| 2065 | 0    | 0    | 0    | 0   | 0    | 0    | 0   | 0    | 0    | 0    | 0    | 0    |
| 2066 | 0    | 0    | 0    | 0   | 0    | 0    | 0   | 0    | 0    | 0    | 0    | 0    |
| 2067 | 0    | 0    | 0    | 0   | 0    | 0    | 0   | 0    | 0    | 0    | 0    | 0    |
| 2068 | 0    | 0    | 0    | 0   | 0    | 0    | 0   | 0    | 0    | 0    | 0    | 0    |

|      | 61 | 62 | 63 | 64 | 65 | 66 | 67 | 68 | 69 | 70 | 71 | 72 |
|------|----|----|----|----|----|----|----|----|----|----|----|----|
| 2069 | 0  | 0  | 0  | 0  | 0  | 0  | 0  | 0  | 0  | 0  | 0  | 0  |
| 2070 | 0  | 0  | 0  | 0  | 0  | 0  | 0  | 0  | 0  | 0  | 0  | 0  |
| 2071 | 0  | 0  | 0  | 0  | 0  | 0  | 0  | 0  | 0  | 0  | 0  | 0  |
| 2072 | 0  | 0  | 0  | 0  | 0  | 0  | 0  | 0  | 0  | 0  | 0  | 0  |
| 2073 | 0  | 0  | 0  | 0  | 0  | 0  | 0  | 0  | 0  | 0  | 0  | 0  |
| 2074 | 0  | 0  | 0  | 0  | 0  | 0  | 0  | 0  | 0  | 0  | 0  | 0  |
| 2075 | 0  | 0  | 0  | 0  | 0  | 0  | 0  | 0  | 0  | 0  | 0  | 0  |
| 2076 | 0  | 0  | 0  | 0  | 0  | 0  | 0  | 0  | 0  | 0  | 0  | 0  |
| 2077 | 0  | 0  | 0  | 0  | 0  | 0  | 0  | 0  | 0  | 0  | 0  | 0  |
| 2078 | 0  | 0  | 0  | 0  | 0  | 0  | 0  | 0  | 0  | 0  | 0  | 0  |
| 2079 | 0  | 0  | 0  | 0  | 0  | 0  | 0  | 0  | 0  | 0  | 0  | 0  |
| 2080 | 0  | 0  | 0  | 0  | 0  | 0  | 0  | 0  | 0  | 0  | 0  | 0  |
| 2081 | 0  | 0  | 0  | 0  | 0  | 0  | 0  | 0  | 0  | 0  | 0  | 0  |
| 2082 | 0  | 0  | 0  | 0  | 0  | 0  | 0  | 0  | 0  | 0  | 0  | 0  |
| 2083 | 0  | 0  | 0  | 0  | 0  | 0  | 0  | 0  | 0  | 0  | 0  | 0  |
| 2084 | 0  | 0  | 0  | 0  | 0  | 0  | 0  | 0  | 0  | 0  | 0  | 0  |
| 2085 | 0  | 0  | 0  | 0  | 0  | 0  | 0  | 0  | 0  | 0  | 0  | 0  |
| 2086 | 0  | 0  | 0  | 0  | 0  | 0  | 0  | 0  | 0  | 0  | 0  | 0  |
| 2087 | 0  | 0  | 0  | 0  | 0  | 0  | 0  | 0  | 0  | 0  | 0  | 0  |
| 2088 | 0  | 0  | 0  | 0  | 0  | 0  | 0  | 0  | 0  | 0  | 0  | 0  |
| 2089 | 0  | 0  | 0  | 0  | 0  | 0  | 0  | 0  | 0  | 0  | 0  | 0  |
| 2090 | 0  | 0  | 0  | 0  | 0  | 0  | 0  | 0  | 0  | 0  | 0  | 0  |
|      |    |    |    |    |    |    |    |    |    |    |    |    |

|      | 73  | 74   | 75   | 76  | 77   | 78   | 79   | 80   | 81   | 82  | 83   | 84   |
|------|-----|------|------|-----|------|------|------|------|------|-----|------|------|
| 2002 | 0   | 0    | 0    | 0   | 0    | 0    | 0    | 0    | 0    | 0   | 0    | 0    |
| 2003 | 0   | 0    | 0    | 0   | 0    | 0    | 0    | 0    | 0    | 0   | 0    | 0    |
| 2004 | 0   | 0    | 0    | 0   | 0    | 0    | 0    | 0    | 0    | 0   | 0    | 0    |
| 2005 | 0   | 0    | 0    | 0   | 0    | 0    | 0    | 0    | 0    | 0   | 0    | 0    |
| 2006 | 0   | 0    | 0    | 0   | 0    | 0    | 0    | 0    | 0    | 0   | 0    | 0    |
| 2007 | 0   | 0    | 0    | 0   | 0    | 0    | 0    | 0    | 0    | 0   | 0    | 0    |
| 2008 | 0   | 0    | 0    | 0   | 0    | 0    | 0    | 0    | 0    | 0   | 0    | 0    |
| 2009 | 0   | 0    | 0    | 0   | 0    | 0    | 0    | 0    | 0    | 0   | 0    | 0    |
| 2010 | 0   | 0    | 0    | 0   | 0    | 0    | 0    | 0    | 0    | 0   | 0    | 0    |
| 2011 | 0   | 0    | 0    | 0   | 0    | 0    | 0    | 0    | 0    | 0   | 0    | 0    |
| 2012 | 0   | 105  | 0    | 0   | 0    | 0    | 0    | 0    | 0    | 0   | 105  | 0    |
| 2013 | 0   | 234  | 0    | 0   | 0    | 0    | 0    | 0    | 0    | 0   | 234  | 0    |
| 2014 | 0   | 352  | 0    | 0   | 0    | 0    | 0    | 0    | 0    | 0   | 352  | 0    |
| 2015 | 0   | 501  | 0    | 0   | 0    | 0    | 0    | 0    | 0    | 0   | 501  | 0    |
| 2016 | 0   | 644  | 143  | 143 | 143  | 143  | 143  | 143  | 143  | 0   | 644  | 143  |
| 2017 | 0   | 796  | 295  | 295 | 295  | 295  | 295  | 295  | 295  | 0   | 796  | 295  |
| 2018 | 0   | 963  | 462  | 462 | 462  | 462  | 462  | 462  | 462  | 0   | 963  | 462  |
| 2019 | 0   | 1136 | 635  | 635 | 635  | 635  | 635  | 635  | 635  | 0   | 1136 | 635  |
| 2020 | 173 | 1309 | 808  | 635 | 808  | 808  | 808  | 808  | 808  | 173 | 1309 | 808  |
| 2021 | 359 | 1495 | 994  | 514 | 994  | 994  | 994  | 994  | 994  | 359 | 1495 | 994  |
| 2022 | 525 | 1661 | 1160 | 434 | 1160 | 1160 | 1160 | 1160 | 1160 | 525 | 1661 | 1160 |
| 2023 | 715 | 1851 | 1350 | 385 | 1350 | 1350 | 1350 | 1350 | 1350 | 715 | 1851 | 1350 |
| 2024 | 914 | 2050 | 1549 | 373 | 1549 | 1549 | 1549 | 1549 | 1549 | 914 | 2050 | 1549 |
| 2025 | 914 | 2050 | 1741 | 371 | 1549 | 1549 | 1549 | 1549 | 1549 | 914 | 2050 | 1741 |
| 2026 | 740 | 1861 | 1924 | 368 | 1360 | 1360 | 1360 | 1360 | 1360 | 853 | 1953 | 1924 |
| 2027 | 623 | 1695 | 2117 | 368 | 1197 | 1207 | 1207 | 1207 | 1207 | 807 | 1847 | 2117 |
| 2028 | 557 | 1552 | 2311 | 361 | 1063 | 1073 | 1073 | 1073 | 1073 | 768 | 1756 | 2311 |
| 2029 | 535 | 1431 | 2483 | 357 | 987  | 998  | 999  | 999  | 999  | 722 | 1645 | 2483 |
| 2030 | 499 | 1339 | 2483 | 348 | 934  | 943  | 943  | 943  | 943  | 682 | 1548 | 2483 |
| 2031 | 489 | 1294 | 2276 | 338 | 904  | 913  | 913  | 913  | 913  | 656 | 1484 | 2390 |
| 2032 | 485 | 1250 | 2062 | 328 | 879  | 878  | 880  | 880  | 880  | 618 | 1393 | 2276 |
| 2033 | 477 | 1202 | 1889 | 328 | 841  | 851  | 855  | 855  | 855  | 577 | 1300 | 2170 |
| 2034 | 467 | 1158 | 1738 | 313 | 826  | 836  | 836  | 836  | 836  | 554 | 1237 | 2079 |
| 2035 | 460 | 1138 | 1643 | 303 | 814  | 824  | 824  | 824  | 824  | 541 | 1204 | 1966 |
| 2036 | 455 | 1104 | 1563 | 298 | 806  | 815  | 815  | 815  | 815  | 523 | 1168 | 1859 |
| 2037 | 445 | 1094 | 1502 | 298 | 796  | 805  | 805  | 805  | 805  | 512 | 1140 | 1756 |
| 2038 | 444 | 1078 | 1426 | 298 | 783  | 792  | 792  | 792  | 792  | 489 | 1102 | 1659 |
| 2039 | 444 | 1060 | 1394 | 296 | 772  | 776  | 782  | 782  | 782  | 467 | 1064 | 1579 |
| 2040 | 434 | 1040 | 1354 | 296 | 760  | 746  | 770  | 770  | 770  | 456 | 1030 | 1516 |
| 2041 | 422 | 1010 | 1286 | 266 | 750  | 724  | 753  | 753  | 753  | 440 | 991  | 1465 |
| 2042 | 404 | 984  | 1256 | 232 | 717  | 704  | 731  | 731  | 731  | 434 | 980  | 1445 |
| 2043 | 404 | 984  | 1216 | 203 | 706  | 690  | 731  | 731  | 731  | 409 | 941  | 1416 |
| 2044 | 401 | 964  | 1197 | 172 | 696  | 688  | 721  | 721  | 721  | 374 | 883  | 1396 |
| 2045 | 391 | 946  | 1193 | 25  | 696  | 637  | 710  | 710  | 710  | 355 | 842  | 1341 |
| 2046 | 375 | 925  | 1183 | 0   | 688  | 607  | 683  | 683  | 683  | 252 | 625  | 1291 |
| 2047 | 168 | 675  | 1173 | 0   | 453  | 371  | 451  | 451  | 451  | 180 | 462  | 1239 |
| 2048 | 53  | 449  | 1152 | 0   | 247  | 181  | 249  | 249  | 249  | 112 | 300  | 1189 |
| 2049 | 0   | 246  | 916  | 0   | 100  | 75   | 103  | 103  | 103  | 71  | 194  | 1002 |
| 2050 | 0   | 128  | 699  | 0   | 31   | 24   | 33   | 33   | 33   | 44  | 121  | 824  |
| 2051 | 0   | 65   | 466  | 0   | 3    | 2    | 3    | 3    | 3    | 19  | 58   | 657  |
| 2052 | 0   | 25   | 277  | 0   | 0    | 0    | 0    | 0    | 0    | 7   | 20   | 529  |
| 2053 | 0   | 8    | 147  | 0   | 0    | 0    | 0    | 0    | 0    | 4   | 11   | 400  |
| 2054 | 0   | 0    | 64   | 0   | 0    | 0    | 0    | 0    | 0    | 3   | 8    | 286  |
| 2055 | 0   | 0    | 14   | 0   | 0    | 0    | 0    | 0    | 0    | 0   | 1    | 195  |
| 2056 | 0   | 0    | 1    | 0   | 0    | 0    | 0    | 0    | 0    | 0   | 1    | 119  |
| 2057 | 0   | 0    | 0    | 0   | 0    | 0    | 0    | 0    | 0    | 0   | 1    | 67   |
| 2058 | 0   | 0    | 0    | 0   | 0    | 0    | 0    | 0    | 0    | 0   | 1    | 32   |
| 2059 | 0   | 0    | 0    | 0   | 0    | 0    | 0    | 0    | 0    | 0   | 1    | 9    |
| 2060 | 0   | 0    | 0    | 0   | 0    | 0    | 0    | 0    | 0    | 0   | 1    | 4    |
| 2061 | 0   | 0    | 0    | 0   | 0    | 0    | 0    | 0    | 0    | 0   | 1    | 1    |
| 2062 | 0   | 0    | 0    | 0   | 0    | 0    | 0    | 0    | 0    | 0   | 1    | 1    |
| 2063 | 0   | 0    | 0    | 0   | 0    | 0    | 0    | 0    | 0    | 0   | 1    | 1    |
| 2064 | 0   | 0    | 0    | 0   | 0    | 0    | 0    | 0    | 0    | 0   | 1    | 1    |
| 2065 | 0   | 0    | 0    | 0   | 0    | 0    | 0    | 0    | 0    | 0   | 1    | 1    |
| 2066 | 0   | 0    | 0    | 0   | 0    | 0    | 0    | 0    | 0    | 0   | 1    | 1    |
| 2067 | 0   | 0    | 0    | 0   | 0    | 0    | 0    | 0    | 0    | 0   | 1    | 1    |
| 2068 | 0   | 0    | 0    | 0   | 0    | 0    | 0    | 0    | 0    | 0   | 1    | 1    |

|      | 73 | 74 | 75 | 76 | 77 | 78 | 79 | 80 | 81 | 82 | 83 | 84 |
|------|----|----|----|----|----|----|----|----|----|----|----|----|
| 2069 | 0  | 0  | 0  | 0  | 0  | 0  | 0  | 0  | 0  | 0  | 1  | 1  |
| 2070 | 0  | 0  | 0  | 0  | 0  | 0  | 0  | 0  | 0  | 0  | 1  | 1  |
| 2071 | 0  | 0  | 0  | 0  | 0  | 0  | 0  | 0  | 0  | 0  | 1  | 1  |
| 2072 | 0  | 0  | 0  | 0  | 0  | 0  | 0  | 0  | 0  | 0  | 1  | 1  |
| 2073 | 0  | 0  | 0  | 0  | 0  | 0  | 0  | 0  | 0  | 0  | 1  | 1  |
| 2074 | 0  | 0  | 0  | 0  | 0  | 0  | 0  | 0  | 0  | 0  | 1  | 1  |
| 2075 | 0  | 0  | 0  | 0  | 0  | 0  | 0  | 0  | 0  | 0  | 1  | 1  |
| 2076 | 0  | 0  | 0  | 0  | 0  | 0  | 0  | 0  | 0  | 0  | 1  | 1  |
| 2077 | 0  | 0  | 0  | 0  | 0  | 0  | 0  | 0  | 0  | 0  | 1  | 1  |
| 2078 | 0  | 0  | 0  | 0  | 0  | 0  | 0  | 0  | 0  | 0  | 1  | 1  |
| 2079 | 0  | 0  | 0  | 0  | 0  | 0  | 0  | 0  | 0  | 0  | 1  | 1  |
| 2080 | 0  | 0  | 0  | 0  | 0  | 0  | 0  | 0  | 0  | 0  | 1  | 1  |
| 2081 | 0  | 0  | 0  | 0  | 0  | 0  | 0  | 0  | 0  | 0  | 1  | 1  |
| 2082 | 0  | 0  | 0  | 0  | 0  | 0  | 0  | 0  | 0  | 0  | 1  | 1  |
| 2083 | 0  | 0  | 0  | 0  | 0  | 0  | 0  | 0  | 0  | 0  | 1  | 1  |
| 2084 | 0  | 0  | 0  | 0  | 0  | 0  | 0  | 0  | 0  | 0  | 1  | 1  |
| 2085 | 0  | 0  | 0  | 0  | 0  | 0  | 0  | 0  | 0  | 0  | 1  | 1  |
| 2086 | 0  | 0  | 0  | 0  | 0  | 0  | 0  | 0  | 0  | 0  | 1  | 1  |
| 2087 | 0  | 0  | 0  | 0  | 0  | 0  | 0  | 0  | 0  | 0  | 1  | 1  |
| 2088 | 0  | 0  | 0  | 0  | 0  | 0  | 0  | 0  | 0  | 0  | 1  | 1  |
| 2089 | 0  | 0  | 0  | 0  | 0  | 0  | 0  | 0  | 0  | 0  | 1  | 1  |
| 2090 | 0  | 0  | 0  | 0  | 0  | 0  | 0  | 0  | 0  | 0  | 1  | 1  |
|      |    |    |    |    |    |    |    |    |    |    |    |    |



|      | 85  | 86   | 87   | 88   | 89   | 90   | 91  | 92   | 93   | 94  | 95   | 96   |
|------|-----|------|------|------|------|------|-----|------|------|-----|------|------|
| 2002 | 0   | 0    | 0    | 0    | 0    | 0    | 0   | 0    | 0    | 0   | 0    | 0    |
| 2003 | 0   | 0    | 0    | 0    | 0    | 0    | 0   | 0    | 0    | 0   | 0    | 0    |
| 2004 | 0   | 0    | 0    | 0    | 0    | 0    | 0   | 0    | 0    | 0   | 0    | 0    |
| 2005 | 0   | 0    | 0    | 0    | 0    | 0    | 0   | 0    | 0    | 0   | 0    | 0    |
| 2006 | 0   | 0    | 0    | 0    | 0    | 0    | 0   | 0    | 0    | 0   | 0    | 0    |
| 2007 | 0   | 0    | 0    | 0    | 0    | 0    | 0   | 0    | 0    | 0   | 0    | 0    |
| 2008 | 0   | 0    | 0    | 0    | 0    | 0    | 0   | 0    | 0    | 0   | 0    | 0    |
| 2009 | 0   | 0    | 0    | 0    | 0    | 0    | 0   | 0    | 0    | 0   | 0    | 0    |
| 2010 | 0   | 0    | 0    | 0    | 0    | 0    | 0   | 0    | 0    | 0   | 0    | 0    |
| 2011 | 0   | 0    | 0    | 0    | 0    | 0    | 0   | 0    | 0    | 0   | 0    | 0    |
| 2012 | 0   | 0    | 0    | 0    | 0    | 0    | 0   | 105  | 0    | 0   | 0    | 0    |
| 2013 | 0   | 0    | 0    | 0    | 0    | 0    | 0   | 234  | 0    | 0   | 0    | 0    |
| 2014 | 0   | 0    | 0    | 0    | 0    | 0    | 0   | 352  | 0    | 0   | 0    | 0    |
| 2015 | 0   | 0    | 0    | 0    | 0    | 0    | 0   | 501  | 0    | 0   | 0    | 0    |
| 2016 | 143 | 143  | 143  | 143  | 143  | 143  | 0   | 644  | 143  | 143 | 143  | 143  |
| 2017 | 295 | 295  | 295  | 295  | 295  | 295  | 0   | 796  | 295  | 295 | 295  | 295  |
| 2018 | 462 | 462  | 462  | 462  | 462  | 462  | 0   | 963  | 462  | 462 | 462  | 462  |
| 2019 | 635 | 635  | 635  | 635  | 635  | 635  | 0   | 1136 | 635  | 635 | 635  | 635  |
| 2020 | 635 | 808  | 808  | 808  | 808  | 808  | 173 | 1309 | 808  | 635 | 808  | 808  |
| 2021 | 572 | 994  | 994  | 994  | 994  | 994  | 359 | 1495 | 994  | 570 | 994  | 994  |
| 2022 | 515 | 1160 | 1160 | 1160 | 1160 | 1160 | 525 | 1661 | 1160 | 506 | 1160 | 1160 |
| 2023 | 483 | 1350 | 1350 | 1350 | 1350 | 1350 | 715 | 1851 | 1350 | 446 | 1350 | 1350 |
| 2024 | 451 | 1549 | 1549 | 1549 | 1549 | 1549 | 914 | 2050 | 1549 | 424 | 1549 | 1549 |
| 2025 | 430 | 1549 | 1549 | 1549 | 1549 | 1549 | 914 | 2050 | 1741 | 415 | 1549 | 1549 |
| 2026 | 409 | 1463 | 1463 | 1463 | 1463 | 1463 | 823 | 1878 | 1924 | 403 | 1407 | 1407 |
| 2027 | 391 | 1376 | 1376 | 1376 | 1376 | 1376 | 748 | 1736 | 2117 | 387 | 1296 | 1296 |
| 2028 | 362 | 1307 | 1307 | 1307 | 1307 | 1307 | 683 | 1609 | 2311 | 378 | 1192 | 1192 |
| 2029 | 344 | 1221 | 1221 | 1221 | 1221 | 1221 | 629 | 1491 | 2483 | 369 | 1102 | 1099 |
| 2030 | 318 | 1150 | 1150 | 1150 | 1150 | 1150 | 589 | 1400 | 2483 | 361 | 1041 | 1038 |
| 2031 | 303 | 1101 | 1101 | 1101 | 1101 | 1101 | 566 | 1339 | 2310 | 355 | 999  | 996  |
| 2032 | 294 | 1040 | 1040 | 1040 | 1040 | 1040 | 545 | 1289 | 2137 | 339 | 964  | 961  |
| 2033 | 281 | 974  | 974  | 974  | 974  | 974  | 526 | 1241 | 2011 | 330 | 933  | 925  |
| 2034 | 261 | 929  | 929  | 929  | 929  | 929  | 510 | 1201 | 1889 | 310 | 908  | 894  |
| 2035 | 255 | 907  | 907  | 907  | 907  | 907  | 499 | 1175 | 1775 | 305 | 887  | 872  |
| 2036 | 233 | 875  | 865  | 875  | 875  | 875  | 483 | 1141 | 1686 | 299 | 852  | 844  |
| 2037 | 228 | 856  | 849  | 856  | 856  | 856  | 475 | 1120 | 1604 | 298 | 840  | 827  |
| 2038 | 227 | 821  | 810  | 821  | 821  | 821  | 464 | 1093 | 1524 | 298 | 819  | 810  |
| 2039 | 209 | 795  | 785  | 791  | 791  | 791  | 453 | 1068 | 1476 | 298 | 801  | 785  |
| 2040 | 193 | 777  | 760  | 767  | 767  | 767  | 446 | 1051 | 1436 | 298 | 787  | 758  |
| 2041 | 193 | 750  | 744  | 738  | 738  | 738  | 436 | 1026 | 1370 | 298 | 771  | 729  |
| 2042 | 180 | 733  | 708  | 727  | 727  | 727  | 423 | 992  | 1323 | 285 | 753  | 712  |
| 2043 | 174 | 710  | 673  | 690  | 690  | 690  | 415 | 972  | 1277 | 285 | 737  | 698  |
| 2044 | 99  | 656  | 640  | 644  | 644  | 644  | 408 | 956  | 1234 | 285 | 731  | 691  |
| 2045 | 64  | 626  | 619  | 612  | 612  | 612  | 404 | 944  | 1214 | 285 | 729  | 681  |
| 2046 | 32  | 458  | 450  | 443  | 443  | 443  | 401 | 936  | 1202 | 275 | 729  | 666  |
| 2047 | 7   | 338  | 326  | 323  | 323  | 323  | 401 | 936  | 1194 | 270 | 729  | 643  |
| 2048 | 5   | 220  | 213  | 206  | 206  | 206  | 401 | 936  | 1187 | 146 | 724  | 464  |
| 2049 | 1   | 142  | 135  | 132  | 132  | 132  | 295 | 706  | 1178 | 68  | 543  | 308  |
| 2050 | 1   | 91   | 85   | 84   | 84   | 84   | 207 | 500  | 988  | 34  | 381  | 181  |
| 2051 | 1   | 49   | 42   | 40   | 40   | 40   | 123 | 306  | 811  | 19  | 234  | 109  |
| 2052 | 1   | 19   | 15   | 14   | 14   | 14   | 66  | 173  | 628  | 11  | 128  | 67   |
| 2053 | 1   | 8    | 7    | 8    | 8    | 8    | 38  | 99   | 460  | 3   | 72   | 42   |
| 2054 | 1   | 5    | 5    | 6    | 6    | 6    | 22  | 60   | 309  | 3   | 42   | 22   |
| 2055 | 1   | 2    | 0    | 1    | 1    | 1    | 11  | 30   | 186  | 3   | 22   | 11   |
| 2056 | 1   | 2    | 0    | 1    | 1    | 1    | 5   | 15   | 105  | 3   | 11   | 5    |
| 2057 | 1   | 2    | 0    | 1    | 1    | 1    | 2   | 7    | 61   | 3   | 5    | 1    |
| 2058 | 1   | 2    | 0    | 1    | 1    | 1    | 0   | 1    | 34   | 3   | 1    | 1    |
| 2059 | 1   | 2    | 0    | 1    | 1    | 1    | 0   | 1    | 21   | 3   | 1    | 1    |
| 2060 | 1   | 2    | 0    | 1    | 1    | 1    | 0   | 1    | 11   | 3   | 1    | 1    |
| 2061 | 1   | 2    | 0    | 1    | 1    | 1    | 0   | 1    | 5    | 3   | 1    | 1    |
| 2062 | 1   | 2    | 0    | 1    | 1    | 1    | 0   | 1    | 1    | 3   | 1    | 1    |
| 2063 | 1   | 2    | 0    | 1    | 1    | 1    | 0   | 1    | 1    | 3   | 1    | 1    |
| 2064 | 1   | 2    | 0    | 1    | 1    | 1    | 0   | 1    | 1    | 3   | 1    | 1    |
| 2065 | 1   | 2    | 0    | 1    | 1    | 1    | 0   | 1    | 1    | 3   | 1    | 1    |
| 2066 | 1   | 2    | 0    | 1    | 1    | 1    | 0   | 1    | 1    | 3   | 1    | 1    |
| 2067 | 1   | 2    | 0    | 1    | 1    | 1    | 0   | 1    | 1    | 3   | 1    | 1    |
| 2068 | 1   | 2    | 0    | 1    | 1    | 1    | 0   | 1    | 1    | 3   | 1    | 1    |

|      | 85 | 86 | 87 | 88 | 89 | 90 | 91 | 92 | 93 | 94 | 95 | 96 |
|------|----|----|----|----|----|----|----|----|----|----|----|----|
| 2069 | 1  | 2  | 0  | 1  | 1  | 1  | 0  | 1  | 1  | 3  | 1  | 1  |
| 2070 | 1  | 2  | 0  | 1  | 1  | 1  | 0  | 1  | 1  | 3  | 1  | 1  |
| 2071 | 1  | 2  | 0  | 1  | 1  | 1  | 0  | 1  | 1  | 3  | 1  | 1  |
| 2072 | 1  | 2  | 0  | 1  | 1  | 1  | 0  | 1  | 1  | 3  | 1  | 1  |
| 2073 | 1  | 2  | 0  | 1  | 1  | 1  | 0  | 1  | 1  | 3  | 1  | 1  |
| 2074 | 1  | 2  | 0  | 1  | 1  | 1  | 0  | 1  | 1  | 3  | 1  | 1  |
| 2075 | 1  | 2  | 0  | 1  | 1  | 1  | 0  | 1  | 1  | 3  | 1  | 1  |
| 2076 | 1  | 2  | 0  | 1  | 1  | 1  | 0  | 1  | 1  | 3  | 1  | 1  |
| 2077 | 1  | 2  | 0  | 1  | 1  | 1  | 0  | 1  | 1  | 3  | 1  | 1  |
| 2078 | 1  | 2  | 0  | 1  | 1  | 1  | 0  | 1  | 1  | 3  | 1  | 1  |
| 2079 | 1  | 2  | 0  | 1  | 1  | 1  | 0  | 1  | 1  | 3  | 1  | 1  |
| 2080 | 1  | 2  | 0  | 1  | 1  | 1  | 0  | 1  | 1  | 3  | 1  | 1  |
| 2081 | 1  | 2  | 0  | 1  | 1  | 1  | 0  | 1  | 1  | 3  | 1  | 1  |
| 2082 | 1  | 2  | 0  | 1  | 1  | 1  | 0  | 1  | 1  | 3  | 1  | 1  |
| 2083 | 1  | 2  | 0  | 1  | 1  | 1  | 0  | 1  | 1  | 3  | 1  | 1  |
| 2084 | 1  | 2  | 0  | 1  | 1  | 1  | 0  | 1  | 1  | 3  | 1  | 1  |
| 2085 | 1  | 2  | 0  | 1  | 1  | 1  | 0  | 1  | 1  | 3  | 1  | 1  |
| 2086 | 1  | 2  | 0  | 1  | 1  | 1  | 0  | 1  | 1  | 3  | 1  | 1  |
| 2087 | 1  | 2  | 0  | 1  | 1  | 1  | 0  | 1  | 1  | 3  | 1  | 1  |
| 2088 | 1  | 2  | 0  | 1  | 1  | 1  | 0  | 1  | 1  | 3  | 1  | 1  |
| 2089 | 1  | 2  | 0  | 1  | 1  | 1  | 0  | 1  | 1  | 3  | 1  | 1  |
| 2090 | 1  | 2  | 0  | 1  | 1  | 1  | 0  | 1  | 1  | 3  | 1  | 1  |
|      |    |    |    |    |    |    |    |    |    |    |    |    |

|      | 97   | 98   | 99   | 100 | 101  | 102  | 103 | 104  | 105  | 106  | 107  | 108  |
|------|------|------|------|-----|------|------|-----|------|------|------|------|------|
| 2002 | 0    | 0    | 0    | 0   | 0    | 0    | 0   | 0    | 0    | 0    | 0    | 0    |
| 2003 | 0    | 0    | 0    | 0   | 0    | 0    | 0   | 0    | 0    | 0    | 0    | 0    |
| 2004 | 0    | 0    | 0    | 0   | 0    | 0    | 0   | 0    | 0    | 0    | 0    | 0    |
| 2005 | 0    | 0    | 0    | 0   | 0    | 0    | 0   | 0    | 0    | 0    | 0    | 0    |
| 2006 | 0    | 0    | 0    | 0   | 0    | 0    | 0   | 0    | 0    | 0    | 0    | 0    |
| 2007 | 0    | 0    | 0    | 0   | 0    | 0    | 0   | 0    | 0    | 0    | 0    | 0    |
| 2008 | 0    | 0    | 0    | 0   | 0    | 0    | 0   | 0    | 0    | 0    | 0    | 0    |
| 2009 | 0    | 0    | 0    | 0   | 0    | 0    | 0   | 0    | 0    | 0    | 0    | 0    |
| 2010 | 0    | 0    | 0    | 0   | 0    | 0    | 0   | 0    | 0    | 0    | 0    | 0    |
| 2011 | 0    | 0    | 0    | 0   | 0    | 0    | 0   | 0    | 0    | 0    | 0    | 0    |
| 2012 | 0    | 0    | 0    | 0   | 105  | 0    | 0   | 0    | 0    | 0    | 0    | 0    |
| 2013 | 0    | 0    | 0    | 0   | 234  | 0    | 0   | 0    | 0    | 0    | 0    | 0    |
| 2014 | 0    | 0    | 0    | 0   | 352  | 0    | 0   | 0    | 0    | 0    | 0    | 0    |
| 2015 | 0    | 0    | 0    | 0   | 501  | 0    | 0   | 0    | 0    | 0    | 0    | 0    |
| 2016 | 143  | 143  | 143  | 0   | 644  | 143  | 143 | 143  | 143  | 143  | 143  | 143  |
| 2017 | 295  | 295  | 295  | 0   | 796  | 295  | 295 | 295  | 295  | 295  | 295  | 295  |
| 2018 | 462  | 462  | 462  | 0   | 963  | 462  | 462 | 462  | 462  | 462  | 462  | 462  |
| 2019 | 635  | 635  | 635  | 0   | 1136 | 635  | 635 | 635  | 635  | 635  | 635  | 635  |
| 2020 | 808  | 808  | 808  | 173 | 1309 | 808  | 635 | 808  | 808  | 808  | 808  | 808  |
| 2021 | 994  | 994  | 994  | 359 | 1495 | 994  | 570 | 994  | 994  | 994  | 994  | 994  |
| 2022 | 1160 | 1160 | 1160 | 525 | 1661 | 1160 | 506 | 1160 | 1160 | 1160 | 1160 | 1160 |
| 2023 | 1350 | 1350 | 1350 | 715 | 1851 | 1350 | 446 | 1350 | 1350 | 1350 | 1350 | 1350 |
| 2024 | 1549 | 1549 | 1549 | 914 | 2050 | 1549 | 424 | 1549 | 1549 | 1549 | 1549 | 1549 |
| 2025 | 1549 | 1549 | 1549 | 914 | 2050 | 1741 | 415 | 1549 | 1549 | 1549 | 1549 | 1549 |
| 2026 | 1407 | 1407 | 1407 | 823 | 1878 | 1924 | 403 | 1407 | 1407 | 1407 | 1407 | 1407 |
| 2027 | 1296 | 1296 | 1296 | 748 | 1736 | 2117 | 392 | 1290 | 1296 | 1296 | 1296 | 1296 |
| 2028 | 1192 | 1192 | 1192 | 683 | 1609 | 2311 | 385 | 1186 | 1192 | 1192 | 1192 | 1192 |
| 2029 | 1102 | 1102 | 1102 | 629 | 1491 | 2483 | 378 | 1091 | 1101 | 1102 | 1102 | 1102 |
| 2030 | 1039 | 1039 | 1039 | 589 | 1400 | 2483 | 363 | 1032 | 1038 | 1039 | 1039 | 1039 |
| 2031 | 997  | 997  | 997  | 566 | 1339 | 2310 | 357 | 990  | 996  | 997  | 997  | 997  |
| 2032 | 959  | 959  | 959  | 546 | 1290 | 2137 | 346 | 960  | 959  | 960  | 960  | 960  |
| 2033 | 927  | 927  | 927  | 527 | 1244 | 2011 | 342 | 928  | 923  | 928  | 928  | 928  |
| 2034 | 897  | 897  | 897  | 512 | 1207 | 1889 | 333 | 902  | 892  | 901  | 901  | 901  |
| 2035 | 876  | 876  | 876  | 501 | 1182 | 1775 | 325 | 880  | 872  | 881  | 881  | 881  |
| 2036 | 850  | 850  | 850  | 483 | 1142 | 1686 | 310 | 851  | 846  | 851  | 851  | 851  |
| 2037 | 835  | 835  | 835  | 477 | 1128 | 1604 | 302 | 836  | 832  | 841  | 841  | 841  |
| 2038 | 816  | 816  | 816  | 465 | 1097 | 1524 | 299 | 815  | 814  | 819  | 819  | 819  |
| 2039 | 799  | 799  | 799  | 454 | 1071 | 1476 | 298 | 799  | 799  | 801  | 801  | 801  |
| 2040 | 787  | 787  | 787  | 446 | 1051 | 1436 | 298 | 785  | 777  | 787  | 787  | 787  |
| 2041 | 769  | 769  | 769  | 438 | 1032 | 1370 | 289 | 769  | 756  | 773  | 773  | 773  |
| 2042 | 746  | 746  | 746  | 425 | 997  | 1327 | 270 | 740  | 733  | 750  | 750  | 750  |
| 2043 | 731  | 731  | 731  | 422 | 989  | 1283 | 254 | 722  | 719  | 744  | 744  | 744  |
| 2044 | 720  | 720  | 720  | 418 | 980  | 1246 | 233 | 712  | 699  | 737  | 737  | 737  |
| 2045 | 712  | 712  | 712  | 408 | 962  | 1223 | 130 | 710  | 661  | 721  | 721  | 721  |
| 2046 | 707  | 707  | 707  | 394 | 929  | 1205 | 62  | 699  | 638  | 696  | 696  | 696  |
| 2047 | 707  | 707  | 707  | 294 | 711  | 1192 | 30  | 524  | 467  | 526  | 526  | 526  |
| 2048 | 707  | 707  | 707  | 209 | 505  | 1184 | 16  | 370  | 310  | 371  | 371  | 371  |
| 2049 | 525  | 525  | 525  | 123 | 306  | 1160 | 7   | 223  | 176  | 219  | 219  | 219  |
| 2050 | 367  | 367  | 367  | 68  | 176  | 966  | 3   | 126  | 99   | 125  | 125  | 125  |
| 2051 | 220  | 220  | 220  | 38  | 100  | 795  | 0   | 71   | 67   | 71   | 71   | 71   |
| 2052 | 124  | 124  | 124  | 22  | 60   | 619  | 0   | 42   | 42   | 42   | 42   | 42   |
| 2053 | 70   | 70   | 70   | 11  | 30   | 443  | 0   | 22   | 22   | 22   | 22   | 22   |
| 2054 | 42   | 42   | 42   | 5   | 15   | 287  | 0   | 11   | 11   | 11   | 11   | 11   |
| 2055 | 22   | 22   | 22   | 2   | 7    | 174  | 0   | 5    | 5    | 5    | 5    | 5    |
| 2056 | 11   | 11   | 11   | 0   | 1    | 102  | 0   | 5    | 1    | 1    | 1    | 1    |
| 2057 | 5    | 5    | 5    | 0   | 1    | 64   | 0   | 5    | 1    | 1    | 1    | 1    |
| 2058 | 1    | 1    | 1    | 0   | 1    | 34   | 0   | 5    | 1    | 1    | 1    | 1    |
| 2059 | 1    | 1    | 1    | 0   | 1    | 21   | 0   | 5    | 1    | 1    | 1    | 1    |
| 2060 | 1    | 1    | 1    | 0   | 1    | 11   | 0   | 5    | 1    | 1    | 1    | 1    |
| 2061 | 1    | 1    | 1    | 0   | 1    | 5    | 0   | 5    | 1    | 1    | 1    | 1    |
| 2062 | 1    | 1    | 1    | 0   | 1    | 1    | 0   | 5    | 1    | 1    | 1    | 1    |
| 2063 | 1    | 1    | 1    | 0   | 1    | 1    | 0   | 5    | 1    | 1    | 1    | 1    |
| 2064 | 1    | 1    | 1    | 0   | 1    | 1    | 0   | 5    | 1    | 1    | 1    | 1    |
| 2065 | 1    | 1    | 1    | 0   | 1    | 1    | 0   | 5    | 1    | 1    | 1    | 1    |
| 2066 | 1    | 1    | 1    | 0   | 1    | 1    | 0   | 5    | 1    | 1    | 1    | 1    |
| 2067 | 1    | 1    | 1    | 0   | 1    | 1    | 0   | 5    | 1    | 1    | 1    | 1    |
| 2068 | 1    | 1    | 1    | 0   | 1    | 1    | 0   | 5    | 1    | 1    | 1    | 1    |

|      | 97 | 98 | 99 | 100 | 101 | 102 | 103 | 104 | 105 | 106 | 107 | 108 |
|------|----|----|----|-----|-----|-----|-----|-----|-----|-----|-----|-----|
| 2069 | 1  | 1  | 1  | 0   | 1   | 1   | 0   | 5   | 1   | 1   | 1   | 1   |
| 2070 | 1  | 1  | 1  | 0   | 1   | 1   | 0   | 5   | 1   | 1   | 1   | 1   |
| 2071 | 1  | 1  | 1  | 0   | 1   | 1   | 0   | 5   | 1   | 1   | 1   | 1   |
| 2072 | 1  | 1  | 1  | 0   | 1   | 1   | 0   | 5   | 1   | 1   | 1   | 1   |
| 2073 | 1  | 1  | 1  | 0   | 1   | 1   | 0   | 5   | 1   | 1   | 1   | 1   |
| 2074 | 1  | 1  | 1  | 0   | 1   | 1   | 0   | 5   | 1   | 1   | 1   | 1   |
| 2075 | 1  | 1  | 1  | 0   | 1   | 1   | 0   | 5   | 1   | 1   | 1   | 1   |
| 2076 | 1  | 1  | 1  | 0   | 1   | 1   | 0   | 5   | 1   | 1   | 1   | 1   |
| 2077 | 1  | 1  | 1  | 0   | 1   | 1   | 0   | 5   | 1   | 1   | 1   | 1   |
| 2078 | 1  | 1  | 1  | 0   | 1   | 1   | 0   | 5   | 1   | 1   | 1   | 1   |
| 2079 | 1  | 1  | 1  | 0   | 1   | 1   | 0   | 5   | 1   | 1   | 1   | 1   |
| 2080 | 1  | 1  | 1  | 0   | 1   | 1   | 0   | 5   | 1   | 1   | 1   | 1   |
| 2081 | 1  | 1  | 1  | 0   | 1   | 1   | 0   | 5   | 1   | 1   | 1   | 1   |
| 2082 | 1  | 1  | 1  | 0   | 1   | 1   | 0   | 5   | 1   | 1   | 1   | 1   |
| 2083 | 1  | 1  | 1  | 0   | 1   | 1   | 0   | 5   | 1   | 1   | 1   | 1   |
| 2084 | 1  | 1  | 1  | 0   | 1   | 1   | 0   | 5   | 1   | 1   | 1   | 1   |
| 2085 | 1  | 1  | 1  | 0   | 1   | 1   | 0   | 5   | 1   | 1   | 1   | 1   |
| 2086 | 1  | 1  | 1  | 0   | 1   | 1   | 0   | 5   | 1   | 1   | 1   | 1   |
| 2087 | 1  | 1  | 1  | 0   | 1   | 1   | 0   | 5   | 1   | 1   | 1   | 1   |
| 2088 | 1  | 1  | 1  | 0   | 1   | 1   | 0   | 5   | 1   | 1   | 1   | 1   |
| 2089 | 1  | 1  | 1  | 0   | 1   | 1   | 0   | 5   | 1   | 1   | 1   | 1   |
| 2090 | 1  | 1  | 1  | 0   | 1   | 1   | 0   | 5   | 1   | 1   | 1   | 1   |

|      | 109 | 110  | 111    | 112       | 113  | 114   | 115   | 116   | 117   | 118 | 119  | 120  |
|------|-----|------|--------|-----------|------|-------|-------|-------|-------|-----|------|------|
| 2002 | 0   | 0    | 0      | 0         | 0    | 0     | 0     | 0     | 0     | 0   | 0    | 0    |
| 2003 | 0   | 0    | 0      | 0         | 0    | 0     | 0     | 0     | 0     | 0   | 0    | 0    |
| 2004 | 0   | 0    | 0      | 0         | 0    | 0     | 0     | 0     | 0     | 0   | 0    | 0    |
| 2005 | 0   | 0    | 0      | 0         | 0    | 0     | 0     | 0     | 0     | 0   | 0    | 0    |
| 2006 | 0   | 0    | 0      | 0         | 0    | 0     | 0     | 0     | 0     | 0   | 0    | 0    |
| 2007 | 0   | 0    | 0      | 0         | 0    | 0     | 0     | 0     | 0     | 0   | 0    | 0    |
| 2008 | 0   | 0    | 0      | 0         | 0    | 0     | 0     | 0     | 0     | 0   | 0    | 0    |
| 2009 | 0   | 0    | 0      | 0         | 0    | 0     | 0     | 0     | 0     | 0   | 0    | 0    |
| 2010 | 0   | 0    | 0      | 0         | 0    | 0     | 0     | 0     | 0     | 0   | 0    | 0    |
| 2011 | 0   | 0    | 0      | 0         | 0    | 0     | 0     | 0     | 0     | 0   | 0    | 0    |
| 2012 | 0   | 105  | 0      | 0         | 0    | 0     | 0     | 0     | 0     | 0   | 105  | 0    |
| 2013 | 0   | 234  | 0      | 0         | 0    | 0     | 0     | 0     | 0     | 0   | 234  | 0    |
| 2014 | 0   | 352  | 0      | 0         | 0    | 0     | 0     | 0     | 0     | 0   | 352  | 0    |
| 2015 | 0   | 501  | 0      | 0         | 0    | 0     | 0     | 0     | 0     | 0   | 501  | 0    |
| 2016 | 0   | 644  | 143    | 143       | 143  | 143   | 143   | 143   | 143   | 0   | 644  | 143  |
| 2017 | 0   | 796  | 295    | 295       | 295  | 295   | 295   | 295   | 295   | 0   | 796  | 295  |
| 2018 | 0   | 963  | 462    | 462       | 462  | 462   | 462   | 462   | 462   | 0   | 963  | 462  |
| 2019 | 0   | 1136 | 635    | 635       | 635  | 635   | 635   | 635   | 635   | 0   | 1136 | 635  |
| 2020 | 173 | 1309 | 808    | 635       | 808  | 808   | 808   | 808   | 808   | 173 | 1309 | 808  |
| 2021 | 359 | 1495 | 994    | 635       | 994  | 994   | 994   | 994   | 994   | 359 | 1495 | 994  |
| 2022 | 525 | 1661 | 1160   | 635       | 1160 | 1160  | 1160  | 1160  | 1160  | 525 | 1661 | 1160 |
| 2023 | 715 | 1851 | 1350   | 635       | 1350 | 1350  | 1350  | 1350  | 1350  | 715 | 1851 | 1350 |
| 2024 | 914 | 2050 | 1549   | 635       | 1549 | 1549  | 1549  | 1549  | 1549  | 914 | 2050 | 1549 |
| 2025 | 914 | 2050 | 1741   | 635       | 1549 | 1549  | 1549  | 1549  | 1549  | 914 | 2050 | 1741 |
| 2026 | 914 | 2050 | 1924   | 635       | 1549 | 1549  | 1549  | 1549  | 1549  | 914 | 2050 | 1924 |
| 2027 | 914 | 2050 | 2117   | 635       | 1549 | 1549  | 1549  | 1549  | 1549  | 914 | 2040 | 2117 |
| 2028 | 914 | 2050 | 2311   | 635       | 1549 | 1549  | 1549  | 1549  | 1549  | 914 | 2040 | 2311 |
| 2029 | 914 | 2050 | 2483   | 625       | 1549 | 1549  | 1549  | 1549  | 1549  | 905 | 2030 | 2483 |
| 2030 | 914 | 2050 | 2483   | 625       | 1549 | 1549  | 1549  | 1549  | 1549  | 900 | 2017 | 2483 |
| 2031 | 914 | 2050 | 2483   | 625       | 1549 | 1549  | 1549  | 1549  | 1549  | 896 | 1996 | 2483 |
| 2032 | 914 | 2050 | 2483   | 625       | 1549 | 1534  | 1549  | 1549  | 1549  | 889 | 1962 | 2483 |
| 2033 | 914 | 2035 | 2483   | 619       | 1549 | 1521  | 1540  | 1540  | 1540  | 877 | 1926 | 2483 |
| 2034 | 910 | 2031 | 2483   | 618       | 1549 | 1507  | 1536  | 1536  | 1536  | 869 | 1903 | 2483 |
| 2035 | 906 | 2027 | 2483   | 617       | 1549 | 1497  | 1532  | 1532  | 1532  | 861 | 1876 | 2473 |
| 2036 | 906 | 2020 | 2483   | 617       | 1549 | 1487  | 1532  | 1532  | 1532  | 851 | 1836 | 2467 |
| 2037 | 901 | 1991 | 2483   | 617       | 1545 | 1487  | 1515  | 1515  | 1515  | 838 | 1798 | 2457 |
| 2038 | 893 | 1978 | 2480   | 609       | 1537 | 1483  | 1507  | 1507  | 1507  | 834 | 1783 | 2429 |
| 2039 | 876 | 1934 | 2477   | 603       | 1527 | 1483  | 1492  | 1492  | 1492  | 814 | 1751 | 2391 |
| 2040 | 869 | 1900 | 2471   | 603       | 1498 | 1471  | 1472  | 1472  | 1472  | 804 | 1722 | 2354 |
| 2041 | 864 | 1879 | 2442   | 587       | 1493 | 1471  | 1459  | 1459  | 1459  | 800 | 1695 | 2330 |
| 2042 | 859 | 1844 | 2412   | 532       | 1491 | 1461  | 1443  | 1443  | 1443  | 800 | 1651 | 2281 |
| 2043 | 850 | 1824 | 2388   | 459       | 1491 | 1450  | 1443  | 1443  | 1443  | 776 | 1589 | 2255 |
| 2044 | 846 | 1708 | 2388   | 384       | 1446 | 1400  | 1357  | 1357  | 1357  | 751 | 1540 | 2218 |
| 2045 | 789 | 1531 | 2378   | 310       | 1318 | 1259  | 1237  | 1237  | 1237  | 747 | 1482 | 2186 |
| 2046 | 716 | 1374 | 2289   | 263       | 1159 | 1093  | 1113  | 1113  | 1113  | 743 | 1442 | 2169 |
| 2047 | 624 | 1208 | 2171   | 142.33333 | 1017 | 962   | 981   | 981   | 981   | 730 | 1432 | 2154 |
| 2048 | 539 | 1025 | 2034   | 65.888889 | 879  | 808   | 833   | 833   | 833   | 720 | 1401 | 2069 |
| 2049 | 460 | 881  | 1846   | 51.592593 | 758  | 700   | 716   | 716   | 716   | 640 | 1340 | 1877 |
| 2050 | 376 | 747  | 1662   | 28        | 647  | 596   | 602   | 602   | 602   | 577 | 1153 | 1681 |
| 2051 | 318 | 594  | 1517   | 10        | 551  | 498   | 525   | 525   | 525   | 455 | 1002 | 1513 |
| 2052 | 264 | 435  | 1337   | 10        | 475  | 394.6 | 439.8 | 439.8 | 439.8 | 412 | 853  | 1378 |
| 2053 | 193 | 307  | 1166   | 0         | 338  | 270.8 | 290.4 | 290.4 | 290.4 | 389 | 714  | 1235 |
| 2054 | 124 | 180  | 1028   | 0         | 201  | 183   | 184.2 | 184.2 | 184.2 | 365 | 524  | 1094 |
| 2055 | 102 | 96   | 913    | 0         | 132  | 112   | 112   | 112   | 112   | 249 | 339  | 986  |
| 2056 | 64  | 27   | 837    | 0         | 69   | 49    | 49    | 49    | 49    | 152 | 202  | 873  |
| 2057 | 15  | 27   | 673.4  | 0         | 19   | 19    | 21    | 21    | 21    | 99  | 122  | 702  |
| 2058 | 14  | 0    | 512.8  | 0         | 14   | 11    | 13    | 13    | 13    | 79  | 71   | 525  |
| 2059 | 1   | 0    | 355.45 | 0         | 5    | 8     | 8     | 8     | 8     | 42  | 39   | 361  |
| 2060 | 1   | 0    | 231.35 | 0         | 5    | 0     | 0     | 0     | 0     | 19  | 18   | 237  |
| 2061 | 1   | 0    | 135    | 0         | 5    | 0     | 0     | 0     | 0     | 2   | 8    | 171  |
| 2062 | 1   | 0    | 70     | 0         | 5    | 0     | 0     | 0     | 0     | 2   | 1    | 127  |
| 2063 | 1   | 0    | 21     | 0         | 5    | 0     | 0     | 0     | 0     | 2   | 1    | 87   |
| 2064 | 1   | 0    | 11     | 0         | 5    | 0     | 0     | 0     | 0     | 2   | 1    | 47   |
| 2065 | 1   | 0    | 6      | 0         | 5    | 0     | 0     | 0     | 0     | 2   | 1    | 16   |
| 2066 | 1   | 0    | 6      | 0         | 5    | 0     | 0     | 0     | 0     | 2   | 1    | 1    |
| 2067 | 1   | 0    | 6      | 0         | 5    | 0     | 0     | 0     | 0     | 2   | 1    | 1    |
| 2068 | 1   | 0    | 6      | 0         | 5    | 0     | 0     | 0     | 0     | 2   | 1    | 1    |

|      | 109 | 110 | 111 | 112 | 113 | 114 | 115 | 116 | 117 | 118 | 119 | 120 |
|------|-----|-----|-----|-----|-----|-----|-----|-----|-----|-----|-----|-----|
| 2069 | 1   | 0   | 6   | 0   | 5   | 0   | 0   | 0   | 0   | 2   | 1   | 1   |
| 2070 | 1   | 0   | 6   | 0   | 5   | 0   | 0   | 0   | 0   | 2   | 1   | 1   |
| 2071 | 1   | 0   | 6   | 0   | 5   | 0   | 0   | 0   | 0   | 2   | 1   | 1   |
| 2072 | 1   | 0   | 6   | 0   | 5   | 0   | 0   | 0   | 0   | 2   | 1   | 1   |
| 2073 | 1   | 0   | 6   | 0   | 5   | 0   | 0   | 0   | 0   | 2   | 1   | 1   |
| 2074 | 1   | 0   | 6   | 0   | 5   | 0   | 0   | 0   | 0   | 2   | 1   | 1   |
| 2075 | 1   | 0   | 6   | 0   | 5   | 0   | 0   | 0   | 0   | 2   | 1   | 1   |
| 2076 | 1   | 0   | 6   | 0   | 5   | 0   | 0   | 0   | 0   | 2   | 1   | 1   |
| 2077 | 1   | 0   | 6   | 0   | 5   | 0   | 0   | 0   | 0   | 2   | 1   | 1   |
| 2078 | 1   | 0   | 6   | 0   | 5   | 0   | 0   | 0   | 0   | 2   | 1   | 1   |
| 2079 | 1   | 0   | 6   | 0   | 5   | 0   | 0   | 0   | 0   | 2   | 1   | 1   |
| 2080 | 1   | 0   | 6   | 0   | 5   | 0   | 0   | 0   | 0   | 2   | 1   | 1   |
| 2081 | 1   | 0   | 6   | 0   | 5   | 0   | 0   | 0   | 0   | 2   | 1   | 1   |
| 2082 | 1   | 0   | 6   | 0   | 5   | 0   | 0   | 0   | 0   | 2   | 1   | 1   |
| 2083 | 1   | 0   | 6   | 0   | 5   | 0   | 0   | 0   | 0   | 2   | 1   | 1   |
| 2084 | 1   | 0   | 6   | 0   | 5   | 0   | 0   | 0   | 0   | 2   | 1   | 1   |
| 2085 | 1   | 0   | 6   | 0   | 5   | 0   | 0   | 0   | 0   | 2   | 1   | 1   |
| 2086 | 1   | 0   | 6   | 0   | 5   | 0   | 0   | 0   | 0   | 2   | 1   | 1   |
| 2087 | 1   | 0   | 6   | 0   | 5   | 0   | 0   | 0   | 0   | 2   | 1   | 1   |
| 2088 | 1   | 0   | 6   | 0   | 5   | 0   | 0   | 0   | 0   | 2   | 1   | 1   |
| 2089 | 1   | 0   | 6   | 0   | 5   | 0   | 0   | 0   | 0   | 2   | 1   | 1   |
| 2090 | 1   | 0   | 6   | 0   | 5   | 0   | 0   | 0   | 0   | 2   | 1   | 1   |
|      |     |     |     |     |     |     |     |     |     |     |     |     |

|      | 121 | 122  | 123  | 124  | 125  | 126  | 127 | 128  | 129  | 130 | 131  | 132  |
|------|-----|------|------|------|------|------|-----|------|------|-----|------|------|
| 2002 | 0   | 0    | 0    | 0    | 0    | 0    | 0   | 0    | 0    | 0   | 0    | 0    |
| 2003 | 0   | 0    | 0    | 0    | 0    | 0    | 0   | 0    | 0    | 0   | 0    | 0    |
| 2004 | 0   | 0    | 0    | 0    | 0    | 0    | 0   | 0    | 0    | 0   | 0    | 0    |
| 2005 | 0   | 0    | 0    | 0    | 0    | 0    | 0   | 0    | 0    | 0   | 0    | 0    |
| 2006 | 0   | 0    | 0    | 0    | 0    | 0    | 0   | 0    | 0    | 0   | 0    | 0    |
| 2007 | 0   | 0    | 0    | 0    | 0    | 0    | 0   | 0    | 0    | 0   | 0    | 0    |
| 2008 | 0   | 0    | 0    | 0    | 0    | 0    | 0   | 0    | 0    | 0   | 0    | 0    |
| 2009 | 0   | 0    | 0    | 0    | 0    | 0    | 0   | 0    | 0    | 0   | 0    | 0    |
| 2010 | 0   | 0    | 0    | 0    | 0    | 0    | 0   | 0    | 0    | 0   | 0    | 0    |
| 2011 | 0   | 0    | 0    | 0    | 0    | 0    | 0   | 0    | 0    | 0   | 0    | 0    |
| 2012 | 0   | 0    | 0    | 0    | 0    | 0    | 0   | 105  | 0    | 0   | 0    | 0    |
| 2013 | 0   | 0    | 0    | 0    | 0    | 0    | 0   | 234  | 0    | 0   | 0    | 0    |
| 2014 | 0   | 0    | 0    | 0    | 0    | 0    | 0   | 352  | 0    | 0   | 0    | 0    |
| 2015 | 0   | 0    | 0    | 0    | 0    | 0    | 0   | 501  | 0    | 0   | 0    | 0    |
| 2016 | 143 | 143  | 143  | 143  | 143  | 143  | 0   | 644  | 143  | 143 | 143  | 143  |
| 2017 | 295 | 295  | 295  | 295  | 295  | 295  | 0   | 796  | 295  | 295 | 295  | 295  |
| 2018 | 462 | 462  | 462  | 462  | 462  | 462  | 0   | 963  | 462  | 462 | 462  | 462  |
| 2019 | 635 | 635  | 635  | 635  | 635  | 635  | 0   | 1136 | 635  | 635 | 635  | 635  |
| 2020 | 635 | 808  | 808  | 808  | 808  | 808  | 173 | 1309 | 808  | 635 | 808  | 808  |
| 2021 | 635 | 994  | 994  | 994  | 994  | 994  | 359 | 1495 | 994  | 635 | 994  | 994  |
| 2022 | 635 | 1160 | 1160 | 1160 | 1160 | 1160 | 525 | 1661 | 1160 | 635 | 1160 | 1160 |
| 2023 | 635 | 1350 | 1350 | 1350 | 1350 | 1350 | 715 | 1851 | 1350 | 635 | 1350 | 1350 |
| 2024 | 630 | 1549 | 1549 | 1549 | 1549 | 1549 | 914 | 2050 | 1549 | 630 | 1549 | 1549 |
| 2025 | 630 | 1549 | 1549 | 1549 | 1549 | 1549 | 914 | 2050 | 1741 | 630 | 1549 | 1549 |
| 2026 | 630 | 1549 | 1549 | 1549 | 1549 | 1549 | 914 | 2050 | 1924 | 630 | 1549 | 1549 |
| 2027 | 627 | 1549 | 1549 | 1549 | 1549 | 1549 | 914 | 2040 | 2117 | 630 | 1549 | 1549 |
| 2028 | 612 | 1549 | 1549 | 1549 | 1549 | 1549 | 914 | 2040 | 2311 | 620 | 1549 | 1549 |
| 2029 | 599 | 1541 | 1541 | 1539 | 1539 | 1539 | 914 | 2030 | 2483 | 605 | 1541 | 1539 |
| 2030 | 590 | 1530 | 1523 | 1530 | 1530 | 1530 | 906 | 2029 | 2483 | 599 | 1535 | 1530 |
| 2031 | 572 | 1525 | 1507 | 1525 | 1525 | 1525 | 899 | 2015 | 2483 | 587 | 1535 | 1512 |
| 2032 | 567 | 1510 | 1466 | 1493 | 1493 | 1493 | 896 | 1990 | 2483 | 587 | 1535 | 1480 |
| 2033 | 545 | 1499 | 1435 | 1474 | 1474 | 1474 | 877 | 1954 | 2483 | 586 | 1525 | 1458 |
| 2034 | 536 | 1496 | 1412 | 1463 | 1463 | 1463 | 875 | 1937 | 2483 | 573 | 1516 | 1444 |
| 2035 | 525 | 1485 | 1373 | 1443 | 1443 | 1443 | 865 | 1917 | 2473 | 560 | 1515 | 1407 |
| 2036 | 485 | 1475 | 1351 | 1433 | 1433 | 1433 | 861 | 1905 | 2472 | 534 | 1510 | 1390 |
| 2037 | 455 | 1463 | 1327 | 1397 | 1397 | 1397 | 850 | 1875 | 2472 | 520 | 1508 | 1368 |
| 2038 | 429 | 1450 | 1294 | 1383 | 1383 | 1383 | 845 | 1838 | 2461 | 510 | 1482 | 1337 |
| 2039 | 423 | 1434 | 1270 | 1358 | 1358 | 1358 | 835 | 1787 | 2428 | 498 | 1469 | 1304 |
| 2040 | 417 | 1425 | 1258 | 1344 | 1344 | 1344 | 800 | 1762 | 2393 | 472 | 1451 | 1273 |
| 2041 | 395 | 1423 | 1208 | 1334 | 1334 | 1334 | 800 | 1750 | 2371 | 453 | 1448 | 1243 |
| 2042 | 390 | 1423 | 1157 | 1308 | 1308 | 1308 | 794 | 1717 | 2339 | 422 | 1440 | 1190 |
| 2043 | 381 | 1416 | 1107 | 1282 | 1282 | 1282 | 793 | 1678 | 2312 | 398 | 1421 | 1157 |
| 2044 | 379 | 1373 | 1053 | 1239 | 1239 | 1239 | 778 | 1627 | 2296 | 386 | 1385 | 1111 |
| 2045 | 372 | 1319 | 1004 | 1196 | 1196 | 1196 | 761 | 1574 | 2254 | 374 | 1373 | 1076 |
| 2046 | 372 | 1289 | 972  | 1170 | 1170 | 1170 | 745 | 1546 | 2216 | 364 | 1356 | 1026 |
| 2047 | 371 | 1266 | 958  | 1160 | 1160 | 1160 | 691 | 1430 | 2177 | 314 | 1275 | 959  |
| 2048 | 367 | 1157 | 942  | 1142 | 1142 | 1142 | 654 | 1242 | 2089 | 251 | 1146 | 866  |
| 2049 | 348 | 1003 | 854  | 1064 | 1064 | 1064 | 511 | 1087 | 1939 | 145 | 968  | 775  |
| 2050 | 293 | 861  | 764  | 912  | 912  | 912  | 441 | 923  | 1768 | 84  | 834  | 687  |
| 2051 | 229 | 764  | 686  | 780  | 780  | 780  | 412 | 791  | 1602 | 45  | 730  | 609  |
| 2052 | 142 | 674  | 568  | 688  | 688  | 688  | 379 | 615  | 1448 | 24  | 648  | 448  |
| 2053 | 71  | 578  | 418  | 609  | 609  | 609  | 309 | 429  | 1319 | 12  | 559  | 284  |
| 2054 | 44  | 451  | 270  | 506  | 506  | 506  | 175 | 258  | 1170 | 8   | 406  | 161  |
| 2055 | 24  | 285  | 151  | 334  | 334  | 334  | 120 | 145  | 1035 | 5   | 256  | 92   |
| 2056 | 10  | 171  | 80   | 207  | 207  | 207  | 79  | 77   | 910  | 5   | 149  | 41   |
| 2057 | 6   | 90   | 36   | 120  | 120  | 120  | 49  | 39   | 770  | 5   | 80   | 20   |
| 2058 | 6   | 46   | 18   | 75   | 75   | 75   | 19  | 18   | 597  | 5   | 36   | 8    |
| 2059 | 2   | 25   | 3    | 36   | 36   | 36   | 2   | 3    | 403  | 5   | 15   | 5    |
| 2060 | 2   | 13   | 1    | 15   | 15   | 15   | 2   | 3    | 283  | 5   | 3    | 4    |
| 2061 | 2   | 3    | 1    | 3    | 3    | 3    | 2   | 3    | 200  | 5   | 1    | 1    |
| 2062 | 2   | 3    | 1    | 1    | 1    | 1    | 2   | 3    | 141  | 5   | 1    | 1    |
| 2063 | 2   | 3    | 1    | 1    | 1    | 1    | 2   | 3    | 97   | 5   | 1    | 1    |
| 2064 | 2   | 3    | 1    | 1    | 1    | 1    | 2   | 3    | 57   | 5   | 1    | 1    |
| 2065 | 2   | 3    | 1    | 1    | 1    | 1    | 2   | 3    | 18   | 5   | 1    | 1    |
| 2066 | 2   | 3    | 1    | 1    | 1    | 1    | 2   | 3    | 12   | 5   | 1    | 1    |
| 2067 | 2   | 3    | 1    | 1    | 1    | 1    | 2   | 3    | 12   | 5   | 1    | 1    |
| 2068 | 2   | 3    | 1    | 1    | 1    | 1    | 2   | 3    | 12   | 5   | 1    | 1    |

|      | 121 | 122 | 123 | 124 | 125 | 126 | 127 | 128 | 129 | 130 | 131 | 132 |
|------|-----|-----|-----|-----|-----|-----|-----|-----|-----|-----|-----|-----|
| 2069 | 2   | 3   | 1   | 1   | 1   | 1   | 2   | 3   | 12  | 5   | 1   | 1   |
| 2070 | 2   | 3   | 1   | 1   | 1   | 1   | 2   | 3   | 12  | 5   | 1   | 1   |
| 2071 | 2   | 3   | 1   | 1   | 1   | 1   | 2   | 3   | 12  | 5   | 1   | 1   |
| 2072 | 2   | 3   | 1   | 1   | 1   | 1   | 2   | 3   | 12  | 5   | 1   | 1   |
| 2073 | 2   | 3   | 1   | 1   | 1   | 1   | 2   | 3   | 12  | 5   | 1   | 1   |
| 2074 | 2   | 3   | 1   | 1   | 1   | 1   | 2   | 3   | 12  | 5   | 1   | 1   |
| 2075 | 2   | 3   | 1   | 1   | 1   | 1   | 2   | 3   | 12  | 5   | 1   | 1   |
| 2076 | 2   | 3   | 1   | 1   | 1   | 1   | 2   | 3   | 12  | 5   | 1   | 1   |
| 2077 | 2   | 3   | 1   | 1   | 1   | 1   | 2   | 3   | 12  | 5   | 1   | 1   |
| 2078 | 2   | 3   | 1   | 1   | 1   | 1   | 2   | 3   | 12  | 5   | 1   | 1   |
| 2079 | 2   | 3   | 1   | 1   | 1   | 1   | 2   | 3   | 12  | 5   | 1   | 1   |
| 2080 | 2   | 3   | 1   | 1   | 1   | 1   | 2   | 3   | 12  | 5   | 1   | 1   |
| 2081 | 2   | 3   | 1   | 1   | 1   | 1   | 2   | 3   | 12  | 5   | 1   | 1   |
| 2082 | 2   | 3   | 1   | 1   | 1   | 1   | 2   | 3   | 12  | 5   | 1   | 1   |
| 2083 | 2   | 3   | 1   | 1   | 1   | 1   | 2   | 3   | 12  | 5   | 1   | 1   |
| 2084 | 2   | 3   | 1   | 1   | 1   | 1   | 2   | 3   | 12  | 5   | 1   | 1   |
| 2085 | 2   | 3   | 1   | 1   | 1   | 1   | 2   | 3   | 12  | 5   | 1   | 1   |
| 2086 | 2   | 3   | 1   | 1   | 1   | 1   | 2   | 3   | 12  | 5   | 1   | 1   |
| 2087 | 2   | 3   | 1   | 1   | 1   | 1   | 2   | 3   | 12  | 5   | 1   | 1   |
| 2088 | 2   | 3   | 1   | 1   | 1   | 1   | 2   | 3   | 12  | 5   | 1   | 1   |
| 2089 | 2   | 3   | 1   | 1   | 1   | 1   | 2   | 3   | 12  | 5   | 1   | 1   |
| 2090 | 2   | 3   | 1   | 1   | 1   | 1   | 2   | 3   | 12  | 5   | 1   | 1   |
|      |     |     |     |     |     |     |     |     |     |     |     |     |



|      | 133  | 134  | 135  | 136 | 137  | 138  | 139 | 140  | 141  |
|------|------|------|------|-----|------|------|-----|------|------|
| 2002 | 0    | 0    | 0    | 0   | 0    | 0    | 0   | 0    | 0    |
| 2003 | 0    | 0    | 0    | 0   | 0    | 0    | 0   | 0    | 0    |
| 2004 | 0    | 0    | 0    | 0   | 0    | 0    | 0   | 0    | 0    |
| 2005 | 0    | 0    | 0    | 0   | 0    | 0    | 0   | 0    | 0    |
| 2006 | 0    | 0    | 0    | 0   | 0    | 0    | 0   | 0    | 0    |
| 2007 | 0    | 0    | 0    | 0   | 0    | 0    | 0   | 0    | 0    |
| 2008 | 0    | 0    | 0    | 0   | 0    | 0    | 0   | 0    | 0    |
| 2009 | 0    | 0    | 0    | 0   | 0    | 0    | 0   | 0    | 0    |
| 2010 | 0    | 0    | 0    | 0   | 0    | 0    | 0   | 0    | 0    |
| 2011 | 0    | 0    | 0    | 0   | 0    | 0    | 0   | 0    | 0    |
| 2012 | 0    | 0    | 0    | 0   | 105  | 0    | 0   | 0    | 0    |
| 2013 | 0    | 0    | 0    | 0   | 234  | 0    | 0   | 0    | 0    |
| 2014 | 0    | 0    | 0    | 0   | 352  | 0    | 0   | 0    | 0    |
| 2015 | 0    | 0    | 0    | 0   | 501  | 0    | 0   | 0    | 0    |
| 2016 | 143  | 143  | 143  | 0   | 644  | 143  | 143 | 143  | 143  |
| 2017 | 295  | 295  | 295  | 0   | 796  | 295  | 295 | 295  | 295  |
| 2018 | 462  | 462  | 462  | 0   | 963  | 462  | 462 | 462  | 462  |
| 2019 | 635  | 635  | 635  | 0   | 1136 | 635  | 635 | 635  | 635  |
| 2020 | 808  | 808  | 808  | 173 | 1309 | 808  | 635 | 808  | 808  |
| 2021 | 994  | 994  | 994  | 359 | 1495 | 994  | 609 | 994  | 994  |
| 2022 | 1160 | 1160 | 1160 | 525 | 1661 | 1160 | 594 | 1160 | 1160 |
| 2023 | 1350 | 1350 | 1350 | 715 | 1851 | 1350 | 566 | 1350 | 1350 |
| 2024 | 1549 | 1549 | 1549 | 914 | 2050 | 1549 | 517 | 1549 | 1549 |
| 2025 | 1549 | 1549 | 1549 | 914 | 2050 | 1741 | 481 | 1549 | 1549 |
| 2026 | 1549 | 1549 | 1549 | 892 | 1978 | 1924 | 462 | 1487 | 1487 |
| 2027 | 1549 | 1549 | 1549 | 869 | 1894 | 2117 | 445 | 1463 | 1463 |
| 2028 | 1549 | 1549 | 1549 | 852 | 1812 | 2311 | 403 | 1411 | 1411 |
| 2029 | 1539 | 1539 | 1539 | 835 | 1719 | 2483 | 384 | 1348 | 1348 |
| 2030 | 1535 | 1535 | 1535 | 776 | 1630 | 2483 | 341 | 1258 | 1258 |
| 2031 | 1528 | 1528 | 1528 | 723 | 1561 | 2413 | 321 | 1180 | 1180 |
| 2032 | 1519 | 1519 | 1519 | 689 | 1475 | 2367 | 307 | 1087 | 1087 |
| 2033 | 1493 | 1493 | 1493 | 649 | 1385 | 2307 | 304 | 1037 | 1037 |
| 2034 | 1477 | 1477 | 1477 | 619 | 1297 | 2230 | 296 | 1005 | 1005 |
| 2035 | 1455 | 1455 | 1455 | 591 | 1249 | 2136 | 289 | 967  | 967  |
| 2036 | 1446 | 1446 | 1446 | 569 | 1200 | 2036 | 279 | 921  | 917  |
| 2037 | 1436 | 1436 | 1436 | 561 | 1167 | 1915 | 274 | 881  | 881  |
| 2038 | 1424 | 1424 | 1424 | 551 | 1127 | 1790 | 271 | 861  | 855  |
| 2039 | 1392 | 1392 | 1392 | 514 | 1105 | 1689 | 271 | 839  | 835  |
| 2040 | 1366 | 1366 | 1366 | 505 | 1085 | 1591 | 255 | 829  | 805  |
| 2041 | 1354 | 1354 | 1354 | 497 | 1057 | 1518 | 255 | 806  | 785  |
| 2042 | 1345 | 1345 | 1345 | 492 | 1027 | 1491 | 255 | 786  | 749  |
| 2043 | 1328 | 1328 | 1328 | 479 | 976  | 1461 | 246 | 746  | 715  |
| 2044 | 1290 | 1290 | 1290 | 446 | 955  | 1451 | 174 | 717  | 695  |
| 2045 | 1247 | 1247 | 1247 | 439 | 926  | 1392 | 144 | 716  | 684  |
| 2046 | 1220 | 1220 | 1220 | 396 | 792  | 1338 | 112 | 599  | 672  |
| 2047 | 1130 | 1130 | 1130 | 322 | 625  | 1280 | 61  | 494  | 574  |
| 2048 | 977  | 977  | 977  | 256 | 449  | 1225 | 26  | 384  | 454  |
| 2049 | 830  | 830  | 830  | 199 | 322  | 1204 | 21  | 282  | 336  |
| 2050 | 738  | 738  | 738  | 138 | 218  | 1095 | 5   | 199  | 262  |
| 2051 | 664  | 664  | 664  | 105 | 129  | 932  | 5   | 134  | 188  |
| 2052 | 558  | 558  | 558  | 68  | 53   | 757  | 5   | 87   | 114  |
| 2053 | 393  | 393  | 393  | 24  | 23   | 632  | 5   | 36   | 52   |
| 2054 | 234  | 234  | 234  | 18  | 23   | 552  | 5   | 19   | 16   |
| 2055 | 142  | 142  | 142  | 6   | 1    | 433  | 5   | 7    | 14   |
| 2056 | 80   | 80   | 80   | 6   | 0    | 318  | 5   | 5    | 2    |
| 2057 | 36   | 36   | 36   | 0   | 0    | 239  | 5   | 2    | 2    |
| 2058 | 15   | 15   | 15   | 0   | 0    | 156  | 5   | 0    | 2    |
| 2059 | 3    | 3    | 3    | 0   | 0    | 92   | 5   | 0    | 2    |
| 2060 | 3    | 3    | 3    | 0   | 0    | 44   | 5   | 0    | 2    |
| 2061 | 3    | 3    | 3    | 0   | 0    | 11   | 5   | 0    | 2    |
| 2062 | 3    | 3    | 3    | 0   | 0    | 1    | 5   | 0    | 2    |
| 2063 | 3    | 3    | 3    | 0   | 0    | 1    | 5   | 0    | 2    |
| 2064 | 3    | 3    | 3    | 0   | 0    | 1    | 5   | 0    | 2    |
| 2065 | 3    | 3    | 3    | 0   | 0    | 1    | 5   | 0    | 2    |
| 2066 | 3    | 3    | 3    | 0   | 0    | 1    | 5   | 0    | 2    |
| 2067 | 3    | 3    | 3    | 0   | 0    | 1    | 5   | 0    | 2    |
| 2068 | 3    | 3    | 3    | 0   | 0    | 1    | 5   | 0    | 2    |

|      | 133 | 134 | 135 | 136 | 137 | 138 | 139 | 140 | 141 |
|------|-----|-----|-----|-----|-----|-----|-----|-----|-----|
| 2069 | 3   | 3   | 3   | 0   | 0   | 1   | 5   | 0   | 2   |
| 2070 | 3   | 3   | 3   | 0   | 0   | 1   | 5   | 0   | 2   |
| 2071 | 3   | 3   | 3   | 0   | 0   | 1   | 5   | 0   | 2   |
| 2072 | 3   | 3   | 3   | 0   | 0   | 1   | 5   | 0   | 2   |
| 2073 | 3   | 3   | 3   | 0   | 0   | 1   | 5   | 0   | 2   |
| 2074 | 3   | 3   | 3   | 0   | 0   | 1   | 5   | 0   | 2   |
| 2075 | 3   | 3   | 3   | 0   | 0   | 1   | 5   | 0   | 2   |
| 2076 | 3   | 3   | 3   | 0   | 0   | 1   | 5   | 0   | 2   |
| 2077 | 3   | 3   | 3   | 0   | 0   | 1   | 5   | 0   | 2   |
| 2078 | 3   | 3   | 3   | 0   | 0   | 1   | 5   | 0   | 2   |
| 2079 | 3   | 3   | 3   | 0   | 0   | 1   | 5   | 0   | 2   |
| 2080 | 3   | 3   | 3   | 0   | 0   | 1   | 5   | 0   | 2   |
| 2081 | 3   | 3   | 3   | 0   | 0   | 1   | 5   | 0   | 2   |
| 2082 | 3   | 3   | 3   | 0   | 0   | 1   | 5   | 0   | 2   |
| 2083 | 3   | 3   | 3   | 0   | 0   | 1   | 5   | 0   | 2   |
| 2084 | 3   | 3   | 3   | 0   | 0   | 1   | 5   | 0   | 2   |
| 2085 | 3   | 3   | 3   | 0   | 0   | 1   | 5   | 0   | 2   |
| 2086 | 3   | 3   | 3   | 0   | 0   | 1   | 5   | 0   | 2   |
| 2087 | 3   | 3   | 3   | 0   | 0   | 1   | 5   | 0   | 2   |
| 2088 | 3   | 3   | 3   | 0   | 0   | 1   | 5   | 0   | 2   |
| 2089 | 3   | 3   | 3   | 0   | 0   | 1   | 5   | 0   | 2   |
| 2090 | 3   | 3   | 3   | 0   | 0   | 1   | 5   | 0   | 2   |
|      |     |     |     |     |     |     |     |     |     |

|      | 142  | 143  | 144  | 145 | 146  | 147  | 148 | 149  | 150  | 151  |
|------|------|------|------|-----|------|------|-----|------|------|------|
| 2002 | 0    | 0    | 0    | 0   | 0    | 0    | 0   | 0    | 0    | 0    |
| 2003 | 0    | 0    | 0    | 0   | 0    | 0    | 0   | 0    | 0    | 0    |
| 2004 | 0    | 0    | 0    | 0   | 0    | 0    | 0   | 0    | 0    | 0    |
| 2005 | 0    | 0    | 0    | 0   | 0    | 0    | 0   | 0    | 0    | 0    |
| 2006 | 0    | 0    | 0    | 0   | 0    | 0    | 0   | 0    | 0    | 0    |
| 2007 | 0    | 0    | 0    | 0   | 0    | 0    | 0   | 0    | 0    | 0    |
| 2008 | 0    | 0    | 0    | 0   | 0    | 0    | 0   | 0    | 0    | 0    |
| 2009 | 0    | 0    | 0    | 0   | 0    | 0    | 0   | 0    | 0    | 0    |
| 2010 | 0    | 0    | 0    | 0   | 0    | 0    | 0   | 0    | 0    | 0    |
| 2011 | 0    | 0    | 0    | 0   | 0    | 0    | 0   | 0    | 0    | 0    |
| 2012 | 0    | 0    | 0    | 0   | 105  | 0    | 0   | 0    | 0    | 0    |
| 2013 | 0    | 0    | 0    | 0   | 234  | 0    | 0   | 0    | 0    | 0    |
| 2014 | 0    | 0    | 0    | 0   | 352  | 0    | 0   | 0    | 0    | 0    |
| 2015 | 0    | 0    | 0    | 0   | 501  | 0    | 0   | 0    | 0    | 0    |
| 2016 | 143  | 143  | 143  | 0   | 644  | 143  | 143 | 143  | 143  | 143  |
| 2017 | 295  | 295  | 295  | 0   | 796  | 295  | 295 | 295  | 295  | 295  |
| 2018 | 462  | 462  | 462  | 0   | 963  | 462  | 462 | 462  | 462  | 462  |
| 2019 | 635  | 635  | 635  | 0   | 1136 | 635  | 635 | 635  | 635  | 635  |
| 2020 | 808  | 808  | 808  | 173 | 1309 | 808  | 635 | 808  | 808  | 808  |
| 2021 | 994  | 994  | 994  | 359 | 1495 | 994  | 624 | 994  | 994  | 994  |
| 2022 | 1160 | 1160 | 1160 | 525 | 1661 | 1160 | 590 | 1160 | 1160 | 1160 |
| 2023 | 1350 | 1350 | 1350 | 715 | 1851 | 1350 | 539 | 1350 | 1350 | 1350 |
| 2024 | 1549 | 1549 | 1549 | 914 | 2050 | 1549 | 509 | 1549 | 1549 | 1549 |
| 2025 | 1549 | 1549 | 1549 | 914 | 2050 | 1741 | 478 | 1549 | 1549 | 1549 |
| 2026 | 1487 | 1487 | 1487 | 905 | 1961 | 1924 | 457 | 1490 | 1490 | 1490 |
| 2027 | 1463 | 1463 | 1463 | 871 | 1885 | 2117 | 434 | 1434 | 1434 | 1434 |
| 2028 | 1411 | 1411 | 1411 | 836 | 1772 | 2311 | 421 | 1342 | 1342 | 1342 |
| 2029 | 1348 | 1348 | 1348 | 770 | 1645 | 2483 | 411 | 1227 | 1227 | 1227 |
| 2030 | 1258 | 1258 | 1258 | 733 | 1544 | 2483 | 402 | 1161 | 1161 | 1161 |
| 2031 | 1180 | 1180 | 1180 | 665 | 1468 | 2386 | 386 | 1105 | 1105 | 1105 |
| 2032 | 1087 | 1087 | 1087 | 615 | 1381 | 2302 | 370 | 1062 | 1062 | 1062 |
| 2033 | 1037 | 1037 | 1037 | 605 | 1314 | 2229 | 356 | 1035 | 1025 | 1025 |
| 2034 | 1005 | 1005 | 1005 | 588 | 1270 | 2130 | 335 | 1007 | 987  | 990  |
| 2035 | 967  | 967  | 967  | 576 | 1234 | 1985 | 321 | 975  | 955  | 958  |
| 2036 | 921  | 921  | 921  | 540 | 1180 | 1849 | 310 | 935  | 911  | 921  |
| 2037 | 881  | 881  | 881  | 538 | 1163 | 1748 | 298 | 911  | 891  | 902  |
| 2038 | 861  | 861  | 861  | 510 | 1122 | 1673 | 298 | 882  | 860  | 875  |
| 2039 | 839  | 839  | 839  | 480 | 1090 | 1612 | 298 | 845  | 836  | 840  |
| 2040 | 829  | 829  | 829  | 470 | 1080 | 1568 | 298 | 826  | 811  | 821  |
| 2041 | 796  | 796  | 796  | 465 | 1053 | 1493 | 298 | 802  | 782  | 802  |
| 2042 | 780  | 780  | 780  | 445 | 1033 | 1441 | 293 | 782  | 763  | 782  |
| 2043 | 737  | 737  | 737  | 433 | 997  | 1366 | 283 | 763  | 733  | 763  |
| 2044 | 716  | 716  | 716  | 422 | 977  | 1307 | 283 | 751  | 711  | 741  |
| 2045 | 706  | 706  | 706  | 419 | 958  | 1262 | 276 | 741  | 700  | 721  |
| 2046 | 599  | 599  | 599  | 409 | 953  | 1241 | 276 | 740  | 688  | 717  |
| 2047 | 484  | 484  | 484  | 409 | 943  | 1227 | 236 | 740  | 678  | 709  |
| 2048 | 374  | 374  | 374  | 409 | 939  | 1217 | 161 | 740  | 678  | 707  |
| 2049 | 282  | 282  | 282  | 388 | 813  | 1197 | 75  | 677  | 609  | 654  |
| 2050 | 199  | 199  | 199  | 360 | 627  | 1194 | 54  | 572  | 491  | 553  |
| 2051 | 124  | 124  | 124  | 295 | 434  | 1117 | 36  | 416  | 319  | 383  |
| 2052 | 67   | 67   | 67   | 189 | 269  | 1010 | 16  | 257  | 198  | 240  |
| 2053 | 21   | 21   | 21   | 114 | 153  | 857  | 4   | 160  | 120  | 160  |
| 2054 | 19   | 19   | 19   | 79  | 97   | 668  | 0   | 90   | 75   | 90   |
| 2055 | 5    | 5    | 5    | 52  | 59   | 475  | 0   | 46   | 36   | 46   |
| 2056 | 0    | 0    | 0    | 29  | 38   | 311  | 0   | 25   | 15   | 25   |
| 2057 | 0    | 0    | 0    | 9   | 18   | 188  | 0   | 13   | 3    | 13   |
| 2058 | 0    | 0    | 0    | 1   | 8    | 111  | 0   | 3    | 3    | 3    |
| 2059 | 0    | 0    | 0    | 1   | 1    | 58   | 0   | 3    | 3    | 1    |
| 2060 | 0    | 0    | 0    | 1   | 1    | 36   | 0   | 3    | 3    | 1    |
| 2061 | 0    | 0    | 0    | 1   | 1    | 21   | 0   | 3    | 3    | 1    |
| 2062 | 0    | 0    | 0    | 1   | 1    | 11   | 0   | 3    | 3    | 1    |
| 2063 | 0    | 0    | 0    | 1   | 1    | 1    | 0   | 3    | 3    | 1    |
| 2064 | 0    | 0    | 0    | 1   | 1    | 1    | 0   | 3    | 3    | 1    |
| 2065 | 0    | 0    | 0    | 1   | 1    | 1    | 0   | 3    | 3    | 1    |
| 2066 | 0    | 0    | 0    | 1   | 1    | 1    | 0   | 3    | 3    | 1    |
| 2067 | 0    | 0    | 0    | 1   | 1    | 1    | 0   | 3    | 3    | 1    |
| 2068 | 0    | 0    | 0    | 1   | 1    | 1    | 0   | 3    | 3    | 1    |

|      | 142 | 143 | 144 | 145 | 146 | 147 | 148 | 149 | 150 | 151 |
|------|-----|-----|-----|-----|-----|-----|-----|-----|-----|-----|
| 2069 | 0   | 0   | 0   | 1   | 1   | 1   | 0   | 3   | 3   | 1   |
| 2070 | 0   | 0   | 0   | 1   | 1   | 1   | 0   | 3   | 3   | 1   |
| 2071 | 0   | 0   | 0   | 1   | 1   | 1   | 0   | 3   | 3   | 1   |
| 2072 | 0   | 0   | 0   | 1   | 1   | 1   | 0   | 3   | 3   | 1   |
| 2073 | 0   | 0   | 0   | 1   | 1   | 1   | 0   | 3   | 3   | 1   |
| 2074 | 0   | 0   | 0   | 1   | 1   | 1   | 0   | 3   | 3   | 1   |
| 2075 | 0   | 0   | 0   | 1   | 1   | 1   | 0   | 3   | 3   | 1   |
| 2076 | 0   | 0   | 0   | 1   | 1   | 1   | 0   | 3   | 3   | 1   |
| 2077 | 0   | 0   | 0   | 1   | 1   | 1   | 0   | 3   | 3   | 1   |
| 2078 | 0   | 0   | 0   | 1   | 1   | 1   | 0   | 3   | 3   | 1   |
| 2079 | 0   | 0   | 0   | 1   | 1   | 1   | 0   | 3   | 3   | 1   |
| 2080 | 0   | 0   | 0   | 1   | 1   | 1   | 0   | 3   | 3   | 1   |
| 2081 | 0   | 0   | 0   | 1   | 1   | 1   | 0   | 3   | 3   | 1   |
| 2082 | 0   | 0   | 0   | 1   | 1   | 1   | 0   | 3   | 3   | 1   |
| 2083 | 0   | 0   | 0   | 1   | 1   | 1   | 0   | 3   | 3   | 1   |
| 2084 | 0   | 0   | 0   | 1   | 1   | 1   | 0   | 3   | 3   | 1   |
| 2085 | 0   | 0   | 0   | 1   | 1   | 1   | 0   | 3   | 3   | 1   |
| 2086 | 0   | 0   | 0   | 1   | 1   | 1   | 0   | 3   | 3   | 1   |
| 2087 | 0   | 0   | 0   | 1   | 1   | 1   | 0   | 3   | 3   | 1   |
| 2088 | 0   | 0   | 0   | 1   | 1   | 1   | 0   | 3   | 3   | 1   |
| 2089 | 0   | 0   | 0   | 1   | 1   | 1   | 0   | 3   | 3   | 1   |
| 2090 | 0   | 0   | 0   | 1   | 1   | 1   | 0   | 3   | 3   | 1   |
|      |     |     |     |     |     |     |     |     |     |     |

|      | 152  | 153  | 154 | 155  | 156  | 157 | 158  | 159  | 160  | 161  | 162  |
|------|------|------|-----|------|------|-----|------|------|------|------|------|
| 2002 | 0    | 0    | 0   | 0    | 0    | 0   | 0    | 0    | 0    | 0    | 0    |
| 2003 | 0    | 0    | 0   | 0    | 0    | 0   | 0    | 0    | 0    | 0    | 0    |
| 2004 | 0    | 0    | 0   | 0    | 0    | 0   | 0    | 0    | 0    | 0    | 0    |
| 2005 | 0    | 0    | 0   | 0    | 0    | 0   | 0    | 0    | 0    | 0    | 0    |
| 2006 | 0    | 0    | 0   | 0    | 0    | 0   | 0    | 0    | 0    | 0    | 0    |
| 2007 | 0    | 0    | 0   | 0    | 0    | 0   | 0    | 0    | 0    | 0    | 0    |
| 2008 | 0    | 0    | 0   | 0    | 0    | 0   | 0    | 0    | 0    | 0    | 0    |
| 2009 | 0    | 0    | 0   | 0    | 0    | 0   | 0    | 0    | 0    | 0    | 0    |
| 2010 | 0    | 0    | 0   | 0    | 0    | 0   | 0    | 0    | 0    | 0    | 0    |
| 2011 | 0    | 0    | 0   | 0    | 0    | 0   | 0    | 0    | 0    | 0    | 0    |
| 2012 | 0    | 0    | 0   | 105  | 0    | 0   | 0    | 0    | 0    | 0    | 0    |
| 2013 | 0    | 0    | 0   | 234  | 0    | 0   | 0    | 0    | 0    | 0    | 0    |
| 2014 | 0    | 0    | 0   | 352  | 0    | 0   | 0    | 0    | 0    | 0    | 0    |
| 2015 | 0    | 0    | 0   | 501  | 0    | 0   | 0    | 0    | 0    | 0    | 0    |
| 2016 | 143  | 143  | 0   | 644  | 143  | 143 | 143  | 143  | 143  | 143  | 143  |
| 2017 | 295  | 295  | 0   | 796  | 295  | 295 | 295  | 295  | 295  | 295  | 295  |
| 2018 | 462  | 462  | 0   | 963  | 462  | 462 | 462  | 462  | 462  | 462  | 462  |
| 2019 | 635  | 635  | 0   | 1136 | 635  | 635 | 635  | 635  | 635  | 635  | 635  |
| 2020 | 808  | 808  | 173 | 1309 | 808  | 635 | 808  | 808  | 808  | 808  | 808  |
| 2021 | 994  | 994  | 359 | 1495 | 994  | 624 | 994  | 994  | 994  | 994  | 994  |
| 2022 | 1160 | 1160 | 525 | 1661 | 1160 | 590 | 1160 | 1160 | 1160 | 1160 | 1160 |
| 2023 | 1350 | 1350 | 715 | 1851 | 1350 | 539 | 1350 | 1350 | 1350 | 1350 | 1350 |
| 2024 | 1549 | 1549 | 914 | 2050 | 1549 | 509 | 1549 | 1549 | 1549 | 1549 | 1549 |
| 2025 | 1549 | 1549 | 914 | 2050 | 1741 | 478 | 1549 | 1549 | 1549 | 1549 | 1549 |
| 2026 | 1490 | 1490 | 905 | 1961 | 1924 | 457 | 1490 | 1490 | 1490 | 1490 | 1490 |
| 2027 | 1434 | 1434 | 871 | 1885 | 2117 | 434 | 1434 | 1434 | 1434 | 1434 | 1434 |
| 2028 | 1342 | 1342 | 836 | 1772 | 2311 | 421 | 1342 | 1342 | 1342 | 1342 | 1342 |
| 2029 | 1227 | 1227 | 770 | 1645 | 2483 | 413 | 1227 | 1227 | 1227 | 1227 | 1227 |
| 2030 | 1161 | 1161 | 733 | 1544 | 2483 | 408 | 1151 | 1161 | 1161 | 1161 | 1161 |
| 2031 | 1105 | 1105 | 665 | 1468 | 2386 | 392 | 1095 | 1105 | 1105 | 1105 | 1105 |
| 2032 | 1062 | 1062 | 615 | 1383 | 2302 | 376 | 1058 | 1062 | 1062 | 1062 | 1062 |
| 2033 | 1025 | 1025 | 605 | 1320 | 2229 | 365 | 1035 | 1025 | 1025 | 1025 | 1025 |
| 2034 | 990  | 990  | 594 | 1279 | 2130 | 362 | 1007 | 987  | 994  | 994  | 994  |
| 2035 | 958  | 958  | 592 | 1243 | 1985 | 353 | 977  | 955  | 966  | 966  | 966  |
| 2036 | 921  | 921  | 553 | 1184 | 1849 | 331 | 927  | 911  | 929  | 929  | 929  |
| 2037 | 902  | 902  | 538 | 1174 | 1748 | 321 | 903  | 894  | 915  | 915  | 915  |
| 2038 | 875  | 875  | 527 | 1130 | 1673 | 310 | 872  | 860  | 880  | 880  | 880  |
| 2039 | 840  | 840  | 497 | 1095 | 1612 | 298 | 841  | 836  | 845  | 845  | 845  |
| 2040 | 821  | 821  | 478 | 1080 | 1568 | 298 | 826  | 811  | 821  | 821  | 821  |
| 2041 | 802  | 802  | 465 | 1063 | 1493 | 288 | 802  | 792  | 802  | 802  | 802  |
| 2042 | 782  | 782  | 455 | 1043 | 1443 | 287 | 781  | 772  | 792  | 792  | 792  |
| 2043 | 763  | 763  | 435 | 1023 | 1376 | 277 | 751  | 753  | 772  | 772  | 772  |
| 2044 | 741  | 741  | 432 | 1007 | 1317 | 263 | 739  | 722  | 761  | 761  | 761  |
| 2045 | 721  | 721  | 422 | 984  | 1272 | 227 | 724  | 692  | 741  | 741  | 741  |
| 2046 | 717  | 717  | 409 | 956  | 1243 | 171 | 705  | 681  | 722  | 722  | 722  |
| 2047 | 709  | 709  | 395 | 942  | 1217 | 77  | 695  | 658  | 668  | 668  | 668  |
| 2048 | 707  | 707  | 372 | 819  | 1217 | 44  | 645  | 572  | 566  | 566  | 566  |
| 2049 | 654  | 654  | 303 | 622  | 1183 | 26  | 553  | 466  | 407  | 407  | 407  |
| 2050 | 553  | 553  | 199 | 420  | 1103 | 14  | 382  | 302  | 257  | 257  | 257  |
| 2051 | 383  | 383  | 117 | 259  | 1006 | 4   | 240  | 196  | 158  | 158  | 158  |
| 2052 | 240  | 240  | 79  | 153  | 870  | 4   | 150  | 130  | 90   | 90   | 90   |
| 2053 | 160  | 160  | 52  | 97   | 673  | 4   | 85   | 85   | 46   | 46   | 46   |
| 2054 | 90   | 90   | 29  | 59   | 453  | 4   | 46   | 46   | 25   | 25   | 25   |
| 2055 | 46   | 46   | 9   | 38   | 284  | 4   | 25   | 25   | 13   | 13   | 13   |
| 2056 | 25   | 25   | 1   | 18   | 180  | 4   | 13   | 13   | 3    | 3    | 3    |
| 2057 | 13   | 13   | 1   | 18   | 113  | 4   | 3    | 3    | 1    | 1    | 1    |
| 2058 | 3    | 3    | 1   | 18   | 62   | 4   | 1    | 3    | 1    | 1    | 1    |
| 2059 | 1    | 1    | 1   | 18   | 36   | 4   | 1    | 3    | 1    | 1    | 1    |
| 2060 | 1    | 1    | 1   | 18   | 21   | 4   | 1    | 3    | 1    | 1    | 1    |
| 2061 | 1    | 1    | 1   | 18   | 11   | 4   | 1    | 3    | 1    | 1    | 1    |
| 2062 | 1    | 1    | 1   | 18   | 1    | 4   | 1    | 3    | 1    | 1    | 1    |
| 2063 | 1    | 1    | 1   | 18   | 1    | 4   | 1    | 3    | 1    | 1    | 1    |
| 2064 | 1    | 1    | 1   | 18   | 1    | 4   | 1    | 3    | 1    | 1    | 1    |
| 2065 | 1    | 1    | 1   | 18   | 1    | 4   | 1    | 3    | 1    | 1    | 1    |
| 2066 | 1    | 1    | 1   | 18   | 1    | 4   | 1    | 3    | 1    | 1    | 1    |
| 2067 | 1    | 1    | 1   | 18   | 1    | 4   | 1    | 3    | 1    | 1    | 1    |
| 2068 | 1    | 1    | 1   | 18   | 1    | 4   | 1    | 3    | 1    | 1    | 1    |

|      | 152 | 153 | 154 | 155 | 156 | 157 | 158 | 159 | 160 | 161 | 162 |
|------|-----|-----|-----|-----|-----|-----|-----|-----|-----|-----|-----|
| 2069 | 1   | 1   | 1   | 18  | 1   | 4   | 1   | 3   | 1   | 1   | 1   |
| 2070 | 1   | 1   | 1   | 18  | 1   | 4   | 1   | 3   | 1   | 1   | 1   |
| 2071 | 1   | 1   | 1   | 18  | 1   | 4   | 1   | 3   | 1   | 1   | 1   |
| 2072 | 1   | 1   | 1   | 18  | 1   | 4   | 1   | 3   | 1   | 1   | 1   |
| 2073 | 1   | 1   | 1   | 18  | 1   | 4   | 1   | 3   | 1   | 1   | 1   |
| 2074 | 1   | 1   | 1   | 18  | 1   | 4   | 1   | 3   | 1   | 1   | 1   |
| 2075 | 1   | 1   | 1   | 18  | 1   | 4   | 1   | 3   | 1   | 1   | 1   |
| 2076 | 1   | 1   | 1   | 18  | 1   | 4   | 1   | 3   | 1   | 1   | 1   |
| 2077 | 1   | 1   | 1   | 18  | 1   | 4   | 1   | 3   | 1   | 1   | 1   |
| 2078 | 1   | 1   | 1   | 18  | 1   | 4   | 1   | 3   | 1   | 1   | 1   |
| 2079 | 1   | 1   | 1   | 18  | 1   | 4   | 1   | 3   | 1   | 1   | 1   |
| 2080 | 1   | 1   | 1   | 18  | 1   | 4   | 1   | 3   | 1   | 1   | 1   |
| 2081 | 1   | 1   | 1   | 18  | 1   | 4   | 1   | 3   | 1   | 1   | 1   |
| 2082 | 1   | 1   | 1   | 18  | 1   | 4   | 1   | 3   | 1   | 1   | 1   |
| 2083 | 1   | 1   | 1   | 18  | 1   | 4   | 1   | 3   | 1   | 1   | 1   |
| 2084 | 1   | 1   | 1   | 18  | 1   | 4   | 1   | 3   | 1   | 1   | 1   |
| 2085 | 1   | 1   | 1   | 18  | 1   | 4   | 1   | 3   | 1   | 1   | 1   |
| 2086 | 1   | 1   | 1   | 18  | 1   | 4   | 1   | 3   | 1   | 1   | 1   |
| 2087 | 1   | 1   | 1   | 18  | 1   | 4   | 1   | 3   | 1   | 1   | 1   |
| 2088 | 1   | 1   | 1   | 18  | 1   | 4   | 1   | 3   | 1   | 1   | 1   |
| 2089 | 1   | 1   | 1   | 18  | 1   | 4   | 1   | 3   | 1   | 1   | 1   |
| 2090 | 1   | 1   | 1   | 18  | 1   | 4   | 1   | 3   | 1   | 1   | 1   |
|      |     |     |     |     |     |     |     |     |     |     |     |

|      | 1    | 2    | 3    | 4    | 5    | 6    | 7    | 8    | 9    | 10   | 11   | 12   |
|------|------|------|------|------|------|------|------|------|------|------|------|------|
| 2002 | 0    | 0    | 0    | 0    | 0    | 0    | 0    | 0    | 0    | 0    | 0    | 0    |
| 2003 | 0    | 0    | 0    | 0    | 0    | 0    | 0    | 0    | 0    | 0    | 0    | 0    |
| 2004 | 0    | 0    | 0    | 0    | 0    | 0    | 0    | 0    | 0    | 0    | 0    | 0    |
| 2005 | 0    | 0    | 0    | 0    | 0    | 0    | 0    | 0    | 0    | 0    | 0    | 0    |
| 2006 | 0    | 0    | 0    | 0    | 0    | 0    | 0    | 0    | 0    | 0    | 0    | 0    |
| 2007 | 0    | 0    | 0    | 0    | 0    | 0    | 0    | 0    | 0    | 0    | 0    | 0    |
| 2008 | 0    | 0    | 0    | 0    | 0    | 0    | 0    | 0    | 0    | 0    | 0    | 0    |
| 2009 | 0    | 0    | 0    | 0    | 0    | 0    | 0    | 0    | 0    | 0    | 0    | 0    |
| 2010 | 0    | 0    | 0    | 0    | 0    | 0    | 0    | 0    | 0    | 0    | 0    | 0    |
| 2011 | 0    | 0    | 0    | 0    | 0    | 0    | 0    | 0    | 0    | 0    | 0    | 0    |
| 2012 | 0    | 0    | 0    | 0    | 0    | 0    | 0    | 0    | 0    | 0    | 0    | 0    |
| 2013 | 0    | 0    | 0    | 0    | 0    | 0    | 0    | 0    | 0    | 0    | 0    | 0    |
| 2014 | 0    | 0    | 0    | 0    | 0    | 0    | 0    | 0    | 0    | 0    | 0    | 0    |
| 2015 | 0    | 0    | 0    | 0    | 0    | 0    | 0    | 0    | 0    | 0    | 0    | 0    |
| 2016 | 0    | 0    | 0    | 0    | 0    | 0    | 0    | 0    | 0    | 0    | 0    | 0    |
| 2017 | 0    | 0    | 0    | 0    | 0    | 0    | 0    | 0    | 0    | 0    | 0    | 0    |
| 2018 | 0    | 0    | 0    | 0    | 0    | 0    | 0    | 0    | 0    | 0    | 0    | 0    |
| 2019 | 0    | 0    | 0    | 0    | 0    | 0    | 0    | 0    | 0    | 0    | 0    | 0    |
| 2020 | 0    | 0    | 0    | 0    | 0    | 0    | 0    | 0    | 0    | 0    | 0    | 0    |
| 2021 | 0    | 0    | 0    | 0    | 0    | 0    | 0    | 0    | 0    | 0    | 0    | 0    |
| 2022 | 0    | 0    | 0    | 0    | 0    | 0    | 0    | 0    | 0    | 0    | 0    | 0    |
| 2023 | 0    | 0    | 0    | 0    | 0    | 0    | 0    | 0    | 0    | 0    | 0    | 0    |
| 2024 | 0    | 0    | 0    | 0    | 0    | 0    | 0    | 0    | 0    | 0    | 0    | 0    |
| 2025 | 0    | 0    | 0    | 0    | 0    | 0    | 0    | 0    | 0    | 0    | 0    | 0    |
| 2026 | 0    | 0    | 0    | 0    | 0    | 0    | 0    | 0    | 0    | 0    | 0    | 0    |
| 2027 | 0    | 0    | 0    | 0    | 0    | 0    | 0    | 0    | 0    | 0    | 0    | 0    |
| 2028 | 0    | 0    | 0    | 0    | 0    | 0    | 0    | 0    | 0    | 0    | 0    | 0    |
| 2029 | 0    | 0    | 0    | 0    | 0    | 0    | 0    | 0    | 0    | 0    | 0    | 0    |
| 2030 | 0    | 0    | 0    | 0    | 0    | 0    | 0    | 0    | 0    | 0    | 0    | 0    |
| 2031 | 0    | 0    | 0    | 0    | 0    | 0    | 0    | 0    | 0    | 0    | 0    | 0    |
| 2032 | 0    | 0    | 0    | 0    | 0    | 0    | 0    | 0    | 0    | 0    | 0    | 0    |
| 2033 | 0    | 0    | 0    | 0    | 0    | 0    | 0    | 0    | 0    | 0    | 0    | 0    |
| 2034 | 0    | 0    | 0    | 0    | 0    | 0    | 0    | 0    | 0    | 0    | 0    | 0    |
| 2035 | 0    | 0    | 0    | 0    | 0    | 0    | 0    | 0    | 0    | 0    | 0    | 0    |
| 2036 | 0    | 0    | 0    | 0    | 0    | 0    | 0    | 0    | 0    | 0    | 0    | 0    |
| 2037 | 0    | 0    | 0    | 0    | 0    | 0    | 0    | 0    | 0    | 0    | 0    | 0    |
| 2038 | 0    | 0    | 0    | 0    | 0    | 0    | 0    | 0    | 0    | 0    | 0    | 0    |
| 2039 | 0    | 0    | 0    | 0    | 0    | 0    | 0    | 0    | 0    | 0    | 0    | 0    |
| 2040 | 0    | 0    | 0    | 0    | 0    | 0    | 0    | 0    | 0    | 0    | 0    | 0    |
| 2041 | 0    | 0    | 0    | 1    | 0    | 0    | 0    | 0    | 0    | 0    | 0    | 0    |
| 2042 | 0    | 0    | 0    | 637  | 0    | 0    | 0    | 0    | 0    | 0    | 0    | 0    |
| 2043 | 56   | 58   | 0    | 1060 | 33   | 72   | 59   | 59   | 59   | 0    | 0    | 0    |
| 2044 | 714  | 713  | 0    | 1307 | 686  | 724  | 711  | 711  | 711  | 0    | 0    | 0    |
| 2045 | 1114 | 1099 | 32   | 1424 | 1071 | 1124 | 1097 | 1097 | 1097 | 0    | 0    | 0    |
| 2046 | 1296 | 1281 | 801  | 1486 | 1253 | 1316 | 1279 | 1279 | 1279 | 0    | 0    | 0    |
| 2047 | 1383 | 1368 | 1153 | 1523 | 1340 | 1403 | 1366 | 1366 | 1366 | 0    | 0    | 0    |
| 2048 | 1466 | 1453 | 1312 | 1574 | 1429 | 1486 | 1450 | 1450 | 1450 | 0    | 0    | 404  |
| 2049 | 1476 | 1463 | 1400 | 1583 | 1440 | 1497 | 1461 | 1461 | 1461 | 421  | 421  | 682  |
| 2050 | 1485 | 1472 | 1413 | 1592 | 1449 | 1507 | 1470 | 1470 | 1470 | 763  | 763  | 869  |
| 2051 | 1500 | 1487 | 1429 | 1607 | 1464 | 1523 | 1485 | 1485 | 1485 | 1009 | 1009 | 1036 |
| 2052 | 1505 | 1492 | 1434 | 1612 | 1469 | 1528 | 1490 | 1490 | 1490 | 1199 | 1199 | 1138 |
| 2053 | 1505 | 1492 | 1434 | 1612 | 1469 | 1528 | 1490 | 1490 | 1490 | 1383 | 1383 | 1182 |
| 2054 | 1518 | 1505 | 1447 | 1625 | 1482 | 1541 | 1503 | 1503 | 1503 | 1497 | 1497 | 1218 |
| 2055 | 1520 | 1507 | 1449 | 1627 | 1484 | 1543 | 1505 | 1505 | 1505 | 1545 | 1545 | 1254 |
| 2056 | 1530 | 1517 | 1459 | 1637 | 1494 | 1553 | 1515 | 1515 | 1515 | 1582 | 1582 | 1275 |
| 2057 | 1530 | 1517 | 1459 | 1637 | 1494 | 1553 | 1515 | 1515 | 1515 | 1618 | 1618 | 1290 |
| 2058 | 1530 | 1517 | 1459 | 1637 | 1494 | 1553 | 1515 | 1515 | 1515 | 1657 | 1657 | 1292 |
| 2059 | 1530 | 1517 | 1459 | 1637 | 1494 | 1553 | 1515 | 1515 | 1515 | 1691 | 1691 | 1292 |
| 2060 | 1530 | 1517 | 1459 | 1637 | 1494 | 1553 | 1515 | 1515 | 1515 | 1703 | 1703 | 1292 |
| 2061 | 1530 | 1517 | 1459 | 1637 | 1494 | 1553 | 1515 | 1515 | 1515 | 1706 | 1706 | 1292 |
| 2062 | 1530 | 1517 | 1459 | 1637 | 1494 | 1553 | 1515 | 1515 | 1515 | 1707 | 1707 | 1292 |
| 2063 | 1530 | 1517 | 1459 | 1637 | 1494 | 1553 | 1515 | 1515 | 1515 | 1707 | 1707 | 1292 |
| 2064 | 1530 | 1517 | 1459 | 1637 | 1494 | 1553 | 1515 | 1515 | 1515 | 1707 | 1707 | 1292 |
| 2065 | 1530 | 1517 | 1459 | 1637 | 1494 | 1553 | 1515 | 1515 | 1515 | 1707 | 1707 | 1292 |
| 2066 | 1530 | 1517 | 1459 | 1637 | 1494 | 1553 | 1515 | 1515 | 1515 | 1707 | 1707 | 1292 |
| 2067 | 1530 | 1517 | 1459 | 1637 | 1494 | 1553 | 1515 | 1515 | 1515 | 1707 | 1707 | 1292 |
| 2068 | 1530 | 1517 | 1459 | 1637 | 1494 | 1553 | 1515 | 1515 | 1515 | 1707 | 1707 | 1292 |

|      | 1    | 2    | 3    | 4    | 5    | 6    | 7    | 8    | 9    | 10   | 11   | 12   |
|------|------|------|------|------|------|------|------|------|------|------|------|------|
| 2069 | 1530 | 1517 | 1459 | 1637 | 1494 | 1553 | 1515 | 1515 | 1515 | 1707 | 1707 | 1292 |
| 2070 | 1530 | 1517 | 1459 | 1637 | 1494 | 1553 | 1515 | 1515 | 1515 | 1707 | 1707 | 1292 |
| 2071 | 1530 | 1517 | 1459 | 1637 | 1494 | 1553 | 1515 | 1515 | 1515 | 1707 | 1707 | 1292 |
| 2072 | 1530 | 1517 | 1459 | 1637 | 1494 | 1553 | 1515 | 1515 | 1515 | 1707 | 1707 | 1292 |
| 2073 | 1530 | 1517 | 1459 | 1637 | 1494 | 1553 | 1515 | 1515 | 1515 | 1707 | 1707 | 1292 |
| 2074 | 1530 | 1517 | 1459 | 1637 | 1494 | 1553 | 1515 | 1515 | 1515 | 1707 | 1707 | 1292 |
| 2075 | 1530 | 1517 | 1459 | 1637 | 1494 | 1553 | 1515 | 1515 | 1515 | 1707 | 1707 | 1292 |
| 2076 | 1530 | 1517 | 1459 | 1637 | 1494 | 1553 | 1515 | 1515 | 1515 | 1707 | 1707 | 1292 |
| 2077 | 1530 | 1517 | 1459 | 1637 | 1494 | 1553 | 1515 | 1515 | 1515 | 1707 | 1707 | 1292 |
| 2078 | 1530 | 1517 | 1459 | 1637 | 1494 | 1553 | 1515 | 1515 | 1515 | 1707 | 1707 | 1292 |
| 2079 | 1530 | 1517 | 1459 | 1637 | 1494 | 1553 | 1515 | 1515 | 1515 | 1707 | 1707 | 1292 |
| 2080 | 1530 | 1517 | 1459 | 1637 | 1494 | 1553 | 1515 | 1515 | 1515 | 1707 | 1707 | 1292 |
| 2081 | 1530 | 1517 | 1459 | 1637 | 1494 | 1553 | 1515 | 1515 | 1515 | 1707 | 1707 | 1292 |
| 2082 | 1530 | 1517 | 1459 | 1637 | 1494 | 1553 | 1515 | 1515 | 1515 | 1707 | 1707 | 1292 |
| 2083 | 1530 | 1517 | 1459 | 1637 | 1494 | 1553 | 1515 | 1515 | 1515 | 1707 | 1707 | 1292 |
| 2084 | 1530 | 1517 | 1459 | 1637 | 1494 | 1553 | 1515 | 1515 | 1515 | 1707 | 1707 | 1292 |
| 2085 | 1530 | 1517 | 1459 | 1637 | 1494 | 1553 | 1515 | 1515 | 1515 | 1707 | 1707 | 1292 |
| 2086 | 1530 | 1517 | 1459 | 1637 | 1494 | 1553 | 1515 | 1515 | 1515 | 1707 | 1707 | 1292 |
| 2087 | 1530 | 1517 | 1459 | 1637 | 1494 | 1553 | 1515 | 1515 | 1515 | 1707 | 1707 | 1292 |
| 2088 | 1530 | 1517 | 1459 | 1637 | 1494 | 1553 | 1515 | 1515 | 1515 | 1707 | 1707 | 1292 |
| 2089 | 1530 | 1517 | 1459 | 1637 | 1494 | 1553 | 1515 | 1515 | 1515 | 1707 | 1707 | 1292 |
| 2090 | 1530 | 1517 | 1459 | 1637 | 1494 | 1553 | 1515 | 1515 | 1515 | 1707 | 1707 | 1292 |



|      | 13   | 14   | 15   | 16   | 17   | 18   | 19   | 20   | 21   | 22   | 23   | 24   |
|------|------|------|------|------|------|------|------|------|------|------|------|------|
| 2002 | 0    | 0    | 0    | 0    | 0    | 0    | 0    | 0    | 0    | 0    | 0    | 0    |
| 2003 | 0    | 0    | 0    | 0    | 0    | 0    | 0    | 0    | 0    | 0    | 0    | 0    |
| 2004 | 0    | 0    | 0    | 0    | 0    | 0    | 0    | 0    | 0    | 0    | 0    | 0    |
| 2005 | 0    | 0    | 0    | 0    | 0    | 0    | 0    | 0    | 0    | 0    | 0    | 0    |
| 2006 | 0    | 0    | 0    | 0    | 0    | 0    | 0    | 0    | 0    | 0    | 0    | 0    |
| 2007 | 0    | 0    | 0    | 0    | 0    | 0    | 0    | 0    | 0    | 0    | 0    | 0    |
| 2008 | 0    | 0    | 0    | 0    | 0    | 0    | 0    | 0    | 0    | 0    | 0    | 0    |
| 2009 | 0    | 0    | 0    | 0    | 0    | 0    | 0    | 0    | 0    | 0    | 0    | 0    |
| 2010 | 0    | 0    | 0    | 0    | 0    | 0    | 0    | 0    | 0    | 0    | 0    | 0    |
| 2011 | 0    | 0    | 0    | 0    | 0    | 0    | 0    | 0    | 0    | 0    | 0    | 0    |
| 2012 | 0    | 0    | 0    | 0    | 0    | 0    | 0    | 0    | 0    | 0    | 0    | 0    |
| 2013 | 0    | 0    | 0    | 0    | 0    | 0    | 0    | 0    | 0    | 0    | 0    | 0    |
| 2014 | 0    | 0    | 0    | 0    | 0    | 0    | 0    | 0    | 0    | 0    | 0    | 0    |
| 2015 | 0    | 0    | 0    | 0    | 0    | 0    | 0    | 0    | 0    | 0    | 0    | 0    |
| 2016 | 0    | 0    | 0    | 0    | 0    | 0    | 0    | 0    | 0    | 0    | 0    | 0    |
| 2017 | 0    | 0    | 0    | 0    | 0    | 0    | 0    | 0    | 0    | 0    | 0    | 0    |
| 2018 | 0    | 0    | 0    | 0    | 0    | 0    | 0    | 0    | 0    | 0    | 0    | 0    |
| 2019 | 0    | 0    | 0    | 0    | 0    | 0    | 0    | 0    | 0    | 0    | 0    | 0    |
| 2020 | 0    | 0    | 0    | 0    | 0    | 0    | 0    | 0    | 0    | 0    | 0    | 0    |
| 2021 | 0    | 0    | 0    | 0    | 0    | 0    | 0    | 0    | 0    | 0    | 0    | 0    |
| 2022 | 0    | 0    | 0    | 0    | 0    | 0    | 0    | 0    | 0    | 0    | 0    | 0    |
| 2023 | 0    | 0    | 0    | 0    | 0    | 0    | 0    | 0    | 0    | 0    | 0    | 0    |
| 2024 | 0    | 0    | 0    | 0    | 0    | 0    | 0    | 0    | 0    | 0    | 0    | 0    |
| 2025 | 0    | 0    | 0    | 0    | 0    | 0    | 0    | 0    | 0    | 0    | 0    | 0    |
| 2026 | 0    | 0    | 0    | 0    | 0    | 0    | 0    | 0    | 0    | 0    | 0    | 0    |
| 2027 | 0    | 0    | 0    | 0    | 0    | 0    | 0    | 0    | 0    | 0    | 0    | 0    |
| 2028 | 0    | 0    | 0    | 0    | 0    | 0    | 0    | 0    | 0    | 0    | 0    | 0    |
| 2029 | 0    | 0    | 0    | 0    | 0    | 0    | 0    | 0    | 0    | 0    | 0    | 0    |
| 2030 | 0    | 0    | 0    | 0    | 0    | 0    | 0    | 0    | 0    | 0    | 0    | 0    |
| 2031 | 0    | 0    | 0    | 0    | 0    | 0    | 0    | 0    | 0    | 0    | 0    | 0    |
| 2032 | 0    | 0    | 0    | 0    | 0    | 0    | 0    | 0    | 0    | 0    | 0    | 0    |
| 2033 | 0    | 0    | 0    | 0    | 0    | 0    | 0    | 0    | 0    | 0    | 0    | 0    |
| 2034 | 0    | 0    | 0    | 0    | 0    | 0    | 0    | 0    | 0    | 0    | 0    | 0    |
| 2035 | 0    | 0    | 0    | 0    | 0    | 0    | 0    | 0    | 0    | 0    | 0    | 0    |
| 2036 | 0    | 0    | 0    | 0    | 0    | 0    | 0    | 0    | 0    | 0    | 0    | 0    |
| 2037 | 0    | 0    | 0    | 0    | 0    | 0    | 0    | 0    | 0    | 0    | 0    | 0    |
| 2038 | 0    | 0    | 0    | 0    | 0    | 0    | 0    | 0    | 0    | 0    | 0    | 0    |
| 2039 | 0    | 0    | 0    | 0    | 0    | 0    | 0    | 0    | 0    | 0    | 0    | 0    |
| 2040 | 0    | 0    | 0    | 0    | 0    | 0    | 0    | 0    | 0    | 0    | 0    | 0    |
| 2041 | 0    | 0    | 0    | 0    | 0    | 0    | 0    | 0    | 0    | 0    | 0    | 0    |
| 2042 | 0    | 0    | 0    | 0    | 0    | 0    | 0    | 0    | 0    | 0    | 0    | 0    |
| 2043 | 0    | 0    | 0    | 0    | 0    | 0    | 0    | 0    | 0    | 0    | 0    | 0    |
| 2044 | 0    | 0    | 0    | 0    | 0    | 0    | 0    | 0    | 0    | 40   | 0    | 0    |
| 2045 | 0    | 0    | 0    | 0    | 0    | 0    | 0    | 0    | 0    | 391  | 0    | 0    |
| 2046 | 0    | 0    | 0    | 0    | 0    | 0    | 0    | 0    | 0    | 739  | 2    | 1    |
| 2047 | 1    | 0    | 0    | 0    | 0    | 0    | 421  | 421  | 1    | 1033 | 394  | 391  |
| 2048 | 373  | 421  | 29   | 0    | 0    | 0    | 764  | 763  | 406  | 1275 | 735  | 738  |
| 2049 | 739  | 763  | 405  | 420  | 420  | 420  | 1010 | 1009 | 684  | 1440 | 980  | 983  |
| 2050 | 1031 | 1009 | 746  | 762  | 762  | 762  | 1200 | 1199 | 871  | 1554 | 1170 | 1174 |
| 2051 | 1266 | 1199 | 998  | 1008 | 1008 | 1008 | 1384 | 1383 | 1038 | 1653 | 1354 | 1359 |
| 2052 | 1472 | 1383 | 1186 | 1198 | 1198 | 1198 | 1498 | 1497 | 1140 | 1714 | 1468 | 1473 |
| 2053 | 1636 | 1497 | 1352 | 1382 | 1382 | 1382 | 1546 | 1545 | 1184 | 1762 | 1516 | 1521 |
| 2054 | 1761 | 1545 | 1460 | 1496 | 1496 | 1496 | 1583 | 1582 | 1220 | 1801 | 1553 | 1558 |
| 2055 | 1833 | 1582 | 1513 | 1544 | 1544 | 1544 | 1619 | 1618 | 1256 | 1835 | 1590 | 1594 |
| 2056 | 1880 | 1618 | 1550 | 1581 | 1581 | 1581 | 1659 | 1657 | 1277 | 1859 | 1639 | 1633 |
| 2057 | 1920 | 1657 | 1586 | 1617 | 1617 | 1617 | 1694 | 1691 | 1292 | 1883 | 1673 | 1664 |
| 2058 | 1956 | 1691 | 1623 | 1656 | 1656 | 1656 | 1706 | 1703 | 1294 | 1895 | 1685 | 1676 |
| 2059 | 1992 | 1703 | 1655 | 1690 | 1690 | 1690 | 1709 | 1706 | 1294 | 1896 | 1688 | 1679 |
| 2060 | 2026 | 1706 | 1669 | 1702 | 1702 | 1702 | 1710 | 1707 | 1294 | 1897 | 1689 | 1680 |
| 2061 | 2042 | 1707 | 1672 | 1705 | 1705 | 1705 | 1710 | 1707 | 1294 | 1897 | 1689 | 1680 |
| 2062 | 2047 | 1707 | 1673 | 1706 | 1706 | 1706 | 1710 | 1707 | 1294 | 1897 | 1689 | 1680 |
| 2063 | 2047 | 1707 | 1673 | 1706 | 1706 | 1706 | 1710 | 1707 | 1294 | 1897 | 1689 | 1680 |
| 2064 | 2047 | 1707 | 1673 | 1706 | 1706 | 1706 | 1710 | 1707 | 1294 | 1897 | 1689 | 1680 |
| 2065 | 2047 | 1707 | 1673 | 1706 | 1706 | 1706 | 1710 | 1707 | 1294 | 1897 | 1689 | 1680 |
| 2066 | 2047 | 1707 | 1673 | 1706 | 1706 | 1706 | 1710 | 1707 | 1294 | 1897 | 1689 | 1680 |
| 2067 | 2047 | 1707 | 1673 | 1706 | 1706 | 1706 | 1710 | 1707 | 1294 | 1897 | 1689 | 1680 |
| 2068 | 2047 | 1707 | 1673 | 1706 | 1706 | 1706 | 1710 | 1707 | 1294 | 1897 | 1689 | 1680 |

|      | 13   | 14   | 15   | 16   | 17   | 18   | 19   | 20   | 21   | 22   | 23   | 24   |
|------|------|------|------|------|------|------|------|------|------|------|------|------|
| 2069 | 2047 | 1707 | 1673 | 1706 | 1706 | 1706 | 1710 | 1707 | 1294 | 1897 | 1689 | 1680 |
| 2070 | 2047 | 1707 | 1673 | 1706 | 1706 | 1706 | 1710 | 1707 | 1294 | 1897 | 1689 | 1680 |
| 2071 | 2047 | 1707 | 1673 | 1706 | 1706 | 1706 | 1710 | 1707 | 1294 | 1897 | 1689 | 1680 |
| 2072 | 2047 | 1707 | 1673 | 1706 | 1706 | 1706 | 1710 | 1707 | 1294 | 1897 | 1689 | 1680 |
| 2073 | 2047 | 1707 | 1673 | 1706 | 1706 | 1706 | 1710 | 1707 | 1294 | 1897 | 1689 | 1680 |
| 2074 | 2047 | 1707 | 1673 | 1706 | 1706 | 1706 | 1710 | 1707 | 1294 | 1897 | 1689 | 1680 |
| 2075 | 2047 | 1707 | 1673 | 1706 | 1706 | 1706 | 1710 | 1707 | 1294 | 1897 | 1689 | 1680 |
| 2076 | 2047 | 1707 | 1673 | 1706 | 1706 | 1706 | 1710 | 1707 | 1294 | 1897 | 1689 | 1680 |
| 2077 | 2047 | 1707 | 1673 | 1706 | 1706 | 1706 | 1710 | 1707 | 1294 | 1897 | 1689 | 1680 |
| 2078 | 2047 | 1707 | 1673 | 1706 | 1706 | 1706 | 1710 | 1707 | 1294 | 1897 | 1689 | 1680 |
| 2079 | 2047 | 1707 | 1673 | 1706 | 1706 | 1706 | 1710 | 1707 | 1294 | 1897 | 1689 | 1680 |
| 2080 | 2047 | 1707 | 1673 | 1706 | 1706 | 1706 | 1710 | 1707 | 1294 | 1897 | 1689 | 1680 |
| 2081 | 2047 | 1707 | 1673 | 1706 | 1706 | 1706 | 1710 | 1707 | 1294 | 1897 | 1689 | 1680 |
| 2082 | 2047 | 1707 | 1673 | 1706 | 1706 | 1706 | 1710 | 1707 | 1294 | 1897 | 1689 | 1680 |
| 2083 | 2047 | 1707 | 1673 | 1706 | 1706 | 1706 | 1710 | 1707 | 1294 | 1897 | 1689 | 1680 |
| 2084 | 2047 | 1707 | 1673 | 1706 | 1706 | 1706 | 1710 | 1707 | 1294 | 1897 | 1689 | 1680 |
| 2085 | 2047 | 1707 | 1673 | 1706 | 1706 | 1706 | 1710 | 1707 | 1294 | 1897 | 1689 | 1680 |
| 2086 | 2047 | 1707 | 1673 | 1706 | 1706 | 1706 | 1710 | 1707 | 1294 | 1897 | 1689 | 1680 |
| 2087 | 2047 | 1707 | 1673 | 1706 | 1706 | 1706 | 1710 | 1707 | 1294 | 1897 | 1689 | 1680 |
| 2088 | 2047 | 1707 | 1673 | 1706 | 1706 | 1706 | 1710 | 1707 | 1294 | 1897 | 1689 | 1680 |
| 2089 | 2047 | 1707 | 1673 | 1706 | 1706 | 1706 | 1710 | 1707 | 1294 | 1897 | 1689 | 1680 |
| 2090 | 2047 | 1707 | 1673 | 1706 | 1706 | 1706 | 1710 | 1707 | 1294 | 1897 | 1689 | 1680 |

|      | 25   | 26   | 27   | 28   | 29   | 30   | 31   | 32   | 33   | 34   | 35   | 36   |
|------|------|------|------|------|------|------|------|------|------|------|------|------|
| 2002 | 0    | 0    | 0    | 0    | 0    | 0    | 0    | 0    | 0    | 0    | 0    | 0    |
| 2003 | 0    | 0    | 0    | 0    | 0    | 0    | 0    | 0    | 0    | 0    | 0    | 0    |
| 2004 | 0    | 0    | 0    | 0    | 0    | 0    | 0    | 0    | 0    | 0    | 0    | 0    |
| 2005 | 0    | 0    | 0    | 0    | 0    | 0    | 0    | 0    | 0    | 0    | 0    | 0    |
| 2006 | 0    | 0    | 0    | 0    | 0    | 0    | 0    | 0    | 0    | 0    | 0    | 0    |
| 2007 | 0    | 0    | 0    | 0    | 0    | 0    | 0    | 0    | 0    | 0    | 0    | 0    |
| 2008 | 0    | 0    | 0    | 0    | 0    | 0    | 0    | 0    | 0    | 0    | 0    | 0    |
| 2009 | 0    | 0    | 0    | 0    | 0    | 0    | 0    | 0    | 0    | 0    | 0    | 0    |
| 2010 | 0    | 0    | 0    | 0    | 0    | 0    | 0    | 0    | 0    | 0    | 0    | 0    |
| 2011 | 0    | 0    | 0    | 0    | 0    | 0    | 0    | 0    | 0    | 0    | 0    | 0    |
| 2012 | 0    | 0    | 0    | 0    | 0    | 0    | 0    | 0    | 0    | 0    | 0    | 0    |
| 2013 | 0    | 0    | 0    | 0    | 0    | 0    | 0    | 0    | 0    | 0    | 0    | 0    |
| 2014 | 0    | 0    | 0    | 0    | 0    | 0    | 0    | 0    | 0    | 0    | 0    | 0    |
| 2015 | 0    | 0    | 0    | 0    | 0    | 0    | 0    | 0    | 0    | 0    | 0    | 0    |
| 2016 | 0    | 0    | 0    | 0    | 0    | 0    | 0    | 0    | 0    | 0    | 0    | 0    |
| 2017 | 0    | 0    | 0    | 0    | 0    | 0    | 0    | 0    | 0    | 0    | 0    | 0    |
| 2018 | 0    | 0    | 0    | 0    | 0    | 0    | 0    | 0    | 0    | 0    | 0    | 0    |
| 2019 | 0    | 0    | 0    | 0    | 0    | 0    | 0    | 0    | 0    | 0    | 0    | 0    |
| 2020 | 0    | 0    | 0    | 0    | 0    | 0    | 0    | 0    | 0    | 0    | 0    | 0    |
| 2021 | 0    | 0    | 0    | 0    | 0    | 0    | 0    | 0    | 0    | 0    | 0    | 0    |
| 2022 | 0    | 0    | 0    | 0    | 0    | 0    | 0    | 0    | 0    | 0    | 0    | 0    |
| 2023 | 0    | 0    | 0    | 0    | 0    | 0    | 0    | 0    | 0    | 0    | 0    | 0    |
| 2024 | 0    | 0    | 0    | 0    | 0    | 0    | 0    | 0    | 0    | 0    | 0    | 0    |
| 2025 | 0    | 0    | 0    | 0    | 0    | 0    | 0    | 0    | 0    | 0    | 0    | 0    |
| 2026 | 0    | 0    | 0    | 0    | 0    | 0    | 0    | 0    | 0    | 0    | 0    | 0    |
| 2027 | 0    | 0    | 0    | 0    | 0    | 0    | 0    | 0    | 0    | 0    | 0    | 0    |
| 2028 | 0    | 0    | 0    | 0    | 0    | 0    | 0    | 0    | 0    | 0    | 0    | 0    |
| 2029 | 0    | 0    | 0    | 0    | 0    | 0    | 0    | 0    | 0    | 0    | 0    | 0    |
| 2030 | 0    | 0    | 0    | 0    | 0    | 0    | 0    | 0    | 0    | 0    | 0    | 0    |
| 2031 | 0    | 0    | 0    | 0    | 0    | 0    | 0    | 0    | 0    | 0    | 0    | 0    |
| 2032 | 0    | 0    | 0    | 0    | 0    | 0    | 0    | 0    | 0    | 0    | 0    | 0    |
| 2033 | 0    | 0    | 0    | 0    | 0    | 0    | 0    | 0    | 0    | 0    | 0    | 0    |
| 2034 | 0    | 0    | 0    | 0    | 0    | 0    | 0    | 0    | 0    | 0    | 0    | 0    |
| 2035 | 0    | 0    | 0    | 0    | 0    | 0    | 0    | 0    | 0    | 0    | 0    | 0    |
| 2036 | 0    | 0    | 0    | 0    | 0    | 0    | 0    | 0    | 0    | 0    | 0    | 0    |
| 2037 | 0    | 0    | 0    | 0    | 0    | 0    | 0    | 0    | 0    | 0    | 0    | 0    |
| 2038 | 0    | 0    | 0    | 0    | 0    | 0    | 0    | 0    | 0    | 0    | 0    | 0    |
| 2039 | 0    | 0    | 0    | 0    | 0    | 0    | 0    | 0    | 0    | 0    | 0    | 0    |
| 2040 | 0    | 0    | 0    | 0    | 0    | 0    | 0    | 0    | 0    | 0    | 0    | 0    |
| 2041 | 0    | 0    | 0    | 0    | 0    | 0    | 5    | 0    | 0    | 0    | 0    | 0    |
| 2042 | 0    | 0    | 0    | 0    | 0    | 0    | 640  | 0    | 0    | 0    | 0    | 0    |
| 2043 | 0    | 0    | 0    | 65   | 72   | 0    | 1056 | 29   | 20   | 66   | 66   | 66   |
| 2044 | 0    | 0    | 0    | 722  | 720  | 0    | 1302 | 682  | 694  | 707  | 707  | 707  |
| 2045 | 0    | 0    | 0    | 1121 | 1107 | 27   | 1414 | 1067 | 1109 | 1093 | 1093 | 1093 |
| 2046 | 0    | 0    | 0    | 1304 | 1289 | 794  | 1476 | 1253 | 1302 | 1275 | 1275 | 1275 |
| 2047 | 421  | 421  | 421  | 1391 | 1376 | 1139 | 1513 | 1340 | 1389 | 1362 | 1362 | 1362 |
| 2048 | 763  | 763  | 763  | 1472 | 1459 | 1300 | 1564 | 1428 | 1469 | 1446 | 1446 | 1446 |
| 2049 | 1009 | 1009 | 1009 | 1483 | 1470 | 1388 | 1573 | 1438 | 1480 | 1456 | 1456 | 1456 |
| 2050 | 1199 | 1199 | 1199 | 1492 | 1479 | 1401 | 1582 | 1447 | 1490 | 1465 | 1465 | 1465 |
| 2051 | 1383 | 1383 | 1383 | 1507 | 1494 | 1417 | 1597 | 1462 | 1506 | 1480 | 1480 | 1480 |
| 2052 | 1497 | 1497 | 1497 | 1512 | 1499 | 1422 | 1602 | 1467 | 1511 | 1485 | 1485 | 1485 |
| 2053 | 1545 | 1545 | 1545 | 1512 | 1499 | 1422 | 1602 | 1467 | 1511 | 1485 | 1485 | 1485 |
| 2054 | 1582 | 1582 | 1582 | 1525 | 1512 | 1435 | 1615 | 1480 | 1524 | 1498 | 1498 | 1498 |
| 2055 | 1618 | 1618 | 1618 | 1527 | 1514 | 1437 | 1617 | 1482 | 1526 | 1500 | 1500 | 1500 |
| 2056 | 1657 | 1657 | 1657 | 1537 | 1524 | 1447 | 1627 | 1492 | 1536 | 1510 | 1510 | 1510 |
| 2057 | 1691 | 1691 | 1691 | 1537 | 1524 | 1447 | 1627 | 1492 | 1536 | 1510 | 1510 | 1510 |
| 2058 | 1703 | 1703 | 1703 | 1537 | 1524 | 1447 | 1627 | 1492 | 1536 | 1510 | 1510 | 1510 |
| 2059 | 1706 | 1706 | 1706 | 1537 | 1524 | 1447 | 1627 | 1492 | 1536 | 1510 | 1510 | 1510 |
| 2060 | 1707 | 1707 | 1707 | 1537 | 1524 | 1447 | 1627 | 1492 | 1536 | 1510 | 1510 | 1510 |
| 2061 | 1707 | 1707 | 1707 | 1537 | 1524 | 1447 | 1627 | 1492 | 1536 | 1510 | 1510 | 1510 |
| 2062 | 1707 | 1707 | 1707 | 1537 | 1524 | 1447 | 1627 | 1492 | 1536 | 1510 | 1510 | 1510 |
| 2063 | 1707 | 1707 | 1707 | 1537 | 1524 | 1447 | 1627 | 1492 | 1536 | 1510 | 1510 | 1510 |
| 2064 | 1707 | 1707 | 1707 | 1537 | 1524 | 1447 | 1627 | 1492 | 1536 | 1510 | 1510 | 1510 |
| 2065 | 1707 | 1707 | 1707 | 1537 | 1524 | 1447 | 1627 | 1492 | 1536 | 1510 | 1510 | 1510 |
| 2066 | 1707 | 1707 | 1707 | 1537 | 1524 | 1447 | 1627 | 1492 | 1536 | 1510 | 1510 | 1510 |
| 2067 | 1707 | 1707 | 1707 | 1537 | 1524 | 1447 | 1627 | 1492 | 1536 | 1510 | 1510 | 1510 |
| 2068 | 1707 | 1707 | 1707 | 1537 | 1524 | 1447 | 1627 | 1492 | 1536 | 1510 | 1510 | 1510 |

|      | 25   | 26   | 27   | 28   | 29   | 30   | 31   | 32   | 33   | 34   | 35   | 36   |
|------|------|------|------|------|------|------|------|------|------|------|------|------|
| 2069 | 1707 | 1707 | 1707 | 1537 | 1524 | 1447 | 1627 | 1492 | 1536 | 1510 | 1510 | 1510 |
| 2070 | 1707 | 1707 | 1707 | 1537 | 1524 | 1447 | 1627 | 1492 | 1536 | 1510 | 1510 | 1510 |
| 2071 | 1707 | 1707 | 1707 | 1537 | 1524 | 1447 | 1627 | 1492 | 1536 | 1510 | 1510 | 1510 |
| 2072 | 1707 | 1707 | 1707 | 1537 | 1524 | 1447 | 1627 | 1492 | 1536 | 1510 | 1510 | 1510 |
| 2073 | 1707 | 1707 | 1707 | 1537 | 1524 | 1447 | 1627 | 1492 | 1536 | 1510 | 1510 | 1510 |
| 2074 | 1707 | 1707 | 1707 | 1537 | 1524 | 1447 | 1627 | 1492 | 1536 | 1510 | 1510 | 1510 |
| 2075 | 1707 | 1707 | 1707 | 1537 | 1524 | 1447 | 1627 | 1492 | 1536 | 1510 | 1510 | 1510 |
| 2076 | 1707 | 1707 | 1707 | 1537 | 1524 | 1447 | 1627 | 1492 | 1536 | 1510 | 1510 | 1510 |
| 2077 | 1707 | 1707 | 1707 | 1537 | 1524 | 1447 | 1627 | 1492 | 1536 | 1510 | 1510 | 1510 |
| 2078 | 1707 | 1707 | 1707 | 1537 | 1524 | 1447 | 1627 | 1492 | 1536 | 1510 | 1510 | 1510 |
| 2079 | 1707 | 1707 | 1707 | 1537 | 1524 | 1447 | 1627 | 1492 | 1536 | 1510 | 1510 | 1510 |
| 2080 | 1707 | 1707 | 1707 | 1537 | 1524 | 1447 | 1627 | 1492 | 1536 | 1510 | 1510 | 1510 |
| 2081 | 1707 | 1707 | 1707 | 1537 | 1524 | 1447 | 1627 | 1492 | 1536 | 1510 | 1510 | 1510 |
| 2082 | 1707 | 1707 | 1707 | 1537 | 1524 | 1447 | 1627 | 1492 | 1536 | 1510 | 1510 | 1510 |
| 2083 | 1707 | 1707 | 1707 | 1537 | 1524 | 1447 | 1627 | 1492 | 1536 | 1510 | 1510 | 1510 |
| 2084 | 1707 | 1707 | 1707 | 1537 | 1524 | 1447 | 1627 | 1492 | 1536 | 1510 | 1510 | 1510 |
| 2085 | 1707 | 1707 | 1707 | 1537 | 1524 | 1447 | 1627 | 1492 | 1536 | 1510 | 1510 | 1510 |
| 2086 | 1707 | 1707 | 1707 | 1537 | 1524 | 1447 | 1627 | 1492 | 1536 | 1510 | 1510 | 1510 |
| 2087 | 1707 | 1707 | 1707 | 1537 | 1524 | 1447 | 1627 | 1492 | 1536 | 1510 | 1510 | 1510 |
| 2088 | 1707 | 1707 | 1707 | 1537 | 1524 | 1447 | 1627 | 1492 | 1536 | 1510 | 1510 | 1510 |
| 2089 | 1707 | 1707 | 1707 | 1537 | 1524 | 1447 | 1627 | 1492 | 1536 | 1510 | 1510 | 1510 |
| 2090 | 1707 | 1707 | 1707 | 1537 | 1524 | 1447 | 1627 | 1492 | 1536 | 1510 | 1510 | 1510 |

|      | 37   | 38   | 39   | 40   | 41   | 42   | 43   | 44   | 45   | 46   | 47   | 48   |
|------|------|------|------|------|------|------|------|------|------|------|------|------|
| 2002 | 0    | 0    | 0    | 0    | 0    | 0    | 0    | 0    | 0    | 0    | 0    | 0    |
| 2003 | 0    | 0    | 0    | 0    | 0    | 0    | 0    | 0    | 0    | 0    | 0    | 0    |
| 2004 | 0    | 0    | 0    | 0    | 0    | 0    | 0    | 0    | 0    | 0    | 0    | 0    |
| 2005 | 0    | 0    | 0    | 0    | 0    | 0    | 0    | 0    | 0    | 0    | 0    | 0    |
| 2006 | 0    | 0    | 0    | 0    | 0    | 0    | 0    | 0    | 0    | 0    | 0    | 0    |
| 2007 | 0    | 0    | 0    | 0    | 0    | 0    | 0    | 0    | 0    | 0    | 0    | 0    |
| 2008 | 0    | 0    | 0    | 0    | 0    | 0    | 0    | 0    | 0    | 0    | 0    | 0    |
| 2009 | 0    | 0    | 0    | 0    | 0    | 0    | 0    | 0    | 0    | 0    | 0    | 0    |
| 2010 | 0    | 0    | 0    | 0    | 0    | 0    | 0    | 0    | 0    | 0    | 0    | 0    |
| 2011 | 0    | 0    | 0    | 0    | 0    | 0    | 0    | 0    | 0    | 0    | 0    | 0    |
| 2012 | 0    | 0    | 0    | 0    | 0    | 0    | 0    | 0    | 0    | 0    | 0    | 0    |
| 2013 | 0    | 0    | 0    | 0    | 0    | 0    | 0    | 0    | 0    | 0    | 0    | 0    |
| 2014 | 0    | 0    | 0    | 0    | 0    | 0    | 0    | 0    | 0    | 0    | 0    | 0    |
| 2015 | 0    | 0    | 0    | 0    | 0    | 0    | 0    | 0    | 0    | 0    | 0    | 0    |
| 2016 | 0    | 0    | 0    | 0    | 0    | 0    | 0    | 0    | 0    | 0    | 0    | 0    |
| 2017 | 0    | 0    | 0    | 0    | 0    | 0    | 0    | 0    | 0    | 0    | 0    | 0    |
| 2018 | 0    | 0    | 0    | 0    | 0    | 0    | 0    | 0    | 0    | 0    | 0    | 0    |
| 2019 | 0    | 0    | 0    | 0    | 0    | 0    | 0    | 0    | 0    | 0    | 0    | 0    |
| 2020 | 0    | 0    | 0    | 0    | 0    | 0    | 0    | 0    | 0    | 0    | 0    | 0    |
| 2021 | 0    | 0    | 0    | 0    | 0    | 0    | 0    | 0    | 0    | 0    | 0    | 0    |
| 2022 | 0    | 0    | 0    | 0    | 0    | 0    | 0    | 0    | 0    | 0    | 0    | 0    |
| 2023 | 0    | 0    | 0    | 0    | 0    | 0    | 0    | 0    | 0    | 0    | 0    | 0    |
| 2024 | 0    | 0    | 0    | 0    | 0    | 0    | 0    | 0    | 0    | 0    | 0    | 0    |
| 2025 | 0    | 0    | 0    | 0    | 0    | 0    | 0    | 0    | 0    | 0    | 0    | 0    |
| 2026 | 0    | 0    | 0    | 0    | 0    | 0    | 0    | 0    | 0    | 0    | 0    | 0    |
| 2027 | 0    | 0    | 0    | 0    | 0    | 0    | 0    | 0    | 0    | 0    | 0    | 0    |
| 2028 | 0    | 0    | 0    | 0    | 0    | 0    | 0    | 0    | 0    | 0    | 0    | 0    |
| 2029 | 0    | 0    | 0    | 0    | 0    | 0    | 0    | 0    | 0    | 0    | 0    | 0    |
| 2030 | 0    | 0    | 0    | 0    | 0    | 0    | 0    | 0    | 0    | 0    | 0    | 0    |
| 2031 | 0    | 0    | 0    | 0    | 0    | 0    | 0    | 0    | 0    | 0    | 0    | 0    |
| 2032 | 0    | 0    | 0    | 0    | 0    | 0    | 0    | 0    | 0    | 0    | 0    | 0    |
| 2033 | 0    | 0    | 0    | 0    | 0    | 0    | 0    | 0    | 0    | 0    | 0    | 0    |
| 2034 | 0    | 0    | 0    | 0    | 0    | 0    | 0    | 0    | 0    | 0    | 0    | 0    |
| 2035 | 0    | 0    | 0    | 0    | 0    | 0    | 0    | 0    | 0    | 0    | 0    | 0    |
| 2036 | 0    | 0    | 0    | 0    | 0    | 0    | 0    | 0    | 0    | 0    | 0    | 0    |
| 2037 | 0    | 0    | 0    | 0    | 0    | 0    | 0    | 0    | 0    | 0    | 0    | 0    |
| 2038 | 0    | 0    | 0    | 0    | 0    | 0    | 0    | 0    | 0    | 0    | 0    | 0    |
| 2039 | 0    | 0    | 0    | 0    | 0    | 0    | 0    | 0    | 0    | 0    | 0    | 0    |
| 2040 | 0    | 0    | 0    | 0    | 0    | 0    | 0    | 0    | 0    | 0    | 0    | 0    |
| 2041 | 0    | 0    | 0    | 0    | 0    | 0    | 0    | 0    | 0    | 0    | 0    | 0    |
| 2042 | 0    | 0    | 0    | 0    | 0    | 0    | 0    | 0    | 0    | 0    | 0    | 0    |
| 2043 | 0    | 0    | 0    | 0    | 0    | 0    | 0    | 0    | 0    | 0    | 0    | 0    |
| 2044 | 0    | 0    | 0    | 0    | 0    | 0    | 0    | 0    | 0    | 0    | 0    | 0    |
| 2045 | 0    | 0    | 0    | 0    | 0    | 0    | 0    | 0    | 0    | 0    | 0    | 0    |
| 2046 | 0    | 0    | 0    | 0    | 0    | 0    | 0    | 0    | 0    | 0    | 0    | 0    |
| 2047 | 0    | 0    | 0    | 2    | 0    | 0    | 0    | 0    | 0    | 421  | 421  | 0    |
| 2048 | 0    | 0    | 404  | 370  | 421  | 379  | 1    | 1    | 1    | 764  | 764  | 405  |
| 2049 | 416  | 421  | 682  | 716  | 763  | 720  | 419  | 419  | 419  | 1010 | 1010 | 683  |
| 2050 | 759  | 763  | 869  | 1007 | 1009 | 966  | 761  | 761  | 761  | 1200 | 1200 | 870  |
| 2051 | 1005 | 1009 | 1036 | 1243 | 1199 | 1157 | 1007 | 1007 | 1007 | 1384 | 1384 | 1037 |
| 2052 | 1195 | 1199 | 1138 | 1424 | 1383 | 1338 | 1197 | 1197 | 1197 | 1498 | 1498 | 1139 |
| 2053 | 1379 | 1383 | 1182 | 1572 | 1497 | 1448 | 1381 | 1381 | 1381 | 1546 | 1546 | 1183 |
| 2054 | 1493 | 1497 | 1218 | 1696 | 1545 | 1496 | 1495 | 1495 | 1495 | 1583 | 1583 | 1219 |
| 2055 | 1541 | 1545 | 1254 | 1768 | 1582 | 1533 | 1543 | 1543 | 1543 | 1619 | 1619 | 1255 |
| 2056 | 1578 | 1582 | 1275 | 1816 | 1618 | 1569 | 1580 | 1580 | 1580 | 1658 | 1662 | 1276 |
| 2057 | 1614 | 1618 | 1290 | 1855 | 1657 | 1608 | 1616 | 1616 | 1616 | 1692 | 1697 | 1291 |
| 2058 | 1653 | 1657 | 1292 | 1891 | 1691 | 1642 | 1655 | 1655 | 1655 | 1704 | 1709 | 1293 |
| 2059 | 1687 | 1691 | 1292 | 1916 | 1703 | 1654 | 1689 | 1689 | 1689 | 1707 | 1712 | 1293 |
| 2060 | 1699 | 1703 | 1292 | 1940 | 1706 | 1657 | 1701 | 1701 | 1701 | 1708 | 1713 | 1293 |
| 2061 | 1702 | 1706 | 1292 | 1955 | 1707 | 1658 | 1704 | 1704 | 1704 | 1708 | 1713 | 1293 |
| 2062 | 1703 | 1707 | 1292 | 1960 | 1707 | 1658 | 1705 | 1705 | 1705 | 1708 | 1713 | 1293 |
| 2063 | 1703 | 1707 | 1292 | 1960 | 1707 | 1658 | 1705 | 1705 | 1705 | 1708 | 1713 | 1293 |
| 2064 | 1703 | 1707 | 1292 | 1960 | 1707 | 1658 | 1705 | 1705 | 1705 | 1708 | 1713 | 1293 |
| 2065 | 1703 | 1707 | 1292 | 1960 | 1707 | 1658 | 1705 | 1705 | 1705 | 1708 | 1713 | 1293 |
| 2066 | 1703 | 1707 | 1292 | 1960 | 1707 | 1658 | 1705 | 1705 | 1705 | 1708 | 1713 | 1293 |
| 2067 | 1703 | 1707 | 1292 | 1960 | 1707 | 1658 | 1705 | 1705 | 1705 | 1708 | 1713 | 1293 |
| 2068 | 1703 | 1707 | 1292 | 1960 | 1707 | 1658 | 1705 | 1705 | 1705 | 1708 | 1713 | 1293 |

|      | 37   | 38   | 39   | 40   | 41   | 42   | 43   | 44   | 45   | 46   | 47   | 48   |
|------|------|------|------|------|------|------|------|------|------|------|------|------|
| 2069 | 1703 | 1707 | 1292 | 1960 | 1707 | 1658 | 1705 | 1705 | 1705 | 1708 | 1713 | 1293 |
| 2070 | 1703 | 1707 | 1292 | 1960 | 1707 | 1658 | 1705 | 1705 | 1705 | 1708 | 1713 | 1293 |
| 2071 | 1703 | 1707 | 1292 | 1960 | 1707 | 1658 | 1705 | 1705 | 1705 | 1708 | 1713 | 1293 |
| 2072 | 1703 | 1707 | 1292 | 1960 | 1707 | 1658 | 1705 | 1705 | 1705 | 1708 | 1713 | 1293 |
| 2073 | 1703 | 1707 | 1292 | 1960 | 1707 | 1658 | 1705 | 1705 | 1705 | 1708 | 1713 | 1293 |
| 2074 | 1703 | 1707 | 1292 | 1960 | 1707 | 1658 | 1705 | 1705 | 1705 | 1708 | 1713 | 1293 |
| 2075 | 1703 | 1707 | 1292 | 1960 | 1707 | 1658 | 1705 | 1705 | 1705 | 1708 | 1713 | 1293 |
| 2076 | 1703 | 1707 | 1292 | 1960 | 1707 | 1658 | 1705 | 1705 | 1705 | 1708 | 1713 | 1293 |
| 2077 | 1703 | 1707 | 1292 | 1960 | 1707 | 1658 | 1705 | 1705 | 1705 | 1708 | 1713 | 1293 |
| 2078 | 1703 | 1707 | 1292 | 1960 | 1707 | 1658 | 1705 | 1705 | 1705 | 1708 | 1713 | 1293 |
| 2079 | 1703 | 1707 | 1292 | 1960 | 1707 | 1658 | 1705 | 1705 | 1705 | 1708 | 1713 | 1293 |
| 2080 | 1703 | 1707 | 1292 | 1960 | 1707 | 1658 | 1705 | 1705 | 1705 | 1708 | 1713 | 1293 |
| 2081 | 1703 | 1707 | 1292 | 1960 | 1707 | 1658 | 1705 | 1705 | 1705 | 1708 | 1713 | 1293 |
| 2082 | 1703 | 1707 | 1292 | 1960 | 1707 | 1658 | 1705 | 1705 | 1705 | 1708 | 1713 | 1293 |
| 2083 | 1703 | 1707 | 1292 | 1960 | 1707 | 1658 | 1705 | 1705 | 1705 | 1708 | 1713 | 1293 |
| 2084 | 1703 | 1707 | 1292 | 1960 | 1707 | 1658 | 1705 | 1705 | 1705 | 1708 | 1713 | 1293 |
| 2085 | 1703 | 1707 | 1292 | 1960 | 1707 | 1658 | 1705 | 1705 | 1705 | 1708 | 1713 | 1293 |
| 2086 | 1703 | 1707 | 1292 | 1960 | 1707 | 1658 | 1705 | 1705 | 1705 | 1708 | 1713 | 1293 |
| 2087 | 1703 | 1707 | 1292 | 1960 | 1707 | 1658 | 1705 | 1705 | 1705 | 1708 | 1713 | 1293 |
| 2088 | 1703 | 1707 | 1292 | 1960 | 1707 | 1658 | 1705 | 1705 | 1705 | 1708 | 1713 | 1293 |
| 2089 | 1703 | 1707 | 1292 | 1960 | 1707 | 1658 | 1705 | 1705 | 1705 | 1708 | 1713 | 1293 |
| 2090 | 1703 | 1707 | 1292 | 1960 | 1707 | 1658 | 1705 | 1705 | 1705 | 1708 | 1713 | 1293 |

|      | 49   | 50   | 51   | 52   | 53   | 54   | 55   | 56   | 57   | 58   | 59   | 60   |
|------|------|------|------|------|------|------|------|------|------|------|------|------|
| 2002 | 0    | 0    | 0    | 0    | 0    | 0    | 0    | 0    | 0    | 0    | 0    | 0    |
| 2003 | 0    | 0    | 0    | 0    | 0    | 0    | 0    | 0    | 0    | 0    | 0    | 0    |
| 2004 | 0    | 0    | 0    | 0    | 0    | 0    | 0    | 0    | 0    | 0    | 0    | 0    |
| 2005 | 0    | 0    | 0    | 0    | 0    | 0    | 0    | 0    | 0    | 0    | 0    | 0    |
| 2006 | 0    | 0    | 0    | 0    | 0    | 0    | 0    | 0    | 0    | 0    | 0    | 0    |
| 2007 | 0    | 0    | 0    | 0    | 0    | 0    | 0    | 0    | 0    | 0    | 0    | 0    |
| 2008 | 0    | 0    | 0    | 0    | 0    | 0    | 0    | 0    | 0    | 0    | 0    | 0    |
| 2009 | 0    | 0    | 0    | 0    | 0    | 0    | 0    | 0    | 0    | 0    | 0    | 0    |
| 2010 | 0    | 0    | 0    | 0    | 0    | 0    | 0    | 0    | 0    | 0    | 0    | 0    |
| 2011 | 0    | 0    | 0    | 0    | 0    | 0    | 0    | 0    | 0    | 0    | 0    | 0    |
| 2012 | 0    | 0    | 0    | 0    | 0    | 0    | 0    | 0    | 0    | 0    | 0    | 0    |
| 2013 | 0    | 0    | 0    | 0    | 0    | 0    | 0    | 0    | 0    | 0    | 0    | 0    |
| 2014 | 0    | 0    | 0    | 0    | 0    | 0    | 0    | 0    | 0    | 0    | 0    | 0    |
| 2015 | 0    | 0    | 0    | 0    | 0    | 0    | 0    | 0    | 0    | 0    | 0    | 0    |
| 2016 | 0    | 0    | 0    | 0    | 0    | 0    | 0    | 0    | 0    | 0    | 0    | 0    |
| 2017 | 0    | 0    | 0    | 0    | 0    | 0    | 0    | 0    | 0    | 0    | 0    | 0    |
| 2018 | 0    | 0    | 0    | 0    | 0    | 0    | 0    | 0    | 0    | 0    | 0    | 0    |
| 2019 | 0    | 0    | 0    | 0    | 0    | 0    | 0    | 0    | 0    | 0    | 0    | 0    |
| 2020 | 0    | 0    | 0    | 0    | 0    | 0    | 0    | 0    | 0    | 0    | 0    | 0    |
| 2021 | 0    | 0    | 0    | 0    | 0    | 0    | 0    | 0    | 0    | 0    | 0    | 0    |
| 2022 | 0    | 0    | 0    | 0    | 0    | 0    | 0    | 0    | 0    | 0    | 0    | 0    |
| 2023 | 0    | 0    | 0    | 0    | 0    | 0    | 0    | 0    | 0    | 0    | 0    | 0    |
| 2024 | 0    | 0    | 0    | 0    | 0    | 0    | 0    | 0    | 0    | 0    | 0    | 0    |
| 2025 | 0    | 0    | 0    | 0    | 0    | 0    | 0    | 0    | 0    | 0    | 0    | 0    |
| 2026 | 0    | 0    | 0    | 0    | 0    | 0    | 0    | 0    | 0    | 0    | 0    | 0    |
| 2027 | 0    | 0    | 0    | 0    | 0    | 0    | 0    | 0    | 0    | 0    | 0    | 0    |
| 2028 | 0    | 0    | 0    | 0    | 0    | 0    | 0    | 0    | 0    | 0    | 0    | 0    |
| 2029 | 0    | 0    | 0    | 0    | 0    | 0    | 0    | 0    | 0    | 0    | 0    | 0    |
| 2030 | 0    | 0    | 0    | 0    | 0    | 0    | 0    | 0    | 0    | 0    | 0    | 0    |
| 2031 | 0    | 0    | 0    | 0    | 0    | 0    | 0    | 0    | 0    | 0    | 0    | 0    |
| 2032 | 0    | 0    | 0    | 0    | 0    | 0    | 0    | 0    | 0    | 0    | 0    | 0    |
| 2033 | 0    | 0    | 0    | 0    | 0    | 0    | 0    | 0    | 0    | 0    | 0    | 0    |
| 2034 | 0    | 0    | 0    | 0    | 0    | 0    | 0    | 0    | 0    | 0    | 0    | 0    |
| 2035 | 0    | 0    | 0    | 0    | 0    | 0    | 0    | 0    | 0    | 0    | 0    | 0    |
| 2036 | 0    | 0    | 0    | 0    | 0    | 0    | 0    | 0    | 0    | 0    | 0    | 0    |
| 2037 | 0    | 0    | 0    | 0    | 0    | 0    | 0    | 0    | 0    | 0    | 0    | 0    |
| 2038 | 0    | 0    | 0    | 0    | 0    | 0    | 0    | 0    | 0    | 0    | 0    | 0    |
| 2039 | 0    | 0    | 0    | 0    | 0    | 0    | 0    | 0    | 0    | 0    | 0    | 0    |
| 2040 | 0    | 0    | 0    | 0    | 0    | 0    | 0    | 0    | 0    | 0    | 0    | 0    |
| 2041 | 0    | 0    | 0    | 0    | 0    | 0    | 0    | 0    | 0    | 0    | 0    | 0    |
| 2042 | 0    | 0    | 0    | 0    | 0    | 0    | 0    | 0    | 0    | 95   | 0    | 0    |
| 2043 | 0    | 0    | 0    | 0    | 0    | 0    | 0    | 0    | 0    | 713  | 0    | 0    |
| 2044 | 45   | 0    | 0    | 0    | 0    | 0    | 30   | 44   | 0    | 1101 | 32   | 31   |
| 2045 | 394  | 0    | 0    | 0    | 0    | 0    | 687  | 708  | 0    | 1334 | 712  | 708  |
| 2046 | 742  | 13   | 8    | 1    | 1    | 1    | 1068 | 1089 | 0    | 1435 | 1114 | 1098 |
| 2047 | 1036 | 385  | 382  | 422  | 422  | 422  | 1248 | 1265 | 17   | 1475 | 1308 | 1287 |
| 2048 | 1271 | 726  | 727  | 765  | 765  | 765  | 1343 | 1363 | 775  | 1531 | 1428 | 1405 |
| 2049 | 1425 | 971  | 972  | 1011 | 1011 | 1011 | 1379 | 1399 | 1124 | 1540 | 1467 | 1444 |
| 2050 | 1537 | 1161 | 1163 | 1201 | 1201 | 1201 | 1389 | 1409 | 1258 | 1549 | 1478 | 1456 |
| 2051 | 1637 | 1345 | 1348 | 1385 | 1385 | 1385 | 1404 | 1424 | 1357 | 1564 | 1493 | 1472 |
| 2052 | 1698 | 1459 | 1462 | 1499 | 1499 | 1499 | 1409 | 1429 | 1375 | 1569 | 1498 | 1477 |
| 2053 | 1747 | 1507 | 1510 | 1547 | 1547 | 1547 | 1409 | 1429 | 1378 | 1569 | 1498 | 1477 |
| 2054 | 1785 | 1544 | 1547 | 1584 | 1584 | 1584 | 1422 | 1442 | 1391 | 1582 | 1511 | 1490 |
| 2055 | 1820 | 1581 | 1583 | 1620 | 1620 | 1620 | 1424 | 1444 | 1393 | 1584 | 1513 | 1492 |
| 2056 | 1844 | 1630 | 1622 | 1659 | 1659 | 1659 | 1434 | 1454 | 1403 | 1594 | 1523 | 1502 |
| 2057 | 1869 | 1664 | 1652 | 1693 | 1693 | 1693 | 1434 | 1454 | 1403 | 1594 | 1523 | 1502 |
| 2058 | 1870 | 1676 | 1664 | 1705 | 1705 | 1705 | 1434 | 1454 | 1403 | 1594 | 1523 | 1502 |
| 2059 | 1870 | 1679 | 1667 | 1708 | 1708 | 1708 | 1434 | 1454 | 1403 | 1594 | 1523 | 1502 |
| 2060 | 1870 | 1680 | 1668 | 1709 | 1709 | 1709 | 1434 | 1454 | 1403 | 1594 | 1523 | 1502 |
| 2061 | 1870 | 1680 | 1668 | 1709 | 1709 | 1709 | 1434 | 1454 | 1403 | 1594 | 1523 | 1502 |
| 2062 | 1870 | 1680 | 1668 | 1709 | 1709 | 1709 | 1434 | 1454 | 1403 | 1594 | 1523 | 1502 |
| 2063 | 1870 | 1680 | 1668 | 1709 | 1709 | 1709 | 1434 | 1454 | 1403 | 1594 | 1523 | 1502 |
| 2064 | 1870 | 1680 | 1668 | 1709 | 1709 | 1709 | 1434 | 1454 | 1403 | 1594 | 1523 | 1502 |
| 2065 | 1870 | 1680 | 1668 | 1709 | 1709 | 1709 | 1434 | 1454 | 1403 | 1594 | 1523 | 1502 |
| 2066 | 1870 | 1680 | 1668 | 1709 | 1709 | 1709 | 1434 | 1454 | 1403 | 1594 | 1523 | 1502 |
| 2067 | 1870 | 1680 | 1668 | 1709 | 1709 | 1709 | 1434 | 1454 | 1403 | 1594 | 1523 | 1502 |
| 2068 | 1870 | 1680 | 1668 | 1709 | 1709 | 1709 | 1434 | 1454 | 1403 | 1594 | 1523 | 1502 |

|      | 49   | 50   | 51   | 52   | 53   | 54   | 55   | 56   | 57   | 58   | 59   | 60   |
|------|------|------|------|------|------|------|------|------|------|------|------|------|
| 2069 | 1870 | 1680 | 1668 | 1709 | 1709 | 1709 | 1434 | 1454 | 1403 | 1594 | 1523 | 1502 |
| 2070 | 1870 | 1680 | 1668 | 1709 | 1709 | 1709 | 1434 | 1454 | 1403 | 1594 | 1523 | 1502 |
| 2071 | 1870 | 1680 | 1668 | 1709 | 1709 | 1709 | 1434 | 1454 | 1403 | 1594 | 1523 | 1502 |
| 2072 | 1870 | 1680 | 1668 | 1709 | 1709 | 1709 | 1434 | 1454 | 1403 | 1594 | 1523 | 1502 |
| 2073 | 1870 | 1680 | 1668 | 1709 | 1709 | 1709 | 1434 | 1454 | 1403 | 1594 | 1523 | 1502 |
| 2074 | 1870 | 1680 | 1668 | 1709 | 1709 | 1709 | 1434 | 1454 | 1403 | 1594 | 1523 | 1502 |
| 2075 | 1870 | 1680 | 1668 | 1709 | 1709 | 1709 | 1434 | 1454 | 1403 | 1594 | 1523 | 1502 |
| 2076 | 1870 | 1680 | 1668 | 1709 | 1709 | 1709 | 1434 | 1454 | 1403 | 1594 | 1523 | 1502 |
| 2077 | 1870 | 1680 | 1668 | 1709 | 1709 | 1709 | 1434 | 1454 | 1403 | 1594 | 1523 | 1502 |
| 2078 | 1870 | 1680 | 1668 | 1709 | 1709 | 1709 | 1434 | 1454 | 1403 | 1594 | 1523 | 1502 |
| 2079 | 1870 | 1680 | 1668 | 1709 | 1709 | 1709 | 1434 | 1454 | 1403 | 1594 | 1523 | 1502 |
| 2080 | 1870 | 1680 | 1668 | 1709 | 1709 | 1709 | 1434 | 1454 | 1403 | 1594 | 1523 | 1502 |
| 2081 | 1870 | 1680 | 1668 | 1709 | 1709 | 1709 | 1434 | 1454 | 1403 | 1594 | 1523 | 1502 |
| 2082 | 1870 | 1680 | 1668 | 1709 | 1709 | 1709 | 1434 | 1454 | 1403 | 1594 | 1523 | 1502 |
| 2083 | 1870 | 1680 | 1668 | 1709 | 1709 | 1709 | 1434 | 1454 | 1403 | 1594 | 1523 | 1502 |
| 2084 | 1870 | 1680 | 1668 | 1709 | 1709 | 1709 | 1434 | 1454 | 1403 | 1594 | 1523 | 1502 |
| 2085 | 1870 | 1680 | 1668 | 1709 | 1709 | 1709 | 1434 | 1454 | 1403 | 1594 | 1523 | 1502 |
| 2086 | 1870 | 1680 | 1668 | 1709 | 1709 | 1709 | 1434 | 1454 | 1403 | 1594 | 1523 | 1502 |
| 2087 | 1870 | 1680 | 1668 | 1709 | 1709 | 1709 | 1434 | 1454 | 1403 | 1594 | 1523 | 1502 |
| 2088 | 1870 | 1680 | 1668 | 1709 | 1709 | 1709 | 1434 | 1454 | 1403 | 1594 | 1523 | 1502 |
| 2089 | 1870 | 1680 | 1668 | 1709 | 1709 | 1709 | 1434 | 1454 | 1403 | 1594 | 1523 | 1502 |
| 2090 | 1870 | 1680 | 1668 | 1709 | 1709 | 1709 | 1434 | 1454 | 1403 | 1594 | 1523 | 1502 |



|      | 61   | 62   | 63   | 64   | 65   | 66   | 67   | 68   | 69   | 70   | 71   | 72   |
|------|------|------|------|------|------|------|------|------|------|------|------|------|
| 2002 | 0    | 0    | 0    | 0    | 0    | 0    | 0    | 0    | 0    | 0    | 0    | 0    |
| 2003 | 0    | 0    | 0    | 0    | 0    | 0    | 0    | 0    | 0    | 0    | 0    | 0    |
| 2004 | 0    | 0    | 0    | 0    | 0    | 0    | 0    | 0    | 0    | 0    | 0    | 0    |
| 2005 | 0    | 0    | 0    | 0    | 0    | 0    | 0    | 0    | 0    | 0    | 0    | 0    |
| 2006 | 0    | 0    | 0    | 0    | 0    | 0    | 0    | 0    | 0    | 0    | 0    | 0    |
| 2007 | 0    | 0    | 0    | 0    | 0    | 0    | 0    | 0    | 0    | 0    | 0    | 0    |
| 2008 | 0    | 0    | 0    | 0    | 0    | 0    | 0    | 0    | 0    | 0    | 0    | 0    |
| 2009 | 0    | 0    | 0    | 0    | 0    | 0    | 0    | 0    | 0    | 0    | 0    | 0    |
| 2010 | 0    | 0    | 0    | 0    | 0    | 0    | 0    | 0    | 0    | 0    | 0    | 0    |
| 2011 | 0    | 0    | 0    | 0    | 0    | 0    | 0    | 0    | 0    | 0    | 0    | 0    |
| 2012 | 0    | 0    | 0    | 0    | 0    | 0    | 0    | 0    | 0    | 0    | 0    | 0    |
| 2013 | 0    | 0    | 0    | 0    | 0    | 0    | 0    | 0    | 0    | 0    | 0    | 0    |
| 2014 | 0    | 0    | 0    | 0    | 0    | 0    | 0    | 0    | 0    | 0    | 0    | 0    |
| 2015 | 0    | 0    | 0    | 0    | 0    | 0    | 0    | 0    | 0    | 0    | 0    | 0    |
| 2016 | 0    | 0    | 0    | 0    | 0    | 0    | 0    | 0    | 0    | 0    | 0    | 0    |
| 2017 | 0    | 0    | 0    | 0    | 0    | 0    | 0    | 0    | 0    | 0    | 0    | 0    |
| 2018 | 0    | 0    | 0    | 0    | 0    | 0    | 0    | 0    | 0    | 0    | 0    | 0    |
| 2019 | 0    | 0    | 0    | 0    | 0    | 0    | 0    | 0    | 0    | 0    | 0    | 0    |
| 2020 | 0    | 0    | 0    | 0    | 0    | 0    | 0    | 0    | 0    | 0    | 0    | 0    |
| 2021 | 0    | 0    | 0    | 0    | 0    | 0    | 0    | 0    | 0    | 0    | 0    | 0    |
| 2022 | 0    | 0    | 0    | 0    | 0    | 0    | 0    | 0    | 0    | 0    | 0    | 0    |
| 2023 | 0    | 0    | 0    | 0    | 0    | 0    | 0    | 0    | 0    | 0    | 0    | 0    |
| 2024 | 0    | 0    | 0    | 0    | 0    | 0    | 0    | 0    | 0    | 0    | 0    | 0    |
| 2025 | 0    | 0    | 0    | 0    | 0    | 0    | 0    | 0    | 0    | 0    | 0    | 0    |
| 2026 | 0    | 0    | 0    | 0    | 0    | 0    | 0    | 0    | 0    | 0    | 0    | 0    |
| 2027 | 0    | 0    | 0    | 0    | 0    | 0    | 0    | 0    | 0    | 0    | 0    | 0    |
| 2028 | 0    | 0    | 0    | 0    | 0    | 0    | 0    | 0    | 0    | 0    | 0    | 0    |
| 2029 | 0    | 0    | 0    | 0    | 0    | 0    | 0    | 0    | 0    | 0    | 0    | 0    |
| 2030 | 0    | 0    | 0    | 0    | 0    | 0    | 0    | 0    | 0    | 0    | 0    | 0    |
| 2031 | 0    | 0    | 0    | 0    | 0    | 0    | 0    | 0    | 0    | 0    | 0    | 0    |
| 2032 | 0    | 0    | 0    | 0    | 0    | 0    | 0    | 0    | 0    | 0    | 0    | 0    |
| 2033 | 0    | 0    | 0    | 0    | 0    | 0    | 0    | 0    | 0    | 0    | 0    | 0    |
| 2034 | 0    | 0    | 0    | 0    | 0    | 0    | 0    | 0    | 0    | 0    | 0    | 0    |
| 2035 | 0    | 0    | 0    | 0    | 0    | 0    | 0    | 0    | 0    | 0    | 0    | 0    |
| 2036 | 0    | 0    | 0    | 0    | 0    | 0    | 0    | 0    | 0    | 0    | 0    | 0    |
| 2037 | 0    | 0    | 0    | 0    | 0    | 0    | 0    | 0    | 0    | 0    | 0    | 0    |
| 2038 | 0    | 0    | 0    | 0    | 0    | 0    | 0    | 0    | 0    | 0    | 0    | 0    |
| 2039 | 0    | 0    | 0    | 0    | 0    | 0    | 0    | 0    | 0    | 0    | 0    | 0    |
| 2040 | 0    | 0    | 0    | 0    | 0    | 0    | 0    | 0    | 0    | 0    | 0    | 0    |
| 2041 | 0    | 0    | 0    | 0    | 0    | 0    | 0    | 0    | 0    | 0    | 0    | 0    |
| 2042 | 0    | 0    | 0    | 0    | 0    | 0    | 0    | 0    | 0    | 0    | 0    | 0    |
| 2043 | 0    | 0    | 0    | 0    | 0    | 0    | 0    | 0    | 0    | 0    | 0    | 0    |
| 2044 | 28   | 28   | 28   | 0    | 0    | 0    | 35   | 0    | 0    | 0    | 0    | 0    |
| 2045 | 689  | 689  | 689  | 0    | 0    | 0    | 372  | 0    | 0    | 0    | 0    | 0    |
| 2046 | 1070 | 1070 | 1070 | 0    | 0    | 0    | 722  | 0    | 64   | 0    | 0    | 0    |
| 2047 | 1248 | 1248 | 1248 | 2    | 4    | 0    | 992  | 0    | 419  | 2    | 2    | 2    |
| 2048 | 1343 | 1343 | 1343 | 382  | 382  | 1    | 1189 | 399  | 755  | 375  | 375  | 375  |
| 2049 | 1373 | 1373 | 1373 | 723  | 724  | 405  | 1328 | 741  | 999  | 716  | 716  | 716  |
| 2050 | 1383 | 1383 | 1383 | 968  | 969  | 683  | 1421 | 987  | 1156 | 961  | 961  | 961  |
| 2051 | 1398 | 1398 | 1398 | 1158 | 1159 | 870  | 1495 | 1177 | 1278 | 1151 | 1151 | 1151 |
| 2052 | 1403 | 1403 | 1403 | 1342 | 1343 | 1037 | 1544 | 1361 | 1375 | 1335 | 1335 | 1335 |
| 2053 | 1403 | 1403 | 1403 | 1456 | 1457 | 1139 | 1578 | 1475 | 1422 | 1449 | 1449 | 1449 |
| 2054 | 1416 | 1416 | 1416 | 1504 | 1505 | 1183 | 1604 | 1523 | 1459 | 1497 | 1497 | 1497 |
| 2055 | 1418 | 1418 | 1418 | 1541 | 1542 | 1219 | 1622 | 1560 | 1496 | 1534 | 1534 | 1534 |
| 2056 | 1428 | 1428 | 1428 | 1577 | 1578 | 1255 | 1635 | 1596 | 1522 | 1570 | 1570 | 1570 |
| 2057 | 1428 | 1428 | 1428 | 1616 | 1617 | 1276 | 1647 | 1635 | 1542 | 1609 | 1609 | 1609 |
| 2058 | 1428 | 1428 | 1428 | 1650 | 1651 | 1291 | 1649 | 1669 | 1542 | 1643 | 1643 | 1643 |
| 2059 | 1428 | 1428 | 1428 | 1662 | 1663 | 1293 | 1650 | 1681 | 1542 | 1655 | 1655 | 1655 |
| 2060 | 1428 | 1428 | 1428 | 1665 | 1666 | 1293 | 1650 | 1684 | 1542 | 1658 | 1658 | 1658 |
| 2061 | 1428 | 1428 | 1428 | 1666 | 1667 | 1293 | 1650 | 1685 | 1542 | 1659 | 1659 | 1659 |
| 2062 | 1428 | 1428 | 1428 | 1666 | 1667 | 1293 | 1650 | 1685 | 1542 | 1659 | 1659 | 1659 |
| 2063 | 1428 | 1428 | 1428 | 1666 | 1667 | 1293 | 1650 | 1685 | 1542 | 1659 | 1659 | 1659 |
| 2064 | 1428 | 1428 | 1428 | 1666 | 1667 | 1293 | 1650 | 1685 | 1542 | 1659 | 1659 | 1659 |
| 2065 | 1428 | 1428 | 1428 | 1666 | 1667 | 1293 | 1650 | 1685 | 1542 | 1659 | 1659 | 1659 |
| 2066 | 1428 | 1428 | 1428 | 1666 | 1667 | 1293 | 1650 | 1685 | 1542 | 1659 | 1659 | 1659 |
| 2067 | 1428 | 1428 | 1428 | 1666 | 1667 | 1293 | 1650 | 1685 | 1542 | 1659 | 1659 | 1659 |
| 2068 | 1428 | 1428 | 1428 | 1666 | 1667 | 1293 | 1650 | 1685 | 1542 | 1659 | 1659 | 1659 |

|      | 61   | 62   | 63   | 64   | 65   | 66   | 67   | 68   | 69   | 70   | 71   | 72   |
|------|------|------|------|------|------|------|------|------|------|------|------|------|
| 2069 | 1428 | 1428 | 1428 | 1666 | 1667 | 1293 | 1650 | 1685 | 1542 | 1659 | 1659 | 1659 |
| 2070 | 1428 | 1428 | 1428 | 1666 | 1667 | 1293 | 1650 | 1685 | 1542 | 1659 | 1659 | 1659 |
| 2071 | 1428 | 1428 | 1428 | 1666 | 1667 | 1293 | 1650 | 1685 | 1542 | 1659 | 1659 | 1659 |
| 2072 | 1428 | 1428 | 1428 | 1666 | 1667 | 1293 | 1650 | 1685 | 1542 | 1659 | 1659 | 1659 |
| 2073 | 1428 | 1428 | 1428 | 1666 | 1667 | 1293 | 1650 | 1685 | 1542 | 1659 | 1659 | 1659 |
| 2074 | 1428 | 1428 | 1428 | 1666 | 1667 | 1293 | 1650 | 1685 | 1542 | 1659 | 1659 | 1659 |
| 2075 | 1428 | 1428 | 1428 | 1666 | 1667 | 1293 | 1650 | 1685 | 1542 | 1659 | 1659 | 1659 |
| 2076 | 1428 | 1428 | 1428 | 1666 | 1667 | 1293 | 1650 | 1685 | 1542 | 1659 | 1659 | 1659 |
| 2077 | 1428 | 1428 | 1428 | 1666 | 1667 | 1293 | 1650 | 1685 | 1542 | 1659 | 1659 | 1659 |
| 2078 | 1428 | 1428 | 1428 | 1666 | 1667 | 1293 | 1650 | 1685 | 1542 | 1659 | 1659 | 1659 |
| 2079 | 1428 | 1428 | 1428 | 1666 | 1667 | 1293 | 1650 | 1685 | 1542 | 1659 | 1659 | 1659 |
| 2080 | 1428 | 1428 | 1428 | 1666 | 1667 | 1293 | 1650 | 1685 | 1542 | 1659 | 1659 | 1659 |
| 2081 | 1428 | 1428 | 1428 | 1666 | 1667 | 1293 | 1650 | 1685 | 1542 | 1659 | 1659 | 1659 |
| 2082 | 1428 | 1428 | 1428 | 1666 | 1667 | 1293 | 1650 | 1685 | 1542 | 1659 | 1659 | 1659 |
| 2083 | 1428 | 1428 | 1428 | 1666 | 1667 | 1293 | 1650 | 1685 | 1542 | 1659 | 1659 | 1659 |
| 2084 | 1428 | 1428 | 1428 | 1666 | 1667 | 1293 | 1650 | 1685 | 1542 | 1659 | 1659 | 1659 |
| 2085 | 1428 | 1428 | 1428 | 1666 | 1667 | 1293 | 1650 | 1685 | 1542 | 1659 | 1659 | 1659 |
| 2086 | 1428 | 1428 | 1428 | 1666 | 1667 | 1293 | 1650 | 1685 | 1542 | 1659 | 1659 | 1659 |
| 2087 | 1428 | 1428 | 1428 | 1666 | 1667 | 1293 | 1650 | 1685 | 1542 | 1659 | 1659 | 1659 |
| 2088 | 1428 | 1428 | 1428 | 1666 | 1667 | 1293 | 1650 | 1685 | 1542 | 1659 | 1659 | 1659 |
| 2089 | 1428 | 1428 | 1428 | 1666 | 1667 | 1293 | 1650 | 1685 | 1542 | 1659 | 1659 | 1659 |
| 2090 | 1428 | 1428 | 1428 | 1666 | 1667 | 1293 | 1650 | 1685 | 1542 | 1659 | 1659 | 1659 |

|      | 73   | 74   | 75   | 76   | 77   | 78   | 79   | 80   | 81   | 82   | 83   | 84   |
|------|------|------|------|------|------|------|------|------|------|------|------|------|
| 2002 | 0    | 0    | 0    | 0    | 0    | 0    | 0    | 0    | 0    | 0    | 0    | 0    |
| 2003 | 0    | 0    | 0    | 0    | 0    | 0    | 0    | 0    | 0    | 0    | 0    | 0    |
| 2004 | 0    | 0    | 0    | 0    | 0    | 0    | 0    | 0    | 0    | 0    | 0    | 0    |
| 2005 | 0    | 0    | 0    | 0    | 0    | 0    | 0    | 0    | 0    | 0    | 0    | 0    |
| 2006 | 0    | 0    | 0    | 0    | 0    | 0    | 0    | 0    | 0    | 0    | 0    | 0    |
| 2007 | 0    | 0    | 0    | 0    | 0    | 0    | 0    | 0    | 0    | 0    | 0    | 0    |
| 2008 | 0    | 0    | 0    | 0    | 0    | 0    | 0    | 0    | 0    | 0    | 0    | 0    |
| 2009 | 0    | 0    | 0    | 0    | 0    | 0    | 0    | 0    | 0    | 0    | 0    | 0    |
| 2010 | 0    | 0    | 0    | 0    | 0    | 0    | 0    | 0    | 0    | 0    | 0    | 0    |
| 2011 | 0    | 0    | 0    | 0    | 0    | 0    | 0    | 0    | 0    | 0    | 0    | 0    |
| 2012 | 0    | 0    | 0    | 0    | 0    | 0    | 0    | 0    | 0    | 0    | 0    | 0    |
| 2013 | 0    | 0    | 0    | 0    | 0    | 0    | 0    | 0    | 0    | 0    | 0    | 0    |
| 2014 | 0    | 0    | 0    | 0    | 0    | 0    | 0    | 0    | 0    | 0    | 0    | 0    |
| 2015 | 0    | 0    | 0    | 0    | 0    | 0    | 0    | 0    | 0    | 0    | 0    | 0    |
| 2016 | 0    | 0    | 0    | 0    | 0    | 0    | 0    | 0    | 0    | 0    | 0    | 0    |
| 2017 | 0    | 0    | 0    | 0    | 0    | 0    | 0    | 0    | 0    | 0    | 0    | 0    |
| 2018 | 0    | 0    | 0    | 0    | 0    | 0    | 0    | 0    | 0    | 0    | 0    | 0    |
| 2019 | 0    | 0    | 0    | 0    | 0    | 0    | 0    | 0    | 0    | 0    | 0    | 0    |
| 2020 | 0    | 0    | 0    | 0    | 0    | 0    | 0    | 0    | 0    | 0    | 0    | 0    |
| 2021 | 0    | 0    | 0    | 0    | 0    | 0    | 0    | 0    | 0    | 0    | 0    | 0    |
| 2022 | 0    | 0    | 0    | 0    | 0    | 0    | 0    | 0    | 0    | 0    | 0    | 0    |
| 2023 | 0    | 0    | 0    | 0    | 0    | 0    | 0    | 0    | 0    | 0    | 0    | 0    |
| 2024 | 0    | 0    | 0    | 0    | 0    | 0    | 0    | 0    | 0    | 0    | 0    | 0    |
| 2025 | 0    | 0    | 0    | 0    | 0    | 0    | 0    | 0    | 0    | 0    | 0    | 0    |
| 2026 | 0    | 0    | 0    | 0    | 0    | 0    | 0    | 0    | 0    | 0    | 0    | 0    |
| 2027 | 0    | 0    | 0    | 0    | 0    | 0    | 0    | 0    | 0    | 0    | 0    | 0    |
| 2028 | 0    | 0    | 0    | 0    | 0    | 0    | 0    | 0    | 0    | 0    | 0    | 0    |
| 2029 | 0    | 0    | 0    | 0    | 0    | 0    | 0    | 0    | 0    | 0    | 0    | 0    |
| 2030 | 0    | 0    | 0    | 0    | 0    | 0    | 0    | 0    | 0    | 0    | 0    | 0    |
| 2031 | 0    | 0    | 0    | 0    | 0    | 0    | 0    | 0    | 0    | 0    | 0    | 0    |
| 2032 | 0    | 0    | 0    | 0    | 0    | 0    | 0    | 0    | 0    | 0    | 0    | 0    |
| 2033 | 0    | 0    | 0    | 0    | 0    | 0    | 0    | 0    | 0    | 0    | 0    | 0    |
| 2034 | 0    | 0    | 0    | 0    | 0    | 0    | 0    | 0    | 0    | 0    | 0    | 0    |
| 2035 | 0    | 0    | 0    | 0    | 0    | 0    | 0    | 0    | 0    | 0    | 0    | 0    |
| 2036 | 0    | 0    | 0    | 0    | 0    | 0    | 0    | 0    | 0    | 0    | 0    | 0    |
| 2037 | 0    | 0    | 0    | 0    | 0    | 0    | 0    | 0    | 0    | 0    | 0    | 0    |
| 2038 | 0    | 0    | 0    | 0    | 0    | 0    | 0    | 0    | 0    | 0    | 0    | 0    |
| 2039 | 0    | 0    | 0    | 0    | 0    | 0    | 0    | 0    | 0    | 0    | 0    | 0    |
| 2040 | 0    | 0    | 0    | 0    | 0    | 0    | 0    | 0    | 0    | 0    | 0    | 0    |
| 2041 | 0    | 0    | 0    | 0    | 0    | 0    | 0    | 0    | 0    | 0    | 0    | 0    |
| 2042 | 0    | 0    | 0    | 0    | 0    | 0    | 0    | 0    | 0    | 0    | 0    | 0    |
| 2043 | 0    | 0    | 0    | 84   | 0    | 0    | 0    | 0    | 0    | 0    | 0    | 0    |
| 2044 | 0    | 0    | 0    | 426  | 0    | 0    | 0    | 0    | 0    | 30   | 30   | 0    |
| 2045 | 10   | 1    | 0    | 764  | 2    | 54   | 9    | 9    | 9    | 695  | 695  | 0    |
| 2046 | 382  | 373  | 0    | 1056 | 374  | 402  | 382  | 382  | 382  | 1087 | 1087 | 0    |
| 2047 | 714  | 705  | 0    | 1266 | 706  | 724  | 714  | 714  | 714  | 1280 | 1280 | 1    |
| 2048 | 970  | 961  | 396  | 1420 | 960  | 985  | 969  | 969  | 969  | 1400 | 1400 | 772  |
| 2049 | 1160 | 1151 | 674  | 1499 | 1150 | 1153 | 1159 | 1159 | 1159 | 1439 | 1439 | 1123 |
| 2050 | 1337 | 1331 | 861  | 1574 | 1334 | 1300 | 1339 | 1339 | 1339 | 1450 | 1450 | 1257 |
| 2051 | 1450 | 1444 | 1028 | 1633 | 1448 | 1403 | 1453 | 1453 | 1453 | 1465 | 1465 | 1356 |
| 2052 | 1498 | 1492 | 1130 | 1681 | 1496 | 1451 | 1501 | 1501 | 1501 | 1470 | 1470 | 1374 |
| 2053 | 1535 | 1529 | 1174 | 1709 | 1533 | 1488 | 1538 | 1538 | 1538 | 1470 | 1470 | 1377 |
| 2054 | 1571 | 1565 | 1210 | 1734 | 1569 | 1527 | 1574 | 1574 | 1574 | 1483 | 1483 | 1390 |
| 2055 | 1610 | 1604 | 1246 | 1748 | 1608 | 1550 | 1613 | 1613 | 1613 | 1485 | 1485 | 1392 |
| 2056 | 1644 | 1638 | 1267 | 1760 | 1642 | 1556 | 1647 | 1647 | 1647 | 1495 | 1495 | 1402 |
| 2057 | 1656 | 1650 | 1282 | 1762 | 1654 | 1556 | 1659 | 1659 | 1659 | 1495 | 1495 | 1402 |
| 2058 | 1659 | 1653 | 1284 | 1762 | 1657 | 1556 | 1662 | 1662 | 1662 | 1495 | 1495 | 1402 |
| 2059 | 1660 | 1654 | 1284 | 1762 | 1658 | 1556 | 1663 | 1663 | 1663 | 1495 | 1495 | 1402 |
| 2060 | 1660 | 1654 | 1284 | 1762 | 1658 | 1556 | 1663 | 1663 | 1663 | 1495 | 1495 | 1402 |
| 2061 | 1660 | 1654 | 1284 | 1762 | 1658 | 1556 | 1663 | 1663 | 1663 | 1495 | 1495 | 1402 |
| 2062 | 1660 | 1654 | 1284 | 1762 | 1658 | 1556 | 1663 | 1663 | 1663 | 1495 | 1495 | 1402 |
| 2063 | 1660 | 1654 | 1284 | 1762 | 1658 | 1556 | 1663 | 1663 | 1663 | 1495 | 1495 | 1402 |
| 2064 | 1660 | 1654 | 1284 | 1762 | 1658 | 1556 | 1663 | 1663 | 1663 | 1495 | 1495 | 1402 |
| 2065 | 1660 | 1654 | 1284 | 1762 | 1658 | 1556 | 1663 | 1663 | 1663 | 1495 | 1495 | 1402 |
| 2066 | 1660 | 1654 | 1284 | 1762 | 1658 | 1556 | 1663 | 1663 | 1663 | 1495 | 1495 | 1402 |
| 2067 | 1660 | 1654 | 1284 | 1762 | 1658 | 1556 | 1663 | 1663 | 1663 | 1495 | 1495 | 1402 |
| 2068 | 1660 | 1654 | 1284 | 1762 | 1658 | 1556 | 1663 | 1663 | 1663 | 1495 | 1495 | 1402 |

|      | 73   | 74   | 75   | 76   | 77   | 78   | 79   | 80   | 81   | 82   | 83   | 84   |
|------|------|------|------|------|------|------|------|------|------|------|------|------|
| 2069 | 1660 | 1654 | 1284 | 1762 | 1658 | 1556 | 1663 | 1663 | 1663 | 1495 | 1495 | 1402 |
| 2070 | 1660 | 1654 | 1284 | 1762 | 1658 | 1556 | 1663 | 1663 | 1663 | 1495 | 1495 | 1402 |
| 2071 | 1660 | 1654 | 1284 | 1762 | 1658 | 1556 | 1663 | 1663 | 1663 | 1495 | 1495 | 1402 |
| 2072 | 1660 | 1654 | 1284 | 1762 | 1658 | 1556 | 1663 | 1663 | 1663 | 1495 | 1495 | 1402 |
| 2073 | 1660 | 1654 | 1284 | 1762 | 1658 | 1556 | 1663 | 1663 | 1663 | 1495 | 1495 | 1402 |
| 2074 | 1660 | 1654 | 1284 | 1762 | 1658 | 1556 | 1663 | 1663 | 1663 | 1495 | 1495 | 1402 |
| 2075 | 1660 | 1654 | 1284 | 1762 | 1658 | 1556 | 1663 | 1663 | 1663 | 1495 | 1495 | 1402 |
| 2076 | 1660 | 1654 | 1284 | 1762 | 1658 | 1556 | 1663 | 1663 | 1663 | 1495 | 1495 | 1402 |
| 2077 | 1660 | 1654 | 1284 | 1762 | 1658 | 1556 | 1663 | 1663 | 1663 | 1495 | 1495 | 1402 |
| 2078 | 1660 | 1654 | 1284 | 1762 | 1658 | 1556 | 1663 | 1663 | 1663 | 1495 | 1495 | 1402 |
| 2079 | 1660 | 1654 | 1284 | 1762 | 1658 | 1556 | 1663 | 1663 | 1663 | 1495 | 1495 | 1402 |
| 2080 | 1660 | 1654 | 1284 | 1762 | 1658 | 1556 | 1663 | 1663 | 1663 | 1495 | 1495 | 1402 |
| 2081 | 1660 | 1654 | 1284 | 1762 | 1658 | 1556 | 1663 | 1663 | 1663 | 1495 | 1495 | 1402 |
| 2082 | 1660 | 1654 | 1284 | 1762 | 1658 | 1556 | 1663 | 1663 | 1663 | 1495 | 1495 | 1402 |
| 2083 | 1660 | 1654 | 1284 | 1762 | 1658 | 1556 | 1663 | 1663 | 1663 | 1495 | 1495 | 1402 |
| 2084 | 1660 | 1654 | 1284 | 1762 | 1658 | 1556 | 1663 | 1663 | 1663 | 1495 | 1495 | 1402 |
| 2085 | 1660 | 1654 | 1284 | 1762 | 1658 | 1556 | 1663 | 1663 | 1663 | 1495 | 1495 | 1402 |
| 2086 | 1660 | 1654 | 1284 | 1762 | 1658 | 1556 | 1663 | 1663 | 1663 | 1495 | 1495 | 1402 |
| 2087 | 1660 | 1654 | 1284 | 1762 | 1658 | 1556 | 1663 | 1663 | 1663 | 1495 | 1495 | 1402 |
| 2088 | 1660 | 1654 | 1284 | 1762 | 1658 | 1556 | 1663 | 1663 | 1663 | 1495 | 1495 | 1402 |
| 2089 | 1660 | 1654 | 1284 | 1762 | 1658 | 1556 | 1663 | 1663 | 1663 | 1495 | 1495 | 1402 |
| 2090 | 1660 | 1654 | 1284 | 1762 | 1658 | 1556 | 1663 | 1663 | 1663 | 1495 | 1495 | 1402 |

|      | 85   | 86   | 87   | 88   | 89   | 90   | 91   | 92   | 93   | 94   | 95   | 96   |
|------|------|------|------|------|------|------|------|------|------|------|------|------|
| 2002 | 0    | 0    | 0    | 0    | 0    | 0    | 0    | 0    | 0    | 0    | 0    | 0    |
| 2003 | 0    | 0    | 0    | 0    | 0    | 0    | 0    | 0    | 0    | 0    | 0    | 0    |
| 2004 | 0    | 0    | 0    | 0    | 0    | 0    | 0    | 0    | 0    | 0    | 0    | 0    |
| 2005 | 0    | 0    | 0    | 0    | 0    | 0    | 0    | 0    | 0    | 0    | 0    | 0    |
| 2006 | 0    | 0    | 0    | 0    | 0    | 0    | 0    | 0    | 0    | 0    | 0    | 0    |
| 2007 | 0    | 0    | 0    | 0    | 0    | 0    | 0    | 0    | 0    | 0    | 0    | 0    |
| 2008 | 0    | 0    | 0    | 0    | 0    | 0    | 0    | 0    | 0    | 0    | 0    | 0    |
| 2009 | 0    | 0    | 0    | 0    | 0    | 0    | 0    | 0    | 0    | 0    | 0    | 0    |
| 2010 | 0    | 0    | 0    | 0    | 0    | 0    | 0    | 0    | 0    | 0    | 0    | 0    |
| 2011 | 0    | 0    | 0    | 0    | 0    | 0    | 0    | 0    | 0    | 0    | 0    | 0    |
| 2012 | 0    | 0    | 0    | 0    | 0    | 0    | 0    | 0    | 0    | 0    | 0    | 0    |
| 2013 | 0    | 0    | 0    | 0    | 0    | 0    | 0    | 0    | 0    | 0    | 0    | 0    |
| 2014 | 0    | 0    | 0    | 0    | 0    | 0    | 0    | 0    | 0    | 0    | 0    | 0    |
| 2015 | 0    | 0    | 0    | 0    | 0    | 0    | 0    | 0    | 0    | 0    | 0    | 0    |
| 2016 | 0    | 0    | 0    | 0    | 0    | 0    | 0    | 0    | 0    | 0    | 0    | 0    |
| 2017 | 0    | 0    | 0    | 0    | 0    | 0    | 0    | 0    | 0    | 0    | 0    | 0    |
| 2018 | 0    | 0    | 0    | 0    | 0    | 0    | 0    | 0    | 0    | 0    | 0    | 0    |
| 2019 | 0    | 0    | 0    | 0    | 0    | 0    | 0    | 0    | 0    | 0    | 0    | 0    |
| 2020 | 0    | 0    | 0    | 0    | 0    | 0    | 0    | 0    | 0    | 0    | 0    | 0    |
| 2021 | 0    | 0    | 0    | 0    | 0    | 0    | 0    | 0    | 0    | 0    | 0    | 0    |
| 2022 | 0    | 0    | 0    | 0    | 0    | 0    | 0    | 0    | 0    | 0    | 0    | 0    |
| 2023 | 0    | 0    | 0    | 0    | 0    | 0    | 0    | 0    | 0    | 0    | 0    | 0    |
| 2024 | 0    | 0    | 0    | 0    | 0    | 0    | 0    | 0    | 0    | 0    | 0    | 0    |
| 2025 | 0    | 0    | 0    | 0    | 0    | 0    | 0    | 0    | 0    | 0    | 0    | 0    |
| 2026 | 0    | 0    | 0    | 0    | 0    | 0    | 0    | 0    | 0    | 0    | 0    | 0    |
| 2027 | 0    | 0    | 0    | 0    | 0    | 0    | 0    | 0    | 0    | 0    | 0    | 0    |
| 2028 | 0    | 0    | 0    | 0    | 0    | 0    | 0    | 0    | 0    | 0    | 0    | 0    |
| 2029 | 0    | 0    | 0    | 0    | 0    | 0    | 0    | 0    | 0    | 0    | 0    | 0    |
| 2030 | 0    | 0    | 0    | 0    | 0    | 0    | 0    | 0    | 0    | 0    | 0    | 0    |
| 2031 | 0    | 0    | 0    | 0    | 0    | 0    | 0    | 0    | 0    | 0    | 0    | 0    |
| 2032 | 0    | 0    | 0    | 0    | 0    | 0    | 0    | 0    | 0    | 0    | 0    | 0    |
| 2033 | 0    | 0    | 0    | 0    | 0    | 0    | 0    | 0    | 0    | 0    | 0    | 0    |
| 2034 | 0    | 0    | 0    | 0    | 0    | 0    | 0    | 0    | 0    | 0    | 0    | 0    |
| 2035 | 0    | 0    | 0    | 0    | 0    | 0    | 0    | 0    | 0    | 0    | 0    | 0    |
| 2036 | 0    | 0    | 0    | 0    | 0    | 0    | 0    | 0    | 0    | 0    | 0    | 0    |
| 2037 | 0    | 0    | 0    | 0    | 0    | 0    | 0    | 0    | 0    | 0    | 0    | 0    |
| 2038 | 0    | 0    | 0    | 0    | 0    | 0    | 0    | 0    | 0    | 0    | 0    | 0    |
| 2039 | 0    | 0    | 0    | 0    | 0    | 0    | 0    | 0    | 0    | 0    | 0    | 0    |
| 2040 | 0    | 0    | 0    | 0    | 0    | 0    | 0    | 0    | 0    | 0    | 0    | 0    |
| 2041 | 0    | 0    | 0    | 0    | 0    | 0    | 0    | 0    | 0    | 0    | 0    | 0    |
| 2042 | 97   | 0    | 0    | 0    | 0    | 0    | 0    | 0    | 0    | 0    | 0    | 0    |
| 2043 | 742  | 0    | 0    | 0    | 0    | 0    | 0    | 0    | 0    | 0    | 0    | 0    |
| 2044 | 1127 | 30   | 12   | 30   | 30   | 30   | 0    | 0    | 0    | 0    | 0    | 0    |
| 2045 | 1348 | 718  | 694  | 695  | 695  | 695  | 0    | 0    | 0    | 0    | 0    | 0    |
| 2046 | 1431 | 1120 | 1095 | 1087 | 1087 | 1087 | 0    | 0    | 0    | 39   | 0    | 27   |
| 2047 | 1472 | 1314 | 1286 | 1280 | 1280 | 1280 | 0    | 0    | 0    | 411  | 2    | 403  |
| 2048 | 1528 | 1434 | 1405 | 1400 | 1400 | 1400 | 397  | 397  | 0    | 777  | 399  | 742  |
| 2049 | 1537 | 1473 | 1444 | 1439 | 1439 | 1439 | 739  | 739  | 404  | 1070 | 741  | 986  |
| 2050 | 1546 | 1484 | 1456 | 1450 | 1450 | 1450 | 985  | 985  | 682  | 1310 | 987  | 1148 |
| 2051 | 1561 | 1499 | 1472 | 1465 | 1465 | 1465 | 1175 | 1175 | 869  | 1484 | 1177 | 1285 |
| 2052 | 1566 | 1504 | 1477 | 1470 | 1470 | 1470 | 1359 | 1359 | 1036 | 1602 | 1361 | 1384 |
| 2053 | 1566 | 1504 | 1477 | 1470 | 1470 | 1470 | 1473 | 1473 | 1138 | 1706 | 1475 | 1428 |
| 2054 | 1579 | 1517 | 1490 | 1483 | 1483 | 1483 | 1521 | 1521 | 1182 | 1778 | 1523 | 1465 |
| 2055 | 1581 | 1519 | 1492 | 1485 | 1485 | 1485 | 1558 | 1558 | 1218 | 1826 | 1560 | 1502 |
| 2056 | 1591 | 1529 | 1502 | 1495 | 1495 | 1495 | 1594 | 1594 | 1254 | 1864 | 1596 | 1535 |
| 2057 | 1591 | 1529 | 1502 | 1495 | 1495 | 1495 | 1633 | 1633 | 1275 | 1900 | 1635 | 1557 |
| 2058 | 1591 | 1529 | 1502 | 1495 | 1495 | 1495 | 1667 | 1667 | 1290 | 1937 | 1669 | 1569 |
| 2059 | 1591 | 1529 | 1502 | 1495 | 1495 | 1495 | 1679 | 1679 | 1292 | 1964 | 1681 | 1572 |
| 2060 | 1591 | 1529 | 1502 | 1495 | 1495 | 1495 | 1682 | 1682 | 1292 | 1967 | 1684 | 1573 |
| 2061 | 1591 | 1529 | 1502 | 1495 | 1495 | 1495 | 1683 | 1683 | 1292 | 1968 | 1685 | 1573 |
| 2062 | 1591 | 1529 | 1502 | 1495 | 1495 | 1495 | 1683 | 1683 | 1292 | 1968 | 1685 | 1573 |
| 2063 | 1591 | 1529 | 1502 | 1495 | 1495 | 1495 | 1683 | 1683 | 1292 | 1968 | 1685 | 1573 |
| 2064 | 1591 | 1529 | 1502 | 1495 | 1495 | 1495 | 1683 | 1683 | 1292 | 1968 | 1685 | 1573 |
| 2065 | 1591 | 1529 | 1502 | 1495 | 1495 | 1495 | 1683 | 1683 | 1292 | 1968 | 1685 | 1573 |
| 2066 | 1591 | 1529 | 1502 | 1495 | 1495 | 1495 | 1683 | 1683 | 1292 | 1968 | 1685 | 1573 |
| 2067 | 1591 | 1529 | 1502 | 1495 | 1495 | 1495 | 1683 | 1683 | 1292 | 1968 | 1685 | 1573 |
| 2068 | 1591 | 1529 | 1502 | 1495 | 1495 | 1495 | 1683 | 1683 | 1292 | 1968 | 1685 | 1573 |

|      | 85   | 86   | 87   | 88   | 89   | 90   | 91   | 92   | 93   | 94   | 95   | 96   |
|------|------|------|------|------|------|------|------|------|------|------|------|------|
| 2069 | 1591 | 1529 | 1502 | 1495 | 1495 | 1495 | 1683 | 1683 | 1292 | 1968 | 1685 | 1573 |
| 2070 | 1591 | 1529 | 1502 | 1495 | 1495 | 1495 | 1683 | 1683 | 1292 | 1968 | 1685 | 1573 |
| 2071 | 1591 | 1529 | 1502 | 1495 | 1495 | 1495 | 1683 | 1683 | 1292 | 1968 | 1685 | 1573 |
| 2072 | 1591 | 1529 | 1502 | 1495 | 1495 | 1495 | 1683 | 1683 | 1292 | 1968 | 1685 | 1573 |
| 2073 | 1591 | 1529 | 1502 | 1495 | 1495 | 1495 | 1683 | 1683 | 1292 | 1968 | 1685 | 1573 |
| 2074 | 1591 | 1529 | 1502 | 1495 | 1495 | 1495 | 1683 | 1683 | 1292 | 1968 | 1685 | 1573 |
| 2075 | 1591 | 1529 | 1502 | 1495 | 1495 | 1495 | 1683 | 1683 | 1292 | 1968 | 1685 | 1573 |
| 2076 | 1591 | 1529 | 1502 | 1495 | 1495 | 1495 | 1683 | 1683 | 1292 | 1968 | 1685 | 1573 |
| 2077 | 1591 | 1529 | 1502 | 1495 | 1495 | 1495 | 1683 | 1683 | 1292 | 1968 | 1685 | 1573 |
| 2078 | 1591 | 1529 | 1502 | 1495 | 1495 | 1495 | 1683 | 1683 | 1292 | 1968 | 1685 | 1573 |
| 2079 | 1591 | 1529 | 1502 | 1495 | 1495 | 1495 | 1683 | 1683 | 1292 | 1968 | 1685 | 1573 |
| 2080 | 1591 | 1529 | 1502 | 1495 | 1495 | 1495 | 1683 | 1683 | 1292 | 1968 | 1685 | 1573 |
| 2081 | 1591 | 1529 | 1502 | 1495 | 1495 | 1495 | 1683 | 1683 | 1292 | 1968 | 1685 | 1573 |
| 2082 | 1591 | 1529 | 1502 | 1495 | 1495 | 1495 | 1683 | 1683 | 1292 | 1968 | 1685 | 1573 |
| 2083 | 1591 | 1529 | 1502 | 1495 | 1495 | 1495 | 1683 | 1683 | 1292 | 1968 | 1685 | 1573 |
| 2084 | 1591 | 1529 | 1502 | 1495 | 1495 | 1495 | 1683 | 1683 | 1292 | 1968 | 1685 | 1573 |
| 2085 | 1591 | 1529 | 1502 | 1495 | 1495 | 1495 | 1683 | 1683 | 1292 | 1968 | 1685 | 1573 |
| 2086 | 1591 | 1529 | 1502 | 1495 | 1495 | 1495 | 1683 | 1683 | 1292 | 1968 | 1685 | 1573 |
| 2087 | 1591 | 1529 | 1502 | 1495 | 1495 | 1495 | 1683 | 1683 | 1292 | 1968 | 1685 | 1573 |
| 2088 | 1591 | 1529 | 1502 | 1495 | 1495 | 1495 | 1683 | 1683 | 1292 | 1968 | 1685 | 1573 |
| 2089 | 1591 | 1529 | 1502 | 1495 | 1495 | 1495 | 1683 | 1683 | 1292 | 1968 | 1685 | 1573 |
| 2090 | 1591 | 1529 | 1502 | 1495 | 1495 | 1495 | 1683 | 1683 | 1292 | 1968 | 1685 | 1573 |

|      | 97   | 98   | 99   | 100  | 101  | 102  | 103  | 104  | 105  | 106  | 107  | 108  |
|------|------|------|------|------|------|------|------|------|------|------|------|------|
| 2002 | 0    | 0    | 0    | 0    | 0    | 0    | 0    | 0    | 0    | 0    | 0    | 0    |
| 2003 | 0    | 0    | 0    | 0    | 0    | 0    | 0    | 0    | 0    | 0    | 0    | 0    |
| 2004 | 0    | 0    | 0    | 0    | 0    | 0    | 0    | 0    | 0    | 0    | 0    | 0    |
| 2005 | 0    | 0    | 0    | 0    | 0    | 0    | 0    | 0    | 0    | 0    | 0    | 0    |
| 2006 | 0    | 0    | 0    | 0    | 0    | 0    | 0    | 0    | 0    | 0    | 0    | 0    |
| 2007 | 0    | 0    | 0    | 0    | 0    | 0    | 0    | 0    | 0    | 0    | 0    | 0    |
| 2008 | 0    | 0    | 0    | 0    | 0    | 0    | 0    | 0    | 0    | 0    | 0    | 0    |
| 2009 | 0    | 0    | 0    | 0    | 0    | 0    | 0    | 0    | 0    | 0    | 0    | 0    |
| 2010 | 0    | 0    | 0    | 0    | 0    | 0    | 0    | 0    | 0    | 0    | 0    | 0    |
| 2011 | 0    | 0    | 0    | 0    | 0    | 0    | 0    | 0    | 0    | 0    | 0    | 0    |
| 2012 | 0    | 0    | 0    | 0    | 0    | 0    | 0    | 0    | 0    | 0    | 0    | 0    |
| 2013 | 0    | 0    | 0    | 0    | 0    | 0    | 0    | 0    | 0    | 0    | 0    | 0    |
| 2014 | 0    | 0    | 0    | 0    | 0    | 0    | 0    | 0    | 0    | 0    | 0    | 0    |
| 2015 | 0    | 0    | 0    | 0    | 0    | 0    | 0    | 0    | 0    | 0    | 0    | 0    |
| 2016 | 0    | 0    | 0    | 0    | 0    | 0    | 0    | 0    | 0    | 0    | 0    | 0    |
| 2017 | 0    | 0    | 0    | 0    | 0    | 0    | 0    | 0    | 0    | 0    | 0    | 0    |
| 2018 | 0    | 0    | 0    | 0    | 0    | 0    | 0    | 0    | 0    | 0    | 0    | 0    |
| 2019 | 0    | 0    | 0    | 0    | 0    | 0    | 0    | 0    | 0    | 0    | 0    | 0    |
| 2020 | 0    | 0    | 0    | 0    | 0    | 0    | 0    | 0    | 0    | 0    | 0    | 0    |
| 2021 | 0    | 0    | 0    | 0    | 0    | 0    | 0    | 0    | 0    | 0    | 0    | 0    |
| 2022 | 0    | 0    | 0    | 0    | 0    | 0    | 0    | 0    | 0    | 0    | 0    | 0    |
| 2023 | 0    | 0    | 0    | 0    | 0    | 0    | 0    | 0    | 0    | 0    | 0    | 0    |
| 2024 | 0    | 0    | 0    | 0    | 0    | 0    | 0    | 0    | 0    | 0    | 0    | 0    |
| 2025 | 0    | 0    | 0    | 0    | 0    | 0    | 0    | 0    | 0    | 0    | 0    | 0    |
| 2026 | 0    | 0    | 0    | 0    | 0    | 0    | 0    | 0    | 0    | 0    | 0    | 0    |
| 2027 | 0    | 0    | 0    | 0    | 0    | 0    | 0    | 0    | 0    | 0    | 0    | 0    |
| 2028 | 0    | 0    | 0    | 0    | 0    | 0    | 0    | 0    | 0    | 0    | 0    | 0    |
| 2029 | 0    | 0    | 0    | 0    | 0    | 0    | 0    | 0    | 0    | 0    | 0    | 0    |
| 2030 | 0    | 0    | 0    | 0    | 0    | 0    | 0    | 0    | 0    | 0    | 0    | 0    |
| 2031 | 0    | 0    | 0    | 0    | 0    | 0    | 0    | 0    | 0    | 0    | 0    | 0    |
| 2032 | 0    | 0    | 0    | 0    | 0    | 0    | 0    | 0    | 0    | 0    | 0    | 0    |
| 2033 | 0    | 0    | 0    | 0    | 0    | 0    | 0    | 0    | 0    | 0    | 0    | 0    |
| 2034 | 0    | 0    | 0    | 0    | 0    | 0    | 0    | 0    | 0    | 0    | 0    | 0    |
| 2035 | 0    | 0    | 0    | 0    | 0    | 0    | 0    | 0    | 0    | 0    | 0    | 0    |
| 2036 | 0    | 0    | 0    | 0    | 0    | 0    | 0    | 0    | 0    | 0    | 0    | 0    |
| 2037 | 0    | 0    | 0    | 0    | 0    | 0    | 0    | 0    | 0    | 0    | 0    | 0    |
| 2038 | 0    | 0    | 0    | 0    | 0    | 0    | 0    | 0    | 0    | 0    | 0    | 0    |
| 2039 | 0    | 0    | 0    | 0    | 0    | 0    | 0    | 0    | 0    | 0    | 0    | 0    |
| 2040 | 0    | 0    | 0    | 0    | 0    | 0    | 0    | 0    | 0    | 0    | 0    | 0    |
| 2041 | 0    | 0    | 0    | 0    | 0    | 0    | 0    | 0    | 0    | 0    | 0    | 0    |
| 2042 | 0    | 0    | 0    | 0    | 0    | 0    | 0    | 0    | 0    | 0    | 0    | 0    |
| 2043 | 0    | 0    | 0    | 0    | 0    | 0    | 49   | 0    | 0    | 0    | 0    | 0    |
| 2044 | 0    | 0    | 0    | 0    | 0    | 0    | 398  | 0    | 0    | 0    | 0    | 0    |
| 2045 | 0    | 0    | 0    | 9    | 9    | 0    | 744  | 2    | 41   | 9    | 9    | 9    |
| 2046 | 0    | 0    | 0    | 383  | 383  | 0    | 1036 | 374  | 389  | 383  | 383  | 383  |
| 2047 | 0    | 0    | 0    | 715  | 715  | 0    | 1273 | 706  | 712  | 715  | 715  | 715  |
| 2048 | 397  | 397  | 397  | 969  | 969  | 3    | 1439 | 960  | 976  | 969  | 969  | 969  |
| 2049 | 739  | 739  | 739  | 1159 | 1159 | 405  | 1546 | 1150 | 1152 | 1159 | 1159 | 1159 |
| 2050 | 985  | 985  | 985  | 1336 | 1336 | 683  | 1637 | 1334 | 1298 | 1336 | 1336 | 1336 |
| 2051 | 1175 | 1175 | 1175 | 1449 | 1449 | 870  | 1706 | 1448 | 1397 | 1449 | 1449 | 1449 |
| 2052 | 1359 | 1359 | 1359 | 1497 | 1497 | 1037 | 1754 | 1496 | 1446 | 1497 | 1497 | 1497 |
| 2053 | 1473 | 1473 | 1473 | 1534 | 1534 | 1139 | 1784 | 1533 | 1483 | 1534 | 1534 | 1534 |
| 2054 | 1521 | 1521 | 1521 | 1570 | 1570 | 1183 | 1808 | 1569 | 1521 | 1570 | 1570 | 1570 |
| 2055 | 1558 | 1558 | 1558 | 1609 | 1609 | 1219 | 1826 | 1608 | 1548 | 1609 | 1609 | 1609 |
| 2056 | 1594 | 1594 | 1594 | 1643 | 1643 | 1255 | 1839 | 1642 | 1564 | 1643 | 1643 | 1643 |
| 2057 | 1633 | 1633 | 1633 | 1655 | 1655 | 1276 | 1841 | 1654 | 1564 | 1655 | 1655 | 1655 |
| 2058 | 1667 | 1667 | 1667 | 1658 | 1658 | 1291 | 1842 | 1657 | 1564 | 1658 | 1658 | 1658 |
| 2059 | 1679 | 1679 | 1679 | 1659 | 1659 | 1293 | 1842 | 1658 | 1564 | 1659 | 1659 | 1659 |
| 2060 | 1682 | 1682 | 1682 | 1659 | 1659 | 1293 | 1842 | 1658 | 1564 | 1659 | 1659 | 1659 |
| 2061 | 1683 | 1683 | 1683 | 1659 | 1659 | 1293 | 1842 | 1658 | 1564 | 1659 | 1659 | 1659 |
| 2062 | 1683 | 1683 | 1683 | 1659 | 1659 | 1293 | 1842 | 1658 | 1564 | 1659 | 1659 | 1659 |
| 2063 | 1683 | 1683 | 1683 | 1659 | 1659 | 1293 | 1842 | 1658 | 1564 | 1659 | 1659 | 1659 |
| 2064 | 1683 | 1683 | 1683 | 1659 | 1659 | 1293 | 1842 | 1658 | 1564 | 1659 | 1659 | 1659 |
| 2065 | 1683 | 1683 | 1683 | 1659 | 1659 | 1293 | 1842 | 1658 | 1564 | 1659 | 1659 | 1659 |
| 2066 | 1683 | 1683 | 1683 | 1659 | 1659 | 1293 | 1842 | 1658 | 1564 | 1659 | 1659 | 1659 |
| 2067 | 1683 | 1683 | 1683 | 1659 | 1659 | 1293 | 1842 | 1658 | 1564 | 1659 | 1659 | 1659 |
| 2068 | 1683 | 1683 | 1683 | 1659 | 1659 | 1293 | 1842 | 1658 | 1564 | 1659 | 1659 | 1659 |

|      | 97   | 98   | 99   | 100  | 101  | 102  | 103  | 104  | 105  | 106  | 107  | 108  |
|------|------|------|------|------|------|------|------|------|------|------|------|------|
| 2069 | 1683 | 1683 | 1683 | 1659 | 1659 | 1293 | 1842 | 1658 | 1564 | 1659 | 1659 | 1659 |
| 2070 | 1683 | 1683 | 1683 | 1659 | 1659 | 1293 | 1842 | 1658 | 1564 | 1659 | 1659 | 1659 |
| 2071 | 1683 | 1683 | 1683 | 1659 | 1659 | 1293 | 1842 | 1658 | 1564 | 1659 | 1659 | 1659 |
| 2072 | 1683 | 1683 | 1683 | 1659 | 1659 | 1293 | 1842 | 1658 | 1564 | 1659 | 1659 | 1659 |
| 2073 | 1683 | 1683 | 1683 | 1659 | 1659 | 1293 | 1842 | 1658 | 1564 | 1659 | 1659 | 1659 |
| 2074 | 1683 | 1683 | 1683 | 1659 | 1659 | 1293 | 1842 | 1658 | 1564 | 1659 | 1659 | 1659 |
| 2075 | 1683 | 1683 | 1683 | 1659 | 1659 | 1293 | 1842 | 1658 | 1564 | 1659 | 1659 | 1659 |
| 2076 | 1683 | 1683 | 1683 | 1659 | 1659 | 1293 | 1842 | 1658 | 1564 | 1659 | 1659 | 1659 |
| 2077 | 1683 | 1683 | 1683 | 1659 | 1659 | 1293 | 1842 | 1658 | 1564 | 1659 | 1659 | 1659 |
| 2078 | 1683 | 1683 | 1683 | 1659 | 1659 | 1293 | 1842 | 1658 | 1564 | 1659 | 1659 | 1659 |
| 2079 | 1683 | 1683 | 1683 | 1659 | 1659 | 1293 | 1842 | 1658 | 1564 | 1659 | 1659 | 1659 |
| 2080 | 1683 | 1683 | 1683 | 1659 | 1659 | 1293 | 1842 | 1658 | 1564 | 1659 | 1659 | 1659 |
| 2081 | 1683 | 1683 | 1683 | 1659 | 1659 | 1293 | 1842 | 1658 | 1564 | 1659 | 1659 | 1659 |
| 2082 | 1683 | 1683 | 1683 | 1659 | 1659 | 1293 | 1842 | 1658 | 1564 | 1659 | 1659 | 1659 |
| 2083 | 1683 | 1683 | 1683 | 1659 | 1659 | 1293 | 1842 | 1658 | 1564 | 1659 | 1659 | 1659 |
| 2084 | 1683 | 1683 | 1683 | 1659 | 1659 | 1293 | 1842 | 1658 | 1564 | 1659 | 1659 | 1659 |
| 2085 | 1683 | 1683 | 1683 | 1659 | 1659 | 1293 | 1842 | 1658 | 1564 | 1659 | 1659 | 1659 |
| 2086 | 1683 | 1683 | 1683 | 1659 | 1659 | 1293 | 1842 | 1658 | 1564 | 1659 | 1659 | 1659 |
| 2087 | 1683 | 1683 | 1683 | 1659 | 1659 | 1293 | 1842 | 1658 | 1564 | 1659 | 1659 | 1659 |
| 2088 | 1683 | 1683 | 1683 | 1659 | 1659 | 1293 | 1842 | 1658 | 1564 | 1659 | 1659 | 1659 |
| 2089 | 1683 | 1683 | 1683 | 1659 | 1659 | 1293 | 1842 | 1658 | 1564 | 1659 | 1659 | 1659 |
| 2090 | 1683 | 1683 | 1683 | 1659 | 1659 | 1293 | 1842 | 1658 | 1564 | 1659 | 1659 | 1659 |



|      | 109  | 110  | 111  | 112  | 113  | 114  | 115  | 116  | 117  | 118  | 119  | 120  |
|------|------|------|------|------|------|------|------|------|------|------|------|------|
| 2002 | 0    | 0    | 0    | 0    | 0    | 0    | 0    | 0    | 0    | 0    | 0    | 0    |
| 2003 | 0    | 0    | 0    | 0    | 0    | 0    | 0    | 0    | 0    | 0    | 0    | 0    |
| 2004 | 0    | 0    | 0    | 0    | 0    | 0    | 0    | 0    | 0    | 0    | 0    | 0    |
| 2005 | 0    | 0    | 0    | 0    | 0    | 0    | 0    | 0    | 0    | 0    | 0    | 0    |
| 2006 | 0    | 0    | 0    | 0    | 0    | 0    | 0    | 0    | 0    | 0    | 0    | 0    |
| 2007 | 0    | 0    | 0    | 0    | 0    | 0    | 0    | 0    | 0    | 0    | 0    | 0    |
| 2008 | 0    | 0    | 0    | 0    | 0    | 0    | 0    | 0    | 0    | 0    | 0    | 0    |
| 2009 | 0    | 0    | 0    | 0    | 0    | 0    | 0    | 0    | 0    | 0    | 0    | 0    |
| 2010 | 0    | 0    | 0    | 0    | 0    | 0    | 0    | 0    | 0    | 0    | 0    | 0    |
| 2011 | 0    | 0    | 0    | 0    | 0    | 0    | 0    | 0    | 0    | 0    | 0    | 0    |
| 2012 | 0    | 0    | 0    | 0    | 0    | 0    | 0    | 0    | 0    | 0    | 0    | 0    |
| 2013 | 0    | 0    | 0    | 0    | 0    | 0    | 0    | 0    | 0    | 0    | 0    | 0    |
| 2014 | 0    | 0    | 0    | 0    | 0    | 0    | 0    | 0    | 0    | 0    | 0    | 0    |
| 2015 | 0    | 0    | 0    | 0    | 0    | 0    | 0    | 0    | 0    | 0    | 0    | 0    |
| 2016 | 0    | 0    | 0    | 0    | 0    | 0    | 0    | 0    | 0    | 0    | 0    | 0    |
| 2017 | 0    | 0    | 0    | 0    | 0    | 0    | 0    | 0    | 0    | 0    | 0    | 0    |
| 2018 | 0    | 0    | 0    | 0    | 0    | 0    | 0    | 0    | 0    | 0    | 0    | 0    |
| 2019 | 0    | 0    | 0    | 0    | 0    | 0    | 0    | 0    | 0    | 0    | 0    | 0    |
| 2020 | 0    | 0    | 0    | 0    | 0    | 0    | 0    | 0    | 0    | 0    | 0    | 0    |
| 2021 | 0    | 0    | 0    | 0    | 0    | 0    | 0    | 0    | 0    | 0    | 0    | 0    |
| 2022 | 0    | 0    | 0    | 0    | 0    | 0    | 0    | 0    | 0    | 0    | 0    | 0    |
| 2023 | 0    | 0    | 0    | 0    | 0    | 0    | 0    | 0    | 0    | 0    | 0    | 0    |
| 2024 | 0    | 0    | 0    | 0    | 0    | 0    | 0    | 0    | 0    | 0    | 0    | 0    |
| 2025 | 0    | 0    | 0    | 0    | 0    | 0    | 0    | 0    | 0    | 0    | 0    | 0    |
| 2026 | 0    | 0    | 0    | 0    | 0    | 0    | 0    | 0    | 0    | 0    | 0    | 0    |
| 2027 | 0    | 0    | 0    | 0    | 0    | 0    | 0    | 0    | 0    | 0    | 0    | 0    |
| 2028 | 0    | 0    | 0    | 0    | 0    | 0    | 0    | 0    | 0    | 0    | 0    | 0    |
| 2029 | 0    | 0    | 0    | 0    | 0    | 0    | 0    | 0    | 0    | 0    | 0    | 0    |
| 2030 | 0    | 0    | 0    | 0    | 0    | 0    | 0    | 0    | 0    | 0    | 0    | 0    |
| 2031 | 0    | 0    | 0    | 0    | 0    | 0    | 0    | 0    | 0    | 0    | 0    | 0    |
| 2032 | 0    | 0    | 0    | 0    | 0    | 0    | 0    | 0    | 0    | 0    | 0    | 0    |
| 2033 | 0    | 0    | 0    | 0    | 0    | 0    | 0    | 0    | 0    | 0    | 0    | 0    |
| 2034 | 0    | 0    | 0    | 0    | 0    | 0    | 0    | 0    | 0    | 0    | 0    | 0    |
| 2035 | 0    | 0    | 0    | 0    | 0    | 0    | 0    | 0    | 0    | 0    | 0    | 0    |
| 2036 | 0    | 0    | 0    | 0    | 0    | 0    | 0    | 0    | 0    | 0    | 0    | 0    |
| 2037 | 0    | 0    | 0    | 0    | 0    | 0    | 0    | 0    | 0    | 0    | 0    | 0    |
| 2038 | 0    | 0    | 0    | 0    | 0    | 0    | 0    | 0    | 0    | 0    | 0    | 0    |
| 2039 | 0    | 0    | 0    | 0    | 0    | 0    | 0    | 0    | 0    | 0    | 0    | 0    |
| 2040 | 0    | 0    | 0    | 0    | 0    | 0    | 0    | 0    | 0    | 0    | 0    | 0    |
| 2041 | 0    | 0    | 0    | 0    | 0    | 0    | 0    | 0    | 0    | 0    | 0    | 0    |
| 2042 | 0    | 0    | 0    | 638  | 0    | 0    | 0    | 0    | 0    | 0    | 0    | 0    |
| 2043 | 62   | 58   | 0    | 1060 | 57   | 58   | 71   | 71   | 71   | 0    | 0    | 0    |
| 2044 | 716  | 714  | 0    | 1308 | 712  | 707  | 725  | 725  | 725  | 0    | 0    | 0    |
| 2045 | 1102 | 1100 | 52   | 1426 | 1097 | 1104 | 1109 | 1109 | 1109 | 0    | 0    | 0    |
| 2046 | 1284 | 1282 | 806  | 1486 | 1279 | 1296 | 1287 | 1287 | 1287 | 0    | 0    | 0    |
| 2047 | 1371 | 1369 | 1151 | 1523 | 1351 | 1383 | 1359 | 1359 | 1359 | 0    | 0    | 0    |
| 2048 | 1456 | 1454 | 1310 | 1579 | 1427 | 1467 | 1435 | 1435 | 1435 | 0    | 0    | 404  |
| 2049 | 1467 | 1464 | 1398 | 1589 | 1437 | 1478 | 1445 | 1445 | 1445 | 421  | 421  | 682  |
| 2050 | 1476 | 1473 | 1411 | 1598 | 1446 | 1488 | 1454 | 1454 | 1454 | 763  | 763  | 869  |
| 2051 | 1491 | 1488 | 1427 | 1613 | 1461 | 1504 | 1469 | 1469 | 1469 | 1009 | 1009 | 1036 |
| 2052 | 1496 | 1493 | 1432 | 1618 | 1466 | 1509 | 1474 | 1474 | 1474 | 1199 | 1199 | 1138 |
| 2053 | 1496 | 1493 | 1432 | 1618 | 1466 | 1509 | 1474 | 1474 | 1474 | 1383 | 1383 | 1182 |
| 2054 | 1509 | 1506 | 1445 | 1631 | 1479 | 1522 | 1487 | 1487 | 1487 | 1497 | 1497 | 1218 |
| 2055 | 1511 | 1508 | 1447 | 1633 | 1481 | 1524 | 1489 | 1489 | 1489 | 1545 | 1545 | 1254 |
| 2056 | 1521 | 1518 | 1457 | 1643 | 1491 | 1534 | 1499 | 1499 | 1499 | 1582 | 1582 | 1275 |
| 2057 | 1521 | 1518 | 1457 | 1643 | 1491 | 1534 | 1499 | 1499 | 1499 | 1618 | 1618 | 1290 |
| 2058 | 1521 | 1518 | 1457 | 1643 | 1491 | 1534 | 1499 | 1499 | 1499 | 1657 | 1657 | 1292 |
| 2059 | 1521 | 1518 | 1457 | 1643 | 1491 | 1534 | 1499 | 1499 | 1499 | 1691 | 1691 | 1292 |
| 2060 | 1521 | 1518 | 1457 | 1643 | 1491 | 1534 | 1499 | 1499 | 1499 | 1703 | 1703 | 1292 |
| 2061 | 1521 | 1518 | 1457 | 1643 | 1491 | 1534 | 1499 | 1499 | 1499 | 1706 | 1706 | 1292 |
| 2062 | 1521 | 1518 | 1457 | 1643 | 1491 | 1534 | 1499 | 1499 | 1499 | 1707 | 1707 | 1292 |
| 2063 | 1521 | 1518 | 1457 | 1643 | 1491 | 1534 | 1499 | 1499 | 1499 | 1707 | 1707 | 1292 |
| 2064 | 1521 | 1518 | 1457 | 1643 | 1491 | 1534 | 1499 | 1499 | 1499 | 1707 | 1707 | 1292 |
| 2065 | 1521 | 1518 | 1457 | 1643 | 1491 | 1534 | 1499 | 1499 | 1499 | 1707 | 1707 | 1292 |
| 2066 | 1521 | 1518 | 1457 | 1643 | 1491 | 1534 | 1499 | 1499 | 1499 | 1707 | 1707 | 1292 |
| 2067 | 1521 | 1518 | 1457 | 1643 | 1491 | 1534 | 1499 | 1499 | 1499 | 1707 | 1707 | 1292 |
| 2068 | 1521 | 1518 | 1457 | 1643 | 1491 | 1534 | 1499 | 1499 | 1499 | 1707 | 1707 | 1292 |

|      | 109  | 110  | 111  | 112  | 113  | 114  | 115  | 116  | 117  | 118  | 119  | 120  |
|------|------|------|------|------|------|------|------|------|------|------|------|------|
| 2069 | 1521 | 1518 | 1457 | 1643 | 1491 | 1534 | 1499 | 1499 | 1499 | 1707 | 1707 | 1292 |
| 2070 | 1521 | 1518 | 1457 | 1643 | 1491 | 1534 | 1499 | 1499 | 1499 | 1707 | 1707 | 1292 |
| 2071 | 1521 | 1518 | 1457 | 1643 | 1491 | 1534 | 1499 | 1499 | 1499 | 1707 | 1707 | 1292 |
| 2072 | 1521 | 1518 | 1457 | 1643 | 1491 | 1534 | 1499 | 1499 | 1499 | 1707 | 1707 | 1292 |
| 2073 | 1521 | 1518 | 1457 | 1643 | 1491 | 1534 | 1499 | 1499 | 1499 | 1707 | 1707 | 1292 |
| 2074 | 1521 | 1518 | 1457 | 1643 | 1491 | 1534 | 1499 | 1499 | 1499 | 1707 | 1707 | 1292 |
| 2075 | 1521 | 1518 | 1457 | 1643 | 1491 | 1534 | 1499 | 1499 | 1499 | 1707 | 1707 | 1292 |
| 2076 | 1521 | 1518 | 1457 | 1643 | 1491 | 1534 | 1499 | 1499 | 1499 | 1707 | 1707 | 1292 |
| 2077 | 1521 | 1518 | 1457 | 1643 | 1491 | 1534 | 1499 | 1499 | 1499 | 1707 | 1707 | 1292 |
| 2078 | 1521 | 1518 | 1457 | 1643 | 1491 | 1534 | 1499 | 1499 | 1499 | 1707 | 1707 | 1292 |
| 2079 | 1521 | 1518 | 1457 | 1643 | 1491 | 1534 | 1499 | 1499 | 1499 | 1707 | 1707 | 1292 |
| 2080 | 1521 | 1518 | 1457 | 1643 | 1491 | 1534 | 1499 | 1499 | 1499 | 1707 | 1707 | 1292 |
| 2081 | 1521 | 1518 | 1457 | 1643 | 1491 | 1534 | 1499 | 1499 | 1499 | 1707 | 1707 | 1292 |
| 2082 | 1521 | 1518 | 1457 | 1643 | 1491 | 1534 | 1499 | 1499 | 1499 | 1707 | 1707 | 1292 |
| 2083 | 1521 | 1518 | 1457 | 1643 | 1491 | 1534 | 1499 | 1499 | 1499 | 1707 | 1707 | 1292 |
| 2084 | 1521 | 1518 | 1457 | 1643 | 1491 | 1534 | 1499 | 1499 | 1499 | 1707 | 1707 | 1292 |
| 2085 | 1521 | 1518 | 1457 | 1643 | 1491 | 1534 | 1499 | 1499 | 1499 | 1707 | 1707 | 1292 |
| 2086 | 1521 | 1518 | 1457 | 1643 | 1491 | 1534 | 1499 | 1499 | 1499 | 1707 | 1707 | 1292 |
| 2087 | 1521 | 1518 | 1457 | 1643 | 1491 | 1534 | 1499 | 1499 | 1499 | 1707 | 1707 | 1292 |
| 2088 | 1521 | 1518 | 1457 | 1643 | 1491 | 1534 | 1499 | 1499 | 1499 | 1707 | 1707 | 1292 |
| 2089 | 1521 | 1518 | 1457 | 1643 | 1491 | 1534 | 1499 | 1499 | 1499 | 1707 | 1707 | 1292 |
| 2090 | 1521 | 1518 | 1457 | 1643 | 1491 | 1534 | 1499 | 1499 | 1499 | 1707 | 1707 | 1292 |

|      | 121  | 122  | 123  | 124  | 125  | 126  | 127  | 128  | 129  | 130  | 131  | 132  |
|------|------|------|------|------|------|------|------|------|------|------|------|------|
| 2002 | 0    | 0    | 0    | 0    | 0    | 0    | 0    | 0    | 0    | 0    | 0    | 0    |
| 2003 | 0    | 0    | 0    | 0    | 0    | 0    | 0    | 0    | 0    | 0    | 0    | 0    |
| 2004 | 0    | 0    | 0    | 0    | 0    | 0    | 0    | 0    | 0    | 0    | 0    | 0    |
| 2005 | 0    | 0    | 0    | 0    | 0    | 0    | 0    | 0    | 0    | 0    | 0    | 0    |
| 2006 | 0    | 0    | 0    | 0    | 0    | 0    | 0    | 0    | 0    | 0    | 0    | 0    |
| 2007 | 0    | 0    | 0    | 0    | 0    | 0    | 0    | 0    | 0    | 0    | 0    | 0    |
| 2008 | 0    | 0    | 0    | 0    | 0    | 0    | 0    | 0    | 0    | 0    | 0    | 0    |
| 2009 | 0    | 0    | 0    | 0    | 0    | 0    | 0    | 0    | 0    | 0    | 0    | 0    |
| 2010 | 0    | 0    | 0    | 0    | 0    | 0    | 0    | 0    | 0    | 0    | 0    | 0    |
| 2011 | 0    | 0    | 0    | 0    | 0    | 0    | 0    | 0    | 0    | 0    | 0    | 0    |
| 2012 | 0    | 0    | 0    | 0    | 0    | 0    | 0    | 0    | 0    | 0    | 0    | 0    |
| 2013 | 0    | 0    | 0    | 0    | 0    | 0    | 0    | 0    | 0    | 0    | 0    | 0    |
| 2014 | 0    | 0    | 0    | 0    | 0    | 0    | 0    | 0    | 0    | 0    | 0    | 0    |
| 2015 | 0    | 0    | 0    | 0    | 0    | 0    | 0    | 0    | 0    | 0    | 0    | 0    |
| 2016 | 0    | 0    | 0    | 0    | 0    | 0    | 0    | 0    | 0    | 0    | 0    | 0    |
| 2017 | 0    | 0    | 0    | 0    | 0    | 0    | 0    | 0    | 0    | 0    | 0    | 0    |
| 2018 | 0    | 0    | 0    | 0    | 0    | 0    | 0    | 0    | 0    | 0    | 0    | 0    |
| 2019 | 0    | 0    | 0    | 0    | 0    | 0    | 0    | 0    | 0    | 0    | 0    | 0    |
| 2020 | 0    | 0    | 0    | 0    | 0    | 0    | 0    | 0    | 0    | 0    | 0    | 0    |
| 2021 | 0    | 0    | 0    | 0    | 0    | 0    | 0    | 0    | 0    | 0    | 0    | 0    |
| 2022 | 0    | 0    | 0    | 0    | 0    | 0    | 0    | 0    | 0    | 0    | 0    | 0    |
| 2023 | 0    | 0    | 0    | 0    | 0    | 0    | 0    | 0    | 0    | 0    | 0    | 0    |
| 2024 | 0    | 0    | 0    | 0    | 0    | 0    | 0    | 0    | 0    | 0    | 0    | 0    |
| 2025 | 0    | 0    | 0    | 0    | 0    | 0    | 0    | 0    | 0    | 0    | 0    | 0    |
| 2026 | 0    | 0    | 0    | 0    | 0    | 0    | 0    | 0    | 0    | 0    | 0    | 0    |
| 2027 | 0    | 0    | 0    | 0    | 0    | 0    | 0    | 0    | 0    | 0    | 0    | 0    |
| 2028 | 0    | 0    | 0    | 0    | 0    | 0    | 0    | 0    | 0    | 0    | 0    | 0    |
| 2029 | 0    | 0    | 0    | 0    | 0    | 0    | 0    | 0    | 0    | 0    | 0    | 0    |
| 2030 | 0    | 0    | 0    | 0    | 0    | 0    | 0    | 0    | 0    | 0    | 0    | 0    |
| 2031 | 0    | 0    | 0    | 0    | 0    | 0    | 0    | 0    | 0    | 0    | 0    | 0    |
| 2032 | 0    | 0    | 0    | 0    | 0    | 0    | 0    | 0    | 0    | 0    | 0    | 0    |
| 2033 | 0    | 0    | 0    | 0    | 0    | 0    | 0    | 0    | 0    | 0    | 0    | 0    |
| 2034 | 0    | 0    | 0    | 0    | 0    | 0    | 0    | 0    | 0    | 0    | 0    | 0    |
| 2035 | 0    | 0    | 0    | 0    | 0    | 0    | 0    | 0    | 0    | 0    | 0    | 0    |
| 2036 | 0    | 0    | 0    | 0    | 0    | 0    | 0    | 0    | 0    | 0    | 0    | 0    |
| 2037 | 0    | 0    | 0    | 0    | 0    | 0    | 0    | 0    | 0    | 0    | 0    | 0    |
| 2038 | 0    | 0    | 0    | 0    | 0    | 0    | 0    | 0    | 0    | 0    | 0    | 0    |
| 2039 | 0    | 0    | 0    | 0    | 0    | 0    | 0    | 0    | 0    | 0    | 0    | 0    |
| 2040 | 0    | 0    | 0    | 0    | 0    | 0    | 0    | 0    | 0    | 0    | 0    | 0    |
| 2041 | 0    | 0    | 0    | 0    | 0    | 0    | 0    | 0    | 0    | 0    | 0    | 0    |
| 2042 | 0    | 0    | 0    | 0    | 0    | 0    | 0    | 0    | 0    | 0    | 0    | 0    |
| 2043 | 0    | 0    | 0    | 0    | 0    | 0    | 0    | 0    | 0    | 0    | 0    | 0    |
| 2044 | 0    | 0    | 0    | 0    | 0    | 0    | 0    | 0    | 0    | 0    | 0    | 0    |
| 2045 | 0    | 0    | 0    | 0    | 0    | 0    | 0    | 0    | 0    | 17   | 0    | 0    |
| 2046 | 0    | 0    | 0    | 0    | 0    | 0    | 0    | 0    | 0    | 392  | 13   | 0    |
| 2047 | 0    | 0    | 0    | 0    | 0    | 0    | 421  | 421  | 2    | 741  | 404  | 3    |
| 2048 | 1    | 421  | 1    | 0    | 0    | 0    | 763  | 763  | 407  | 1041 | 745  | 404  |
| 2049 | 373  | 763  | 397  | 421  | 421  | 421  | 1009 | 1009 | 685  | 1278 | 990  | 745  |
| 2050 | 739  | 1009 | 739  | 763  | 763  | 763  | 1199 | 1199 | 872  | 1478 | 1180 | 992  |
| 2051 | 1031 | 1199 | 985  | 1009 | 1009 | 1009 | 1383 | 1383 | 1039 | 1618 | 1364 | 1183 |
| 2052 | 1266 | 1383 | 1175 | 1199 | 1199 | 1199 | 1497 | 1497 | 1141 | 1730 | 1478 | 1366 |
| 2053 | 1472 | 1497 | 1359 | 1383 | 1383 | 1383 | 1545 | 1545 | 1185 | 1802 | 1526 | 1479 |
| 2054 | 1636 | 1545 | 1472 | 1497 | 1497 | 1497 | 1582 | 1582 | 1221 | 1850 | 1563 | 1527 |
| 2055 | 1761 | 1582 | 1520 | 1545 | 1545 | 1545 | 1618 | 1618 | 1257 | 1889 | 1600 | 1564 |
| 2056 | 1833 | 1618 | 1557 | 1582 | 1582 | 1582 | 1657 | 1660 | 1278 | 1925 | 1649 | 1600 |
| 2057 | 1880 | 1657 | 1593 | 1618 | 1618 | 1618 | 1691 | 1695 | 1293 | 1950 | 1683 | 1639 |
| 2058 | 1920 | 1691 | 1632 | 1657 | 1657 | 1657 | 1703 | 1707 | 1295 | 1974 | 1695 | 1673 |
| 2059 | 1956 | 1703 | 1666 | 1691 | 1691 | 1691 | 1706 | 1710 | 1295 | 1989 | 1698 | 1685 |
| 2060 | 1992 | 1706 | 1678 | 1703 | 1703 | 1703 | 1707 | 1711 | 1295 | 1994 | 1699 | 1688 |
| 2061 | 2026 | 1707 | 1681 | 1706 | 1706 | 1706 | 1707 | 1711 | 1295 | 1994 | 1699 | 1689 |
| 2062 | 2042 | 1707 | 1682 | 1707 | 1707 | 1707 | 1707 | 1711 | 1295 | 1994 | 1699 | 1689 |
| 2063 | 2047 | 1707 | 1682 | 1707 | 1707 | 1707 | 1707 | 1711 | 1295 | 1994 | 1699 | 1689 |
| 2064 | 2047 | 1707 | 1682 | 1707 | 1707 | 1707 | 1707 | 1711 | 1295 | 1994 | 1699 | 1689 |
| 2065 | 2047 | 1707 | 1682 | 1707 | 1707 | 1707 | 1707 | 1711 | 1295 | 1994 | 1699 | 1689 |
| 2066 | 2047 | 1707 | 1682 | 1707 | 1707 | 1707 | 1707 | 1711 | 1295 | 1994 | 1699 | 1689 |
| 2067 | 2047 | 1707 | 1682 | 1707 | 1707 | 1707 | 1707 | 1711 | 1295 | 1994 | 1699 | 1689 |
| 2068 | 2047 | 1707 | 1682 | 1707 | 1707 | 1707 | 1707 | 1711 | 1295 | 1994 | 1699 | 1689 |

|      | 121  | 122  | 123  | 124  | 125  | 126  | 127  | 128  | 129  | 130  | 131  | 132  |
|------|------|------|------|------|------|------|------|------|------|------|------|------|
| 2069 | 2047 | 1707 | 1682 | 1707 | 1707 | 1707 | 1707 | 1711 | 1295 | 1994 | 1699 | 1689 |
| 2070 | 2047 | 1707 | 1682 | 1707 | 1707 | 1707 | 1707 | 1711 | 1295 | 1994 | 1699 | 1689 |
| 2071 | 2047 | 1707 | 1682 | 1707 | 1707 | 1707 | 1707 | 1711 | 1295 | 1994 | 1699 | 1689 |
| 2072 | 2047 | 1707 | 1682 | 1707 | 1707 | 1707 | 1707 | 1711 | 1295 | 1994 | 1699 | 1689 |
| 2073 | 2047 | 1707 | 1682 | 1707 | 1707 | 1707 | 1707 | 1711 | 1295 | 1994 | 1699 | 1689 |
| 2074 | 2047 | 1707 | 1682 | 1707 | 1707 | 1707 | 1707 | 1711 | 1295 | 1994 | 1699 | 1689 |
| 2075 | 2047 | 1707 | 1682 | 1707 | 1707 | 1707 | 1707 | 1711 | 1295 | 1994 | 1699 | 1689 |
| 2076 | 2047 | 1707 | 1682 | 1707 | 1707 | 1707 | 1707 | 1711 | 1295 | 1994 | 1699 | 1689 |
| 2077 | 2047 | 1707 | 1682 | 1707 | 1707 | 1707 | 1707 | 1711 | 1295 | 1994 | 1699 | 1689 |
| 2078 | 2047 | 1707 | 1682 | 1707 | 1707 | 1707 | 1707 | 1711 | 1295 | 1994 | 1699 | 1689 |
| 2079 | 2047 | 1707 | 1682 | 1707 | 1707 | 1707 | 1707 | 1711 | 1295 | 1994 | 1699 | 1689 |
| 2080 | 2047 | 1707 | 1682 | 1707 | 1707 | 1707 | 1707 | 1711 | 1295 | 1994 | 1699 | 1689 |
| 2081 | 2047 | 1707 | 1682 | 1707 | 1707 | 1707 | 1707 | 1711 | 1295 | 1994 | 1699 | 1689 |
| 2082 | 2047 | 1707 | 1682 | 1707 | 1707 | 1707 | 1707 | 1711 | 1295 | 1994 | 1699 | 1689 |
| 2083 | 2047 | 1707 | 1682 | 1707 | 1707 | 1707 | 1707 | 1711 | 1295 | 1994 | 1699 | 1689 |
| 2084 | 2047 | 1707 | 1682 | 1707 | 1707 | 1707 | 1707 | 1711 | 1295 | 1994 | 1699 | 1689 |
| 2085 | 2047 | 1707 | 1682 | 1707 | 1707 | 1707 | 1707 | 1711 | 1295 | 1994 | 1699 | 1689 |
| 2086 | 2047 | 1707 | 1682 | 1707 | 1707 | 1707 | 1707 | 1711 | 1295 | 1994 | 1699 | 1689 |
| 2087 | 2047 | 1707 | 1682 | 1707 | 1707 | 1707 | 1707 | 1711 | 1295 | 1994 | 1699 | 1689 |
| 2088 | 2047 | 1707 | 1682 | 1707 | 1707 | 1707 | 1707 | 1711 | 1295 | 1994 | 1699 | 1689 |
| 2089 | 2047 | 1707 | 1682 | 1707 | 1707 | 1707 | 1707 | 1711 | 1295 | 1994 | 1699 | 1689 |
| 2090 | 2047 | 1707 | 1682 | 1707 | 1707 | 1707 | 1707 | 1711 | 1295 | 1994 | 1699 | 1689 |

|      | 133  | 134  | 135  | 136  | 137  | 138  | 139  | 140  | 141  | 142  |
|------|------|------|------|------|------|------|------|------|------|------|
| 2002 | 0    | 0    | 0    | 0    | 0    | 0    | 0    | 0    | 0    | 0    |
| 2003 | 0    | 0    | 0    | 0    | 0    | 0    | 0    | 0    | 0    | 0    |
| 2004 | 0    | 0    | 0    | 0    | 0    | 0    | 0    | 0    | 0    | 0    |
| 2005 | 0    | 0    | 0    | 0    | 0    | 0    | 0    | 0    | 0    | 0    |
| 2006 | 0    | 0    | 0    | 0    | 0    | 0    | 0    | 0    | 0    | 0    |
| 2007 | 0    | 0    | 0    | 0    | 0    | 0    | 0    | 0    | 0    | 0    |
| 2008 | 0    | 0    | 0    | 0    | 0    | 0    | 0    | 0    | 0    | 0    |
| 2009 | 0    | 0    | 0    | 0    | 0    | 0    | 0    | 0    | 0    | 0    |
| 2010 | 0    | 0    | 0    | 0    | 0    | 0    | 0    | 0    | 0    | 0    |
| 2011 | 0    | 0    | 0    | 0    | 0    | 0    | 0    | 0    | 0    | 0    |
| 2012 | 0    | 0    | 0    | 0    | 0    | 0    | 0    | 0    | 0    | 0    |
| 2013 | 0    | 0    | 0    | 0    | 0    | 0    | 0    | 0    | 0    | 0    |
| 2014 | 0    | 0    | 0    | 0    | 0    | 0    | 0    | 0    | 0    | 0    |
| 2015 | 0    | 0    | 0    | 0    | 0    | 0    | 0    | 0    | 0    | 0    |
| 2016 | 0    | 0    | 0    | 0    | 0    | 0    | 0    | 0    | 0    | 0    |
| 2017 | 0    | 0    | 0    | 0    | 0    | 0    | 0    | 0    | 0    | 0    |
| 2018 | 0    | 0    | 0    | 0    | 0    | 0    | 0    | 0    | 0    | 0    |
| 2019 | 0    | 0    | 0    | 0    | 0    | 0    | 0    | 0    | 0    | 0    |
| 2020 | 0    | 0    | 0    | 0    | 0    | 0    | 0    | 0    | 0    | 0    |
| 2021 | 0    | 0    | 0    | 0    | 0    | 0    | 0    | 0    | 0    | 0    |
| 2022 | 0    | 0    | 0    | 0    | 0    | 0    | 0    | 0    | 0    | 0    |
| 2023 | 0    | 0    | 0    | 0    | 0    | 0    | 0    | 0    | 0    | 0    |
| 2024 | 0    | 0    | 0    | 0    | 0    | 0    | 0    | 0    | 0    | 0    |
| 2025 | 0    | 0    | 0    | 0    | 0    | 0    | 0    | 0    | 0    | 0    |
| 2026 | 0    | 0    | 0    | 0    | 0    | 0    | 0    | 0    | 0    | 0    |
| 2027 | 0    | 0    | 0    | 0    | 0    | 0    | 0    | 0    | 0    | 0    |
| 2028 | 0    | 0    | 0    | 0    | 0    | 0    | 0    | 0    | 0    | 0    |
| 2029 | 0    | 0    | 0    | 0    | 0    | 0    | 0    | 0    | 0    | 0    |
| 2030 | 0    | 0    | 0    | 0    | 0    | 0    | 0    | 0    | 0    | 0    |
| 2031 | 0    | 0    | 0    | 0    | 0    | 0    | 0    | 0    | 0    | 0    |
| 2032 | 0    | 0    | 0    | 0    | 0    | 0    | 0    | 0    | 0    | 0    |
| 2033 | 0    | 0    | 0    | 0    | 0    | 0    | 0    | 0    | 0    | 0    |
| 2034 | 0    | 0    | 0    | 0    | 0    | 0    | 0    | 0    | 0    | 0    |
| 2035 | 0    | 0    | 0    | 0    | 0    | 0    | 0    | 0    | 0    | 0    |
| 2036 | 0    | 0    | 0    | 0    | 0    | 0    | 0    | 0    | 0    | 0    |
| 2037 | 0    | 0    | 0    | 0    | 0    | 0    | 0    | 0    | 0    | 0    |
| 2038 | 0    | 0    | 0    | 0    | 0    | 0    | 0    | 0    | 0    | 0    |
| 2039 | 0    | 0    | 0    | 0    | 0    | 0    | 0    | 0    | 0    | 0    |
| 2040 | 0    | 0    | 0    | 0    | 0    | 0    | 0    | 0    | 0    | 0    |
| 2041 | 0    | 0    | 0    | 0    | 0    | 0    | 0    | 0    | 0    | 0    |
| 2042 | 0    | 0    | 0    | 0    | 0    | 0    | 86   | 0    | 0    | 0    |
| 2043 | 0    | 0    | 0    | 0    | 0    | 0    | 703  | 0    | 0    | 0    |
| 2044 | 0    | 0    | 0    | 24   | 0    | 0    | 1095 | 5    | 0    | 0    |
| 2045 | 0    | 0    | 0    | 684  | 674  | 0    | 1323 | 694  | 64   | 678  |
| 2046 | 0    | 0    | 0    | 1074 | 1076 | 0    | 1407 | 1096 | 734  | 1080 |
| 2047 | 421  | 421  | 421  | 1267 | 1270 | 0    | 1448 | 1290 | 1117 | 1274 |
| 2048 | 763  | 763  | 763  | 1375 | 1390 | 84   | 1504 | 1410 | 1342 | 1394 |
| 2049 | 1009 | 1009 | 1009 | 1411 | 1429 | 774  | 1513 | 1449 | 1405 | 1433 |
| 2050 | 1199 | 1199 | 1199 | 1421 | 1440 | 1119 | 1522 | 1460 | 1443 | 1444 |
| 2051 | 1383 | 1383 | 1383 | 1436 | 1455 | 1251 | 1537 | 1475 | 1459 | 1459 |
| 2052 | 1497 | 1497 | 1497 | 1441 | 1460 | 1349 | 1542 | 1480 | 1464 | 1464 |
| 2053 | 1545 | 1545 | 1545 | 1441 | 1460 | 1365 | 1542 | 1480 | 1464 | 1464 |
| 2054 | 1582 | 1582 | 1582 | 1454 | 1473 | 1381 | 1555 | 1493 | 1477 | 1477 |
| 2055 | 1618 | 1618 | 1618 | 1456 | 1475 | 1383 | 1557 | 1495 | 1479 | 1479 |
| 2056 | 1659 | 1659 | 1659 | 1466 | 1485 | 1393 | 1567 | 1505 | 1489 | 1489 |
| 2057 | 1694 | 1694 | 1694 | 1466 | 1485 | 1393 | 1567 | 1505 | 1489 | 1489 |
| 2058 | 1706 | 1706 | 1706 | 1466 | 1485 | 1393 | 1567 | 1505 | 1489 | 1489 |
| 2059 | 1709 | 1709 | 1709 | 1466 | 1485 | 1393 | 1567 | 1505 | 1489 | 1489 |
| 2060 | 1710 | 1710 | 1710 | 1466 | 1485 | 1393 | 1567 | 1505 | 1489 | 1489 |
| 2061 | 1710 | 1710 | 1710 | 1466 | 1485 | 1393 | 1567 | 1505 | 1489 | 1489 |
| 2062 | 1710 | 1710 | 1710 | 1466 | 1485 | 1393 | 1567 | 1505 | 1489 | 1489 |
| 2063 | 1710 | 1710 | 1710 | 1466 | 1485 | 1393 | 1567 | 1505 | 1489 | 1489 |
| 2064 | 1710 | 1710 | 1710 | 1466 | 1485 | 1393 | 1567 | 1505 | 1489 | 1489 |
| 2065 | 1710 | 1710 | 1710 | 1466 | 1485 | 1393 | 1567 | 1505 | 1489 | 1489 |
| 2066 | 1710 | 1710 | 1710 | 1466 | 1485 | 1393 | 1567 | 1505 | 1489 | 1489 |
| 2067 | 1710 | 1710 | 1710 | 1466 | 1485 | 1393 | 1567 | 1505 | 1489 | 1489 |
| 2068 | 1710 | 1710 | 1710 | 1466 | 1485 | 1393 | 1567 | 1505 | 1489 | 1489 |

|      | 133  | 134  | 135  | 136  | 137  | 138  | 139  | 140  | 141  | 142  |
|------|------|------|------|------|------|------|------|------|------|------|
| 2069 | 1710 | 1710 | 1710 | 1466 | 1485 | 1393 | 1567 | 1505 | 1489 | 1489 |
| 2070 | 1710 | 1710 | 1710 | 1466 | 1485 | 1393 | 1567 | 1505 | 1489 | 1489 |
| 2071 | 1710 | 1710 | 1710 | 1466 | 1485 | 1393 | 1567 | 1505 | 1489 | 1489 |
| 2072 | 1710 | 1710 | 1710 | 1466 | 1485 | 1393 | 1567 | 1505 | 1489 | 1489 |
| 2073 | 1710 | 1710 | 1710 | 1466 | 1485 | 1393 | 1567 | 1505 | 1489 | 1489 |
| 2074 | 1710 | 1710 | 1710 | 1466 | 1485 | 1393 | 1567 | 1505 | 1489 | 1489 |
| 2075 | 1710 | 1710 | 1710 | 1466 | 1485 | 1393 | 1567 | 1505 | 1489 | 1489 |
| 2076 | 1710 | 1710 | 1710 | 1466 | 1485 | 1393 | 1567 | 1505 | 1489 | 1489 |
| 2077 | 1710 | 1710 | 1710 | 1466 | 1485 | 1393 | 1567 | 1505 | 1489 | 1489 |
| 2078 | 1710 | 1710 | 1710 | 1466 | 1485 | 1393 | 1567 | 1505 | 1489 | 1489 |
| 2079 | 1710 | 1710 | 1710 | 1466 | 1485 | 1393 | 1567 | 1505 | 1489 | 1489 |
| 2080 | 1710 | 1710 | 1710 | 1466 | 1485 | 1393 | 1567 | 1505 | 1489 | 1489 |
| 2081 | 1710 | 1710 | 1710 | 1466 | 1485 | 1393 | 1567 | 1505 | 1489 | 1489 |
| 2082 | 1710 | 1710 | 1710 | 1466 | 1485 | 1393 | 1567 | 1505 | 1489 | 1489 |
| 2083 | 1710 | 1710 | 1710 | 1466 | 1485 | 1393 | 1567 | 1505 | 1489 | 1489 |
| 2084 | 1710 | 1710 | 1710 | 1466 | 1485 | 1393 | 1567 | 1505 | 1489 | 1489 |
| 2085 | 1710 | 1710 | 1710 | 1466 | 1485 | 1393 | 1567 | 1505 | 1489 | 1489 |
| 2086 | 1710 | 1710 | 1710 | 1466 | 1485 | 1393 | 1567 | 1505 | 1489 | 1489 |
| 2087 | 1710 | 1710 | 1710 | 1466 | 1485 | 1393 | 1567 | 1505 | 1489 | 1489 |
| 2088 | 1710 | 1710 | 1710 | 1466 | 1485 | 1393 | 1567 | 1505 | 1489 | 1489 |
| 2089 | 1710 | 1710 | 1710 | 1466 | 1485 | 1393 | 1567 | 1505 | 1489 | 1489 |
| 2090 | 1710 | 1710 | 1710 | 1466 | 1485 | 1393 | 1567 | 1505 | 1489 | 1489 |

|      | 143  | 144  | 145  | 146  | 147  | 148  | 149  | 150  | 151  | 152  | 153  |
|------|------|------|------|------|------|------|------|------|------|------|------|
| 2002 | 0    | 0    | 0    | 0    | 0    | 0    | 0    | 0    | 0    | 0    | 0    |
| 2003 | 0    | 0    | 0    | 0    | 0    | 0    | 0    | 0    | 0    | 0    | 0    |
| 2004 | 0    | 0    | 0    | 0    | 0    | 0    | 0    | 0    | 0    | 0    | 0    |
| 2005 | 0    | 0    | 0    | 0    | 0    | 0    | 0    | 0    | 0    | 0    | 0    |
| 2006 | 0    | 0    | 0    | 0    | 0    | 0    | 0    | 0    | 0    | 0    | 0    |
| 2007 | 0    | 0    | 0    | 0    | 0    | 0    | 0    | 0    | 0    | 0    | 0    |
| 2008 | 0    | 0    | 0    | 0    | 0    | 0    | 0    | 0    | 0    | 0    | 0    |
| 2009 | 0    | 0    | 0    | 0    | 0    | 0    | 0    | 0    | 0    | 0    | 0    |
| 2010 | 0    | 0    | 0    | 0    | 0    | 0    | 0    | 0    | 0    | 0    | 0    |
| 2011 | 0    | 0    | 0    | 0    | 0    | 0    | 0    | 0    | 0    | 0    | 0    |
| 2012 | 0    | 0    | 0    | 0    | 0    | 0    | 0    | 0    | 0    | 0    | 0    |
| 2013 | 0    | 0    | 0    | 0    | 0    | 0    | 0    | 0    | 0    | 0    | 0    |
| 2014 | 0    | 0    | 0    | 0    | 0    | 0    | 0    | 0    | 0    | 0    | 0    |
| 2015 | 0    | 0    | 0    | 0    | 0    | 0    | 0    | 0    | 0    | 0    | 0    |
| 2016 | 0    | 0    | 0    | 0    | 0    | 0    | 0    | 0    | 0    | 0    | 0    |
| 2017 | 0    | 0    | 0    | 0    | 0    | 0    | 0    | 0    | 0    | 0    | 0    |
| 2018 | 0    | 0    | 0    | 0    | 0    | 0    | 0    | 0    | 0    | 0    | 0    |
| 2019 | 0    | 0    | 0    | 0    | 0    | 0    | 0    | 0    | 0    | 0    | 0    |
| 2020 | 0    | 0    | 0    | 0    | 0    | 0    | 0    | 0    | 0    | 0    | 0    |
| 2021 | 0    | 0    | 0    | 0    | 0    | 0    | 0    | 0    | 0    | 0    | 0    |
| 2022 | 0    | 0    | 0    | 0    | 0    | 0    | 0    | 0    | 0    | 0    | 0    |
| 2023 | 0    | 0    | 0    | 0    | 0    | 0    | 0    | 0    | 0    | 0    | 0    |
| 2024 | 0    | 0    | 0    | 0    | 0    | 0    | 0    | 0    | 0    | 0    | 0    |
| 2025 | 0    | 0    | 0    | 0    | 0    | 0    | 0    | 0    | 0    | 0    | 0    |
| 2026 | 0    | 0    | 0    | 0    | 0    | 0    | 0    | 0    | 0    | 0    | 0    |
| 2027 | 0    | 0    | 0    | 0    | 0    | 0    | 0    | 0    | 0    | 0    | 0    |
| 2028 | 0    | 0    | 0    | 0    | 0    | 0    | 0    | 0    | 0    | 0    | 0    |
| 2029 | 0    | 0    | 0    | 0    | 0    | 0    | 0    | 0    | 0    | 0    | 0    |
| 2030 | 0    | 0    | 0    | 0    | 0    | 0    | 0    | 0    | 0    | 0    | 0    |
| 2031 | 0    | 0    | 0    | 0    | 0    | 0    | 0    | 0    | 0    | 0    | 0    |
| 2032 | 0    | 0    | 0    | 0    | 0    | 0    | 0    | 0    | 0    | 0    | 0    |
| 2033 | 0    | 0    | 0    | 0    | 0    | 0    | 0    | 0    | 0    | 0    | 0    |
| 2034 | 0    | 0    | 0    | 0    | 0    | 0    | 0    | 0    | 0    | 0    | 0    |
| 2035 | 0    | 0    | 0    | 0    | 0    | 0    | 0    | 0    | 0    | 0    | 0    |
| 2036 | 0    | 0    | 0    | 0    | 0    | 0    | 0    | 0    | 0    | 0    | 0    |
| 2037 | 0    | 0    | 0    | 0    | 0    | 0    | 0    | 0    | 0    | 0    | 0    |
| 2038 | 0    | 0    | 0    | 0    | 0    | 0    | 0    | 0    | 0    | 0    | 0    |
| 2039 | 0    | 0    | 0    | 0    | 0    | 0    | 0    | 0    | 0    | 0    | 0    |
| 2040 | 0    | 0    | 0    | 0    | 0    | 0    | 0    | 0    | 0    | 0    | 0    |
| 2041 | 0    | 0    | 0    | 0    | 0    | 0    | 0    | 0    | 0    | 0    | 0    |
| 2042 | 0    | 0    | 0    | 0    | 0    | 0    | 0    | 0    | 0    | 0    | 0    |
| 2043 | 0    | 0    | 0    | 0    | 0    | 0    | 0    | 0    | 0    | 0    | 0    |
| 2044 | 0    | 0    | 0    | 0    | 0    | 0    | 0    | 0    | 0    | 0    | 0    |
| 2045 | 678  | 678  | 0    | 0    | 0    | 37   | 0    | 0    | 0    | 0    | 0    |
| 2046 | 1080 | 1080 | 0    | 0    | 0    | 385  | 0    | 0    | 0    | 0    | 0    |
| 2047 | 1274 | 1274 | 1    | 0    | 0    | 725  | 0    | 55   | 0    | 0    | 0    |
| 2048 | 1394 | 1394 | 398  | 397  | 0    | 1012 | 397  | 419  | 397  | 397  | 397  |
| 2049 | 1433 | 1433 | 740  | 739  | 1    | 1236 | 739  | 742  | 739  | 739  | 739  |
| 2050 | 1444 | 1444 | 986  | 985  | 405  | 1395 | 985  | 991  | 985  | 985  | 985  |
| 2051 | 1459 | 1459 | 1176 | 1175 | 683  | 1502 | 1175 | 1170 | 1175 | 1175 | 1175 |
| 2052 | 1464 | 1464 | 1360 | 1359 | 870  | 1593 | 1359 | 1314 | 1359 | 1359 | 1359 |
| 2053 | 1464 | 1464 | 1474 | 1473 | 1037 | 1664 | 1473 | 1415 | 1473 | 1473 | 1473 |
| 2054 | 1477 | 1477 | 1522 | 1521 | 1139 | 1713 | 1521 | 1466 | 1521 | 1521 | 1521 |
| 2055 | 1479 | 1479 | 1559 | 1558 | 1183 | 1742 | 1558 | 1503 | 1558 | 1558 | 1558 |
| 2056 | 1489 | 1489 | 1595 | 1594 | 1219 | 1766 | 1594 | 1540 | 1594 | 1594 | 1594 |
| 2057 | 1489 | 1489 | 1634 | 1633 | 1255 | 1782 | 1633 | 1566 | 1633 | 1633 | 1633 |
| 2058 | 1489 | 1489 | 1668 | 1667 | 1276 | 1795 | 1667 | 1586 | 1667 | 1667 | 1667 |
| 2059 | 1489 | 1489 | 1680 | 1679 | 1291 | 1797 | 1679 | 1600 | 1679 | 1679 | 1679 |
| 2060 | 1489 | 1489 | 1683 | 1682 | 1293 | 1798 | 1682 | 1602 | 1682 | 1682 | 1682 |
| 2061 | 1489 | 1489 | 1684 | 1683 | 1293 | 1798 | 1683 | 1602 | 1683 | 1683 | 1683 |
| 2062 | 1489 | 1489 | 1684 | 1683 | 1293 | 1798 | 1683 | 1602 | 1683 | 1683 | 1683 |
| 2063 | 1489 | 1489 | 1684 | 1683 | 1293 | 1798 | 1683 | 1602 | 1683 | 1683 | 1683 |
| 2064 | 1489 | 1489 | 1684 | 1683 | 1293 | 1798 | 1683 | 1602 | 1683 | 1683 | 1683 |
| 2065 | 1489 | 1489 | 1684 | 1683 | 1293 | 1798 | 1683 | 1602 | 1683 | 1683 | 1683 |
| 2066 | 1489 | 1489 | 1684 | 1683 | 1293 | 1798 | 1683 | 1602 | 1683 | 1683 | 1683 |
| 2067 | 1489 | 1489 | 1684 | 1683 | 1293 | 1798 | 1683 | 1602 | 1683 | 1683 | 1683 |
| 2068 | 1489 | 1489 | 1684 | 1683 | 1293 | 1798 | 1683 | 1602 | 1683 | 1683 | 1683 |

|      | 143  | 144  | 145  | 146  | 147  | 148  | 149  | 150  | 151  | 152  | 153  |
|------|------|------|------|------|------|------|------|------|------|------|------|
| 2069 | 1489 | 1489 | 1684 | 1683 | 1293 | 1798 | 1683 | 1602 | 1683 | 1683 | 1683 |
| 2070 | 1489 | 1489 | 1684 | 1683 | 1293 | 1798 | 1683 | 1602 | 1683 | 1683 | 1683 |
| 2071 | 1489 | 1489 | 1684 | 1683 | 1293 | 1798 | 1683 | 1602 | 1683 | 1683 | 1683 |
| 2072 | 1489 | 1489 | 1684 | 1683 | 1293 | 1798 | 1683 | 1602 | 1683 | 1683 | 1683 |
| 2073 | 1489 | 1489 | 1684 | 1683 | 1293 | 1798 | 1683 | 1602 | 1683 | 1683 | 1683 |
| 2074 | 1489 | 1489 | 1684 | 1683 | 1293 | 1798 | 1683 | 1602 | 1683 | 1683 | 1683 |
| 2075 | 1489 | 1489 | 1684 | 1683 | 1293 | 1798 | 1683 | 1602 | 1683 | 1683 | 1683 |
| 2076 | 1489 | 1489 | 1684 | 1683 | 1293 | 1798 | 1683 | 1602 | 1683 | 1683 | 1683 |
| 2077 | 1489 | 1489 | 1684 | 1683 | 1293 | 1798 | 1683 | 1602 | 1683 | 1683 | 1683 |
| 2078 | 1489 | 1489 | 1684 | 1683 | 1293 | 1798 | 1683 | 1602 | 1683 | 1683 | 1683 |
| 2079 | 1489 | 1489 | 1684 | 1683 | 1293 | 1798 | 1683 | 1602 | 1683 | 1683 | 1683 |
| 2080 | 1489 | 1489 | 1684 | 1683 | 1293 | 1798 | 1683 | 1602 | 1683 | 1683 | 1683 |
| 2081 | 1489 | 1489 | 1684 | 1683 | 1293 | 1798 | 1683 | 1602 | 1683 | 1683 | 1683 |
| 2082 | 1489 | 1489 | 1684 | 1683 | 1293 | 1798 | 1683 | 1602 | 1683 | 1683 | 1683 |
| 2083 | 1489 | 1489 | 1684 | 1683 | 1293 | 1798 | 1683 | 1602 | 1683 | 1683 | 1683 |
| 2084 | 1489 | 1489 | 1684 | 1683 | 1293 | 1798 | 1683 | 1602 | 1683 | 1683 | 1683 |
| 2085 | 1489 | 1489 | 1684 | 1683 | 1293 | 1798 | 1683 | 1602 | 1683 | 1683 | 1683 |
| 2086 | 1489 | 1489 | 1684 | 1683 | 1293 | 1798 | 1683 | 1602 | 1683 | 1683 | 1683 |
| 2087 | 1489 | 1489 | 1684 | 1683 | 1293 | 1798 | 1683 | 1602 | 1683 | 1683 | 1683 |
| 2088 | 1489 | 1489 | 1684 | 1683 | 1293 | 1798 | 1683 | 1602 | 1683 | 1683 | 1683 |
| 2089 | 1489 | 1489 | 1684 | 1683 | 1293 | 1798 | 1683 | 1602 | 1683 | 1683 | 1683 |
| 2090 | 1489 | 1489 | 1684 | 1683 | 1293 | 1798 | 1683 | 1602 | 1683 | 1683 | 1683 |



|      | 154  | 155  | 156  | 157  | 158  | 159  | 160  | 161  | 162  |
|------|------|------|------|------|------|------|------|------|------|
| 2002 | 0    | 0    | 0    | 0    | 0    | 0    | 0    | 0    | 0    |
| 2003 | 0    | 0    | 0    | 0    | 0    | 0    | 0    | 0    | 0    |
| 2004 | 0    | 0    | 0    | 0    | 0    | 0    | 0    | 0    | 0    |
| 2005 | 0    | 0    | 0    | 0    | 0    | 0    | 0    | 0    | 0    |
| 2006 | 0    | 0    | 0    | 0    | 0    | 0    | 0    | 0    | 0    |
| 2007 | 0    | 0    | 0    | 0    | 0    | 0    | 0    | 0    | 0    |
| 2008 | 0    | 0    | 0    | 0    | 0    | 0    | 0    | 0    | 0    |
| 2009 | 0    | 0    | 0    | 0    | 0    | 0    | 0    | 0    | 0    |
| 2010 | 0    | 0    | 0    | 0    | 0    | 0    | 0    | 0    | 0    |
| 2011 | 0    | 0    | 0    | 0    | 0    | 0    | 0    | 0    | 0    |
| 2012 | 0    | 0    | 0    | 0    | 0    | 0    | 0    | 0    | 0    |
| 2013 | 0    | 0    | 0    | 0    | 0    | 0    | 0    | 0    | 0    |
| 2014 | 0    | 0    | 0    | 0    | 0    | 0    | 0    | 0    | 0    |
| 2015 | 0    | 0    | 0    | 0    | 0    | 0    | 0    | 0    | 0    |
| 2016 | 0    | 0    | 0    | 0    | 0    | 0    | 0    | 0    | 0    |
| 2017 | 0    | 0    | 0    | 0    | 0    | 0    | 0    | 0    | 0    |
| 2018 | 0    | 0    | 0    | 0    | 0    | 0    | 0    | 0    | 0    |
| 2019 | 0    | 0    | 0    | 0    | 0    | 0    | 0    | 0    | 0    |
| 2020 | 0    | 0    | 0    | 0    | 0    | 0    | 0    | 0    | 0    |
| 2021 | 0    | 0    | 0    | 0    | 0    | 0    | 0    | 0    | 0    |
| 2022 | 0    | 0    | 0    | 0    | 0    | 0    | 0    | 0    | 0    |
| 2023 | 0    | 0    | 0    | 0    | 0    | 0    | 0    | 0    | 0    |
| 2024 | 0    | 0    | 0    | 0    | 0    | 0    | 0    | 0    | 0    |
| 2025 | 0    | 0    | 0    | 0    | 0    | 0    | 0    | 0    | 0    |
| 2026 | 0    | 0    | 0    | 0    | 0    | 0    | 0    | 0    | 0    |
| 2027 | 0    | 0    | 0    | 0    | 0    | 0    | 0    | 0    | 0    |
| 2028 | 0    | 0    | 0    | 0    | 0    | 0    | 0    | 0    | 0    |
| 2029 | 0    | 0    | 0    | 0    | 0    | 0    | 0    | 0    | 0    |
| 2030 | 0    | 0    | 0    | 0    | 0    | 0    | 0    | 0    | 0    |
| 2031 | 0    | 0    | 0    | 0    | 0    | 0    | 0    | 0    | 0    |
| 2032 | 0    | 0    | 0    | 0    | 0    | 0    | 0    | 0    | 0    |
| 2033 | 0    | 0    | 0    | 0    | 0    | 0    | 0    | 0    | 0    |
| 2034 | 0    | 0    | 0    | 0    | 0    | 0    | 0    | 0    | 0    |
| 2035 | 0    | 0    | 0    | 0    | 0    | 0    | 0    | 0    | 0    |
| 2036 | 0    | 0    | 0    | 0    | 0    | 0    | 0    | 0    | 0    |
| 2037 | 0    | 0    | 0    | 0    | 0    | 0    | 0    | 0    | 0    |
| 2038 | 0    | 0    | 0    | 0    | 0    | 0    | 0    | 0    | 0    |
| 2039 | 0    | 0    | 0    | 0    | 0    | 0    | 0    | 0    | 0    |
| 2040 | 0    | 0    | 0    | 0    | 0    | 0    | 0    | 0    | 0    |
| 2041 | 0    | 0    | 0    | 0    | 0    | 0    | 0    | 0    | 0    |
| 2042 | 0    | 0    | 0    | 0    | 0    | 0    | 0    | 0    | 0    |
| 2043 | 0    | 0    | 0    | 49   | 0    | 0    | 0    | 0    | 0    |
| 2044 | 0    | 0    | 0    | 395  | 0    | 0    | 0    | 0    | 0    |
| 2045 | 4    | 0    | 0    | 730  | 0    | 0    | 5    | 5    | 5    |
| 2046 | 376  | 1    | 0    | 1022 | 2    | 36   | 377  | 377  | 377  |
| 2047 | 708  | 373  | 0    | 1256 | 374  | 413  | 709  | 709  | 709  |
| 2048 | 963  | 714  | 4    | 1421 | 715  | 760  | 964  | 964  | 964  |
| 2049 | 1153 | 960  | 404  | 1530 | 960  | 1005 | 1154 | 1154 | 1154 |
| 2050 | 1337 | 1150 | 682  | 1621 | 1150 | 1167 | 1332 | 1332 | 1332 |
| 2051 | 1451 | 1333 | 869  | 1690 | 1334 | 1301 | 1446 | 1446 | 1446 |
| 2052 | 1499 | 1447 | 1036 | 1738 | 1448 | 1405 | 1494 | 1494 | 1494 |
| 2053 | 1536 | 1496 | 1138 | 1767 | 1496 | 1453 | 1531 | 1531 | 1531 |
| 2054 | 1572 | 1533 | 1182 | 1791 | 1533 | 1490 | 1567 | 1567 | 1567 |
| 2055 | 1611 | 1569 | 1218 | 1809 | 1569 | 1528 | 1606 | 1606 | 1606 |
| 2056 | 1645 | 1607 | 1254 | 1822 | 1608 | 1554 | 1640 | 1640 | 1640 |
| 2057 | 1657 | 1640 | 1275 | 1824 | 1642 | 1575 | 1652 | 1652 | 1652 |
| 2058 | 1660 | 1653 | 1290 | 1825 | 1654 | 1575 | 1655 | 1655 | 1655 |
| 2059 | 1661 | 1656 | 1292 | 1825 | 1657 | 1575 | 1656 | 1656 | 1656 |
| 2060 | 1661 | 1657 | 1292 | 1825 | 1658 | 1575 | 1656 | 1656 | 1656 |
| 2061 | 1661 | 1657 | 1292 | 1825 | 1658 | 1575 | 1656 | 1656 | 1656 |
| 2062 | 1661 | 1657 | 1292 | 1825 | 1658 | 1575 | 1656 | 1656 | 1656 |
| 2063 | 1661 | 1657 | 1292 | 1825 | 1658 | 1575 | 1656 | 1656 | 1656 |
| 2064 | 1661 | 1657 | 1292 | 1825 | 1658 | 1575 | 1656 | 1656 | 1656 |
| 2065 | 1661 | 1657 | 1292 | 1825 | 1658 | 1575 | 1656 | 1656 | 1656 |
| 2066 | 1661 | 1657 | 1292 | 1825 | 1658 | 1575 | 1656 | 1656 | 1656 |
| 2067 | 1661 | 1657 | 1292 | 1825 | 1658 | 1575 | 1656 | 1656 | 1656 |
| 2068 | 1661 | 1657 | 1292 | 1825 | 1658 | 1575 | 1656 | 1656 | 1656 |

|      | 154  | 155  | 156  | 157  | 158  | 159  | 160  | 161  | 162  |
|------|------|------|------|------|------|------|------|------|------|
| 2069 | 1661 | 1657 | 1292 | 1825 | 1658 | 1575 | 1656 | 1656 | 1656 |
| 2070 | 1661 | 1657 | 1292 | 1825 | 1658 | 1575 | 1656 | 1656 | 1656 |
| 2071 | 1661 | 1657 | 1292 | 1825 | 1658 | 1575 | 1656 | 1656 | 1656 |
| 2072 | 1661 | 1657 | 1292 | 1825 | 1658 | 1575 | 1656 | 1656 | 1656 |
| 2073 | 1661 | 1657 | 1292 | 1825 | 1658 | 1575 | 1656 | 1656 | 1656 |
| 2074 | 1661 | 1657 | 1292 | 1825 | 1658 | 1575 | 1656 | 1656 | 1656 |
| 2075 | 1661 | 1657 | 1292 | 1825 | 1658 | 1575 | 1656 | 1656 | 1656 |
| 2076 | 1661 | 1657 | 1292 | 1825 | 1658 | 1575 | 1656 | 1656 | 1656 |
| 2077 | 1661 | 1657 | 1292 | 1825 | 1658 | 1575 | 1656 | 1656 | 1656 |
| 2078 | 1661 | 1657 | 1292 | 1825 | 1658 | 1575 | 1656 | 1656 | 1656 |
| 2079 | 1661 | 1657 | 1292 | 1825 | 1658 | 1575 | 1656 | 1656 | 1656 |
| 2080 | 1661 | 1657 | 1292 | 1825 | 1658 | 1575 | 1656 | 1656 | 1656 |
| 2081 | 1661 | 1657 | 1292 | 1825 | 1658 | 1575 | 1656 | 1656 | 1656 |
| 2082 | 1661 | 1657 | 1292 | 1825 | 1658 | 1575 | 1656 | 1656 | 1656 |
| 2083 | 1661 | 1657 | 1292 | 1825 | 1658 | 1575 | 1656 | 1656 | 1656 |
| 2084 | 1661 | 1657 | 1292 | 1825 | 1658 | 1575 | 1656 | 1656 | 1656 |
| 2085 | 1661 | 1657 | 1292 | 1825 | 1658 | 1575 | 1656 | 1656 | 1656 |
| 2086 | 1661 | 1657 | 1292 | 1825 | 1658 | 1575 | 1656 | 1656 | 1656 |
| 2087 | 1661 | 1657 | 1292 | 1825 | 1658 | 1575 | 1656 | 1656 | 1656 |
| 2088 | 1661 | 1657 | 1292 | 1825 | 1658 | 1575 | 1656 | 1656 | 1656 |
| 2089 | 1661 | 1657 | 1292 | 1825 | 1658 | 1575 | 1656 | 1656 | 1656 |
| 2090 | 1661 | 1657 | 1292 | 1825 | 1658 | 1575 | 1656 | 1656 | 1656 |



|      | 1      | 2      | 3      | 4      | 5      | 6      | 7      | 8      | 9      | 10     | 11     | 12     |
|------|--------|--------|--------|--------|--------|--------|--------|--------|--------|--------|--------|--------|
| 2068 | 135380 | 135851 | 137917 | 131874 | 135986 | 134596 | 135611 | 135611 | 135611 | 172940 | 172991 | 181468 |
| 2069 | 135380 | 135851 | 137917 | 131874 | 135986 | 134596 | 135611 | 135611 | 135611 | 172940 | 172991 | 181468 |
| 2070 | 135380 | 135851 | 137917 | 131874 | 135986 | 134596 | 135611 | 135611 | 135611 | 172940 | 172991 | 181468 |
| 2071 | 135380 | 135851 | 137917 | 131874 | 135986 | 134596 | 135611 | 135611 | 135611 | 172940 | 172991 | 181468 |
| 2072 | 135380 | 135851 | 137917 | 131874 | 135986 | 134596 | 135611 | 135611 | 135611 | 172940 | 172991 | 181468 |
| 2073 | 135380 | 135851 | 137917 | 131874 | 135986 | 134596 | 135611 | 135611 | 135611 | 172940 | 172991 | 181468 |
| 2074 | 135380 | 135851 | 137917 | 131874 | 135986 | 134596 | 135611 | 135611 | 135611 | 172940 | 172991 | 181468 |
| 2075 | 135380 | 135851 | 137917 | 131874 | 135986 | 134596 | 135611 | 135611 | 135611 | 172940 | 172991 | 181468 |
| 2076 | 135380 | 135851 | 137917 | 131874 | 135986 | 134596 | 135611 | 135611 | 135611 | 172940 | 172991 | 181468 |
| 2077 | 135380 | 135851 | 137917 | 131874 | 135986 | 134596 | 135611 | 135611 | 135611 | 172940 | 172991 | 181468 |
| 2078 | 135380 | 135851 | 137917 | 131874 | 135986 | 134596 | 135611 | 135611 | 135611 | 172940 | 172991 | 181468 |
| 2079 | 135380 | 135851 | 137917 | 131874 | 135986 | 134596 | 135611 | 135611 | 135611 | 172940 | 172991 | 181468 |
| 2080 | 135380 | 135851 | 137917 | 131874 | 135986 | 134596 | 135611 | 135611 | 135611 | 172940 | 172991 | 181468 |
| 2081 | 135380 | 135851 | 137917 | 131874 | 135986 | 134596 | 135611 | 135611 | 135611 | 172940 | 172991 | 181468 |
| 2082 | 135380 | 135851 | 137917 | 131874 | 135986 | 134596 | 135611 | 135611 | 135611 | 172940 | 172991 | 181468 |
| 2083 | 135380 | 135851 | 137917 | 131874 | 135986 | 134596 | 135611 | 135611 | 135611 | 172940 | 172991 | 181468 |
| 2084 | 135380 | 135851 | 137917 | 131874 | 135986 | 134596 | 135611 | 135611 | 135611 | 172940 | 172991 | 181468 |
| 2085 | 135380 | 135851 | 137917 | 131874 | 135986 | 134596 | 135611 | 135611 | 135611 | 172940 | 172991 | 181468 |
| 2086 | 135380 | 135851 | 137917 | 131874 | 135986 | 134596 | 135611 | 135611 | 135611 | 172940 | 172991 | 181468 |
| 2087 | 135380 | 135851 | 137917 | 131874 | 135986 | 134596 | 135611 | 135611 | 135611 | 172940 | 172991 | 181468 |
| 2088 | 135380 | 135851 | 137917 | 131874 | 135986 | 134596 | 135611 | 135611 | 135611 | 172940 | 172991 | 181468 |
| 2089 | 135380 | 135851 | 137917 | 131874 | 135986 | 134596 | 135611 | 135611 | 135611 | 172940 | 172991 | 181468 |
| 2090 | 135380 | 135851 | 137917 | 131874 | 135986 | 134596 | 135611 | 135611 | 135611 | 172940 | 172991 | 181468 |



|      | 13     | 14     | 15     | 16     | 17     | 18     | 19     | 20     | 21     | 22     | 23     | 24     |
|------|--------|--------|--------|--------|--------|--------|--------|--------|--------|--------|--------|--------|
| 2068 | 165925 | 172849 | 173317 | 172995 | 172995 | 172995 | 172821 | 172855 | 181346 | 168947 | 173331 | 173531 |
| 2069 | 165925 | 172849 | 173317 | 172995 | 172995 | 172995 | 172821 | 172855 | 181346 | 168947 | 173331 | 173531 |
| 2070 | 165925 | 172849 | 173317 | 172995 | 172995 | 172995 | 172821 | 172855 | 181346 | 168947 | 173331 | 173531 |
| 2071 | 165925 | 172849 | 173317 | 172995 | 172995 | 172995 | 172821 | 172855 | 181346 | 168947 | 173331 | 173531 |
| 2072 | 165925 | 172849 | 173317 | 172995 | 172995 | 172995 | 172821 | 172855 | 181346 | 168947 | 173331 | 173531 |
| 2073 | 165925 | 172849 | 173317 | 172995 | 172995 | 172995 | 172821 | 172855 | 181346 | 168947 | 173331 | 173531 |
| 2074 | 165925 | 172849 | 173317 | 172995 | 172995 | 172995 | 172821 | 172855 | 181346 | 168947 | 173331 | 173531 |
| 2075 | 165925 | 172849 | 173317 | 172995 | 172995 | 172995 | 172821 | 172855 | 181346 | 168947 | 173331 | 173531 |
| 2076 | 165925 | 172849 | 173317 | 172995 | 172995 | 172995 | 172821 | 172855 | 181346 | 168947 | 173331 | 173531 |
| 2077 | 165925 | 172849 | 173317 | 172995 | 172995 | 172995 | 172821 | 172855 | 181346 | 168947 | 173331 | 173531 |
| 2078 | 165925 | 172849 | 173317 | 172995 | 172995 | 172995 | 172821 | 172855 | 181346 | 168947 | 173331 | 173531 |
| 2079 | 165925 | 172849 | 173317 | 172995 | 172995 | 172995 | 172821 | 172855 | 181346 | 168947 | 173331 | 173531 |
| 2080 | 165925 | 172849 | 173317 | 172995 | 172995 | 172995 | 172821 | 172855 | 181346 | 168947 | 173331 | 173531 |
| 2081 | 165925 | 172849 | 173317 | 172995 | 172995 | 172995 | 172821 | 172855 | 181346 | 168947 | 173331 | 173531 |
| 2082 | 165925 | 172849 | 173317 | 172995 | 172995 | 172995 | 172821 | 172855 | 181346 | 168947 | 173331 | 173531 |
| 2083 | 165925 | 172849 | 173317 | 172995 | 172995 | 172995 | 172821 | 172855 | 181346 | 168947 | 173331 | 173531 |
| 2084 | 165925 | 172849 | 173317 | 172995 | 172995 | 172995 | 172821 | 172855 | 181346 | 168947 | 173331 | 173531 |
| 2085 | 165925 | 172849 | 173317 | 172995 | 172995 | 172995 | 172821 | 172855 | 181346 | 168947 | 173331 | 173531 |
| 2086 | 165925 | 172849 | 173317 | 172995 | 172995 | 172995 | 172821 | 172855 | 181346 | 168947 | 173331 | 173531 |
| 2087 | 165925 | 172849 | 173317 | 172995 | 172995 | 172995 | 172821 | 172855 | 181346 | 168947 | 173331 | 173531 |
| 2088 | 165925 | 172849 | 173317 | 172995 | 172995 | 172995 | 172821 | 172855 | 181346 | 168947 | 173331 | 173531 |
| 2089 | 165925 | 172849 | 173317 | 172995 | 172995 | 172995 | 172821 | 172855 | 181346 | 168947 | 173331 | 173531 |
| 2090 | 165925 | 172849 | 173317 | 172995 | 172995 | 172995 | 172821 | 172855 | 181346 | 168947 | 173331 | 173531 |



|      | 25     | 26     | 27     | 28     | 29     | 30     | 31     | 32     | 33     | 34     | 35     | 36     |
|------|--------|--------|--------|--------|--------|--------|--------|--------|--------|--------|--------|--------|
| 2068 | 172909 | 172909 | 172909 | 135220 | 135539 | 138232 | 132147 | 136647 | 134990 | 136159 | 136159 | 136159 |
| 2069 | 172909 | 172909 | 172909 | 135220 | 135539 | 138232 | 132147 | 136647 | 134990 | 136159 | 136159 | 136159 |
| 2070 | 172909 | 172909 | 172909 | 135220 | 135539 | 138232 | 132147 | 136647 | 134990 | 136159 | 136159 | 136159 |
| 2071 | 172909 | 172909 | 172909 | 135220 | 135539 | 138232 | 132147 | 136647 | 134990 | 136159 | 136159 | 136159 |
| 2072 | 172909 | 172909 | 172909 | 135220 | 135539 | 138232 | 132147 | 136647 | 134990 | 136159 | 136159 | 136159 |
| 2073 | 172909 | 172909 | 172909 | 135220 | 135539 | 138232 | 132147 | 136647 | 134990 | 136159 | 136159 | 136159 |
| 2074 | 172909 | 172909 | 172909 | 135220 | 135539 | 138232 | 132147 | 136647 | 134990 | 136159 | 136159 | 136159 |
| 2075 | 172909 | 172909 | 172909 | 135220 | 135539 | 138232 | 132147 | 136647 | 134990 | 136159 | 136159 | 136159 |
| 2076 | 172909 | 172909 | 172909 | 135220 | 135539 | 138232 | 132147 | 136647 | 134990 | 136159 | 136159 | 136159 |
| 2077 | 172909 | 172909 | 172909 | 135220 | 135539 | 138232 | 132147 | 136647 | 134990 | 136159 | 136159 | 136159 |
| 2078 | 172909 | 172909 | 172909 | 135220 | 135539 | 138232 | 132147 | 136647 | 134990 | 136159 | 136159 | 136159 |
| 2079 | 172909 | 172909 | 172909 | 135220 | 135539 | 138232 | 132147 | 136647 | 134990 | 136159 | 136159 | 136159 |
| 2080 | 172909 | 172909 | 172909 | 135220 | 135539 | 138232 | 132147 | 136647 | 134990 | 136159 | 136159 | 136159 |
| 2081 | 172909 | 172909 | 172909 | 135220 | 135539 | 138232 | 132147 | 136647 | 134990 | 136159 | 136159 | 136159 |
| 2082 | 172909 | 172909 | 172909 | 135220 | 135539 | 138232 | 132147 | 136647 | 134990 | 136159 | 136159 | 136159 |
| 2083 | 172909 | 172909 | 172909 | 135220 | 135539 | 138232 | 132147 | 136647 | 134990 | 136159 | 136159 | 136159 |
| 2084 | 172909 | 172909 | 172909 | 135220 | 135539 | 138232 | 132147 | 136647 | 134990 | 136159 | 136159 | 136159 |
| 2085 | 172909 | 172909 | 172909 | 135220 | 135539 | 138232 | 132147 | 136647 | 134990 | 136159 | 136159 | 136159 |
| 2086 | 172909 | 172909 | 172909 | 135220 | 135539 | 138232 | 132147 | 136647 | 134990 | 136159 | 136159 | 136159 |
| 2087 | 172909 | 172909 | 172909 | 135220 | 135539 | 138232 | 132147 | 136647 | 134990 | 136159 | 136159 | 136159 |
| 2088 | 172909 | 172909 | 172909 | 135220 | 135539 | 138232 | 132147 | 136647 | 134990 | 136159 | 136159 | 136159 |
| 2089 | 172909 | 172909 | 172909 | 135220 | 135539 | 138232 | 132147 | 136647 | 134990 | 136159 | 136159 | 136159 |
| 2090 | 172909 | 172909 | 172909 | 135220 | 135539 | 138232 | 132147 | 136647 | 134990 | 136159 | 136159 | 136159 |





|      | 37     | 38     | 39     | 40     | 41     | 42     | 43     | 44     | 45     | 46     | 47     | 48     |
|------|--------|--------|--------|--------|--------|--------|--------|--------|--------|--------|--------|--------|
| 2068 | 173015 | 172975 | 181531 | 167549 | 173037 | 174059 | 172839 | 172839 | 172839 | 172842 | 172926 | 181564 |
| 2069 | 173015 | 172975 | 181531 | 167549 | 173037 | 174059 | 172839 | 172839 | 172839 | 172842 | 172926 | 181564 |
| 2070 | 173015 | 172975 | 181531 | 167549 | 173037 | 174059 | 172839 | 172839 | 172839 | 172842 | 172926 | 181564 |
| 2071 | 173015 | 172975 | 181531 | 167549 | 173037 | 174059 | 172839 | 172839 | 172839 | 172842 | 172926 | 181564 |
| 2072 | 173015 | 172975 | 181531 | 167549 | 173037 | 174059 | 172839 | 172839 | 172839 | 172842 | 172926 | 181564 |
| 2073 | 173015 | 172975 | 181531 | 167549 | 173037 | 174059 | 172839 | 172839 | 172839 | 172842 | 172926 | 181564 |
| 2074 | 173015 | 172975 | 181531 | 167549 | 173037 | 174059 | 172839 | 172839 | 172839 | 172842 | 172926 | 181564 |
| 2075 | 173015 | 172975 | 181531 | 167549 | 173037 | 174059 | 172839 | 172839 | 172839 | 172842 | 172926 | 181564 |
| 2076 | 173015 | 172975 | 181531 | 167549 | 173037 | 174059 | 172839 | 172839 | 172839 | 172842 | 172926 | 181564 |
| 2077 | 173015 | 172975 | 181531 | 167549 | 173037 | 174059 | 172839 | 172839 | 172839 | 172842 | 172926 | 181564 |
| 2078 | 173015 | 172975 | 181531 | 167549 | 173037 | 174059 | 172839 | 172839 | 172839 | 172842 | 172926 | 181564 |
| 2079 | 173015 | 172975 | 181531 | 167549 | 173037 | 174059 | 172839 | 172839 | 172839 | 172842 | 172926 | 181564 |
| 2080 | 173015 | 172975 | 181531 | 167549 | 173037 | 174059 | 172839 | 172839 | 172839 | 172842 | 172926 | 181564 |
| 2081 | 173015 | 172975 | 181531 | 167549 | 173037 | 174059 | 172839 | 172839 | 172839 | 172842 | 172926 | 181564 |
| 2082 | 173015 | 172975 | 181531 | 167549 | 173037 | 174059 | 172839 | 172839 | 172839 | 172842 | 172926 | 181564 |
| 2083 | 173015 | 172975 | 181531 | 167549 | 173037 | 174059 | 172839 | 172839 | 172839 | 172842 | 172926 | 181564 |
| 2084 | 173015 | 172975 | 181531 | 167549 | 173037 | 174059 | 172839 | 172839 | 172839 | 172842 | 172926 | 181564 |
| 2085 | 173015 | 172975 | 181531 | 167549 | 173037 | 174059 | 172839 | 172839 | 172839 | 172842 | 172926 | 181564 |
| 2086 | 173015 | 172975 | 181531 | 167549 | 173037 | 174059 | 172839 | 172839 | 172839 | 172842 | 172926 | 181564 |
| 2087 | 173015 | 172975 | 181531 | 167549 | 173037 | 174059 | 172839 | 172839 | 172839 | 172842 | 172926 | 181564 |
| 2088 | 173015 | 172975 | 181531 | 167549 | 173037 | 174059 | 172839 | 172839 | 172839 | 172842 | 172926 | 181564 |
| 2089 | 173015 | 172975 | 181531 | 167549 | 173037 | 174059 | 172839 | 172839 | 172839 | 172842 | 172926 | 181564 |
| 2090 | 173015 | 172975 | 181531 | 167549 | 173037 | 174059 | 172839 | 172839 | 172839 | 172842 | 172926 | 181564 |



|      | 49     | 50     | 51     | 52     | 53     | 54     | 55     | 56     | 57     | 58     | 59     | 60     |
|------|--------|--------|--------|--------|--------|--------|--------|--------|--------|--------|--------|--------|
| 2068 | 169540 | 173452 | 173925 | 173104 | 173104 | 173104 | 139791 | 139594 | 141469 | 134296 | 136146 | 137481 |
| 2069 | 169540 | 173452 | 173925 | 173104 | 173104 | 173104 | 139791 | 139594 | 141469 | 134296 | 136146 | 137481 |
| 2070 | 169540 | 173452 | 173925 | 173104 | 173104 | 173104 | 139791 | 139594 | 141469 | 134296 | 136146 | 137481 |
| 2071 | 169540 | 173452 | 173925 | 173104 | 173104 | 173104 | 139791 | 139594 | 141469 | 134296 | 136146 | 137481 |
| 2072 | 169540 | 173452 | 173925 | 173104 | 173104 | 173104 | 139791 | 139594 | 141469 | 134296 | 136146 | 137481 |
| 2073 | 169540 | 173452 | 173925 | 173104 | 173104 | 173104 | 139791 | 139594 | 141469 | 134296 | 136146 | 137481 |
| 2074 | 169540 | 173452 | 173925 | 173104 | 173104 | 173104 | 139791 | 139594 | 141469 | 134296 | 136146 | 137481 |
| 2075 | 169540 | 173452 | 173925 | 173104 | 173104 | 173104 | 139791 | 139594 | 141469 | 134296 | 136146 | 137481 |
| 2076 | 169540 | 173452 | 173925 | 173104 | 173104 | 173104 | 139791 | 139594 | 141469 | 134296 | 136146 | 137481 |
| 2077 | 169540 | 173452 | 173925 | 173104 | 173104 | 173104 | 139791 | 139594 | 141469 | 134296 | 136146 | 137481 |
| 2078 | 169540 | 173452 | 173925 | 173104 | 173104 | 173104 | 139791 | 139594 | 141469 | 134296 | 136146 | 137481 |
| 2079 | 169540 | 173452 | 173925 | 173104 | 173104 | 173104 | 139791 | 139594 | 141469 | 134296 | 136146 | 137481 |
| 2080 | 169540 | 173452 | 173925 | 173104 | 173104 | 173104 | 139791 | 139594 | 141469 | 134296 | 136146 | 137481 |
| 2081 | 169540 | 173452 | 173925 | 173104 | 173104 | 173104 | 139791 | 139594 | 141469 | 134296 | 136146 | 137481 |
| 2082 | 169540 | 173452 | 173925 | 173104 | 173104 | 173104 | 139791 | 139594 | 141469 | 134296 | 136146 | 137481 |
| 2083 | 169540 | 173452 | 173925 | 173104 | 173104 | 173104 | 139791 | 139594 | 141469 | 134296 | 136146 | 137481 |
| 2084 | 169540 | 173452 | 173925 | 173104 | 173104 | 173104 | 139791 | 139594 | 141469 | 134296 | 136146 | 137481 |
| 2085 | 169540 | 173452 | 173925 | 173104 | 173104 | 173104 | 139791 | 139594 | 141469 | 134296 | 136146 | 137481 |
| 2086 | 169540 | 173452 | 173925 | 173104 | 173104 | 173104 | 139791 | 139594 | 141469 | 134296 | 136146 | 137481 |
| 2087 | 169540 | 173452 | 173925 | 173104 | 173104 | 173104 | 139791 | 139594 | 141469 | 134296 | 136146 | 137481 |
| 2088 | 169540 | 173452 | 173925 | 173104 | 173104 | 173104 | 139791 | 139594 | 141469 | 134296 | 136146 | 137481 |
| 2089 | 169540 | 173452 | 173925 | 173104 | 173104 | 173104 | 139791 | 139594 | 141469 | 134296 | 136146 | 137481 |
| 2090 | 169540 | 173452 | 173925 | 173104 | 173104 | 173104 | 139791 | 139594 | 141469 | 134296 | 136146 | 137481 |



|      | 61     | 62     | 63     | 64     | 65     | 66     | 67     | 68     | 69     | 70     | 71     | 72     |
|------|--------|--------|--------|--------|--------|--------|--------|--------|--------|--------|--------|--------|
| 2068 | 140371 | 140371 | 140371 | 173646 | 173637 | 181781 | 174301 | 173535 | 176303 | 173706 | 173706 | 173706 |
| 2069 | 140371 | 140371 | 140371 | 173646 | 173637 | 181781 | 174301 | 173535 | 176303 | 173706 | 173706 | 173706 |
| 2070 | 140371 | 140371 | 140371 | 173646 | 173637 | 181781 | 174301 | 173535 | 176303 | 173706 | 173706 | 173706 |
| 2071 | 140371 | 140371 | 140371 | 173646 | 173637 | 181781 | 174301 | 173535 | 176303 | 173706 | 173706 | 173706 |
| 2072 | 140371 | 140371 | 140371 | 173646 | 173637 | 181781 | 174301 | 173535 | 176303 | 173706 | 173706 | 173706 |
| 2073 | 140371 | 140371 | 140371 | 173646 | 173637 | 181781 | 174301 | 173535 | 176303 | 173706 | 173706 | 173706 |
| 2074 | 140371 | 140371 | 140371 | 173646 | 173637 | 181781 | 174301 | 173535 | 176303 | 173706 | 173706 | 173706 |
| 2075 | 140371 | 140371 | 140371 | 173646 | 173637 | 181781 | 174301 | 173535 | 176303 | 173706 | 173706 | 173706 |
| 2076 | 140371 | 140371 | 140371 | 173646 | 173637 | 181781 | 174301 | 173535 | 176303 | 173706 | 173706 | 173706 |
| 2077 | 140371 | 140371 | 140371 | 173646 | 173637 | 181781 | 174301 | 173535 | 176303 | 173706 | 173706 | 173706 |
| 2078 | 140371 | 140371 | 140371 | 173646 | 173637 | 181781 | 174301 | 173535 | 176303 | 173706 | 173706 | 173706 |
| 2079 | 140371 | 140371 | 140371 | 173646 | 173637 | 181781 | 174301 | 173535 | 176303 | 173706 | 173706 | 173706 |
| 2080 | 140371 | 140371 | 140371 | 173646 | 173637 | 181781 | 174301 | 173535 | 176303 | 173706 | 173706 | 173706 |
| 2081 | 140371 | 140371 | 140371 | 173646 | 173637 | 181781 | 174301 | 173535 | 176303 | 173706 | 173706 | 173706 |
| 2082 | 140371 | 140371 | 140371 | 173646 | 173637 | 181781 | 174301 | 173535 | 176303 | 173706 | 173706 | 173706 |
| 2083 | 140371 | 140371 | 140371 | 173646 | 173637 | 181781 | 174301 | 173535 | 176303 | 173706 | 173706 | 173706 |
| 2084 | 140371 | 140371 | 140371 | 173646 | 173637 | 181781 | 174301 | 173535 | 176303 | 173706 | 173706 | 173706 |
| 2085 | 140371 | 140371 | 140371 | 173646 | 173637 | 181781 | 174301 | 173535 | 176303 | 173706 | 173706 | 173706 |
| 2086 | 140371 | 140371 | 140371 | 173646 | 173637 | 181781 | 174301 | 173535 | 176303 | 173706 | 173706 | 173706 |
| 2087 | 140371 | 140371 | 140371 | 173646 | 173637 | 181781 | 174301 | 173535 | 176303 | 173706 | 173706 | 173706 |
| 2088 | 140371 | 140371 | 140371 | 173646 | 173637 | 181781 | 174301 | 173535 | 176303 | 173706 | 173706 | 173706 |
| 2089 | 140371 | 140371 | 140371 | 173646 | 173637 | 181781 | 174301 | 173535 | 176303 | 173706 | 173706 | 173706 |
| 2090 | 140371 | 140371 | 140371 | 173646 | 173637 | 181781 | 174301 | 173535 | 176303 | 173706 | 173706 | 173706 |



|      | 73     | 74     | 75     | 76     | 77     | 78     | 79     | 80     | 81     | 82     | 83     | 84     |
|------|--------|--------|--------|--------|--------|--------|--------|--------|--------|--------|--------|--------|
| 2068 | 173951 | 174203 | 182005 | 171697 | 173928 | 176240 | 173722 | 173722 | 173722 | 137904 | 137904 | 141328 |
| 2069 | 173951 | 174203 | 182005 | 171697 | 173928 | 176240 | 173722 | 173722 | 173722 | 137904 | 137904 | 141328 |
| 2070 | 173951 | 174203 | 182005 | 171697 | 173928 | 176240 | 173722 | 173722 | 173722 | 137904 | 137904 | 141328 |
| 2071 | 173951 | 174203 | 182005 | 171697 | 173928 | 176240 | 173722 | 173722 | 173722 | 137904 | 137904 | 141328 |
| 2072 | 173951 | 174203 | 182005 | 171697 | 173928 | 176240 | 173722 | 173722 | 173722 | 137904 | 137904 | 141328 |
| 2073 | 173951 | 174203 | 182005 | 171697 | 173928 | 176240 | 173722 | 173722 | 173722 | 137904 | 137904 | 141328 |
| 2074 | 173951 | 174203 | 182005 | 171697 | 173928 | 176240 | 173722 | 173722 | 173722 | 137904 | 137904 | 141328 |
| 2075 | 173951 | 174203 | 182005 | 171697 | 173928 | 176240 | 173722 | 173722 | 173722 | 137904 | 137904 | 141328 |
| 2076 | 173951 | 174203 | 182005 | 171697 | 173928 | 176240 | 173722 | 173722 | 173722 | 137904 | 137904 | 141328 |
| 2077 | 173951 | 174203 | 182005 | 171697 | 173928 | 176240 | 173722 | 173722 | 173722 | 137904 | 137904 | 141328 |
| 2078 | 173951 | 174203 | 182005 | 171697 | 173928 | 176240 | 173722 | 173722 | 173722 | 137904 | 137904 | 141328 |
| 2079 | 173951 | 174203 | 182005 | 171697 | 173928 | 176240 | 173722 | 173722 | 173722 | 137904 | 137904 | 141328 |
| 2080 | 173951 | 174203 | 182005 | 171697 | 173928 | 176240 | 173722 | 173722 | 173722 | 137904 | 137904 | 141328 |
| 2081 | 173951 | 174203 | 182005 | 171697 | 173928 | 176240 | 173722 | 173722 | 173722 | 137904 | 137904 | 141328 |
| 2082 | 173951 | 174203 | 182005 | 171697 | 173928 | 176240 | 173722 | 173722 | 173722 | 137904 | 137904 | 141328 |
| 2083 | 173951 | 174203 | 182005 | 171697 | 173928 | 176240 | 173722 | 173722 | 173722 | 137904 | 137904 | 141328 |
| 2084 | 173951 | 174203 | 182005 | 171697 | 173928 | 176240 | 173722 | 173722 | 173722 | 137904 | 137904 | 141328 |
| 2085 | 173951 | 174203 | 182005 | 171697 | 173928 | 176240 | 173722 | 173722 | 173722 | 137904 | 137904 | 141328 |
| 2086 | 173951 | 174203 | 182005 | 171697 | 173928 | 176240 | 173722 | 173722 | 173722 | 137904 | 137904 | 141328 |
| 2087 | 173951 | 174203 | 182005 | 171697 | 173928 | 176240 | 173722 | 173722 | 173722 | 137904 | 137904 | 141328 |
| 2088 | 173951 | 174203 | 182005 | 171697 | 173928 | 176240 | 173722 | 173722 | 173722 | 137904 | 137904 | 141328 |
| 2089 | 173951 | 174203 | 182005 | 171697 | 173928 | 176240 | 173722 | 173722 | 173722 | 137904 | 137904 | 141328 |
| 2090 | 173951 | 174203 | 182005 | 171697 | 173928 | 176240 | 173722 | 173722 | 173722 | 137904 | 137904 | 141328 |





|      | 85     | 86     | 87     | 88     | 89     | 90     | 91     | 92     | 93     | 94     | 95     | 96     |
|------|--------|--------|--------|--------|--------|--------|--------|--------|--------|--------|--------|--------|
| 2068 | 133960 | 135910 | 137179 | 137904 | 137904 | 137904 | 173484 | 173484 | 181694 | 167408 | 173306 | 175915 |
| 2069 | 133960 | 135910 | 137179 | 137904 | 137904 | 137904 | 173484 | 173484 | 181694 | 167408 | 173306 | 175915 |
| 2070 | 133960 | 135910 | 137179 | 137904 | 137904 | 137904 | 173484 | 173484 | 181694 | 167408 | 173306 | 175915 |
| 2071 | 133960 | 135910 | 137179 | 137904 | 137904 | 137904 | 173484 | 173484 | 181694 | 167408 | 173306 | 175915 |
| 2072 | 133960 | 135910 | 137179 | 137904 | 137904 | 137904 | 173484 | 173484 | 181694 | 167408 | 173306 | 175915 |
| 2073 | 133960 | 135910 | 137179 | 137904 | 137904 | 137904 | 173484 | 173484 | 181694 | 167408 | 173306 | 175915 |
| 2074 | 133960 | 135910 | 137179 | 137904 | 137904 | 137904 | 173484 | 173484 | 181694 | 167408 | 173306 | 175915 |
| 2075 | 133960 | 135910 | 137179 | 137904 | 137904 | 137904 | 173484 | 173484 | 181694 | 167408 | 173306 | 175915 |
| 2076 | 133960 | 135910 | 137179 | 137904 | 137904 | 137904 | 173484 | 173484 | 181694 | 167408 | 173306 | 175915 |
| 2077 | 133960 | 135910 | 137179 | 137904 | 137904 | 137904 | 173484 | 173484 | 181694 | 167408 | 173306 | 175915 |
| 2078 | 133960 | 135910 | 137179 | 137904 | 137904 | 137904 | 173484 | 173484 | 181694 | 167408 | 173306 | 175915 |
| 2079 | 133960 | 135910 | 137179 | 137904 | 137904 | 137904 | 173484 | 173484 | 181694 | 167408 | 173306 | 175915 |
| 2080 | 133960 | 135910 | 137179 | 137904 | 137904 | 137904 | 173484 | 173484 | 181694 | 167408 | 173306 | 175915 |
| 2081 | 133960 | 135910 | 137179 | 137904 | 137904 | 137904 | 173484 | 173484 | 181694 | 167408 | 173306 | 175915 |
| 2082 | 133960 | 135910 | 137179 | 137904 | 137904 | 137904 | 173484 | 173484 | 181694 | 167408 | 173306 | 175915 |
| 2083 | 133960 | 135910 | 137179 | 137904 | 137904 | 137904 | 173484 | 173484 | 181694 | 167408 | 173306 | 175915 |
| 2084 | 133960 | 135910 | 137179 | 137904 | 137904 | 137904 | 173484 | 173484 | 181694 | 167408 | 173306 | 175915 |
| 2085 | 133960 | 135910 | 137179 | 137904 | 137904 | 137904 | 173484 | 173484 | 181694 | 167408 | 173306 | 175915 |
| 2086 | 133960 | 135910 | 137179 | 137904 | 137904 | 137904 | 173484 | 173484 | 181694 | 167408 | 173306 | 175915 |
| 2087 | 133960 | 135910 | 137179 | 137904 | 137904 | 137904 | 173484 | 173484 | 181694 | 167408 | 173306 | 175915 |
| 2088 | 133960 | 135910 | 137179 | 137904 | 137904 | 137904 | 173484 | 173484 | 181694 | 167408 | 173306 | 175915 |
| 2089 | 133960 | 135910 | 137179 | 137904 | 137904 | 137904 | 173484 | 173484 | 181694 | 167408 | 173306 | 175915 |
| 2090 | 133960 | 135910 | 137179 | 137904 | 137904 | 137904 | 173484 | 173484 | 181694 | 167408 | 173306 | 175915 |







|      | 109    | 110    | 111    | 112    | 113    | 114    | 115    | 116    | 117    | 118    | 119    | 120    |
|------|--------|--------|--------|--------|--------|--------|--------|--------|--------|--------|--------|--------|
| 2068 | 135564 | 135851 | 137746 | 131691 | 135986 | 134915 | 136423 | 136423 | 136423 | 172825 | 172837 | 181597 |
| 2069 | 135564 | 135851 | 137746 | 131691 | 135986 | 134915 | 136423 | 136423 | 136423 | 172825 | 172837 | 181597 |
| 2070 | 135564 | 135851 | 137746 | 131691 | 135986 | 134915 | 136423 | 136423 | 136423 | 172825 | 172837 | 181597 |
| 2071 | 135564 | 135851 | 137746 | 131691 | 135986 | 134915 | 136423 | 136423 | 136423 | 172825 | 172837 | 181597 |
| 2072 | 135564 | 135851 | 137746 | 131691 | 135986 | 134915 | 136423 | 136423 | 136423 | 172825 | 172837 | 181597 |
| 2073 | 135564 | 135851 | 137746 | 131691 | 135986 | 134915 | 136423 | 136423 | 136423 | 172825 | 172837 | 181597 |
| 2074 | 135564 | 135851 | 137746 | 131691 | 135986 | 134915 | 136423 | 136423 | 136423 | 172825 | 172837 | 181597 |
| 2075 | 135564 | 135851 | 137746 | 131691 | 135986 | 134915 | 136423 | 136423 | 136423 | 172825 | 172837 | 181597 |
| 2076 | 135564 | 135851 | 137746 | 131691 | 135986 | 134915 | 136423 | 136423 | 136423 | 172825 | 172837 | 181597 |
| 2077 | 135564 | 135851 | 137746 | 131691 | 135986 | 134915 | 136423 | 136423 | 136423 | 172825 | 172837 | 181597 |
| 2078 | 135564 | 135851 | 137746 | 131691 | 135986 | 134915 | 136423 | 136423 | 136423 | 172825 | 172837 | 181597 |
| 2079 | 135564 | 135851 | 137746 | 131691 | 135986 | 134915 | 136423 | 136423 | 136423 | 172825 | 172837 | 181597 |
| 2080 | 135564 | 135851 | 137746 | 131691 | 135986 | 134915 | 136423 | 136423 | 136423 | 172825 | 172837 | 181597 |
| 2081 | 135564 | 135851 | 137746 | 131691 | 135986 | 134915 | 136423 | 136423 | 136423 | 172825 | 172837 | 181597 |
| 2082 | 135564 | 135851 | 137746 | 131691 | 135986 | 134915 | 136423 | 136423 | 136423 | 172825 | 172837 | 181597 |
| 2083 | 135564 | 135851 | 137746 | 131691 | 135986 | 134915 | 136423 | 136423 | 136423 | 172825 | 172837 | 181597 |
| 2084 | 135564 | 135851 | 137746 | 131691 | 135986 | 134915 | 136423 | 136423 | 136423 | 172825 | 172837 | 181597 |
| 2085 | 135564 | 135851 | 137746 | 131691 | 135986 | 134915 | 136423 | 136423 | 136423 | 172825 | 172837 | 181597 |
| 2086 | 135564 | 135851 | 137746 | 131691 | 135986 | 134915 | 136423 | 136423 | 136423 | 172825 | 172837 | 181597 |
| 2087 | 135564 | 135851 | 137746 | 131691 | 135986 | 134915 | 136423 | 136423 | 136423 | 172825 | 172837 | 181597 |
| 2088 | 135564 | 135851 | 137746 | 131691 | 135986 | 134915 | 136423 | 136423 | 136423 | 172825 | 172837 | 181597 |
| 2089 | 135564 | 135851 | 137746 | 131691 | 135986 | 134915 | 136423 | 136423 | 136423 | 172825 | 172837 | 181597 |
| 2090 | 135564 | 135851 | 137746 | 131691 | 135986 | 134915 | 136423 | 136423 | 136423 | 172825 | 172837 | 181597 |



|      | 121    | 122    | 123    | 124    | 125    | 126    | 127    | 128    | 129    | 130    | 131    | 132    |
|------|--------|--------|--------|--------|--------|--------|--------|--------|--------|--------|--------|--------|
| 2068 | 165998 | 172884 | 173541 | 172844 | 172844 | 172844 | 172878 | 172764 | 181504 | 167058 | 173356 | 173439 |
| 2069 | 165998 | 172884 | 173541 | 172844 | 172844 | 172844 | 172878 | 172764 | 181504 | 167058 | 173356 | 173439 |
| 2070 | 165998 | 172884 | 173541 | 172844 | 172844 | 172844 | 172878 | 172764 | 181504 | 167058 | 173356 | 173439 |
| 2071 | 165998 | 172884 | 173541 | 172844 | 172844 | 172844 | 172878 | 172764 | 181504 | 167058 | 173356 | 173439 |
| 2072 | 165998 | 172884 | 173541 | 172844 | 172844 | 172844 | 172878 | 172764 | 181504 | 167058 | 173356 | 173439 |
| 2073 | 165998 | 172884 | 173541 | 172844 | 172844 | 172844 | 172878 | 172764 | 181504 | 167058 | 173356 | 173439 |
| 2074 | 165998 | 172884 | 173541 | 172844 | 172844 | 172844 | 172878 | 172764 | 181504 | 167058 | 173356 | 173439 |
| 2075 | 165998 | 172884 | 173541 | 172844 | 172844 | 172844 | 172878 | 172764 | 181504 | 167058 | 173356 | 173439 |
| 2076 | 165998 | 172884 | 173541 | 172844 | 172844 | 172844 | 172878 | 172764 | 181504 | 167058 | 173356 | 173439 |
| 2077 | 165998 | 172884 | 173541 | 172844 | 172844 | 172844 | 172878 | 172764 | 181504 | 167058 | 173356 | 173439 |
| 2078 | 165998 | 172884 | 173541 | 172844 | 172844 | 172844 | 172878 | 172764 | 181504 | 167058 | 173356 | 173439 |
| 2079 | 165998 | 172884 | 173541 | 172844 | 172844 | 172844 | 172878 | 172764 | 181504 | 167058 | 173356 | 173439 |
| 2080 | 165998 | 172884 | 173541 | 172844 | 172844 | 172844 | 172878 | 172764 | 181504 | 167058 | 173356 | 173439 |
| 2081 | 165998 | 172884 | 173541 | 172844 | 172844 | 172844 | 172878 | 172764 | 181504 | 167058 | 173356 | 173439 |
| 2082 | 165998 | 172884 | 173541 | 172844 | 172844 | 172844 | 172878 | 172764 | 181504 | 167058 | 173356 | 173439 |
| 2083 | 165998 | 172884 | 173541 | 172844 | 172844 | 172844 | 172878 | 172764 | 181504 | 167058 | 173356 | 173439 |
| 2084 | 165998 | 172884 | 173541 | 172844 | 172844 | 172844 | 172878 | 172764 | 181504 | 167058 | 173356 | 173439 |
| 2085 | 165998 | 172884 | 173541 | 172844 | 172844 | 172844 | 172878 | 172764 | 181504 | 167058 | 173356 | 173439 |
| 2086 | 165998 | 172884 | 173541 | 172844 | 172844 | 172844 | 172878 | 172764 | 181504 | 167058 | 173356 | 173439 |
| 2087 | 165998 | 172884 | 173541 | 172844 | 172844 | 172844 | 172878 | 172764 | 181504 | 167058 | 173356 | 173439 |
| 2088 | 165998 | 172884 | 173541 | 172844 | 172844 | 172844 | 172878 | 172764 | 181504 | 167058 | 173356 | 173439 |
| 2089 | 165998 | 172884 | 173541 | 172844 | 172844 | 172844 | 172878 | 172764 | 181504 | 167058 | 173356 | 173439 |
| 2090 | 165998 | 172884 | 173541 | 172844 | 172844 | 172844 | 172878 | 172764 | 181504 | 167058 | 173356 | 173439 |



|      | 133    | 134    | 135    | 136    | 137    | 138    | 139    | 140    | 141    | 142    |
|------|--------|--------|--------|--------|--------|--------|--------|--------|--------|--------|
| 2002 | 141104 | 141104 | 141104 | 141104 | 141104 | 141104 | 141104 | 141104 | 141104 | 141104 |
| 2003 | 149233 | 149233 | 149233 | 149233 | 149233 | 149233 | 149233 | 149233 | 149233 | 149233 |
| 2004 | 157146 | 157146 | 157146 | 157146 | 157146 | 157146 | 157146 | 157146 | 157146 | 157146 |
| 2005 | 164299 | 164299 | 164299 | 164299 | 164299 | 164299 | 164299 | 164299 | 164299 | 164299 |
| 2006 | 171496 | 171496 | 171496 | 171496 | 171496 | 171496 | 171496 | 171496 | 171496 | 171496 |
| 2007 | 178790 | 178790 | 178790 | 178790 | 178790 | 178790 | 178790 | 178790 | 178790 | 178790 |
| 2008 | 184759 | 184759 | 184759 | 184759 | 184759 | 184759 | 184759 | 184759 | 184759 | 184759 |
| 2009 | 190596 | 190596 | 190596 | 190596 | 190596 | 190596 | 190596 | 190596 | 190596 | 190596 |
| 2010 | 195244 | 195244 | 195244 | 195244 | 195244 | 195244 | 195244 | 195244 | 195244 | 195244 |
| 2011 | 199472 | 199472 | 199472 | 199472 | 199472 | 199472 | 199472 | 199472 | 199472 | 199472 |
| 2012 | 202694 | 202694 | 202694 | 202694 | 202694 | 202694 | 202694 | 202694 | 202694 | 202694 |
| 2013 | 206172 | 206172 | 206172 | 206172 | 206172 | 206172 | 206172 | 206172 | 206172 | 206172 |
| 2014 | 208841 | 208841 | 208841 | 208841 | 208841 | 208841 | 208841 | 208841 | 208841 | 208841 |
| 2015 | 211298 | 211298 | 211298 | 211298 | 211298 | 211298 | 211298 | 211298 | 211298 | 211298 |
| 2016 | 213570 | 213570 | 213570 | 213570 | 213570 | 213570 | 213570 | 213570 | 213570 | 213570 |
| 2017 | 215247 | 215247 | 215247 | 215247 | 215247 | 215247 | 215247 | 215247 | 215247 | 215247 |
| 2018 | 216679 | 216679 | 216679 | 216679 | 216679 | 216679 | 216679 | 216679 | 216679 | 216679 |
| 2019 | 217907 | 217907 | 217907 | 217907 | 217907 | 217907 | 217907 | 217907 | 217907 | 217907 |
| 2020 | 218888 | 218888 | 218888 | 218888 | 218888 | 218888 | 214207 | 218888 | 218888 | 218888 |
| 2021 | 219755 | 219755 | 219755 | 219755 | 219755 | 219755 | 213646 | 219755 | 219755 | 219755 |
| 2022 | 220922 | 220922 | 220922 | 220922 | 220922 | 220922 | 211589 | 220922 | 220922 | 220922 |
| 2023 | 221438 | 221438 | 221438 | 221438 | 221438 | 221438 | 209627 | 221438 | 221438 | 221438 |
| 2024 | 221835 | 221835 | 221835 | 221835 | 221835 | 221835 | 207608 | 221835 | 221835 | 221835 |
| 2025 | 223145 | 223145 | 223145 | 219176 | 219176 | 222385 | 205385 | 219176 | 219176 | 219176 |
| 2026 | 224085 | 224085 | 224085 | 218720 | 219115 | 222873 | 201045 | 219336 | 219336 | 219336 |
| 2027 | 225129 | 225129 | 225129 | 217748 | 217791 | 223196 | 197642 | 217484 | 217484 | 217484 |
| 2028 | 226473 | 226473 | 226473 | 216403 | 216622 | 223606 | 195750 | 216077 | 216077 | 216077 |
| 2029 | 227452 | 227452 | 227452 | 214407 | 215153 | 224093 | 191667 | 214222 | 214222 | 214222 |
| 2030 | 230019 | 230019 | 230019 | 214658 | 214348 | 222915 | 189062 | 214110 | 214110 | 214110 |
| 2031 | 232031 | 232031 | 232031 | 212724 | 212328 | 223785 | 185828 | 212749 | 212749 | 212749 |
| 2032 | 233284 | 233284 | 233284 | 210875 | 210830 | 223230 | 182904 | 211603 | 211603 | 211603 |
| 2033 | 236137 | 236137 | 236137 | 210485 | 210705 | 222770 | 181763 | 210290 | 210291 | 210290 |
| 2034 | 238442 | 238442 | 238442 | 208813 | 209210 | 221438 | 177810 | 208083 | 208131 | 208083 |
| 2035 | 242029 | 242029 | 242029 | 207690 | 208952 | 220747 | 177682 | 207944 | 207991 | 207944 |
| 2036 | 241457 | 241457 | 241457 | 203077 | 202927 | 216451 | 169950 | 202006 | 201798 | 202006 |
| 2037 | 242977 | 242977 | 242977 | 198655 | 199093 | 214561 | 166350 | 198292 | 198733 | 198292 |
| 2038 | 242027 | 242027 | 242027 | 192125 | 192368 | 212135 | 160931 | 191755 | 191352 | 191778 |
| 2039 | 242371 | 242371 | 242371 | 186185 | 186426 | 209024 | 155246 | 185815 | 186247 | 185822 |
| 2040 | 241103 | 241103 | 241103 | 179213 | 179341 | 205290 | 148544 | 178541 | 178724 | 178546 |
| 2041 | 239305 | 239305 | 239305 | 172147 | 172702 | 199990 | 143259 | 171949 | 172771 | 171926 |
| 2042 | 237353 | 237353 | 237353 | 166043 | 165707 | 193438 | 140938 | 163967 | 165726 | 165344 |
| 2043 | 237486 | 237486 | 237486 | 160320 | 160667 | 188252 | 132521 | 159577 | 160378 | 160428 |
| 2044 | 238118 | 238118 | 238118 | 154605 | 154957 | 183224 | 129193 | 153472 | 154645 | 154696 |
| 2045 | 237927 | 237927 | 237927 | 143969 | 143959 | 177272 | 128229 | 142181 | 156042 | 143637 |
| 2046 | 238051 | 238051 | 238051 | 139400 | 139158 | 171663 | 130046 | 137380 | 145200 | 138836 |
| 2047 | 224885 | 224885 | 224885 | 139477 | 139214 | 167403 | 133135 | 137436 | 141187 | 138892 |
| 2048 | 211854 | 211854 | 211854 | 138925 | 138390 | 166541 | 133636 | 136612 | 138282 | 138068 |
| 2049 | 201173 | 201173 | 201173 | 138376 | 137798 | 151922 | 133634 | 136020 | 137226 | 137476 |
| 2050 | 193704 | 193704 | 193704 | 139123 | 138524 | 145874 | 134402 | 136746 | 137401 | 138202 |
| 2051 | 186417 | 186417 | 186417 | 139126 | 138527 | 143460 | 134405 | 136749 | 137383 | 138205 |
| 2052 | 181487 | 181487 | 181487 | 139146 | 138547 | 141547 | 134425 | 136769 | 137403 | 138225 |
| 2053 | 179384 | 179384 | 179384 | 139146 | 138547 | 141271 | 134425 | 136769 | 137403 | 138225 |
| 2054 | 177970 | 177970 | 177970 | 139117 | 138518 | 141179 | 134396 | 136740 | 137374 | 138196 |
| 2055 | 176407 | 176407 | 176407 | 139126 | 138527 | 141188 | 134405 | 136749 | 137383 | 138205 |
| 2056 | 174948 | 174948 | 174948 | 139109 | 138510 | 141171 | 134388 | 136732 | 137366 | 138188 |
| 2057 | 173437 | 173437 | 173437 | 139109 | 138510 | 141171 | 134388 | 136732 | 137366 | 138188 |
| 2058 | 172899 | 172899 | 172899 | 139109 | 138510 | 141171 | 134388 | 136732 | 137366 | 138188 |
| 2059 | 172795 | 172795 | 172795 | 139109 | 138510 | 141171 | 134388 | 136732 | 137366 | 138188 |
| 2060 | 172751 | 172751 | 172751 | 139109 | 138510 | 141171 | 134388 | 136732 | 137366 | 138188 |
| 2061 | 172751 | 172751 | 172751 | 139109 | 138510 | 141171 | 134388 | 136732 | 137366 | 138188 |
| 2062 | 172751 | 172751 | 172751 | 139109 | 138510 | 141171 | 134388 | 136732 | 137366 | 138188 |
| 2063 | 172751 | 172751 | 172751 | 139109 | 138510 | 141171 | 134388 | 136732 | 137366 | 138188 |
| 2064 | 172751 | 172751 | 172751 | 139109 | 138510 | 141171 | 134388 | 136732 | 137366 | 138188 |
| 2065 | 172751 | 172751 | 172751 | 139109 | 138510 | 141171 | 134388 | 136732 | 137366 | 138188 |
| 2066 | 172751 | 172751 | 172751 | 139109 | 138510 | 141171 | 134388 | 136732 | 137366 | 138188 |
| 2067 | 172751 | 172751 | 172751 | 139109 | 138510 | 141171 | 134388 | 136732 | 137366 | 138188 |

|      | 133    | 134    | 135    | 136    | 137    | 138    | 139    | 140    | 141    | 142    |
|------|--------|--------|--------|--------|--------|--------|--------|--------|--------|--------|
| 2068 | 172751 | 172751 | 172751 | 139109 | 138510 | 141171 | 134388 | 136732 | 137366 | 138188 |
| 2069 | 172751 | 172751 | 172751 | 139109 | 138510 | 141171 | 134388 | 136732 | 137366 | 138188 |
| 2070 | 172751 | 172751 | 172751 | 139109 | 138510 | 141171 | 134388 | 136732 | 137366 | 138188 |
| 2071 | 172751 | 172751 | 172751 | 139109 | 138510 | 141171 | 134388 | 136732 | 137366 | 138188 |
| 2072 | 172751 | 172751 | 172751 | 139109 | 138510 | 141171 | 134388 | 136732 | 137366 | 138188 |
| 2073 | 172751 | 172751 | 172751 | 139109 | 138510 | 141171 | 134388 | 136732 | 137366 | 138188 |
| 2074 | 172751 | 172751 | 172751 | 139109 | 138510 | 141171 | 134388 | 136732 | 137366 | 138188 |
| 2075 | 172751 | 172751 | 172751 | 139109 | 138510 | 141171 | 134388 | 136732 | 137366 | 138188 |
| 2076 | 172751 | 172751 | 172751 | 139109 | 138510 | 141171 | 134388 | 136732 | 137366 | 138188 |
| 2077 | 172751 | 172751 | 172751 | 139109 | 138510 | 141171 | 134388 | 136732 | 137366 | 138188 |
| 2078 | 172751 | 172751 | 172751 | 139109 | 138510 | 141171 | 134388 | 136732 | 137366 | 138188 |
| 2079 | 172751 | 172751 | 172751 | 139109 | 138510 | 141171 | 134388 | 136732 | 137366 | 138188 |
| 2080 | 172751 | 172751 | 172751 | 139109 | 138510 | 141171 | 134388 | 136732 | 137366 | 138188 |
| 2081 | 172751 | 172751 | 172751 | 139109 | 138510 | 141171 | 134388 | 136732 | 137366 | 138188 |
| 2082 | 172751 | 172751 | 172751 | 139109 | 138510 | 141171 | 134388 | 136732 | 137366 | 138188 |
| 2083 | 172751 | 172751 | 172751 | 139109 | 138510 | 141171 | 134388 | 136732 | 137366 | 138188 |
| 2084 | 172751 | 172751 | 172751 | 139109 | 138510 | 141171 | 134388 | 136732 | 137366 | 138188 |
| 2085 | 172751 | 172751 | 172751 | 139109 | 138510 | 141171 | 134388 | 136732 | 137366 | 138188 |
| 2086 | 172751 | 172751 | 172751 | 139109 | 138510 | 141171 | 134388 | 136732 | 137366 | 138188 |
| 2087 | 172751 | 172751 | 172751 | 139109 | 138510 | 141171 | 134388 | 136732 | 137366 | 138188 |
| 2088 | 172751 | 172751 | 172751 | 139109 | 138510 | 141171 | 134388 | 136732 | 137366 | 138188 |
| 2089 | 172751 | 172751 | 172751 | 139109 | 138510 | 141171 | 134388 | 136732 | 137366 | 138188 |
| 2090 | 172751 | 172751 | 172751 | 139109 | 138510 | 141171 | 134388 | 136732 | 137366 | 138188 |



|      | 143    | 144    | 145    | 146    | 147    | 148    | 149    | 150    | 151    | 152    | 153    |
|------|--------|--------|--------|--------|--------|--------|--------|--------|--------|--------|--------|
| 2068 | 138188 | 138188 | 173408 | 173497 | 181787 | 171220 | 173444 | 175059 | 173462 | 173462 | 173462 |
| 2069 | 138188 | 138188 | 173408 | 173497 | 181787 | 171220 | 173444 | 175059 | 173462 | 173462 | 173462 |
| 2070 | 138188 | 138188 | 173408 | 173497 | 181787 | 171220 | 173444 | 175059 | 173462 | 173462 | 173462 |
| 2071 | 138188 | 138188 | 173408 | 173497 | 181787 | 171220 | 173444 | 175059 | 173462 | 173462 | 173462 |
| 2072 | 138188 | 138188 | 173408 | 173497 | 181787 | 171220 | 173444 | 175059 | 173462 | 173462 | 173462 |
| 2073 | 138188 | 138188 | 173408 | 173497 | 181787 | 171220 | 173444 | 175059 | 173462 | 173462 | 173462 |
| 2074 | 138188 | 138188 | 173408 | 173497 | 181787 | 171220 | 173444 | 175059 | 173462 | 173462 | 173462 |
| 2075 | 138188 | 138188 | 173408 | 173497 | 181787 | 171220 | 173444 | 175059 | 173462 | 173462 | 173462 |
| 2076 | 138188 | 138188 | 173408 | 173497 | 181787 | 171220 | 173444 | 175059 | 173462 | 173462 | 173462 |
| 2077 | 138188 | 138188 | 173408 | 173497 | 181787 | 171220 | 173444 | 175059 | 173462 | 173462 | 173462 |
| 2078 | 138188 | 138188 | 173408 | 173497 | 181787 | 171220 | 173444 | 175059 | 173462 | 173462 | 173462 |
| 2079 | 138188 | 138188 | 173408 | 173497 | 181787 | 171220 | 173444 | 175059 | 173462 | 173462 | 173462 |
| 2080 | 138188 | 138188 | 173408 | 173497 | 181787 | 171220 | 173444 | 175059 | 173462 | 173462 | 173462 |
| 2081 | 138188 | 138188 | 173408 | 173497 | 181787 | 171220 | 173444 | 175059 | 173462 | 173462 | 173462 |
| 2082 | 138188 | 138188 | 173408 | 173497 | 181787 | 171220 | 173444 | 175059 | 173462 | 173462 | 173462 |
| 2083 | 138188 | 138188 | 173408 | 173497 | 181787 | 171220 | 173444 | 175059 | 173462 | 173462 | 173462 |
| 2084 | 138188 | 138188 | 173408 | 173497 | 181787 | 171220 | 173444 | 175059 | 173462 | 173462 | 173462 |
| 2085 | 138188 | 138188 | 173408 | 173497 | 181787 | 171220 | 173444 | 175059 | 173462 | 173462 | 173462 |
| 2086 | 138188 | 138188 | 173408 | 173497 | 181787 | 171220 | 173444 | 175059 | 173462 | 173462 | 173462 |
| 2087 | 138188 | 138188 | 173408 | 173497 | 181787 | 171220 | 173444 | 175059 | 173462 | 173462 | 173462 |
| 2088 | 138188 | 138188 | 173408 | 173497 | 181787 | 171220 | 173444 | 175059 | 173462 | 173462 | 173462 |
| 2089 | 138188 | 138188 | 173408 | 173497 | 181787 | 171220 | 173444 | 175059 | 173462 | 173462 | 173462 |
| 2090 | 138188 | 138188 | 173408 | 173497 | 181787 | 171220 | 173444 | 175059 | 173462 | 173462 | 173462 |

|      | 154    | 155    | 156    | 157    | 158    | 159    | 160    | 161    | 162    |
|------|--------|--------|--------|--------|--------|--------|--------|--------|--------|
| 2002 | 141104 | 141104 | 141104 | 141104 | 141104 | 141104 | 141104 | 141104 | 141104 |
| 2003 | 149233 | 149233 | 149233 | 149233 | 149233 | 149233 | 149233 | 149233 | 149233 |
| 2004 | 157146 | 157146 | 157146 | 157146 | 157146 | 157146 | 157146 | 157146 | 157146 |
| 2005 | 164299 | 164299 | 164299 | 164299 | 164299 | 164299 | 164299 | 164299 | 164299 |
| 2006 | 171496 | 171496 | 171496 | 171496 | 171496 | 171496 | 171496 | 171496 | 171496 |
| 2007 | 178790 | 178790 | 178790 | 178790 | 178790 | 178790 | 178790 | 178790 | 178790 |
| 2008 | 184759 | 184759 | 184759 | 184759 | 184759 | 184759 | 184759 | 184759 | 184759 |
| 2009 | 190596 | 190596 | 190596 | 190596 | 190596 | 190596 | 190596 | 190596 | 190596 |
| 2010 | 195244 | 195244 | 195244 | 195244 | 195244 | 195244 | 195244 | 195244 | 195244 |
| 2011 | 199472 | 199472 | 199472 | 199472 | 199472 | 199472 | 199472 | 199472 | 199472 |
| 2012 | 202694 | 202694 | 202694 | 202694 | 202694 | 202694 | 202694 | 202694 | 202694 |
| 2013 | 206172 | 206172 | 206172 | 206172 | 206172 | 206172 | 206172 | 206172 | 206172 |
| 2014 | 208841 | 208841 | 208841 | 208841 | 208841 | 208841 | 208841 | 208841 | 208841 |
| 2015 | 211298 | 211298 | 211298 | 211298 | 211298 | 211298 | 211298 | 211298 | 211298 |
| 2016 | 213570 | 213570 | 213570 | 213570 | 213570 | 213570 | 213570 | 213570 | 213570 |
| 2017 | 215247 | 215247 | 215247 | 215247 | 215247 | 215247 | 215247 | 215247 | 215247 |
| 2018 | 216679 | 216679 | 216679 | 216679 | 216679 | 216679 | 216679 | 216679 | 216679 |
| 2019 | 217907 | 217907 | 217907 | 217907 | 217907 | 217907 | 217907 | 217907 | 217907 |
| 2020 | 218888 | 218888 | 218888 | 218973 | 218888 | 218888 | 218888 | 218888 | 218888 |
| 2021 | 219755 | 219755 | 219755 | 221511 | 219755 | 219755 | 219755 | 219755 | 219755 |
| 2022 | 220922 | 220922 | 220922 | 223691 | 220922 | 220922 | 220922 | 220922 | 220922 |
| 2023 | 221438 | 221438 | 221438 | 225640 | 221438 | 221438 | 221438 | 221438 | 221438 |
| 2024 | 221835 | 221835 | 221835 | 226570 | 221835 | 221835 | 221835 | 221835 | 221835 |
| 2025 | 223145 | 223145 | 222385 | 227963 | 223145 | 223145 | 223145 | 223145 | 223145 |
| 2026 | 225834 | 225608 | 222873 | 228746 | 225727 | 225917 | 225917 | 225917 | 225917 |
| 2027 | 228372 | 227746 | 223196 | 229921 | 228204 | 228393 | 228393 | 228393 | 228393 |
| 2028 | 230386 | 229798 | 223606 | 230555 | 230212 | 230509 | 230451 | 230451 | 230451 |
| 2029 | 232222 | 231764 | 224093 | 231006 | 232052 | 232328 | 232270 | 232270 | 232270 |
| 2030 | 235170 | 235131 | 226493 | 233262 | 235270 | 235484 | 235404 | 235404 | 235404 |
| 2031 | 237279 | 237026 | 229892 | 234655 | 237279 | 237315 | 237301 | 237301 | 237301 |
| 2032 | 238510 | 238196 | 232594 | 234940 | 238298 | 238460 | 238447 | 238447 | 238447 |
| 2033 | 241361 | 241091 | 236137 | 237499 | 241276 | 241714 | 241405 | 241405 | 241405 |
| 2034 | 242874 | 242582 | 238448 | 239439 | 242929 | 243243 | 242899 | 242899 | 242899 |
| 2035 | 245853 | 245855 | 243193 | 243231 | 246243 | 246505 | 246087 | 246087 | 246087 |
| 2036 | 244676 | 244591 | 243484 | 241533 | 244969 | 245246 | 244675 | 244675 | 244675 |
| 2037 | 245490 | 245259 | 245307 | 242668 | 245846 | 246181 | 245344 | 245344 | 245344 |
| 2038 | 243727 | 243774 | 243333 | 241601 | 244446 | 244952 | 243768 | 243768 | 243768 |
| 2039 | 242965 | 243133 | 242548 | 241003 | 243623 | 244178 | 243068 | 243068 | 243068 |
| 2040 | 240621 | 240696 | 241039 | 238840 | 241097 | 241648 | 240721 | 240721 | 240721 |
| 2041 | 238586 | 238743 | 238964 | 234878 | 238933 | 239548 | 238602 | 238602 | 238602 |
| 2042 | 235994 | 236200 | 237639 | 229997 | 236082 | 237238 | 235860 | 235860 | 235860 |
| 2043 | 236170 | 236375 | 238129 | 228831 | 236006 | 237204 | 236037 | 236037 | 236037 |
| 2044 | 236005 | 236271 | 238437 | 218231 | 235901 | 236856 | 236038 | 236038 | 236038 |
| 2045 | 234818 | 235018 | 237501 | 206930 | 234975 | 233434 | 234659 | 234659 | 234659 |
| 2046 | 222251 | 237732 | 236211 | 197500 | 237999 | 234116 | 222092 | 222092 | 222092 |
| 2047 | 211684 | 225614 | 235017 | 191412 | 225881 | 221992 | 211525 | 211525 | 211525 |
| 2048 | 202304 | 212584 | 234494 | 186221 | 212851 | 208837 | 202166 | 202166 | 202166 |
| 2049 | 194065 | 201925 | 218141 | 181542 | 202191 | 198177 | 193927 | 193927 | 193927 |
| 2050 | 187417 | 194456 | 207220 | 178438 | 194722 | 192162 | 187515 | 187515 | 187515 |
| 2051 | 182680 | 187168 | 199245 | 175791 | 187435 | 186820 | 182778 | 182778 | 182778 |
| 2052 | 180702 | 182238 | 191920 | 173852 | 182505 | 182447 | 180800 | 180800 | 180800 |
| 2053 | 179044 | 180136 | 187917 | 172609 | 180402 | 180335 | 179142 | 179142 | 179142 |
| 2054 | 177674 | 178722 | 186195 | 171777 | 178988 | 178921 | 177772 | 177772 | 177772 |
| 2055 | 176114 | 177159 | 184632 | 171064 | 177425 | 177358 | 176212 | 176212 | 176212 |
| 2056 | 174817 | 175740 | 183211 | 170675 | 176007 | 176432 | 174915 | 174915 | 174915 |
| 2057 | 174279 | 174316 | 182343 | 170625 | 174517 | 175517 | 174377 | 174377 | 174377 |
| 2058 | 174175 | 173734 | 181718 | 170581 | 173979 | 175517 | 174273 | 174273 | 174273 |
| 2059 | 174131 | 173630 | 181638 | 170581 | 173875 | 175517 | 174229 | 174229 | 174229 |
| 2060 | 174131 | 173586 | 181638 | 170581 | 173831 | 175517 | 174229 | 174229 | 174229 |
| 2061 | 174131 | 173586 | 181638 | 170581 | 173831 | 175517 | 174229 | 174229 | 174229 |
| 2062 | 174131 | 173586 | 181638 | 170581 | 173831 | 175517 | 174229 | 174229 | 174229 |
| 2063 | 174131 | 173586 | 181638 | 170581 | 173831 | 175517 | 174229 | 174229 | 174229 |
| 2064 | 174131 | 173586 | 181638 | 170581 | 173831 | 175517 | 174229 | 174229 | 174229 |
| 2065 | 174131 | 173586 | 181638 | 170581 | 173831 | 175517 | 174229 | 174229 | 174229 |
| 2066 | 174131 | 173586 | 181638 | 170581 | 173831 | 175517 | 174229 | 174229 | 174229 |
| 2067 | 174131 | 173586 | 181638 | 170581 | 173831 | 175517 | 174229 | 174229 | 174229 |

|      | 154    | 155    | 156    | 157    | 158    | 159    | 160    | 161    | 162    |
|------|--------|--------|--------|--------|--------|--------|--------|--------|--------|
| 2068 | 174131 | 173586 | 181638 | 170581 | 173831 | 175517 | 174229 | 174229 | 174229 |
| 2069 | 174131 | 173586 | 181638 | 170581 | 173831 | 175517 | 174229 | 174229 | 174229 |
| 2070 | 174131 | 173586 | 181638 | 170581 | 173831 | 175517 | 174229 | 174229 | 174229 |
| 2071 | 174131 | 173586 | 181638 | 170581 | 173831 | 175517 | 174229 | 174229 | 174229 |
| 2072 | 174131 | 173586 | 181638 | 170581 | 173831 | 175517 | 174229 | 174229 | 174229 |
| 2073 | 174131 | 173586 | 181638 | 170581 | 173831 | 175517 | 174229 | 174229 | 174229 |
| 2074 | 174131 | 173586 | 181638 | 170581 | 173831 | 175517 | 174229 | 174229 | 174229 |
| 2075 | 174131 | 173586 | 181638 | 170581 | 173831 | 175517 | 174229 | 174229 | 174229 |
| 2076 | 174131 | 173586 | 181638 | 170581 | 173831 | 175517 | 174229 | 174229 | 174229 |
| 2077 | 174131 | 173586 | 181638 | 170581 | 173831 | 175517 | 174229 | 174229 | 174229 |
| 2078 | 174131 | 173586 | 181638 | 170581 | 173831 | 175517 | 174229 | 174229 | 174229 |
| 2079 | 174131 | 173586 | 181638 | 170581 | 173831 | 175517 | 174229 | 174229 | 174229 |
| 2080 | 174131 | 173586 | 181638 | 170581 | 173831 | 175517 | 174229 | 174229 | 174229 |
| 2081 | 174131 | 173586 | 181638 | 170581 | 173831 | 175517 | 174229 | 174229 | 174229 |
| 2082 | 174131 | 173586 | 181638 | 170581 | 173831 | 175517 | 174229 | 174229 | 174229 |
| 2083 | 174131 | 173586 | 181638 | 170581 | 173831 | 175517 | 174229 | 174229 | 174229 |
| 2084 | 174131 | 173586 | 181638 | 170581 | 173831 | 175517 | 174229 | 174229 | 174229 |
| 2085 | 174131 | 173586 | 181638 | 170581 | 173831 | 175517 | 174229 | 174229 | 174229 |
| 2086 | 174131 | 173586 | 181638 | 170581 | 173831 | 175517 | 174229 | 174229 | 174229 |
| 2087 | 174131 | 173586 | 181638 | 170581 | 173831 | 175517 | 174229 | 174229 | 174229 |
| 2088 | 174131 | 173586 | 181638 | 170581 | 173831 | 175517 | 174229 | 174229 | 174229 |
| 2089 | 174131 | 173586 | 181638 | 170581 | 173831 | 175517 | 174229 | 174229 | 174229 |
| 2090 | 174131 | 173586 | 181638 | 170581 | 173831 | 175517 | 174229 | 174229 | 174229 |

|      | 1   | 2   | 3   | 4   | 5   | 6   | 7   | 8   | 9   | 10  | 11  |
|------|-----|-----|-----|-----|-----|-----|-----|-----|-----|-----|-----|
| 2002 | 0   | 0   | 0   | 0   | 0   | 0   | 0   | 0   | 0   | 0   | 0   |
| 2003 | 0   | 0   | 0   | 0   | 0   | 0   | 0   | 0   | 0   | 0   | 0   |
| 2004 | 0   | 0   | 0   | 0   | 0   | 0   | 0   | 0   | 0   | 0   | 0   |
| 2005 | 0   | 0   | 0   | 0   | 0   | 0   | 0   | 0   | 0   | 0   | 0   |
| 2006 | 0   | 0   | 0   | 0   | 0   | 0   | 0   | 0   | 0   | 0   | 0   |
| 2007 | 0   | 0   | 0   | 0   | 0   | 0   | 0   | 0   | 0   | 0   | 0   |
| 2008 | 0   | 0   | 0   | 0   | 0   | 0   | 0   | 0   | 0   | 0   | 0   |
| 2009 | 0   | 0   | 0   | 0   | 0   | 0   | 0   | 0   | 0   | 0   | 0   |
| 2010 | 0   | 0   | 0   | 0   | 0   | 0   | 0   | 0   | 0   | 0   | 0   |
| 2011 | 0   | 0   | 0   | 0   | 0   | 0   | 0   | 0   | 0   | 0   | 0   |
| 2012 | 0   | 0   | 0   | 0   | 0   | 0   | 0   | 0   | 0   | 0   | 0   |
| 2013 | 0   | 0   | 0   | 0   | 0   | 0   | 0   | 0   | 0   | 0   | 0   |
| 2014 | 0   | 0   | 0   | 0   | 0   | 0   | 0   | 0   | 0   | 0   | 0   |
| 2015 | 0   | 0   | 0   | 0   | 0   | 0   | 0   | 0   | 0   | 0   | 0   |
| 2016 | 0   | 0   | 0   | 0   | 0   | 0   | 0   | 0   | 0   | 0   | 0   |
| 2017 | 0   | 0   | 0   | 0   | 0   | 0   | 0   | 0   | 0   | 0   | 0   |
| 2018 | 0   | 0   | 0   | 0   | 0   | 0   | 0   | 0   | 0   | 0   | 0   |
| 2019 | 0   | 0   | 0   | 0   | 0   | 0   | 0   | 0   | 0   | 0   | 0   |
| 2020 | 0   | 0   | 0   | 250 | 0   | 0   | 0   | 0   | 0   | 0   | 0   |
| 2021 | 0   | 0   | 0   | 250 | 0   | 0   | 0   | 0   | 0   | 0   | 0   |
| 2022 | 0   | 0   | 0   | 250 | 0   | 0   | 0   | 0   | 0   | 0   | 0   |
| 2023 | 0   | 0   | 0   | 250 | 0   | 0   | 0   | 0   | 0   | 0   | 0   |
| 2024 | 0   | 0   | 0   | 250 | 0   | 0   | 0   | 0   | 0   | 0   | 0   |
| 2025 | 250 | 250 | 0   | 250 | 250 | 250 | 250 | 250 | 250 | 250 | 250 |
| 2026 | 250 | 250 | 0   | 250 | 250 | 250 | 250 | 250 | 250 | 250 | 250 |
| 2027 | 250 | 250 | 0   | 250 | 250 | 250 | 250 | 250 | 250 | 250 | 250 |
| 2028 | 250 | 250 | 0   | 250 | 250 | 250 | 250 | 250 | 250 | 250 | 250 |
| 2029 | 250 | 250 | 0   | 250 | 250 | 250 | 250 | 250 | 250 | 250 | 250 |
| 2030 | 250 | 250 | 250 | 250 | 250 | 250 | 250 | 250 | 250 | 250 | 250 |
| 2031 | 250 | 250 | 250 | 250 | 250 | 250 | 250 | 250 | 250 | 250 | 250 |
| 2032 | 250 | 250 | 250 | 250 | 250 | 250 | 250 | 250 | 250 | 250 | 250 |
| 2033 | 250 | 250 | 250 | 250 | 250 | 250 | 250 | 250 | 250 | 250 | 250 |
| 2034 | 250 | 250 | 250 | 250 | 250 | 250 | 250 | 250 | 250 | 250 | 250 |
| 2035 | 250 | 250 | 250 | 250 | 250 | 250 | 250 | 250 | 250 | 250 | 250 |
| 2036 | 250 | 250 | 250 | 250 | 250 | 250 | 250 | 250 | 250 | 250 | 250 |
| 2037 | 250 | 250 | 250 | 250 | 250 | 250 | 250 | 250 | 250 | 250 | 250 |
| 2038 | 250 | 250 | 250 | 250 | 250 | 250 | 250 | 250 | 250 | 250 | 250 |
| 2039 | 250 | 250 | 250 | 250 | 250 | 250 | 250 | 250 | 250 | 250 | 250 |
| 2040 | 250 | 250 | 250 | 250 | 250 | 250 | 250 | 250 | 250 | 250 | 250 |
| 2041 | 250 | 250 | 250 | 250 | 250 | 250 | 250 | 250 | 250 | 250 | 250 |
| 2042 | 250 | 250 | 250 | 250 | 250 | 250 | 250 | 250 | 250 | 250 | 250 |
| 2043 | 250 | 250 | 250 | 250 | 250 | 250 | 250 | 250 | 250 | 250 | 250 |
| 2044 | 250 | 250 | 250 | 250 | 250 | 250 | 250 | 250 | 250 | 250 | 250 |
| 2045 | 250 | 250 | 250 | 242 | 250 | 250 | 250 | 250 | 250 | 250 | 250 |
| 2046 | 250 | 250 | 250 | 163 | 250 | 250 | 250 | 250 | 250 | 250 | 250 |
| 2047 | 250 | 250 | 250 | 75  | 250 | 250 | 250 | 250 | 250 | 250 | 250 |
| 2048 | 250 | 250 | 250 | 39  | 250 | 250 | 250 | 250 | 250 | 250 | 250 |
| 2049 | 250 | 250 | 250 | 7   | 250 | 250 | 250 | 250 | 250 | 250 | 250 |
| 2050 | 213 | 250 | 250 | 7   | 250 | 237 | 227 | 227 | 227 | 250 | 250 |
| 2051 | 176 | 221 | 250 | 0   | 241 | 209 | 198 | 198 | 198 | 250 | 250 |
| 2052 | 125 | 179 | 250 | 0   | 189 | 143 | 134 | 134 | 134 | 250 | 250 |
| 2053 | 81  | 110 | 250 | 0   | 110 | 89  | 95  | 95  | 95  | 247 | 250 |
| 2054 | 22  | 74  | 250 | 0   | 59  | 49  | 49  | 49  | 49  | 167 | 226 |
| 2055 | 15  | 24  | 250 | 0   | 24  | 25  | 25  | 25  | 25  | 97  | 134 |
| 2056 | 7   | 19  | 237 | 0   | 17  | 17  | 17  | 17  | 17  | 47  | 75  |
| 2057 | 7   | 5   | 201 | 0   | 7   | 8   | 8   | 8   | 8   | 18  | 50  |
| 2058 | 0   | 5   | 143 | 0   | 7   | 7   | 0   | 0   | 0   | 7   | 12  |
| 2059 | 0   | 0   | 97  | 0   | 0   | 0   | 0   | 0   | 0   | 7   | 2   |

|      | 1 | 2 | 3  | 4 | 5 | 6 | 7 | 8 | 9 | 10 | 11 |
|------|---|---|----|---|---|---|---|---|---|----|----|
| 2060 | 0 | 0 | 59 | 0 | 0 | 0 | 0 | 0 | 0 | 1  | 1  |
| 2061 | 0 | 0 | 35 | 0 | 0 | 0 | 0 | 0 | 0 | 1  | 1  |
| 2062 | 0 | 0 | 14 | 0 | 0 | 0 | 0 | 0 | 0 | 1  | 1  |
| 2063 | 0 | 0 | 8  | 0 | 0 | 0 | 0 | 0 | 0 | 1  | 1  |
| 2064 | 0 | 0 | 2  | 0 | 0 | 0 | 0 | 0 | 0 | 1  | 1  |
| 2065 | 0 | 0 | 2  | 0 | 0 | 0 | 0 | 0 | 0 | 1  | 1  |
| 2066 | 0 | 0 | 0  | 0 | 0 | 0 | 0 | 0 | 0 | 1  | 1  |
| 2067 | 0 | 0 | 0  | 0 | 0 | 0 | 0 | 0 | 0 | 1  | 1  |
| 2068 | 0 | 0 | 0  | 0 | 0 | 0 | 0 | 0 | 0 | 1  | 1  |
| 2069 | 0 | 0 | 0  | 0 | 0 | 0 | 0 | 0 | 0 | 1  | 1  |
| 2070 | 0 | 0 | 0  | 0 | 0 | 0 | 0 | 0 | 0 | 1  | 1  |
| 2071 | 0 | 0 | 0  | 0 | 0 | 0 | 0 | 0 | 0 | 1  | 1  |
| 2072 | 0 | 0 | 0  | 0 | 0 | 0 | 0 | 0 | 0 | 1  | 1  |
| 2073 | 0 | 0 | 0  | 0 | 0 | 0 | 0 | 0 | 0 | 1  | 1  |
| 2074 | 0 | 0 | 0  | 0 | 0 | 0 | 0 | 0 | 0 | 1  | 1  |
| 2075 | 0 | 0 | 0  | 0 | 0 | 0 | 0 | 0 | 0 | 1  | 1  |
| 2076 | 0 | 0 | 0  | 0 | 0 | 0 | 0 | 0 | 0 | 1  | 1  |
| 2077 | 0 | 0 | 0  | 0 | 0 | 0 | 0 | 0 | 0 | 1  | 1  |
| 2078 | 0 | 0 | 0  | 0 | 0 | 0 | 0 | 0 | 0 | 1  | 1  |
| 2079 | 0 | 0 | 0  | 0 | 0 | 0 | 0 | 0 | 0 | 1  | 1  |
| 2080 | 0 | 0 | 0  | 0 | 0 | 0 | 0 | 0 | 0 | 1  | 1  |
| 2081 | 0 | 0 | 0  | 0 | 0 | 0 | 0 | 0 | 0 | 1  | 1  |
| 2082 | 0 | 0 | 0  | 0 | 0 | 0 | 0 | 0 | 0 | 1  | 1  |
| 2083 | 0 | 0 | 0  | 0 | 0 | 0 | 0 | 0 | 0 | 1  | 1  |
| 2084 | 0 | 0 | 0  | 0 | 0 | 0 | 0 | 0 | 0 | 1  | 1  |
| 2085 | 0 | 0 | 0  | 0 | 0 | 0 | 0 | 0 | 0 | 1  | 1  |
| 2086 | 0 | 0 | 0  | 0 | 0 | 0 | 0 | 0 | 0 | 1  | 1  |
| 2087 | 0 | 0 | 0  | 0 | 0 | 0 | 0 | 0 | 0 | 1  | 1  |
| 2088 | 0 | 0 | 0  | 0 | 0 | 0 | 0 | 0 | 0 | 1  | 1  |
| 2089 | 0 | 0 | 0  | 0 | 0 | 0 | 0 | 0 | 0 | 1  | 1  |
| 2090 | 0 | 0 | 0  | 0 | 0 | 0 | 0 | 0 | 0 | 1  | 1  |



|      | 12  | 13  | 14  | 15  | 16  | 17  | 18  | 19  | 20  | 21  | 22  |
|------|-----|-----|-----|-----|-----|-----|-----|-----|-----|-----|-----|
| 2002 | 0   | 0   | 0   | 0   | 0   | 0   | 0   | 0   | 0   | 0   | 0   |
| 2003 | 0   | 0   | 0   | 0   | 0   | 0   | 0   | 0   | 0   | 0   | 0   |
| 2004 | 0   | 0   | 0   | 0   | 0   | 0   | 0   | 0   | 0   | 0   | 0   |
| 2005 | 0   | 0   | 0   | 0   | 0   | 0   | 0   | 0   | 0   | 0   | 0   |
| 2006 | 0   | 0   | 0   | 0   | 0   | 0   | 0   | 0   | 0   | 0   | 0   |
| 2007 | 0   | 0   | 0   | 0   | 0   | 0   | 0   | 0   | 0   | 0   | 0   |
| 2008 | 0   | 0   | 0   | 0   | 0   | 0   | 0   | 0   | 0   | 0   | 0   |
| 2009 | 0   | 0   | 0   | 0   | 0   | 0   | 0   | 0   | 0   | 0   | 0   |
| 2010 | 0   | 0   | 0   | 0   | 0   | 0   | 0   | 0   | 0   | 0   | 0   |
| 2011 | 0   | 0   | 0   | 0   | 0   | 0   | 0   | 0   | 0   | 0   | 0   |
| 2012 | 0   | 0   | 0   | 0   | 0   | 0   | 0   | 0   | 0   | 0   | 0   |
| 2013 | 0   | 0   | 0   | 0   | 0   | 0   | 0   | 0   | 0   | 0   | 0   |
| 2014 | 0   | 0   | 0   | 0   | 0   | 0   | 0   | 0   | 0   | 0   | 0   |
| 2015 | 0   | 0   | 0   | 0   | 0   | 0   | 0   | 0   | 0   | 0   | 0   |
| 2016 | 0   | 0   | 0   | 0   | 0   | 0   | 0   | 0   | 0   | 0   | 0   |
| 2017 | 0   | 0   | 0   | 0   | 0   | 0   | 0   | 0   | 0   | 0   | 0   |
| 2018 | 0   | 0   | 0   | 0   | 0   | 0   | 0   | 0   | 0   | 0   | 0   |
| 2019 | 0   | 0   | 0   | 0   | 0   | 0   | 0   | 0   | 0   | 0   | 0   |
| 2020 | 0   | 250 | 0   | 0   | 0   | 0   | 0   | 0   | 0   | 0   | 250 |
| 2021 | 0   | 250 | 0   | 0   | 0   | 0   | 0   | 0   | 0   | 0   | 250 |
| 2022 | 0   | 250 | 0   | 0   | 0   | 0   | 0   | 0   | 0   | 0   | 250 |
| 2023 | 0   | 250 | 0   | 0   | 0   | 0   | 0   | 0   | 0   | 0   | 250 |
| 2024 | 0   | 250 | 0   | 0   | 0   | 0   | 0   | 0   | 0   | 0   | 250 |
| 2025 | 0   | 250 | 250 | 250 | 250 | 250 | 250 | 250 | 250 | 0   | 250 |
| 2026 | 0   | 250 | 250 | 250 | 250 | 250 | 250 | 250 | 250 | 0   | 250 |
| 2027 | 0   | 250 | 250 | 250 | 250 | 250 | 250 | 250 | 250 | 0   | 250 |
| 2028 | 0   | 250 | 250 | 250 | 250 | 250 | 250 | 250 | 250 | 0   | 250 |
| 2029 | 0   | 250 | 250 | 250 | 250 | 250 | 250 | 250 | 250 | 0   | 250 |
| 2030 | 250 | 250 | 250 | 250 | 250 | 250 | 250 | 250 | 250 | 250 | 250 |
| 2031 | 250 | 250 | 250 | 250 | 250 | 250 | 250 | 250 | 250 | 250 | 250 |
| 2032 | 250 | 250 | 250 | 250 | 250 | 250 | 250 | 250 | 250 | 250 | 250 |
| 2033 | 250 | 250 | 250 | 250 | 250 | 250 | 250 | 250 | 250 | 250 | 250 |
| 2034 | 250 | 250 | 250 | 250 | 250 | 250 | 250 | 250 | 250 | 250 | 250 |
| 2035 | 250 | 250 | 250 | 250 | 250 | 250 | 250 | 250 | 250 | 250 | 250 |
| 2036 | 250 | 250 | 250 | 250 | 250 | 250 | 250 | 250 | 250 | 250 | 250 |
| 2037 | 250 | 250 | 250 | 250 | 250 | 250 | 250 | 250 | 250 | 250 | 250 |
| 2038 | 250 | 250 | 250 | 250 | 250 | 250 | 250 | 250 | 250 | 250 | 250 |
| 2039 | 250 | 250 | 250 | 250 | 250 | 250 | 250 | 250 | 250 | 250 | 250 |
| 2040 | 250 | 250 | 250 | 250 | 250 | 250 | 250 | 250 | 250 | 250 | 250 |
| 2041 | 250 | 250 | 250 | 250 | 250 | 250 | 250 | 250 | 250 | 250 | 250 |
| 2042 | 250 | 250 | 250 | 250 | 250 | 250 | 250 | 250 | 250 | 250 | 250 |
| 2043 | 250 | 250 | 250 | 250 | 250 | 250 | 250 | 250 | 250 | 250 | 250 |
| 2044 | 250 | 250 | 250 | 250 | 250 | 250 | 250 | 250 | 250 | 250 | 250 |
| 2045 | 250 | 250 | 250 | 250 | 250 | 250 | 250 | 250 | 250 | 250 | 250 |
| 2046 | 250 | 250 | 250 | 250 | 250 | 250 | 250 | 250 | 250 | 250 | 250 |
| 2047 | 250 | 250 | 250 | 250 | 250 | 250 | 250 | 250 | 250 | 250 | 179 |
| 2048 | 250 | 250 | 250 | 250 | 250 | 250 | 250 | 250 | 250 | 250 | 81  |
| 2049 | 250 | 245 | 250 | 250 | 250 | 250 | 250 | 250 | 250 | 250 | 40  |
| 2050 | 250 | 178 | 250 | 250 | 250 | 250 | 250 | 250 | 250 | 250 | 20  |
| 2051 | 250 | 85  | 250 | 250 | 250 | 250 | 250 | 250 | 250 | 250 | 7   |
| 2052 | 250 | 42  | 250 | 250 | 250 | 250 | 250 | 219 | 250 | 250 | 7   |
| 2053 | 250 | 22  | 250 | 205 | 250 | 250 | 250 | 130 | 186 | 250 | 0   |
| 2054 | 250 | 6   | 185 | 113 | 181 | 181 | 181 | 65  | 98  | 250 | 0   |
| 2055 | 250 | 0   | 86  | 51  | 106 | 106 | 106 | 38  | 63  | 250 | 0   |
| 2056 | 247 | 0   | 49  | 34  | 56  | 56  | 56  | 17  | 38  | 250 | 0   |
| 2057 | 192 | 0   | 35  | 0   | 34  | 34  | 34  | 2   | 4   | 239 | 0   |
| 2058 | 139 | 0   | 16  | 0   | 9   | 9   | 9   | 2   | 3   | 197 | 0   |
| 2059 | 81  | 0   | 0   | 0   | 0   | 0   | 0   | 1   | 2   | 99  | 0   |

|      | 12 | 13 | 14 | 15 | 16 | 17 | 18 | 19 | 20 | 21 | 22 |
|------|----|----|----|----|----|----|----|----|----|----|----|
| 2060 | 46 | 0  | 0  | 0  | 0  | 0  | 0  | 1  | 2  | 59 | 0  |
| 2061 | 42 | 0  | 0  | 0  | 0  | 0  | 0  | 1  | 1  | 45 | 0  |
| 2062 | 42 | 0  | 0  | 0  | 0  | 0  | 0  | 1  | 1  | 39 | 0  |
| 2063 | 25 | 0  | 0  | 0  | 0  | 0  | 0  | 1  | 1  | 24 | 0  |
| 2064 | 0  | 0  | 0  | 0  | 0  | 0  | 0  | 1  | 1  | 0  | 0  |
| 2065 | 0  | 0  | 0  | 0  | 0  | 0  | 0  | 1  | 1  | 0  | 0  |
| 2066 | 0  | 0  | 0  | 0  | 0  | 0  | 0  | 1  | 1  | 0  | 0  |
| 2067 | 0  | 0  | 0  | 0  | 0  | 0  | 0  | 1  | 1  | 0  | 0  |
| 2068 | 0  | 0  | 0  | 0  | 0  | 0  | 0  | 1  | 1  | 0  | 0  |
| 2069 | 0  | 0  | 0  | 0  | 0  | 0  | 0  | 1  | 1  | 0  | 0  |
| 2070 | 0  | 0  | 0  | 0  | 0  | 0  | 0  | 1  | 1  | 0  | 0  |
| 2071 | 0  | 0  | 0  | 0  | 0  | 0  | 0  | 1  | 1  | 0  | 0  |
| 2072 | 0  | 0  | 0  | 0  | 0  | 0  | 0  | 1  | 1  | 0  | 0  |
| 2073 | 0  | 0  | 0  | 0  | 0  | 0  | 0  | 1  | 1  | 0  | 0  |
| 2074 | 0  | 0  | 0  | 0  | 0  | 0  | 0  | 1  | 1  | 0  | 0  |
| 2075 | 0  | 0  | 0  | 0  | 0  | 0  | 0  | 1  | 1  | 0  | 0  |
| 2076 | 0  | 0  | 0  | 0  | 0  | 0  | 0  | 1  | 1  | 0  | 0  |
| 2077 | 0  | 0  | 0  | 0  | 0  | 0  | 0  | 1  | 1  | 0  | 0  |
| 2078 | 0  | 0  | 0  | 0  | 0  | 0  | 0  | 1  | 1  | 0  | 0  |
| 2079 | 0  | 0  | 0  | 0  | 0  | 0  | 0  | 1  | 1  | 0  | 0  |
| 2080 | 0  | 0  | 0  | 0  | 0  | 0  | 0  | 1  | 1  | 0  | 0  |
| 2081 | 0  | 0  | 0  | 0  | 0  | 0  | 0  | 1  | 1  | 0  | 0  |
| 2082 | 0  | 0  | 0  | 0  | 0  | 0  | 0  | 1  | 1  | 0  | 0  |
| 2083 | 0  | 0  | 0  | 0  | 0  | 0  | 0  | 1  | 1  | 0  | 0  |
| 2084 | 0  | 0  | 0  | 0  | 0  | 0  | 0  | 1  | 1  | 0  | 0  |
| 2085 | 0  | 0  | 0  | 0  | 0  | 0  | 0  | 1  | 1  | 0  | 0  |
| 2086 | 0  | 0  | 0  | 0  | 0  | 0  | 0  | 1  | 1  | 0  | 0  |
| 2087 | 0  | 0  | 0  | 0  | 0  | 0  | 0  | 1  | 1  | 0  | 0  |
| 2088 | 0  | 0  | 0  | 0  | 0  | 0  | 0  | 1  | 1  | 0  | 0  |
| 2089 | 0  | 0  | 0  | 0  | 0  | 0  | 0  | 1  | 1  | 0  | 0  |
| 2090 | 0  | 0  | 0  | 0  | 0  | 0  | 0  | 1  | 1  | 0  | 0  |

|      | 23  | 24  | 25  | 26  | 27  | 28  | 29  | 30  | 31  | 32  | 33  |
|------|-----|-----|-----|-----|-----|-----|-----|-----|-----|-----|-----|
| 2002 | 0   | 0   | 0   | 0   | 0   | 0   | 0   | 0   | 0   | 0   | 0   |
| 2003 | 0   | 0   | 0   | 0   | 0   | 0   | 0   | 0   | 0   | 0   | 0   |
| 2004 | 0   | 0   | 0   | 0   | 0   | 0   | 0   | 0   | 0   | 0   | 0   |
| 2005 | 0   | 0   | 0   | 0   | 0   | 0   | 0   | 0   | 0   | 0   | 0   |
| 2006 | 0   | 0   | 0   | 0   | 0   | 0   | 0   | 0   | 0   | 0   | 0   |
| 2007 | 0   | 0   | 0   | 0   | 0   | 0   | 0   | 0   | 0   | 0   | 0   |
| 2008 | 0   | 0   | 0   | 0   | 0   | 0   | 0   | 0   | 0   | 0   | 0   |
| 2009 | 0   | 0   | 0   | 0   | 0   | 0   | 0   | 0   | 0   | 0   | 0   |
| 2010 | 0   | 0   | 0   | 0   | 0   | 0   | 0   | 0   | 0   | 0   | 0   |
| 2011 | 0   | 0   | 0   | 0   | 0   | 0   | 0   | 0   | 0   | 0   | 0   |
| 2012 | 0   | 0   | 0   | 0   | 0   | 0   | 0   | 0   | 0   | 0   | 0   |
| 2013 | 0   | 0   | 0   | 0   | 0   | 0   | 0   | 0   | 0   | 0   | 0   |
| 2014 | 0   | 0   | 0   | 0   | 0   | 0   | 0   | 0   | 0   | 0   | 0   |
| 2015 | 0   | 0   | 0   | 0   | 0   | 0   | 0   | 0   | 0   | 0   | 0   |
| 2016 | 0   | 0   | 0   | 0   | 0   | 0   | 0   | 0   | 0   | 0   | 0   |
| 2017 | 0   | 0   | 0   | 0   | 0   | 0   | 0   | 0   | 0   | 0   | 0   |
| 2018 | 0   | 0   | 0   | 0   | 0   | 0   | 0   | 0   | 0   | 0   | 0   |
| 2019 | 0   | 0   | 0   | 0   | 0   | 0   | 0   | 0   | 0   | 0   | 0   |
| 2020 | 0   | 0   | 0   | 0   | 0   | 0   | 0   | 0   | 250 | 0   | 0   |
| 2021 | 0   | 0   | 0   | 0   | 0   | 0   | 0   | 0   | 250 | 0   | 0   |
| 2022 | 0   | 0   | 0   | 0   | 0   | 0   | 0   | 0   | 250 | 0   | 0   |
| 2023 | 0   | 0   | 0   | 0   | 0   | 0   | 0   | 0   | 250 | 0   | 0   |
| 2024 | 0   | 0   | 0   | 0   | 0   | 0   | 0   | 0   | 250 | 0   | 0   |
| 2025 | 250 | 250 | 250 | 250 | 250 | 250 | 250 | 0   | 250 | 250 | 250 |
| 2026 | 250 | 250 | 250 | 250 | 250 | 250 | 250 | 0   | 250 | 250 | 250 |
| 2027 | 250 | 250 | 250 | 250 | 250 | 250 | 250 | 0   | 250 | 250 | 250 |
| 2028 | 250 | 250 | 250 | 250 | 250 | 250 | 250 | 0   | 250 | 250 | 250 |
| 2029 | 250 | 250 | 250 | 250 | 250 | 250 | 250 | 0   | 250 | 250 | 250 |
| 2030 | 250 | 250 | 250 | 250 | 250 | 250 | 250 | 250 | 250 | 250 | 250 |
| 2031 | 250 | 250 | 250 | 250 | 250 | 250 | 250 | 250 | 250 | 250 | 250 |
| 2032 | 250 | 250 | 250 | 250 | 250 | 250 | 250 | 250 | 250 | 250 | 250 |
| 2033 | 250 | 250 | 250 | 250 | 250 | 250 | 250 | 250 | 250 | 250 | 250 |
| 2034 | 250 | 250 | 250 | 250 | 250 | 250 | 250 | 250 | 250 | 250 | 250 |
| 2035 | 250 | 250 | 250 | 250 | 250 | 250 | 250 | 250 | 250 | 250 | 250 |
| 2036 | 250 | 250 | 250 | 250 | 250 | 250 | 250 | 250 | 250 | 250 | 250 |
| 2037 | 250 | 250 | 250 | 250 | 250 | 250 | 250 | 250 | 250 | 250 | 250 |
| 2038 | 250 | 250 | 250 | 250 | 250 | 250 | 250 | 250 | 250 | 250 | 250 |
| 2039 | 250 | 250 | 250 | 250 | 250 | 250 | 250 | 250 | 250 | 250 | 250 |
| 2040 | 250 | 250 | 250 | 250 | 250 | 250 | 250 | 250 | 250 | 250 | 250 |
| 2041 | 250 | 250 | 250 | 250 | 250 | 250 | 250 | 250 | 250 | 250 | 250 |
| 2042 | 250 | 250 | 250 | 250 | 250 | 250 | 250 | 250 | 250 | 250 | 250 |
| 2043 | 250 | 250 | 250 | 250 | 250 | 250 | 250 | 250 | 250 | 250 | 250 |
| 2044 | 250 | 250 | 250 | 250 | 250 | 250 | 250 | 250 | 250 | 250 | 250 |
| 2045 | 250 | 250 | 250 | 250 | 250 | 250 | 250 | 250 | 250 | 250 | 250 |
| 2046 | 250 | 250 | 250 | 250 | 250 | 250 | 250 | 250 | 200 | 250 | 250 |
| 2047 | 250 | 250 | 250 | 250 | 250 | 250 | 250 | 250 | 105 | 250 | 250 |
| 2048 | 250 | 250 | 250 | 250 | 250 | 250 | 250 | 250 | 45  | 250 | 250 |
| 2049 | 250 | 250 | 250 | 250 | 250 | 250 | 250 | 250 | 25  | 250 | 250 |
| 2050 | 250 | 250 | 250 | 250 | 250 | 235 | 250 | 250 | 14  | 250 | 205 |
| 2051 | 250 | 227 | 250 | 250 | 250 | 194 | 213 | 250 | 10  | 220 | 153 |
| 2052 | 250 | 137 | 233 | 233 | 233 | 149 | 173 | 250 | 4   | 181 | 123 |
| 2053 | 212 | 69  | 140 | 140 | 140 | 115 | 128 | 250 | 0   | 117 | 87  |
| 2054 | 142 | 44  | 65  | 65  | 65  | 74  | 85  | 250 | 0   | 81  | 50  |
| 2055 | 72  | 25  | 42  | 42  | 42  | 24  | 59  | 250 | 0   | 39  | 24  |
| 2056 | 42  | 10  | 25  | 25  | 25  | 17  | 31  | 221 | 0   | 21  | 18  |
| 2057 | 25  | 0   | 0   | 0   | 0   | 7   | 20  | 188 | 0   | 16  | 0   |
| 2058 | 0   | 0   | 0   | 0   | 0   | 6   | 9   | 144 | 0   | 5   | 0   |
| 2059 | 0   | 0   | 0   | 0   | 0   | 0   | 0   | 117 | 0   | 0   | 0   |

|      | 23 | 24 | 25 | 26 | 27 | 28 | 29 | 30 | 31 | 32 | 33 |
|------|----|----|----|----|----|----|----|----|----|----|----|
| 2060 | 0  | 0  | 0  | 0  | 0  | 0  | 0  | 97 | 0  | 0  | 0  |
| 2061 | 0  | 0  | 0  | 0  | 0  | 0  | 0  | 57 | 0  | 0  | 0  |
| 2062 | 0  | 0  | 0  | 0  | 0  | 0  | 0  | 19 | 0  | 0  | 0  |
| 2063 | 0  | 0  | 0  | 0  | 0  | 0  | 0  | 11 | 0  | 0  | 0  |
| 2064 | 0  | 0  | 0  | 0  | 0  | 0  | 0  | 8  | 0  | 0  | 0  |
| 2065 | 0  | 0  | 0  | 0  | 0  | 0  | 0  | 3  | 0  | 0  | 0  |
| 2066 | 0  | 0  | 0  | 0  | 0  | 0  | 0  | 0  | 0  | 0  | 0  |
| 2067 | 0  | 0  | 0  | 0  | 0  | 0  | 0  | 0  | 0  | 0  | 0  |
| 2068 | 0  | 0  | 0  | 0  | 0  | 0  | 0  | 0  | 0  | 0  | 0  |
| 2069 | 0  | 0  | 0  | 0  | 0  | 0  | 0  | 0  | 0  | 0  | 0  |
| 2070 | 0  | 0  | 0  | 0  | 0  | 0  | 0  | 0  | 0  | 0  | 0  |
| 2071 | 0  | 0  | 0  | 0  | 0  | 0  | 0  | 0  | 0  | 0  | 0  |
| 2072 | 0  | 0  | 0  | 0  | 0  | 0  | 0  | 0  | 0  | 0  | 0  |
| 2073 | 0  | 0  | 0  | 0  | 0  | 0  | 0  | 0  | 0  | 0  | 0  |
| 2074 | 0  | 0  | 0  | 0  | 0  | 0  | 0  | 0  | 0  | 0  | 0  |
| 2075 | 0  | 0  | 0  | 0  | 0  | 0  | 0  | 0  | 0  | 0  | 0  |
| 2076 | 0  | 0  | 0  | 0  | 0  | 0  | 0  | 0  | 0  | 0  | 0  |
| 2077 | 0  | 0  | 0  | 0  | 0  | 0  | 0  | 0  | 0  | 0  | 0  |
| 2078 | 0  | 0  | 0  | 0  | 0  | 0  | 0  | 0  | 0  | 0  | 0  |
| 2079 | 0  | 0  | 0  | 0  | 0  | 0  | 0  | 0  | 0  | 0  | 0  |
| 2080 | 0  | 0  | 0  | 0  | 0  | 0  | 0  | 0  | 0  | 0  | 0  |
| 2081 | 0  | 0  | 0  | 0  | 0  | 0  | 0  | 0  | 0  | 0  | 0  |
| 2082 | 0  | 0  | 0  | 0  | 0  | 0  | 0  | 0  | 0  | 0  | 0  |
| 2083 | 0  | 0  | 0  | 0  | 0  | 0  | 0  | 0  | 0  | 0  | 0  |
| 2084 | 0  | 0  | 0  | 0  | 0  | 0  | 0  | 0  | 0  | 0  | 0  |
| 2085 | 0  | 0  | 0  | 0  | 0  | 0  | 0  | 0  | 0  | 0  | 0  |
| 2086 | 0  | 0  | 0  | 0  | 0  | 0  | 0  | 0  | 0  | 0  | 0  |
| 2087 | 0  | 0  | 0  | 0  | 0  | 0  | 0  | 0  | 0  | 0  | 0  |
| 2088 | 0  | 0  | 0  | 0  | 0  | 0  | 0  | 0  | 0  | 0  | 0  |
| 2089 | 0  | 0  | 0  | 0  | 0  | 0  | 0  | 0  | 0  | 0  | 0  |
| 2090 | 0  | 0  | 0  | 0  | 0  | 0  | 0  | 0  | 0  | 0  | 0  |

|      | 34  | 35  | 36  | 37  | 38  | 39  | 40  | 41  | 42  | 43  | 44  |
|------|-----|-----|-----|-----|-----|-----|-----|-----|-----|-----|-----|
| 2002 | 0   | 0   | 0   | 0   | 0   | 0   | 0   | 0   | 0   | 0   | 0   |
| 2003 | 0   | 0   | 0   | 0   | 0   | 0   | 0   | 0   | 0   | 0   | 0   |
| 2004 | 0   | 0   | 0   | 0   | 0   | 0   | 0   | 0   | 0   | 0   | 0   |
| 2005 | 0   | 0   | 0   | 0   | 0   | 0   | 0   | 0   | 0   | 0   | 0   |
| 2006 | 0   | 0   | 0   | 0   | 0   | 0   | 0   | 0   | 0   | 0   | 0   |
| 2007 | 0   | 0   | 0   | 0   | 0   | 0   | 0   | 0   | 0   | 0   | 0   |
| 2008 | 0   | 0   | 0   | 0   | 0   | 0   | 0   | 0   | 0   | 0   | 0   |
| 2009 | 0   | 0   | 0   | 0   | 0   | 0   | 0   | 0   | 0   | 0   | 0   |
| 2010 | 0   | 0   | 0   | 0   | 0   | 0   | 0   | 0   | 0   | 0   | 0   |
| 2011 | 0   | 0   | 0   | 0   | 0   | 0   | 0   | 0   | 0   | 0   | 0   |
| 2012 | 0   | 0   | 0   | 0   | 0   | 0   | 0   | 0   | 0   | 0   | 0   |
| 2013 | 0   | 0   | 0   | 0   | 0   | 0   | 0   | 0   | 0   | 0   | 0   |
| 2014 | 0   | 0   | 0   | 0   | 0   | 0   | 0   | 0   | 0   | 0   | 0   |
| 2015 | 0   | 0   | 0   | 0   | 0   | 0   | 0   | 0   | 0   | 0   | 0   |
| 2016 | 0   | 0   | 0   | 0   | 0   | 0   | 0   | 0   | 0   | 0   | 0   |
| 2017 | 0   | 0   | 0   | 0   | 0   | 0   | 0   | 0   | 0   | 0   | 0   |
| 2018 | 0   | 0   | 0   | 0   | 0   | 0   | 0   | 0   | 0   | 0   | 0   |
| 2019 | 0   | 0   | 0   | 0   | 0   | 0   | 0   | 0   | 0   | 0   | 0   |
| 2020 | 0   | 0   | 0   | 0   | 0   | 0   | 250 | 0   | 0   | 0   | 0   |
| 2021 | 0   | 0   | 0   | 0   | 0   | 0   | 250 | 0   | 0   | 0   | 0   |
| 2022 | 0   | 0   | 0   | 0   | 0   | 0   | 250 | 0   | 0   | 0   | 0   |
| 2023 | 0   | 0   | 0   | 0   | 0   | 0   | 250 | 0   | 0   | 0   | 0   |
| 2024 | 0   | 0   | 0   | 0   | 0   | 0   | 250 | 0   | 0   | 0   | 0   |
| 2025 | 250 | 250 | 250 | 250 | 250 | 0   | 250 | 250 | 250 | 250 | 250 |
| 2026 | 250 | 250 | 250 | 250 | 250 | 0   | 250 | 250 | 250 | 250 | 250 |
| 2027 | 250 | 250 | 250 | 250 | 250 | 0   | 250 | 250 | 250 | 250 | 250 |
| 2028 | 250 | 250 | 250 | 250 | 250 | 0   | 250 | 250 | 250 | 250 | 250 |
| 2029 | 250 | 250 | 250 | 250 | 250 | 0   | 250 | 250 | 250 | 250 | 250 |
| 2030 | 250 | 250 | 250 | 250 | 250 | 250 | 250 | 250 | 250 | 250 | 250 |
| 2031 | 250 | 250 | 250 | 250 | 250 | 250 | 250 | 250 | 250 | 250 | 250 |
| 2032 | 250 | 250 | 250 | 250 | 250 | 250 | 250 | 250 | 250 | 250 | 250 |
| 2033 | 250 | 250 | 250 | 250 | 250 | 250 | 250 | 250 | 250 | 250 | 250 |
| 2034 | 250 | 250 | 250 | 250 | 250 | 250 | 250 | 250 | 250 | 250 | 250 |
| 2035 | 250 | 250 | 250 | 250 | 250 | 250 | 250 | 250 | 250 | 250 | 250 |
| 2036 | 250 | 250 | 250 | 250 | 250 | 250 | 250 | 250 | 250 | 250 | 250 |
| 2037 | 250 | 250 | 250 | 250 | 250 | 250 | 250 | 250 | 250 | 250 | 250 |
| 2038 | 250 | 250 | 250 | 250 | 250 | 250 | 250 | 250 | 250 | 250 | 250 |
| 2039 | 250 | 250 | 250 | 250 | 250 | 250 | 250 | 250 | 250 | 250 | 250 |
| 2040 | 250 | 250 | 250 | 250 | 250 | 250 | 250 | 250 | 250 | 250 | 250 |
| 2041 | 250 | 250 | 250 | 250 | 250 | 250 | 250 | 250 | 250 | 250 | 250 |
| 2042 | 250 | 250 | 250 | 250 | 250 | 250 | 250 | 250 | 250 | 250 | 250 |
| 2043 | 250 | 250 | 250 | 250 | 250 | 250 | 250 | 250 | 250 | 250 | 250 |
| 2044 | 250 | 250 | 250 | 250 | 250 | 250 | 250 | 250 | 250 | 250 | 250 |
| 2045 | 250 | 250 | 250 | 250 | 250 | 250 | 250 | 250 | 250 | 250 | 250 |
| 2046 | 250 | 250 | 250 | 250 | 250 | 250 | 250 | 250 | 250 | 250 | 250 |
| 2047 | 250 | 250 | 250 | 250 | 250 | 250 | 250 | 250 | 250 | 250 | 250 |
| 2048 | 250 | 250 | 250 | 250 | 250 | 250 | 250 | 250 | 250 | 250 | 250 |
| 2049 | 250 | 250 | 250 | 250 | 250 | 250 | 245 | 250 | 250 | 250 | 250 |
| 2050 | 248 | 248 | 248 | 250 | 250 | 250 | 211 | 250 | 250 | 250 | 250 |
| 2051 | 189 | 189 | 189 | 250 | 250 | 250 | 102 | 250 | 250 | 250 | 250 |
| 2052 | 154 | 154 | 154 | 250 | 250 | 250 | 46  | 250 | 234 | 250 | 250 |
| 2053 | 116 | 116 | 116 | 247 | 250 | 250 | 29  | 233 | 160 | 240 | 240 |
| 2054 | 84  | 84  | 84  | 205 | 219 | 250 | 11  | 170 | 83  | 188 | 188 |
| 2055 | 30  | 30  | 30  | 118 | 129 | 250 | 1   | 92  | 48  | 98  | 98  |
| 2056 | 21  | 21  | 21  | 70  | 79  | 250 | 1   | 54  | 20  | 58  | 58  |
| 2057 | 0   | 0   | 0   | 36  | 46  | 209 | 1   | 26  | 9   | 20  | 20  |
| 2058 | 0   | 0   | 0   | 14  | 10  | 139 | 1   | 8   | 0   | 0   | 0   |
| 2059 | 0   | 0   | 0   | 5   | 0   | 82  | 1   | 8   | 0   | 0   | 0   |

|      | 34 | 35 | 36 | 37 | 38 | 39 | 40 | 41 | 42 | 43 | 44 |
|------|----|----|----|----|----|----|----|----|----|----|----|
| 2060 | 0  | 0  | 0  | 5  | 0  | 54 | 1  | 0  | 0  | 0  | 0  |
| 2061 | 0  | 0  | 0  | 1  | 0  | 42 | 1  | 0  | 0  | 0  | 0  |
| 2062 | 0  | 0  | 0  | 1  | 0  | 42 | 1  | 0  | 0  | 0  | 0  |
| 2063 | 0  | 0  | 0  | 1  | 0  | 27 | 1  | 0  | 0  | 0  | 0  |
| 2064 | 0  | 0  | 0  | 1  | 0  | 0  | 1  | 0  | 0  | 0  | 0  |
| 2065 | 0  | 0  | 0  | 1  | 0  | 0  | 1  | 0  | 0  | 0  | 0  |
| 2066 | 0  | 0  | 0  | 1  | 0  | 0  | 1  | 0  | 0  | 0  | 0  |
| 2067 | 0  | 0  | 0  | 1  | 0  | 0  | 1  | 0  | 0  | 0  | 0  |
| 2068 | 0  | 0  | 0  | 1  | 0  | 0  | 1  | 0  | 0  | 0  | 0  |
| 2069 | 0  | 0  | 0  | 1  | 0  | 0  | 1  | 0  | 0  | 0  | 0  |
| 2070 | 0  | 0  | 0  | 1  | 0  | 0  | 1  | 0  | 0  | 0  | 0  |
| 2071 | 0  | 0  | 0  | 1  | 0  | 0  | 1  | 0  | 0  | 0  | 0  |
| 2072 | 0  | 0  | 0  | 1  | 0  | 0  | 1  | 0  | 0  | 0  | 0  |
| 2073 | 0  | 0  | 0  | 1  | 0  | 0  | 1  | 0  | 0  | 0  | 0  |
| 2074 | 0  | 0  | 0  | 1  | 0  | 0  | 1  | 0  | 0  | 0  | 0  |
| 2075 | 0  | 0  | 0  | 1  | 0  | 0  | 1  | 0  | 0  | 0  | 0  |
| 2076 | 0  | 0  | 0  | 1  | 0  | 0  | 1  | 0  | 0  | 0  | 0  |
| 2077 | 0  | 0  | 0  | 1  | 0  | 0  | 1  | 0  | 0  | 0  | 0  |
| 2078 | 0  | 0  | 0  | 1  | 0  | 0  | 1  | 0  | 0  | 0  | 0  |
| 2079 | 0  | 0  | 0  | 1  | 0  | 0  | 1  | 0  | 0  | 0  | 0  |
| 2080 | 0  | 0  | 0  | 1  | 0  | 0  | 1  | 0  | 0  | 0  | 0  |
| 2081 | 0  | 0  | 0  | 1  | 0  | 0  | 1  | 0  | 0  | 0  | 0  |
| 2082 | 0  | 0  | 0  | 1  | 0  | 0  | 1  | 0  | 0  | 0  | 0  |
| 2083 | 0  | 0  | 0  | 1  | 0  | 0  | 1  | 0  | 0  | 0  | 0  |
| 2084 | 0  | 0  | 0  | 1  | 0  | 0  | 1  | 0  | 0  | 0  | 0  |
| 2085 | 0  | 0  | 0  | 1  | 0  | 0  | 1  | 0  | 0  | 0  | 0  |
| 2086 | 0  | 0  | 0  | 1  | 0  | 0  | 1  | 0  | 0  | 0  | 0  |
| 2087 | 0  | 0  | 0  | 1  | 0  | 0  | 1  | 0  | 0  | 0  | 0  |
| 2088 | 0  | 0  | 0  | 1  | 0  | 0  | 1  | 0  | 0  | 0  | 0  |
| 2089 | 0  | 0  | 0  | 1  | 0  | 0  | 1  | 0  | 0  | 0  | 0  |
| 2090 | 0  | 0  | 0  | 1  | 0  | 0  | 1  | 0  | 0  | 0  | 0  |

|      | 45  | 46  | 47  | 48  | 49  | 50  | 51  | 52  | 53  | 54  | 55  |
|------|-----|-----|-----|-----|-----|-----|-----|-----|-----|-----|-----|
| 2002 | 0   | 0   | 0   | 0   | 0   | 0   | 0   | 0   | 0   | 0   | 0   |
| 2003 | 0   | 0   | 0   | 0   | 0   | 0   | 0   | 0   | 0   | 0   | 0   |
| 2004 | 0   | 0   | 0   | 0   | 0   | 0   | 0   | 0   | 0   | 0   | 0   |
| 2005 | 0   | 0   | 0   | 0   | 0   | 0   | 0   | 0   | 0   | 0   | 0   |
| 2006 | 0   | 0   | 0   | 0   | 0   | 0   | 0   | 0   | 0   | 0   | 0   |
| 2007 | 0   | 0   | 0   | 0   | 0   | 0   | 0   | 0   | 0   | 0   | 0   |
| 2008 | 0   | 0   | 0   | 0   | 0   | 0   | 0   | 0   | 0   | 0   | 0   |
| 2009 | 0   | 0   | 0   | 0   | 0   | 0   | 0   | 0   | 0   | 0   | 0   |
| 2010 | 0   | 0   | 0   | 0   | 0   | 0   | 0   | 0   | 0   | 0   | 0   |
| 2011 | 0   | 0   | 0   | 0   | 0   | 0   | 0   | 0   | 0   | 0   | 0   |
| 2012 | 0   | 0   | 0   | 0   | 0   | 0   | 0   | 0   | 0   | 0   | 0   |
| 2013 | 0   | 0   | 0   | 0   | 0   | 0   | 0   | 0   | 0   | 0   | 0   |
| 2014 | 0   | 0   | 0   | 0   | 0   | 0   | 0   | 0   | 0   | 0   | 0   |
| 2015 | 0   | 0   | 0   | 0   | 0   | 0   | 0   | 0   | 0   | 0   | 0   |
| 2016 | 0   | 0   | 0   | 0   | 0   | 0   | 0   | 0   | 0   | 0   | 0   |
| 2017 | 0   | 0   | 0   | 0   | 0   | 0   | 0   | 0   | 0   | 0   | 0   |
| 2018 | 0   | 0   | 0   | 0   | 0   | 0   | 0   | 0   | 0   | 0   | 0   |
| 2019 | 0   | 0   | 0   | 0   | 0   | 0   | 0   | 0   | 0   | 0   | 0   |
| 2020 | 0   | 0   | 0   | 0   | 250 | 0   | 0   | 0   | 0   | 0   | 0   |
| 2021 | 0   | 0   | 0   | 0   | 250 | 0   | 0   | 0   | 0   | 0   | 0   |
| 2022 | 0   | 0   | 0   | 0   | 250 | 0   | 0   | 0   | 0   | 0   | 0   |
| 2023 | 0   | 0   | 0   | 0   | 250 | 0   | 0   | 0   | 0   | 0   | 0   |
| 2024 | 0   | 0   | 0   | 0   | 250 | 0   | 0   | 0   | 0   | 0   | 0   |
| 2025 | 250 | 250 | 250 | 0   | 250 | 250 | 250 | 250 | 250 | 250 | 250 |
| 2026 | 250 | 250 | 250 | 0   | 250 | 250 | 250 | 250 | 250 | 250 | 250 |
| 2027 | 250 | 250 | 250 | 0   | 250 | 250 | 250 | 250 | 250 | 250 | 250 |
| 2028 | 250 | 250 | 250 | 0   | 250 | 250 | 250 | 250 | 250 | 250 | 250 |
| 2029 | 250 | 250 | 250 | 0   | 250 | 250 | 250 | 250 | 250 | 250 | 250 |
| 2030 | 250 | 250 | 250 | 250 | 250 | 250 | 250 | 250 | 250 | 250 | 250 |
| 2031 | 250 | 250 | 250 | 250 | 250 | 250 | 250 | 250 | 250 | 250 | 250 |
| 2032 | 250 | 250 | 250 | 250 | 250 | 250 | 250 | 250 | 250 | 250 | 250 |
| 2033 | 250 | 250 | 250 | 250 | 250 | 250 | 250 | 250 | 250 | 250 | 250 |
| 2034 | 250 | 250 | 250 | 250 | 250 | 250 | 250 | 250 | 250 | 250 | 250 |
| 2035 | 250 | 250 | 250 | 250 | 250 | 250 | 250 | 250 | 250 | 250 | 250 |
| 2036 | 250 | 250 | 250 | 250 | 250 | 250 | 250 | 250 | 250 | 250 | 250 |
| 2037 | 250 | 250 | 250 | 250 | 250 | 250 | 250 | 250 | 250 | 250 | 250 |
| 2038 | 250 | 250 | 250 | 250 | 250 | 250 | 250 | 250 | 250 | 250 | 250 |
| 2039 | 250 | 250 | 250 | 250 | 250 | 250 | 250 | 250 | 250 | 250 | 250 |
| 2040 | 250 | 250 | 250 | 250 | 250 | 250 | 250 | 250 | 250 | 250 | 250 |
| 2041 | 250 | 250 | 250 | 250 | 250 | 250 | 250 | 250 | 250 | 250 | 250 |
| 2042 | 250 | 250 | 250 | 250 | 250 | 250 | 250 | 250 | 250 | 250 | 250 |
| 2043 | 250 | 250 | 250 | 250 | 250 | 250 | 250 | 250 | 250 | 250 | 250 |
| 2044 | 250 | 250 | 250 | 250 | 250 | 250 | 250 | 250 | 250 | 250 | 250 |
| 2045 | 250 | 250 | 250 | 250 | 250 | 250 | 250 | 250 | 250 | 250 | 250 |
| 2046 | 250 | 250 | 250 | 250 | 250 | 250 | 250 | 250 | 250 | 250 | 250 |
| 2047 | 250 | 250 | 250 | 250 | 213 | 250 | 250 | 250 | 250 | 250 | 209 |
| 2048 | 250 | 250 | 250 | 250 | 130 | 250 | 250 | 250 | 250 | 250 | 169 |
| 2049 | 250 | 250 | 250 | 250 | 59  | 250 | 250 | 250 | 250 | 250 | 113 |
| 2050 | 250 | 250 | 250 | 250 | 29  | 250 | 250 | 250 | 250 | 250 | 77  |
| 2051 | 250 | 250 | 250 | 250 | 11  | 250 | 230 | 250 | 250 | 250 | 29  |
| 2052 | 250 | 245 | 250 | 250 | 11  | 250 | 183 | 248 | 248 | 248 | 8   |
| 2053 | 240 | 163 | 190 | 250 | 0   | 229 | 96  | 167 | 167 | 167 | 0   |
| 2054 | 188 | 94  | 103 | 250 | 0   | 137 | 64  | 100 | 100 | 100 | 0   |
| 2055 | 98  | 54  | 62  | 250 | 0   | 87  | 30  | 54  | 54  | 54  | 0   |
| 2056 | 58  | 23  | 41  | 250 | 0   | 59  | 16  | 25  | 25  | 25  | 0   |
| 2057 | 20  | 0   | 10  | 249 | 0   | 30  | 3   | 10  | 10  | 10  | 0   |
| 2058 | 0   | 0   | 0   | 197 | 0   | 0   | 3   | 10  | 10  | 10  | 0   |
| 2059 | 0   | 0   | 0   | 112 | 0   | 0   | 0   | 1   | 1   | 1   | 0   |

|      | 45 | 46 | 47 | 48 | 49 | 50 | 51 | 52 | 53 | 54 | 55 |
|------|----|----|----|----|----|----|----|----|----|----|----|
| 2060 | 0  | 0  | 0  | 67 | 0  | 0  | 0  | 1  | 1  | 1  | 0  |
| 2061 | 0  | 0  | 0  | 49 | 0  | 0  | 0  | 1  | 1  | 1  | 0  |
| 2062 | 0  | 0  | 0  | 42 | 0  | 0  | 0  | 1  | 1  | 1  | 0  |
| 2063 | 0  | 0  | 0  | 34 | 0  | 0  | 0  | 1  | 1  | 1  | 0  |
| 2064 | 0  | 0  | 0  | 10 | 0  | 0  | 0  | 1  | 1  | 1  | 0  |
| 2065 | 0  | 0  | 0  | 5  | 0  | 0  | 0  | 1  | 1  | 1  | 0  |
| 2066 | 0  | 0  | 0  | 5  | 0  | 0  | 0  | 1  | 1  | 1  | 0  |
| 2067 | 0  | 0  | 0  | 1  | 0  | 0  | 0  | 1  | 1  | 1  | 0  |
| 2068 | 0  | 0  | 0  | 1  | 0  | 0  | 0  | 1  | 1  | 1  | 0  |
| 2069 | 0  | 0  | 0  | 1  | 0  | 0  | 0  | 1  | 1  | 1  | 0  |
| 2070 | 0  | 0  | 0  | 1  | 0  | 0  | 0  | 1  | 1  | 1  | 0  |
| 2071 | 0  | 0  | 0  | 1  | 0  | 0  | 0  | 1  | 1  | 1  | 0  |
| 2072 | 0  | 0  | 0  | 1  | 0  | 0  | 0  | 1  | 1  | 1  | 0  |
| 2073 | 0  | 0  | 0  | 1  | 0  | 0  | 0  | 1  | 1  | 1  | 0  |
| 2074 | 0  | 0  | 0  | 1  | 0  | 0  | 0  | 1  | 1  | 1  | 0  |
| 2075 | 0  | 0  | 0  | 1  | 0  | 0  | 0  | 1  | 1  | 1  | 0  |
| 2076 | 0  | 0  | 0  | 1  | 0  | 0  | 0  | 1  | 1  | 1  | 0  |
| 2077 | 0  | 0  | 0  | 1  | 0  | 0  | 0  | 1  | 1  | 1  | 0  |
| 2078 | 0  | 0  | 0  | 1  | 0  | 0  | 0  | 1  | 1  | 1  | 0  |
| 2079 | 0  | 0  | 0  | 1  | 0  | 0  | 0  | 1  | 1  | 1  | 0  |
| 2080 | 0  | 0  | 0  | 1  | 0  | 0  | 0  | 1  | 1  | 1  | 0  |
| 2081 | 0  | 0  | 0  | 1  | 0  | 0  | 0  | 1  | 1  | 1  | 0  |
| 2082 | 0  | 0  | 0  | 1  | 0  | 0  | 0  | 1  | 1  | 1  | 0  |
| 2083 | 0  | 0  | 0  | 1  | 0  | 0  | 0  | 1  | 1  | 1  | 0  |
| 2084 | 0  | 0  | 0  | 1  | 0  | 0  | 0  | 1  | 1  | 1  | 0  |
| 2085 | 0  | 0  | 0  | 1  | 0  | 0  | 0  | 1  | 1  | 1  | 0  |
| 2086 | 0  | 0  | 0  | 1  | 0  | 0  | 0  | 1  | 1  | 1  | 0  |
| 2087 | 0  | 0  | 0  | 1  | 0  | 0  | 0  | 1  | 1  | 1  | 0  |
| 2088 | 0  | 0  | 0  | 1  | 0  | 0  | 0  | 1  | 1  | 1  | 0  |
| 2089 | 0  | 0  | 0  | 1  | 0  | 0  | 0  | 1  | 1  | 1  | 0  |
| 2090 | 0  | 0  | 0  | 1  | 0  | 0  | 0  | 1  | 1  | 1  | 0  |



|      | 56  | 57  | 58  | 59  | 60  | 61  | 62  | 63  | 64  | 65  | 66  |
|------|-----|-----|-----|-----|-----|-----|-----|-----|-----|-----|-----|
| 2002 | 0   | 0   | 0   | 0   | 0   | 0   | 0   | 0   | 0   | 0   | 0   |
| 2003 | 0   | 0   | 0   | 0   | 0   | 0   | 0   | 0   | 0   | 0   | 0   |
| 2004 | 0   | 0   | 0   | 0   | 0   | 0   | 0   | 0   | 0   | 0   | 0   |
| 2005 | 0   | 0   | 0   | 0   | 0   | 0   | 0   | 0   | 0   | 0   | 0   |
| 2006 | 0   | 0   | 0   | 0   | 0   | 0   | 0   | 0   | 0   | 0   | 0   |
| 2007 | 0   | 0   | 0   | 0   | 0   | 0   | 0   | 0   | 0   | 0   | 0   |
| 2008 | 0   | 0   | 0   | 0   | 0   | 0   | 0   | 0   | 0   | 0   | 0   |
| 2009 | 0   | 0   | 0   | 0   | 0   | 0   | 0   | 0   | 0   | 0   | 0   |
| 2010 | 0   | 0   | 0   | 0   | 0   | 0   | 0   | 0   | 0   | 0   | 0   |
| 2011 | 0   | 0   | 0   | 0   | 0   | 0   | 0   | 0   | 0   | 0   | 0   |
| 2012 | 0   | 0   | 0   | 0   | 0   | 0   | 0   | 0   | 0   | 0   | 0   |
| 2013 | 0   | 0   | 0   | 0   | 0   | 0   | 0   | 0   | 0   | 0   | 0   |
| 2014 | 0   | 0   | 0   | 0   | 0   | 0   | 0   | 0   | 0   | 0   | 0   |
| 2015 | 0   | 0   | 0   | 0   | 0   | 0   | 0   | 0   | 0   | 0   | 0   |
| 2016 | 0   | 0   | 0   | 0   | 0   | 0   | 0   | 0   | 0   | 0   | 0   |
| 2017 | 0   | 0   | 0   | 0   | 0   | 0   | 0   | 0   | 0   | 0   | 0   |
| 2018 | 0   | 0   | 0   | 0   | 0   | 0   | 0   | 0   | 0   | 0   | 0   |
| 2019 | 0   | 0   | 0   | 0   | 0   | 0   | 0   | 0   | 0   | 0   | 0   |
| 2020 | 0   | 0   | 250 | 0   | 0   | 0   | 0   | 0   | 0   | 0   | 0   |
| 2021 | 0   | 0   | 250 | 0   | 0   | 0   | 0   | 0   | 0   | 0   | 0   |
| 2022 | 0   | 0   | 250 | 0   | 0   | 0   | 0   | 0   | 0   | 0   | 0   |
| 2023 | 0   | 0   | 250 | 0   | 0   | 0   | 0   | 0   | 0   | 0   | 0   |
| 2024 | 0   | 0   | 250 | 0   | 0   | 0   | 0   | 0   | 0   | 0   | 0   |
| 2025 | 250 | 0   | 250 | 250 | 250 | 250 | 250 | 250 | 250 | 250 | 0   |
| 2026 | 250 | 0   | 250 | 250 | 250 | 250 | 250 | 250 | 250 | 250 | 0   |
| 2027 | 250 | 0   | 250 | 250 | 250 | 250 | 250 | 250 | 250 | 250 | 0   |
| 2028 | 250 | 0   | 250 | 250 | 250 | 250 | 250 | 250 | 250 | 250 | 0   |
| 2029 | 250 | 0   | 250 | 250 | 250 | 250 | 250 | 250 | 250 | 250 | 0   |
| 2030 | 250 | 250 | 250 | 250 | 250 | 250 | 250 | 250 | 250 | 250 | 250 |
| 2031 | 250 | 250 | 250 | 250 | 250 | 250 | 250 | 250 | 250 | 250 | 250 |
| 2032 | 250 | 250 | 250 | 250 | 250 | 250 | 250 | 250 | 250 | 250 | 250 |
| 2033 | 250 | 250 | 250 | 250 | 250 | 250 | 250 | 250 | 250 | 250 | 250 |
| 2034 | 250 | 250 | 250 | 250 | 250 | 250 | 250 | 250 | 250 | 250 | 250 |
| 2035 | 250 | 250 | 250 | 250 | 250 | 250 | 250 | 250 | 250 | 250 | 250 |
| 2036 | 250 | 250 | 250 | 250 | 250 | 250 | 250 | 250 | 250 | 250 | 250 |
| 2037 | 250 | 250 | 250 | 250 | 250 | 250 | 250 | 250 | 250 | 250 | 250 |
| 2038 | 250 | 250 | 250 | 250 | 250 | 250 | 250 | 250 | 250 | 250 | 250 |
| 2039 | 250 | 250 | 250 | 250 | 250 | 250 | 250 | 250 | 250 | 250 | 250 |
| 2040 | 250 | 250 | 250 | 250 | 250 | 250 | 250 | 250 | 250 | 250 | 250 |
| 2041 | 250 | 250 | 250 | 250 | 250 | 250 | 250 | 250 | 250 | 250 | 250 |
| 2042 | 250 | 250 | 250 | 250 | 250 | 250 | 250 | 250 | 250 | 250 | 250 |
| 2043 | 250 | 250 | 155 | 250 | 250 | 250 | 250 | 250 | 250 | 250 | 250 |
| 2044 | 250 | 250 | 126 | 250 | 250 | 250 | 250 | 250 | 250 | 250 | 250 |
| 2045 | 250 | 250 | 94  | 250 | 250 | 250 | 250 | 250 | 250 | 250 | 250 |
| 2046 | 250 | 250 | 73  | 250 | 250 | 250 | 250 | 250 | 250 | 250 | 250 |
| 2047 | 250 | 250 | 6   | 236 | 235 | 227 | 227 | 227 | 250 | 250 | 250 |
| 2048 | 209 | 250 | 6   | 170 | 170 | 169 | 169 | 169 | 250 | 250 | 250 |
| 2049 | 123 | 250 | 0   | 128 | 118 | 114 | 114 | 114 | 250 | 250 | 250 |
| 2050 | 97  | 250 | 0   | 90  | 88  | 86  | 86  | 86  | 235 | 248 | 250 |
| 2051 | 32  | 250 | 0   | 39  | 29  | 29  | 29  | 29  | 205 | 223 | 250 |
| 2052 | 19  | 199 | 0   | 17  | 17  | 7   | 7   | 7   | 125 | 148 | 250 |
| 2053 | 13  | 178 | 0   | 14  | 8   | 5   | 5   | 5   | 54  | 76  | 250 |
| 2054 | 6   | 151 | 0   | 0   | 7   | 2   | 2   | 2   | 38  | 42  | 188 |
| 2055 | 4   | 126 | 0   | 0   | 0   | 2   | 2   | 2   | 21  | 30  | 151 |
| 2056 | 0   | 92  | 0   | 0   | 0   | 0   | 0   | 0   | 10  | 11  | 94  |
| 2057 | 0   | 74  | 0   | 0   | 0   | 0   | 0   | 0   | 1   | 1   | 47  |
| 2058 | 0   | 27  | 0   | 0   | 0   | 0   | 0   | 0   | 1   | 1   | 31  |
| 2059 | 0   | 14  | 0   | 0   | 0   | 0   | 0   | 0   | 1   | 1   | 21  |

|      | 56 | 57 | 58 | 59 | 60 | 61 | 62 | 63 | 64 | 65 | 66 |
|------|----|----|----|----|----|----|----|----|----|----|----|
| 2060 | 0  | 11 | 0  | 0  | 0  | 0  | 0  | 0  | 1  | 1  | 12 |
| 2061 | 0  | 0  | 0  | 0  | 0  | 0  | 0  | 0  | 1  | 1  | 6  |
| 2062 | 0  | 0  | 0  | 0  | 0  | 0  | 0  | 0  | 1  | 1  | 0  |
| 2063 | 0  | 0  | 0  | 0  | 0  | 0  | 0  | 0  | 1  | 1  | 0  |
| 2064 | 0  | 0  | 0  | 0  | 0  | 0  | 0  | 0  | 1  | 1  | 0  |
| 2065 | 0  | 0  | 0  | 0  | 0  | 0  | 0  | 0  | 1  | 1  | 0  |
| 2066 | 0  | 0  | 0  | 0  | 0  | 0  | 0  | 0  | 1  | 1  | 0  |
| 2067 | 0  | 0  | 0  | 0  | 0  | 0  | 0  | 0  | 1  | 1  | 0  |
| 2068 | 0  | 0  | 0  | 0  | 0  | 0  | 0  | 0  | 1  | 1  | 0  |
| 2069 | 0  | 0  | 0  | 0  | 0  | 0  | 0  | 0  | 1  | 1  | 0  |
| 2070 | 0  | 0  | 0  | 0  | 0  | 0  | 0  | 0  | 1  | 1  | 0  |
| 2071 | 0  | 0  | 0  | 0  | 0  | 0  | 0  | 0  | 1  | 1  | 0  |
| 2072 | 0  | 0  | 0  | 0  | 0  | 0  | 0  | 0  | 1  | 1  | 0  |
| 2073 | 0  | 0  | 0  | 0  | 0  | 0  | 0  | 0  | 1  | 1  | 0  |
| 2074 | 0  | 0  | 0  | 0  | 0  | 0  | 0  | 0  | 1  | 1  | 0  |
| 2075 | 0  | 0  | 0  | 0  | 0  | 0  | 0  | 0  | 1  | 1  | 0  |
| 2076 | 0  | 0  | 0  | 0  | 0  | 0  | 0  | 0  | 1  | 1  | 0  |
| 2077 | 0  | 0  | 0  | 0  | 0  | 0  | 0  | 0  | 1  | 1  | 0  |
| 2078 | 0  | 0  | 0  | 0  | 0  | 0  | 0  | 0  | 1  | 1  | 0  |
| 2079 | 0  | 0  | 0  | 0  | 0  | 0  | 0  | 0  | 1  | 1  | 0  |
| 2080 | 0  | 0  | 0  | 0  | 0  | 0  | 0  | 0  | 1  | 1  | 0  |
| 2081 | 0  | 0  | 0  | 0  | 0  | 0  | 0  | 0  | 1  | 1  | 0  |
| 2082 | 0  | 0  | 0  | 0  | 0  | 0  | 0  | 0  | 1  | 1  | 0  |
| 2083 | 0  | 0  | 0  | 0  | 0  | 0  | 0  | 0  | 1  | 1  | 0  |
| 2084 | 0  | 0  | 0  | 0  | 0  | 0  | 0  | 0  | 1  | 1  | 0  |
| 2085 | 0  | 0  | 0  | 0  | 0  | 0  | 0  | 0  | 1  | 1  | 0  |
| 2086 | 0  | 0  | 0  | 0  | 0  | 0  | 0  | 0  | 1  | 1  | 0  |
| 2087 | 0  | 0  | 0  | 0  | 0  | 0  | 0  | 0  | 1  | 1  | 0  |
| 2088 | 0  | 0  | 0  | 0  | 0  | 0  | 0  | 0  | 1  | 1  | 0  |
| 2089 | 0  | 0  | 0  | 0  | 0  | 0  | 0  | 0  | 1  | 1  | 0  |
| 2090 | 0  | 0  | 0  | 0  | 0  | 0  | 0  | 0  | 1  | 1  | 0  |

|      | 67  | 68  | 69  | 70  | 71  | 72  | 73  | 74  | 75  | 76  | 77  |
|------|-----|-----|-----|-----|-----|-----|-----|-----|-----|-----|-----|
| 2002 | 0   | 0   | 0   | 0   | 0   | 0   | 0   | 0   | 0   | 0   | 0   |
| 2003 | 0   | 0   | 0   | 0   | 0   | 0   | 0   | 0   | 0   | 0   | 0   |
| 2004 | 0   | 0   | 0   | 0   | 0   | 0   | 0   | 0   | 0   | 0   | 0   |
| 2005 | 0   | 0   | 0   | 0   | 0   | 0   | 0   | 0   | 0   | 0   | 0   |
| 2006 | 0   | 0   | 0   | 0   | 0   | 0   | 0   | 0   | 0   | 0   | 0   |
| 2007 | 0   | 0   | 0   | 0   | 0   | 0   | 0   | 0   | 0   | 0   | 0   |
| 2008 | 0   | 0   | 0   | 0   | 0   | 0   | 0   | 0   | 0   | 0   | 0   |
| 2009 | 0   | 0   | 0   | 0   | 0   | 0   | 0   | 0   | 0   | 0   | 0   |
| 2010 | 0   | 0   | 0   | 0   | 0   | 0   | 0   | 0   | 0   | 0   | 0   |
| 2011 | 0   | 0   | 0   | 0   | 0   | 0   | 0   | 0   | 0   | 0   | 0   |
| 2012 | 0   | 0   | 0   | 0   | 0   | 0   | 0   | 0   | 0   | 0   | 0   |
| 2013 | 0   | 0   | 0   | 0   | 0   | 0   | 0   | 0   | 0   | 0   | 0   |
| 2014 | 0   | 0   | 0   | 0   | 0   | 0   | 0   | 0   | 0   | 0   | 0   |
| 2015 | 0   | 0   | 0   | 0   | 0   | 0   | 0   | 0   | 0   | 0   | 0   |
| 2016 | 0   | 0   | 0   | 0   | 0   | 0   | 0   | 0   | 0   | 0   | 0   |
| 2017 | 0   | 0   | 0   | 0   | 0   | 0   | 0   | 0   | 0   | 0   | 0   |
| 2018 | 0   | 0   | 0   | 0   | 0   | 0   | 0   | 0   | 0   | 0   | 0   |
| 2019 | 0   | 0   | 0   | 0   | 0   | 0   | 0   | 0   | 0   | 0   | 0   |
| 2020 | 250 | 0   | 0   | 0   | 0   | 0   | 0   | 0   | 0   | 250 | 0   |
| 2021 | 250 | 0   | 0   | 0   | 0   | 0   | 0   | 0   | 0   | 250 | 0   |
| 2022 | 250 | 0   | 0   | 0   | 0   | 0   | 0   | 0   | 0   | 250 | 0   |
| 2023 | 250 | 0   | 0   | 0   | 0   | 0   | 0   | 0   | 0   | 250 | 0   |
| 2024 | 250 | 0   | 0   | 0   | 0   | 0   | 0   | 0   | 0   | 250 | 0   |
| 2025 | 250 | 250 | 250 | 250 | 250 | 250 | 250 | 250 | 0   | 250 | 250 |
| 2026 | 250 | 250 | 250 | 250 | 250 | 250 | 250 | 250 | 0   | 250 | 250 |
| 2027 | 250 | 250 | 250 | 250 | 250 | 250 | 250 | 250 | 0   | 250 | 250 |
| 2028 | 250 | 250 | 250 | 250 | 250 | 250 | 250 | 250 | 0   | 250 | 250 |
| 2029 | 250 | 250 | 250 | 250 | 250 | 250 | 250 | 250 | 0   | 250 | 250 |
| 2030 | 250 | 250 | 250 | 250 | 250 | 250 | 250 | 250 | 250 | 250 | 250 |
| 2031 | 250 | 250 | 250 | 250 | 250 | 250 | 250 | 250 | 250 | 250 | 250 |
| 2032 | 250 | 250 | 250 | 250 | 250 | 250 | 250 | 250 | 250 | 250 | 250 |
| 2033 | 250 | 250 | 250 | 250 | 250 | 250 | 250 | 250 | 250 | 250 | 250 |
| 2034 | 250 | 250 | 250 | 250 | 250 | 250 | 250 | 250 | 250 | 250 | 250 |
| 2035 | 250 | 250 | 250 | 250 | 250 | 250 | 250 | 250 | 250 | 250 | 250 |
| 2036 | 250 | 250 | 250 | 250 | 250 | 250 | 250 | 250 | 250 | 250 | 250 |
| 2037 | 250 | 250 | 250 | 250 | 250 | 250 | 250 | 250 | 250 | 250 | 250 |
| 2038 | 250 | 250 | 250 | 250 | 250 | 250 | 250 | 250 | 250 | 250 | 250 |
| 2039 | 250 | 250 | 250 | 250 | 250 | 250 | 250 | 250 | 250 | 250 | 250 |
| 2040 | 250 | 250 | 250 | 250 | 250 | 250 | 250 | 250 | 250 | 250 | 250 |
| 2041 | 250 | 250 | 250 | 250 | 250 | 250 | 250 | 250 | 250 | 250 | 250 |
| 2042 | 250 | 250 | 250 | 250 | 250 | 250 | 250 | 250 | 250 | 250 | 250 |
| 2043 | 250 | 250 | 250 | 250 | 250 | 250 | 250 | 250 | 250 | 250 | 250 |
| 2044 | 250 | 250 | 250 | 250 | 250 | 250 | 250 | 250 | 250 | 200 | 250 |
| 2045 | 200 | 250 | 250 | 250 | 250 | 250 | 250 | 250 | 250 | 200 | 250 |
| 2046 | 198 | 250 | 250 | 250 | 250 | 250 | 250 | 250 | 250 | 85  | 250 |
| 2047 | 105 | 250 | 250 | 250 | 250 | 250 | 250 | 250 | 250 | 35  | 250 |
| 2048 | 46  | 250 | 250 | 250 | 250 | 250 | 245 | 250 | 250 | 16  | 250 |
| 2049 | 31  | 250 | 242 | 250 | 250 | 250 | 203 | 224 | 250 | 0   | 213 |
| 2050 | 16  | 250 | 157 | 248 | 248 | 248 | 117 | 138 | 250 | 0   | 127 |
| 2051 | 6   | 213 | 76  | 202 | 202 | 202 | 50  | 78  | 250 | 0   | 57  |
| 2052 | 0   | 127 | 42  | 121 | 121 | 121 | 38  | 42  | 245 | 0   | 39  |
| 2053 | 0   | 64  | 39  | 57  | 57  | 57  | 21  | 30  | 198 | 0   | 31  |
| 2054 | 0   | 42  | 25  | 39  | 39  | 39  | 10  | 11  | 139 | 0   | 16  |
| 2055 | 0   | 31  | 6   | 31  | 31  | 31  | 0   | 0   | 85  | 0   | 0   |
| 2056 | 0   | 16  | 0   | 16  | 16  | 16  | 0   | 0   | 47  | 0   | 0   |
| 2057 | 0   | 6   | 0   | 6   | 6   | 6   | 0   | 0   | 31  | 0   | 0   |
| 2058 | 0   | 0   | 0   | 0   | 0   | 0   | 0   | 0   | 21  | 0   | 0   |
| 2059 | 0   | 0   | 0   | 0   | 0   | 0   | 0   | 0   | 12  | 0   | 0   |

|      | 67 | 68 | 69 | 70 | 71 | 72 | 73 | 74 | 75 | 76 | 77 |
|------|----|----|----|----|----|----|----|----|----|----|----|
| 2060 | 0  | 0  | 0  | 0  | 0  | 0  | 0  | 0  | 6  | 0  | 0  |
| 2061 | 0  | 0  | 0  | 0  | 0  | 0  | 0  | 0  | 1  | 0  | 0  |
| 2062 | 0  | 0  | 0  | 0  | 0  | 0  | 0  | 0  | 1  | 0  | 0  |
| 2063 | 0  | 0  | 0  | 0  | 0  | 0  | 0  | 0  | 1  | 0  | 0  |
| 2064 | 0  | 0  | 0  | 0  | 0  | 0  | 0  | 0  | 1  | 0  | 0  |
| 2065 | 0  | 0  | 0  | 0  | 0  | 0  | 0  | 0  | 1  | 0  | 0  |
| 2066 | 0  | 0  | 0  | 0  | 0  | 0  | 0  | 0  | 1  | 0  | 0  |
| 2067 | 0  | 0  | 0  | 0  | 0  | 0  | 0  | 0  | 1  | 0  | 0  |
| 2068 | 0  | 0  | 0  | 0  | 0  | 0  | 0  | 0  | 1  | 0  | 0  |
| 2069 | 0  | 0  | 0  | 0  | 0  | 0  | 0  | 0  | 1  | 0  | 0  |
| 2070 | 0  | 0  | 0  | 0  | 0  | 0  | 0  | 0  | 1  | 0  | 0  |
| 2071 | 0  | 0  | 0  | 0  | 0  | 0  | 0  | 0  | 1  | 0  | 0  |
| 2072 | 0  | 0  | 0  | 0  | 0  | 0  | 0  | 0  | 1  | 0  | 0  |
| 2073 | 0  | 0  | 0  | 0  | 0  | 0  | 0  | 0  | 1  | 0  | 0  |
| 2074 | 0  | 0  | 0  | 0  | 0  | 0  | 0  | 0  | 1  | 0  | 0  |
| 2075 | 0  | 0  | 0  | 0  | 0  | 0  | 0  | 0  | 1  | 0  | 0  |
| 2076 | 0  | 0  | 0  | 0  | 0  | 0  | 0  | 0  | 1  | 0  | 0  |
| 2077 | 0  | 0  | 0  | 0  | 0  | 0  | 0  | 0  | 1  | 0  | 0  |
| 2078 | 0  | 0  | 0  | 0  | 0  | 0  | 0  | 0  | 1  | 0  | 0  |
| 2079 | 0  | 0  | 0  | 0  | 0  | 0  | 0  | 0  | 1  | 0  | 0  |
| 2080 | 0  | 0  | 0  | 0  | 0  | 0  | 0  | 0  | 1  | 0  | 0  |
| 2081 | 0  | 0  | 0  | 0  | 0  | 0  | 0  | 0  | 1  | 0  | 0  |
| 2082 | 0  | 0  | 0  | 0  | 0  | 0  | 0  | 0  | 1  | 0  | 0  |
| 2083 | 0  | 0  | 0  | 0  | 0  | 0  | 0  | 0  | 1  | 0  | 0  |
| 2084 | 0  | 0  | 0  | 0  | 0  | 0  | 0  | 0  | 1  | 0  | 0  |
| 2085 | 0  | 0  | 0  | 0  | 0  | 0  | 0  | 0  | 1  | 0  | 0  |
| 2086 | 0  | 0  | 0  | 0  | 0  | 0  | 0  | 0  | 1  | 0  | 0  |
| 2087 | 0  | 0  | 0  | 0  | 0  | 0  | 0  | 0  | 1  | 0  | 0  |
| 2088 | 0  | 0  | 0  | 0  | 0  | 0  | 0  | 0  | 1  | 0  | 0  |
| 2089 | 0  | 0  | 0  | 0  | 0  | 0  | 0  | 0  | 1  | 0  | 0  |
| 2090 | 0  | 0  | 0  | 0  | 0  | 0  | 0  | 0  | 1  | 0  | 0  |

|      | 78  | 79  | 80  | 81  | 82  | 83  | 84  | 85  | 86  | 87  | 88  |
|------|-----|-----|-----|-----|-----|-----|-----|-----|-----|-----|-----|
| 2002 | 0   | 0   | 0   | 0   | 0   | 0   | 0   | 0   | 0   | 0   | 0   |
| 2003 | 0   | 0   | 0   | 0   | 0   | 0   | 0   | 0   | 0   | 0   | 0   |
| 2004 | 0   | 0   | 0   | 0   | 0   | 0   | 0   | 0   | 0   | 0   | 0   |
| 2005 | 0   | 0   | 0   | 0   | 0   | 0   | 0   | 0   | 0   | 0   | 0   |
| 2006 | 0   | 0   | 0   | 0   | 0   | 0   | 0   | 0   | 0   | 0   | 0   |
| 2007 | 0   | 0   | 0   | 0   | 0   | 0   | 0   | 0   | 0   | 0   | 0   |
| 2008 | 0   | 0   | 0   | 0   | 0   | 0   | 0   | 0   | 0   | 0   | 0   |
| 2009 | 0   | 0   | 0   | 0   | 0   | 0   | 0   | 0   | 0   | 0   | 0   |
| 2010 | 0   | 0   | 0   | 0   | 0   | 0   | 0   | 0   | 0   | 0   | 0   |
| 2011 | 0   | 0   | 0   | 0   | 0   | 0   | 0   | 0   | 0   | 0   | 0   |
| 2012 | 0   | 0   | 0   | 0   | 0   | 0   | 0   | 0   | 0   | 0   | 0   |
| 2013 | 0   | 0   | 0   | 0   | 0   | 0   | 0   | 0   | 0   | 0   | 0   |
| 2014 | 0   | 0   | 0   | 0   | 0   | 0   | 0   | 0   | 0   | 0   | 0   |
| 2015 | 0   | 0   | 0   | 0   | 0   | 0   | 0   | 0   | 0   | 0   | 0   |
| 2016 | 0   | 0   | 0   | 0   | 0   | 0   | 0   | 0   | 0   | 0   | 0   |
| 2017 | 0   | 0   | 0   | 0   | 0   | 0   | 0   | 0   | 0   | 0   | 0   |
| 2018 | 0   | 0   | 0   | 0   | 0   | 0   | 0   | 0   | 0   | 0   | 0   |
| 2019 | 0   | 0   | 0   | 0   | 0   | 0   | 0   | 0   | 0   | 0   | 0   |
| 2020 | 0   | 0   | 0   | 0   | 0   | 0   | 0   | 250 | 0   | 0   | 0   |
| 2021 | 0   | 0   | 0   | 0   | 0   | 0   | 0   | 250 | 0   | 0   | 0   |
| 2022 | 0   | 0   | 0   | 0   | 0   | 0   | 0   | 250 | 0   | 0   | 0   |
| 2023 | 0   | 0   | 0   | 0   | 0   | 0   | 0   | 250 | 0   | 0   | 0   |
| 2024 | 0   | 0   | 0   | 0   | 0   | 0   | 0   | 250 | 0   | 0   | 0   |
| 2025 | 250 | 250 | 250 | 250 | 250 | 250 | 0   | 250 | 250 | 250 | 250 |
| 2026 | 250 | 250 | 250 | 250 | 250 | 250 | 0   | 250 | 250 | 250 | 250 |
| 2027 | 250 | 250 | 250 | 250 | 250 | 250 | 0   | 250 | 250 | 250 | 250 |
| 2028 | 250 | 250 | 250 | 250 | 250 | 250 | 0   | 250 | 250 | 250 | 250 |
| 2029 | 250 | 250 | 250 | 250 | 250 | 250 | 0   | 250 | 250 | 250 | 250 |
| 2030 | 250 | 250 | 250 | 250 | 250 | 250 | 250 | 250 | 250 | 250 | 250 |
| 2031 | 250 | 250 | 250 | 250 | 250 | 250 | 250 | 250 | 250 | 250 | 250 |
| 2032 | 250 | 250 | 250 | 250 | 250 | 250 | 250 | 250 | 250 | 250 | 250 |
| 2033 | 250 | 250 | 250 | 250 | 250 | 250 | 250 | 250 | 250 | 250 | 250 |
| 2034 | 250 | 250 | 250 | 250 | 250 | 250 | 250 | 250 | 250 | 250 | 250 |
| 2035 | 250 | 250 | 250 | 250 | 250 | 250 | 250 | 250 | 250 | 250 | 250 |
| 2036 | 250 | 250 | 250 | 250 | 250 | 250 | 250 | 250 | 250 | 250 | 250 |
| 2037 | 250 | 250 | 250 | 250 | 250 | 250 | 250 | 250 | 250 | 250 | 250 |
| 2038 | 250 | 250 | 250 | 250 | 250 | 250 | 250 | 250 | 250 | 250 | 250 |
| 2039 | 250 | 250 | 250 | 250 | 250 | 250 | 250 | 250 | 250 | 250 | 250 |
| 2040 | 250 | 250 | 250 | 250 | 250 | 250 | 250 | 250 | 250 | 250 | 250 |
| 2041 | 250 | 250 | 250 | 250 | 250 | 250 | 250 | 250 | 250 | 250 | 250 |
| 2042 | 250 | 250 | 250 | 250 | 250 | 250 | 250 | 250 | 250 | 250 | 250 |
| 2043 | 250 | 250 | 250 | 250 | 250 | 250 | 250 | 216 | 250 | 250 | 250 |
| 2044 | 250 | 250 | 250 | 250 | 250 | 250 | 250 | 202 | 250 | 250 | 250 |
| 2045 | 250 | 250 | 250 | 250 | 250 | 250 | 250 | 119 | 250 | 250 | 250 |
| 2046 | 250 | 250 | 250 | 250 | 250 | 250 | 250 | 96  | 250 | 250 | 250 |
| 2047 | 250 | 250 | 250 | 250 | 250 | 250 | 250 | 24  | 250 | 250 | 250 |
| 2048 | 235 | 250 | 250 | 250 | 209 | 209 | 250 | 19  | 209 | 201 | 209 |
| 2049 | 178 | 220 | 220 | 220 | 134 | 134 | 250 | 0   | 142 | 141 | 134 |
| 2050 | 84  | 119 | 119 | 119 | 98  | 98  | 250 | 0   | 101 | 101 | 98  |
| 2051 | 46  | 62  | 62  | 62  | 83  | 83  | 250 | 0   | 87  | 87  | 83  |
| 2052 | 40  | 42  | 42  | 42  | 30  | 30  | 248 | 0   | 42  | 33  | 30  |
| 2053 | 32  | 31  | 31  | 31  | 17  | 17  | 186 | 0   | 17  | 17  | 17  |
| 2054 | 16  | 0   | 0   | 0   | 10  | 10  | 163 | 0   | 12  | 12  | 10  |
| 2055 | 6   | 0   | 0   | 0   | 0   | 0   | 138 | 0   | 0   | 0   | 0   |
| 2056 | 1   | 0   | 0   | 0   | 0   | 0   | 115 | 0   | 0   | 0   | 0   |
| 2057 | 1   | 0   | 0   | 0   | 0   | 0   | 89  | 0   | 0   | 0   | 0   |
| 2058 | 1   | 0   | 0   | 0   | 0   | 0   | 57  | 0   | 0   | 0   | 0   |
| 2059 | 1   | 0   | 0   | 0   | 0   | 0   | 13  | 0   | 0   | 0   | 0   |

|      | 78 | 79 | 80 | 81 | 82 | 83 | 84 | 85 | 86 | 87 | 88 |
|------|----|----|----|----|----|----|----|----|----|----|----|
| 2060 | 1  | 0  | 0  | 0  | 0  | 0  | 6  | 0  | 0  | 0  | 0  |
| 2061 | 1  | 0  | 0  | 0  | 0  | 0  | 0  | 0  | 0  | 0  | 0  |
| 2062 | 1  | 0  | 0  | 0  | 0  | 0  | 0  | 0  | 0  | 0  | 0  |
| 2063 | 1  | 0  | 0  | 0  | 0  | 0  | 0  | 0  | 0  | 0  | 0  |
| 2064 | 1  | 0  | 0  | 0  | 0  | 0  | 0  | 0  | 0  | 0  | 0  |
| 2065 | 1  | 0  | 0  | 0  | 0  | 0  | 0  | 0  | 0  | 0  | 0  |
| 2066 | 1  | 0  | 0  | 0  | 0  | 0  | 0  | 0  | 0  | 0  | 0  |
| 2067 | 1  | 0  | 0  | 0  | 0  | 0  | 0  | 0  | 0  | 0  | 0  |
| 2068 | 1  | 0  | 0  | 0  | 0  | 0  | 0  | 0  | 0  | 0  | 0  |
| 2069 | 1  | 0  | 0  | 0  | 0  | 0  | 0  | 0  | 0  | 0  | 0  |
| 2070 | 1  | 0  | 0  | 0  | 0  | 0  | 0  | 0  | 0  | 0  | 0  |
| 2071 | 1  | 0  | 0  | 0  | 0  | 0  | 0  | 0  | 0  | 0  | 0  |
| 2072 | 1  | 0  | 0  | 0  | 0  | 0  | 0  | 0  | 0  | 0  | 0  |
| 2073 | 1  | 0  | 0  | 0  | 0  | 0  | 0  | 0  | 0  | 0  | 0  |
| 2074 | 1  | 0  | 0  | 0  | 0  | 0  | 0  | 0  | 0  | 0  | 0  |
| 2075 | 1  | 0  | 0  | 0  | 0  | 0  | 0  | 0  | 0  | 0  | 0  |
| 2076 | 1  | 0  | 0  | 0  | 0  | 0  | 0  | 0  | 0  | 0  | 0  |
| 2077 | 1  | 0  | 0  | 0  | 0  | 0  | 0  | 0  | 0  | 0  | 0  |
| 2078 | 1  | 0  | 0  | 0  | 0  | 0  | 0  | 0  | 0  | 0  | 0  |
| 2079 | 1  | 0  | 0  | 0  | 0  | 0  | 0  | 0  | 0  | 0  | 0  |
| 2080 | 1  | 0  | 0  | 0  | 0  | 0  | 0  | 0  | 0  | 0  | 0  |
| 2081 | 1  | 0  | 0  | 0  | 0  | 0  | 0  | 0  | 0  | 0  | 0  |
| 2082 | 1  | 0  | 0  | 0  | 0  | 0  | 0  | 0  | 0  | 0  | 0  |
| 2083 | 1  | 0  | 0  | 0  | 0  | 0  | 0  | 0  | 0  | 0  | 0  |
| 2084 | 1  | 0  | 0  | 0  | 0  | 0  | 0  | 0  | 0  | 0  | 0  |
| 2085 | 1  | 0  | 0  | 0  | 0  | 0  | 0  | 0  | 0  | 0  | 0  |
| 2086 | 1  | 0  | 0  | 0  | 0  | 0  | 0  | 0  | 0  | 0  | 0  |
| 2087 | 1  | 0  | 0  | 0  | 0  | 0  | 0  | 0  | 0  | 0  | 0  |
| 2088 | 1  | 0  | 0  | 0  | 0  | 0  | 0  | 0  | 0  | 0  | 0  |
| 2089 | 1  | 0  | 0  | 0  | 0  | 0  | 0  | 0  | 0  | 0  | 0  |
| 2090 | 1  | 0  | 0  | 0  | 0  | 0  | 0  | 0  | 0  | 0  | 0  |

|      | 89  | 90  | 91  | 92  | 93  | 94  | 95  | 96  | 97  | 98  | 99  |
|------|-----|-----|-----|-----|-----|-----|-----|-----|-----|-----|-----|
| 2002 | 0   | 0   | 0   | 0   | 0   | 0   | 0   | 0   | 0   | 0   | 0   |
| 2003 | 0   | 0   | 0   | 0   | 0   | 0   | 0   | 0   | 0   | 0   | 0   |
| 2004 | 0   | 0   | 0   | 0   | 0   | 0   | 0   | 0   | 0   | 0   | 0   |
| 2005 | 0   | 0   | 0   | 0   | 0   | 0   | 0   | 0   | 0   | 0   | 0   |
| 2006 | 0   | 0   | 0   | 0   | 0   | 0   | 0   | 0   | 0   | 0   | 0   |
| 2007 | 0   | 0   | 0   | 0   | 0   | 0   | 0   | 0   | 0   | 0   | 0   |
| 2008 | 0   | 0   | 0   | 0   | 0   | 0   | 0   | 0   | 0   | 0   | 0   |
| 2009 | 0   | 0   | 0   | 0   | 0   | 0   | 0   | 0   | 0   | 0   | 0   |
| 2010 | 0   | 0   | 0   | 0   | 0   | 0   | 0   | 0   | 0   | 0   | 0   |
| 2011 | 0   | 0   | 0   | 0   | 0   | 0   | 0   | 0   | 0   | 0   | 0   |
| 2012 | 0   | 0   | 0   | 0   | 0   | 0   | 0   | 0   | 0   | 0   | 0   |
| 2013 | 0   | 0   | 0   | 0   | 0   | 0   | 0   | 0   | 0   | 0   | 0   |
| 2014 | 0   | 0   | 0   | 0   | 0   | 0   | 0   | 0   | 0   | 0   | 0   |
| 2015 | 0   | 0   | 0   | 0   | 0   | 0   | 0   | 0   | 0   | 0   | 0   |
| 2016 | 0   | 0   | 0   | 0   | 0   | 0   | 0   | 0   | 0   | 0   | 0   |
| 2017 | 0   | 0   | 0   | 0   | 0   | 0   | 0   | 0   | 0   | 0   | 0   |
| 2018 | 0   | 0   | 0   | 0   | 0   | 0   | 0   | 0   | 0   | 0   | 0   |
| 2019 | 0   | 0   | 0   | 0   | 0   | 0   | 0   | 0   | 0   | 0   | 0   |
| 2020 | 0   | 0   | 0   | 0   | 0   | 250 | 0   | 0   | 0   | 0   | 0   |
| 2021 | 0   | 0   | 0   | 0   | 0   | 250 | 0   | 0   | 0   | 0   | 0   |
| 2022 | 0   | 0   | 0   | 0   | 0   | 250 | 0   | 0   | 0   | 0   | 0   |
| 2023 | 0   | 0   | 0   | 0   | 0   | 250 | 0   | 0   | 0   | 0   | 0   |
| 2024 | 0   | 0   | 0   | 0   | 0   | 250 | 0   | 0   | 0   | 0   | 0   |
| 2025 | 250 | 250 | 250 | 250 | 0   | 250 | 250 | 250 | 250 | 250 | 250 |
| 2026 | 250 | 250 | 250 | 250 | 0   | 250 | 250 | 250 | 250 | 250 | 250 |
| 2027 | 250 | 250 | 250 | 250 | 0   | 250 | 250 | 250 | 250 | 250 | 250 |
| 2028 | 250 | 250 | 250 | 250 | 0   | 250 | 250 | 250 | 250 | 250 | 250 |
| 2029 | 250 | 250 | 250 | 250 | 0   | 250 | 250 | 250 | 250 | 250 | 250 |
| 2030 | 250 | 250 | 250 | 250 | 250 | 250 | 250 | 250 | 250 | 250 | 250 |
| 2031 | 250 | 250 | 250 | 250 | 250 | 250 | 250 | 250 | 250 | 250 | 250 |
| 2032 | 250 | 250 | 250 | 250 | 250 | 250 | 250 | 250 | 250 | 250 | 250 |
| 2033 | 250 | 250 | 250 | 250 | 250 | 250 | 250 | 250 | 250 | 250 | 250 |
| 2034 | 250 | 250 | 250 | 250 | 250 | 250 | 250 | 250 | 250 | 250 | 250 |
| 2035 | 250 | 250 | 250 | 250 | 250 | 250 | 250 | 250 | 250 | 250 | 250 |
| 2036 | 250 | 250 | 250 | 250 | 250 | 250 | 250 | 250 | 250 | 250 | 250 |
| 2037 | 250 | 250 | 250 | 250 | 250 | 250 | 250 | 250 | 250 | 250 | 250 |
| 2038 | 250 | 250 | 250 | 250 | 250 | 250 | 250 | 250 | 250 | 250 | 250 |
| 2039 | 250 | 250 | 250 | 250 | 250 | 250 | 250 | 250 | 250 | 250 | 250 |
| 2040 | 250 | 250 | 250 | 250 | 250 | 250 | 250 | 250 | 250 | 250 | 250 |
| 2041 | 250 | 250 | 250 | 250 | 250 | 250 | 250 | 250 | 250 | 250 | 250 |
| 2042 | 250 | 250 | 250 | 250 | 250 | 250 | 250 | 250 | 250 | 250 | 250 |
| 2043 | 250 | 250 | 250 | 250 | 250 | 250 | 250 | 250 | 250 | 250 | 250 |
| 2044 | 250 | 250 | 250 | 250 | 250 | 250 | 250 | 250 | 250 | 250 | 250 |
| 2045 | 250 | 250 | 250 | 250 | 250 | 250 | 250 | 250 | 250 | 250 | 250 |
| 2046 | 250 | 250 | 250 | 250 | 250 | 250 | 250 | 250 | 250 | 250 | 250 |
| 2047 | 250 | 250 | 250 | 250 | 250 | 235 | 250 | 250 | 250 | 250 | 250 |
| 2048 | 209 | 209 | 250 | 250 | 250 | 235 | 250 | 250 | 250 | 250 | 250 |
| 2049 | 134 | 134 | 250 | 250 | 250 | 180 | 250 | 244 | 250 | 250 | 250 |
| 2050 | 98  | 98  | 250 | 250 | 250 | 91  | 250 | 197 | 250 | 250 | 250 |
| 2051 | 83  | 83  | 223 | 223 | 250 | 38  | 235 | 120 | 223 | 223 | 223 |
| 2052 | 30  | 30  | 154 | 154 | 250 | 29  | 167 | 70  | 154 | 154 | 154 |
| 2053 | 17  | 17  | 90  | 90  | 250 | 0   | 94  | 42  | 90  | 90  | 90  |
| 2054 | 10  | 10  | 48  | 48  | 217 | 0   | 52  | 38  | 48  | 48  | 48  |
| 2055 | 0   | 0   | 38  | 38  | 168 | 0   | 38  | 20  | 38  | 38  | 38  |
| 2056 | 0   | 0   | 20  | 20  | 109 | 0   | 20  | 9   | 20  | 20  | 20  |
| 2057 | 0   | 0   | 9   | 9   | 67  | 0   | 9   | 1   | 9   | 9   | 9   |
| 2058 | 0   | 0   | 0   | 0   | 42  | 0   | 1   | 1   | 0   | 0   | 0   |
| 2059 | 0   | 0   | 0   | 0   | 23  | 0   | 1   | 1   | 0   | 0   | 0   |

|      | 89 | 90 | 91 | 92 | 93 | 94 | 95 | 96 | 97 | 98 | 99 |
|------|----|----|----|----|----|----|----|----|----|----|----|
| 2060 | 0  | 0  | 0  | 0  | 16 | 0  | 1  | 1  | 0  | 0  | 0  |
| 2061 | 0  | 0  | 0  | 0  | 7  | 0  | 1  | 1  | 0  | 0  | 0  |
| 2062 | 0  | 0  | 0  | 0  | 1  | 0  | 1  | 1  | 0  | 0  | 0  |
| 2063 | 0  | 0  | 0  | 0  | 1  | 0  | 1  | 1  | 0  | 0  | 0  |
| 2064 | 0  | 0  | 0  | 0  | 1  | 0  | 1  | 1  | 0  | 0  | 0  |
| 2065 | 0  | 0  | 0  | 0  | 1  | 0  | 1  | 1  | 0  | 0  | 0  |
| 2066 | 0  | 0  | 0  | 0  | 1  | 0  | 1  | 1  | 0  | 0  | 0  |
| 2067 | 0  | 0  | 0  | 0  | 1  | 0  | 1  | 1  | 0  | 0  | 0  |
| 2068 | 0  | 0  | 0  | 0  | 1  | 0  | 1  | 1  | 0  | 0  | 0  |
| 2069 | 0  | 0  | 0  | 0  | 1  | 0  | 1  | 1  | 0  | 0  | 0  |
| 2070 | 0  | 0  | 0  | 0  | 1  | 0  | 1  | 1  | 0  | 0  | 0  |
| 2071 | 0  | 0  | 0  | 0  | 1  | 0  | 1  | 1  | 0  | 0  | 0  |
| 2072 | 0  | 0  | 0  | 0  | 1  | 0  | 1  | 1  | 0  | 0  | 0  |
| 2073 | 0  | 0  | 0  | 0  | 1  | 0  | 1  | 1  | 0  | 0  | 0  |
| 2074 | 0  | 0  | 0  | 0  | 1  | 0  | 1  | 1  | 0  | 0  | 0  |
| 2075 | 0  | 0  | 0  | 0  | 1  | 0  | 1  | 1  | 0  | 0  | 0  |
| 2076 | 0  | 0  | 0  | 0  | 1  | 0  | 1  | 1  | 0  | 0  | 0  |
| 2077 | 0  | 0  | 0  | 0  | 1  | 0  | 1  | 1  | 0  | 0  | 0  |
| 2078 | 0  | 0  | 0  | 0  | 1  | 0  | 1  | 1  | 0  | 0  | 0  |
| 2079 | 0  | 0  | 0  | 0  | 1  | 0  | 1  | 1  | 0  | 0  | 0  |
| 2080 | 0  | 0  | 0  | 0  | 1  | 0  | 1  | 1  | 0  | 0  | 0  |
| 2081 | 0  | 0  | 0  | 0  | 1  | 0  | 1  | 1  | 0  | 0  | 0  |
| 2082 | 0  | 0  | 0  | 0  | 1  | 0  | 1  | 1  | 0  | 0  | 0  |
| 2083 | 0  | 0  | 0  | 0  | 1  | 0  | 1  | 1  | 0  | 0  | 0  |
| 2084 | 0  | 0  | 0  | 0  | 1  | 0  | 1  | 1  | 0  | 0  | 0  |
| 2085 | 0  | 0  | 0  | 0  | 1  | 0  | 1  | 1  | 0  | 0  | 0  |
| 2086 | 0  | 0  | 0  | 0  | 1  | 0  | 1  | 1  | 0  | 0  | 0  |
| 2087 | 0  | 0  | 0  | 0  | 1  | 0  | 1  | 1  | 0  | 0  | 0  |
| 2088 | 0  | 0  | 0  | 0  | 1  | 0  | 1  | 1  | 0  | 0  | 0  |
| 2089 | 0  | 0  | 0  | 0  | 1  | 0  | 1  | 1  | 0  | 0  | 0  |
| 2090 | 0  | 0  | 0  | 0  | 1  | 0  | 1  | 1  | 0  | 0  | 0  |



|      | 100 | 101 | 102 | 103 | 104 | 105 | 106 | 107 | 108 | 109 | 110 |
|------|-----|-----|-----|-----|-----|-----|-----|-----|-----|-----|-----|
| 2002 | 0   | 0   | 0   | 0   | 0   | 0   | 0   | 0   | 0   | 0   | 0   |
| 2003 | 0   | 0   | 0   | 0   | 0   | 0   | 0   | 0   | 0   | 0   | 0   |
| 2004 | 0   | 0   | 0   | 0   | 0   | 0   | 0   | 0   | 0   | 0   | 0   |
| 2005 | 0   | 0   | 0   | 0   | 0   | 0   | 0   | 0   | 0   | 0   | 0   |
| 2006 | 0   | 0   | 0   | 0   | 0   | 0   | 0   | 0   | 0   | 0   | 0   |
| 2007 | 0   | 0   | 0   | 0   | 0   | 0   | 0   | 0   | 0   | 0   | 0   |
| 2008 | 0   | 0   | 0   | 0   | 0   | 0   | 0   | 0   | 0   | 0   | 0   |
| 2009 | 0   | 0   | 0   | 0   | 0   | 0   | 0   | 0   | 0   | 0   | 0   |
| 2010 | 0   | 0   | 0   | 0   | 0   | 0   | 0   | 0   | 0   | 0   | 0   |
| 2011 | 0   | 0   | 0   | 0   | 0   | 0   | 0   | 0   | 0   | 0   | 0   |
| 2012 | 0   | 0   | 0   | 0   | 0   | 0   | 0   | 0   | 0   | 0   | 0   |
| 2013 | 0   | 0   | 0   | 0   | 0   | 0   | 0   | 0   | 0   | 0   | 0   |
| 2014 | 0   | 0   | 0   | 0   | 0   | 0   | 0   | 0   | 0   | 0   | 0   |
| 2015 | 0   | 0   | 0   | 0   | 0   | 0   | 0   | 0   | 0   | 0   | 0   |
| 2016 | 0   | 0   | 0   | 0   | 0   | 0   | 0   | 0   | 0   | 0   | 0   |
| 2017 | 0   | 0   | 0   | 0   | 0   | 0   | 0   | 0   | 0   | 0   | 0   |
| 2018 | 0   | 0   | 0   | 0   | 0   | 0   | 0   | 0   | 0   | 0   | 0   |
| 2019 | 0   | 0   | 0   | 0   | 0   | 0   | 0   | 0   | 0   | 0   | 0   |
| 2020 | 0   | 0   | 0   | 250 | 0   | 0   | 0   | 0   | 0   | 0   | 0   |
| 2021 | 0   | 0   | 0   | 250 | 0   | 0   | 0   | 0   | 0   | 0   | 0   |
| 2022 | 0   | 0   | 0   | 250 | 0   | 0   | 0   | 0   | 0   | 0   | 0   |
| 2023 | 0   | 0   | 0   | 250 | 0   | 0   | 0   | 0   | 0   | 0   | 0   |
| 2024 | 0   | 0   | 0   | 250 | 0   | 0   | 0   | 0   | 0   | 0   | 0   |
| 2025 | 250 | 250 | 0   | 250 | 250 | 250 | 250 | 250 | 250 | 250 | 250 |
| 2026 | 250 | 250 | 0   | 250 | 250 | 250 | 250 | 250 | 250 | 250 | 250 |
| 2027 | 250 | 250 | 0   | 250 | 250 | 250 | 250 | 250 | 250 | 250 | 250 |
| 2028 | 250 | 250 | 0   | 250 | 250 | 250 | 250 | 250 | 250 | 250 | 250 |
| 2029 | 250 | 250 | 0   | 250 | 250 | 250 | 250 | 250 | 250 | 250 | 250 |
| 2030 | 250 | 250 | 250 | 250 | 250 | 250 | 250 | 250 | 250 | 250 | 250 |
| 2031 | 250 | 250 | 250 | 250 | 250 | 250 | 250 | 250 | 250 | 250 | 250 |
| 2032 | 250 | 250 | 250 | 250 | 250 | 250 | 250 | 250 | 250 | 250 | 250 |
| 2033 | 250 | 250 | 250 | 250 | 250 | 250 | 250 | 250 | 250 | 250 | 250 |
| 2034 | 250 | 250 | 250 | 250 | 250 | 250 | 250 | 250 | 250 | 250 | 250 |
| 2035 | 250 | 250 | 250 | 250 | 250 | 250 | 250 | 250 | 250 | 250 | 250 |
| 2036 | 250 | 250 | 250 | 250 | 250 | 250 | 250 | 250 | 250 | 250 | 250 |
| 2037 | 250 | 250 | 250 | 250 | 250 | 250 | 250 | 250 | 250 | 250 | 250 |
| 2038 | 250 | 250 | 250 | 250 | 250 | 250 | 250 | 250 | 250 | 250 | 250 |
| 2039 | 250 | 250 | 250 | 250 | 250 | 250 | 250 | 250 | 250 | 250 | 250 |
| 2040 | 250 | 250 | 250 | 250 | 250 | 250 | 250 | 250 | 250 | 250 | 250 |
| 2041 | 250 | 250 | 250 | 250 | 250 | 250 | 250 | 250 | 250 | 250 | 250 |
| 2042 | 250 | 250 | 250 | 250 | 250 | 250 | 250 | 250 | 250 | 250 | 250 |
| 2043 | 250 | 250 | 250 | 250 | 250 | 250 | 250 | 250 | 250 | 250 | 250 |
| 2044 | 250 | 250 | 250 | 222 | 250 | 250 | 250 | 250 | 250 | 250 | 250 |
| 2045 | 250 | 250 | 250 | 211 | 250 | 250 | 250 | 250 | 250 | 250 | 250 |
| 2046 | 250 | 250 | 250 | 162 | 250 | 250 | 250 | 250 | 250 | 250 | 250 |
| 2047 | 250 | 250 | 250 | 82  | 250 | 250 | 250 | 250 | 250 | 250 | 250 |
| 2048 | 250 | 250 | 250 | 38  | 250 | 248 | 250 | 250 | 250 | 250 | 250 |
| 2049 | 231 | 231 | 250 | 21  | 223 | 205 | 231 | 231 | 231 | 250 | 250 |
| 2050 | 151 | 151 | 250 | 10  | 157 | 127 | 151 | 151 | 151 | 250 | 250 |
| 2051 | 92  | 92  | 250 | 0   | 93  | 58  | 92  | 92  | 92  | 250 | 250 |
| 2052 | 49  | 49  | 250 | 0   | 49  | 42  | 49  | 49  | 49  | 226 | 227 |
| 2053 | 38  | 38  | 250 | 0   | 38  | 38  | 38  | 38  | 38  | 201 | 158 |
| 2054 | 20  | 20  | 217 | 0   | 20  | 20  | 20  | 20  | 20  | 139 | 127 |
| 2055 | 9   | 9   | 158 | 0   | 0   | 9   | 9   | 9   | 9   | 82  | 84  |
| 2056 | 0   | 0   | 99  | 0   | 0   | 0   | 0   | 0   | 0   | 64  | 27  |
| 2057 | 0   | 0   | 57  | 0   | 0   | 0   | 0   | 0   | 0   | 15  | 27  |
| 2058 | 0   | 0   | 45  | 0   | 0   | 0   | 0   | 0   | 0   | 14  | 0   |
| 2059 | 0   | 0   | 23  | 0   | 0   | 0   | 0   | 0   | 0   | 0   | 0   |

|      | 100 | 101 | 102 | 103 | 104 | 105 | 106 | 107 | 108 | 109 | 110 |
|------|-----|-----|-----|-----|-----|-----|-----|-----|-----|-----|-----|
| 2060 | 0   | 0   | 16  | 0   | 0   | 0   | 0   | 0   | 0   | 0   | 0   |
| 2061 | 0   | 0   | 7   | 0   | 0   | 0   | 0   | 0   | 0   | 0   | 0   |
| 2062 | 0   | 0   | 0   | 0   | 0   | 0   | 0   | 0   | 0   | 0   | 0   |
| 2063 | 0   | 0   | 0   | 0   | 0   | 0   | 0   | 0   | 0   | 0   | 0   |
| 2064 | 0   | 0   | 0   | 0   | 0   | 0   | 0   | 0   | 0   | 0   | 0   |
| 2065 | 0   | 0   | 0   | 0   | 0   | 0   | 0   | 0   | 0   | 0   | 0   |
| 2066 | 0   | 0   | 0   | 0   | 0   | 0   | 0   | 0   | 0   | 0   | 0   |
| 2067 | 0   | 0   | 0   | 0   | 0   | 0   | 0   | 0   | 0   | 0   | 0   |
| 2068 | 0   | 0   | 0   | 0   | 0   | 0   | 0   | 0   | 0   | 0   | 0   |
| 2069 | 0   | 0   | 0   | 0   | 0   | 0   | 0   | 0   | 0   | 0   | 0   |
| 2070 | 0   | 0   | 0   | 0   | 0   | 0   | 0   | 0   | 0   | 0   | 0   |
| 2071 | 0   | 0   | 0   | 0   | 0   | 0   | 0   | 0   | 0   | 0   | 0   |
| 2072 | 0   | 0   | 0   | 0   | 0   | 0   | 0   | 0   | 0   | 0   | 0   |
| 2073 | 0   | 0   | 0   | 0   | 0   | 0   | 0   | 0   | 0   | 0   | 0   |
| 2074 | 0   | 0   | 0   | 0   | 0   | 0   | 0   | 0   | 0   | 0   | 0   |
| 2075 | 0   | 0   | 0   | 0   | 0   | 0   | 0   | 0   | 0   | 0   | 0   |
| 2076 | 0   | 0   | 0   | 0   | 0   | 0   | 0   | 0   | 0   | 0   | 0   |
| 2077 | 0   | 0   | 0   | 0   | 0   | 0   | 0   | 0   | 0   | 0   | 0   |
| 2078 | 0   | 0   | 0   | 0   | 0   | 0   | 0   | 0   | 0   | 0   | 0   |
| 2079 | 0   | 0   | 0   | 0   | 0   | 0   | 0   | 0   | 0   | 0   | 0   |
| 2080 | 0   | 0   | 0   | 0   | 0   | 0   | 0   | 0   | 0   | 0   | 0   |
| 2081 | 0   | 0   | 0   | 0   | 0   | 0   | 0   | 0   | 0   | 0   | 0   |
| 2082 | 0   | 0   | 0   | 0   | 0   | 0   | 0   | 0   | 0   | 0   | 0   |
| 2083 | 0   | 0   | 0   | 0   | 0   | 0   | 0   | 0   | 0   | 0   | 0   |
| 2084 | 0   | 0   | 0   | 0   | 0   | 0   | 0   | 0   | 0   | 0   | 0   |
| 2085 | 0   | 0   | 0   | 0   | 0   | 0   | 0   | 0   | 0   | 0   | 0   |
| 2086 | 0   | 0   | 0   | 0   | 0   | 0   | 0   | 0   | 0   | 0   | 0   |
| 2087 | 0   | 0   | 0   | 0   | 0   | 0   | 0   | 0   | 0   | 0   | 0   |
| 2088 | 0   | 0   | 0   | 0   | 0   | 0   | 0   | 0   | 0   | 0   | 0   |
| 2089 | 0   | 0   | 0   | 0   | 0   | 0   | 0   | 0   | 0   | 0   | 0   |
| 2090 | 0   | 0   | 0   | 0   | 0   | 0   | 0   | 0   | 0   | 0   | 0   |

|      | 111 | 112 | 113 | 114 | 115 | 116 | 117 | 118 | 119 | 120 | 121 |
|------|-----|-----|-----|-----|-----|-----|-----|-----|-----|-----|-----|
| 2002 | 0   | 0   | 0   | 0   | 0   | 0   | 0   | 0   | 0   | 0   | 0   |
| 2003 | 0   | 0   | 0   | 0   | 0   | 0   | 0   | 0   | 0   | 0   | 0   |
| 2004 | 0   | 0   | 0   | 0   | 0   | 0   | 0   | 0   | 0   | 0   | 0   |
| 2005 | 0   | 0   | 0   | 0   | 0   | 0   | 0   | 0   | 0   | 0   | 0   |
| 2006 | 0   | 0   | 0   | 0   | 0   | 0   | 0   | 0   | 0   | 0   | 0   |
| 2007 | 0   | 0   | 0   | 0   | 0   | 0   | 0   | 0   | 0   | 0   | 0   |
| 2008 | 0   | 0   | 0   | 0   | 0   | 0   | 0   | 0   | 0   | 0   | 0   |
| 2009 | 0   | 0   | 0   | 0   | 0   | 0   | 0   | 0   | 0   | 0   | 0   |
| 2010 | 0   | 0   | 0   | 0   | 0   | 0   | 0   | 0   | 0   | 0   | 0   |
| 2011 | 0   | 0   | 0   | 0   | 0   | 0   | 0   | 0   | 0   | 0   | 0   |
| 2012 | 0   | 0   | 0   | 0   | 0   | 0   | 0   | 0   | 0   | 0   | 0   |
| 2013 | 0   | 0   | 0   | 0   | 0   | 0   | 0   | 0   | 0   | 0   | 0   |
| 2014 | 0   | 0   | 0   | 0   | 0   | 0   | 0   | 0   | 0   | 0   | 0   |
| 2015 | 0   | 0   | 0   | 0   | 0   | 0   | 0   | 0   | 0   | 0   | 0   |
| 2016 | 0   | 0   | 0   | 0   | 0   | 0   | 0   | 0   | 0   | 0   | 0   |
| 2017 | 0   | 0   | 0   | 0   | 0   | 0   | 0   | 0   | 0   | 0   | 0   |
| 2018 | 0   | 0   | 0   | 0   | 0   | 0   | 0   | 0   | 0   | 0   | 0   |
| 2019 | 0   | 0   | 0   | 0   | 0   | 0   | 0   | 0   | 0   | 0   | 0   |
| 2020 | 0   | 250 | 0   | 0   | 0   | 0   | 0   | 0   | 0   | 0   | 250 |
| 2021 | 0   | 250 | 0   | 0   | 0   | 0   | 0   | 0   | 0   | 0   | 250 |
| 2022 | 0   | 250 | 0   | 0   | 0   | 0   | 0   | 0   | 0   | 0   | 250 |
| 2023 | 0   | 250 | 0   | 0   | 0   | 0   | 0   | 0   | 0   | 0   | 250 |
| 2024 | 0   | 250 | 0   | 0   | 0   | 0   | 0   | 0   | 0   | 0   | 250 |
| 2025 | 0   | 250 | 250 | 250 | 250 | 250 | 250 | 250 | 250 | 0   | 250 |
| 2026 | 0   | 250 | 250 | 250 | 250 | 250 | 250 | 250 | 250 | 0   | 250 |
| 2027 | 0   | 250 | 250 | 250 | 250 | 250 | 250 | 250 | 250 | 0   | 250 |
| 2028 | 0   | 250 | 250 | 250 | 250 | 250 | 250 | 250 | 250 | 0   | 250 |
| 2029 | 0   | 250 | 250 | 250 | 250 | 250 | 250 | 250 | 250 | 0   | 250 |
| 2030 | 250 | 250 | 250 | 250 | 250 | 250 | 250 | 250 | 250 | 250 | 250 |
| 2031 | 250 | 250 | 250 | 250 | 250 | 250 | 250 | 250 | 250 | 250 | 250 |
| 2032 | 250 | 250 | 250 | 250 | 250 | 250 | 250 | 250 | 250 | 250 | 250 |
| 2033 | 250 | 250 | 250 | 250 | 250 | 250 | 250 | 250 | 250 | 250 | 250 |
| 2034 | 250 | 250 | 250 | 250 | 250 | 250 | 250 | 250 | 250 | 250 | 250 |
| 2035 | 250 | 250 | 250 | 250 | 250 | 250 | 250 | 250 | 250 | 250 | 250 |
| 2036 | 250 | 250 | 250 | 250 | 250 | 250 | 250 | 250 | 250 | 250 | 250 |
| 2037 | 250 | 250 | 250 | 250 | 250 | 250 | 250 | 250 | 250 | 250 | 250 |
| 2038 | 250 | 250 | 250 | 250 | 250 | 250 | 250 | 250 | 250 | 250 | 250 |
| 2039 | 250 | 250 | 250 | 250 | 250 | 250 | 250 | 250 | 250 | 250 | 250 |
| 2040 | 250 | 250 | 250 | 250 | 250 | 250 | 250 | 250 | 250 | 250 | 250 |
| 2041 | 250 | 250 | 250 | 250 | 250 | 250 | 250 | 250 | 250 | 250 | 250 |
| 2042 | 250 | 250 | 250 | 250 | 250 | 250 | 250 | 250 | 250 | 250 | 250 |
| 2043 | 250 | 250 | 250 | 250 | 250 | 250 | 250 | 250 | 250 | 250 | 250 |
| 2044 | 250 | 250 | 250 | 250 | 250 | 250 | 250 | 250 | 250 | 250 | 250 |
| 2045 | 250 | 250 | 250 | 250 | 250 | 250 | 250 | 250 | 250 | 250 | 250 |
| 2046 | 250 | 250 | 250 | 250 | 250 | 250 | 250 | 250 | 250 | 250 | 250 |
| 2047 | 250 | 234 | 250 | 250 | 250 | 250 | 250 | 250 | 250 | 250 | 250 |
| 2048 | 250 | 111 | 250 | 250 | 250 | 250 | 250 | 250 | 250 | 250 | 250 |
| 2049 | 250 | 55  | 250 | 250 | 250 | 250 | 250 | 250 | 250 | 250 | 250 |
| 2050 | 250 | 28  | 250 | 250 | 250 | 250 | 250 | 250 | 250 | 250 | 250 |
| 2051 | 250 | 10  | 250 | 250 | 250 | 250 | 250 | 250 | 250 | 250 | 228 |
| 2052 | 250 | 10  | 246 | 238 | 227 | 227 | 227 | 250 | 250 | 250 | 170 |
| 2053 | 250 | 0   | 217 | 184 | 199 | 199 | 199 | 250 | 250 | 250 | 79  |
| 2054 | 250 | 0   | 177 | 128 | 146 | 146 | 146 | 250 | 250 | 250 | 46  |
| 2055 | 250 | 0   | 99  | 91  | 92  | 92  | 92  | 242 | 207 | 250 | 24  |
| 2056 | 250 | 0   | 63  | 49  | 49  | 49  | 49  | 169 | 149 | 250 | 10  |
| 2057 | 250 | 0   | 19  | 19  | 21  | 21  | 21  | 95  | 82  | 250 | 6   |
| 2058 | 218 | 0   | 14  | 11  | 13  | 13  | 13  | 50  | 53  | 249 | 6   |
| 2059 | 187 | 0   | 0   | 8   | 8   | 8   | 8   | 42  | 34  | 186 | 0   |

|      | 111 | 112 | 113 | 114 | 115 | 116 | 117 | 118 | 119 | 120 | 121 |
|------|-----|-----|-----|-----|-----|-----|-----|-----|-----|-----|-----|
| 2060 | 134 | 0   | 0   | 0   | 0   | 0   | 0   | 19  | 18  | 126 | 0   |
| 2061 | 96  | 0   | 0   | 0   | 0   | 0   | 0   | 0   | 8   | 68  | 0   |
| 2062 | 65  | 0   | 0   | 0   | 0   | 0   | 0   | 0   | 0   | 46  | 0   |
| 2063 | 21  | 0   | 0   | 0   | 0   | 0   | 0   | 0   | 0   | 42  | 0   |
| 2064 | 11  | 0   | 0   | 0   | 0   | 0   | 0   | 0   | 0   | 42  | 0   |
| 2065 | 0   | 0   | 0   | 0   | 0   | 0   | 0   | 0   | 0   | 16  | 0   |
| 2066 | 0   | 0   | 0   | 0   | 0   | 0   | 0   | 0   | 0   | 0   | 0   |
| 2067 | 0   | 0   | 0   | 0   | 0   | 0   | 0   | 0   | 0   | 0   | 0   |
| 2068 | 0   | 0   | 0   | 0   | 0   | 0   | 0   | 0   | 0   | 0   | 0   |
| 2069 | 0   | 0   | 0   | 0   | 0   | 0   | 0   | 0   | 0   | 0   | 0   |
| 2070 | 0   | 0   | 0   | 0   | 0   | 0   | 0   | 0   | 0   | 0   | 0   |
| 2071 | 0   | 0   | 0   | 0   | 0   | 0   | 0   | 0   | 0   | 0   | 0   |
| 2072 | 0   | 0   | 0   | 0   | 0   | 0   | 0   | 0   | 0   | 0   | 0   |
| 2073 | 0   | 0   | 0   | 0   | 0   | 0   | 0   | 0   | 0   | 0   | 0   |
| 2074 | 0   | 0   | 0   | 0   | 0   | 0   | 0   | 0   | 0   | 0   | 0   |
| 2075 | 0   | 0   | 0   | 0   | 0   | 0   | 0   | 0   | 0   | 0   | 0   |
| 2076 | 0   | 0   | 0   | 0   | 0   | 0   | 0   | 0   | 0   | 0   | 0   |
| 2077 | 0   | 0   | 0   | 0   | 0   | 0   | 0   | 0   | 0   | 0   | 0   |
| 2078 | 0   | 0   | 0   | 0   | 0   | 0   | 0   | 0   | 0   | 0   | 0   |
| 2079 | 0   | 0   | 0   | 0   | 0   | 0   | 0   | 0   | 0   | 0   | 0   |
| 2080 | 0   | 0   | 0   | 0   | 0   | 0   | 0   | 0   | 0   | 0   | 0   |
| 2081 | 0   | 0   | 0   | 0   | 0   | 0   | 0   | 0   | 0   | 0   | 0   |
| 2082 | 0   | 0   | 0   | 0   | 0   | 0   | 0   | 0   | 0   | 0   | 0   |
| 2083 | 0   | 0   | 0   | 0   | 0   | 0   | 0   | 0   | 0   | 0   | 0   |
| 2084 | 0   | 0   | 0   | 0   | 0   | 0   | 0   | 0   | 0   | 0   | 0   |
| 2085 | 0   | 0   | 0   | 0   | 0   | 0   | 0   | 0   | 0   | 0   | 0   |
| 2086 | 0   | 0   | 0   | 0   | 0   | 0   | 0   | 0   | 0   | 0   | 0   |
| 2087 | 0   | 0   | 0   | 0   | 0   | 0   | 0   | 0   | 0   | 0   | 0   |
| 2088 | 0   | 0   | 0   | 0   | 0   | 0   | 0   | 0   | 0   | 0   | 0   |
| 2089 | 0   | 0   | 0   | 0   | 0   | 0   | 0   | 0   | 0   | 0   | 0   |
| 2090 | 0   | 0   | 0   | 0   | 0   | 0   | 0   | 0   | 0   | 0   | 0   |

|      | 122 | 123 | 124 | 125 | 126 | 127 | 128 | 129 | 130 | 131 | 132 |
|------|-----|-----|-----|-----|-----|-----|-----|-----|-----|-----|-----|
| 2002 | 0   | 0   | 0   | 0   | 0   | 0   | 0   | 0   | 0   | 0   | 0   |
| 2003 | 0   | 0   | 0   | 0   | 0   | 0   | 0   | 0   | 0   | 0   | 0   |
| 2004 | 0   | 0   | 0   | 0   | 0   | 0   | 0   | 0   | 0   | 0   | 0   |
| 2005 | 0   | 0   | 0   | 0   | 0   | 0   | 0   | 0   | 0   | 0   | 0   |
| 2006 | 0   | 0   | 0   | 0   | 0   | 0   | 0   | 0   | 0   | 0   | 0   |
| 2007 | 0   | 0   | 0   | 0   | 0   | 0   | 0   | 0   | 0   | 0   | 0   |
| 2008 | 0   | 0   | 0   | 0   | 0   | 0   | 0   | 0   | 0   | 0   | 0   |
| 2009 | 0   | 0   | 0   | 0   | 0   | 0   | 0   | 0   | 0   | 0   | 0   |
| 2010 | 0   | 0   | 0   | 0   | 0   | 0   | 0   | 0   | 0   | 0   | 0   |
| 2011 | 0   | 0   | 0   | 0   | 0   | 0   | 0   | 0   | 0   | 0   | 0   |
| 2012 | 0   | 0   | 0   | 0   | 0   | 0   | 0   | 0   | 0   | 0   | 0   |
| 2013 | 0   | 0   | 0   | 0   | 0   | 0   | 0   | 0   | 0   | 0   | 0   |
| 2014 | 0   | 0   | 0   | 0   | 0   | 0   | 0   | 0   | 0   | 0   | 0   |
| 2015 | 0   | 0   | 0   | 0   | 0   | 0   | 0   | 0   | 0   | 0   | 0   |
| 2016 | 0   | 0   | 0   | 0   | 0   | 0   | 0   | 0   | 0   | 0   | 0   |
| 2017 | 0   | 0   | 0   | 0   | 0   | 0   | 0   | 0   | 0   | 0   | 0   |
| 2018 | 0   | 0   | 0   | 0   | 0   | 0   | 0   | 0   | 0   | 0   | 0   |
| 2019 | 0   | 0   | 0   | 0   | 0   | 0   | 0   | 0   | 0   | 0   | 0   |
| 2020 | 0   | 0   | 0   | 0   | 0   | 0   | 0   | 0   | 250 | 0   | 0   |
| 2021 | 0   | 0   | 0   | 0   | 0   | 0   | 0   | 0   | 250 | 0   | 0   |
| 2022 | 0   | 0   | 0   | 0   | 0   | 0   | 0   | 0   | 250 | 0   | 0   |
| 2023 | 0   | 0   | 0   | 0   | 0   | 0   | 0   | 0   | 250 | 0   | 0   |
| 2024 | 0   | 0   | 0   | 0   | 0   | 0   | 0   | 0   | 250 | 0   | 0   |
| 2025 | 250 | 250 | 250 | 250 | 250 | 250 | 250 | 0   | 250 | 250 | 250 |
| 2026 | 250 | 250 | 250 | 250 | 250 | 250 | 250 | 0   | 250 | 250 | 250 |
| 2027 | 250 | 250 | 250 | 250 | 250 | 250 | 250 | 0   | 250 | 250 | 250 |
| 2028 | 250 | 250 | 250 | 250 | 250 | 250 | 250 | 0   | 250 | 250 | 250 |
| 2029 | 250 | 250 | 250 | 250 | 250 | 250 | 250 | 0   | 250 | 250 | 250 |
| 2030 | 250 | 250 | 250 | 250 | 250 | 250 | 250 | 250 | 250 | 250 | 250 |
| 2031 | 250 | 250 | 250 | 250 | 250 | 250 | 250 | 250 | 250 | 250 | 250 |
| 2032 | 250 | 250 | 250 | 250 | 250 | 250 | 250 | 250 | 250 | 250 | 250 |
| 2033 | 250 | 250 | 250 | 250 | 250 | 250 | 250 | 250 | 250 | 250 | 250 |
| 2034 | 250 | 250 | 250 | 250 | 250 | 250 | 250 | 250 | 250 | 250 | 250 |
| 2035 | 250 | 250 | 250 | 250 | 250 | 250 | 250 | 250 | 250 | 250 | 250 |
| 2036 | 250 | 250 | 250 | 250 | 250 | 250 | 250 | 250 | 250 | 250 | 250 |
| 2037 | 250 | 250 | 250 | 250 | 250 | 250 | 250 | 250 | 250 | 250 | 250 |
| 2038 | 250 | 250 | 250 | 250 | 250 | 250 | 250 | 250 | 250 | 250 | 250 |
| 2039 | 250 | 250 | 250 | 250 | 250 | 250 | 250 | 250 | 250 | 250 | 250 |
| 2040 | 250 | 250 | 250 | 250 | 250 | 250 | 250 | 250 | 250 | 250 | 250 |
| 2041 | 250 | 250 | 250 | 250 | 250 | 250 | 250 | 250 | 250 | 250 | 250 |
| 2042 | 250 | 250 | 250 | 250 | 250 | 250 | 250 | 250 | 250 | 250 | 250 |
| 2043 | 250 | 250 | 250 | 250 | 250 | 250 | 250 | 250 | 250 | 250 | 250 |
| 2044 | 250 | 250 | 250 | 250 | 250 | 250 | 250 | 250 | 250 | 250 | 250 |
| 2045 | 250 | 250 | 250 | 250 | 250 | 250 | 250 | 250 | 250 | 250 | 250 |
| 2046 | 250 | 250 | 250 | 250 | 250 | 250 | 250 | 250 | 250 | 250 | 250 |
| 2047 | 250 | 250 | 250 | 250 | 250 | 250 | 250 | 250 | 250 | 250 | 250 |
| 2048 | 250 | 250 | 250 | 250 | 250 | 250 | 250 | 250 | 243 | 250 | 250 |
| 2049 | 250 | 250 | 250 | 250 | 250 | 250 | 250 | 250 | 177 | 250 | 250 |
| 2050 | 250 | 250 | 250 | 250 | 250 | 250 | 250 | 250 | 93  | 250 | 250 |
| 2051 | 250 | 250 | 250 | 250 | 250 | 250 | 250 | 250 | 48  | 250 | 250 |
| 2052 | 250 | 250 | 250 | 250 | 250 | 250 | 250 | 250 | 27  | 250 | 250 |
| 2053 | 250 | 250 | 250 | 250 | 250 | 250 | 241 | 250 | 12  | 250 | 217 |
| 2054 | 250 | 200 | 250 | 250 | 250 | 226 | 183 | 250 | 8   | 248 | 135 |
| 2055 | 218 | 131 | 234 | 234 | 234 | 117 | 115 | 250 | 0   | 202 | 81  |
| 2056 | 136 | 73  | 159 | 159 | 159 | 73  | 70  | 250 | 0   | 119 | 41  |
| 2057 | 83  | 36  | 89  | 89  | 89  | 49  | 39  | 250 | 0   | 71  | 20  |
| 2058 | 46  | 18  | 47  | 47  | 47  | 19  | 18  | 250 | 0   | 36  | 8   |
| 2059 | 23  | 3   | 36  | 36  | 36  | 0   | 0   | 236 | 0   | 15  | 5   |

|      | 122 | 123 | 124 | 125 | 126 | 127 | 128 | 129 | 130 | 131 | 132 |
|------|-----|-----|-----|-----|-----|-----|-----|-----|-----|-----|-----|
| 2060 | 13  | 0   | 15  | 15  | 15  | 0   | 0   | 142 | 0   | 3   | 4   |
| 2061 | 0   | 0   | 3   | 3   | 3   | 0   | 0   | 85  | 0   | 1   | 0   |
| 2062 | 0   | 0   | 1   | 1   | 1   | 0   | 0   | 61  | 0   | 1   | 0   |
| 2063 | 0   | 0   | 1   | 1   | 1   | 0   | 0   | 46  | 0   | 1   | 0   |
| 2064 | 0   | 0   | 1   | 1   | 1   | 0   | 0   | 42  | 0   | 1   | 0   |
| 2065 | 0   | 0   | 1   | 1   | 1   | 0   | 0   | 18  | 0   | 1   | 0   |
| 2066 | 0   | 0   | 1   | 1   | 1   | 0   | 0   | 0   | 0   | 1   | 0   |
| 2067 | 0   | 0   | 1   | 1   | 1   | 0   | 0   | 0   | 0   | 1   | 0   |
| 2068 | 0   | 0   | 1   | 1   | 1   | 0   | 0   | 0   | 0   | 1   | 0   |
| 2069 | 0   | 0   | 1   | 1   | 1   | 0   | 0   | 0   | 0   | 1   | 0   |
| 2070 | 0   | 0   | 1   | 1   | 1   | 0   | 0   | 0   | 0   | 1   | 0   |
| 2071 | 0   | 0   | 1   | 1   | 1   | 0   | 0   | 0   | 0   | 1   | 0   |
| 2072 | 0   | 0   | 1   | 1   | 1   | 0   | 0   | 0   | 0   | 1   | 0   |
| 2073 | 0   | 0   | 1   | 1   | 1   | 0   | 0   | 0   | 0   | 1   | 0   |
| 2074 | 0   | 0   | 1   | 1   | 1   | 0   | 0   | 0   | 0   | 1   | 0   |
| 2075 | 0   | 0   | 1   | 1   | 1   | 0   | 0   | 0   | 0   | 1   | 0   |
| 2076 | 0   | 0   | 1   | 1   | 1   | 0   | 0   | 0   | 0   | 1   | 0   |
| 2077 | 0   | 0   | 1   | 1   | 1   | 0   | 0   | 0   | 0   | 1   | 0   |
| 2078 | 0   | 0   | 1   | 1   | 1   | 0   | 0   | 0   | 0   | 1   | 0   |
| 2079 | 0   | 0   | 1   | 1   | 1   | 0   | 0   | 0   | 0   | 1   | 0   |
| 2080 | 0   | 0   | 1   | 1   | 1   | 0   | 0   | 0   | 0   | 1   | 0   |
| 2081 | 0   | 0   | 1   | 1   | 1   | 0   | 0   | 0   | 0   | 1   | 0   |
| 2082 | 0   | 0   | 1   | 1   | 1   | 0   | 0   | 0   | 0   | 1   | 0   |
| 2083 | 0   | 0   | 1   | 1   | 1   | 0   | 0   | 0   | 0   | 1   | 0   |
| 2084 | 0   | 0   | 1   | 1   | 1   | 0   | 0   | 0   | 0   | 1   | 0   |
| 2085 | 0   | 0   | 1   | 1   | 1   | 0   | 0   | 0   | 0   | 1   | 0   |
| 2086 | 0   | 0   | 1   | 1   | 1   | 0   | 0   | 0   | 0   | 1   | 0   |
| 2087 | 0   | 0   | 1   | 1   | 1   | 0   | 0   | 0   | 0   | 1   | 0   |
| 2088 | 0   | 0   | 1   | 1   | 1   | 0   | 0   | 0   | 0   | 1   | 0   |
| 2089 | 0   | 0   | 1   | 1   | 1   | 0   | 0   | 0   | 0   | 1   | 0   |
| 2090 | 0   | 0   | 1   | 1   | 1   | 0   | 0   | 0   | 0   | 1   | 0   |

|      | 133 | 134 | 135 | 136 | 137 | 138 | 139 | 140 | 141 | 142 | 143 |
|------|-----|-----|-----|-----|-----|-----|-----|-----|-----|-----|-----|
| 2002 | 0   | 0   | 0   | 0   | 0   | 0   | 0   | 0   | 0   | 0   | 0   |
| 2003 | 0   | 0   | 0   | 0   | 0   | 0   | 0   | 0   | 0   | 0   | 0   |
| 2004 | 0   | 0   | 0   | 0   | 0   | 0   | 0   | 0   | 0   | 0   | 0   |
| 2005 | 0   | 0   | 0   | 0   | 0   | 0   | 0   | 0   | 0   | 0   | 0   |
| 2006 | 0   | 0   | 0   | 0   | 0   | 0   | 0   | 0   | 0   | 0   | 0   |
| 2007 | 0   | 0   | 0   | 0   | 0   | 0   | 0   | 0   | 0   | 0   | 0   |
| 2008 | 0   | 0   | 0   | 0   | 0   | 0   | 0   | 0   | 0   | 0   | 0   |
| 2009 | 0   | 0   | 0   | 0   | 0   | 0   | 0   | 0   | 0   | 0   | 0   |
| 2010 | 0   | 0   | 0   | 0   | 0   | 0   | 0   | 0   | 0   | 0   | 0   |
| 2011 | 0   | 0   | 0   | 0   | 0   | 0   | 0   | 0   | 0   | 0   | 0   |
| 2012 | 0   | 0   | 0   | 0   | 0   | 0   | 0   | 0   | 0   | 0   | 0   |
| 2013 | 0   | 0   | 0   | 0   | 0   | 0   | 0   | 0   | 0   | 0   | 0   |
| 2014 | 0   | 0   | 0   | 0   | 0   | 0   | 0   | 0   | 0   | 0   | 0   |
| 2015 | 0   | 0   | 0   | 0   | 0   | 0   | 0   | 0   | 0   | 0   | 0   |
| 2016 | 0   | 0   | 0   | 0   | 0   | 0   | 0   | 0   | 0   | 0   | 0   |
| 2017 | 0   | 0   | 0   | 0   | 0   | 0   | 0   | 0   | 0   | 0   | 0   |
| 2018 | 0   | 0   | 0   | 0   | 0   | 0   | 0   | 0   | 0   | 0   | 0   |
| 2019 | 0   | 0   | 0   | 0   | 0   | 0   | 0   | 0   | 0   | 0   | 0   |
| 2020 | 0   | 0   | 0   | 0   | 0   | 0   | 250 | 0   | 0   | 0   | 0   |
| 2021 | 0   | 0   | 0   | 0   | 0   | 0   | 250 | 0   | 0   | 0   | 0   |
| 2022 | 0   | 0   | 0   | 0   | 0   | 0   | 250 | 0   | 0   | 0   | 0   |
| 2023 | 0   | 0   | 0   | 0   | 0   | 0   | 250 | 0   | 0   | 0   | 0   |
| 2024 | 0   | 0   | 0   | 0   | 0   | 0   | 250 | 0   | 0   | 0   | 0   |
| 2025 | 250 | 250 | 250 | 250 | 250 | 0   | 250 | 250 | 250 | 250 | 250 |
| 2026 | 250 | 250 | 250 | 250 | 250 | 0   | 250 | 250 | 250 | 250 | 250 |
| 2027 | 250 | 250 | 250 | 250 | 250 | 0   | 250 | 250 | 250 | 250 | 250 |
| 2028 | 250 | 250 | 250 | 250 | 250 | 0   | 250 | 250 | 250 | 250 | 250 |
| 2029 | 250 | 250 | 250 | 250 | 250 | 0   | 250 | 250 | 250 | 250 | 250 |
| 2030 | 250 | 250 | 250 | 250 | 250 | 250 | 250 | 250 | 250 | 250 | 250 |
| 2031 | 250 | 250 | 250 | 250 | 250 | 250 | 250 | 250 | 250 | 250 | 250 |
| 2032 | 250 | 250 | 250 | 250 | 250 | 250 | 250 | 250 | 250 | 250 | 250 |
| 2033 | 250 | 250 | 250 | 250 | 250 | 250 | 250 | 250 | 250 | 250 | 250 |
| 2034 | 250 | 250 | 250 | 250 | 250 | 250 | 250 | 250 | 250 | 250 | 250 |
| 2035 | 250 | 250 | 250 | 250 | 250 | 250 | 250 | 250 | 250 | 250 | 250 |
| 2036 | 250 | 250 | 250 | 250 | 250 | 250 | 250 | 250 | 250 | 250 | 250 |
| 2037 | 250 | 250 | 250 | 250 | 250 | 250 | 250 | 250 | 250 | 250 | 250 |
| 2038 | 250 | 250 | 250 | 250 | 250 | 250 | 250 | 250 | 250 | 250 | 250 |
| 2039 | 250 | 250 | 250 | 250 | 250 | 250 | 250 | 250 | 250 | 250 | 250 |
| 2040 | 250 | 250 | 250 | 250 | 250 | 250 | 250 | 250 | 250 | 250 | 250 |
| 2041 | 250 | 250 | 250 | 250 | 250 | 250 | 250 | 250 | 250 | 250 | 250 |
| 2042 | 250 | 250 | 250 | 250 | 250 | 250 | 250 | 250 | 250 | 250 | 250 |
| 2043 | 250 | 250 | 250 | 250 | 250 | 250 | 240 | 250 | 250 | 250 | 250 |
| 2044 | 250 | 250 | 250 | 250 | 250 | 250 | 229 | 250 | 250 | 250 | 250 |
| 2045 | 250 | 250 | 250 | 250 | 250 | 250 | 146 | 250 | 250 | 250 | 250 |
| 2046 | 250 | 250 | 250 | 250 | 250 | 250 | 112 | 250 | 250 | 250 | 250 |
| 2047 | 250 | 250 | 250 | 250 | 250 | 250 | 61  | 250 | 250 | 250 | 250 |
| 2048 | 250 | 250 | 250 | 236 | 238 | 250 | 26  | 234 | 250 | 234 | 234 |
| 2049 | 250 | 250 | 250 | 187 | 177 | 250 | 21  | 182 | 218 | 172 | 172 |
| 2050 | 250 | 250 | 250 | 141 | 114 | 250 | 0   | 123 | 154 | 123 | 123 |
| 2051 | 250 | 250 | 250 | 93  | 89  | 250 | 0   | 95  | 104 | 95  | 95  |
| 2052 | 250 | 250 | 250 | 68  | 53  | 250 | 0   | 67  | 94  | 67  | 67  |
| 2053 | 250 | 250 | 250 | 24  | 23  | 250 | 0   | 36  | 52  | 21  | 21  |
| 2054 | 201 | 201 | 201 | 18  | 22  | 190 | 0   | 19  | 16  | 16  | 16  |
| 2055 | 104 | 104 | 104 | 6   | 1   | 169 | 0   | 7   | 14  | 5   | 5   |
| 2056 | 64  | 64  | 64  | 6   | 0   | 155 | 0   | 5   | 0   | 0   | 0   |
| 2057 | 36  | 36  | 36  | 0   | 0   | 119 | 0   | 2   | 0   | 0   | 0   |
| 2058 | 15  | 15  | 15  | 0   | 0   | 83  | 0   | 0   | 0   | 0   | 0   |
| 2059 | 0   | 0   | 0   | 0   | 0   | 64  | 0   | 0   | 0   | 0   | 0   |

|      | 133 | 134 | 135 | 136 | 137 | 138 | 139 | 140 | 141 | 142 | 143 |
|------|-----|-----|-----|-----|-----|-----|-----|-----|-----|-----|-----|
| 2060 | 0   | 0   | 0   | 0   | 0   | 44  | 0   | 0   | 0   | 0   | 0   |
| 2061 | 0   | 0   | 0   | 0   | 0   | 11  | 0   | 0   | 0   | 0   | 0   |
| 2062 | 0   | 0   | 0   | 0   | 0   | 0   | 0   | 0   | 0   | 0   | 0   |
| 2063 | 0   | 0   | 0   | 0   | 0   | 0   | 0   | 0   | 0   | 0   | 0   |
| 2064 | 0   | 0   | 0   | 0   | 0   | 0   | 0   | 0   | 0   | 0   | 0   |
| 2065 | 0   | 0   | 0   | 0   | 0   | 0   | 0   | 0   | 0   | 0   | 0   |
| 2066 | 0   | 0   | 0   | 0   | 0   | 0   | 0   | 0   | 0   | 0   | 0   |
| 2067 | 0   | 0   | 0   | 0   | 0   | 0   | 0   | 0   | 0   | 0   | 0   |
| 2068 | 0   | 0   | 0   | 0   | 0   | 0   | 0   | 0   | 0   | 0   | 0   |
| 2069 | 0   | 0   | 0   | 0   | 0   | 0   | 0   | 0   | 0   | 0   | 0   |
| 2070 | 0   | 0   | 0   | 0   | 0   | 0   | 0   | 0   | 0   | 0   | 0   |
| 2071 | 0   | 0   | 0   | 0   | 0   | 0   | 0   | 0   | 0   | 0   | 0   |
| 2072 | 0   | 0   | 0   | 0   | 0   | 0   | 0   | 0   | 0   | 0   | 0   |
| 2073 | 0   | 0   | 0   | 0   | 0   | 0   | 0   | 0   | 0   | 0   | 0   |
| 2074 | 0   | 0   | 0   | 0   | 0   | 0   | 0   | 0   | 0   | 0   | 0   |
| 2075 | 0   | 0   | 0   | 0   | 0   | 0   | 0   | 0   | 0   | 0   | 0   |
| 2076 | 0   | 0   | 0   | 0   | 0   | 0   | 0   | 0   | 0   | 0   | 0   |
| 2077 | 0   | 0   | 0   | 0   | 0   | 0   | 0   | 0   | 0   | 0   | 0   |
| 2078 | 0   | 0   | 0   | 0   | 0   | 0   | 0   | 0   | 0   | 0   | 0   |
| 2079 | 0   | 0   | 0   | 0   | 0   | 0   | 0   | 0   | 0   | 0   | 0   |
| 2080 | 0   | 0   | 0   | 0   | 0   | 0   | 0   | 0   | 0   | 0   | 0   |
| 2081 | 0   | 0   | 0   | 0   | 0   | 0   | 0   | 0   | 0   | 0   | 0   |
| 2082 | 0   | 0   | 0   | 0   | 0   | 0   | 0   | 0   | 0   | 0   | 0   |
| 2083 | 0   | 0   | 0   | 0   | 0   | 0   | 0   | 0   | 0   | 0   | 0   |
| 2084 | 0   | 0   | 0   | 0   | 0   | 0   | 0   | 0   | 0   | 0   | 0   |
| 2085 | 0   | 0   | 0   | 0   | 0   | 0   | 0   | 0   | 0   | 0   | 0   |
| 2086 | 0   | 0   | 0   | 0   | 0   | 0   | 0   | 0   | 0   | 0   | 0   |
| 2087 | 0   | 0   | 0   | 0   | 0   | 0   | 0   | 0   | 0   | 0   | 0   |
| 2088 | 0   | 0   | 0   | 0   | 0   | 0   | 0   | 0   | 0   | 0   | 0   |
| 2089 | 0   | 0   | 0   | 0   | 0   | 0   | 0   | 0   | 0   | 0   | 0   |
| 2090 | 0   | 0   | 0   | 0   | 0   | 0   | 0   | 0   | 0   | 0   | 0   |



|      | 144 | 145 | 146 | 147 | 148 | 149 | 150 | 151 | 152 | 153 | 154 |
|------|-----|-----|-----|-----|-----|-----|-----|-----|-----|-----|-----|
| 2002 | 0   | 0   | 0   | 0   | 0   | 0   | 0   | 0   | 0   | 0   | 0   |
| 2003 | 0   | 0   | 0   | 0   | 0   | 0   | 0   | 0   | 0   | 0   | 0   |
| 2004 | 0   | 0   | 0   | 0   | 0   | 0   | 0   | 0   | 0   | 0   | 0   |
| 2005 | 0   | 0   | 0   | 0   | 0   | 0   | 0   | 0   | 0   | 0   | 0   |
| 2006 | 0   | 0   | 0   | 0   | 0   | 0   | 0   | 0   | 0   | 0   | 0   |
| 2007 | 0   | 0   | 0   | 0   | 0   | 0   | 0   | 0   | 0   | 0   | 0   |
| 2008 | 0   | 0   | 0   | 0   | 0   | 0   | 0   | 0   | 0   | 0   | 0   |
| 2009 | 0   | 0   | 0   | 0   | 0   | 0   | 0   | 0   | 0   | 0   | 0   |
| 2010 | 0   | 0   | 0   | 0   | 0   | 0   | 0   | 0   | 0   | 0   | 0   |
| 2011 | 0   | 0   | 0   | 0   | 0   | 0   | 0   | 0   | 0   | 0   | 0   |
| 2012 | 0   | 0   | 0   | 0   | 0   | 0   | 0   | 0   | 0   | 0   | 0   |
| 2013 | 0   | 0   | 0   | 0   | 0   | 0   | 0   | 0   | 0   | 0   | 0   |
| 2014 | 0   | 0   | 0   | 0   | 0   | 0   | 0   | 0   | 0   | 0   | 0   |
| 2015 | 0   | 0   | 0   | 0   | 0   | 0   | 0   | 0   | 0   | 0   | 0   |
| 2016 | 0   | 0   | 0   | 0   | 0   | 0   | 0   | 0   | 0   | 0   | 0   |
| 2017 | 0   | 0   | 0   | 0   | 0   | 0   | 0   | 0   | 0   | 0   | 0   |
| 2018 | 0   | 0   | 0   | 0   | 0   | 0   | 0   | 0   | 0   | 0   | 0   |
| 2019 | 0   | 0   | 0   | 0   | 0   | 0   | 0   | 0   | 0   | 0   | 0   |
| 2020 | 0   | 0   | 0   | 0   | 250 | 0   | 0   | 0   | 0   | 0   | 0   |
| 2021 | 0   | 0   | 0   | 0   | 250 | 0   | 0   | 0   | 0   | 0   | 0   |
| 2022 | 0   | 0   | 0   | 0   | 250 | 0   | 0   | 0   | 0   | 0   | 0   |
| 2023 | 0   | 0   | 0   | 0   | 250 | 0   | 0   | 0   | 0   | 0   | 0   |
| 2024 | 0   | 0   | 0   | 0   | 250 | 0   | 0   | 0   | 0   | 0   | 0   |
| 2025 | 250 | 250 | 250 | 0   | 250 | 250 | 250 | 250 | 250 | 250 | 250 |
| 2026 | 250 | 250 | 250 | 0   | 250 | 250 | 250 | 250 | 250 | 250 | 250 |
| 2027 | 250 | 250 | 250 | 0   | 250 | 250 | 250 | 250 | 250 | 250 | 250 |
| 2028 | 250 | 250 | 250 | 0   | 250 | 250 | 250 | 250 | 250 | 250 | 250 |
| 2029 | 250 | 250 | 250 | 0   | 250 | 250 | 250 | 250 | 250 | 250 | 250 |
| 2030 | 250 | 250 | 250 | 250 | 250 | 250 | 250 | 250 | 250 | 250 | 250 |
| 2031 | 250 | 250 | 250 | 250 | 250 | 250 | 250 | 250 | 250 | 250 | 250 |
| 2032 | 250 | 250 | 250 | 250 | 250 | 250 | 250 | 250 | 250 | 250 | 250 |
| 2033 | 250 | 250 | 250 | 250 | 250 | 250 | 250 | 250 | 250 | 250 | 250 |
| 2034 | 250 | 250 | 250 | 250 | 250 | 250 | 250 | 250 | 250 | 250 | 250 |
| 2035 | 250 | 250 | 250 | 250 | 250 | 250 | 250 | 250 | 250 | 250 | 250 |
| 2036 | 250 | 250 | 250 | 250 | 250 | 250 | 250 | 250 | 250 | 250 | 250 |
| 2037 | 250 | 250 | 250 | 250 | 250 | 250 | 250 | 250 | 250 | 250 | 250 |
| 2038 | 250 | 250 | 250 | 250 | 250 | 250 | 250 | 250 | 250 | 250 | 250 |
| 2039 | 250 | 250 | 250 | 250 | 250 | 250 | 250 | 250 | 250 | 250 | 250 |
| 2040 | 250 | 250 | 250 | 250 | 250 | 250 | 250 | 250 | 250 | 250 | 250 |
| 2041 | 250 | 250 | 250 | 250 | 250 | 250 | 250 | 250 | 250 | 250 | 250 |
| 2042 | 250 | 250 | 250 | 250 | 250 | 250 | 250 | 250 | 250 | 250 | 250 |
| 2043 | 250 | 250 | 250 | 250 | 250 | 250 | 250 | 250 | 250 | 250 | 250 |
| 2044 | 250 | 250 | 250 | 250 | 250 | 250 | 250 | 250 | 250 | 250 | 250 |
| 2045 | 250 | 250 | 250 | 250 | 250 | 250 | 250 | 250 | 250 | 250 | 250 |
| 2046 | 250 | 250 | 250 | 250 | 219 | 250 | 250 | 250 | 250 | 250 | 250 |
| 2047 | 250 | 250 | 250 | 250 | 219 | 250 | 250 | 250 | 250 | 250 | 250 |
| 2048 | 234 | 250 | 250 | 250 | 187 | 250 | 250 | 250 | 250 | 250 | 250 |
| 2049 | 172 | 250 | 250 | 250 | 100 | 250 | 250 | 250 | 250 | 250 | 245 |
| 2050 | 123 | 250 | 250 | 250 | 43  | 250 | 249 | 250 | 250 | 250 | 196 |
| 2051 | 95  | 241 | 225 | 250 | 30  | 249 | 214 | 233 | 233 | 233 | 124 |
| 2052 | 67  | 188 | 177 | 250 | 16  | 191 | 153 | 175 | 175 | 175 | 68  |
| 2053 | 21  | 117 | 118 | 250 | 4   | 119 | 80  | 102 | 102 | 102 | 49  |
| 2054 | 16  | 65  | 58  | 250 | 0   | 72  | 47  | 72  | 72  | 72  | 25  |
| 2055 | 5   | 49  | 40  | 235 | 0   | 46  | 36  | 46  | 46  | 46  | 9   |
| 2056 | 0   | 25  | 23  | 186 | 0   | 23  | 15  | 23  | 23  | 23  | 1   |
| 2057 | 0   | 9   | 18  | 125 | 0   | 13  | 0   | 13  | 13  | 13  | 1   |
| 2058 | 0   | 0   | 8   | 79  | 0   | 0   | 0   | 3   | 3   | 3   | 1   |
| 2059 | 0   | 0   | 0   | 55  | 0   | 0   | 0   | 1   | 1   | 1   | 1   |

|      | 144 | 145 | 146 | 147 | 148 | 149 | 150 | 151 | 152 | 153 | 154 |
|------|-----|-----|-----|-----|-----|-----|-----|-----|-----|-----|-----|
| 2060 | 0   | 0   | 0   | 24  | 0   | 0   | 0   | 1   | 1   | 1   | 1   |
| 2061 | 0   | 0   | 0   | 17  | 0   | 0   | 0   | 1   | 1   | 1   | 1   |
| 2062 | 0   | 0   | 0   | 11  | 0   | 0   | 0   | 1   | 1   | 1   | 1   |
| 2063 | 0   | 0   | 0   | 0   | 0   | 0   | 0   | 1   | 1   | 1   | 1   |
| 2064 | 0   | 0   | 0   | 0   | 0   | 0   | 0   | 1   | 1   | 1   | 1   |
| 2065 | 0   | 0   | 0   | 0   | 0   | 0   | 0   | 1   | 1   | 1   | 1   |
| 2066 | 0   | 0   | 0   | 0   | 0   | 0   | 0   | 1   | 1   | 1   | 1   |
| 2067 | 0   | 0   | 0   | 0   | 0   | 0   | 0   | 1   | 1   | 1   | 1   |
| 2068 | 0   | 0   | 0   | 0   | 0   | 0   | 0   | 1   | 1   | 1   | 1   |
| 2069 | 0   | 0   | 0   | 0   | 0   | 0   | 0   | 1   | 1   | 1   | 1   |
| 2070 | 0   | 0   | 0   | 0   | 0   | 0   | 0   | 1   | 1   | 1   | 1   |
| 2071 | 0   | 0   | 0   | 0   | 0   | 0   | 0   | 1   | 1   | 1   | 1   |
| 2072 | 0   | 0   | 0   | 0   | 0   | 0   | 0   | 1   | 1   | 1   | 1   |
| 2073 | 0   | 0   | 0   | 0   | 0   | 0   | 0   | 1   | 1   | 1   | 1   |
| 2074 | 0   | 0   | 0   | 0   | 0   | 0   | 0   | 1   | 1   | 1   | 1   |
| 2075 | 0   | 0   | 0   | 0   | 0   | 0   | 0   | 1   | 1   | 1   | 1   |
| 2076 | 0   | 0   | 0   | 0   | 0   | 0   | 0   | 1   | 1   | 1   | 1   |
| 2077 | 0   | 0   | 0   | 0   | 0   | 0   | 0   | 1   | 1   | 1   | 1   |
| 2078 | 0   | 0   | 0   | 0   | 0   | 0   | 0   | 1   | 1   | 1   | 1   |
| 2079 | 0   | 0   | 0   | 0   | 0   | 0   | 0   | 1   | 1   | 1   | 1   |
| 2080 | 0   | 0   | 0   | 0   | 0   | 0   | 0   | 1   | 1   | 1   | 1   |
| 2081 | 0   | 0   | 0   | 0   | 0   | 0   | 0   | 1   | 1   | 1   | 1   |
| 2082 | 0   | 0   | 0   | 0   | 0   | 0   | 0   | 1   | 1   | 1   | 1   |
| 2083 | 0   | 0   | 0   | 0   | 0   | 0   | 0   | 1   | 1   | 1   | 1   |
| 2084 | 0   | 0   | 0   | 0   | 0   | 0   | 0   | 1   | 1   | 1   | 1   |
| 2085 | 0   | 0   | 0   | 0   | 0   | 0   | 0   | 1   | 1   | 1   | 1   |
| 2086 | 0   | 0   | 0   | 0   | 0   | 0   | 0   | 1   | 1   | 1   | 1   |
| 2087 | 0   | 0   | 0   | 0   | 0   | 0   | 0   | 1   | 1   | 1   | 1   |
| 2088 | 0   | 0   | 0   | 0   | 0   | 0   | 0   | 1   | 1   | 1   | 1   |
| 2089 | 0   | 0   | 0   | 0   | 0   | 0   | 0   | 1   | 1   | 1   | 1   |
| 2090 | 0   | 0   | 0   | 0   | 0   | 0   | 0   | 1   | 1   | 1   | 1   |

|      | 155 | 156 | 157 | 158 | 159 | 160 | 161 | 162 |
|------|-----|-----|-----|-----|-----|-----|-----|-----|
| 2002 | 0   | 0   | 0   | 0   | 0   | 0   | 0   | 0   |
| 2003 | 0   | 0   | 0   | 0   | 0   | 0   | 0   | 0   |
| 2004 | 0   | 0   | 0   | 0   | 0   | 0   | 0   | 0   |
| 2005 | 0   | 0   | 0   | 0   | 0   | 0   | 0   | 0   |
| 2006 | 0   | 0   | 0   | 0   | 0   | 0   | 0   | 0   |
| 2007 | 0   | 0   | 0   | 0   | 0   | 0   | 0   | 0   |
| 2008 | 0   | 0   | 0   | 0   | 0   | 0   | 0   | 0   |
| 2009 | 0   | 0   | 0   | 0   | 0   | 0   | 0   | 0   |
| 2010 | 0   | 0   | 0   | 0   | 0   | 0   | 0   | 0   |
| 2011 | 0   | 0   | 0   | 0   | 0   | 0   | 0   | 0   |
| 2012 | 0   | 0   | 0   | 0   | 0   | 0   | 0   | 0   |
| 2013 | 0   | 0   | 0   | 0   | 0   | 0   | 0   | 0   |
| 2014 | 0   | 0   | 0   | 0   | 0   | 0   | 0   | 0   |
| 2015 | 0   | 0   | 0   | 0   | 0   | 0   | 0   | 0   |
| 2016 | 0   | 0   | 0   | 0   | 0   | 0   | 0   | 0   |
| 2017 | 0   | 0   | 0   | 0   | 0   | 0   | 0   | 0   |
| 2018 | 0   | 0   | 0   | 0   | 0   | 0   | 0   | 0   |
| 2019 | 0   | 0   | 0   | 0   | 0   | 0   | 0   | 0   |
| 2020 | 0   | 0   | 250 | 0   | 0   | 0   | 0   | 0   |
| 2021 | 0   | 0   | 250 | 0   | 0   | 0   | 0   | 0   |
| 2022 | 0   | 0   | 250 | 0   | 0   | 0   | 0   | 0   |
| 2023 | 0   | 0   | 250 | 0   | 0   | 0   | 0   | 0   |
| 2024 | 0   | 0   | 250 | 0   | 0   | 0   | 0   | 0   |
| 2025 | 250 | 0   | 250 | 250 | 250 | 250 | 250 | 250 |
| 2026 | 250 | 0   | 250 | 250 | 250 | 250 | 250 | 250 |
| 2027 | 250 | 0   | 250 | 250 | 250 | 250 | 250 | 250 |
| 2028 | 250 | 0   | 250 | 250 | 250 | 250 | 250 | 250 |
| 2029 | 250 | 0   | 250 | 250 | 250 | 250 | 250 | 250 |
| 2030 | 250 | 250 | 250 | 250 | 250 | 250 | 250 | 250 |
| 2031 | 250 | 250 | 250 | 250 | 250 | 250 | 250 | 250 |
| 2032 | 250 | 250 | 250 | 250 | 250 | 250 | 250 | 250 |
| 2033 | 250 | 250 | 250 | 250 | 250 | 250 | 250 | 250 |
| 2034 | 250 | 250 | 250 | 250 | 250 | 250 | 250 | 250 |
| 2035 | 250 | 250 | 250 | 250 | 250 | 250 | 250 | 250 |
| 2036 | 250 | 250 | 250 | 250 | 250 | 250 | 250 | 250 |
| 2037 | 250 | 250 | 250 | 250 | 250 | 250 | 250 | 250 |
| 2038 | 250 | 250 | 250 | 250 | 250 | 250 | 250 | 250 |
| 2039 | 250 | 250 | 250 | 250 | 250 | 250 | 250 | 250 |
| 2040 | 250 | 250 | 250 | 250 | 250 | 250 | 250 | 250 |
| 2041 | 250 | 250 | 250 | 250 | 250 | 250 | 250 | 250 |
| 2042 | 250 | 250 | 250 | 250 | 250 | 250 | 250 | 250 |
| 2043 | 250 | 250 | 250 | 250 | 250 | 250 | 250 | 250 |
| 2044 | 250 | 250 | 224 | 250 | 250 | 250 | 250 | 250 |
| 2045 | 250 | 250 | 215 | 250 | 250 | 250 | 250 | 250 |
| 2046 | 250 | 250 | 178 | 250 | 250 | 250 | 250 | 250 |
| 2047 | 250 | 250 | 93  | 250 | 250 | 250 | 250 | 250 |
| 2048 | 250 | 250 | 45  | 250 | 250 | 250 | 250 | 250 |
| 2049 | 250 | 250 | 26  | 250 | 250 | 243 | 243 | 243 |
| 2050 | 234 | 250 | 14  | 233 | 206 | 182 | 182 | 182 |
| 2051 | 173 | 250 | 0   | 174 | 138 | 121 | 121 | 121 |
| 2052 | 108 | 250 | 0   | 102 | 78  | 70  | 70  | 70  |
| 2053 | 58  | 250 | 0   | 67  | 47  | 46  | 46  | 46  |
| 2054 | 40  | 245 | 0   | 41  | 41  | 23  | 23  | 23  |
| 2055 | 23  | 181 | 0   | 23  | 23  | 13  | 13  | 13  |
| 2056 | 0   | 116 | 0   | 13  | 13  | 3   | 3   | 3   |
| 2057 | 0   | 69  | 0   | 3   | 0   | 1   | 1   | 1   |
| 2058 | 0   | 53  | 0   | 1   | 0   | 1   | 1   | 1   |
| 2059 | 0   | 28  | 0   | 1   | 0   | 1   | 1   | 1   |

|      | 155 | 156 | 157 | 158 | 159 | 160 | 161 | 162 |
|------|-----|-----|-----|-----|-----|-----|-----|-----|
| 2060 | 0   | 17  | 0   | 1   | 0   | 1   | 1   | 1   |
| 2061 | 0   | 11  | 0   | 1   | 0   | 1   | 1   | 1   |
| 2062 | 0   | 0   | 0   | 1   | 0   | 1   | 1   | 1   |
| 2063 | 0   | 0   | 0   | 1   | 0   | 1   | 1   | 1   |
| 2064 | 0   | 0   | 0   | 1   | 0   | 1   | 1   | 1   |
| 2065 | 0   | 0   | 0   | 1   | 0   | 1   | 1   | 1   |
| 2066 | 0   | 0   | 0   | 1   | 0   | 1   | 1   | 1   |
| 2067 | 0   | 0   | 0   | 1   | 0   | 1   | 1   | 1   |
| 2068 | 0   | 0   | 0   | 1   | 0   | 1   | 1   | 1   |
| 2069 | 0   | 0   | 0   | 1   | 0   | 1   | 1   | 1   |
| 2070 | 0   | 0   | 0   | 1   | 0   | 1   | 1   | 1   |
| 2071 | 0   | 0   | 0   | 1   | 0   | 1   | 1   | 1   |
| 2072 | 0   | 0   | 0   | 1   | 0   | 1   | 1   | 1   |
| 2073 | 0   | 0   | 0   | 1   | 0   | 1   | 1   | 1   |
| 2074 | 0   | 0   | 0   | 1   | 0   | 1   | 1   | 1   |
| 2075 | 0   | 0   | 0   | 1   | 0   | 1   | 1   | 1   |
| 2076 | 0   | 0   | 0   | 1   | 0   | 1   | 1   | 1   |
| 2077 | 0   | 0   | 0   | 1   | 0   | 1   | 1   | 1   |
| 2078 | 0   | 0   | 0   | 1   | 0   | 1   | 1   | 1   |
| 2079 | 0   | 0   | 0   | 1   | 0   | 1   | 1   | 1   |
| 2080 | 0   | 0   | 0   | 1   | 0   | 1   | 1   | 1   |
| 2081 | 0   | 0   | 0   | 1   | 0   | 1   | 1   | 1   |
| 2082 | 0   | 0   | 0   | 1   | 0   | 1   | 1   | 1   |
| 2083 | 0   | 0   | 0   | 1   | 0   | 1   | 1   | 1   |
| 2084 | 0   | 0   | 0   | 1   | 0   | 1   | 1   | 1   |
| 2085 | 0   | 0   | 0   | 1   | 0   | 1   | 1   | 1   |
| 2086 | 0   | 0   | 0   | 1   | 0   | 1   | 1   | 1   |
| 2087 | 0   | 0   | 0   | 1   | 0   | 1   | 1   | 1   |
| 2088 | 0   | 0   | 0   | 1   | 0   | 1   | 1   | 1   |
| 2089 | 0   | 0   | 0   | 1   | 0   | 1   | 1   | 1   |
| 2090 | 0   | 0   | 0   | 1   | 0   | 1   | 1   | 1   |

|      | 1  | 2  | 3  | 4  | 5  | 6  | 7  | 8  | 9  | 10 | 11 | 12 |
|------|----|----|----|----|----|----|----|----|----|----|----|----|
| 2002 | 0  | 0  | 0  | 0  | 0  | 0  | 0  | 0  | 0  | 0  | 0  | 0  |
| 2003 | 0  | 0  | 0  | 0  | 0  | 0  | 0  | 0  | 0  | 0  | 0  | 0  |
| 2004 | 1  | 1  | 1  | 1  | 1  | 1  | 1  | 1  | 1  | 1  | 1  | 1  |
| 2005 | 2  | 2  | 2  | 2  | 2  | 2  | 2  | 2  | 2  | 2  | 2  | 2  |
| 2006 | 3  | 3  | 3  | 3  | 3  | 3  | 3  | 3  | 3  | 3  | 3  | 3  |
| 2007 | 7  | 7  | 7  | 7  | 7  | 7  | 7  | 7  | 7  | 7  | 7  | 7  |
| 2008 | 10 | 10 | 10 | 10 | 10 | 10 | 10 | 10 | 10 | 10 | 10 | 10 |
| 2009 | 17 | 17 | 17 | 17 | 17 | 17 | 17 | 17 | 17 | 17 | 17 | 17 |
| 2010 | 19 | 19 | 19 | 19 | 19 | 19 | 19 | 19 | 19 | 19 | 19 | 19 |
| 2011 | 30 | 30 | 30 | 30 | 30 | 30 | 30 | 30 | 30 | 30 | 30 | 30 |
| 2012 | 27 | 27 | 27 | 27 | 27 | 27 | 27 | 27 | 27 | 27 | 27 | 27 |
| 2013 | 31 | 31 | 31 | 31 | 31 | 31 | 31 | 31 | 31 | 31 | 31 | 31 |
| 2014 | 32 | 32 | 32 | 32 | 32 | 32 | 32 | 32 | 32 | 32 | 32 | 32 |
| 2015 | 41 | 41 | 41 | 41 | 41 | 41 | 41 | 41 | 41 | 41 | 41 | 41 |
| 2016 | 37 | 37 | 37 | 37 | 37 | 37 | 37 | 37 | 37 | 37 | 37 | 37 |
| 2017 | 44 | 44 | 44 | 44 | 44 | 44 | 44 | 44 | 44 | 44 | 44 | 44 |
| 2018 | 44 | 44 | 44 | 44 | 44 | 44 | 44 | 44 | 44 | 44 | 44 | 44 |
| 2019 | 45 | 45 | 45 | 45 | 45 | 45 | 45 | 45 | 45 | 45 | 45 | 45 |
| 2020 | 47 | 47 | 47 | 27 | 47 | 47 | 47 | 47 | 47 | 47 | 47 | 47 |
| 2021 | 49 | 49 | 49 | 25 | 49 | 49 | 49 | 49 | 49 | 49 | 49 | 49 |
| 2022 | 47 | 47 | 47 | 25 | 47 | 47 | 47 | 47 | 47 | 47 | 47 | 47 |
| 2023 | 50 | 50 | 50 | 25 | 50 | 50 | 50 | 50 | 50 | 50 | 50 | 50 |
| 2024 | 49 | 49 | 49 | 25 | 49 | 49 | 49 | 49 | 49 | 49 | 49 | 49 |
| 2025 | 28 | 28 | 52 | 25 | 28 | 28 | 28 | 28 | 28 | 25 | 25 | 52 |
| 2026 | 23 | 23 | 51 | 27 | 23 | 23 | 23 | 23 | 23 | 24 | 24 | 51 |
| 2027 | 25 | 25 | 51 | 27 | 25 | 25 | 25 | 25 | 25 | 24 | 24 | 51 |
| 2028 | 25 | 25 | 53 | 27 | 25 | 25 | 25 | 25 | 25 | 27 | 26 | 53 |
| 2029 | 24 | 24 | 51 | 25 | 24 | 24 | 24 | 24 | 24 | 24 | 25 | 51 |
| 2030 | 25 | 25 | 28 | 29 | 25 | 25 | 25 | 25 | 25 | 26 | 26 | 24 |
| 2031 | 27 | 27 | 25 | 26 | 27 | 27 | 27 | 27 | 27 | 27 | 27 | 25 |
| 2032 | 26 | 26 | 24 | 29 | 26 | 26 | 26 | 26 | 26 | 26 | 26 | 25 |
| 2033 | 24 | 24 | 27 | 27 | 24 | 25 | 24 | 24 | 24 | 23 | 23 | 26 |
| 2034 | 27 | 27 | 26 | 26 | 27 | 27 | 27 | 27 | 27 | 27 | 27 | 27 |
| 2035 | 26 | 26 | 25 | 30 | 26 | 26 | 26 | 26 | 26 | 30 | 29 | 24 |
| 2036 | 28 | 28 | 27 | 36 | 28 | 27 | 28 | 28 | 28 | 23 | 24 | 23 |
| 2037 | 23 | 24 | 25 | 26 | 24 | 28 | 24 | 24 | 24 | 26 | 27 | 25 |
| 2038 | 29 | 30 | 25 | 27 | 29 | 31 | 30 | 30 | 30 | 28 | 28 | 25 |
| 2039 | 28 | 27 | 26 | 29 | 28 | 26 | 27 | 27 | 27 | 28 | 28 | 24 |
| 2040 | 28 | 29 | 27 | 30 | 29 | 29 | 29 | 29 | 29 | 27 | 27 | 23 |
| 2041 | 28 | 27 | 24 | 26 | 28 | 27 | 27 | 27 | 27 | 29 | 29 | 26 |
| 2042 | 27 | 29 | 27 | 35 | 32 | 28 | 29 | 29 | 29 | 28 | 30 | 26 |
| 2043 | 30 | 30 | 27 | 26 | 16 | 31 | 30 | 30 | 30 | 26 | 27 | 26 |
| 2044 | 36 | 34 | 28 | 22 | 34 | 36 | 34 | 34 | 34 | 23 | 23 | 26 |
| 2045 | 25 | 24 | 28 | 18 | 23 | 25 | 24 | 24 | 24 | 26 | 24 | 23 |
| 2046 | 21 | 21 | 39 | 14 | 21 | 21 | 21 | 21 | 21 | 24 | 25 | 24 |
| 2047 | 13 | 13 | 25 | 5  | 13 | 12 | 13 | 13 | 13 | 27 | 27 | 26 |
| 2048 | 9  | 9  | 22 | 7  | 9  | 10 | 9  | 9  | 9  | 30 | 29 | 32 |
| 2049 | 3  | 3  | 6  | 2  | 4  | 4  | 4  | 4  | 4  | 32 | 32 | 25 |
| 2050 | 1  | 1  | 4  | 1  | 1  | 2  | 1  | 1  | 1  | 30 | 30 | 20 |
| 2051 | 2  | 2  | 3  | 2  | 2  | 3  | 2  | 2  | 2  | 27 | 27 | 15 |
| 2052 | 2  | 2  | 2  | 2  | 2  | 2  | 2  | 2  | 2  | 21 | 21 | 14 |
| 2053 | 0  | 0  | 0  | 0  | 0  | 0  | 0  | 0  | 0  | 17 | 17 | 11 |
| 2054 | 2  | 2  | 2  | 2  | 2  | 2  | 2  | 2  | 2  | 14 | 14 | 3  |
| 2055 | 1  | 1  | 1  | 1  | 1  | 1  | 1  | 1  | 1  | 6  | 6  | 3  |
| 2056 | 1  | 1  | 1  | 1  | 1  | 1  | 1  | 1  | 1  | 4  | 4  | 3  |
| 2057 | 0  | 0  | 0  | 0  | 0  | 0  | 0  | 0  | 0  | 3  | 3  | 3  |
| 2058 | 0  | 0  | 0  | 0  | 0  | 0  | 0  | 0  | 0  | 3  | 3  | 1  |
| 2059 | 0  | 0  | 0  | 0  | 0  | 0  | 0  | 0  | 0  | 3  | 3  | 0  |

|      | 1 | 2 | 3 | 4 | 5 | 6 | 7 | 8 | 9 | 10 | 11 | 12 |
|------|---|---|---|---|---|---|---|---|---|----|----|----|
| 2060 | 0 | 0 | 0 | 0 | 0 | 0 | 0 | 0 | 0 | 1  | 1  | 0  |
| 2061 | 0 | 0 | 0 | 0 | 0 | 0 | 0 | 0 | 0 | 1  | 1  | 0  |
| 2062 | 0 | 0 | 0 | 0 | 0 | 0 | 0 | 0 | 0 | 1  | 1  | 0  |
| 2063 | 0 | 0 | 0 | 0 | 0 | 0 | 0 | 0 | 0 | 0  | 0  | 0  |
| 2064 | 0 | 0 | 0 | 0 | 0 | 0 | 0 | 0 | 0 | 0  | 0  | 0  |
| 2065 | 0 | 0 | 0 | 0 | 0 | 0 | 0 | 0 | 0 | 0  | 0  | 0  |
| 2066 | 0 | 0 | 0 | 0 | 0 | 0 | 0 | 0 | 0 | 0  | 0  | 0  |
| 2067 | 0 | 0 | 0 | 0 | 0 | 0 | 0 | 0 | 0 | 0  | 0  | 0  |
| 2068 | 0 | 0 | 0 | 0 | 0 | 0 | 0 | 0 | 0 | 0  | 0  | 0  |
| 2069 | 0 | 0 | 0 | 0 | 0 | 0 | 0 | 0 | 0 | 0  | 0  | 0  |
| 2070 | 0 | 0 | 0 | 0 | 0 | 0 | 0 | 0 | 0 | 0  | 0  | 0  |
| 2071 | 0 | 0 | 0 | 0 | 0 | 0 | 0 | 0 | 0 | 0  | 0  | 0  |
| 2072 | 0 | 0 | 0 | 0 | 0 | 0 | 0 | 0 | 0 | 0  | 0  | 0  |
| 2073 | 0 | 0 | 0 | 0 | 0 | 0 | 0 | 0 | 0 | 0  | 0  | 0  |
| 2074 | 0 | 0 | 0 | 0 | 0 | 0 | 0 | 0 | 0 | 0  | 0  | 0  |
| 2075 | 0 | 0 | 0 | 0 | 0 | 0 | 0 | 0 | 0 | 0  | 0  | 0  |
| 2076 | 0 | 0 | 0 | 0 | 0 | 0 | 0 | 0 | 0 | 0  | 0  | 0  |
| 2077 | 0 | 0 | 0 | 0 | 0 | 0 | 0 | 0 | 0 | 0  | 0  | 0  |
| 2078 | 0 | 0 | 0 | 0 | 0 | 0 | 0 | 0 | 0 | 0  | 0  | 0  |
| 2079 | 0 | 0 | 0 | 0 | 0 | 0 | 0 | 0 | 0 | 0  | 0  | 0  |
| 2080 | 0 | 0 | 0 | 0 | 0 | 0 | 0 | 0 | 0 | 0  | 0  | 0  |
| 2081 | 0 | 0 | 0 | 0 | 0 | 0 | 0 | 0 | 0 | 0  | 0  | 0  |
| 2082 | 0 | 0 | 0 | 0 | 0 | 0 | 0 | 0 | 0 | 0  | 0  | 0  |
| 2083 | 0 | 0 | 0 | 0 | 0 | 0 | 0 | 0 | 0 | 0  | 0  | 0  |
| 2084 | 0 | 0 | 0 | 0 | 0 | 0 | 0 | 0 | 0 | 0  | 0  | 0  |
| 2085 | 0 | 0 | 0 | 0 | 0 | 0 | 0 | 0 | 0 | 0  | 0  | 0  |
| 2086 | 0 | 0 | 0 | 0 | 0 | 0 | 0 | 0 | 0 | 0  | 0  | 0  |
| 2087 | 0 | 0 | 0 | 0 | 0 | 0 | 0 | 0 | 0 | 0  | 0  | 0  |
| 2088 | 0 | 0 | 0 | 0 | 0 | 0 | 0 | 0 | 0 | 0  | 0  | 0  |
| 2089 | 0 | 0 | 0 | 0 | 0 | 0 | 0 | 0 | 0 | 0  | 0  | 0  |
| 2090 | 0 | 0 | 0 | 0 | 0 | 0 | 0 | 0 | 0 | 0  | 0  | 0  |

|      | 13 | 14 | 15 | 16 | 17 | 18 | 19 | 20 | 21 | 22 | 23 | 24 |
|------|----|----|----|----|----|----|----|----|----|----|----|----|
| 2002 | 0  | 0  | 0  | 0  | 0  | 0  | 0  | 0  | 0  | 0  | 0  | 0  |
| 2003 | 0  | 0  | 0  | 0  | 0  | 0  | 0  | 0  | 0  | 0  | 0  | 0  |
| 2004 | 1  | 1  | 1  | 1  | 1  | 1  | 1  | 1  | 1  | 1  | 1  | 1  |
| 2005 | 2  | 2  | 2  | 2  | 2  | 2  | 2  | 2  | 2  | 2  | 2  | 2  |
| 2006 | 3  | 3  | 3  | 3  | 3  | 3  | 3  | 3  | 3  | 3  | 3  | 3  |
| 2007 | 7  | 7  | 7  | 7  | 7  | 7  | 7  | 7  | 7  | 7  | 7  | 7  |
| 2008 | 10 | 10 | 10 | 10 | 10 | 10 | 10 | 10 | 10 | 10 | 10 | 10 |
| 2009 | 17 | 17 | 17 | 17 | 17 | 17 | 17 | 17 | 17 | 17 | 17 | 17 |
| 2010 | 19 | 19 | 19 | 19 | 19 | 19 | 19 | 19 | 19 | 19 | 19 | 19 |
| 2011 | 30 | 30 | 30 | 30 | 30 | 30 | 30 | 30 | 30 | 30 | 30 | 30 |
| 2012 | 27 | 27 | 27 | 27 | 27 | 27 | 27 | 27 | 27 | 27 | 27 | 27 |
| 2013 | 31 | 31 | 31 | 31 | 31 | 31 | 31 | 31 | 31 | 31 | 31 | 31 |
| 2014 | 32 | 32 | 32 | 32 | 32 | 32 | 32 | 32 | 32 | 32 | 32 | 32 |
| 2015 | 41 | 41 | 41 | 41 | 41 | 41 | 41 | 41 | 41 | 41 | 41 | 41 |
| 2016 | 37 | 37 | 37 | 37 | 37 | 37 | 37 | 37 | 37 | 37 | 37 | 37 |
| 2017 | 44 | 44 | 44 | 44 | 44 | 44 | 44 | 44 | 44 | 44 | 44 | 44 |
| 2018 | 44 | 44 | 44 | 44 | 44 | 44 | 44 | 44 | 44 | 44 | 44 | 44 |
| 2019 | 45 | 45 | 45 | 45 | 45 | 45 | 45 | 45 | 45 | 45 | 45 | 45 |
| 2020 | 24 | 47 | 47 | 47 | 47 | 47 | 47 | 47 | 47 | 24 | 47 | 47 |
| 2021 | 24 | 49 | 49 | 49 | 49 | 49 | 49 | 49 | 49 | 24 | 49 | 49 |
| 2022 | 25 | 47 | 47 | 47 | 47 | 47 | 47 | 47 | 47 | 25 | 47 | 47 |
| 2023 | 27 | 50 | 50 | 50 | 50 | 50 | 50 | 50 | 50 | 27 | 50 | 50 |
| 2024 | 27 | 49 | 49 | 49 | 49 | 49 | 49 | 49 | 49 | 26 | 49 | 49 |
| 2025 | 25 | 25 | 25 | 25 | 25 | 25 | 25 | 25 | 52 | 26 | 25 | 25 |
| 2026 | 27 | 24 | 23 | 24 | 24 | 24 | 24 | 24 | 51 | 26 | 24 | 24 |
| 2027 | 28 | 24 | 23 | 24 | 24 | 24 | 24 | 24 | 51 | 26 | 24 | 24 |
| 2028 | 28 | 26 | 26 | 27 | 27 | 27 | 27 | 26 | 53 | 27 | 27 | 25 |
| 2029 | 31 | 24 | 26 | 25 | 25 | 25 | 24 | 24 | 51 | 28 | 24 | 23 |
| 2030 | 27 | 25 | 27 | 26 | 26 | 26 | 26 | 25 | 24 | 30 | 24 | 26 |
| 2031 | 31 | 27 | 26 | 26 | 26 | 26 | 27 | 27 | 25 | 30 | 26 | 27 |
| 2032 | 35 | 25 | 27 | 27 | 27 | 27 | 24 | 25 | 25 | 32 | 23 | 26 |
| 2033 | 33 | 26 | 24 | 24 | 24 | 24 | 24 | 24 | 26 | 27 | 25 | 26 |
| 2034 | 30 | 26 | 29 | 28 | 28 | 28 | 26 | 26 | 27 | 33 | 26 | 27 |
| 2035 | 31 | 28 | 32 | 31 | 31 | 31 | 28 | 29 | 24 | 31 | 26 | 29 |
| 2036 | 31 | 24 | 28 | 25 | 25 | 25 | 24 | 25 | 24 | 32 | 22 | 27 |
| 2037 | 36 | 24 | 29 | 26 | 26 | 26 | 26 | 25 | 24 | 30 | 27 | 25 |
| 2038 | 26 | 28 | 28 | 27 | 27 | 27 | 26 | 26 | 26 | 28 | 25 | 26 |
| 2039 | 34 | 26 | 27 | 28 | 28 | 28 | 22 | 23 | 23 | 30 | 26 | 27 |
| 2040 | 29 | 27 | 28 | 27 | 27 | 27 | 26 | 26 | 23 | 31 | 25 | 27 |
| 2041 | 34 | 26 | 27 | 30 | 30 | 30 | 29 | 27 | 24 | 34 | 26 | 27 |
| 2042 | 36 | 26 | 25 | 29 | 29 | 29 | 28 | 27 | 23 | 38 | 24 | 26 |
| 2043 | 33 | 27 | 29 | 24 | 24 | 24 | 28 | 25 | 24 | 43 | 26 | 30 |
| 2044 | 31 | 29 | 23 | 24 | 24 | 24 | 27 | 28 | 26 | 38 | 24 | 25 |
| 2045 | 35 | 29 | 27 | 26 | 26 | 26 | 28 | 28 | 25 | 29 | 28 | 35 |
| 2046 | 25 | 25 | 32 | 28 | 28 | 28 | 29 | 29 | 22 | 29 | 26 | 30 |
| 2047 | 29 | 24 | 34 | 26 | 26 | 26 | 32 | 32 | 25 | 27 | 30 | 31 |
| 2048 | 29 | 32 | 31 | 31 | 31 | 31 | 31 | 30 | 33 | 27 | 29 | 31 |
| 2049 | 29 | 30 | 31 | 32 | 32 | 32 | 27 | 27 | 25 | 20 | 26 | 26 |
| 2050 | 27 | 27 | 30 | 30 | 30 | 30 | 21 | 21 | 20 | 13 | 21 | 22 |
| 2051 | 26 | 21 | 27 | 27 | 27 | 27 | 17 | 17 | 15 | 9  | 17 | 18 |
| 2052 | 20 | 17 | 21 | 21 | 21 | 21 | 14 | 14 | 14 | 7  | 14 | 14 |
| 2053 | 17 | 14 | 17 | 17 | 17 | 17 | 6  | 6  | 11 | 5  | 6  | 6  |
| 2054 | 12 | 6  | 13 | 14 | 14 | 14 | 4  | 4  | 3  | 4  | 4  | 4  |
| 2055 | 8  | 4  | 9  | 6  | 6  | 6  | 3  | 3  | 3  | 3  | 4  | 3  |
| 2056 | 5  | 3  | 4  | 4  | 4  | 4  | 4  | 3  | 3  | 2  | 4  | 3  |
| 2057 | 4  | 3  | 3  | 3  | 3  | 3  | 4  | 3  | 3  | 2  | 3  | 3  |
| 2058 | 3  | 3  | 3  | 3  | 3  | 3  | 1  | 1  | 1  | 1  | 1  | 1  |
| 2059 | 3  | 1  | 3  | 3  | 3  | 3  | 1  | 1  | 0  | 1  | 1  | 1  |

|      | 13 | 14 | 15 | 16 | 17 | 18 | 19 | 20 | 21 | 22 | 23 | 24 |
|------|----|----|----|----|----|----|----|----|----|----|----|----|
| 2060 | 3  | 1  | 3  | 1  | 1  | 1  | 1  | 1  | 0  | 1  | 1  | 1  |
| 2061 | 3  | 1  | 1  | 1  | 1  | 1  | 0  | 0  | 0  | 0  | 0  | 0  |
| 2062 | 2  | 0  | 1  | 1  | 1  | 1  | 0  | 0  | 0  | 0  | 0  | 0  |
| 2063 | 0  | 0  | 0  | 0  | 0  | 0  | 0  | 0  | 0  | 0  | 0  | 0  |
| 2064 | 0  | 0  | 0  | 0  | 0  | 0  | 0  | 0  | 0  | 0  | 0  | 0  |
| 2065 | 0  | 0  | 0  | 0  | 0  | 0  | 0  | 0  | 0  | 0  | 0  | 0  |
| 2066 | 0  | 0  | 0  | 0  | 0  | 0  | 0  | 0  | 0  | 0  | 0  | 0  |
| 2067 | 0  | 0  | 0  | 0  | 0  | 0  | 0  | 0  | 0  | 0  | 0  | 0  |
| 2068 | 0  | 0  | 0  | 0  | 0  | 0  | 0  | 0  | 0  | 0  | 0  | 0  |
| 2069 | 0  | 0  | 0  | 0  | 0  | 0  | 0  | 0  | 0  | 0  | 0  | 0  |
| 2070 | 0  | 0  | 0  | 0  | 0  | 0  | 0  | 0  | 0  | 0  | 0  | 0  |
| 2071 | 0  | 0  | 0  | 0  | 0  | 0  | 0  | 0  | 0  | 0  | 0  | 0  |
| 2072 | 0  | 0  | 0  | 0  | 0  | 0  | 0  | 0  | 0  | 0  | 0  | 0  |
| 2073 | 0  | 0  | 0  | 0  | 0  | 0  | 0  | 0  | 0  | 0  | 0  | 0  |
| 2074 | 0  | 0  | 0  | 0  | 0  | 0  | 0  | 0  | 0  | 0  | 0  | 0  |
| 2075 | 0  | 0  | 0  | 0  | 0  | 0  | 0  | 0  | 0  | 0  | 0  | 0  |
| 2076 | 0  | 0  | 0  | 0  | 0  | 0  | 0  | 0  | 0  | 0  | 0  | 0  |
| 2077 | 0  | 0  | 0  | 0  | 0  | 0  | 0  | 0  | 0  | 0  | 0  | 0  |
| 2078 | 0  | 0  | 0  | 0  | 0  | 0  | 0  | 0  | 0  | 0  | 0  | 0  |
| 2079 | 0  | 0  | 0  | 0  | 0  | 0  | 0  | 0  | 0  | 0  | 0  | 0  |
| 2080 | 0  | 0  | 0  | 0  | 0  | 0  | 0  | 0  | 0  | 0  | 0  | 0  |
| 2081 | 0  | 0  | 0  | 0  | 0  | 0  | 0  | 0  | 0  | 0  | 0  | 0  |
| 2082 | 0  | 0  | 0  | 0  | 0  | 0  | 0  | 0  | 0  | 0  | 0  | 0  |
| 2083 | 0  | 0  | 0  | 0  | 0  | 0  | 0  | 0  | 0  | 0  | 0  | 0  |
| 2084 | 0  | 0  | 0  | 0  | 0  | 0  | 0  | 0  | 0  | 0  | 0  | 0  |
| 2085 | 0  | 0  | 0  | 0  | 0  | 0  | 0  | 0  | 0  | 0  | 0  | 0  |
| 2086 | 0  | 0  | 0  | 0  | 0  | 0  | 0  | 0  | 0  | 0  | 0  | 0  |
| 2087 | 0  | 0  | 0  | 0  | 0  | 0  | 0  | 0  | 0  | 0  | 0  | 0  |
| 2088 | 0  | 0  | 0  | 0  | 0  | 0  | 0  | 0  | 0  | 0  | 0  | 0  |
| 2089 | 0  | 0  | 0  | 0  | 0  | 0  | 0  | 0  | 0  | 0  | 0  | 0  |
| 2090 | 0  | 0  | 0  | 0  | 0  | 0  | 0  | 0  | 0  | 0  | 0  | 0  |



|      | 25 | 26 | 27 | 28 | 29 | 30 | 31 | 32 | 33 | 34 | 35 | 36 |
|------|----|----|----|----|----|----|----|----|----|----|----|----|
| 2002 | 0  | 0  | 0  | 0  | 0  | 0  | 0  | 0  | 0  | 0  | 0  | 0  |
| 2003 | 0  | 0  | 0  | 0  | 0  | 0  | 0  | 0  | 0  | 0  | 0  | 0  |
| 2004 | 1  | 1  | 1  | 1  | 1  | 1  | 1  | 1  | 1  | 1  | 1  | 1  |
| 2005 | 2  | 2  | 2  | 2  | 2  | 2  | 2  | 2  | 2  | 2  | 2  | 2  |
| 2006 | 3  | 3  | 3  | 3  | 3  | 3  | 3  | 3  | 3  | 3  | 3  | 3  |
| 2007 | 7  | 7  | 7  | 7  | 7  | 7  | 7  | 7  | 7  | 7  | 7  | 7  |
| 2008 | 10 | 10 | 10 | 10 | 10 | 10 | 10 | 10 | 10 | 10 | 10 | 10 |
| 2009 | 17 | 17 | 17 | 17 | 17 | 17 | 17 | 17 | 17 | 17 | 17 | 17 |
| 2010 | 19 | 19 | 19 | 19 | 19 | 19 | 19 | 19 | 19 | 19 | 19 | 19 |
| 2011 | 30 | 30 | 30 | 30 | 30 | 30 | 30 | 30 | 30 | 30 | 30 | 30 |
| 2012 | 27 | 27 | 27 | 27 | 27 | 27 | 27 | 27 | 27 | 27 | 27 | 27 |
| 2013 | 31 | 31 | 31 | 31 | 31 | 31 | 31 | 31 | 31 | 31 | 31 | 31 |
| 2014 | 32 | 32 | 32 | 32 | 32 | 32 | 32 | 32 | 32 | 32 | 32 | 32 |
| 2015 | 41 | 41 | 41 | 41 | 41 | 41 | 41 | 41 | 41 | 41 | 41 | 41 |
| 2016 | 37 | 37 | 37 | 37 | 37 | 37 | 37 | 37 | 37 | 37 | 37 | 37 |
| 2017 | 44 | 44 | 44 | 44 | 44 | 44 | 44 | 44 | 44 | 44 | 44 | 44 |
| 2018 | 44 | 44 | 44 | 44 | 44 | 44 | 44 | 44 | 44 | 44 | 44 | 44 |
| 2019 | 45 | 45 | 45 | 45 | 45 | 45 | 45 | 45 | 45 | 45 | 45 | 45 |
| 2020 | 47 | 47 | 47 | 47 | 47 | 47 | 27 | 47 | 47 | 47 | 47 | 47 |
| 2021 | 49 | 49 | 49 | 49 | 49 | 49 | 25 | 49 | 49 | 49 | 49 | 49 |
| 2022 | 47 | 47 | 47 | 47 | 47 | 47 | 25 | 47 | 47 | 47 | 47 | 47 |
| 2023 | 50 | 50 | 50 | 50 | 50 | 50 | 25 | 50 | 50 | 50 | 50 | 50 |
| 2024 | 49 | 49 | 49 | 49 | 49 | 49 | 25 | 49 | 49 | 49 | 49 | 49 |
| 2025 | 25 | 25 | 25 | 28 | 28 | 52 | 25 | 28 | 28 | 28 | 28 | 28 |
| 2026 | 24 | 24 | 24 | 23 | 23 | 51 | 27 | 23 | 23 | 23 | 23 | 23 |
| 2027 | 24 | 24 | 24 | 25 | 25 | 51 | 27 | 25 | 25 | 25 | 25 | 25 |
| 2028 | 27 | 27 | 27 | 25 | 25 | 53 | 27 | 25 | 25 | 25 | 25 | 25 |
| 2029 | 25 | 25 | 25 | 24 | 24 | 51 | 25 | 24 | 24 | 24 | 24 | 24 |
| 2030 | 26 | 26 | 26 | 25 | 25 | 28 | 29 | 25 | 25 | 25 | 25 | 25 |
| 2031 | 26 | 26 | 26 | 27 | 27 | 25 | 26 | 27 | 27 | 27 | 27 | 27 |
| 2032 | 25 | 25 | 25 | 26 | 26 | 24 | 30 | 26 | 26 | 26 | 26 | 26 |
| 2033 | 23 | 23 | 23 | 24 | 24 | 27 | 27 | 24 | 25 | 24 | 24 | 24 |
| 2034 | 27 | 27 | 27 | 27 | 27 | 26 | 26 | 27 | 25 | 27 | 27 | 27 |
| 2035 | 28 | 28 | 28 | 26 | 26 | 25 | 31 | 26 | 23 | 26 | 26 | 26 |
| 2036 | 25 | 25 | 25 | 28 | 28 | 27 | 36 | 28 | 25 | 28 | 28 | 28 |
| 2037 | 24 | 24 | 24 | 23 | 24 | 25 | 26 | 24 | 28 | 24 | 24 | 24 |
| 2038 | 26 | 26 | 26 | 30 | 30 | 25 | 28 | 29 | 29 | 30 | 30 | 30 |
| 2039 | 23 | 23 | 23 | 26 | 26 | 26 | 30 | 28 | 27 | 23 | 23 | 23 |
| 2040 | 27 | 27 | 27 | 30 | 29 | 27 | 31 | 28 | 27 | 29 | 29 | 29 |
| 2041 | 27 | 27 | 27 | 28 | 27 | 24 | 28 | 29 | 31 | 28 | 28 | 28 |
| 2042 | 28 | 28 | 28 | 28 | 27 | 26 | 35 | 30 | 28 | 29 | 29 | 29 |
| 2043 | 27 | 27 | 27 | 30 | 31 | 28 | 25 | 29 | 29 | 30 | 30 | 30 |
| 2044 | 26 | 26 | 26 | 35 | 35 | 25 | 21 | 35 | 35 | 35 | 35 | 35 |
| 2045 | 30 | 30 | 30 | 26 | 25 | 26 | 18 | 23 | 27 | 24 | 24 | 24 |
| 2046 | 28 | 28 | 28 | 22 | 21 | 38 | 14 | 21 | 22 | 21 | 21 | 21 |
| 2047 | 32 | 32 | 32 | 13 | 13 | 24 | 5  | 13 | 12 | 13 | 13 | 13 |
| 2048 | 30 | 30 | 30 | 9  | 9  | 24 | 7  | 9  | 10 | 9  | 9  | 9  |
| 2049 | 27 | 27 | 27 | 4  | 4  | 6  | 2  | 3  | 4  | 3  | 3  | 3  |
| 2050 | 21 | 21 | 21 | 1  | 1  | 4  | 1  | 1  | 2  | 1  | 1  | 1  |
| 2051 | 17 | 17 | 17 | 2  | 2  | 3  | 2  | 2  | 3  | 2  | 2  | 2  |
| 2052 | 14 | 14 | 14 | 2  | 2  | 2  | 2  | 2  | 2  | 2  | 2  | 2  |
| 2053 | 6  | 6  | 6  | 0  | 0  | 0  | 0  | 0  | 0  | 0  | 0  | 0  |
| 2054 | 4  | 4  | 4  | 2  | 2  | 2  | 2  | 2  | 2  | 2  | 2  | 2  |
| 2055 | 3  | 3  | 3  | 1  | 1  | 1  | 1  | 1  | 1  | 1  | 1  | 1  |
| 2056 | 3  | 3  | 3  | 1  | 1  | 1  | 1  | 1  | 1  | 1  | 1  | 1  |
| 2057 | 3  | 3  | 3  | 0  | 0  | 0  | 0  | 0  | 0  | 0  | 0  | 0  |
| 2058 | 1  | 1  | 1  | 0  | 0  | 0  | 0  | 0  | 0  | 0  | 0  | 0  |
| 2059 | 1  | 1  | 1  | 0  | 0  | 0  | 0  | 0  | 0  | 0  | 0  | 0  |

|      | 25 | 26 | 27 | 28 | 29 | 30 | 31 | 32 | 33 | 34 | 35 | 36 |
|------|----|----|----|----|----|----|----|----|----|----|----|----|
| 2060 | 1  | 1  | 1  | 0  | 0  | 0  | 0  | 0  | 0  | 0  | 0  | 0  |
| 2061 | 0  | 0  | 0  | 0  | 0  | 0  | 0  | 0  | 0  | 0  | 0  | 0  |
| 2062 | 0  | 0  | 0  | 0  | 0  | 0  | 0  | 0  | 0  | 0  | 0  | 0  |
| 2063 | 0  | 0  | 0  | 0  | 0  | 0  | 0  | 0  | 0  | 0  | 0  | 0  |
| 2064 | 0  | 0  | 0  | 0  | 0  | 0  | 0  | 0  | 0  | 0  | 0  | 0  |
| 2065 | 0  | 0  | 0  | 0  | 0  | 0  | 0  | 0  | 0  | 0  | 0  | 0  |
| 2066 | 0  | 0  | 0  | 0  | 0  | 0  | 0  | 0  | 0  | 0  | 0  | 0  |
| 2067 | 0  | 0  | 0  | 0  | 0  | 0  | 0  | 0  | 0  | 0  | 0  | 0  |
| 2068 | 0  | 0  | 0  | 0  | 0  | 0  | 0  | 0  | 0  | 0  | 0  | 0  |
| 2069 | 0  | 0  | 0  | 0  | 0  | 0  | 0  | 0  | 0  | 0  | 0  | 0  |
| 2070 | 0  | 0  | 0  | 0  | 0  | 0  | 0  | 0  | 0  | 0  | 0  | 0  |
| 2071 | 0  | 0  | 0  | 0  | 0  | 0  | 0  | 0  | 0  | 0  | 0  | 0  |
| 2072 | 0  | 0  | 0  | 0  | 0  | 0  | 0  | 0  | 0  | 0  | 0  | 0  |
| 2073 | 0  | 0  | 0  | 0  | 0  | 0  | 0  | 0  | 0  | 0  | 0  | 0  |
| 2074 | 0  | 0  | 0  | 0  | 0  | 0  | 0  | 0  | 0  | 0  | 0  | 0  |
| 2075 | 0  | 0  | 0  | 0  | 0  | 0  | 0  | 0  | 0  | 0  | 0  | 0  |
| 2076 | 0  | 0  | 0  | 0  | 0  | 0  | 0  | 0  | 0  | 0  | 0  | 0  |
| 2077 | 0  | 0  | 0  | 0  | 0  | 0  | 0  | 0  | 0  | 0  | 0  | 0  |
| 2078 | 0  | 0  | 0  | 0  | 0  | 0  | 0  | 0  | 0  | 0  | 0  | 0  |
| 2079 | 0  | 0  | 0  | 0  | 0  | 0  | 0  | 0  | 0  | 0  | 0  | 0  |
| 2080 | 0  | 0  | 0  | 0  | 0  | 0  | 0  | 0  | 0  | 0  | 0  | 0  |
| 2081 | 0  | 0  | 0  | 0  | 0  | 0  | 0  | 0  | 0  | 0  | 0  | 0  |
| 2082 | 0  | 0  | 0  | 0  | 0  | 0  | 0  | 0  | 0  | 0  | 0  | 0  |
| 2083 | 0  | 0  | 0  | 0  | 0  | 0  | 0  | 0  | 0  | 0  | 0  | 0  |
| 2084 | 0  | 0  | 0  | 0  | 0  | 0  | 0  | 0  | 0  | 0  | 0  | 0  |
| 2085 | 0  | 0  | 0  | 0  | 0  | 0  | 0  | 0  | 0  | 0  | 0  | 0  |
| 2086 | 0  | 0  | 0  | 0  | 0  | 0  | 0  | 0  | 0  | 0  | 0  | 0  |
| 2087 | 0  | 0  | 0  | 0  | 0  | 0  | 0  | 0  | 0  | 0  | 0  | 0  |
| 2088 | 0  | 0  | 0  | 0  | 0  | 0  | 0  | 0  | 0  | 0  | 0  | 0  |
| 2089 | 0  | 0  | 0  | 0  | 0  | 0  | 0  | 0  | 0  | 0  | 0  | 0  |
| 2090 | 0  | 0  | 0  | 0  | 0  | 0  | 0  | 0  | 0  | 0  | 0  | 0  |

|      | 37 | 38 | 39 | 40 | 41 | 42 | 43 | 44 | 45 | 46 | 47 | 48 |
|------|----|----|----|----|----|----|----|----|----|----|----|----|
| 2002 | 0  | 0  | 0  | 0  | 0  | 0  | 0  | 0  | 0  | 0  | 0  | 0  |
| 2003 | 0  | 0  | 0  | 0  | 0  | 0  | 0  | 0  | 0  | 0  | 0  | 0  |
| 2004 | 1  | 1  | 1  | 1  | 1  | 1  | 1  | 1  | 1  | 1  | 1  | 1  |
| 2005 | 2  | 2  | 2  | 2  | 2  | 2  | 2  | 2  | 2  | 2  | 2  | 2  |
| 2006 | 3  | 3  | 3  | 3  | 3  | 3  | 3  | 3  | 3  | 3  | 3  | 3  |
| 2007 | 7  | 7  | 7  | 7  | 7  | 7  | 7  | 7  | 7  | 7  | 7  | 7  |
| 2008 | 10 | 10 | 10 | 10 | 10 | 10 | 10 | 10 | 10 | 10 | 10 | 10 |
| 2009 | 17 | 17 | 17 | 17 | 17 | 17 | 17 | 17 | 17 | 17 | 17 | 17 |
| 2010 | 19 | 19 | 19 | 19 | 19 | 19 | 19 | 19 | 19 | 19 | 19 | 19 |
| 2011 | 30 | 30 | 30 | 30 | 30 | 30 | 30 | 30 | 30 | 30 | 30 | 30 |
| 2012 | 27 | 27 | 27 | 27 | 27 | 27 | 27 | 27 | 27 | 27 | 27 | 27 |
| 2013 | 31 | 31 | 31 | 31 | 31 | 31 | 31 | 31 | 31 | 31 | 31 | 31 |
| 2014 | 32 | 32 | 32 | 32 | 32 | 32 | 32 | 32 | 32 | 32 | 32 | 32 |
| 2015 | 41 | 41 | 41 | 41 | 41 | 41 | 41 | 41 | 41 | 41 | 41 | 41 |
| 2016 | 37 | 37 | 37 | 37 | 37 | 37 | 37 | 37 | 37 | 37 | 37 | 37 |
| 2017 | 44 | 44 | 44 | 44 | 44 | 44 | 44 | 44 | 44 | 44 | 44 | 44 |
| 2018 | 44 | 44 | 44 | 44 | 44 | 44 | 44 | 44 | 44 | 44 | 44 | 44 |
| 2019 | 45 | 45 | 45 | 45 | 45 | 45 | 45 | 45 | 45 | 45 | 45 | 45 |
| 2020 | 47 | 47 | 47 | 24 | 47 | 47 | 47 | 47 | 47 | 47 | 47 | 47 |
| 2021 | 49 | 49 | 49 | 24 | 49 | 49 | 49 | 49 | 49 | 49 | 49 | 49 |
| 2022 | 47 | 47 | 47 | 25 | 47 | 47 | 47 | 47 | 47 | 47 | 47 | 47 |
| 2023 | 50 | 50 | 50 | 26 | 50 | 50 | 50 | 50 | 50 | 50 | 50 | 50 |
| 2024 | 49 | 49 | 49 | 27 | 49 | 49 | 49 | 49 | 49 | 49 | 49 | 49 |
| 2025 | 25 | 25 | 52 | 25 | 25 | 25 | 25 | 25 | 25 | 25 | 25 | 52 |
| 2026 | 23 | 23 | 51 | 27 | 24 | 23 | 23 | 23 | 23 | 23 | 24 | 51 |
| 2027 | 24 | 24 | 51 | 28 | 23 | 23 | 24 | 24 | 24 | 24 | 24 | 51 |
| 2028 | 26 | 25 | 53 | 28 | 25 | 23 | 26 | 26 | 26 | 26 | 26 | 53 |
| 2029 | 23 | 23 | 51 | 32 | 23 | 24 | 23 | 23 | 23 | 25 | 24 | 51 |
| 2030 | 26 | 26 | 24 | 26 | 24 | 27 | 25 | 25 | 25 | 26 | 25 | 24 |
| 2031 | 26 | 26 | 25 | 30 | 25 | 28 | 25 | 25 | 25 | 26 | 26 | 24 |
| 2032 | 25 | 25 | 24 | 35 | 24 | 29 | 26 | 26 | 26 | 25 | 25 | 25 |
| 2033 | 22 | 22 | 26 | 33 | 25 | 24 | 22 | 22 | 22 | 24 | 25 | 25 |
| 2034 | 26 | 26 | 27 | 32 | 26 | 29 | 27 | 27 | 27 | 25 | 25 | 27 |
| 2035 | 30 | 29 | 23 | 31 | 27 | 30 | 31 | 31 | 31 | 27 | 27 | 23 |
| 2036 | 26 | 25 | 22 | 29 | 23 | 29 | 26 | 26 | 26 | 23 | 21 | 24 |
| 2037 | 27 | 27 | 21 | 31 | 25 | 28 | 26 | 26 | 26 | 27 | 24 | 24 |
| 2038 | 30 | 30 | 24 | 27 | 27 | 28 | 29 | 29 | 29 | 26 | 24 | 26 |
| 2039 | 29 | 29 | 22 | 37 | 26 | 27 | 28 | 28 | 28 | 26 | 24 | 21 |
| 2040 | 26 | 27 | 23 | 35 | 27 | 32 | 27 | 27 | 27 | 30 | 24 | 20 |
| 2041 | 29 | 30 | 24 | 39 | 26 | 32 | 31 | 31 | 31 | 28 | 24 | 24 |
| 2042 | 26 | 30 | 26 | 31 | 28 | 26 | 30 | 30 | 30 | 31 | 29 | 26 |
| 2043 | 24 | 28 | 25 | 33 | 31 | 31 | 28 | 28 | 28 | 28 | 28 | 21 |
| 2044 | 20 | 23 | 27 | 34 | 30 | 27 | 24 | 24 | 24 | 28 | 30 | 24 |
| 2045 | 27 | 22 | 27 | 35 | 31 | 29 | 25 | 25 | 25 | 32 | 33 | 25 |
| 2046 | 27 | 24 | 27 | 29 | 27 | 30 | 26 | 26 | 26 | 28 | 30 | 24 |
| 2047 | 29 | 27 | 27 | 33 | 26 | 33 | 29 | 29 | 29 | 32 | 32 | 29 |
| 2048 | 30 | 30 | 32 | 29 | 32 | 31 | 32 | 32 | 32 | 31 | 31 | 33 |
| 2049 | 32 | 32 | 25 | 28 | 30 | 29 | 32 | 32 | 32 | 27 | 27 | 25 |
| 2050 | 31 | 30 | 20 | 26 | 27 | 27 | 30 | 30 | 30 | 21 | 21 | 20 |
| 2051 | 27 | 27 | 15 | 26 | 21 | 22 | 27 | 27 | 27 | 17 | 17 | 15 |
| 2052 | 21 | 21 | 14 | 20 | 17 | 17 | 21 | 21 | 21 | 14 | 14 | 14 |
| 2053 | 17 | 17 | 11 | 16 | 14 | 14 | 17 | 17 | 17 | 6  | 6  | 11 |
| 2054 | 14 | 14 | 3  | 11 | 6  | 6  | 14 | 14 | 14 | 4  | 4  | 3  |
| 2055 | 6  | 6  | 3  | 8  | 4  | 4  | 6  | 6  | 6  | 3  | 3  | 3  |
| 2056 | 4  | 4  | 3  | 5  | 3  | 3  | 4  | 4  | 4  | 3  | 4  | 3  |
| 2057 | 3  | 3  | 3  | 4  | 3  | 3  | 3  | 3  | 3  | 3  | 4  | 3  |
| 2058 | 3  | 3  | 1  | 3  | 3  | 3  | 3  | 3  | 3  | 1  | 1  | 1  |
| 2059 | 3  | 3  | 0  | 3  | 1  | 1  | 3  | 3  | 3  | 1  | 1  | 0  |

|      | 37 | 38 | 39 | 40 | 41 | 42 | 43 | 44 | 45 | 46 | 47 | 48 |
|------|----|----|----|----|----|----|----|----|----|----|----|----|
| 2060 | 1  | 1  | 0  | 2  | 1  | 1  | 1  | 1  | 1  | 1  | 1  | 0  |
| 2061 | 1  | 1  | 0  | 2  | 1  | 1  | 1  | 1  | 1  | 0  | 0  | 0  |
| 2062 | 1  | 1  | 0  | 2  | 0  | 0  | 1  | 1  | 1  | 0  | 0  | 0  |
| 2063 | 0  | 0  | 0  | 0  | 0  | 0  | 0  | 0  | 0  | 0  | 0  | 0  |
| 2064 | 0  | 0  | 0  | 0  | 0  | 0  | 0  | 0  | 0  | 0  | 0  | 0  |
| 2065 | 0  | 0  | 0  | 0  | 0  | 0  | 0  | 0  | 0  | 0  | 0  | 0  |
| 2066 | 0  | 0  | 0  | 0  | 0  | 0  | 0  | 0  | 0  | 0  | 0  | 0  |
| 2067 | 0  | 0  | 0  | 0  | 0  | 0  | 0  | 0  | 0  | 0  | 0  | 0  |
| 2068 | 0  | 0  | 0  | 0  | 0  | 0  | 0  | 0  | 0  | 0  | 0  | 0  |
| 2069 | 0  | 0  | 0  | 0  | 0  | 0  | 0  | 0  | 0  | 0  | 0  | 0  |
| 2070 | 0  | 0  | 0  | 0  | 0  | 0  | 0  | 0  | 0  | 0  | 0  | 0  |
| 2071 | 0  | 0  | 0  | 0  | 0  | 0  | 0  | 0  | 0  | 0  | 0  | 0  |
| 2072 | 0  | 0  | 0  | 0  | 0  | 0  | 0  | 0  | 0  | 0  | 0  | 0  |
| 2073 | 0  | 0  | 0  | 0  | 0  | 0  | 0  | 0  | 0  | 0  | 0  | 0  |
| 2074 | 0  | 0  | 0  | 0  | 0  | 0  | 0  | 0  | 0  | 0  | 0  | 0  |
| 2075 | 0  | 0  | 0  | 0  | 0  | 0  | 0  | 0  | 0  | 0  | 0  | 0  |
| 2076 | 0  | 0  | 0  | 0  | 0  | 0  | 0  | 0  | 0  | 0  | 0  | 0  |
| 2077 | 0  | 0  | 0  | 0  | 0  | 0  | 0  | 0  | 0  | 0  | 0  | 0  |
| 2078 | 0  | 0  | 0  | 0  | 0  | 0  | 0  | 0  | 0  | 0  | 0  | 0  |
| 2079 | 0  | 0  | 0  | 0  | 0  | 0  | 0  | 0  | 0  | 0  | 0  | 0  |
| 2080 | 0  | 0  | 0  | 0  | 0  | 0  | 0  | 0  | 0  | 0  | 0  | 0  |
| 2081 | 0  | 0  | 0  | 0  | 0  | 0  | 0  | 0  | 0  | 0  | 0  | 0  |
| 2082 | 0  | 0  | 0  | 0  | 0  | 0  | 0  | 0  | 0  | 0  | 0  | 0  |
| 2083 | 0  | 0  | 0  | 0  | 0  | 0  | 0  | 0  | 0  | 0  | 0  | 0  |
| 2084 | 0  | 0  | 0  | 0  | 0  | 0  | 0  | 0  | 0  | 0  | 0  | 0  |
| 2085 | 0  | 0  | 0  | 0  | 0  | 0  | 0  | 0  | 0  | 0  | 0  | 0  |
| 2086 | 0  | 0  | 0  | 0  | 0  | 0  | 0  | 0  | 0  | 0  | 0  | 0  |
| 2087 | 0  | 0  | 0  | 0  | 0  | 0  | 0  | 0  | 0  | 0  | 0  | 0  |
| 2088 | 0  | 0  | 0  | 0  | 0  | 0  | 0  | 0  | 0  | 0  | 0  | 0  |
| 2089 | 0  | 0  | 0  | 0  | 0  | 0  | 0  | 0  | 0  | 0  | 0  | 0  |
| 2090 | 0  | 0  | 0  | 0  | 0  | 0  | 0  | 0  | 0  | 0  | 0  | 0  |

|      | 49 | 50 | 51 | 52 | 53 | 54 | 55 | 56 | 57 | 58 | 59 | 60 |
|------|----|----|----|----|----|----|----|----|----|----|----|----|
| 2002 | 0  | 0  | 0  | 0  | 0  | 0  | 0  | 0  | 0  | 0  | 0  | 0  |
| 2003 | 0  | 0  | 0  | 0  | 0  | 0  | 0  | 0  | 0  | 0  | 0  | 0  |
| 2004 | 1  | 1  | 1  | 1  | 1  | 1  | 1  | 1  | 1  | 1  | 1  | 1  |
| 2005 | 2  | 2  | 2  | 2  | 2  | 2  | 2  | 2  | 2  | 2  | 2  | 2  |
| 2006 | 3  | 3  | 3  | 3  | 3  | 3  | 3  | 3  | 3  | 3  | 3  | 3  |
| 2007 | 7  | 7  | 7  | 7  | 7  | 7  | 7  | 7  | 7  | 7  | 7  | 7  |
| 2008 | 10 | 10 | 10 | 10 | 10 | 10 | 10 | 10 | 10 | 10 | 10 | 10 |
| 2009 | 17 | 17 | 17 | 17 | 17 | 17 | 17 | 17 | 17 | 17 | 17 | 17 |
| 2010 | 19 | 19 | 19 | 19 | 19 | 19 | 19 | 19 | 19 | 19 | 19 | 19 |
| 2011 | 30 | 30 | 30 | 30 | 30 | 30 | 30 | 30 | 30 | 30 | 30 | 30 |
| 2012 | 27 | 27 | 27 | 27 | 27 | 27 | 27 | 27 | 27 | 27 | 27 | 27 |
| 2013 | 31 | 31 | 31 | 31 | 31 | 31 | 31 | 31 | 31 | 31 | 31 | 31 |
| 2014 | 32 | 32 | 32 | 32 | 32 | 32 | 32 | 32 | 32 | 32 | 32 | 32 |
| 2015 | 41 | 41 | 41 | 41 | 41 | 41 | 41 | 41 | 41 | 41 | 41 | 41 |
| 2016 | 37 | 37 | 37 | 37 | 37 | 37 | 37 | 37 | 37 | 37 | 37 | 37 |
| 2017 | 44 | 44 | 44 | 44 | 44 | 44 | 44 | 44 | 44 | 44 | 44 | 44 |
| 2018 | 44 | 44 | 44 | 44 | 44 | 44 | 44 | 44 | 44 | 44 | 44 | 44 |
| 2019 | 45 | 45 | 45 | 45 | 45 | 45 | 45 | 45 | 45 | 45 | 45 | 45 |
| 2020 | 24 | 47 | 47 | 47 | 47 | 47 | 47 | 47 | 47 | 27 | 47 | 47 |
| 2021 | 24 | 49 | 49 | 49 | 49 | 49 | 49 | 49 | 49 | 21 | 49 | 49 |
| 2022 | 25 | 47 | 47 | 47 | 47 | 47 | 47 | 47 | 47 | 25 | 47 | 47 |
| 2023 | 27 | 50 | 50 | 50 | 50 | 50 | 50 | 50 | 50 | 24 | 50 | 50 |
| 2024 | 26 | 49 | 49 | 49 | 49 | 49 | 49 | 49 | 49 | 23 | 49 | 49 |
| 2025 | 26 | 25 | 25 | 25 | 25 | 25 | 28 | 28 | 52 | 25 | 28 | 28 |
| 2026 | 26 | 24 | 23 | 23 | 23 | 23 | 17 | 17 | 51 | 27 | 17 | 17 |
| 2027 | 26 | 24 | 24 | 24 | 24 | 24 | 22 | 22 | 51 | 28 | 22 | 22 |
| 2028 | 29 | 27 | 25 | 26 | 26 | 26 | 20 | 20 | 53 | 25 | 20 | 20 |
| 2029 | 28 | 25 | 23 | 25 | 25 | 25 | 22 | 21 | 51 | 27 | 21 | 21 |
| 2030 | 30 | 24 | 24 | 26 | 26 | 26 | 23 | 23 | 28 | 26 | 24 | 24 |
| 2031 | 30 | 26 | 26 | 25 | 25 | 25 | 26 | 25 | 20 | 29 | 26 | 26 |
| 2032 | 31 | 22 | 26 | 25 | 25 | 25 | 22 | 22 | 21 | 29 | 22 | 22 |
| 2033 | 26 | 24 | 25 | 22 | 22 | 22 | 23 | 22 | 25 | 31 | 22 | 22 |
| 2034 | 32 | 24 | 27 | 25 | 25 | 25 | 25 | 25 | 23 | 30 | 24 | 26 |
| 2035 | 33 | 26 | 27 | 27 | 27 | 27 | 25 | 24 | 23 | 33 | 25 | 28 |
| 2036 | 33 | 23 | 25 | 22 | 22 | 22 | 27 | 27 | 24 | 32 | 27 | 30 |
| 2037 | 31 | 25 | 26 | 24 | 24 | 24 | 29 | 29 | 22 | 32 | 26 | 31 |
| 2038 | 29 | 21 | 30 | 24 | 24 | 24 | 28 | 29 | 20 | 28 | 29 | 32 |
| 2039 | 31 | 25 | 29 | 23 | 23 | 23 | 26 | 26 | 21 | 31 | 25 | 30 |
| 2040 | 31 | 27 | 31 | 26 | 26 | 26 | 33 | 33 | 22 | 33 | 30 | 27 |
| 2041 | 37 | 23 | 28 | 26 | 26 | 26 | 32 | 31 | 26 | 30 | 29 | 30 |
| 2042 | 40 | 24 | 29 | 28 | 28 | 28 | 32 | 31 | 26 | 30 | 30 | 28 |
| 2043 | 43 | 26 | 32 | 28 | 28 | 28 | 33 | 32 | 24 | 33 | 31 | 31 |
| 2044 | 39 | 26 | 30 | 30 | 30 | 30 | 31 | 32 | 27 | 21 | 31 | 30 |
| 2045 | 28 | 30 | 34 | 35 | 35 | 35 | 35 | 35 | 28 | 18 | 36 | 35 |
| 2046 | 29 | 29 | 32 | 30 | 30 | 30 | 23 | 23 | 33 | 17 | 25 | 23 |
| 2047 | 27 | 29 | 30 | 32 | 32 | 32 | 18 | 19 | 30 | 8  | 20 | 18 |
| 2048 | 27 | 29 | 31 | 31 | 31 | 31 | 15 | 15 | 36 | 7  | 15 | 15 |
| 2049 | 20 | 26 | 26 | 27 | 27 | 27 | 5  | 5  | 23 | 2  | 5  | 5  |
| 2050 | 13 | 21 | 22 | 21 | 21 | 21 | 2  | 2  | 22 | 1  | 3  | 4  |
| 2051 | 9  | 17 | 18 | 17 | 17 | 17 | 2  | 2  | 7  | 2  | 2  | 3  |
| 2052 | 7  | 14 | 14 | 14 | 14 | 14 | 2  | 2  | 5  | 2  | 2  | 2  |
| 2053 | 5  | 6  | 6  | 6  | 6  | 6  | 0  | 0  | 3  | 0  | 0  | 0  |
| 2054 | 4  | 4  | 4  | 4  | 4  | 4  | 2  | 2  | 2  | 2  | 2  | 2  |
| 2055 | 3  | 4  | 3  | 3  | 3  | 3  | 1  | 1  | 1  | 1  | 1  | 1  |
| 2056 | 2  | 4  | 3  | 3  | 3  | 3  | 1  | 1  | 1  | 1  | 1  | 1  |
| 2057 | 2  | 3  | 3  | 3  | 3  | 3  | 0  | 0  | 0  | 0  | 0  | 0  |
| 2058 | 1  | 1  | 1  | 1  | 1  | 1  | 0  | 0  | 0  | 0  | 0  | 0  |
| 2059 | 0  | 1  | 1  | 1  | 1  | 1  | 0  | 0  | 0  | 0  | 0  | 0  |

|      | 49 | 50 | 51 | 52 | 53 | 54 | 55 | 56 | 57 | 58 | 59 | 60 |
|------|----|----|----|----|----|----|----|----|----|----|----|----|
| 2060 | 0  | 1  | 1  | 1  | 1  | 1  | 0  | 0  | 0  | 0  | 0  | 0  |
| 2061 | 0  | 0  | 0  | 0  | 0  | 0  | 0  | 0  | 0  | 0  | 0  | 0  |
| 2062 | 0  | 0  | 0  | 0  | 0  | 0  | 0  | 0  | 0  | 0  | 0  | 0  |
| 2063 | 0  | 0  | 0  | 0  | 0  | 0  | 0  | 0  | 0  | 0  | 0  | 0  |
| 2064 | 0  | 0  | 0  | 0  | 0  | 0  | 0  | 0  | 0  | 0  | 0  | 0  |
| 2065 | 0  | 0  | 0  | 0  | 0  | 0  | 0  | 0  | 0  | 0  | 0  | 0  |
| 2066 | 0  | 0  | 0  | 0  | 0  | 0  | 0  | 0  | 0  | 0  | 0  | 0  |
| 2067 | 0  | 0  | 0  | 0  | 0  | 0  | 0  | 0  | 0  | 0  | 0  | 0  |
| 2068 | 0  | 0  | 0  | 0  | 0  | 0  | 0  | 0  | 0  | 0  | 0  | 0  |
| 2069 | 0  | 0  | 0  | 0  | 0  | 0  | 0  | 0  | 0  | 0  | 0  | 0  |
| 2070 | 0  | 0  | 0  | 0  | 0  | 0  | 0  | 0  | 0  | 0  | 0  | 0  |
| 2071 | 0  | 0  | 0  | 0  | 0  | 0  | 0  | 0  | 0  | 0  | 0  | 0  |
| 2072 | 0  | 0  | 0  | 0  | 0  | 0  | 0  | 0  | 0  | 0  | 0  | 0  |
| 2073 | 0  | 0  | 0  | 0  | 0  | 0  | 0  | 0  | 0  | 0  | 0  | 0  |
| 2074 | 0  | 0  | 0  | 0  | 0  | 0  | 0  | 0  | 0  | 0  | 0  | 0  |
| 2075 | 0  | 0  | 0  | 0  | 0  | 0  | 0  | 0  | 0  | 0  | 0  | 0  |
| 2076 | 0  | 0  | 0  | 0  | 0  | 0  | 0  | 0  | 0  | 0  | 0  | 0  |
| 2077 | 0  | 0  | 0  | 0  | 0  | 0  | 0  | 0  | 0  | 0  | 0  | 0  |
| 2078 | 0  | 0  | 0  | 0  | 0  | 0  | 0  | 0  | 0  | 0  | 0  | 0  |
| 2079 | 0  | 0  | 0  | 0  | 0  | 0  | 0  | 0  | 0  | 0  | 0  | 0  |
| 2080 | 0  | 0  | 0  | 0  | 0  | 0  | 0  | 0  | 0  | 0  | 0  | 0  |
| 2081 | 0  | 0  | 0  | 0  | 0  | 0  | 0  | 0  | 0  | 0  | 0  | 0  |
| 2082 | 0  | 0  | 0  | 0  | 0  | 0  | 0  | 0  | 0  | 0  | 0  | 0  |
| 2083 | 0  | 0  | 0  | 0  | 0  | 0  | 0  | 0  | 0  | 0  | 0  | 0  |
| 2084 | 0  | 0  | 0  | 0  | 0  | 0  | 0  | 0  | 0  | 0  | 0  | 0  |
| 2085 | 0  | 0  | 0  | 0  | 0  | 0  | 0  | 0  | 0  | 0  | 0  | 0  |
| 2086 | 0  | 0  | 0  | 0  | 0  | 0  | 0  | 0  | 0  | 0  | 0  | 0  |
| 2087 | 0  | 0  | 0  | 0  | 0  | 0  | 0  | 0  | 0  | 0  | 0  | 0  |
| 2088 | 0  | 0  | 0  | 0  | 0  | 0  | 0  | 0  | 0  | 0  | 0  | 0  |
| 2089 | 0  | 0  | 0  | 0  | 0  | 0  | 0  | 0  | 0  | 0  | 0  | 0  |
| 2090 | 0  | 0  | 0  | 0  | 0  | 0  | 0  | 0  | 0  | 0  | 0  | 0  |

|      | 61 | 62 | 63 | 64 | 65 | 66 | 67 | 68 | 69 | 70 | 71 | 72 |
|------|----|----|----|----|----|----|----|----|----|----|----|----|
| 2002 | 0  | 0  | 0  | 0  | 0  | 0  | 0  | 0  | 0  | 0  | 0  | 0  |
| 2003 | 0  | 0  | 0  | 0  | 0  | 0  | 0  | 0  | 0  | 0  | 0  | 0  |
| 2004 | 1  | 1  | 1  | 1  | 1  | 1  | 1  | 1  | 1  | 1  | 1  | 1  |
| 2005 | 2  | 2  | 2  | 2  | 2  | 2  | 2  | 2  | 2  | 2  | 2  | 2  |
| 2006 | 3  | 3  | 3  | 3  | 3  | 3  | 3  | 3  | 3  | 3  | 3  | 3  |
| 2007 | 7  | 7  | 7  | 7  | 7  | 7  | 7  | 7  | 7  | 7  | 7  | 7  |
| 2008 | 10 | 10 | 10 | 10 | 10 | 10 | 10 | 10 | 10 | 10 | 10 | 10 |
| 2009 | 17 | 17 | 17 | 17 | 17 | 17 | 17 | 17 | 17 | 17 | 17 | 17 |
| 2010 | 19 | 19 | 19 | 19 | 19 | 19 | 19 | 19 | 19 | 19 | 19 | 19 |
| 2011 | 30 | 30 | 30 | 30 | 30 | 30 | 30 | 30 | 30 | 30 | 30 | 30 |
| 2012 | 27 | 27 | 27 | 27 | 27 | 27 | 27 | 27 | 27 | 27 | 27 | 27 |
| 2013 | 31 | 31 | 31 | 31 | 31 | 31 | 31 | 31 | 31 | 31 | 31 | 31 |
| 2014 | 32 | 32 | 32 | 32 | 32 | 32 | 32 | 32 | 32 | 32 | 32 | 32 |
| 2015 | 41 | 41 | 41 | 41 | 41 | 41 | 41 | 41 | 41 | 41 | 41 | 41 |
| 2016 | 37 | 37 | 37 | 37 | 37 | 37 | 37 | 37 | 37 | 37 | 37 | 37 |
| 2017 | 44 | 44 | 44 | 44 | 44 | 44 | 44 | 44 | 44 | 44 | 44 | 44 |
| 2018 | 44 | 44 | 44 | 44 | 44 | 44 | 44 | 44 | 44 | 44 | 44 | 44 |
| 2019 | 45 | 45 | 45 | 45 | 45 | 45 | 45 | 45 | 45 | 45 | 45 | 45 |
| 2020 | 47 | 47 | 47 | 47 | 47 | 47 | 24 | 47 | 47 | 47 | 47 | 47 |
| 2021 | 49 | 49 | 49 | 49 | 49 | 49 | 19 | 49 | 49 | 49 | 49 | 49 |
| 2022 | 47 | 47 | 47 | 47 | 47 | 47 | 24 | 47 | 47 | 47 | 47 | 47 |
| 2023 | 50 | 50 | 50 | 50 | 50 | 50 | 26 | 50 | 50 | 50 | 50 | 50 |
| 2024 | 49 | 49 | 49 | 49 | 49 | 49 | 26 | 49 | 49 | 49 | 49 | 49 |
| 2025 | 28 | 28 | 28 | 25 | 25 | 52 | 27 | 25 | 25 | 25 | 25 | 25 |
| 2026 | 17 | 17 | 17 | 15 | 15 | 51 | 27 | 15 | 15 | 15 | 15 | 15 |
| 2027 | 22 | 22 | 22 | 20 | 20 | 51 | 28 | 20 | 20 | 20 | 20 | 20 |
| 2028 | 20 | 20 | 20 | 28 | 27 | 53 | 30 | 28 | 27 | 28 | 28 | 28 |
| 2029 | 21 | 21 | 21 | 25 | 25 | 51 | 32 | 26 | 25 | 25 | 25 | 25 |
| 2030 | 24 | 24 | 24 | 25 | 25 | 24 | 31 | 25 | 25 | 25 | 25 | 25 |
| 2031 | 26 | 26 | 26 | 27 | 27 | 18 | 35 | 27 | 29 | 27 | 27 | 27 |
| 2032 | 22 | 22 | 22 | 26 | 26 | 19 | 43 | 26 | 29 | 26 | 26 | 26 |
| 2033 | 22 | 22 | 22 | 23 | 24 | 23 | 39 | 26 | 26 | 24 | 24 | 24 |
| 2034 | 24 | 24 | 24 | 31 | 31 | 28 | 43 | 29 | 31 | 31 | 31 | 31 |
| 2035 | 25 | 25 | 25 | 34 | 34 | 22 | 38 | 30 | 34 | 34 | 34 | 34 |
| 2036 | 27 | 27 | 27 | 30 | 30 | 19 | 31 | 28 | 33 | 29 | 29 | 29 |
| 2037 | 27 | 27 | 27 | 29 | 29 | 26 | 32 | 27 | 36 | 29 | 29 | 29 |
| 2038 | 29 | 29 | 29 | 30 | 31 | 29 | 32 | 28 | 37 | 30 | 30 | 30 |
| 2039 | 25 | 25 | 25 | 34 | 35 | 28 | 39 | 33 | 35 | 36 | 36 | 36 |
| 2040 | 34 | 34 | 34 | 34 | 34 | 24 | 36 | 33 | 36 | 36 | 36 | 36 |
| 2041 | 33 | 33 | 33 | 31 | 31 | 29 | 38 | 29 | 38 | 31 | 31 | 31 |
| 2042 | 31 | 31 | 31 | 32 | 33 | 25 | 42 | 33 | 29 | 33 | 33 | 33 |
| 2043 | 33 | 33 | 33 | 33 | 31 | 26 | 43 | 31 | 35 | 33 | 33 | 33 |
| 2044 | 31 | 31 | 31 | 27 | 26 | 25 | 36 | 27 | 32 | 27 | 27 | 27 |
| 2045 | 35 | 35 | 35 | 29 | 28 | 27 | 28 | 28 | 41 | 32 | 32 | 32 |
| 2046 | 23 | 23 | 23 | 26 | 26 | 26 | 29 | 28 | 39 | 28 | 28 | 28 |
| 2047 | 18 | 18 | 18 | 32 | 31 | 27 | 25 | 29 | 30 | 33 | 33 | 33 |
| 2048 | 15 | 15 | 15 | 31 | 31 | 27 | 24 | 32 | 31 | 30 | 30 | 30 |
| 2049 | 5  | 5  | 5  | 29 | 30 | 32 | 17 | 30 | 25 | 29 | 29 | 29 |
| 2050 | 2  | 2  | 2  | 26 | 26 | 25 | 12 | 27 | 22 | 26 | 26 | 26 |
| 2051 | 2  | 2  | 2  | 21 | 21 | 20 | 7  | 21 | 17 | 21 | 21 | 21 |
| 2052 | 2  | 2  | 2  | 17 | 17 | 15 | 6  | 17 | 9  | 17 | 17 | 17 |
| 2053 | 0  | 0  | 0  | 14 | 14 | 14 | 4  | 14 | 7  | 14 | 14 | 14 |
| 2054 | 2  | 2  | 2  | 6  | 6  | 11 | 3  | 6  | 4  | 6  | 6  | 6  |
| 2055 | 1  | 1  | 1  | 4  | 4  | 3  | 2  | 4  | 3  | 4  | 4  | 4  |
| 2056 | 1  | 1  | 1  | 3  | 3  | 3  | 2  | 3  | 3  | 3  | 3  | 3  |
| 2057 | 0  | 0  | 0  | 3  | 3  | 3  | 1  | 3  | 2  | 3  | 3  | 3  |
| 2058 | 0  | 0  | 0  | 3  | 3  | 3  | 1  | 3  | 0  | 3  | 3  | 3  |
| 2059 | 0  | 0  | 0  | 1  | 1  | 1  | 1  | 1  | 0  | 1  | 1  | 1  |

|      | 61 | 62 | 63 | 64 | 65 | 66 | 67 | 68 | 69 | 70 | 71 | 72 |
|------|----|----|----|----|----|----|----|----|----|----|----|----|
| 2060 | 0  | 0  | 0  | 1  | 1  | 0  | 0  | 1  | 0  | 1  | 1  | 1  |
| 2061 | 0  | 0  | 0  | 1  | 1  | 0  | 0  | 1  | 0  | 1  | 1  | 1  |
| 2062 | 0  | 0  | 0  | 0  | 0  | 0  | 0  | 0  | 0  | 0  | 0  | 0  |
| 2063 | 0  | 0  | 0  | 0  | 0  | 0  | 0  | 0  | 0  | 0  | 0  | 0  |
| 2064 | 0  | 0  | 0  | 0  | 0  | 0  | 0  | 0  | 0  | 0  | 0  | 0  |
| 2065 | 0  | 0  | 0  | 0  | 0  | 0  | 0  | 0  | 0  | 0  | 0  | 0  |
| 2066 | 0  | 0  | 0  | 0  | 0  | 0  | 0  | 0  | 0  | 0  | 0  | 0  |
| 2067 | 0  | 0  | 0  | 0  | 0  | 0  | 0  | 0  | 0  | 0  | 0  | 0  |
| 2068 | 0  | 0  | 0  | 0  | 0  | 0  | 0  | 0  | 0  | 0  | 0  | 0  |
| 2069 | 0  | 0  | 0  | 0  | 0  | 0  | 0  | 0  | 0  | 0  | 0  | 0  |
| 2070 | 0  | 0  | 0  | 0  | 0  | 0  | 0  | 0  | 0  | 0  | 0  | 0  |
| 2071 | 0  | 0  | 0  | 0  | 0  | 0  | 0  | 0  | 0  | 0  | 0  | 0  |
| 2072 | 0  | 0  | 0  | 0  | 0  | 0  | 0  | 0  | 0  | 0  | 0  | 0  |
| 2073 | 0  | 0  | 0  | 0  | 0  | 0  | 0  | 0  | 0  | 0  | 0  | 0  |
| 2074 | 0  | 0  | 0  | 0  | 0  | 0  | 0  | 0  | 0  | 0  | 0  | 0  |
| 2075 | 0  | 0  | 0  | 0  | 0  | 0  | 0  | 0  | 0  | 0  | 0  | 0  |
| 2076 | 0  | 0  | 0  | 0  | 0  | 0  | 0  | 0  | 0  | 0  | 0  | 0  |
| 2077 | 0  | 0  | 0  | 0  | 0  | 0  | 0  | 0  | 0  | 0  | 0  | 0  |
| 2078 | 0  | 0  | 0  | 0  | 0  | 0  | 0  | 0  | 0  | 0  | 0  | 0  |
| 2079 | 0  | 0  | 0  | 0  | 0  | 0  | 0  | 0  | 0  | 0  | 0  | 0  |
| 2080 | 0  | 0  | 0  | 0  | 0  | 0  | 0  | 0  | 0  | 0  | 0  | 0  |
| 2081 | 0  | 0  | 0  | 0  | 0  | 0  | 0  | 0  | 0  | 0  | 0  | 0  |
| 2082 | 0  | 0  | 0  | 0  | 0  | 0  | 0  | 0  | 0  | 0  | 0  | 0  |
| 2083 | 0  | 0  | 0  | 0  | 0  | 0  | 0  | 0  | 0  | 0  | 0  | 0  |
| 2084 | 0  | 0  | 0  | 0  | 0  | 0  | 0  | 0  | 0  | 0  | 0  | 0  |
| 2085 | 0  | 0  | 0  | 0  | 0  | 0  | 0  | 0  | 0  | 0  | 0  | 0  |
| 2086 | 0  | 0  | 0  | 0  | 0  | 0  | 0  | 0  | 0  | 0  | 0  | 0  |
| 2087 | 0  | 0  | 0  | 0  | 0  | 0  | 0  | 0  | 0  | 0  | 0  | 0  |
| 2088 | 0  | 0  | 0  | 0  | 0  | 0  | 0  | 0  | 0  | 0  | 0  | 0  |
| 2089 | 0  | 0  | 0  | 0  | 0  | 0  | 0  | 0  | 0  | 0  | 0  | 0  |
| 2090 | 0  | 0  | 0  | 0  | 0  | 0  | 0  | 0  | 0  | 0  | 0  | 0  |



|      | 73 | 74 | 75 | 76 | 77 | 78 | 79 | 80 | 81 | 82 | 83 | 84 |
|------|----|----|----|----|----|----|----|----|----|----|----|----|
| 2002 | 0  | 0  | 0  | 0  | 0  | 0  | 0  | 0  | 0  | 0  | 0  | 0  |
| 2003 | 0  | 0  | 0  | 0  | 0  | 0  | 0  | 0  | 0  | 0  | 0  | 0  |
| 2004 | 1  | 1  | 1  | 1  | 1  | 1  | 1  | 1  | 1  | 1  | 1  | 1  |
| 2005 | 2  | 2  | 2  | 2  | 2  | 2  | 2  | 2  | 2  | 2  | 2  | 2  |
| 2006 | 3  | 3  | 3  | 3  | 3  | 3  | 3  | 3  | 3  | 3  | 3  | 3  |
| 2007 | 7  | 7  | 7  | 7  | 7  | 7  | 7  | 7  | 7  | 7  | 7  | 7  |
| 2008 | 10 | 10 | 10 | 10 | 10 | 10 | 10 | 10 | 10 | 10 | 10 | 10 |
| 2009 | 17 | 17 | 17 | 17 | 17 | 17 | 17 | 17 | 17 | 17 | 17 | 17 |
| 2010 | 19 | 19 | 19 | 19 | 19 | 19 | 19 | 19 | 19 | 19 | 19 | 19 |
| 2011 | 30 | 30 | 30 | 30 | 30 | 30 | 30 | 30 | 30 | 30 | 30 | 30 |
| 2012 | 27 | 27 | 27 | 27 | 27 | 27 | 27 | 27 | 27 | 27 | 27 | 27 |
| 2013 | 31 | 31 | 31 | 31 | 31 | 31 | 31 | 31 | 31 | 31 | 31 | 31 |
| 2014 | 32 | 32 | 32 | 32 | 32 | 32 | 32 | 32 | 32 | 32 | 32 | 32 |
| 2015 | 41 | 41 | 41 | 41 | 41 | 41 | 41 | 41 | 41 | 41 | 41 | 41 |
| 2016 | 37 | 37 | 37 | 37 | 37 | 37 | 37 | 37 | 37 | 37 | 37 | 37 |
| 2017 | 44 | 44 | 44 | 44 | 44 | 44 | 44 | 44 | 44 | 44 | 44 | 44 |
| 2018 | 44 | 44 | 44 | 44 | 44 | 44 | 44 | 44 | 44 | 44 | 44 | 44 |
| 2019 | 45 | 45 | 45 | 45 | 45 | 45 | 45 | 45 | 45 | 45 | 45 | 45 |
| 2020 | 47 | 47 | 47 | 24 | 47 | 47 | 47 | 47 | 47 | 47 | 47 | 47 |
| 2021 | 49 | 49 | 49 | 19 | 49 | 49 | 49 | 49 | 49 | 49 | 49 | 49 |
| 2022 | 47 | 47 | 47 | 24 | 47 | 47 | 47 | 47 | 47 | 47 | 47 | 47 |
| 2023 | 50 | 50 | 50 | 26 | 50 | 50 | 50 | 50 | 50 | 50 | 50 | 50 |
| 2024 | 49 | 49 | 49 | 26 | 49 | 49 | 49 | 49 | 49 | 49 | 49 | 49 |
| 2025 | 25 | 25 | 52 | 26 | 25 | 25 | 25 | 25 | 25 | 28 | 28 | 52 |
| 2026 | 15 | 15 | 51 | 26 | 15 | 15 | 15 | 15 | 15 | 17 | 17 | 51 |
| 2027 | 20 | 20 | 51 | 26 | 20 | 20 | 20 | 20 | 20 | 22 | 22 | 51 |
| 2028 | 28 | 27 | 53 | 29 | 28 | 28 | 28 | 28 | 28 | 20 | 20 | 53 |
| 2029 | 25 | 25 | 51 | 29 | 25 | 24 | 25 | 25 | 25 | 21 | 21 | 51 |
| 2030 | 25 | 25 | 24 | 28 | 24 | 25 | 25 | 25 | 25 | 23 | 23 | 28 |
| 2031 | 27 | 27 | 18 | 31 | 26 | 27 | 27 | 27 | 27 | 25 | 25 | 20 |
| 2032 | 28 | 27 | 19 | 32 | 25 | 28 | 27 | 27 | 27 | 22 | 22 | 21 |
| 2033 | 25 | 24 | 23 | 33 | 25 | 26 | 25 | 25 | 25 | 22 | 22 | 25 |
| 2034 | 29 | 29 | 28 | 38 | 29 | 31 | 29 | 29 | 29 | 25 | 25 | 23 |
| 2035 | 33 | 31 | 22 | 39 | 29 | 32 | 32 | 32 | 32 | 24 | 24 | 22 |
| 2036 | 27 | 27 | 19 | 34 | 27 | 31 | 27 | 27 | 27 | 27 | 27 | 24 |
| 2037 | 28 | 29 | 25 | 36 | 26 | 31 | 27 | 27 | 27 | 29 | 29 | 21 |
| 2038 | 27 | 26 | 29 | 35 | 26 | 34 | 26 | 26 | 26 | 29 | 29 | 19 |
| 2039 | 33 | 34 | 25 | 37 | 30 | 35 | 33 | 33 | 33 | 27 | 27 | 21 |
| 2040 | 32 | 35 | 23 | 38 | 32 | 35 | 32 | 32 | 32 | 33 | 33 | 22 |
| 2041 | 32 | 34 | 27 | 42 | 32 | 34 | 31 | 31 | 31 | 30 | 30 | 26 |
| 2042 | 33 | 33 | 26 | 40 | 31 | 36 | 33 | 33 | 33 | 30 | 30 | 26 |
| 2043 | 34 | 33 | 24 | 39 | 31 | 39 | 34 | 34 | 34 | 31 | 31 | 25 |
| 2044 | 30 | 32 | 31 | 28 | 28 | 37 | 32 | 32 | 32 | 30 | 30 | 26 |
| 2045 | 34 | 33 | 28 | 28 | 30 | 42 | 34 | 34 | 34 | 36 | 36 | 29 |
| 2046 | 29 | 29 | 28 | 26 | 29 | 28 | 29 | 29 | 29 | 25 | 25 | 28 |
| 2047 | 29 | 29 | 29 | 25 | 29 | 29 | 29 | 29 | 29 | 19 | 19 | 31 |
| 2048 | 26 | 27 | 32 | 19 | 26 | 28 | 27 | 27 | 27 | 15 | 15 | 35 |
| 2049 | 21 | 21 | 25 | 11 | 21 | 21 | 21 | 21 | 21 | 5  | 5  | 23 |
| 2050 | 17 | 17 | 20 | 6  | 17 | 18 | 17 | 17 | 17 | 3  | 3  | 22 |
| 2051 | 14 | 14 | 15 | 6  | 14 | 12 | 14 | 14 | 14 | 2  | 2  | 7  |
| 2052 | 6  | 6  | 14 | 5  | 6  | 6  | 6  | 6  | 6  | 2  | 2  | 5  |
| 2053 | 4  | 4  | 11 | 4  | 4  | 4  | 4  | 4  | 4  | 0  | 0  | 3  |
| 2054 | 3  | 3  | 3  | 2  | 3  | 3  | 3  | 3  | 3  | 2  | 2  | 2  |
| 2055 | 3  | 3  | 3  | 2  | 3  | 3  | 3  | 3  | 3  | 1  | 1  | 1  |
| 2056 | 3  | 3  | 3  | 1  | 3  | 1  | 3  | 3  | 3  | 1  | 1  | 1  |
| 2057 | 1  | 1  | 3  | 1  | 1  | 0  | 1  | 1  | 1  | 0  | 0  | 0  |
| 2058 | 1  | 1  | 1  | 0  | 1  | 0  | 1  | 1  | 1  | 0  | 0  | 0  |
| 2059 | 1  | 1  | 0  | 0  | 1  | 0  | 1  | 1  | 1  | 0  | 0  | 0  |

|      | 73 | 74 | 75 | 76 | 77 | 78 | 79 | 80 | 81 | 82 | 83 | 84 |
|------|----|----|----|----|----|----|----|----|----|----|----|----|
| 2060 | 0  | 0  | 0  | 0  | 0  | 0  | 0  | 0  | 0  | 0  | 0  | 0  |
| 2061 | 0  | 0  | 0  | 0  | 0  | 0  | 0  | 0  | 0  | 0  | 0  | 0  |
| 2062 | 0  | 0  | 0  | 0  | 0  | 0  | 0  | 0  | 0  | 0  | 0  | 0  |
| 2063 | 0  | 0  | 0  | 0  | 0  | 0  | 0  | 0  | 0  | 0  | 0  | 0  |
| 2064 | 0  | 0  | 0  | 0  | 0  | 0  | 0  | 0  | 0  | 0  | 0  | 0  |
| 2065 | 0  | 0  | 0  | 0  | 0  | 0  | 0  | 0  | 0  | 0  | 0  | 0  |
| 2066 | 0  | 0  | 0  | 0  | 0  | 0  | 0  | 0  | 0  | 0  | 0  | 0  |
| 2067 | 0  | 0  | 0  | 0  | 0  | 0  | 0  | 0  | 0  | 0  | 0  | 0  |
| 2068 | 0  | 0  | 0  | 0  | 0  | 0  | 0  | 0  | 0  | 0  | 0  | 0  |
| 2069 | 0  | 0  | 0  | 0  | 0  | 0  | 0  | 0  | 0  | 0  | 0  | 0  |
| 2070 | 0  | 0  | 0  | 0  | 0  | 0  | 0  | 0  | 0  | 0  | 0  | 0  |
| 2071 | 0  | 0  | 0  | 0  | 0  | 0  | 0  | 0  | 0  | 0  | 0  | 0  |
| 2072 | 0  | 0  | 0  | 0  | 0  | 0  | 0  | 0  | 0  | 0  | 0  | 0  |
| 2073 | 0  | 0  | 0  | 0  | 0  | 0  | 0  | 0  | 0  | 0  | 0  | 0  |
| 2074 | 0  | 0  | 0  | 0  | 0  | 0  | 0  | 0  | 0  | 0  | 0  | 0  |
| 2075 | 0  | 0  | 0  | 0  | 0  | 0  | 0  | 0  | 0  | 0  | 0  | 0  |
| 2076 | 0  | 0  | 0  | 0  | 0  | 0  | 0  | 0  | 0  | 0  | 0  | 0  |
| 2077 | 0  | 0  | 0  | 0  | 0  | 0  | 0  | 0  | 0  | 0  | 0  | 0  |
| 2078 | 0  | 0  | 0  | 0  | 0  | 0  | 0  | 0  | 0  | 0  | 0  | 0  |
| 2079 | 0  | 0  | 0  | 0  | 0  | 0  | 0  | 0  | 0  | 0  | 0  | 0  |
| 2080 | 0  | 0  | 0  | 0  | 0  | 0  | 0  | 0  | 0  | 0  | 0  | 0  |
| 2081 | 0  | 0  | 0  | 0  | 0  | 0  | 0  | 0  | 0  | 0  | 0  | 0  |
| 2082 | 0  | 0  | 0  | 0  | 0  | 0  | 0  | 0  | 0  | 0  | 0  | 0  |
| 2083 | 0  | 0  | 0  | 0  | 0  | 0  | 0  | 0  | 0  | 0  | 0  | 0  |
| 2084 | 0  | 0  | 0  | 0  | 0  | 0  | 0  | 0  | 0  | 0  | 0  | 0  |
| 2085 | 0  | 0  | 0  | 0  | 0  | 0  | 0  | 0  | 0  | 0  | 0  | 0  |
| 2086 | 0  | 0  | 0  | 0  | 0  | 0  | 0  | 0  | 0  | 0  | 0  | 0  |
| 2087 | 0  | 0  | 0  | 0  | 0  | 0  | 0  | 0  | 0  | 0  | 0  | 0  |
| 2088 | 0  | 0  | 0  | 0  | 0  | 0  | 0  | 0  | 0  | 0  | 0  | 0  |
| 2089 | 0  | 0  | 0  | 0  | 0  | 0  | 0  | 0  | 0  | 0  | 0  | 0  |
| 2090 | 0  | 0  | 0  | 0  | 0  | 0  | 0  | 0  | 0  | 0  | 0  | 0  |

|      | 85 | 86 | 87 | 88 | 89 | 90 | 91 | 92 | 93 | 94 | 95 | 96 |
|------|----|----|----|----|----|----|----|----|----|----|----|----|
| 2002 | 0  | 0  | 0  | 0  | 0  | 0  | 0  | 0  | 0  | 0  | 0  | 0  |
| 2003 | 0  | 0  | 0  | 0  | 0  | 0  | 0  | 0  | 0  | 0  | 0  | 0  |
| 2004 | 1  | 1  | 1  | 1  | 1  | 1  | 1  | 1  | 1  | 1  | 1  | 1  |
| 2005 | 2  | 2  | 2  | 2  | 2  | 2  | 2  | 2  | 2  | 2  | 2  | 2  |
| 2006 | 3  | 3  | 3  | 3  | 3  | 3  | 3  | 3  | 3  | 3  | 3  | 3  |
| 2007 | 7  | 7  | 7  | 7  | 7  | 7  | 7  | 7  | 7  | 7  | 7  | 7  |
| 2008 | 10 | 10 | 10 | 10 | 10 | 10 | 10 | 10 | 10 | 10 | 10 | 10 |
| 2009 | 17 | 17 | 17 | 17 | 17 | 17 | 17 | 17 | 17 | 17 | 17 | 17 |
| 2010 | 19 | 19 | 19 | 19 | 19 | 19 | 19 | 19 | 19 | 19 | 19 | 19 |
| 2011 | 30 | 30 | 30 | 30 | 30 | 30 | 30 | 30 | 30 | 30 | 30 | 30 |
| 2012 | 27 | 27 | 27 | 27 | 27 | 27 | 27 | 27 | 27 | 27 | 27 | 27 |
| 2013 | 31 | 31 | 31 | 31 | 31 | 31 | 31 | 31 | 31 | 31 | 31 | 31 |
| 2014 | 32 | 32 | 32 | 32 | 32 | 32 | 32 | 32 | 32 | 32 | 32 | 32 |
| 2015 | 41 | 41 | 41 | 41 | 41 | 41 | 41 | 41 | 41 | 41 | 41 | 41 |
| 2016 | 37 | 37 | 37 | 37 | 37 | 37 | 37 | 37 | 37 | 37 | 37 | 37 |
| 2017 | 44 | 44 | 44 | 44 | 44 | 44 | 44 | 44 | 44 | 44 | 44 | 44 |
| 2018 | 44 | 44 | 44 | 44 | 44 | 44 | 44 | 44 | 44 | 44 | 44 | 44 |
| 2019 | 45 | 45 | 45 | 45 | 45 | 45 | 45 | 45 | 45 | 45 | 45 | 45 |
| 2020 | 27 | 47 | 47 | 47 | 47 | 47 | 47 | 47 | 47 | 24 | 47 | 47 |
| 2021 | 21 | 49 | 49 | 49 | 49 | 49 | 49 | 49 | 49 | 19 | 49 | 49 |
| 2022 | 23 | 47 | 47 | 47 | 47 | 47 | 47 | 47 | 47 | 23 | 47 | 47 |
| 2023 | 24 | 50 | 50 | 50 | 50 | 50 | 50 | 50 | 50 | 26 | 50 | 50 |
| 2024 | 23 | 49 | 49 | 49 | 49 | 49 | 49 | 49 | 49 | 26 | 49 | 49 |
| 2025 | 26 | 28 | 28 | 28 | 28 | 28 | 25 | 25 | 52 | 26 | 25 | 25 |
| 2026 | 27 | 17 | 17 | 17 | 17 | 17 | 15 | 15 | 51 | 26 | 15 | 15 |
| 2027 | 27 | 22 | 22 | 22 | 22 | 22 | 20 | 20 | 51 | 28 | 20 | 20 |
| 2028 | 25 | 20 | 20 | 20 | 20 | 20 | 27 | 27 | 53 | 29 | 27 | 27 |
| 2029 | 27 | 21 | 21 | 21 | 21 | 21 | 25 | 25 | 51 | 31 | 26 | 26 |
| 2030 | 26 | 23 | 23 | 23 | 23 | 23 | 25 | 25 | 24 | 31 | 25 | 25 |
| 2031 | 29 | 25 | 25 | 25 | 25 | 25 | 27 | 27 | 18 | 34 | 27 | 29 |
| 2032 | 27 | 22 | 22 | 22 | 22 | 22 | 26 | 26 | 19 | 40 | 26 | 28 |
| 2033 | 31 | 22 | 22 | 22 | 22 | 22 | 23 | 23 | 23 | 39 | 25 | 25 |
| 2034 | 30 | 25 | 26 | 25 | 25 | 25 | 31 | 31 | 28 | 43 | 30 | 31 |
| 2035 | 33 | 24 | 28 | 24 | 24 | 24 | 33 | 33 | 21 | 38 | 32 | 34 |
| 2036 | 33 | 27 | 32 | 27 | 27 | 27 | 29 | 29 | 18 | 31 | 27 | 31 |
| 2037 | 32 | 28 | 30 | 29 | 29 | 29 | 30 | 30 | 25 | 35 | 28 | 33 |
| 2038 | 29 | 29 | 30 | 29 | 29 | 29 | 31 | 31 | 28 | 32 | 28 | 36 |
| 2039 | 30 | 26 | 29 | 27 | 27 | 27 | 33 | 33 | 27 | 36 | 32 | 33 |
| 2040 | 32 | 30 | 27 | 33 | 33 | 33 | 33 | 33 | 24 | 35 | 33 | 34 |
| 2041 | 29 | 27 | 29 | 30 | 30 | 30 | 30 | 30 | 28 | 37 | 31 | 37 |
| 2042 | 28 | 31 | 30 | 30 | 30 | 30 | 32 | 32 | 24 | 38 | 30 | 32 |
| 2043 | 34 | 30 | 31 | 31 | 31 | 31 | 31 | 31 | 24 | 33 | 33 | 37 |
| 2044 | 21 | 31 | 31 | 30 | 30 | 30 | 24 | 24 | 25 | 34 | 30 | 31 |
| 2045 | 20 | 36 | 35 | 36 | 36 | 36 | 28 | 28 | 26 | 38 | 27 | 39 |
| 2046 | 17 | 25 | 24 | 25 | 25 | 25 | 25 | 25 | 26 | 33 | 27 | 37 |
| 2047 | 8  | 20 | 20 | 19 | 19 | 19 | 28 | 28 | 27 | 29 | 30 | 30 |
| 2048 | 7  | 15 | 15 | 15 | 15 | 15 | 31 | 31 | 26 | 29 | 31 | 31 |
| 2049 | 2  | 5  | 5  | 5  | 5  | 5  | 30 | 30 | 32 | 27 | 30 | 25 |
| 2050 | 1  | 3  | 4  | 3  | 3  | 3  | 27 | 27 | 25 | 26 | 27 | 22 |
| 2051 | 2  | 2  | 3  | 2  | 2  | 2  | 21 | 21 | 20 | 20 | 21 | 18 |
| 2052 | 2  | 2  | 2  | 2  | 2  | 2  | 17 | 17 | 15 | 14 | 17 | 10 |
| 2053 | 0  | 0  | 0  | 0  | 0  | 0  | 14 | 14 | 14 | 9  | 14 | 6  |
| 2054 | 2  | 2  | 2  | 2  | 2  | 2  | 6  | 6  | 11 | 8  | 6  | 4  |
| 2055 | 1  | 1  | 1  | 1  | 1  | 1  | 4  | 4  | 3  | 5  | 4  | 3  |
| 2056 | 1  | 1  | 1  | 1  | 1  | 1  | 3  | 3  | 3  | 4  | 3  | 3  |
| 2057 | 0  | 0  | 0  | 0  | 0  | 0  | 3  | 3  | 3  | 3  | 3  | 2  |
| 2058 | 0  | 0  | 0  | 0  | 0  | 0  | 3  | 3  | 3  | 3  | 3  | 1  |
| 2059 | 0  | 0  | 0  | 0  | 0  | 0  | 1  | 1  | 1  | 3  | 1  | 1  |

|      | 85 | 86 | 87 | 88 | 89 | 90 | 91 | 92 | 93 | 94 | 95 | 96 |
|------|----|----|----|----|----|----|----|----|----|----|----|----|
| 2060 | 0  | 0  | 0  | 0  | 0  | 0  | 1  | 1  | 0  | 2  | 1  | 1  |
| 2061 | 0  | 0  | 0  | 0  | 0  | 0  | 1  | 1  | 0  | 1  | 1  | 0  |
| 2062 | 0  | 0  | 0  | 0  | 0  | 0  | 0  | 0  | 0  | 0  | 0  | 0  |
| 2063 | 0  | 0  | 0  | 0  | 0  | 0  | 0  | 0  | 0  | 0  | 0  | 0  |
| 2064 | 0  | 0  | 0  | 0  | 0  | 0  | 0  | 0  | 0  | 0  | 0  | 0  |
| 2065 | 0  | 0  | 0  | 0  | 0  | 0  | 0  | 0  | 0  | 0  | 0  | 0  |
| 2066 | 0  | 0  | 0  | 0  | 0  | 0  | 0  | 0  | 0  | 0  | 0  | 0  |
| 2067 | 0  | 0  | 0  | 0  | 0  | 0  | 0  | 0  | 0  | 0  | 0  | 0  |
| 2068 | 0  | 0  | 0  | 0  | 0  | 0  | 0  | 0  | 0  | 0  | 0  | 0  |
| 2069 | 0  | 0  | 0  | 0  | 0  | 0  | 0  | 0  | 0  | 0  | 0  | 0  |
| 2070 | 0  | 0  | 0  | 0  | 0  | 0  | 0  | 0  | 0  | 0  | 0  | 0  |
| 2071 | 0  | 0  | 0  | 0  | 0  | 0  | 0  | 0  | 0  | 0  | 0  | 0  |
| 2072 | 0  | 0  | 0  | 0  | 0  | 0  | 0  | 0  | 0  | 0  | 0  | 0  |
| 2073 | 0  | 0  | 0  | 0  | 0  | 0  | 0  | 0  | 0  | 0  | 0  | 0  |
| 2074 | 0  | 0  | 0  | 0  | 0  | 0  | 0  | 0  | 0  | 0  | 0  | 0  |
| 2075 | 0  | 0  | 0  | 0  | 0  | 0  | 0  | 0  | 0  | 0  | 0  | 0  |
| 2076 | 0  | 0  | 0  | 0  | 0  | 0  | 0  | 0  | 0  | 0  | 0  | 0  |
| 2077 | 0  | 0  | 0  | 0  | 0  | 0  | 0  | 0  | 0  | 0  | 0  | 0  |
| 2078 | 0  | 0  | 0  | 0  | 0  | 0  | 0  | 0  | 0  | 0  | 0  | 0  |
| 2079 | 0  | 0  | 0  | 0  | 0  | 0  | 0  | 0  | 0  | 0  | 0  | 0  |
| 2080 | 0  | 0  | 0  | 0  | 0  | 0  | 0  | 0  | 0  | 0  | 0  | 0  |
| 2081 | 0  | 0  | 0  | 0  | 0  | 0  | 0  | 0  | 0  | 0  | 0  | 0  |
| 2082 | 0  | 0  | 0  | 0  | 0  | 0  | 0  | 0  | 0  | 0  | 0  | 0  |
| 2083 | 0  | 0  | 0  | 0  | 0  | 0  | 0  | 0  | 0  | 0  | 0  | 0  |
| 2084 | 0  | 0  | 0  | 0  | 0  | 0  | 0  | 0  | 0  | 0  | 0  | 0  |
| 2085 | 0  | 0  | 0  | 0  | 0  | 0  | 0  | 0  | 0  | 0  | 0  | 0  |
| 2086 | 0  | 0  | 0  | 0  | 0  | 0  | 0  | 0  | 0  | 0  | 0  | 0  |
| 2087 | 0  | 0  | 0  | 0  | 0  | 0  | 0  | 0  | 0  | 0  | 0  | 0  |
| 2088 | 0  | 0  | 0  | 0  | 0  | 0  | 0  | 0  | 0  | 0  | 0  | 0  |
| 2089 | 0  | 0  | 0  | 0  | 0  | 0  | 0  | 0  | 0  | 0  | 0  | 0  |
| 2090 | 0  | 0  | 0  | 0  | 0  | 0  | 0  | 0  | 0  | 0  | 0  | 0  |

|      | 97 | 98 | 99 | 100 | 101 | 102 | 103 | 104 | 105 | 106 | 107 | 108 |
|------|----|----|----|-----|-----|-----|-----|-----|-----|-----|-----|-----|
| 2002 | 0  | 0  | 0  | 0   | 0   | 0   | 0   | 0   | 0   | 0   | 0   | 0   |
| 2003 | 0  | 0  | 0  | 0   | 0   | 0   | 0   | 0   | 0   | 0   | 0   | 0   |
| 2004 | 1  | 1  | 1  | 1   | 1   | 1   | 1   | 1   | 1   | 1   | 1   | 1   |
| 2005 | 2  | 2  | 2  | 2   | 2   | 2   | 2   | 2   | 2   | 2   | 2   | 2   |
| 2006 | 3  | 3  | 3  | 3   | 3   | 3   | 3   | 3   | 3   | 3   | 3   | 3   |
| 2007 | 7  | 7  | 7  | 7   | 7   | 7   | 7   | 7   | 7   | 7   | 7   | 7   |
| 2008 | 10 | 10 | 10 | 10  | 10  | 10  | 10  | 10  | 10  | 10  | 10  | 10  |
| 2009 | 17 | 17 | 17 | 17  | 17  | 17  | 17  | 17  | 17  | 17  | 17  | 17  |
| 2010 | 19 | 19 | 19 | 19  | 19  | 19  | 19  | 19  | 19  | 19  | 19  | 19  |
| 2011 | 30 | 30 | 30 | 30  | 30  | 30  | 30  | 30  | 30  | 30  | 30  | 30  |
| 2012 | 27 | 27 | 27 | 27  | 27  | 27  | 27  | 27  | 27  | 27  | 27  | 27  |
| 2013 | 31 | 31 | 31 | 31  | 31  | 31  | 31  | 31  | 31  | 31  | 31  | 31  |
| 2014 | 32 | 32 | 32 | 32  | 32  | 32  | 32  | 32  | 32  | 32  | 32  | 32  |
| 2015 | 41 | 41 | 41 | 41  | 41  | 41  | 41  | 41  | 41  | 41  | 41  | 41  |
| 2016 | 37 | 37 | 37 | 37  | 37  | 37  | 37  | 37  | 37  | 37  | 37  | 37  |
| 2017 | 44 | 44 | 44 | 44  | 44  | 44  | 44  | 44  | 44  | 44  | 44  | 44  |
| 2018 | 44 | 44 | 44 | 44  | 44  | 44  | 44  | 44  | 44  | 44  | 44  | 44  |
| 2019 | 45 | 45 | 45 | 45  | 45  | 45  | 45  | 45  | 45  | 45  | 45  | 45  |
| 2020 | 47 | 47 | 47 | 47  | 47  | 47  | 24  | 47  | 47  | 47  | 47  | 47  |
| 2021 | 49 | 49 | 49 | 49  | 49  | 49  | 19  | 49  | 49  | 49  | 49  | 49  |
| 2022 | 47 | 47 | 47 | 47  | 47  | 47  | 23  | 47  | 47  | 47  | 47  | 47  |
| 2023 | 50 | 50 | 50 | 50  | 50  | 50  | 26  | 50  | 50  | 50  | 50  | 50  |
| 2024 | 49 | 49 | 49 | 49  | 49  | 49  | 26  | 49  | 49  | 49  | 49  | 49  |
| 2025 | 25 | 25 | 25 | 25  | 25  | 52  | 26  | 25  | 25  | 25  | 25  | 25  |
| 2026 | 15 | 15 | 15 | 15  | 15  | 51  | 26  | 15  | 15  | 15  | 15  | 15  |
| 2027 | 20 | 20 | 20 | 20  | 20  | 51  | 26  | 20  | 20  | 20  | 20  | 20  |
| 2028 | 27 | 27 | 27 | 27  | 27  | 53  | 29  | 27  | 28  | 27  | 27  | 27  |
| 2029 | 25 | 25 | 25 | 25  | 25  | 51  | 30  | 25  | 25  | 25  | 25  | 25  |
| 2030 | 25 | 25 | 25 | 25  | 25  | 24  | 28  | 24  | 25  | 25  | 25  | 25  |
| 2031 | 27 | 27 | 27 | 27  | 27  | 18  | 31  | 26  | 27  | 27  | 27  | 27  |
| 2032 | 26 | 26 | 26 | 27  | 27  | 19  | 33  | 25  | 27  | 27  | 27  | 27  |
| 2033 | 23 | 23 | 23 | 24  | 24  | 23  | 31  | 23  | 24  | 24  | 24  | 24  |
| 2034 | 31 | 31 | 31 | 28  | 28  | 28  | 36  | 28  | 31  | 28  | 28  | 28  |
| 2035 | 33 | 33 | 33 | 32  | 32  | 21  | 36  | 29  | 32  | 32  | 32  | 32  |
| 2036 | 29 | 29 | 29 | 27  | 27  | 18  | 35  | 26  | 30  | 27  | 27  | 27  |
| 2037 | 30 | 30 | 30 | 30  | 30  | 25  | 35  | 27  | 31  | 30  | 30  | 30  |
| 2038 | 31 | 31 | 31 | 27  | 27  | 28  | 34  | 24  | 34  | 27  | 27  | 27  |
| 2039 | 33 | 33 | 33 | 31  | 31  | 25  | 36  | 31  | 36  | 31  | 31  | 31  |
| 2040 | 33 | 33 | 33 | 33  | 33  | 23  | 38  | 33  | 37  | 33  | 33  | 33  |
| 2041 | 30 | 30 | 30 | 34  | 34  | 27  | 40  | 31  | 34  | 34  | 34  | 34  |
| 2042 | 32 | 32 | 32 | 31  | 31  | 27  | 41  | 31  | 36  | 31  | 31  | 31  |
| 2043 | 31 | 31 | 31 | 33  | 33  | 25  | 45  | 30  | 39  | 33  | 33  | 33  |
| 2044 | 24 | 24 | 24 | 31  | 31  | 27  | 28  | 27  | 37  | 31  | 31  | 31  |
| 2045 | 28 | 28 | 28 | 34  | 34  | 27  | 28  | 30  | 42  | 34  | 34  | 34  |
| 2046 | 25 | 25 | 25 | 29  | 29  | 30  | 26  | 29  | 28  | 29  | 29  | 29  |
| 2047 | 28 | 28 | 28 | 29  | 29  | 29  | 26  | 29  | 30  | 29  | 29  | 29  |
| 2048 | 31 | 31 | 31 | 26  | 26  | 26  | 21  | 26  | 28  | 26  | 26  | 26  |
| 2049 | 30 | 30 | 30 | 21  | 21  | 32  | 13  | 21  | 21  | 21  | 21  | 21  |
| 2050 | 27 | 27 | 27 | 17  | 17  | 25  | 8   | 17  | 18  | 17  | 17  | 17  |
| 2051 | 21 | 21 | 21 | 14  | 14  | 20  | 7   | 14  | 11  | 14  | 14  | 14  |
| 2052 | 17 | 17 | 17 | 6   | 6   | 15  | 5   | 6   | 7   | 6   | 6   | 6   |
| 2053 | 14 | 14 | 14 | 4   | 4   | 14  | 4   | 4   | 4   | 4   | 4   | 4   |
| 2054 | 6  | 6  | 6  | 3   | 3   | 11  | 2   | 3   | 3   | 3   | 3   | 3   |
| 2055 | 4  | 4  | 4  | 3   | 3   | 3   | 2   | 3   | 3   | 3   | 3   | 3   |
| 2056 | 3  | 3  | 3  | 3   | 3   | 3   | 2   | 3   | 2   | 3   | 3   | 3   |
| 2057 | 3  | 3  | 3  | 1   | 1   | 3   | 1   | 1   | 0   | 1   | 1   | 1   |
| 2058 | 3  | 3  | 3  | 1   | 1   | 3   | 1   | 1   | 0   | 1   | 1   | 1   |
| 2059 | 1  | 1  | 1  | 1   | 1   | 1   | 0   | 1   | 0   | 1   | 1   | 1   |

Pools

|      | 97 | 98 | 99 | 100 | 101 | 102 | 103 | 104 | 105 | 106 | 107 | 108 |
|------|----|----|----|-----|-----|-----|-----|-----|-----|-----|-----|-----|
| 2060 | 1  | 1  | 1  | 0   | 0   | 0   | 0   | 0   | 0   | 0   | 0   | 0   |
| 2061 | 1  | 1  | 1  | 0   | 0   | 0   | 0   | 0   | 0   | 0   | 0   | 0   |
| 2062 | 0  | 0  | 0  | 0   | 0   | 0   | 0   | 0   | 0   | 0   | 0   | 0   |
| 2063 | 0  | 0  | 0  | 0   | 0   | 0   | 0   | 0   | 0   | 0   | 0   | 0   |
| 2064 | 0  | 0  | 0  | 0   | 0   | 0   | 0   | 0   | 0   | 0   | 0   | 0   |
| 2065 | 0  | 0  | 0  | 0   | 0   | 0   | 0   | 0   | 0   | 0   | 0   | 0   |
| 2066 | 0  | 0  | 0  | 0   | 0   | 0   | 0   | 0   | 0   | 0   | 0   | 0   |
| 2067 | 0  | 0  | 0  | 0   | 0   | 0   | 0   | 0   | 0   | 0   | 0   | 0   |
| 2068 | 0  | 0  | 0  | 0   | 0   | 0   | 0   | 0   | 0   | 0   | 0   | 0   |
| 2069 | 0  | 0  | 0  | 0   | 0   | 0   | 0   | 0   | 0   | 0   | 0   | 0   |
| 2070 | 0  | 0  | 0  | 0   | 0   | 0   | 0   | 0   | 0   | 0   | 0   | 0   |
| 2071 | 0  | 0  | 0  | 0   | 0   | 0   | 0   | 0   | 0   | 0   | 0   | 0   |
| 2072 | 0  | 0  | 0  | 0   | 0   | 0   | 0   | 0   | 0   | 0   | 0   | 0   |
| 2073 | 0  | 0  | 0  | 0   | 0   | 0   | 0   | 0   | 0   | 0   | 0   | 0   |
| 2074 | 0  | 0  | 0  | 0   | 0   | 0   | 0   | 0   | 0   | 0   | 0   | 0   |
| 2075 | 0  | 0  | 0  | 0   | 0   | 0   | 0   | 0   | 0   | 0   | 0   | 0   |
| 2076 | 0  | 0  | 0  | 0   | 0   | 0   | 0   | 0   | 0   | 0   | 0   | 0   |
| 2077 | 0  | 0  | 0  | 0   | 0   | 0   | 0   | 0   | 0   | 0   | 0   | 0   |
| 2078 | 0  | 0  | 0  | 0   | 0   | 0   | 0   | 0   | 0   | 0   | 0   | 0   |
| 2079 | 0  | 0  | 0  | 0   | 0   | 0   | 0   | 0   | 0   | 0   | 0   | 0   |
| 2080 | 0  | 0  | 0  | 0   | 0   | 0   | 0   | 0   | 0   | 0   | 0   | 0   |
| 2081 | 0  | 0  | 0  | 0   | 0   | 0   | 0   | 0   | 0   | 0   | 0   | 0   |
| 2082 | 0  | 0  | 0  | 0   | 0   | 0   | 0   | 0   | 0   | 0   | 0   | 0   |
| 2083 | 0  | 0  | 0  | 0   | 0   | 0   | 0   | 0   | 0   | 0   | 0   | 0   |
| 2084 | 0  | 0  | 0  | 0   | 0   | 0   | 0   | 0   | 0   | 0   | 0   | 0   |
| 2085 | 0  | 0  | 0  | 0   | 0   | 0   | 0   | 0   | 0   | 0   | 0   | 0   |
| 2086 | 0  | 0  | 0  | 0   | 0   | 0   | 0   | 0   | 0   | 0   | 0   | 0   |
| 2087 | 0  | 0  | 0  | 0   | 0   | 0   | 0   | 0   | 0   | 0   | 0   | 0   |
| 2088 | 0  | 0  | 0  | 0   | 0   | 0   | 0   | 0   | 0   | 0   | 0   | 0   |
| 2089 | 0  | 0  | 0  | 0   | 0   | 0   | 0   | 0   | 0   | 0   | 0   | 0   |
| 2090 | 0  | 0  | 0  | 0   | 0   | 0   | 0   | 0   | 0   | 0   | 0   | 0   |

|      | 109 | 110 | 111 | 112 | 113 | 114 | 115 | 116 | 117 | 118 | 119 | 120 |
|------|-----|-----|-----|-----|-----|-----|-----|-----|-----|-----|-----|-----|
| 2002 | 0   | 0   | 0   | 0   | 0   | 0   | 0   | 0   | 0   | 0   | 0   | 0   |
| 2003 | 0   | 0   | 0   | 0   | 0   | 0   | 0   | 0   | 0   | 0   | 0   | 0   |
| 2004 | 1   | 1   | 1   | 1   | 1   | 1   | 1   | 1   | 1   | 1   | 1   | 1   |
| 2005 | 2   | 2   | 2   | 2   | 2   | 2   | 2   | 2   | 2   | 2   | 2   | 2   |
| 2006 | 3   | 3   | 3   | 3   | 3   | 3   | 3   | 3   | 3   | 3   | 3   | 3   |
| 2007 | 7   | 7   | 7   | 7   | 7   | 7   | 7   | 7   | 7   | 7   | 7   | 7   |
| 2008 | 10  | 10  | 10  | 10  | 10  | 10  | 10  | 10  | 10  | 10  | 10  | 10  |
| 2009 | 17  | 17  | 17  | 17  | 17  | 17  | 17  | 17  | 17  | 17  | 17  | 17  |
| 2010 | 19  | 19  | 19  | 19  | 19  | 19  | 19  | 19  | 19  | 19  | 19  | 19  |
| 2011 | 30  | 30  | 30  | 30  | 30  | 30  | 30  | 30  | 30  | 30  | 30  | 30  |
| 2012 | 27  | 27  | 27  | 27  | 27  | 27  | 27  | 27  | 27  | 27  | 27  | 27  |
| 2013 | 31  | 31  | 31  | 31  | 31  | 31  | 31  | 31  | 31  | 31  | 31  | 31  |
| 2014 | 32  | 32  | 32  | 32  | 32  | 32  | 32  | 32  | 32  | 32  | 32  | 32  |
| 2015 | 41  | 41  | 41  | 41  | 41  | 41  | 41  | 41  | 41  | 41  | 41  | 41  |
| 2016 | 37  | 37  | 37  | 37  | 37  | 37  | 37  | 37  | 37  | 37  | 37  | 37  |
| 2017 | 44  | 44  | 44  | 44  | 44  | 44  | 44  | 44  | 44  | 44  | 44  | 44  |
| 2018 | 44  | 44  | 44  | 44  | 44  | 44  | 44  | 44  | 44  | 44  | 44  | 44  |
| 2019 | 45  | 45  | 45  | 45  | 45  | 45  | 45  | 45  | 45  | 45  | 45  | 45  |
| 2020 | 47  | 47  | 47  | 27  | 47  | 47  | 47  | 47  | 47  | 47  | 47  | 47  |
| 2021 | 49  | 49  | 49  | 25  | 49  | 49  | 49  | 49  | 49  | 49  | 49  | 49  |
| 2022 | 47  | 47  | 47  | 25  | 47  | 47  | 47  | 47  | 47  | 47  | 47  | 47  |
| 2023 | 50  | 50  | 50  | 25  | 50  | 50  | 50  | 50  | 50  | 50  | 50  | 50  |
| 2024 | 49  | 49  | 49  | 25  | 49  | 49  | 49  | 49  | 49  | 49  | 49  | 49  |
| 2025 | 28  | 28  | 52  | 25  | 28  | 28  | 28  | 28  | 28  | 25  | 25  | 52  |
| 2026 | 23  | 23  | 51  | 27  | 23  | 23  | 23  | 23  | 23  | 24  | 24  | 51  |
| 2027 | 25  | 25  | 51  | 27  | 25  | 25  | 25  | 25  | 25  | 24  | 24  | 51  |
| 2028 | 25  | 25  | 53  | 27  | 25  | 25  | 25  | 25  | 25  | 26  | 26  | 53  |
| 2029 | 24  | 24  | 51  | 25  | 24  | 24  | 24  | 24  | 24  | 25  | 24  | 51  |
| 2030 | 25  | 25  | 28  | 29  | 25  | 25  | 25  | 25  | 25  | 26  | 25  | 24  |
| 2031 | 27  | 27  | 25  | 26  | 27  | 27  | 27  | 27  | 27  | 27  | 27  | 25  |
| 2032 | 26  | 26  | 24  | 29  | 26  | 26  | 26  | 26  | 26  | 26  | 26  | 25  |
| 2033 | 24  | 24  | 27  | 27  | 24  | 25  | 24  | 24  | 24  | 24  | 25  | 26  |
| 2034 | 27  | 27  | 26  | 26  | 27  | 27  | 27  | 27  | 27  | 27  | 27  | 27  |
| 2035 | 26  | 26  | 25  | 30  | 26  | 26  | 26  | 26  | 26  | 29  | 29  | 24  |
| 2036 | 28  | 28  | 27  | 36  | 28  | 28  | 28  | 28  | 28  | 23  | 24  | 24  |
| 2037 | 24  | 24  | 25  | 26  | 24  | 29  | 24  | 24  | 24  | 28  | 26  | 25  |
| 2038 | 30  | 30  | 25  | 27  | 29  | 30  | 30  | 30  | 30  | 28  | 28  | 25  |
| 2039 | 27  | 27  | 26  | 30  | 28  | 27  | 26  | 26  | 26  | 27  | 28  | 24  |
| 2040 | 29  | 29  | 28  | 31  | 29  | 28  | 29  | 29  | 29  | 27  | 27  | 23  |
| 2041 | 26  | 27  | 24  | 27  | 28  | 27  | 28  | 28  | 28  | 29  | 29  | 26  |
| 2042 | 31  | 29  | 27  | 35  | 32  | 29  | 30  | 30  | 30  | 29  | 29  | 26  |
| 2043 | 30  | 29  | 27  | 26  | 16  | 30  | 31  | 31  | 31  | 26  | 26  | 27  |
| 2044 | 35  | 35  | 28  | 22  | 35  | 34  | 34  | 34  | 34  | 25  | 24  | 24  |
| 2045 | 24  | 24  | 29  | 17  | 23  | 24  | 23  | 23  | 23  | 27  | 23  | 24  |
| 2046 | 21  | 21  | 39  | 13  | 21  | 21  | 21  | 21  | 21  | 24  | 23  | 23  |
| 2047 | 13  | 13  | 25  | 5   | 13  | 12  | 13  | 13  | 13  | 21  | 27  | 25  |
| 2048 | 9   | 9   | 22  | 7   | 8   | 10  | 8   | 8   | 8   | 26  | 27  | 32  |
| 2049 | 4   | 3   | 6   | 3   | 3   | 4   | 3   | 3   | 3   | 32  | 32  | 25  |
| 2050 | 1   | 1   | 4   | 1   | 1   | 2   | 1   | 1   | 1   | 30  | 30  | 20  |
| 2051 | 2   | 2   | 3   | 2   | 2   | 3   | 2   | 2   | 2   | 27  | 27  | 15  |
| 2052 | 2   | 2   | 2   | 2   | 2   | 2   | 2   | 2   | 2   | 21  | 21  | 14  |
| 2053 | 0   | 0   | 0   | 0   | 0   | 0   | 0   | 0   | 0   | 17  | 17  | 11  |
| 2054 | 2   | 2   | 2   | 2   | 2   | 2   | 2   | 2   | 2   | 14  | 14  | 3   |
| 2055 | 1   | 1   | 1   | 1   | 1   | 1   | 1   | 1   | 1   | 6   | 6   | 3   |
| 2056 | 1   | 1   | 1   | 1   | 1   | 1   | 1   | 1   | 1   | 4   | 4   | 3   |
| 2057 | 0   | 0   | 0   | 0   | 0   | 0   | 0   | 0   | 0   | 3   | 3   | 3   |
| 2058 | 0   | 0   | 0   | 0   | 0   | 0   | 0   | 0   | 0   | 3   | 3   | 1   |
| 2059 | 0   | 0   | 0   | 0   | 0   | 0   | 0   | 0   | 0   | 3   | 3   | 0   |

|      | 109 | 110 | 111 | 112 | 113 | 114 | 115 | 116 | 117 | 118 | 119 | 120 |
|------|-----|-----|-----|-----|-----|-----|-----|-----|-----|-----|-----|-----|
| 2060 | 0   | 0   | 0   | 0   | 0   | 0   | 0   | 0   | 0   | 1   | 1   | 0   |
| 2061 | 0   | 0   | 0   | 0   | 0   | 0   | 0   | 0   | 0   | 1   | 1   | 0   |
| 2062 | 0   | 0   | 0   | 0   | 0   | 0   | 0   | 0   | 0   | 1   | 1   | 0   |
| 2063 | 0   | 0   | 0   | 0   | 0   | 0   | 0   | 0   | 0   | 0   | 0   | 0   |
| 2064 | 0   | 0   | 0   | 0   | 0   | 0   | 0   | 0   | 0   | 0   | 0   | 0   |
| 2065 | 0   | 0   | 0   | 0   | 0   | 0   | 0   | 0   | 0   | 0   | 0   | 0   |
| 2066 | 0   | 0   | 0   | 0   | 0   | 0   | 0   | 0   | 0   | 0   | 0   | 0   |
| 2067 | 0   | 0   | 0   | 0   | 0   | 0   | 0   | 0   | 0   | 0   | 0   | 0   |
| 2068 | 0   | 0   | 0   | 0   | 0   | 0   | 0   | 0   | 0   | 0   | 0   | 0   |
| 2069 | 0   | 0   | 0   | 0   | 0   | 0   | 0   | 0   | 0   | 0   | 0   | 0   |
| 2070 | 0   | 0   | 0   | 0   | 0   | 0   | 0   | 0   | 0   | 0   | 0   | 0   |
| 2071 | 0   | 0   | 0   | 0   | 0   | 0   | 0   | 0   | 0   | 0   | 0   | 0   |
| 2072 | 0   | 0   | 0   | 0   | 0   | 0   | 0   | 0   | 0   | 0   | 0   | 0   |
| 2073 | 0   | 0   | 0   | 0   | 0   | 0   | 0   | 0   | 0   | 0   | 0   | 0   |
| 2074 | 0   | 0   | 0   | 0   | 0   | 0   | 0   | 0   | 0   | 0   | 0   | 0   |
| 2075 | 0   | 0   | 0   | 0   | 0   | 0   | 0   | 0   | 0   | 0   | 0   | 0   |
| 2076 | 0   | 0   | 0   | 0   | 0   | 0   | 0   | 0   | 0   | 0   | 0   | 0   |
| 2077 | 0   | 0   | 0   | 0   | 0   | 0   | 0   | 0   | 0   | 0   | 0   | 0   |
| 2078 | 0   | 0   | 0   | 0   | 0   | 0   | 0   | 0   | 0   | 0   | 0   | 0   |
| 2079 | 0   | 0   | 0   | 0   | 0   | 0   | 0   | 0   | 0   | 0   | 0   | 0   |
| 2080 | 0   | 0   | 0   | 0   | 0   | 0   | 0   | 0   | 0   | 0   | 0   | 0   |
| 2081 | 0   | 0   | 0   | 0   | 0   | 0   | 0   | 0   | 0   | 0   | 0   | 0   |
| 2082 | 0   | 0   | 0   | 0   | 0   | 0   | 0   | 0   | 0   | 0   | 0   | 0   |
| 2083 | 0   | 0   | 0   | 0   | 0   | 0   | 0   | 0   | 0   | 0   | 0   | 0   |
| 2084 | 0   | 0   | 0   | 0   | 0   | 0   | 0   | 0   | 0   | 0   | 0   | 0   |
| 2085 | 0   | 0   | 0   | 0   | 0   | 0   | 0   | 0   | 0   | 0   | 0   | 0   |
| 2086 | 0   | 0   | 0   | 0   | 0   | 0   | 0   | 0   | 0   | 0   | 0   | 0   |
| 2087 | 0   | 0   | 0   | 0   | 0   | 0   | 0   | 0   | 0   | 0   | 0   | 0   |
| 2088 | 0   | 0   | 0   | 0   | 0   | 0   | 0   | 0   | 0   | 0   | 0   | 0   |
| 2089 | 0   | 0   | 0   | 0   | 0   | 0   | 0   | 0   | 0   | 0   | 0   | 0   |
| 2090 | 0   | 0   | 0   | 0   | 0   | 0   | 0   | 0   | 0   | 0   | 0   | 0   |



|      | 121 | 122 | 123 | 124 | 125 | 126 | 127 | 128 | 129 | 130 | 131 | 132 |
|------|-----|-----|-----|-----|-----|-----|-----|-----|-----|-----|-----|-----|
| 2002 | 0   | 0   | 0   | 0   | 0   | 0   | 0   | 0   | 0   | 0   | 0   | 0   |
| 2003 | 0   | 0   | 0   | 0   | 0   | 0   | 0   | 0   | 0   | 0   | 0   | 0   |
| 2004 | 1   | 1   | 1   | 1   | 1   | 1   | 1   | 1   | 1   | 1   | 1   | 1   |
| 2005 | 2   | 2   | 2   | 2   | 2   | 2   | 2   | 2   | 2   | 2   | 2   | 2   |
| 2006 | 3   | 3   | 3   | 3   | 3   | 3   | 3   | 3   | 3   | 3   | 3   | 3   |
| 2007 | 7   | 7   | 7   | 7   | 7   | 7   | 7   | 7   | 7   | 7   | 7   | 7   |
| 2008 | 10  | 10  | 10  | 10  | 10  | 10  | 10  | 10  | 10  | 10  | 10  | 10  |
| 2009 | 17  | 17  | 17  | 17  | 17  | 17  | 17  | 17  | 17  | 17  | 17  | 17  |
| 2010 | 19  | 19  | 19  | 19  | 19  | 19  | 19  | 19  | 19  | 19  | 19  | 19  |
| 2011 | 30  | 30  | 30  | 30  | 30  | 30  | 30  | 30  | 30  | 30  | 30  | 30  |
| 2012 | 27  | 27  | 27  | 27  | 27  | 27  | 27  | 27  | 27  | 27  | 27  | 27  |
| 2013 | 31  | 31  | 31  | 31  | 31  | 31  | 31  | 31  | 31  | 31  | 31  | 31  |
| 2014 | 32  | 32  | 32  | 32  | 32  | 32  | 32  | 32  | 32  | 32  | 32  | 32  |
| 2015 | 41  | 41  | 41  | 41  | 41  | 41  | 41  | 41  | 41  | 41  | 41  | 41  |
| 2016 | 37  | 37  | 37  | 37  | 37  | 37  | 37  | 37  | 37  | 37  | 37  | 37  |
| 2017 | 44  | 44  | 44  | 44  | 44  | 44  | 44  | 44  | 44  | 44  | 44  | 44  |
| 2018 | 44  | 44  | 44  | 44  | 44  | 44  | 44  | 44  | 44  | 44  | 44  | 44  |
| 2019 | 45  | 45  | 45  | 45  | 45  | 45  | 45  | 45  | 45  | 45  | 45  | 45  |
| 2020 | 24  | 47  | 47  | 47  | 47  | 47  | 47  | 47  | 47  | 24  | 47  | 47  |
| 2021 | 24  | 49  | 49  | 49  | 49  | 49  | 49  | 49  | 49  | 24  | 49  | 49  |
| 2022 | 25  | 47  | 47  | 47  | 47  | 47  | 47  | 47  | 47  | 25  | 47  | 47  |
| 2023 | 26  | 50  | 50  | 50  | 50  | 50  | 50  | 50  | 50  | 26  | 50  | 50  |
| 2024 | 27  | 49  | 49  | 49  | 49  | 49  | 49  | 49  | 49  | 27  | 49  | 49  |
| 2025 | 26  | 25  | 25  | 25  | 25  | 25  | 25  | 25  | 52  | 26  | 25  | 25  |
| 2026 | 27  | 24  | 23  | 24  | 24  | 24  | 24  | 24  | 51  | 27  | 24  | 24  |
| 2027 | 29  | 24  | 23  | 24  | 24  | 24  | 24  | 24  | 51  | 27  | 24  | 24  |
| 2028 | 27  | 26  | 25  | 26  | 26  | 26  | 26  | 26  | 53  | 27  | 27  | 24  |
| 2029 | 30  | 25  | 25  | 24  | 24  | 24  | 24  | 24  | 51  | 26  | 25  | 23  |
| 2030 | 29  | 25  | 26  | 25  | 25  | 25  | 25  | 25  | 24  | 30  | 24  | 26  |
| 2031 | 32  | 27  | 28  | 27  | 27  | 27  | 27  | 27  | 25  | 31  | 26  | 26  |
| 2032 | 37  | 26  | 25  | 26  | 26  | 26  | 25  | 24  | 25  | 31  | 24  | 25  |
| 2033 | 28  | 26  | 25  | 25  | 25  | 25  | 25  | 24  | 26  | 27  | 25  | 25  |
| 2034 | 27  | 26  | 27  | 27  | 27  | 27  | 26  | 25  | 27  | 26  | 26  | 26  |
| 2035 | 29  | 28  | 31  | 29  | 29  | 29  | 29  | 29  | 24  | 26  | 26  | 28  |
| 2036 | 26  | 24  | 29  | 24  | 24  | 24  | 25  | 25  | 24  | 28  | 22  | 26  |
| 2037 | 29  | 26  | 28  | 27  | 27  | 27  | 24  | 25  | 24  | 29  | 26  | 25  |
| 2038 | 25  | 28  | 27  | 28  | 28  | 28  | 25  | 26  | 26  | 26  | 25  | 26  |
| 2039 | 32  | 25  | 28  | 28  | 28  | 28  | 24  | 24  | 23  | 26  | 27  | 27  |
| 2040 | 25  | 27  | 27  | 27  | 27  | 27  | 23  | 24  | 23  | 26  | 25  | 24  |
| 2041 | 33  | 26  | 26  | 29  | 29  | 29  | 28  | 26  | 24  | 28  | 24  | 28  |
| 2042 | 30  | 27  | 24  | 29  | 29  | 29  | 29  | 27  | 23  | 30  | 25  | 24  |
| 2043 | 33  | 27  | 26  | 26  | 26  | 26  | 27  | 26  | 24  | 37  | 26  | 28  |
| 2044 | 27  | 29  | 21  | 25  | 25  | 25  | 27  | 25  | 27  | 37  | 24  | 28  |
| 2045 | 31  | 28  | 24  | 24  | 24  | 24  | 29  | 27  | 26  | 36  | 27  | 30  |
| 2046 | 27  | 27  | 26  | 24  | 24  | 24  | 28  | 27  | 23  | 29  | 26  | 27  |
| 2047 | 31  | 23  | 31  | 23  | 23  | 23  | 32  | 32  | 25  | 29  | 30  | 31  |
| 2048 | 32  | 32  | 34  | 26  | 26  | 26  | 30  | 30  | 33  | 27  | 29  | 32  |
| 2049 | 29  | 30  | 31  | 32  | 32  | 32  | 27  | 27  | 25  | 26  | 26  | 29  |
| 2050 | 29  | 27  | 30  | 30  | 30  | 30  | 21  | 21  | 20  | 20  | 21  | 27  |
| 2051 | 27  | 21  | 27  | 27  | 27  | 27  | 17  | 17  | 15  | 16  | 17  | 22  |
| 2052 | 26  | 17  | 21  | 21  | 21  | 21  | 14  | 14  | 14  | 13  | 14  | 17  |
| 2053 | 20  | 14  | 17  | 17  | 17  | 17  | 6   | 6   | 11  | 8   | 6   | 14  |
| 2054 | 17  | 6   | 14  | 14  | 14  | 14  | 4   | 4   | 3   | 5   | 4   | 6   |
| 2055 | 12  | 4   | 6   | 6   | 6   | 6   | 3   | 3   | 3   | 4   | 4   | 4   |
| 2056 | 8   | 3   | 4   | 4   | 4   | 4   | 3   | 4   | 3   | 3   | 4   | 3   |
| 2057 | 5   | 3   | 3   | 3   | 3   | 3   | 3   | 4   | 3   | 3   | 3   | 3   |
| 2058 | 4   | 3   | 3   | 3   | 3   | 3   | 1   | 1   | 1   | 2   | 1   | 3   |
| 2059 | 3   | 1   | 3   | 3   | 3   | 3   | 1   | 1   | 0   | 2   | 1   | 1   |

|      | 121 | 122 | 123 | 124 | 125 | 126 | 127 | 128 | 129 | 130 | 131 | 132 |
|------|-----|-----|-----|-----|-----|-----|-----|-----|-----|-----|-----|-----|
| 2060 | 3   | 1   | 1   | 1   | 1   | 1   | 1   | 1   | 0   | 2   | 1   | 1   |
| 2061 | 3   | 1   | 1   | 1   | 1   | 1   | 0   | 0   | 0   | 0   | 0   | 1   |
| 2062 | 3   | 0   | 1   | 1   | 1   | 1   | 0   | 0   | 0   | 0   | 0   | 0   |
| 2063 | 2   | 0   | 0   | 0   | 0   | 0   | 0   | 0   | 0   | 0   | 0   | 0   |
| 2064 | 0   | 0   | 0   | 0   | 0   | 0   | 0   | 0   | 0   | 0   | 0   | 0   |
| 2065 | 0   | 0   | 0   | 0   | 0   | 0   | 0   | 0   | 0   | 0   | 0   | 0   |
| 2066 | 0   | 0   | 0   | 0   | 0   | 0   | 0   | 0   | 0   | 0   | 0   | 0   |
| 2067 | 0   | 0   | 0   | 0   | 0   | 0   | 0   | 0   | 0   | 0   | 0   | 0   |
| 2068 | 0   | 0   | 0   | 0   | 0   | 0   | 0   | 0   | 0   | 0   | 0   | 0   |
| 2069 | 0   | 0   | 0   | 0   | 0   | 0   | 0   | 0   | 0   | 0   | 0   | 0   |
| 2070 | 0   | 0   | 0   | 0   | 0   | 0   | 0   | 0   | 0   | 0   | 0   | 0   |
| 2071 | 0   | 0   | 0   | 0   | 0   | 0   | 0   | 0   | 0   | 0   | 0   | 0   |
| 2072 | 0   | 0   | 0   | 0   | 0   | 0   | 0   | 0   | 0   | 0   | 0   | 0   |
| 2073 | 0   | 0   | 0   | 0   | 0   | 0   | 0   | 0   | 0   | 0   | 0   | 0   |
| 2074 | 0   | 0   | 0   | 0   | 0   | 0   | 0   | 0   | 0   | 0   | 0   | 0   |
| 2075 | 0   | 0   | 0   | 0   | 0   | 0   | 0   | 0   | 0   | 0   | 0   | 0   |
| 2076 | 0   | 0   | 0   | 0   | 0   | 0   | 0   | 0   | 0   | 0   | 0   | 0   |
| 2077 | 0   | 0   | 0   | 0   | 0   | 0   | 0   | 0   | 0   | 0   | 0   | 0   |
| 2078 | 0   | 0   | 0   | 0   | 0   | 0   | 0   | 0   | 0   | 0   | 0   | 0   |
| 2079 | 0   | 0   | 0   | 0   | 0   | 0   | 0   | 0   | 0   | 0   | 0   | 0   |
| 2080 | 0   | 0   | 0   | 0   | 0   | 0   | 0   | 0   | 0   | 0   | 0   | 0   |
| 2081 | 0   | 0   | 0   | 0   | 0   | 0   | 0   | 0   | 0   | 0   | 0   | 0   |
| 2082 | 0   | 0   | 0   | 0   | 0   | 0   | 0   | 0   | 0   | 0   | 0   | 0   |
| 2083 | 0   | 0   | 0   | 0   | 0   | 0   | 0   | 0   | 0   | 0   | 0   | 0   |
| 2084 | 0   | 0   | 0   | 0   | 0   | 0   | 0   | 0   | 0   | 0   | 0   | 0   |
| 2085 | 0   | 0   | 0   | 0   | 0   | 0   | 0   | 0   | 0   | 0   | 0   | 0   |
| 2086 | 0   | 0   | 0   | 0   | 0   | 0   | 0   | 0   | 0   | 0   | 0   | 0   |
| 2087 | 0   | 0   | 0   | 0   | 0   | 0   | 0   | 0   | 0   | 0   | 0   | 0   |
| 2088 | 0   | 0   | 0   | 0   | 0   | 0   | 0   | 0   | 0   | 0   | 0   | 0   |
| 2089 | 0   | 0   | 0   | 0   | 0   | 0   | 0   | 0   | 0   | 0   | 0   | 0   |
| 2090 | 0   | 0   | 0   | 0   | 0   | 0   | 0   | 0   | 0   | 0   | 0   | 0   |

|      | 133 | 134 | 135 | 136 | 137 | 138 | 139 | 140 | 141 | 142 |
|------|-----|-----|-----|-----|-----|-----|-----|-----|-----|-----|
| 2002 | 0   | 0   | 0   | 0   | 0   | 0   | 0   | 0   | 0   | 0   |
| 2003 | 0   | 0   | 0   | 0   | 0   | 0   | 0   | 0   | 0   | 0   |
| 2004 | 1   | 1   | 1   | 1   | 1   | 1   | 1   | 1   | 1   | 1   |
| 2005 | 2   | 2   | 2   | 2   | 2   | 2   | 2   | 2   | 2   | 2   |
| 2006 | 3   | 3   | 3   | 3   | 3   | 3   | 3   | 3   | 3   | 3   |
| 2007 | 7   | 7   | 7   | 7   | 7   | 7   | 7   | 7   | 7   | 7   |
| 2008 | 10  | 10  | 10  | 10  | 10  | 10  | 10  | 10  | 10  | 10  |
| 2009 | 17  | 17  | 17  | 17  | 17  | 17  | 17  | 17  | 17  | 17  |
| 2010 | 19  | 19  | 19  | 19  | 19  | 19  | 19  | 19  | 19  | 19  |
| 2011 | 30  | 30  | 30  | 30  | 30  | 30  | 30  | 30  | 30  | 30  |
| 2012 | 27  | 27  | 27  | 27  | 27  | 27  | 27  | 27  | 27  | 27  |
| 2013 | 31  | 31  | 31  | 31  | 31  | 31  | 31  | 31  | 31  | 31  |
| 2014 | 32  | 32  | 32  | 32  | 32  | 32  | 32  | 32  | 32  | 32  |
| 2015 | 41  | 41  | 41  | 41  | 41  | 41  | 41  | 41  | 41  | 41  |
| 2016 | 37  | 37  | 37  | 37  | 37  | 37  | 37  | 37  | 37  | 37  |
| 2017 | 44  | 44  | 44  | 44  | 44  | 44  | 44  | 44  | 44  | 44  |
| 2018 | 44  | 44  | 44  | 44  | 44  | 44  | 44  | 44  | 44  | 44  |
| 2019 | 45  | 45  | 45  | 45  | 45  | 45  | 45  | 45  | 45  | 45  |
| 2020 | 47  | 47  | 47  | 47  | 47  | 47  | 27  | 47  | 47  | 47  |
| 2021 | 49  | 49  | 49  | 49  | 49  | 49  | 22  | 49  | 49  | 49  |
| 2022 | 47  | 47  | 47  | 47  | 47  | 47  | 25  | 47  | 47  | 47  |
| 2023 | 50  | 50  | 50  | 50  | 50  | 50  | 25  | 50  | 50  | 50  |
| 2024 | 49  | 49  | 49  | 49  | 49  | 49  | 22  | 49  | 49  | 49  |
| 2025 | 25  | 25  | 25  | 28  | 28  | 52  | 23  | 28  | 28  | 28  |
| 2026 | 24  | 24  | 24  | 20  | 19  | 51  | 27  | 17  | 17  | 17  |
| 2027 | 24  | 24  | 24  | 22  | 22  | 51  | 26  | 24  | 24  | 24  |
| 2028 | 26  | 26  | 26  | 20  | 19  | 53  | 26  | 22  | 22  | 22  |
| 2029 | 24  | 24  | 24  | 23  | 21  | 51  | 27  | 23  | 23  | 23  |
| 2030 | 25  | 25  | 25  | 23  | 23  | 28  | 26  | 22  | 22  | 22  |
| 2031 | 27  | 27  | 27  | 24  | 24  | 20  | 29  | 24  | 24  | 24  |
| 2032 | 25  | 25  | 25  | 25  | 22  | 22  | 27  | 23  | 23  | 23  |
| 2033 | 25  | 25  | 25  | 23  | 21  | 25  | 30  | 24  | 24  | 24  |
| 2034 | 25  | 25  | 25  | 25  | 24  | 22  | 31  | 23  | 25  | 23  |
| 2035 | 29  | 29  | 29  | 25  | 24  | 22  | 32  | 23  | 27  | 23  |
| 2036 | 25  | 25  | 25  | 24  | 27  | 23  | 33  | 27  | 32  | 27  |
| 2037 | 25  | 25  | 25  | 29  | 28  | 21  | 33  | 28  | 29  | 28  |
| 2038 | 26  | 26  | 26  | 29  | 30  | 18  | 28  | 28  | 29  | 29  |
| 2039 | 23  | 23  | 23  | 25  | 25  | 21  | 31  | 25  | 29  | 26  |
| 2040 | 25  | 25  | 25  | 31  | 33  | 22  | 32  | 30  | 27  | 32  |
| 2041 | 27  | 27  | 27  | 33  | 30  | 26  | 31  | 27  | 28  | 30  |
| 2042 | 28  | 28  | 28  | 32  | 33  | 26  | 29  | 30  | 30  | 33  |
| 2043 | 27  | 27  | 27  | 34  | 33  | 25  | 33  | 32  | 30  | 33  |
| 2044 | 26  | 26  | 26  | 32  | 31  | 26  | 22  | 31  | 30  | 31  |
| 2045 | 26  | 26  | 26  | 36  | 36  | 29  | 21  | 36  | 18  | 36  |
| 2046 | 26  | 26  | 26  | 23  | 25  | 29  | 17  | 25  | 34  | 25  |
| 2047 | 32  | 32  | 32  | 19  | 20  | 28  | 8   | 20  | 20  | 20  |
| 2048 | 30  | 30  | 30  | 15  | 15  | 16  | 7   | 15  | 20  | 15  |
| 2049 | 27  | 27  | 27  | 5   | 5   | 33  | 2   | 5   | 13  | 5   |
| 2050 | 21  | 21  | 21  | 2   | 3   | 23  | 1   | 3   | 6   | 3   |
| 2051 | 17  | 17  | 17  | 2   | 2   | 17  | 2   | 2   | 3   | 2   |
| 2052 | 14  | 14  | 14  | 2   | 2   | 7   | 2   | 2   | 2   | 2   |
| 2053 | 6   | 6   | 6   | 0   | 0   | 4   | 0   | 0   | 0   | 0   |
| 2054 | 4   | 4   | 4   | 2   | 2   | 4   | 2   | 2   | 2   | 2   |
| 2055 | 3   | 3   | 3   | 1   | 1   | 1   | 1   | 1   | 1   | 1   |
| 2056 | 4   | 4   | 4   | 1   | 1   | 1   | 1   | 1   | 1   | 1   |
| 2057 | 4   | 4   | 4   | 0   | 0   | 0   | 0   | 0   | 0   | 0   |
| 2058 | 1   | 1   | 1   | 0   | 0   | 0   | 0   | 0   | 0   | 0   |
| 2059 | 1   | 1   | 1   | 0   | 0   | 0   | 0   | 0   | 0   | 0   |

|      | 133 | 134 | 135 | 136 | 137 | 138 | 139 | 140 | 141 | 142 |
|------|-----|-----|-----|-----|-----|-----|-----|-----|-----|-----|
| 2060 | 1   | 1   | 1   | 0   | 0   | 0   | 0   | 0   | 0   | 0   |
| 2061 | 0   | 0   | 0   | 0   | 0   | 0   | 0   | 0   | 0   | 0   |
| 2062 | 0   | 0   | 0   | 0   | 0   | 0   | 0   | 0   | 0   | 0   |
| 2063 | 0   | 0   | 0   | 0   | 0   | 0   | 0   | 0   | 0   | 0   |
| 2064 | 0   | 0   | 0   | 0   | 0   | 0   | 0   | 0   | 0   | 0   |
| 2065 | 0   | 0   | 0   | 0   | 0   | 0   | 0   | 0   | 0   | 0   |
| 2066 | 0   | 0   | 0   | 0   | 0   | 0   | 0   | 0   | 0   | 0   |
| 2067 | 0   | 0   | 0   | 0   | 0   | 0   | 0   | 0   | 0   | 0   |
| 2068 | 0   | 0   | 0   | 0   | 0   | 0   | 0   | 0   | 0   | 0   |
| 2069 | 0   | 0   | 0   | 0   | 0   | 0   | 0   | 0   | 0   | 0   |
| 2070 | 0   | 0   | 0   | 0   | 0   | 0   | 0   | 0   | 0   | 0   |
| 2071 | 0   | 0   | 0   | 0   | 0   | 0   | 0   | 0   | 0   | 0   |
| 2072 | 0   | 0   | 0   | 0   | 0   | 0   | 0   | 0   | 0   | 0   |
| 2073 | 0   | 0   | 0   | 0   | 0   | 0   | 0   | 0   | 0   | 0   |
| 2074 | 0   | 0   | 0   | 0   | 0   | 0   | 0   | 0   | 0   | 0   |
| 2075 | 0   | 0   | 0   | 0   | 0   | 0   | 0   | 0   | 0   | 0   |
| 2076 | 0   | 0   | 0   | 0   | 0   | 0   | 0   | 0   | 0   | 0   |
| 2077 | 0   | 0   | 0   | 0   | 0   | 0   | 0   | 0   | 0   | 0   |
| 2078 | 0   | 0   | 0   | 0   | 0   | 0   | 0   | 0   | 0   | 0   |
| 2079 | 0   | 0   | 0   | 0   | 0   | 0   | 0   | 0   | 0   | 0   |
| 2080 | 0   | 0   | 0   | 0   | 0   | 0   | 0   | 0   | 0   | 0   |
| 2081 | 0   | 0   | 0   | 0   | 0   | 0   | 0   | 0   | 0   | 0   |
| 2082 | 0   | 0   | 0   | 0   | 0   | 0   | 0   | 0   | 0   | 0   |
| 2083 | 0   | 0   | 0   | 0   | 0   | 0   | 0   | 0   | 0   | 0   |
| 2084 | 0   | 0   | 0   | 0   | 0   | 0   | 0   | 0   | 0   | 0   |
| 2085 | 0   | 0   | 0   | 0   | 0   | 0   | 0   | 0   | 0   | 0   |
| 2086 | 0   | 0   | 0   | 0   | 0   | 0   | 0   | 0   | 0   | 0   |
| 2087 | 0   | 0   | 0   | 0   | 0   | 0   | 0   | 0   | 0   | 0   |
| 2088 | 0   | 0   | 0   | 0   | 0   | 0   | 0   | 0   | 0   | 0   |
| 2089 | 0   | 0   | 0   | 0   | 0   | 0   | 0   | 0   | 0   | 0   |
| 2090 | 0   | 0   | 0   | 0   | 0   | 0   | 0   | 0   | 0   | 0   |

|      | 143 | 144 | 145 | 146 | 147 | 148 | 149 | 150 | 151 | 152 | 153 |
|------|-----|-----|-----|-----|-----|-----|-----|-----|-----|-----|-----|
| 2002 | 0   | 0   | 0   | 0   | 0   | 0   | 0   | 0   | 0   | 0   | 0   |
| 2003 | 0   | 0   | 0   | 0   | 0   | 0   | 0   | 0   | 0   | 0   | 0   |
| 2004 | 1   | 1   | 1   | 1   | 1   | 1   | 1   | 1   | 1   | 1   | 1   |
| 2005 | 2   | 2   | 2   | 2   | 2   | 2   | 2   | 2   | 2   | 2   | 2   |
| 2006 | 3   | 3   | 3   | 3   | 3   | 3   | 3   | 3   | 3   | 3   | 3   |
| 2007 | 7   | 7   | 7   | 7   | 7   | 7   | 7   | 7   | 7   | 7   | 7   |
| 2008 | 10  | 10  | 10  | 10  | 10  | 10  | 10  | 10  | 10  | 10  | 10  |
| 2009 | 17  | 17  | 17  | 17  | 17  | 17  | 17  | 17  | 17  | 17  | 17  |
| 2010 | 19  | 19  | 19  | 19  | 19  | 19  | 19  | 19  | 19  | 19  | 19  |
| 2011 | 30  | 30  | 30  | 30  | 30  | 30  | 30  | 30  | 30  | 30  | 30  |
| 2012 | 27  | 27  | 27  | 27  | 27  | 27  | 27  | 27  | 27  | 27  | 27  |
| 2013 | 31  | 31  | 31  | 31  | 31  | 31  | 31  | 31  | 31  | 31  | 31  |
| 2014 | 32  | 32  | 32  | 32  | 32  | 32  | 32  | 32  | 32  | 32  | 32  |
| 2015 | 41  | 41  | 41  | 41  | 41  | 41  | 41  | 41  | 41  | 41  | 41  |
| 2016 | 37  | 37  | 37  | 37  | 37  | 37  | 37  | 37  | 37  | 37  | 37  |
| 2017 | 44  | 44  | 44  | 44  | 44  | 44  | 44  | 44  | 44  | 44  | 44  |
| 2018 | 44  | 44  | 44  | 44  | 44  | 44  | 44  | 44  | 44  | 44  | 44  |
| 2019 | 45  | 45  | 45  | 45  | 45  | 45  | 45  | 45  | 45  | 45  | 45  |
| 2020 | 47  | 47  | 47  | 47  | 47  | 24  | 47  | 47  | 47  | 47  | 47  |
| 2021 | 49  | 49  | 49  | 49  | 49  | 20  | 49  | 49  | 49  | 49  | 49  |
| 2022 | 47  | 47  | 47  | 47  | 47  | 22  | 47  | 47  | 47  | 47  | 47  |
| 2023 | 50  | 50  | 50  | 50  | 50  | 26  | 50  | 50  | 50  | 50  | 50  |
| 2024 | 49  | 49  | 49  | 49  | 49  | 28  | 49  | 49  | 49  | 49  | 49  |
| 2025 | 28  | 28  | 25  | 25  | 52  | 27  | 25  | 25  | 25  | 25  | 25  |
| 2026 | 17  | 17  | 16  | 18  | 51  | 28  | 16  | 16  | 16  | 16  | 16  |
| 2027 | 24  | 24  | 19  | 23  | 51  | 27  | 19  | 19  | 19  | 19  | 19  |
| 2028 | 22  | 22  | 27  | 25  | 53  | 29  | 26  | 25  | 26  | 26  | 26  |
| 2029 | 23  | 23  | 22  | 21  | 51  | 31  | 23  | 24  | 23  | 23  | 23  |
| 2030 | 22  | 22  | 25  | 23  | 24  | 32  | 24  | 24  | 24  | 24  | 24  |
| 2031 | 24  | 24  | 26  | 27  | 19  | 35  | 27  | 28  | 27  | 27  | 27  |
| 2032 | 23  | 23  | 25  | 25  | 18  | 40  | 25  | 28  | 25  | 25  | 25  |
| 2033 | 24  | 24  | 23  | 23  | 23  | 39  | 25  | 25  | 23  | 23  | 23  |
| 2034 | 23  | 23  | 30  | 30  | 28  | 42  | 29  | 31  | 30  | 30  | 30  |
| 2035 | 23  | 23  | 34  | 33  | 20  | 38  | 31  | 32  | 33  | 33  | 33  |
| 2036 | 27  | 27  | 30  | 29  | 17  | 32  | 28  | 31  | 30  | 30  | 30  |
| 2037 | 28  | 28  | 31  | 30  | 25  | 36  | 29  | 33  | 31  | 31  | 31  |
| 2038 | 29  | 29  | 29  | 30  | 28  | 32  | 29  | 34  | 30  | 30  | 30  |
| 2039 | 26  | 26  | 30  | 33  | 26  | 35  | 29  | 34  | 31  | 31  | 31  |
| 2040 | 32  | 32  | 31  | 32  | 25  | 34  | 32  | 35  | 33  | 33  | 33  |
| 2041 | 30  | 30  | 33  | 29  | 29  | 37  | 30  | 33  | 30  | 30  | 30  |
| 2042 | 33  | 33  | 30  | 31  | 25  | 41  | 30  | 29  | 29  | 29  | 29  |
| 2043 | 33  | 33  | 31  | 30  | 25  | 41  | 32  | 31  | 29  | 29  | 29  |
| 2044 | 31  | 31  | 24  | 23  | 24  | 34  | 28  | 30  | 24  | 24  | 24  |
| 2045 | 36  | 36  | 27  | 27  | 25  | 41  | 28  | 34  | 27  | 27  | 27  |
| 2046 | 25  | 25  | 27  | 26  | 26  | 28  | 29  | 36  | 25  | 25  | 25  |
| 2047 | 20  | 20  | 28  | 28  | 27  | 28  | 28  | 42  | 29  | 29  | 29  |
| 2048 | 15  | 15  | 31  | 31  | 27  | 26  | 31  | 31  | 31  | 31  | 31  |
| 2049 | 5   | 5   | 30  | 30  | 31  | 25  | 30  | 29  | 30  | 30  | 30  |
| 2050 | 3   | 3   | 27  | 27  | 32  | 19  | 27  | 26  | 27  | 27  | 27  |
| 2051 | 2   | 2   | 21  | 21  | 25  | 12  | 21  | 22  | 21  | 21  | 21  |
| 2052 | 2   | 2   | 17  | 17  | 20  | 8   | 17  | 17  | 17  | 17  | 17  |
| 2053 | 0   | 0   | 14  | 14  | 15  | 7   | 14  | 11  | 14  | 14  | 14  |
| 2054 | 2   | 2   | 6   | 6   | 14  | 5   | 6   | 7   | 6   | 6   | 6   |
| 2055 | 1   | 1   | 4   | 4   | 11  | 4   | 4   | 4   | 4   | 4   | 4   |
| 2056 | 1   | 1   | 3   | 3   | 3   | 2   | 3   | 3   | 3   | 3   | 3   |
| 2057 | 0   | 0   | 3   | 3   | 3   | 2   | 3   | 3   | 3   | 3   | 3   |
| 2058 | 0   | 0   | 3   | 3   | 3   | 2   | 3   | 2   | 3   | 3   | 3   |
| 2059 | 0   | 0   | 1   | 1   | 3   | 1   | 1   | 2   | 1   | 1   | 1   |

|      | 143 | 144 | 145 | 146 | 147 | 148 | 149 | 150 | 151 | 152 | 153 |
|------|-----|-----|-----|-----|-----|-----|-----|-----|-----|-----|-----|
| 2060 | 0   | 0   | 1   | 1   | 1   | 1   | 1   | 1   | 1   | 1   | 1   |
| 2061 | 0   | 0   | 1   | 1   | 0   | 0   | 1   | 0   | 1   | 1   | 1   |
| 2062 | 0   | 0   | 0   | 0   | 0   | 0   | 0   | 0   | 0   | 0   | 0   |
| 2063 | 0   | 0   | 0   | 0   | 0   | 0   | 0   | 0   | 0   | 0   | 0   |
| 2064 | 0   | 0   | 0   | 0   | 0   | 0   | 0   | 0   | 0   | 0   | 0   |
| 2065 | 0   | 0   | 0   | 0   | 0   | 0   | 0   | 0   | 0   | 0   | 0   |
| 2066 | 0   | 0   | 0   | 0   | 0   | 0   | 0   | 0   | 0   | 0   | 0   |
| 2067 | 0   | 0   | 0   | 0   | 0   | 0   | 0   | 0   | 0   | 0   | 0   |
| 2068 | 0   | 0   | 0   | 0   | 0   | 0   | 0   | 0   | 0   | 0   | 0   |
| 2069 | 0   | 0   | 0   | 0   | 0   | 0   | 0   | 0   | 0   | 0   | 0   |
| 2070 | 0   | 0   | 0   | 0   | 0   | 0   | 0   | 0   | 0   | 0   | 0   |
| 2071 | 0   | 0   | 0   | 0   | 0   | 0   | 0   | 0   | 0   | 0   | 0   |
| 2072 | 0   | 0   | 0   | 0   | 0   | 0   | 0   | 0   | 0   | 0   | 0   |
| 2073 | 0   | 0   | 0   | 0   | 0   | 0   | 0   | 0   | 0   | 0   | 0   |
| 2074 | 0   | 0   | 0   | 0   | 0   | 0   | 0   | 0   | 0   | 0   | 0   |
| 2075 | 0   | 0   | 0   | 0   | 0   | 0   | 0   | 0   | 0   | 0   | 0   |
| 2076 | 0   | 0   | 0   | 0   | 0   | 0   | 0   | 0   | 0   | 0   | 0   |
| 2077 | 0   | 0   | 0   | 0   | 0   | 0   | 0   | 0   | 0   | 0   | 0   |
| 2078 | 0   | 0   | 0   | 0   | 0   | 0   | 0   | 0   | 0   | 0   | 0   |
| 2079 | 0   | 0   | 0   | 0   | 0   | 0   | 0   | 0   | 0   | 0   | 0   |
| 2080 | 0   | 0   | 0   | 0   | 0   | 0   | 0   | 0   | 0   | 0   | 0   |
| 2081 | 0   | 0   | 0   | 0   | 0   | 0   | 0   | 0   | 0   | 0   | 0   |
| 2082 | 0   | 0   | 0   | 0   | 0   | 0   | 0   | 0   | 0   | 0   | 0   |
| 2083 | 0   | 0   | 0   | 0   | 0   | 0   | 0   | 0   | 0   | 0   | 0   |
| 2084 | 0   | 0   | 0   | 0   | 0   | 0   | 0   | 0   | 0   | 0   | 0   |
| 2085 | 0   | 0   | 0   | 0   | 0   | 0   | 0   | 0   | 0   | 0   | 0   |
| 2086 | 0   | 0   | 0   | 0   | 0   | 0   | 0   | 0   | 0   | 0   | 0   |
| 2087 | 0   | 0   | 0   | 0   | 0   | 0   | 0   | 0   | 0   | 0   | 0   |
| 2088 | 0   | 0   | 0   | 0   | 0   | 0   | 0   | 0   | 0   | 0   | 0   |
| 2089 | 0   | 0   | 0   | 0   | 0   | 0   | 0   | 0   | 0   | 0   | 0   |
| 2090 | 0   | 0   | 0   | 0   | 0   | 0   | 0   | 0   | 0   | 0   | 0   |

|      | 154 | 155 | 156 | 157 | 158 | 159 | 160 | 161 | 162 |
|------|-----|-----|-----|-----|-----|-----|-----|-----|-----|
| 2002 | 0   | 0   | 0   | 0   | 0   | 0   | 0   | 0   | 0   |
| 2003 | 0   | 0   | 0   | 0   | 0   | 0   | 0   | 0   | 0   |
| 2004 | 1   | 1   | 1   | 1   | 1   | 1   | 1   | 1   | 1   |
| 2005 | 2   | 2   | 2   | 2   | 2   | 2   | 2   | 2   | 2   |
| 2006 | 3   | 3   | 3   | 3   | 3   | 3   | 3   | 3   | 3   |
| 2007 | 7   | 7   | 7   | 7   | 7   | 7   | 7   | 7   | 7   |
| 2008 | 10  | 10  | 10  | 10  | 10  | 10  | 10  | 10  | 10  |
| 2009 | 17  | 17  | 17  | 17  | 17  | 17  | 17  | 17  | 17  |
| 2010 | 19  | 19  | 19  | 19  | 19  | 19  | 19  | 19  | 19  |
| 2011 | 30  | 30  | 30  | 30  | 30  | 30  | 30  | 30  | 30  |
| 2012 | 27  | 27  | 27  | 27  | 27  | 27  | 27  | 27  | 27  |
| 2013 | 31  | 31  | 31  | 31  | 31  | 31  | 31  | 31  | 31  |
| 2014 | 32  | 32  | 32  | 32  | 32  | 32  | 32  | 32  | 32  |
| 2015 | 41  | 41  | 41  | 41  | 41  | 41  | 41  | 41  | 41  |
| 2016 | 37  | 37  | 37  | 37  | 37  | 37  | 37  | 37  | 37  |
| 2017 | 44  | 44  | 44  | 44  | 44  | 44  | 44  | 44  | 44  |
| 2018 | 44  | 44  | 44  | 44  | 44  | 44  | 44  | 44  | 44  |
| 2019 | 45  | 45  | 45  | 45  | 45  | 45  | 45  | 45  | 45  |
| 2020 | 47  | 47  | 47  | 24  | 47  | 47  | 47  | 47  | 47  |
| 2021 | 49  | 49  | 49  | 20  | 49  | 49  | 49  | 49  | 49  |
| 2022 | 47  | 47  | 47  | 22  | 47  | 47  | 47  | 47  | 47  |
| 2023 | 50  | 50  | 50  | 26  | 50  | 50  | 50  | 50  | 50  |
| 2024 | 49  | 49  | 49  | 28  | 49  | 49  | 49  | 49  | 49  |
| 2025 | 25  | 25  | 52  | 26  | 25  | 25  | 25  | 25  | 25  |
| 2026 | 16  | 18  | 51  | 27  | 16  | 16  | 16  | 16  | 16  |
| 2027 | 19  | 23  | 51  | 25  | 19  | 19  | 19  | 19  | 19  |
| 2028 | 27  | 25  | 53  | 29  | 26  | 26  | 26  | 26  | 26  |
| 2029 | 22  | 21  | 51  | 29  | 23  | 23  | 23  | 23  | 23  |
| 2030 | 25  | 23  | 24  | 29  | 23  | 24  | 24  | 24  | 24  |
| 2031 | 26  | 27  | 19  | 31  | 26  | 27  | 27  | 27  | 27  |
| 2032 | 27  | 26  | 18  | 32  | 25  | 26  | 26  | 26  | 26  |
| 2033 | 24  | 24  | 23  | 32  | 23  | 25  | 24  | 24  | 24  |
| 2034 | 28  | 28  | 28  | 35  | 27  | 31  | 28  | 28  | 28  |
| 2035 | 32  | 32  | 20  | 35  | 29  | 31  | 32  | 32  | 32  |
| 2036 | 27  | 27  | 17  | 33  | 25  | 29  | 27  | 27  | 27  |
| 2037 | 31  | 30  | 25  | 35  | 27  | 31  | 30  | 30  | 30  |
| 2038 | 32  | 27  | 28  | 33  | 26  | 34  | 29  | 29  | 29  |
| 2039 | 31  | 32  | 25  | 36  | 31  | 34  | 29  | 29  | 29  |
| 2040 | 31  | 31  | 24  | 38  | 32  | 37  | 32  | 32  | 32  |
| 2041 | 32  | 30  | 27  | 42  | 30  | 35  | 33  | 33  | 33  |
| 2042 | 33  | 33  | 26  | 39  | 32  | 34  | 31  | 31  | 31  |
| 2043 | 31  | 31  | 25  | 46  | 32  | 36  | 30  | 30  | 30  |
| 2044 | 31  | 30  | 26  | 28  | 27  | 37  | 28  | 28  | 28  |
| 2045 | 34  | 34  | 27  | 28  | 29  | 39  | 34  | 34  | 34  |
| 2046 | 29  | 35  | 29  | 26  | 3   | 34  | 29  | 29  | 29  |
| 2047 | 29  | 29  | 30  | 26  | 29  | 30  | 29  | 29  | 29  |
| 2048 | 27  | 29  | 27  | 20  | 29  | 31  | 26  | 26  | 26  |
| 2049 | 21  | 26  | 32  | 13  | 26  | 26  | 21  | 21  | 21  |
| 2050 | 17  | 21  | 25  | 8   | 21  | 22  | 17  | 17  | 17  |
| 2051 | 14  | 17  | 20  | 7   | 17  | 17  | 14  | 14  | 14  |
| 2052 | 6   | 14  | 15  | 5   | 14  | 10  | 6   | 6   | 6   |
| 2053 | 4   | 6   | 14  | 4   | 6   | 7   | 4   | 4   | 4   |
| 2054 | 3   | 4   | 11  | 2   | 4   | 4   | 3   | 3   | 3   |
| 2055 | 3   | 3   | 3   | 2   | 3   | 3   | 3   | 3   | 3   |
| 2056 | 3   | 3   | 3   | 2   | 3   | 3   | 3   | 3   | 3   |
| 2057 | 1   | 3   | 3   | 1   | 3   | 2   | 1   | 1   | 1   |
| 2058 | 1   | 2   | 3   | 1   | 1   | 0   | 1   | 1   | 1   |
| 2059 | 1   | 1   | 1   | 0   | 1   | 0   | 1   | 1   | 1   |

|      | 154 | 155 | 156 | 157 | 158 | 159 | 160 | 161 | 162 |
|------|-----|-----|-----|-----|-----|-----|-----|-----|-----|
| 2060 | 0   | 1   | 0   | 0   | 1   | 0   | 0   | 0   | 0   |
| 2061 | 0   | 0   | 0   | 0   | 0   | 0   | 0   | 0   | 0   |
| 2062 | 0   | 0   | 0   | 0   | 0   | 0   | 0   | 0   | 0   |
| 2063 | 0   | 0   | 0   | 0   | 0   | 0   | 0   | 0   | 0   |
| 2064 | 0   | 0   | 0   | 0   | 0   | 0   | 0   | 0   | 0   |
| 2065 | 0   | 0   | 0   | 0   | 0   | 0   | 0   | 0   | 0   |
| 2066 | 0   | 0   | 0   | 0   | 0   | 0   | 0   | 0   | 0   |
| 2067 | 0   | 0   | 0   | 0   | 0   | 0   | 0   | 0   | 0   |
| 2068 | 0   | 0   | 0   | 0   | 0   | 0   | 0   | 0   | 0   |
| 2069 | 0   | 0   | 0   | 0   | 0   | 0   | 0   | 0   | 0   |
| 2070 | 0   | 0   | 0   | 0   | 0   | 0   | 0   | 0   | 0   |
| 2071 | 0   | 0   | 0   | 0   | 0   | 0   | 0   | 0   | 0   |
| 2072 | 0   | 0   | 0   | 0   | 0   | 0   | 0   | 0   | 0   |
| 2073 | 0   | 0   | 0   | 0   | 0   | 0   | 0   | 0   | 0   |
| 2074 | 0   | 0   | 0   | 0   | 0   | 0   | 0   | 0   | 0   |
| 2075 | 0   | 0   | 0   | 0   | 0   | 0   | 0   | 0   | 0   |
| 2076 | 0   | 0   | 0   | 0   | 0   | 0   | 0   | 0   | 0   |
| 2077 | 0   | 0   | 0   | 0   | 0   | 0   | 0   | 0   | 0   |
| 2078 | 0   | 0   | 0   | 0   | 0   | 0   | 0   | 0   | 0   |
| 2079 | 0   | 0   | 0   | 0   | 0   | 0   | 0   | 0   | 0   |
| 2080 | 0   | 0   | 0   | 0   | 0   | 0   | 0   | 0   | 0   |
| 2081 | 0   | 0   | 0   | 0   | 0   | 0   | 0   | 0   | 0   |
| 2082 | 0   | 0   | 0   | 0   | 0   | 0   | 0   | 0   | 0   |
| 2083 | 0   | 0   | 0   | 0   | 0   | 0   | 0   | 0   | 0   |
| 2084 | 0   | 0   | 0   | 0   | 0   | 0   | 0   | 0   | 0   |
| 2085 | 0   | 0   | 0   | 0   | 0   | 0   | 0   | 0   | 0   |
| 2086 | 0   | 0   | 0   | 0   | 0   | 0   | 0   | 0   | 0   |
| 2087 | 0   | 0   | 0   | 0   | 0   | 0   | 0   | 0   | 0   |
| 2088 | 0   | 0   | 0   | 0   | 0   | 0   | 0   | 0   | 0   |
| 2089 | 0   | 0   | 0   | 0   | 0   | 0   | 0   | 0   | 0   |
| 2090 | 0   | 0   | 0   | 0   | 0   | 0   | 0   | 0   | 0   |



|      | 1 | 2 | 3 | 4 | 5 | 6 | 7 | 8 | 9 | 10 | 11 |
|------|---|---|---|---|---|---|---|---|---|----|----|
| 2002 | 0 | 0 | 0 | 0 | 0 | 0 | 0 | 0 | 0 | 0  | 0  |
| 2003 | 0 | 0 | 0 | 0 | 0 | 0 | 0 | 0 | 0 | 0  | 0  |
| 2004 | 0 | 0 | 0 | 0 | 0 | 0 | 0 | 0 | 0 | 0  | 0  |
| 2005 | 0 | 0 | 0 | 0 | 0 | 0 | 0 | 0 | 0 | 0  | 0  |
| 2006 | 0 | 0 | 0 | 0 | 0 | 0 | 0 | 0 | 0 | 0  | 0  |
| 2007 | 0 | 0 | 0 | 0 | 0 | 0 | 0 | 0 | 0 | 0  | 0  |
| 2008 | 0 | 0 | 0 | 0 | 0 | 0 | 0 | 0 | 0 | 0  | 0  |
| 2009 | 0 | 0 | 0 | 0 | 0 | 0 | 0 | 0 | 0 | 0  | 0  |
| 2010 | 0 | 0 | 0 | 0 | 0 | 0 | 0 | 0 | 0 | 0  | 0  |
| 2011 | 0 | 0 | 0 | 0 | 0 | 0 | 0 | 0 | 0 | 0  | 0  |
| 2012 | 0 | 0 | 0 | 0 | 0 | 0 | 0 | 0 | 0 | 0  | 0  |
| 2013 | 0 | 0 | 0 | 0 | 0 | 0 | 0 | 0 | 0 | 0  | 0  |
| 2014 | 0 | 0 | 0 | 0 | 0 | 0 | 0 | 0 | 0 | 0  | 0  |
| 2015 | 0 | 0 | 0 | 0 | 0 | 0 | 0 | 0 | 0 | 0  | 0  |
| 2016 | 0 | 0 | 0 | 0 | 0 | 0 | 0 | 0 | 0 | 0  | 0  |
| 2017 | 0 | 0 | 0 | 0 | 0 | 0 | 0 | 0 | 0 | 0  | 0  |
| 2018 | 0 | 0 | 0 | 0 | 0 | 0 | 0 | 0 | 0 | 0  | 0  |
| 2019 | 0 | 0 | 0 | 0 | 0 | 0 | 0 | 0 | 0 | 0  | 0  |
| 2020 | 0 | 0 | 0 | 0 | 0 | 0 | 0 | 0 | 0 | 0  | 0  |
| 2021 | 0 | 0 | 0 | 0 | 0 | 0 | 0 | 0 | 0 | 0  | 0  |
| 2022 | 0 | 0 | 0 | 0 | 0 | 0 | 0 | 0 | 0 | 0  | 0  |
| 2023 | 0 | 0 | 0 | 0 | 0 | 0 | 0 | 0 | 0 | 0  | 0  |
| 2024 | 0 | 0 | 0 | 0 | 0 | 0 | 0 | 0 | 0 | 0  | 0  |
| 2025 | 0 | 0 | 0 | 0 | 0 | 0 | 0 | 0 | 0 | 0  | 0  |
| 2026 | 0 | 0 | 0 | 0 | 0 | 0 | 0 | 0 | 0 | 0  | 0  |
| 2027 | 0 | 0 | 0 | 0 | 0 | 0 | 0 | 0 | 0 | 0  | 0  |
| 2028 | 0 | 0 | 0 | 0 | 0 | 0 | 0 | 0 | 0 | 0  | 0  |
| 2029 | 0 | 0 | 0 | 0 | 0 | 0 | 0 | 0 | 0 | 0  | 0  |
| 2030 | 0 | 0 | 0 | 0 | 0 | 0 | 0 | 0 | 0 | 0  | 0  |
| 2031 | 0 | 0 | 0 | 0 | 0 | 0 | 0 | 0 | 0 | 0  | 0  |
| 2032 | 0 | 0 | 0 | 0 | 0 | 0 | 0 | 0 | 0 | 0  | 0  |
| 2033 | 0 | 0 | 0 | 0 | 0 | 0 | 0 | 0 | 0 | 0  | 0  |
| 2034 | 0 | 0 | 0 | 0 | 0 | 0 | 0 | 0 | 0 | 0  | 0  |
| 2035 | 0 | 0 | 0 | 0 | 0 | 0 | 0 | 0 | 0 | 0  | 0  |
| 2036 | 0 | 0 | 0 | 0 | 0 | 0 | 0 | 0 | 0 | 0  | 0  |
| 2037 | 0 | 0 | 0 | 0 | 0 | 0 | 0 | 0 | 0 | 0  | 0  |
| 2038 | 0 | 0 | 0 | 0 | 0 | 0 | 0 | 0 | 0 | 0  | 0  |
| 2039 | 0 | 0 | 0 | 0 | 0 | 0 | 0 | 0 | 0 | 0  | 0  |
| 2040 | 0 | 0 | 0 | 0 | 0 | 0 | 0 | 0 | 0 | 0  | 0  |
| 2041 | 0 | 0 | 0 | 0 | 0 | 0 | 0 | 0 | 0 | 0  | 0  |
| 2042 | 0 | 0 | 0 | 0 | 0 | 0 | 0 | 0 | 0 | 0  | 0  |
| 2043 | 0 | 0 | 0 | 0 | 0 | 0 | 0 | 0 | 0 | 0  | 0  |
| 2044 | 0 | 0 | 0 | 0 | 0 | 0 | 0 | 0 | 0 | 0  | 0  |
| 2045 | 0 | 0 | 0 | 0 | 0 | 0 | 0 | 0 | 0 | 0  | 0  |
| 2046 | 0 | 0 | 0 | 0 | 0 | 0 | 0 | 0 | 0 | 0  | 0  |
| 2047 | 0 | 0 | 0 | 0 | 0 | 0 | 0 | 0 | 0 | 0  | 0  |
| 2048 | 0 | 0 | 0 | 0 | 0 | 0 | 0 | 0 | 0 | 0  | 0  |
| 2049 | 0 | 0 | 0 | 0 | 0 | 0 | 0 | 0 | 0 | 0  | 0  |
| 2050 | 0 | 0 | 0 | 0 | 0 | 0 | 0 | 0 | 0 | 0  | 0  |
| 2051 | 0 | 0 | 0 | 0 | 0 | 0 | 0 | 0 | 0 | 0  | 0  |
| 2052 | 0 | 0 | 0 | 0 | 0 | 0 | 0 | 0 | 0 | 0  | 0  |
| 2053 | 0 | 0 | 0 | 0 | 0 | 0 | 0 | 0 | 0 | 0  | 0  |
| 2054 | 0 | 0 | 0 | 0 | 0 | 0 | 0 | 0 | 0 | 0  | 0  |
| 2055 | 0 | 0 | 0 | 0 | 0 | 0 | 0 | 0 | 0 | 0  | 0  |
| 2056 | 0 | 0 | 0 | 0 | 0 | 0 | 0 | 0 | 0 | 0  | 0  |
| 2057 | 0 | 0 | 0 | 0 | 0 | 0 | 0 | 0 | 0 | 0  | 0  |
| 2058 | 0 | 0 | 0 | 0 | 0 | 0 | 0 | 0 | 0 | 0  | 0  |
| 2059 | 0 | 0 | 0 | 0 | 0 | 0 | 0 | 0 | 0 | 0  | 0  |

|      | 1 | 2 | 3 | 4 | 5 | 6 | 7 | 8 | 9 | 10 | 11 |
|------|---|---|---|---|---|---|---|---|---|----|----|
| 2060 | 0 | 0 | 0 | 0 | 0 | 0 | 0 | 0 | 0 | 0  | 0  |
| 2061 | 0 | 0 | 0 | 0 | 0 | 0 | 0 | 0 | 0 | 0  | 0  |
| 2062 | 0 | 0 | 0 | 0 | 0 | 0 | 0 | 0 | 0 | 0  | 0  |
| 2063 | 0 | 0 | 0 | 0 | 0 | 0 | 0 | 0 | 0 | 0  | 0  |
| 2064 | 0 | 0 | 0 | 0 | 0 | 0 | 0 | 0 | 0 | 0  | 0  |
| 2065 | 0 | 0 | 0 | 0 | 0 | 0 | 0 | 0 | 0 | 0  | 0  |
| 2066 | 0 | 0 | 0 | 0 | 0 | 0 | 0 | 0 | 0 | 0  | 0  |
| 2067 | 0 | 0 | 0 | 0 | 0 | 0 | 0 | 0 | 0 | 0  | 0  |
| 2068 | 0 | 0 | 0 | 0 | 0 | 0 | 0 | 0 | 0 | 0  | 0  |
| 2069 | 0 | 0 | 0 | 0 | 0 | 0 | 0 | 0 | 0 | 0  | 0  |
| 2070 | 0 | 0 | 0 | 0 | 0 | 0 | 0 | 0 | 0 | 0  | 0  |
| 2071 | 0 | 0 | 0 | 0 | 0 | 0 | 0 | 0 | 0 | 0  | 0  |
| 2072 | 0 | 0 | 0 | 0 | 0 | 0 | 0 | 0 | 0 | 0  | 0  |
| 2073 | 0 | 0 | 0 | 0 | 0 | 0 | 0 | 0 | 0 | 0  | 0  |
| 2074 | 0 | 0 | 0 | 0 | 0 | 0 | 0 | 0 | 0 | 0  | 0  |
| 2075 | 0 | 0 | 0 | 0 | 0 | 0 | 0 | 0 | 0 | 0  | 0  |
| 2076 | 0 | 0 | 0 | 0 | 0 | 0 | 0 | 0 | 0 | 0  | 0  |
| 2077 | 0 | 0 | 0 | 0 | 0 | 0 | 0 | 0 | 0 | 0  | 0  |
| 2078 | 0 | 0 | 0 | 0 | 0 | 0 | 0 | 0 | 0 | 0  | 0  |
| 2079 | 0 | 0 | 0 | 0 | 0 | 0 | 0 | 0 | 0 | 0  | 0  |
| 2080 | 0 | 0 | 0 | 0 | 0 | 0 | 0 | 0 | 0 | 0  | 0  |
| 2081 | 0 | 0 | 0 | 0 | 0 | 0 | 0 | 0 | 0 | 0  | 0  |
| 2082 | 0 | 0 | 0 | 0 | 0 | 0 | 0 | 0 | 0 | 0  | 0  |
| 2083 | 0 | 0 | 0 | 0 | 0 | 0 | 0 | 0 | 0 | 0  | 0  |
| 2084 | 0 | 0 | 0 | 0 | 0 | 0 | 0 | 0 | 0 | 0  | 0  |
| 2085 | 0 | 0 | 0 | 0 | 0 | 0 | 0 | 0 | 0 | 0  | 0  |
| 2086 | 0 | 0 | 0 | 0 | 0 | 0 | 0 | 0 | 0 | 0  | 0  |
| 2087 | 0 | 0 | 0 | 0 | 0 | 0 | 0 | 0 | 0 | 0  | 0  |
| 2088 | 0 | 0 | 0 | 0 | 0 | 0 | 0 | 0 | 0 | 0  | 0  |
| 2089 | 0 | 0 | 0 | 0 | 0 | 0 | 0 | 0 | 0 | 0  | 0  |
| 2090 | 0 | 0 | 0 | 0 | 0 | 0 | 0 | 0 | 0 | 0  | 0  |

|      | 12 | 13 | 14 | 15 | 16 | 17 | 18 | 19 | 20 | 21 | 22 |
|------|----|----|----|----|----|----|----|----|----|----|----|
| 2002 | 0  | 0  | 0  | 0  | 0  | 0  | 0  | 0  | 0  | 0  | 0  |
| 2003 | 0  | 0  | 0  | 0  | 0  | 0  | 0  | 0  | 0  | 0  | 0  |
| 2004 | 0  | 0  | 0  | 0  | 0  | 0  | 0  | 0  | 0  | 0  | 0  |
| 2005 | 0  | 0  | 0  | 0  | 0  | 0  | 0  | 0  | 0  | 0  | 0  |
| 2006 | 0  | 0  | 0  | 0  | 0  | 0  | 0  | 0  | 0  | 0  | 0  |
| 2007 | 0  | 0  | 0  | 0  | 0  | 0  | 0  | 0  | 0  | 0  | 0  |
| 2008 | 0  | 0  | 0  | 0  | 0  | 0  | 0  | 0  | 0  | 0  | 0  |
| 2009 | 0  | 0  | 0  | 0  | 0  | 0  | 0  | 0  | 0  | 0  | 0  |
| 2010 | 0  | 0  | 0  | 0  | 0  | 0  | 0  | 0  | 0  | 0  | 0  |
| 2011 | 0  | 0  | 0  | 0  | 0  | 0  | 0  | 0  | 0  | 0  | 0  |
| 2012 | 0  | 0  | 0  | 0  | 0  | 0  | 0  | 0  | 0  | 0  | 0  |
| 2013 | 0  | 0  | 0  | 0  | 0  | 0  | 0  | 0  | 0  | 0  | 0  |
| 2014 | 0  | 0  | 0  | 0  | 0  | 0  | 0  | 0  | 0  | 0  | 0  |
| 2015 | 0  | 0  | 0  | 0  | 0  | 0  | 0  | 0  | 0  | 0  | 0  |
| 2016 | 0  | 0  | 0  | 0  | 0  | 0  | 0  | 0  | 0  | 0  | 0  |
| 2017 | 0  | 0  | 0  | 0  | 0  | 0  | 0  | 0  | 0  | 0  | 0  |
| 2018 | 0  | 0  | 0  | 0  | 0  | 0  | 0  | 0  | 0  | 0  | 0  |
| 2019 | 0  | 0  | 0  | 0  | 0  | 0  | 0  | 0  | 0  | 0  | 0  |
| 2020 | 0  | 0  | 0  | 0  | 0  | 0  | 0  | 0  | 0  | 0  | 0  |
| 2021 | 0  | 0  | 0  | 0  | 0  | 0  | 0  | 0  | 0  | 0  | 0  |
| 2022 | 0  | 0  | 0  | 0  | 0  | 0  | 0  | 0  | 0  | 0  | 0  |
| 2023 | 0  | 0  | 0  | 0  | 0  | 0  | 0  | 0  | 0  | 0  | 1  |
| 2024 | 0  | 0  | 0  | 0  | 0  | 0  | 0  | 0  | 0  | 0  | 2  |
| 2025 | 0  | 0  | 0  | 0  | 0  | 0  | 0  | 0  | 0  | 0  | 2  |
| 2026 | 0  | 0  | 0  | 0  | 0  | 0  | 0  | 0  | 0  | 0  | 6  |
| 2027 | 0  | 0  | 0  | 0  | 0  | 0  | 0  | 0  | 0  | 0  | 7  |
| 2028 | 0  | 0  | 0  | 0  | 0  | 0  | 0  | 2  | 0  | 0  | 9  |
| 2029 | 0  | 0  | 0  | 0  | 0  | 2  | 0  | 2  | 0  | 0  | 9  |
| 2030 | 0  | 0  | 0  | 0  | 0  | 2  | 0  | 2  | 0  | 0  | 9  |
| 2031 | 0  | 0  | 0  | 0  | 0  | 2  | 0  | 4  | 0  | 0  | 9  |
| 2032 | 0  | 0  | 0  | 0  | 0  | 3  | 0  | 5  | 0  | 0  | 9  |
| 2033 | 0  | 0  | 0  | 0  | 0  | 5  | 0  | 7  | 0  | 0  | 9  |
| 2034 | 0  | 0  | 0  | 0  | 0  | 5  | 0  | 7  | 0  | 0  | 9  |
| 2035 | 0  | 0  | 0  | 0  | 0  | 7  | 0  | 7  | 0  | 0  | 9  |
| 2036 | 0  | 0  | 0  | 0  | 0  | 7  | 0  | 7  | 0  | 0  | 9  |
| 2037 | 0  | 0  | 0  | 0  | 0  | 7  | 0  | 7  | 0  | 0  | 9  |
| 2038 | 0  | 0  | 0  | 0  | 0  | 7  | 0  | 7  | 0  | 0  | 9  |
| 2039 | 0  | 0  | 0  | 0  | 0  | 7  | 0  | 7  | 0  | 0  | 9  |
| 2040 | 0  | 0  | 0  | 0  | 0  | 7  | 0  | 7  | 0  | 0  | 9  |
| 2041 | 0  | 0  | 0  | 0  | 0  | 7  | 0  | 7  | 0  | 0  | 9  |
| 2042 | 0  | 0  | 0  | 0  | 0  | 7  | 0  | 7  | 0  | 0  | 9  |
| 2043 | 0  | 0  | 0  | 0  | 0  | 7  | 0  | 7  | 0  | 0  | 9  |
| 2044 | 0  | 0  | 0  | 0  | 0  | 7  | 0  | 7  | 0  | 0  | 9  |
| 2045 | 0  | 0  | 0  | 0  | 0  | 7  | 0  | 7  | 0  | 0  | 9  |
| 2046 | 0  | 0  | 0  | 0  | 0  | 7  | 0  | 7  | 0  | 0  | 9  |
| 2047 | 0  | 0  | 0  | 0  | 0  | 7  | 0  | 7  | 0  | 0  | 9  |
| 2048 | 0  | 0  | 0  | 0  | 0  | 7  | 0  | 7  | 0  | 0  | 9  |
| 2049 | 0  | 0  | 0  | 0  | 0  | 7  | 0  | 7  | 0  | 0  | 9  |
| 2050 | 0  | 0  | 0  | 0  | 0  | 7  | 0  | 7  | 0  | 0  | 9  |
| 2051 | 0  | 0  | 0  | 0  | 0  | 7  | 0  | 7  | 0  | 0  | 9  |
| 2052 | 0  | 0  | 0  | 0  | 0  | 7  | 0  | 7  | 0  | 0  | 9  |
| 2053 | 0  | 0  | 0  | 0  | 0  | 7  | 0  | 7  | 0  | 0  | 9  |
| 2054 | 0  | 0  | 0  | 0  | 0  | 7  | 0  | 7  | 0  | 0  | 9  |
| 2055 | 0  | 0  | 0  | 0  | 0  | 7  | 0  | 7  | 0  | 0  | 9  |
| 2056 | 0  | 0  | 0  | 0  | 0  | 7  | 0  | 7  | 0  | 0  | 9  |
| 2057 | 0  | 0  | 0  | 0  | 0  | 7  | 0  | 7  | 0  | 0  | 9  |
| 2058 | 0  | 0  | 0  | 0  | 0  | 7  | 0  | 7  | 0  | 0  | 9  |
| 2059 | 0  | 0  | 0  | 0  | 0  | 7  | 0  | 7  | 0  | 0  | 9  |

|      | 12 | 13 | 14 | 15 | 16 | 17 | 18 | 19 | 20 | 21 | 22 |
|------|----|----|----|----|----|----|----|----|----|----|----|
| 2060 | 0  | 0  | 0  | 0  | 0  | 7  | 0  | 7  | 0  | 0  | 9  |
| 2061 | 0  | 0  | 0  | 0  | 0  | 7  | 0  | 7  | 0  | 0  | 9  |
| 2062 | 0  | 0  | 0  | 0  | 0  | 7  | 0  | 7  | 0  | 0  | 9  |
| 2063 | 0  | 0  | 0  | 0  | 0  | 7  | 0  | 7  | 0  | 0  | 9  |
| 2064 | 0  | 0  | 0  | 0  | 0  | 7  | 0  | 7  | 0  | 0  | 9  |
| 2065 | 0  | 0  | 0  | 0  | 0  | 7  | 0  | 7  | 0  | 0  | 9  |
| 2066 | 0  | 0  | 0  | 0  | 0  | 7  | 0  | 7  | 0  | 0  | 9  |
| 2067 | 0  | 0  | 0  | 0  | 0  | 7  | 0  | 7  | 0  | 0  | 9  |
| 2068 | 0  | 0  | 0  | 0  | 0  | 7  | 0  | 7  | 0  | 0  | 9  |
| 2069 | 0  | 0  | 0  | 0  | 0  | 7  | 0  | 7  | 0  | 0  | 9  |
| 2070 | 0  | 0  | 0  | 0  | 0  | 7  | 0  | 7  | 0  | 0  | 9  |
| 2071 | 0  | 0  | 0  | 0  | 0  | 7  | 0  | 7  | 0  | 0  | 9  |
| 2072 | 0  | 0  | 0  | 0  | 0  | 7  | 0  | 7  | 0  | 0  | 9  |
| 2073 | 0  | 0  | 0  | 0  | 0  | 7  | 0  | 7  | 0  | 0  | 9  |
| 2074 | 0  | 0  | 0  | 0  | 0  | 7  | 0  | 7  | 0  | 0  | 9  |
| 2075 | 0  | 0  | 0  | 0  | 0  | 7  | 0  | 7  | 0  | 0  | 9  |
| 2076 | 0  | 0  | 0  | 0  | 0  | 7  | 0  | 7  | 0  | 0  | 9  |
| 2077 | 0  | 0  | 0  | 0  | 0  | 7  | 0  | 7  | 0  | 0  | 9  |
| 2078 | 0  | 0  | 0  | 0  | 0  | 7  | 0  | 7  | 0  | 0  | 9  |
| 2079 | 0  | 0  | 0  | 0  | 0  | 7  | 0  | 7  | 0  | 0  | 9  |
| 2080 | 0  | 0  | 0  | 0  | 0  | 7  | 0  | 7  | 0  | 0  | 9  |
| 2081 | 0  | 0  | 0  | 0  | 0  | 7  | 0  | 7  | 0  | 0  | 9  |
| 2082 | 0  | 0  | 0  | 0  | 0  | 7  | 0  | 7  | 0  | 0  | 9  |
| 2083 | 0  | 0  | 0  | 0  | 0  | 7  | 0  | 7  | 0  | 0  | 9  |
| 2084 | 0  | 0  | 0  | 0  | 0  | 7  | 0  | 7  | 0  | 0  | 9  |
| 2085 | 0  | 0  | 0  | 0  | 0  | 7  | 0  | 7  | 0  | 0  | 9  |
| 2086 | 0  | 0  | 0  | 0  | 0  | 7  | 0  | 7  | 0  | 0  | 9  |
| 2087 | 0  | 0  | 0  | 0  | 0  | 7  | 0  | 7  | 0  | 0  | 9  |
| 2088 | 0  | 0  | 0  | 0  | 0  | 7  | 0  | 7  | 0  | 0  | 9  |
| 2089 | 0  | 0  | 0  | 0  | 0  | 7  | 0  | 7  | 0  | 0  | 9  |
| 2090 | 0  | 0  | 0  | 0  | 0  | 7  | 0  | 7  | 0  | 0  | 9  |

|      | 23 | 24 | 25 | 26 | 27 | 28 | 29 | 30 | 31 | 32 | 33 |
|------|----|----|----|----|----|----|----|----|----|----|----|
| 2002 | 0  | 0  | 0  | 0  | 0  | 0  | 0  | 0  | 0  | 0  | 0  |
| 2003 | 0  | 0  | 0  | 0  | 0  | 0  | 0  | 0  | 0  | 0  | 0  |
| 2004 | 0  | 0  | 0  | 0  | 0  | 0  | 0  | 0  | 0  | 0  | 0  |
| 2005 | 0  | 0  | 0  | 0  | 0  | 0  | 0  | 0  | 0  | 0  | 0  |
| 2006 | 0  | 0  | 0  | 0  | 0  | 0  | 0  | 0  | 0  | 0  | 0  |
| 2007 | 0  | 0  | 0  | 0  | 0  | 0  | 0  | 0  | 0  | 0  | 0  |
| 2008 | 0  | 0  | 0  | 0  | 0  | 0  | 0  | 0  | 0  | 0  | 0  |
| 2009 | 0  | 0  | 0  | 0  | 0  | 0  | 0  | 0  | 0  | 0  | 0  |
| 2010 | 0  | 0  | 0  | 0  | 0  | 0  | 0  | 0  | 0  | 0  | 0  |
| 2011 | 0  | 0  | 0  | 0  | 0  | 0  | 0  | 0  | 0  | 0  | 0  |
| 2012 | 0  | 0  | 0  | 0  | 0  | 0  | 0  | 0  | 0  | 0  | 0  |
| 2013 | 0  | 0  | 0  | 0  | 0  | 0  | 0  | 0  | 0  | 0  | 0  |
| 2014 | 0  | 0  | 0  | 0  | 0  | 0  | 0  | 0  | 0  | 0  | 0  |
| 2015 | 0  | 0  | 0  | 0  | 0  | 0  | 0  | 0  | 0  | 0  | 0  |
| 2016 | 0  | 0  | 0  | 0  | 0  | 0  | 0  | 0  | 0  | 0  | 0  |
| 2017 | 0  | 0  | 0  | 0  | 0  | 0  | 0  | 0  | 0  | 0  | 0  |
| 2018 | 0  | 0  | 0  | 0  | 0  | 0  | 0  | 0  | 0  | 0  | 0  |
| 2019 | 0  | 0  | 0  | 0  | 0  | 0  | 0  | 0  | 0  | 0  | 0  |
| 2020 | 0  | 0  | 0  | 0  | 0  | 0  | 0  | 0  | 0  | 0  | 0  |
| 2021 | 0  | 0  | 0  | 0  | 0  | 0  | 0  | 0  | 0  | 0  | 0  |
| 2022 | 0  | 0  | 0  | 0  | 0  | 0  | 0  | 0  | 0  | 0  | 0  |
| 2023 | 0  | 0  | 0  | 0  | 0  | 0  | 0  | 0  | 0  | 0  | 0  |
| 2024 | 0  | 0  | 0  | 0  | 0  | 0  | 0  | 0  | 0  | 0  | 0  |
| 2025 | 0  | 0  | 0  | 0  | 0  | 0  | 0  | 0  | 0  | 0  | 0  |
| 2026 | 0  | 0  | 0  | 0  | 0  | 0  | 0  | 0  | 0  | 0  | 0  |
| 2027 | 0  | 0  | 0  | 0  | 0  | 0  | 0  | 0  | 0  | 0  | 0  |
| 2028 | 0  | 1  | 0  | 0  | 2  | 0  | 0  | 0  | 0  | 0  | 0  |
| 2029 | 0  | 1  | 0  | 1  | 2  | 0  | 0  | 0  | 0  | 0  | 0  |
| 2030 | 0  | 1  | 0  | 1  | 2  | 0  | 0  | 0  | 0  | 0  | 0  |
| 2031 | 0  | 1  | 0  | 1  | 2  | 0  | 0  | 0  | 0  | 0  | 0  |
| 2032 | 0  | 1  | 0  | 1  | 2  | 0  | 0  | 0  | 0  | 0  | 0  |
| 2033 | 0  | 1  | 0  | 1  | 2  | 0  | 0  | 0  | 0  | 0  | 0  |
| 2034 | 0  | 1  | 0  | 1  | 2  | 0  | 0  | 0  | 0  | 0  | 0  |
| 2035 | 0  | 1  | 0  | 3  | 2  | 0  | 0  | 0  | 0  | 0  | 0  |
| 2036 | 0  | 1  | 0  | 4  | 2  | 0  | 0  | 0  | 0  | 0  | 0  |
| 2037 | 0  | 1  | 0  | 4  | 2  | 0  | 0  | 0  | 0  | 0  | 0  |
| 2038 | 0  | 1  | 0  | 8  | 2  | 0  | 0  | 0  | 0  | 0  | 0  |
| 2039 | 0  | 1  | 0  | 9  | 2  | 0  | 0  | 0  | 0  | 0  | 0  |
| 2040 | 0  | 1  | 0  | 11 | 2  | 0  | 0  | 0  | 0  | 0  | 0  |
| 2041 | 0  | 1  | 0  | 11 | 2  | 0  | 0  | 0  | 0  | 0  | 0  |
| 2042 | 0  | 1  | 0  | 11 | 2  | 0  | 0  | 0  | 0  | 0  | 0  |
| 2043 | 0  | 1  | 0  | 11 | 2  | 0  | 0  | 0  | 0  | 0  | 0  |
| 2044 | 0  | 1  | 0  | 11 | 2  | 0  | 0  | 0  | 0  | 0  | 0  |
| 2045 | 0  | 1  | 0  | 11 | 2  | 0  | 0  | 0  | 0  | 0  | 0  |
| 2046 | 0  | 1  | 0  | 11 | 2  | 0  | 0  | 0  | 0  | 0  | 0  |
| 2047 | 0  | 1  | 0  | 11 | 2  | 0  | 0  | 0  | 0  | 0  | 0  |
| 2048 | 0  | 1  | 0  | 11 | 2  | 0  | 0  | 0  | 0  | 0  | 0  |
| 2049 | 0  | 1  | 0  | 11 | 2  | 0  | 0  | 0  | 0  | 0  | 0  |
| 2050 | 0  | 1  | 0  | 11 | 2  | 0  | 0  | 0  | 0  | 0  | 0  |
| 2051 | 0  | 1  | 0  | 11 | 2  | 0  | 0  | 0  | 0  | 0  | 0  |
| 2052 | 0  | 1  | 0  | 11 | 2  | 0  | 0  | 0  | 0  | 0  | 0  |
| 2053 | 0  | 1  | 0  | 11 | 2  | 0  | 0  | 0  | 0  | 0  | 0  |
| 2054 | 0  | 1  | 0  | 11 | 2  | 0  | 0  | 0  | 0  | 0  | 0  |
| 2055 | 0  | 1  | 0  | 11 | 2  | 0  | 0  | 0  | 0  | 0  | 0  |
| 2056 | 0  | 1  | 0  | 11 | 2  | 0  | 0  | 0  | 0  | 0  | 0  |
| 2057 | 0  | 1  | 0  | 11 | 2  | 0  | 0  | 0  | 0  | 0  | 0  |
| 2058 | 0  | 1  | 0  | 11 | 2  | 0  | 0  | 0  | 0  | 0  | 0  |
| 2059 | 0  | 1  | 0  | 11 | 2  | 0  | 0  | 0  | 0  | 0  | 0  |

|      | 23 | 24 | 25 | 26 | 27 | 28 | 29 | 30 | 31 | 32 | 33 |
|------|----|----|----|----|----|----|----|----|----|----|----|
| 2060 | 0  | 1  | 0  | 11 | 2  | 0  | 0  | 0  | 0  | 0  | 0  |
| 2061 | 0  | 1  | 0  | 11 | 2  | 0  | 0  | 0  | 0  | 0  | 0  |
| 2062 | 0  | 1  | 0  | 11 | 2  | 0  | 0  | 0  | 0  | 0  | 0  |
| 2063 | 0  | 1  | 0  | 11 | 2  | 0  | 0  | 0  | 0  | 0  | 0  |
| 2064 | 0  | 1  | 0  | 11 | 2  | 0  | 0  | 0  | 0  | 0  | 0  |
| 2065 | 0  | 1  | 0  | 11 | 2  | 0  | 0  | 0  | 0  | 0  | 0  |
| 2066 | 0  | 1  | 0  | 11 | 2  | 0  | 0  | 0  | 0  | 0  | 0  |
| 2067 | 0  | 1  | 0  | 11 | 2  | 0  | 0  | 0  | 0  | 0  | 0  |
| 2068 | 0  | 1  | 0  | 11 | 2  | 0  | 0  | 0  | 0  | 0  | 0  |
| 2069 | 0  | 1  | 0  | 11 | 2  | 0  | 0  | 0  | 0  | 0  | 0  |
| 2070 | 0  | 1  | 0  | 11 | 2  | 0  | 0  | 0  | 0  | 0  | 0  |
| 2071 | 0  | 1  | 0  | 11 | 2  | 0  | 0  | 0  | 0  | 0  | 0  |
| 2072 | 0  | 1  | 0  | 11 | 2  | 0  | 0  | 0  | 0  | 0  | 0  |
| 2073 | 0  | 1  | 0  | 11 | 2  | 0  | 0  | 0  | 0  | 0  | 0  |
| 2074 | 0  | 1  | 0  | 11 | 2  | 0  | 0  | 0  | 0  | 0  | 0  |
| 2075 | 0  | 1  | 0  | 11 | 2  | 0  | 0  | 0  | 0  | 0  | 0  |
| 2076 | 0  | 1  | 0  | 11 | 2  | 0  | 0  | 0  | 0  | 0  | 0  |
| 2077 | 0  | 1  | 0  | 11 | 2  | 0  | 0  | 0  | 0  | 0  | 0  |
| 2078 | 0  | 1  | 0  | 11 | 2  | 0  | 0  | 0  | 0  | 0  | 0  |
| 2079 | 0  | 1  | 0  | 11 | 2  | 0  | 0  | 0  | 0  | 0  | 0  |
| 2080 | 0  | 1  | 0  | 11 | 2  | 0  | 0  | 0  | 0  | 0  | 0  |
| 2081 | 0  | 1  | 0  | 11 | 2  | 0  | 0  | 0  | 0  | 0  | 0  |
| 2082 | 0  | 1  | 0  | 11 | 2  | 0  | 0  | 0  | 0  | 0  | 0  |
| 2083 | 0  | 1  | 0  | 11 | 2  | 0  | 0  | 0  | 0  | 0  | 0  |
| 2084 | 0  | 1  | 0  | 11 | 2  | 0  | 0  | 0  | 0  | 0  | 0  |
| 2085 | 0  | 1  | 0  | 11 | 2  | 0  | 0  | 0  | 0  | 0  | 0  |
| 2086 | 0  | 1  | 0  | 11 | 2  | 0  | 0  | 0  | 0  | 0  | 0  |
| 2087 | 0  | 1  | 0  | 11 | 2  | 0  | 0  | 0  | 0  | 0  | 0  |
| 2088 | 0  | 1  | 0  | 11 | 2  | 0  | 0  | 0  | 0  | 0  | 0  |
| 2089 | 0  | 1  | 0  | 11 | 2  | 0  | 0  | 0  | 0  | 0  | 0  |
| 2090 | 0  | 1  | 0  | 11 | 2  | 0  | 0  | 0  | 0  | 0  | 0  |

|      | 34 | 35 | 36 | 37 | 38 | 39 | 40 | 41 | 42 | 43 | 44 |
|------|----|----|----|----|----|----|----|----|----|----|----|
| 2002 | 0  | 0  | 0  | 0  | 0  | 0  | 0  | 0  | 0  | 0  | 0  |
| 2003 | 0  | 0  | 0  | 0  | 0  | 0  | 0  | 0  | 0  | 0  | 0  |
| 2004 | 0  | 0  | 0  | 0  | 0  | 0  | 0  | 0  | 0  | 0  | 0  |
| 2005 | 0  | 0  | 0  | 0  | 0  | 0  | 0  | 0  | 0  | 0  | 0  |
| 2006 | 0  | 0  | 0  | 0  | 0  | 0  | 0  | 0  | 0  | 0  | 0  |
| 2007 | 0  | 0  | 0  | 0  | 0  | 0  | 0  | 0  | 0  | 0  | 0  |
| 2008 | 0  | 0  | 0  | 0  | 0  | 0  | 0  | 0  | 0  | 0  | 0  |
| 2009 | 0  | 0  | 0  | 0  | 0  | 0  | 0  | 0  | 0  | 0  | 0  |
| 2010 | 0  | 0  | 0  | 0  | 0  | 0  | 0  | 0  | 0  | 0  | 0  |
| 2011 | 0  | 0  | 0  | 0  | 0  | 0  | 0  | 0  | 0  | 0  | 0  |
| 2012 | 0  | 0  | 0  | 0  | 0  | 0  | 0  | 0  | 0  | 0  | 0  |
| 2013 | 0  | 0  | 0  | 0  | 0  | 0  | 0  | 0  | 0  | 0  | 0  |
| 2014 | 0  | 0  | 0  | 0  | 0  | 0  | 0  | 0  | 0  | 0  | 0  |
| 2015 | 0  | 0  | 0  | 0  | 0  | 0  | 0  | 0  | 0  | 0  | 0  |
| 2016 | 0  | 0  | 0  | 0  | 0  | 0  | 0  | 0  | 0  | 0  | 0  |
| 2017 | 0  | 0  | 0  | 0  | 0  | 0  | 0  | 0  | 0  | 0  | 0  |
| 2018 | 0  | 0  | 0  | 0  | 0  | 0  | 0  | 0  | 0  | 0  | 0  |
| 2019 | 0  | 0  | 0  | 0  | 0  | 0  | 0  | 0  | 0  | 0  | 0  |
| 2020 | 0  | 0  | 0  | 0  | 0  | 0  | 0  | 0  | 0  | 0  | 0  |
| 2021 | 0  | 0  | 0  | 0  | 0  | 0  | 0  | 0  | 0  | 0  | 0  |
| 2022 | 0  | 0  | 0  | 0  | 0  | 0  | 0  | 0  | 0  | 0  | 0  |
| 2023 | 0  | 0  | 0  | 0  | 0  | 0  | 0  | 0  | 0  | 0  | 0  |
| 2024 | 0  | 0  | 0  | 0  | 0  | 0  | 0  | 0  | 0  | 0  | 0  |
| 2025 | 0  | 0  | 0  | 0  | 0  | 0  | 0  | 0  | 0  | 0  | 0  |
| 2026 | 0  | 0  | 0  | 0  | 0  | 0  | 0  | 0  | 0  | 0  | 0  |
| 2027 | 0  | 0  | 0  | 0  | 0  | 0  | 0  | 0  | 0  | 0  | 3  |
| 2028 | 0  | 0  | 0  | 0  | 0  | 0  | 0  | 0  | 0  | 0  | 3  |
| 2029 | 0  | 0  | 0  | 0  | 0  | 0  | 0  | 0  | 0  | 0  | 5  |
| 2030 | 0  | 0  | 0  | 0  | 0  | 0  | 0  | 0  | 0  | 0  | 5  |
| 2031 | 0  | 0  | 0  | 0  | 0  | 0  | 0  | 0  | 0  | 0  | 5  |
| 2032 | 0  | 0  | 0  | 0  | 0  | 0  | 0  | 0  | 0  | 0  | 6  |
| 2033 | 0  | 0  | 0  | 0  | 0  | 0  | 0  | 0  | 0  | 0  | 8  |
| 2034 | 0  | 0  | 0  | 0  | 0  | 0  | 0  | 0  | 0  | 0  | 8  |
| 2035 | 0  | 0  | 0  | 0  | 0  | 0  | 0  | 0  | 0  | 0  | 10 |
| 2036 | 0  | 0  | 0  | 0  | 0  | 0  | 0  | 0  | 0  | 0  | 10 |
| 2037 | 0  | 0  | 0  | 0  | 0  | 0  | 0  | 0  | 0  | 0  | 10 |
| 2038 | 0  | 0  | 0  | 0  | 0  | 0  | 0  | 0  | 0  | 0  | 10 |
| 2039 | 0  | 0  | 0  | 0  | 0  | 0  | 0  | 0  | 0  | 0  | 10 |
| 2040 | 0  | 0  | 0  | 0  | 0  | 0  | 0  | 0  | 0  | 0  | 10 |
| 2041 | 0  | 0  | 0  | 0  | 0  | 0  | 0  | 0  | 0  | 0  | 10 |
| 2042 | 0  | 0  | 0  | 0  | 0  | 0  | 0  | 0  | 0  | 0  | 10 |
| 2043 | 0  | 0  | 0  | 0  | 0  | 0  | 0  | 0  | 0  | 0  | 10 |
| 2044 | 0  | 0  | 0  | 0  | 0  | 0  | 0  | 0  | 0  | 0  | 10 |
| 2045 | 0  | 0  | 0  | 0  | 0  | 0  | 0  | 0  | 0  | 0  | 10 |
| 2046 | 0  | 0  | 0  | 0  | 0  | 0  | 0  | 0  | 0  | 0  | 10 |
| 2047 | 0  | 0  | 0  | 0  | 0  | 0  | 0  | 0  | 0  | 0  | 10 |
| 2048 | 0  | 0  | 0  | 0  | 0  | 0  | 0  | 0  | 0  | 0  | 10 |
| 2049 | 0  | 0  | 0  | 0  | 0  | 0  | 0  | 0  | 0  | 0  | 10 |
| 2050 | 0  | 0  | 0  | 0  | 0  | 0  | 0  | 0  | 0  | 0  | 10 |
| 2051 | 0  | 0  | 0  | 0  | 0  | 0  | 0  | 0  | 0  | 0  | 10 |
| 2052 | 0  | 0  | 0  | 0  | 0  | 0  | 0  | 0  | 0  | 0  | 10 |
| 2053 | 0  | 0  | 0  | 0  | 0  | 0  | 0  | 0  | 0  | 0  | 10 |
| 2054 | 0  | 0  | 0  | 0  | 0  | 0  | 0  | 0  | 0  | 0  | 10 |
| 2055 | 0  | 0  | 0  | 0  | 0  | 0  | 0  | 0  | 0  | 0  | 10 |
| 2056 | 0  | 0  | 0  | 0  | 0  | 0  | 0  | 0  | 0  | 0  | 10 |
| 2057 | 0  | 0  | 0  | 0  | 0  | 0  | 0  | 0  | 0  | 0  | 10 |
| 2058 | 0  | 0  | 0  | 0  | 0  | 0  | 0  | 0  | 0  | 0  | 10 |
| 2059 | 0  | 0  | 0  | 0  | 0  | 0  | 0  | 0  | 0  | 0  | 10 |

|      | 34 | 35 | 36 | 37 | 38 | 39 | 40 | 41 | 42 | 43 | 44 |
|------|----|----|----|----|----|----|----|----|----|----|----|
| 2060 | 0  | 0  | 0  | 0  | 0  | 0  | 0  | 0  | 0  | 0  | 10 |
| 2061 | 0  | 0  | 0  | 0  | 0  | 0  | 0  | 0  | 0  | 0  | 10 |
| 2062 | 0  | 0  | 0  | 0  | 0  | 0  | 0  | 0  | 0  | 0  | 10 |
| 2063 | 0  | 0  | 0  | 0  | 0  | 0  | 0  | 0  | 0  | 0  | 10 |
| 2064 | 0  | 0  | 0  | 0  | 0  | 0  | 0  | 0  | 0  | 0  | 10 |
| 2065 | 0  | 0  | 0  | 0  | 0  | 0  | 0  | 0  | 0  | 0  | 10 |
| 2066 | 0  | 0  | 0  | 0  | 0  | 0  | 0  | 0  | 0  | 0  | 10 |
| 2067 | 0  | 0  | 0  | 0  | 0  | 0  | 0  | 0  | 0  | 0  | 10 |
| 2068 | 0  | 0  | 0  | 0  | 0  | 0  | 0  | 0  | 0  | 0  | 10 |
| 2069 | 0  | 0  | 0  | 0  | 0  | 0  | 0  | 0  | 0  | 0  | 10 |
| 2070 | 0  | 0  | 0  | 0  | 0  | 0  | 0  | 0  | 0  | 0  | 10 |
| 2071 | 0  | 0  | 0  | 0  | 0  | 0  | 0  | 0  | 0  | 0  | 10 |
| 2072 | 0  | 0  | 0  | 0  | 0  | 0  | 0  | 0  | 0  | 0  | 10 |
| 2073 | 0  | 0  | 0  | 0  | 0  | 0  | 0  | 0  | 0  | 0  | 10 |
| 2074 | 0  | 0  | 0  | 0  | 0  | 0  | 0  | 0  | 0  | 0  | 10 |
| 2075 | 0  | 0  | 0  | 0  | 0  | 0  | 0  | 0  | 0  | 0  | 10 |
| 2076 | 0  | 0  | 0  | 0  | 0  | 0  | 0  | 0  | 0  | 0  | 10 |
| 2077 | 0  | 0  | 0  | 0  | 0  | 0  | 0  | 0  | 0  | 0  | 10 |
| 2078 | 0  | 0  | 0  | 0  | 0  | 0  | 0  | 0  | 0  | 0  | 10 |
| 2079 | 0  | 0  | 0  | 0  | 0  | 0  | 0  | 0  | 0  | 0  | 10 |
| 2080 | 0  | 0  | 0  | 0  | 0  | 0  | 0  | 0  | 0  | 0  | 10 |
| 2081 | 0  | 0  | 0  | 0  | 0  | 0  | 0  | 0  | 0  | 0  | 10 |
| 2082 | 0  | 0  | 0  | 0  | 0  | 0  | 0  | 0  | 0  | 0  | 10 |
| 2083 | 0  | 0  | 0  | 0  | 0  | 0  | 0  | 0  | 0  | 0  | 10 |
| 2084 | 0  | 0  | 0  | 0  | 0  | 0  | 0  | 0  | 0  | 0  | 10 |
| 2085 | 0  | 0  | 0  | 0  | 0  | 0  | 0  | 0  | 0  | 0  | 10 |
| 2086 | 0  | 0  | 0  | 0  | 0  | 0  | 0  | 0  | 0  | 0  | 10 |
| 2087 | 0  | 0  | 0  | 0  | 0  | 0  | 0  | 0  | 0  | 0  | 10 |
| 2088 | 0  | 0  | 0  | 0  | 0  | 0  | 0  | 0  | 0  | 0  | 10 |
| 2089 | 0  | 0  | 0  | 0  | 0  | 0  | 0  | 0  | 0  | 0  | 10 |
| 2090 | 0  | 0  | 0  | 0  | 0  | 0  | 0  | 0  | 0  | 0  | 10 |



|      | 45 | 46 | 47 | 48 | 49 | 50 | 51 | 52 | 53 | 54 | 55 |
|------|----|----|----|----|----|----|----|----|----|----|----|
| 2002 | 0  | 0  | 0  | 0  | 0  | 0  | 0  | 0  | 0  | 0  | 0  |
| 2003 | 0  | 0  | 0  | 0  | 0  | 0  | 0  | 0  | 0  | 0  | 0  |
| 2004 | 0  | 0  | 0  | 0  | 0  | 0  | 0  | 0  | 0  | 0  | 0  |
| 2005 | 0  | 0  | 0  | 0  | 0  | 0  | 0  | 0  | 0  | 0  | 0  |
| 2006 | 0  | 0  | 0  | 0  | 0  | 0  | 0  | 0  | 0  | 0  | 0  |
| 2007 | 0  | 0  | 0  | 0  | 0  | 0  | 0  | 0  | 0  | 0  | 0  |
| 2008 | 0  | 0  | 0  | 0  | 0  | 0  | 0  | 0  | 0  | 0  | 0  |
| 2009 | 0  | 0  | 0  | 0  | 0  | 0  | 0  | 0  | 0  | 0  | 0  |
| 2010 | 0  | 0  | 0  | 0  | 0  | 0  | 0  | 0  | 0  | 0  | 0  |
| 2011 | 0  | 0  | 0  | 0  | 0  | 0  | 0  | 0  | 0  | 0  | 0  |
| 2012 | 0  | 0  | 0  | 0  | 0  | 0  | 0  | 0  | 0  | 0  | 0  |
| 2013 | 0  | 0  | 0  | 0  | 0  | 0  | 0  | 0  | 0  | 0  | 0  |
| 2014 | 0  | 0  | 0  | 0  | 0  | 0  | 0  | 0  | 0  | 0  | 0  |
| 2015 | 0  | 0  | 0  | 0  | 0  | 0  | 0  | 0  | 0  | 0  | 0  |
| 2016 | 0  | 0  | 0  | 0  | 0  | 0  | 0  | 0  | 0  | 0  | 0  |
| 2017 | 0  | 0  | 0  | 0  | 0  | 0  | 0  | 0  | 0  | 0  | 0  |
| 2018 | 0  | 0  | 0  | 0  | 0  | 0  | 0  | 0  | 0  | 0  | 0  |
| 2019 | 0  | 0  | 0  | 0  | 0  | 0  | 0  | 0  | 0  | 0  | 0  |
| 2020 | 0  | 0  | 0  | 0  | 0  | 0  | 0  | 0  | 0  | 0  | 0  |
| 2021 | 0  | 0  | 0  | 0  | 0  | 0  | 0  | 0  | 0  | 0  | 0  |
| 2022 | 0  | 0  | 0  | 0  | 0  | 0  | 0  | 0  | 0  | 0  | 0  |
| 2023 | 0  | 0  | 0  | 0  | 1  | 0  | 0  | 0  | 0  | 0  | 0  |
| 2024 | 0  | 0  | 0  | 0  | 2  | 0  | 0  | 0  | 0  | 0  | 0  |
| 2025 | 0  | 0  | 0  | 0  | 2  | 0  | 0  | 0  | 0  | 0  | 0  |
| 2026 | 0  | 0  | 0  | 0  | 6  | 0  | 0  | 0  | 0  | 0  | 0  |
| 2027 | 0  | 0  | 0  | 0  | 7  | 0  | 0  | 0  | 0  | 0  | 0  |
| 2028 | 0  | 2  | 0  | 0  | 9  | 2  | 2  | 0  | 0  | 2  | 0  |
| 2029 | 0  | 2  | 0  | 0  | 9  | 2  | 2  | 0  | 1  | 2  | 0  |
| 2030 | 0  | 2  | 0  | 0  | 9  | 2  | 2  | 0  | 1  | 2  | 0  |
| 2031 | 0  | 4  | 0  | 0  | 9  | 2  | 2  | 0  | 1  | 2  | 0  |
| 2032 | 0  | 5  | 0  | 0  | 9  | 2  | 2  | 0  | 1  | 2  | 0  |
| 2033 | 0  | 7  | 0  | 0  | 9  | 2  | 2  | 0  | 1  | 2  | 0  |
| 2034 | 0  | 7  | 0  | 0  | 9  | 2  | 2  | 0  | 5  | 2  | 0  |
| 2035 | 0  | 7  | 0  | 0  | 9  | 2  | 2  | 0  | 7  | 2  | 0  |
| 2036 | 0  | 7  | 0  | 0  | 9  | 2  | 2  | 0  | 8  | 2  | 0  |
| 2037 | 0  | 7  | 0  | 0  | 9  | 2  | 2  | 0  | 8  | 2  | 0  |
| 2038 | 0  | 7  | 0  | 0  | 9  | 2  | 2  | 0  | 12 | 2  | 0  |
| 2039 | 0  | 7  | 0  | 0  | 9  | 2  | 2  | 0  | 13 | 2  | 0  |
| 2040 | 0  | 7  | 0  | 0  | 9  | 2  | 2  | 0  | 15 | 2  | 0  |
| 2041 | 0  | 7  | 0  | 0  | 9  | 2  | 2  | 0  | 15 | 2  | 0  |
| 2042 | 0  | 7  | 0  | 0  | 9  | 2  | 2  | 0  | 15 | 2  | 0  |
| 2043 | 0  | 7  | 0  | 0  | 9  | 2  | 2  | 0  | 15 | 2  | 0  |
| 2044 | 0  | 7  | 0  | 0  | 9  | 2  | 2  | 0  | 15 | 2  | 0  |
| 2045 | 0  | 7  | 0  | 0  | 9  | 2  | 2  | 0  | 15 | 2  | 0  |
| 2046 | 0  | 7  | 0  | 0  | 9  | 2  | 2  | 0  | 15 | 2  | 0  |
| 2047 | 0  | 7  | 0  | 0  | 9  | 2  | 2  | 0  | 15 | 2  | 0  |
| 2048 | 0  | 7  | 0  | 0  | 9  | 2  | 2  | 0  | 15 | 2  | 0  |
| 2049 | 0  | 7  | 0  | 0  | 9  | 2  | 2  | 0  | 15 | 2  | 0  |
| 2050 | 0  | 7  | 0  | 0  | 9  | 2  | 2  | 0  | 15 | 2  | 0  |
| 2051 | 0  | 7  | 0  | 0  | 9  | 2  | 2  | 0  | 15 | 2  | 0  |
| 2052 | 0  | 7  | 0  | 0  | 9  | 2  | 2  | 0  | 15 | 2  | 0  |
| 2053 | 0  | 7  | 0  | 0  | 9  | 2  | 2  | 0  | 15 | 2  | 0  |
| 2054 | 0  | 7  | 0  | 0  | 9  | 2  | 2  | 0  | 15 | 2  | 0  |
| 2055 | 0  | 7  | 0  | 0  | 9  | 2  | 2  | 0  | 15 | 2  | 0  |
| 2056 | 0  | 7  | 0  | 0  | 9  | 2  | 2  | 0  | 15 | 2  | 0  |
| 2057 | 0  | 7  | 0  | 0  | 9  | 2  | 2  | 0  | 15 | 2  | 0  |
| 2058 | 0  | 7  | 0  | 0  | 9  | 2  | 2  | 0  | 15 | 2  | 0  |
| 2059 | 0  | 7  | 0  | 0  | 9  | 2  | 2  | 0  | 15 | 2  | 0  |

|      | 45 | 46 | 47 | 48 | 49 | 50 | 51 | 52 | 53 | 54 | 55 |
|------|----|----|----|----|----|----|----|----|----|----|----|
| 2060 | 0  | 7  | 0  | 0  | 9  | 2  | 2  | 0  | 15 | 2  | 0  |
| 2061 | 0  | 7  | 0  | 0  | 9  | 2  | 2  | 0  | 15 | 2  | 0  |
| 2062 | 0  | 7  | 0  | 0  | 9  | 2  | 2  | 0  | 15 | 2  | 0  |
| 2063 | 0  | 7  | 0  | 0  | 9  | 2  | 2  | 0  | 15 | 2  | 0  |
| 2064 | 0  | 7  | 0  | 0  | 9  | 2  | 2  | 0  | 15 | 2  | 0  |
| 2065 | 0  | 7  | 0  | 0  | 9  | 2  | 2  | 0  | 15 | 2  | 0  |
| 2066 | 0  | 7  | 0  | 0  | 9  | 2  | 2  | 0  | 15 | 2  | 0  |
| 2067 | 0  | 7  | 0  | 0  | 9  | 2  | 2  | 0  | 15 | 2  | 0  |
| 2068 | 0  | 7  | 0  | 0  | 9  | 2  | 2  | 0  | 15 | 2  | 0  |
| 2069 | 0  | 7  | 0  | 0  | 9  | 2  | 2  | 0  | 15 | 2  | 0  |
| 2070 | 0  | 7  | 0  | 0  | 9  | 2  | 2  | 0  | 15 | 2  | 0  |
| 2071 | 0  | 7  | 0  | 0  | 9  | 2  | 2  | 0  | 15 | 2  | 0  |
| 2072 | 0  | 7  | 0  | 0  | 9  | 2  | 2  | 0  | 15 | 2  | 0  |
| 2073 | 0  | 7  | 0  | 0  | 9  | 2  | 2  | 0  | 15 | 2  | 0  |
| 2074 | 0  | 7  | 0  | 0  | 9  | 2  | 2  | 0  | 15 | 2  | 0  |
| 2075 | 0  | 7  | 0  | 0  | 9  | 2  | 2  | 0  | 15 | 2  | 0  |
| 2076 | 0  | 7  | 0  | 0  | 9  | 2  | 2  | 0  | 15 | 2  | 0  |
| 2077 | 0  | 7  | 0  | 0  | 9  | 2  | 2  | 0  | 15 | 2  | 0  |
| 2078 | 0  | 7  | 0  | 0  | 9  | 2  | 2  | 0  | 15 | 2  | 0  |
| 2079 | 0  | 7  | 0  | 0  | 9  | 2  | 2  | 0  | 15 | 2  | 0  |
| 2080 | 0  | 7  | 0  | 0  | 9  | 2  | 2  | 0  | 15 | 2  | 0  |
| 2081 | 0  | 7  | 0  | 0  | 9  | 2  | 2  | 0  | 15 | 2  | 0  |
| 2082 | 0  | 7  | 0  | 0  | 9  | 2  | 2  | 0  | 15 | 2  | 0  |
| 2083 | 0  | 7  | 0  | 0  | 9  | 2  | 2  | 0  | 15 | 2  | 0  |
| 2084 | 0  | 7  | 0  | 0  | 9  | 2  | 2  | 0  | 15 | 2  | 0  |
| 2085 | 0  | 7  | 0  | 0  | 9  | 2  | 2  | 0  | 15 | 2  | 0  |
| 2086 | 0  | 7  | 0  | 0  | 9  | 2  | 2  | 0  | 15 | 2  | 0  |
| 2087 | 0  | 7  | 0  | 0  | 9  | 2  | 2  | 0  | 15 | 2  | 0  |
| 2088 | 0  | 7  | 0  | 0  | 9  | 2  | 2  | 0  | 15 | 2  | 0  |
| 2089 | 0  | 7  | 0  | 0  | 9  | 2  | 2  | 0  | 15 | 2  | 0  |
| 2090 | 0  | 7  | 0  | 0  | 9  | 2  | 2  | 0  | 15 | 2  | 0  |

|      | 56 | 57 | 58 | 59 | 60 | 61 | 62 | 63 | 64 | 65 | 66 |
|------|----|----|----|----|----|----|----|----|----|----|----|
| 2002 | 0  | 0  | 0  | 0  | 0  | 0  | 0  | 0  | 0  | 0  | 0  |
| 2003 | 0  | 0  | 0  | 0  | 0  | 0  | 0  | 0  | 0  | 0  | 0  |
| 2004 | 0  | 0  | 0  | 0  | 0  | 0  | 0  | 0  | 0  | 0  | 0  |
| 2005 | 0  | 0  | 0  | 0  | 0  | 0  | 0  | 0  | 0  | 0  | 0  |
| 2006 | 0  | 0  | 0  | 0  | 0  | 0  | 0  | 0  | 0  | 0  | 0  |
| 2007 | 0  | 0  | 0  | 0  | 0  | 0  | 0  | 0  | 0  | 0  | 0  |
| 2008 | 0  | 0  | 0  | 0  | 0  | 0  | 0  | 0  | 0  | 0  | 0  |
| 2009 | 0  | 0  | 0  | 0  | 0  | 0  | 0  | 0  | 0  | 0  | 0  |
| 2010 | 0  | 0  | 0  | 0  | 0  | 0  | 0  | 0  | 0  | 0  | 0  |
| 2011 | 0  | 0  | 0  | 0  | 0  | 0  | 0  | 0  | 0  | 0  | 0  |
| 2012 | 0  | 0  | 0  | 0  | 0  | 0  | 0  | 0  | 0  | 0  | 0  |
| 2013 | 0  | 0  | 0  | 0  | 0  | 0  | 0  | 0  | 0  | 0  | 0  |
| 2014 | 0  | 0  | 0  | 0  | 0  | 0  | 0  | 0  | 0  | 0  | 0  |
| 2015 | 0  | 0  | 0  | 0  | 0  | 0  | 0  | 0  | 0  | 0  | 0  |
| 2016 | 0  | 0  | 0  | 0  | 0  | 0  | 0  | 0  | 0  | 0  | 0  |
| 2017 | 0  | 0  | 0  | 0  | 0  | 0  | 0  | 0  | 0  | 0  | 0  |
| 2018 | 0  | 0  | 0  | 0  | 0  | 0  | 0  | 0  | 0  | 0  | 0  |
| 2019 | 0  | 0  | 0  | 0  | 0  | 0  | 0  | 0  | 0  | 0  | 0  |
| 2020 | 0  | 0  | 0  | 0  | 0  | 0  | 0  | 0  | 0  | 0  | 0  |
| 2021 | 0  | 0  | 0  | 0  | 0  | 0  | 0  | 0  | 0  | 0  | 0  |
| 2022 | 0  | 0  | 0  | 0  | 0  | 0  | 0  | 0  | 0  | 0  | 0  |
| 2023 | 0  | 0  | 0  | 0  | 0  | 0  | 0  | 0  | 0  | 0  | 0  |
| 2024 | 0  | 0  | 0  | 0  | 0  | 0  | 0  | 0  | 0  | 0  | 0  |
| 2025 | 0  | 0  | 0  | 0  | 0  | 0  | 0  | 0  | 0  | 0  | 0  |
| 2026 | 0  | 0  | 0  | 0  | 0  | 0  | 0  | 0  | 0  | 0  | 0  |
| 2027 | 0  | 0  | 0  | 0  | 0  | 0  | 0  | 0  | 0  | 0  | 0  |
| 2028 | 0  | 0  | 0  | 0  | 0  | 0  | 0  | 0  | 0  | 0  | 0  |
| 2029 | 0  | 0  | 0  | 0  | 0  | 0  | 0  | 0  | 0  | 0  | 0  |
| 2030 | 0  | 0  | 0  | 0  | 0  | 0  | 0  | 0  | 0  | 0  | 0  |
| 2031 | 0  | 0  | 0  | 0  | 0  | 0  | 0  | 0  | 0  | 0  | 0  |
| 2032 | 0  | 0  | 0  | 0  | 0  | 0  | 0  | 0  | 0  | 0  | 0  |
| 2033 | 0  | 0  | 0  | 0  | 0  | 0  | 0  | 0  | 0  | 0  | 0  |
| 2034 | 0  | 0  | 0  | 0  | 0  | 0  | 0  | 0  | 0  | 0  | 0  |
| 2035 | 0  | 0  | 0  | 0  | 0  | 0  | 0  | 0  | 0  | 0  | 0  |
| 2036 | 0  | 0  | 0  | 0  | 0  | 0  | 0  | 0  | 0  | 0  | 0  |
| 2037 | 0  | 0  | 0  | 0  | 0  | 0  | 0  | 0  | 0  | 0  | 0  |
| 2038 | 0  | 0  | 0  | 0  | 0  | 0  | 0  | 0  | 0  | 0  | 0  |
| 2039 | 0  | 0  | 0  | 0  | 0  | 0  | 0  | 0  | 0  | 0  | 0  |
| 2040 | 0  | 0  | 0  | 0  | 0  | 0  | 0  | 0  | 0  | 0  | 0  |
| 2041 | 0  | 0  | 0  | 0  | 0  | 0  | 0  | 0  | 0  | 0  | 0  |
| 2042 | 0  | 0  | 0  | 0  | 0  | 0  | 0  | 0  | 0  | 0  | 0  |
| 2043 | 0  | 0  | 0  | 0  | 0  | 0  | 0  | 0  | 0  | 0  | 0  |
| 2044 | 0  | 0  | 0  | 0  | 0  | 0  | 0  | 0  | 0  | 0  | 0  |
| 2045 | 0  | 0  | 0  | 0  | 0  | 0  | 0  | 0  | 0  | 0  | 0  |
| 2046 | 0  | 0  | 0  | 0  | 0  | 0  | 0  | 0  | 0  | 0  | 0  |
| 2047 | 0  | 0  | 0  | 0  | 0  | 0  | 0  | 0  | 0  | 0  | 0  |
| 2048 | 0  | 0  | 0  | 0  | 0  | 0  | 0  | 0  | 0  | 0  | 0  |
| 2049 | 0  | 0  | 0  | 0  | 0  | 0  | 0  | 0  | 0  | 0  | 0  |
| 2050 | 0  | 0  | 0  | 0  | 0  | 0  | 0  | 0  | 0  | 0  | 0  |
| 2051 | 0  | 0  | 0  | 0  | 0  | 0  | 0  | 0  | 0  | 0  | 0  |
| 2052 | 0  | 0  | 0  | 0  | 0  | 0  | 0  | 0  | 0  | 0  | 0  |
| 2053 | 0  | 0  | 0  | 0  | 0  | 0  | 0  | 0  | 0  | 0  | 0  |
| 2054 | 0  | 0  | 0  | 0  | 0  | 0  | 0  | 0  | 0  | 0  | 0  |
| 2055 | 0  | 0  | 0  | 0  | 0  | 0  | 0  | 0  | 0  | 0  | 0  |
| 2056 | 0  | 0  | 0  | 0  | 0  | 0  | 0  | 0  | 0  | 0  | 0  |
| 2057 | 0  | 0  | 0  | 0  | 0  | 0  | 0  | 0  | 0  | 0  | 0  |
| 2058 | 0  | 0  | 0  | 0  | 0  | 0  | 0  | 0  | 0  | 0  | 0  |
| 2059 | 0  | 0  | 0  | 0  | 0  | 0  | 0  | 0  | 0  | 0  | 0  |

|      | 56 | 57 | 58 | 59 | 60 | 61 | 62 | 63 | 64 | 65 | 66 |
|------|----|----|----|----|----|----|----|----|----|----|----|
| 2060 | 0  | 0  | 0  | 0  | 0  | 0  | 0  | 0  | 0  | 0  | 0  |
| 2061 | 0  | 0  | 0  | 0  | 0  | 0  | 0  | 0  | 0  | 0  | 0  |
| 2062 | 0  | 0  | 0  | 0  | 0  | 0  | 0  | 0  | 0  | 0  | 0  |
| 2063 | 0  | 0  | 0  | 0  | 0  | 0  | 0  | 0  | 0  | 0  | 0  |
| 2064 | 0  | 0  | 0  | 0  | 0  | 0  | 0  | 0  | 0  | 0  | 0  |
| 2065 | 0  | 0  | 0  | 0  | 0  | 0  | 0  | 0  | 0  | 0  | 0  |
| 2066 | 0  | 0  | 0  | 0  | 0  | 0  | 0  | 0  | 0  | 0  | 0  |
| 2067 | 0  | 0  | 0  | 0  | 0  | 0  | 0  | 0  | 0  | 0  | 0  |
| 2068 | 0  | 0  | 0  | 0  | 0  | 0  | 0  | 0  | 0  | 0  | 0  |
| 2069 | 0  | 0  | 0  | 0  | 0  | 0  | 0  | 0  | 0  | 0  | 0  |
| 2070 | 0  | 0  | 0  | 0  | 0  | 0  | 0  | 0  | 0  | 0  | 0  |
| 2071 | 0  | 0  | 0  | 0  | 0  | 0  | 0  | 0  | 0  | 0  | 0  |
| 2072 | 0  | 0  | 0  | 0  | 0  | 0  | 0  | 0  | 0  | 0  | 0  |
| 2073 | 0  | 0  | 0  | 0  | 0  | 0  | 0  | 0  | 0  | 0  | 0  |
| 2074 | 0  | 0  | 0  | 0  | 0  | 0  | 0  | 0  | 0  | 0  | 0  |
| 2075 | 0  | 0  | 0  | 0  | 0  | 0  | 0  | 0  | 0  | 0  | 0  |
| 2076 | 0  | 0  | 0  | 0  | 0  | 0  | 0  | 0  | 0  | 0  | 0  |
| 2077 | 0  | 0  | 0  | 0  | 0  | 0  | 0  | 0  | 0  | 0  | 0  |
| 2078 | 0  | 0  | 0  | 0  | 0  | 0  | 0  | 0  | 0  | 0  | 0  |
| 2079 | 0  | 0  | 0  | 0  | 0  | 0  | 0  | 0  | 0  | 0  | 0  |
| 2080 | 0  | 0  | 0  | 0  | 0  | 0  | 0  | 0  | 0  | 0  | 0  |
| 2081 | 0  | 0  | 0  | 0  | 0  | 0  | 0  | 0  | 0  | 0  | 0  |
| 2082 | 0  | 0  | 0  | 0  | 0  | 0  | 0  | 0  | 0  | 0  | 0  |
| 2083 | 0  | 0  | 0  | 0  | 0  | 0  | 0  | 0  | 0  | 0  | 0  |
| 2084 | 0  | 0  | 0  | 0  | 0  | 0  | 0  | 0  | 0  | 0  | 0  |
| 2085 | 0  | 0  | 0  | 0  | 0  | 0  | 0  | 0  | 0  | 0  | 0  |
| 2086 | 0  | 0  | 0  | 0  | 0  | 0  | 0  | 0  | 0  | 0  | 0  |
| 2087 | 0  | 0  | 0  | 0  | 0  | 0  | 0  | 0  | 0  | 0  | 0  |
| 2088 | 0  | 0  | 0  | 0  | 0  | 0  | 0  | 0  | 0  | 0  | 0  |
| 2089 | 0  | 0  | 0  | 0  | 0  | 0  | 0  | 0  | 0  | 0  | 0  |
| 2090 | 0  | 0  | 0  | 0  | 0  | 0  | 0  | 0  | 0  | 0  | 0  |

|      | 67 | 68 | 69 | 70 | 71 | 72 | 73 | 74 | 75 | 76 | 77 |
|------|----|----|----|----|----|----|----|----|----|----|----|
| 2002 | 0  | 0  | 0  | 0  | 0  | 0  | 0  | 0  | 0  | 0  | 0  |
| 2003 | 0  | 0  | 0  | 0  | 0  | 0  | 0  | 0  | 0  | 0  | 0  |
| 2004 | 0  | 0  | 0  | 0  | 0  | 0  | 0  | 0  | 0  | 0  | 0  |
| 2005 | 0  | 0  | 0  | 0  | 0  | 0  | 0  | 0  | 0  | 0  | 0  |
| 2006 | 0  | 0  | 0  | 0  | 0  | 0  | 0  | 0  | 0  | 0  | 0  |
| 2007 | 0  | 0  | 0  | 0  | 0  | 0  | 0  | 0  | 0  | 0  | 0  |
| 2008 | 0  | 0  | 0  | 0  | 0  | 0  | 0  | 0  | 0  | 0  | 0  |
| 2009 | 0  | 0  | 0  | 0  | 0  | 0  | 0  | 0  | 0  | 0  | 0  |
| 2010 | 0  | 0  | 0  | 0  | 0  | 0  | 0  | 0  | 0  | 0  | 0  |
| 2011 | 0  | 0  | 0  | 0  | 0  | 0  | 0  | 0  | 0  | 0  | 0  |
| 2012 | 0  | 0  | 0  | 0  | 0  | 0  | 0  | 0  | 0  | 0  | 0  |
| 2013 | 0  | 0  | 0  | 0  | 0  | 0  | 0  | 0  | 0  | 0  | 0  |
| 2014 | 0  | 0  | 0  | 0  | 0  | 0  | 0  | 0  | 0  | 0  | 0  |
| 2015 | 0  | 0  | 0  | 0  | 0  | 0  | 0  | 0  | 0  | 0  | 0  |
| 2016 | 0  | 0  | 0  | 0  | 0  | 0  | 0  | 0  | 0  | 0  | 0  |
| 2017 | 0  | 0  | 0  | 0  | 0  | 0  | 0  | 0  | 0  | 0  | 0  |
| 2018 | 0  | 0  | 0  | 0  | 0  | 0  | 0  | 0  | 0  | 0  | 0  |
| 2019 | 0  | 0  | 0  | 0  | 0  | 0  | 0  | 0  | 0  | 0  | 0  |
| 2020 | 0  | 0  | 0  | 0  | 0  | 0  | 0  | 0  | 0  | 0  | 0  |
| 2021 | 0  | 0  | 0  | 0  | 0  | 0  | 0  | 0  | 0  | 0  | 0  |
| 2022 | 0  | 0  | 0  | 0  | 0  | 0  | 0  | 0  | 0  | 4  | 0  |
| 2023 | 4  | 0  | 0  | 0  | 0  | 0  | 0  | 0  | 0  | 6  | 0  |
| 2024 | 4  | 0  | 0  | 0  | 0  | 0  | 0  | 0  | 0  | 10 | 0  |
| 2025 | 4  | 0  | 0  | 0  | 0  | 0  | 0  | 0  | 0  | 10 | 0  |
| 2026 | 4  | 0  | 0  | 0  | 0  | 0  | 0  | 0  | 0  | 14 | 0  |
| 2027 | 4  | 0  | 0  | 0  | 1  | 0  | 1  | 0  | 0  | 15 | 0  |
| 2028 | 4  | 0  | 0  | 0  | 3  | 0  | 6  | 0  | 0  | 17 | 2  |
| 2029 | 4  | 0  | 0  | 0  | 5  | 0  | 6  | 0  | 0  | 17 | 2  |
| 2030 | 4  | 0  | 0  | 0  | 9  | 0  | 6  | 0  | 0  | 17 | 2  |
| 2031 | 4  | 0  | 0  | 0  | 13 | 0  | 8  | 0  | 0  | 17 | 2  |
| 2032 | 4  | 0  | 0  | 0  | 14 | 0  | 9  | 0  | 0  | 17 | 2  |
| 2033 | 4  | 0  | 0  | 0  | 16 | 0  | 11 | 0  | 0  | 17 | 2  |
| 2034 | 4  | 0  | 0  | 0  | 16 | 0  | 11 | 0  | 0  | 17 | 2  |
| 2035 | 4  | 0  | 0  | 0  | 21 | 0  | 11 | 0  | 0  | 17 | 2  |
| 2036 | 4  | 0  | 0  | 0  | 21 | 0  | 11 | 0  | 0  | 17 | 2  |
| 2037 | 4  | 0  | 0  | 0  | 21 | 0  | 11 | 0  | 0  | 17 | 2  |
| 2038 | 4  | 0  | 0  | 0  | 21 | 0  | 11 | 0  | 0  | 17 | 2  |
| 2039 | 4  | 0  | 0  | 0  | 21 | 0  | 11 | 0  | 0  | 17 | 2  |
| 2040 | 4  | 0  | 0  | 0  | 21 | 0  | 11 | 0  | 0  | 17 | 2  |
| 2041 | 4  | 0  | 0  | 0  | 21 | 0  | 11 | 0  | 0  | 17 | 2  |
| 2042 | 4  | 0  | 0  | 0  | 21 | 0  | 11 | 0  | 0  | 17 | 2  |
| 2043 | 4  | 0  | 0  | 0  | 21 | 0  | 11 | 0  | 0  | 17 | 2  |
| 2044 | 4  | 0  | 0  | 0  | 21 | 0  | 11 | 0  | 0  | 17 | 2  |
| 2045 | 4  | 0  | 0  | 0  | 21 | 0  | 11 | 0  | 0  | 17 | 2  |
| 2046 | 4  | 0  | 0  | 0  | 21 | 0  | 11 | 0  | 0  | 17 | 2  |
| 2047 | 4  | 0  | 0  | 0  | 21 | 0  | 11 | 0  | 0  | 17 | 2  |
| 2048 | 4  | 0  | 0  | 0  | 21 | 0  | 11 | 0  | 0  | 17 | 2  |
| 2049 | 4  | 0  | 0  | 0  | 21 | 0  | 11 | 0  | 0  | 17 | 2  |
| 2050 | 4  | 0  | 0  | 0  | 21 | 0  | 11 | 0  | 0  | 17 | 2  |
| 2051 | 4  | 0  | 0  | 0  | 21 | 0  | 11 | 0  | 0  | 17 | 2  |
| 2052 | 4  | 0  | 0  | 0  | 21 | 0  | 11 | 0  | 0  | 17 | 2  |
| 2053 | 4  | 0  | 0  | 0  | 21 | 0  | 11 | 0  | 0  | 17 | 2  |
| 2054 | 4  | 0  | 0  | 0  | 21 | 0  | 11 | 0  | 0  | 17 | 2  |
| 2055 | 4  | 0  | 0  | 0  | 21 | 0  | 11 | 0  | 0  | 17 | 2  |
| 2056 | 4  | 0  | 0  | 0  | 21 | 0  | 11 | 0  | 0  | 17 | 2  |
| 2057 | 4  | 0  | 0  | 0  | 21 | 0  | 11 | 0  | 0  | 17 | 2  |
| 2058 | 4  | 0  | 0  | 0  | 21 | 0  | 11 | 0  | 0  | 17 | 2  |
| 2059 | 4  | 0  | 0  | 0  | 21 | 0  | 11 | 0  | 0  | 17 | 2  |

|      | 67 | 68 | 69 | 70 | 71 | 72 | 73 | 74 | 75 | 76 | 77 |
|------|----|----|----|----|----|----|----|----|----|----|----|
| 2060 | 4  | 0  | 0  | 0  | 21 | 0  | 11 | 0  | 0  | 17 | 2  |
| 2061 | 4  | 0  | 0  | 0  | 21 | 0  | 11 | 0  | 0  | 17 | 2  |
| 2062 | 4  | 0  | 0  | 0  | 21 | 0  | 11 | 0  | 0  | 17 | 2  |
| 2063 | 4  | 0  | 0  | 0  | 21 | 0  | 11 | 0  | 0  | 17 | 2  |
| 2064 | 4  | 0  | 0  | 0  | 21 | 0  | 11 | 0  | 0  | 17 | 2  |
| 2065 | 4  | 0  | 0  | 0  | 21 | 0  | 11 | 0  | 0  | 17 | 2  |
| 2066 | 4  | 0  | 0  | 0  | 21 | 0  | 11 | 0  | 0  | 17 | 2  |
| 2067 | 4  | 0  | 0  | 0  | 21 | 0  | 11 | 0  | 0  | 17 | 2  |
| 2068 | 4  | 0  | 0  | 0  | 21 | 0  | 11 | 0  | 0  | 17 | 2  |
| 2069 | 4  | 0  | 0  | 0  | 21 | 0  | 11 | 0  | 0  | 17 | 2  |
| 2070 | 4  | 0  | 0  | 0  | 21 | 0  | 11 | 0  | 0  | 17 | 2  |
| 2071 | 4  | 0  | 0  | 0  | 21 | 0  | 11 | 0  | 0  | 17 | 2  |
| 2072 | 4  | 0  | 0  | 0  | 21 | 0  | 11 | 0  | 0  | 17 | 2  |
| 2073 | 4  | 0  | 0  | 0  | 21 | 0  | 11 | 0  | 0  | 17 | 2  |
| 2074 | 4  | 0  | 0  | 0  | 21 | 0  | 11 | 0  | 0  | 17 | 2  |
| 2075 | 4  | 0  | 0  | 0  | 21 | 0  | 11 | 0  | 0  | 17 | 2  |
| 2076 | 4  | 0  | 0  | 0  | 21 | 0  | 11 | 0  | 0  | 17 | 2  |
| 2077 | 4  | 0  | 0  | 0  | 21 | 0  | 11 | 0  | 0  | 17 | 2  |
| 2078 | 4  | 0  | 0  | 0  | 21 | 0  | 11 | 0  | 0  | 17 | 2  |
| 2079 | 4  | 0  | 0  | 0  | 21 | 0  | 11 | 0  | 0  | 17 | 2  |
| 2080 | 4  | 0  | 0  | 0  | 21 | 0  | 11 | 0  | 0  | 17 | 2  |
| 2081 | 4  | 0  | 0  | 0  | 21 | 0  | 11 | 0  | 0  | 17 | 2  |
| 2082 | 4  | 0  | 0  | 0  | 21 | 0  | 11 | 0  | 0  | 17 | 2  |
| 2083 | 4  | 0  | 0  | 0  | 21 | 0  | 11 | 0  | 0  | 17 | 2  |
| 2084 | 4  | 0  | 0  | 0  | 21 | 0  | 11 | 0  | 0  | 17 | 2  |
| 2085 | 4  | 0  | 0  | 0  | 21 | 0  | 11 | 0  | 0  | 17 | 2  |
| 2086 | 4  | 0  | 0  | 0  | 21 | 0  | 11 | 0  | 0  | 17 | 2  |
| 2087 | 4  | 0  | 0  | 0  | 21 | 0  | 11 | 0  | 0  | 17 | 2  |
| 2088 | 4  | 0  | 0  | 0  | 21 | 0  | 11 | 0  | 0  | 17 | 2  |
| 2089 | 4  | 0  | 0  | 0  | 21 | 0  | 11 | 0  | 0  | 17 | 2  |
| 2090 | 4  | 0  | 0  | 0  | 21 | 0  | 11 | 0  | 0  | 17 | 2  |

|      | 78 | 79 | 80 | 81 | 82 | 83 | 84 | 85 | 86 | 87 | 88 |
|------|----|----|----|----|----|----|----|----|----|----|----|
| 2002 | 0  | 0  | 0  | 0  | 0  | 0  | 0  | 0  | 0  | 0  | 0  |
| 2003 | 0  | 0  | 0  | 0  | 0  | 0  | 0  | 0  | 0  | 0  | 0  |
| 2004 | 0  | 0  | 0  | 0  | 0  | 0  | 0  | 0  | 0  | 0  | 0  |
| 2005 | 0  | 0  | 0  | 0  | 0  | 0  | 0  | 0  | 0  | 0  | 0  |
| 2006 | 0  | 0  | 0  | 0  | 0  | 0  | 0  | 0  | 0  | 0  | 0  |
| 2007 | 0  | 0  | 0  | 0  | 0  | 0  | 0  | 0  | 0  | 0  | 0  |
| 2008 | 0  | 0  | 0  | 0  | 0  | 0  | 0  | 0  | 0  | 0  | 0  |
| 2009 | 0  | 0  | 0  | 0  | 0  | 0  | 0  | 0  | 0  | 0  | 0  |
| 2010 | 0  | 0  | 0  | 0  | 0  | 0  | 0  | 0  | 0  | 0  | 0  |
| 2011 | 0  | 0  | 0  | 0  | 0  | 0  | 0  | 0  | 0  | 0  | 0  |
| 2012 | 0  | 0  | 0  | 0  | 0  | 0  | 0  | 0  | 0  | 0  | 0  |
| 2013 | 0  | 0  | 0  | 0  | 0  | 0  | 0  | 0  | 0  | 0  | 0  |
| 2014 | 0  | 0  | 0  | 0  | 0  | 0  | 0  | 0  | 0  | 0  | 0  |
| 2015 | 0  | 0  | 0  | 0  | 0  | 0  | 0  | 0  | 0  | 0  | 0  |
| 2016 | 0  | 0  | 0  | 0  | 0  | 0  | 0  | 0  | 0  | 0  | 0  |
| 2017 | 0  | 0  | 0  | 0  | 0  | 0  | 0  | 0  | 0  | 0  | 0  |
| 2018 | 0  | 0  | 0  | 0  | 0  | 0  | 0  | 0  | 0  | 0  | 0  |
| 2019 | 0  | 0  | 0  | 0  | 0  | 0  | 0  | 0  | 0  | 0  | 0  |
| 2020 | 0  | 0  | 0  | 0  | 0  | 0  | 0  | 0  | 0  | 0  | 0  |
| 2021 | 0  | 0  | 0  | 0  | 0  | 0  | 0  | 0  | 0  | 0  | 0  |
| 2022 | 0  | 0  | 0  | 0  | 0  | 0  | 0  | 0  | 0  | 0  | 0  |
| 2023 | 0  | 0  | 0  | 0  | 0  | 0  | 0  | 0  | 0  | 0  | 0  |
| 2024 | 0  | 0  | 0  | 0  | 0  | 0  | 0  | 0  | 0  | 0  | 0  |
| 2025 | 0  | 0  | 0  | 0  | 0  | 0  | 0  | 0  | 0  | 0  | 0  |
| 2026 | 0  | 0  | 0  | 0  | 0  | 0  | 0  | 0  | 0  | 0  | 0  |
| 2027 | 0  | 0  | 0  | 0  | 0  | 0  | 0  | 0  | 0  | 0  | 0  |
| 2028 | 1  | 0  | 0  | 2  | 0  | 0  | 0  | 0  | 0  | 0  | 0  |
| 2029 | 1  | 0  | 3  | 2  | 0  | 0  | 0  | 0  | 0  | 0  | 0  |
| 2030 | 1  | 0  | 12 | 2  | 0  | 0  | 0  | 0  | 0  | 0  | 0  |
| 2031 | 1  | 0  | 44 | 2  | 0  | 0  | 0  | 0  | 0  | 0  | 0  |
| 2032 | 1  | 0  | 50 | 2  | 0  | 0  | 0  | 0  | 0  | 0  | 0  |
| 2033 | 1  | 0  | 55 | 2  | 0  | 0  | 0  | 0  | 0  | 0  | 0  |
| 2034 | 1  | 0  | 63 | 2  | 0  | 0  | 0  | 0  | 0  | 0  | 0  |
| 2035 | 1  | 0  | 68 | 2  | 0  | 0  | 0  | 0  | 0  | 0  | 0  |
| 2036 | 1  | 0  | 69 | 2  | 0  | 0  | 0  | 0  | 0  | 0  | 0  |
| 2037 | 1  | 0  | 69 | 2  | 0  | 0  | 0  | 0  | 0  | 0  | 0  |
| 2038 | 1  | 0  | 73 | 2  | 0  | 0  | 0  | 0  | 0  | 0  | 0  |
| 2039 | 1  | 0  | 74 | 2  | 0  | 0  | 0  | 0  | 0  | 0  | 0  |
| 2040 | 1  | 0  | 76 | 2  | 0  | 0  | 0  | 0  | 0  | 0  | 0  |
| 2041 | 1  | 0  | 76 | 2  | 0  | 0  | 0  | 0  | 0  | 0  | 0  |
| 2042 | 1  | 0  | 76 | 2  | 0  | 0  | 0  | 0  | 0  | 0  | 0  |
| 2043 | 1  | 0  | 76 | 2  | 0  | 0  | 0  | 0  | 0  | 0  | 0  |
| 2044 | 1  | 0  | 76 | 2  | 0  | 0  | 0  | 0  | 0  | 0  | 0  |
| 2045 | 1  | 0  | 76 | 2  | 0  | 0  | 0  | 0  | 0  | 0  | 0  |
| 2046 | 1  | 0  | 76 | 2  | 0  | 0  | 0  | 0  | 0  | 0  | 0  |
| 2047 | 1  | 0  | 76 | 2  | 0  | 0  | 0  | 0  | 0  | 0  | 0  |
| 2048 | 1  | 0  | 76 | 2  | 0  | 0  | 0  | 0  | 0  | 0  | 0  |
| 2049 | 1  | 0  | 76 | 2  | 0  | 0  | 0  | 0  | 0  | 0  | 0  |
| 2050 | 1  | 0  | 76 | 2  | 0  | 0  | 0  | 0  | 0  | 0  | 0  |
| 2051 | 1  | 0  | 76 | 2  | 0  | 0  | 0  | 0  | 0  | 0  | 0  |
| 2052 | 1  | 0  | 76 | 2  | 0  | 0  | 0  | 0  | 0  | 0  | 0  |
| 2053 | 1  | 0  | 76 | 2  | 0  | 0  | 0  | 0  | 0  | 0  | 0  |
| 2054 | 1  | 0  | 76 | 2  | 0  | 0  | 0  | 0  | 0  | 0  | 0  |
| 2055 | 1  | 0  | 76 | 2  | 0  | 0  | 0  | 0  | 0  | 0  | 0  |
| 2056 | 1  | 0  | 76 | 2  | 0  | 0  | 0  | 0  | 0  | 0  | 0  |
| 2057 | 1  | 0  | 76 | 2  | 0  | 0  | 0  | 0  | 0  | 0  | 0  |
| 2058 | 1  | 0  | 76 | 2  | 0  | 0  | 0  | 0  | 0  | 0  | 0  |
| 2059 | 1  | 0  | 76 | 2  | 0  | 0  | 0  | 0  | 0  | 0  | 0  |

|      | 78 | 79 | 80 | 81 | 82 | 83 | 84 | 85 | 86 | 87 | 88 |
|------|----|----|----|----|----|----|----|----|----|----|----|
| 2060 | 1  | 0  | 76 | 2  | 0  | 0  | 0  | 0  | 0  | 0  | 0  |
| 2061 | 1  | 0  | 76 | 2  | 0  | 0  | 0  | 0  | 0  | 0  | 0  |
| 2062 | 1  | 0  | 76 | 2  | 0  | 0  | 0  | 0  | 0  | 0  | 0  |
| 2063 | 1  | 0  | 76 | 2  | 0  | 0  | 0  | 0  | 0  | 0  | 0  |
| 2064 | 1  | 0  | 76 | 2  | 0  | 0  | 0  | 0  | 0  | 0  | 0  |
| 2065 | 1  | 0  | 76 | 2  | 0  | 0  | 0  | 0  | 0  | 0  | 0  |
| 2066 | 1  | 0  | 76 | 2  | 0  | 0  | 0  | 0  | 0  | 0  | 0  |
| 2067 | 1  | 0  | 76 | 2  | 0  | 0  | 0  | 0  | 0  | 0  | 0  |
| 2068 | 1  | 0  | 76 | 2  | 0  | 0  | 0  | 0  | 0  | 0  | 0  |
| 2069 | 1  | 0  | 76 | 2  | 0  | 0  | 0  | 0  | 0  | 0  | 0  |
| 2070 | 1  | 0  | 76 | 2  | 0  | 0  | 0  | 0  | 0  | 0  | 0  |
| 2071 | 1  | 0  | 76 | 2  | 0  | 0  | 0  | 0  | 0  | 0  | 0  |
| 2072 | 1  | 0  | 76 | 2  | 0  | 0  | 0  | 0  | 0  | 0  | 0  |
| 2073 | 1  | 0  | 76 | 2  | 0  | 0  | 0  | 0  | 0  | 0  | 0  |
| 2074 | 1  | 0  | 76 | 2  | 0  | 0  | 0  | 0  | 0  | 0  | 0  |
| 2075 | 1  | 0  | 76 | 2  | 0  | 0  | 0  | 0  | 0  | 0  | 0  |
| 2076 | 1  | 0  | 76 | 2  | 0  | 0  | 0  | 0  | 0  | 0  | 0  |
| 2077 | 1  | 0  | 76 | 2  | 0  | 0  | 0  | 0  | 0  | 0  | 0  |
| 2078 | 1  | 0  | 76 | 2  | 0  | 0  | 0  | 0  | 0  | 0  | 0  |
| 2079 | 1  | 0  | 76 | 2  | 0  | 0  | 0  | 0  | 0  | 0  | 0  |
| 2080 | 1  | 0  | 76 | 2  | 0  | 0  | 0  | 0  | 0  | 0  | 0  |
| 2081 | 1  | 0  | 76 | 2  | 0  | 0  | 0  | 0  | 0  | 0  | 0  |
| 2082 | 1  | 0  | 76 | 2  | 0  | 0  | 0  | 0  | 0  | 0  | 0  |
| 2083 | 1  | 0  | 76 | 2  | 0  | 0  | 0  | 0  | 0  | 0  | 0  |
| 2084 | 1  | 0  | 76 | 2  | 0  | 0  | 0  | 0  | 0  | 0  | 0  |
| 2085 | 1  | 0  | 76 | 2  | 0  | 0  | 0  | 0  | 0  | 0  | 0  |
| 2086 | 1  | 0  | 76 | 2  | 0  | 0  | 0  | 0  | 0  | 0  | 0  |
| 2087 | 1  | 0  | 76 | 2  | 0  | 0  | 0  | 0  | 0  | 0  | 0  |
| 2088 | 1  | 0  | 76 | 2  | 0  | 0  | 0  | 0  | 0  | 0  | 0  |
| 2089 | 1  | 0  | 76 | 2  | 0  | 0  | 0  | 0  | 0  | 0  | 0  |
| 2090 | 1  | 0  | 76 | 2  | 0  | 0  | 0  | 0  | 0  | 0  | 0  |



|      | 89 | 90 | 91 | 92 | 93 | 94 | 95 | 96 | 97 | 98 | 99 |
|------|----|----|----|----|----|----|----|----|----|----|----|
| 2002 | 0  | 0  | 0  | 0  | 0  | 0  | 0  | 0  | 0  | 0  | 0  |
| 2003 | 0  | 0  | 0  | 0  | 0  | 0  | 0  | 0  | 0  | 0  | 0  |
| 2004 | 0  | 0  | 0  | 0  | 0  | 0  | 0  | 0  | 0  | 0  | 0  |
| 2005 | 0  | 0  | 0  | 0  | 0  | 0  | 0  | 0  | 0  | 0  | 0  |
| 2006 | 0  | 0  | 0  | 0  | 0  | 0  | 0  | 0  | 0  | 0  | 0  |
| 2007 | 0  | 0  | 0  | 0  | 0  | 0  | 0  | 0  | 0  | 0  | 0  |
| 2008 | 0  | 0  | 0  | 0  | 0  | 0  | 0  | 0  | 0  | 0  | 0  |
| 2009 | 0  | 0  | 0  | 0  | 0  | 0  | 0  | 0  | 0  | 0  | 0  |
| 2010 | 0  | 0  | 0  | 0  | 0  | 0  | 0  | 0  | 0  | 0  | 0  |
| 2011 | 0  | 0  | 0  | 0  | 0  | 0  | 0  | 0  | 0  | 0  | 0  |
| 2012 | 0  | 0  | 0  | 0  | 0  | 0  | 0  | 0  | 0  | 0  | 0  |
| 2013 | 0  | 0  | 0  | 0  | 0  | 0  | 0  | 0  | 0  | 0  | 0  |
| 2014 | 0  | 0  | 0  | 0  | 0  | 0  | 0  | 0  | 0  | 0  | 0  |
| 2015 | 0  | 0  | 0  | 0  | 0  | 0  | 0  | 0  | 0  | 0  | 0  |
| 2016 | 0  | 0  | 0  | 0  | 0  | 0  | 0  | 0  | 0  | 0  | 0  |
| 2017 | 0  | 0  | 0  | 0  | 0  | 0  | 0  | 0  | 0  | 0  | 0  |
| 2018 | 0  | 0  | 0  | 0  | 0  | 0  | 0  | 0  | 0  | 0  | 0  |
| 2019 | 0  | 0  | 0  | 0  | 0  | 0  | 0  | 0  | 0  | 0  | 0  |
| 2020 | 0  | 0  | 0  | 0  | 0  | 0  | 0  | 0  | 0  | 0  | 0  |
| 2021 | 0  | 0  | 0  | 0  | 0  | 0  | 0  | 0  | 0  | 0  | 0  |
| 2022 | 0  | 0  | 0  | 0  | 0  | 0  | 0  | 0  | 0  | 0  | 0  |
| 2023 | 0  | 0  | 0  | 0  | 0  | 3  | 0  | 0  | 0  | 0  | 0  |
| 2024 | 0  | 0  | 0  | 0  | 0  | 3  | 0  | 0  | 0  | 0  | 0  |
| 2025 | 0  | 0  | 0  | 0  | 0  | 3  | 0  | 0  | 0  | 0  | 0  |
| 2026 | 0  | 0  | 0  | 0  | 0  | 3  | 0  | 0  | 0  | 0  | 0  |
| 2027 | 0  | 0  | 0  | 0  | 0  | 3  | 0  | 0  | 0  | 4  | 0  |
| 2028 | 0  | 0  | 0  | 0  | 0  | 3  | 0  | 0  | 0  | 4  | 0  |
| 2029 | 0  | 0  | 0  | 0  | 0  | 3  | 0  | 0  | 0  | 6  | 0  |
| 2030 | 0  | 0  | 0  | 0  | 0  | 3  | 0  | 0  | 0  | 14 | 0  |
| 2031 | 0  | 0  | 0  | 0  | 0  | 3  | 0  | 0  | 0  | 16 | 0  |
| 2032 | 0  | 0  | 0  | 0  | 0  | 3  | 0  | 0  | 0  | 17 | 0  |
| 2033 | 0  | 0  | 0  | 0  | 0  | 3  | 0  | 0  | 0  | 19 | 0  |
| 2034 | 0  | 0  | 0  | 0  | 0  | 3  | 0  | 0  | 0  | 19 | 0  |
| 2035 | 0  | 0  | 0  | 0  | 0  | 3  | 0  | 0  | 0  | 24 | 0  |
| 2036 | 0  | 0  | 0  | 0  | 0  | 3  | 0  | 0  | 0  | 24 | 0  |
| 2037 | 0  | 0  | 0  | 0  | 0  | 3  | 0  | 0  | 0  | 24 | 0  |
| 2038 | 0  | 0  | 0  | 0  | 0  | 3  | 0  | 0  | 0  | 24 | 0  |
| 2039 | 0  | 0  | 0  | 0  | 0  | 3  | 0  | 0  | 0  | 24 | 0  |
| 2040 | 0  | 0  | 0  | 0  | 0  | 3  | 0  | 0  | 0  | 24 | 0  |
| 2041 | 0  | 0  | 0  | 0  | 0  | 3  | 0  | 0  | 0  | 24 | 0  |
| 2042 | 0  | 0  | 0  | 0  | 0  | 3  | 0  | 0  | 0  | 24 | 0  |
| 2043 | 0  | 0  | 0  | 0  | 0  | 3  | 0  | 0  | 0  | 24 | 0  |
| 2044 | 0  | 0  | 0  | 0  | 0  | 3  | 0  | 0  | 0  | 24 | 0  |
| 2045 | 0  | 0  | 0  | 0  | 0  | 3  | 0  | 0  | 0  | 24 | 0  |
| 2046 | 0  | 0  | 0  | 0  | 0  | 3  | 0  | 0  | 0  | 24 | 0  |
| 2047 | 0  | 0  | 0  | 0  | 0  | 3  | 0  | 0  | 0  | 24 | 0  |
| 2048 | 0  | 0  | 0  | 0  | 0  | 3  | 0  | 0  | 0  | 24 | 0  |
| 2049 | 0  | 0  | 0  | 0  | 0  | 3  | 0  | 0  | 0  | 24 | 0  |
| 2050 | 0  | 0  | 0  | 0  | 0  | 3  | 0  | 0  | 0  | 24 | 0  |
| 2051 | 0  | 0  | 0  | 0  | 0  | 3  | 0  | 0  | 0  | 24 | 0  |
| 2052 | 0  | 0  | 0  | 0  | 0  | 3  | 0  | 0  | 0  | 24 | 0  |
| 2053 | 0  | 0  | 0  | 0  | 0  | 3  | 0  | 0  | 0  | 24 | 0  |
| 2054 | 0  | 0  | 0  | 0  | 0  | 3  | 0  | 0  | 0  | 24 | 0  |
| 2055 | 0  | 0  | 0  | 0  | 0  | 3  | 0  | 0  | 0  | 24 | 0  |
| 2056 | 0  | 0  | 0  | 0  | 0  | 3  | 0  | 0  | 0  | 24 | 0  |
| 2057 | 0  | 0  | 0  | 0  | 0  | 3  | 0  | 0  | 0  | 24 | 0  |
| 2058 | 0  | 0  | 0  | 0  | 0  | 3  | 0  | 0  | 0  | 24 | 0  |
| 2059 | 0  | 0  | 0  | 0  | 0  | 3  | 0  | 0  | 0  | 24 | 0  |

|      | 89 | 90 | 91 | 92 | 93 | 94 | 95 | 96 | 97 | 98 | 99 |
|------|----|----|----|----|----|----|----|----|----|----|----|
| 2060 | 0  | 0  | 0  | 0  | 0  | 3  | 0  | 0  | 0  | 24 | 0  |
| 2061 | 0  | 0  | 0  | 0  | 0  | 3  | 0  | 0  | 0  | 24 | 0  |
| 2062 | 0  | 0  | 0  | 0  | 0  | 3  | 0  | 0  | 0  | 24 | 0  |
| 2063 | 0  | 0  | 0  | 0  | 0  | 3  | 0  | 0  | 0  | 24 | 0  |
| 2064 | 0  | 0  | 0  | 0  | 0  | 3  | 0  | 0  | 0  | 24 | 0  |
| 2065 | 0  | 0  | 0  | 0  | 0  | 3  | 0  | 0  | 0  | 24 | 0  |
| 2066 | 0  | 0  | 0  | 0  | 0  | 3  | 0  | 0  | 0  | 24 | 0  |
| 2067 | 0  | 0  | 0  | 0  | 0  | 3  | 0  | 0  | 0  | 24 | 0  |
| 2068 | 0  | 0  | 0  | 0  | 0  | 3  | 0  | 0  | 0  | 24 | 0  |
| 2069 | 0  | 0  | 0  | 0  | 0  | 3  | 0  | 0  | 0  | 24 | 0  |
| 2070 | 0  | 0  | 0  | 0  | 0  | 3  | 0  | 0  | 0  | 24 | 0  |
| 2071 | 0  | 0  | 0  | 0  | 0  | 3  | 0  | 0  | 0  | 24 | 0  |
| 2072 | 0  | 0  | 0  | 0  | 0  | 3  | 0  | 0  | 0  | 24 | 0  |
| 2073 | 0  | 0  | 0  | 0  | 0  | 3  | 0  | 0  | 0  | 24 | 0  |
| 2074 | 0  | 0  | 0  | 0  | 0  | 3  | 0  | 0  | 0  | 24 | 0  |
| 2075 | 0  | 0  | 0  | 0  | 0  | 3  | 0  | 0  | 0  | 24 | 0  |
| 2076 | 0  | 0  | 0  | 0  | 0  | 3  | 0  | 0  | 0  | 24 | 0  |
| 2077 | 0  | 0  | 0  | 0  | 0  | 3  | 0  | 0  | 0  | 24 | 0  |
| 2078 | 0  | 0  | 0  | 0  | 0  | 3  | 0  | 0  | 0  | 24 | 0  |
| 2079 | 0  | 0  | 0  | 0  | 0  | 3  | 0  | 0  | 0  | 24 | 0  |
| 2080 | 0  | 0  | 0  | 0  | 0  | 3  | 0  | 0  | 0  | 24 | 0  |
| 2081 | 0  | 0  | 0  | 0  | 0  | 3  | 0  | 0  | 0  | 24 | 0  |
| 2082 | 0  | 0  | 0  | 0  | 0  | 3  | 0  | 0  | 0  | 24 | 0  |
| 2083 | 0  | 0  | 0  | 0  | 0  | 3  | 0  | 0  | 0  | 24 | 0  |
| 2084 | 0  | 0  | 0  | 0  | 0  | 3  | 0  | 0  | 0  | 24 | 0  |
| 2085 | 0  | 0  | 0  | 0  | 0  | 3  | 0  | 0  | 0  | 24 | 0  |
| 2086 | 0  | 0  | 0  | 0  | 0  | 3  | 0  | 0  | 0  | 24 | 0  |
| 2087 | 0  | 0  | 0  | 0  | 0  | 3  | 0  | 0  | 0  | 24 | 0  |
| 2088 | 0  | 0  | 0  | 0  | 0  | 3  | 0  | 0  | 0  | 24 | 0  |
| 2089 | 0  | 0  | 0  | 0  | 0  | 3  | 0  | 0  | 0  | 24 | 0  |
| 2090 | 0  | 0  | 0  | 0  | 0  | 3  | 0  | 0  | 0  | 24 | 0  |

|      | 100 | 101 | 102 | 103 | 104 | 105 | 106 | 107 | 108 | 109 | 110 |
|------|-----|-----|-----|-----|-----|-----|-----|-----|-----|-----|-----|
| 2002 | 0   | 0   | 0   | 0   | 0   | 0   | 0   | 0   | 0   | 0   | 0   |
| 2003 | 0   | 0   | 0   | 0   | 0   | 0   | 0   | 0   | 0   | 0   | 0   |
| 2004 | 0   | 0   | 0   | 0   | 0   | 0   | 0   | 0   | 0   | 0   | 0   |
| 2005 | 0   | 0   | 0   | 0   | 0   | 0   | 0   | 0   | 0   | 0   | 0   |
| 2006 | 0   | 0   | 0   | 0   | 0   | 0   | 0   | 0   | 0   | 0   | 0   |
| 2007 | 0   | 0   | 0   | 0   | 0   | 0   | 0   | 0   | 0   | 0   | 0   |
| 2008 | 0   | 0   | 0   | 0   | 0   | 0   | 0   | 0   | 0   | 0   | 0   |
| 2009 | 0   | 0   | 0   | 0   | 0   | 0   | 0   | 0   | 0   | 0   | 0   |
| 2010 | 0   | 0   | 0   | 0   | 0   | 0   | 0   | 0   | 0   | 0   | 0   |
| 2011 | 0   | 0   | 0   | 0   | 0   | 0   | 0   | 0   | 0   | 0   | 0   |
| 2012 | 0   | 0   | 0   | 0   | 0   | 0   | 0   | 0   | 0   | 0   | 0   |
| 2013 | 0   | 0   | 0   | 0   | 0   | 0   | 0   | 0   | 0   | 0   | 0   |
| 2014 | 0   | 0   | 0   | 0   | 0   | 0   | 0   | 0   | 0   | 0   | 0   |
| 2015 | 0   | 0   | 0   | 0   | 0   | 0   | 0   | 0   | 0   | 0   | 0   |
| 2016 | 0   | 0   | 0   | 0   | 0   | 0   | 0   | 0   | 0   | 0   | 0   |
| 2017 | 0   | 0   | 0   | 0   | 0   | 0   | 0   | 0   | 0   | 0   | 0   |
| 2018 | 0   | 0   | 0   | 0   | 0   | 0   | 0   | 0   | 0   | 0   | 0   |
| 2019 | 0   | 0   | 0   | 0   | 0   | 0   | 0   | 0   | 0   | 0   | 0   |
| 2020 | 0   | 0   | 0   | 0   | 0   | 0   | 0   | 0   | 0   | 0   | 0   |
| 2021 | 0   | 0   | 0   | 0   | 0   | 0   | 0   | 0   | 0   | 0   | 0   |
| 2022 | 0   | 0   | 0   | 2   | 0   | 0   | 0   | 0   | 0   | 0   | 0   |
| 2023 | 0   | 0   | 0   | 4   | 0   | 0   | 0   | 0   | 0   | 0   | 0   |
| 2024 | 0   | 0   | 0   | 8   | 0   | 0   | 0   | 0   | 0   | 0   | 0   |
| 2025 | 0   | 0   | 0   | 8   | 0   | 0   | 0   | 0   | 0   | 0   | 0   |
| 2026 | 0   | 0   | 0   | 12  | 0   | 0   | 0   | 0   | 0   | 0   | 0   |
| 2027 | 0   | 0   | 0   | 13  | 0   | 0   | 0   | 0   | 0   | 0   | 0   |
| 2028 | 5   | 0   | 0   | 15  | 2   | 0   | 0   | 3   | 2   | 0   | 0   |
| 2029 | 5   | 0   | 0   | 15  | 2   | 0   | 0   | 7   | 2   | 0   | 0   |
| 2030 | 5   | 0   | 0   | 15  | 2   | 0   | 0   | 21  | 2   | 0   | 0   |
| 2031 | 7   | 0   | 0   | 15  | 2   | 0   | 0   | 51  | 2   | 0   | 0   |
| 2032 | 8   | 0   | 0   | 15  | 2   | 0   | 0   | 55  | 2   | 0   | 0   |
| 2033 | 10  | 0   | 0   | 15  | 2   | 0   | 0   | 60  | 2   | 0   | 0   |
| 2034 | 10  | 0   | 0   | 15  | 2   | 0   | 0   | 66  | 2   | 0   | 0   |
| 2035 | 10  | 0   | 0   | 15  | 2   | 0   | 0   | 71  | 2   | 0   | 0   |
| 2036 | 10  | 0   | 0   | 15  | 2   | 0   | 0   | 72  | 2   | 0   | 0   |
| 2037 | 10  | 0   | 0   | 15  | 2   | 0   | 0   | 72  | 2   | 0   | 0   |
| 2038 | 10  | 0   | 0   | 15  | 2   | 0   | 0   | 76  | 2   | 0   | 0   |
| 2039 | 10  | 0   | 0   | 15  | 2   | 0   | 0   | 77  | 2   | 0   | 0   |
| 2040 | 10  | 0   | 0   | 15  | 2   | 0   | 0   | 79  | 2   | 0   | 0   |
| 2041 | 10  | 0   | 0   | 15  | 2   | 0   | 0   | 79  | 2   | 0   | 0   |
| 2042 | 10  | 0   | 0   | 15  | 2   | 0   | 0   | 79  | 2   | 0   | 0   |
| 2043 | 10  | 0   | 0   | 15  | 2   | 0   | 0   | 79  | 2   | 0   | 0   |
| 2044 | 10  | 0   | 0   | 15  | 2   | 0   | 0   | 79  | 2   | 0   | 0   |
| 2045 | 10  | 0   | 0   | 15  | 2   | 0   | 0   | 79  | 2   | 0   | 0   |
| 2046 | 10  | 0   | 0   | 15  | 2   | 0   | 0   | 79  | 2   | 0   | 0   |
| 2047 | 10  | 0   | 0   | 15  | 2   | 0   | 0   | 79  | 2   | 0   | 0   |
| 2048 | 10  | 0   | 0   | 15  | 2   | 0   | 0   | 79  | 2   | 0   | 0   |
| 2049 | 10  | 0   | 0   | 15  | 2   | 0   | 0   | 79  | 2   | 0   | 0   |
| 2050 | 10  | 0   | 0   | 15  | 2   | 0   | 0   | 79  | 2   | 0   | 0   |
| 2051 | 10  | 0   | 0   | 15  | 2   | 0   | 0   | 79  | 2   | 0   | 0   |
| 2052 | 10  | 0   | 0   | 15  | 2   | 0   | 0   | 79  | 2   | 0   | 0   |
| 2053 | 10  | 0   | 0   | 15  | 2   | 0   | 0   | 79  | 2   | 0   | 0   |
| 2054 | 10  | 0   | 0   | 15  | 2   | 0   | 0   | 79  | 2   | 0   | 0   |
| 2055 | 10  | 0   | 0   | 15  | 2   | 0   | 0   | 79  | 2   | 0   | 0   |
| 2056 | 10  | 0   | 0   | 15  | 2   | 0   | 0   | 79  | 2   | 0   | 0   |
| 2057 | 10  | 0   | 0   | 15  | 2   | 0   | 0   | 79  | 2   | 0   | 0   |
| 2058 | 10  | 0   | 0   | 15  | 2   | 0   | 0   | 79  | 2   | 0   | 0   |
| 2059 | 10  | 0   | 0   | 15  | 2   | 0   | 0   | 79  | 2   | 0   | 0   |

|      | 100 | 101 | 102 | 103 | 104 | 105 | 106 | 107 | 108 | 109 | 110 |
|------|-----|-----|-----|-----|-----|-----|-----|-----|-----|-----|-----|
| 2060 | 10  | 0   | 0   | 15  | 2   | 0   | 0   | 79  | 2   | 0   | 0   |
| 2061 | 10  | 0   | 0   | 15  | 2   | 0   | 0   | 79  | 2   | 0   | 0   |
| 2062 | 10  | 0   | 0   | 15  | 2   | 0   | 0   | 79  | 2   | 0   | 0   |
| 2063 | 10  | 0   | 0   | 15  | 2   | 0   | 0   | 79  | 2   | 0   | 0   |
| 2064 | 10  | 0   | 0   | 15  | 2   | 0   | 0   | 79  | 2   | 0   | 0   |
| 2065 | 10  | 0   | 0   | 15  | 2   | 0   | 0   | 79  | 2   | 0   | 0   |
| 2066 | 10  | 0   | 0   | 15  | 2   | 0   | 0   | 79  | 2   | 0   | 0   |
| 2067 | 10  | 0   | 0   | 15  | 2   | 0   | 0   | 79  | 2   | 0   | 0   |
| 2068 | 10  | 0   | 0   | 15  | 2   | 0   | 0   | 79  | 2   | 0   | 0   |
| 2069 | 10  | 0   | 0   | 15  | 2   | 0   | 0   | 79  | 2   | 0   | 0   |
| 2070 | 10  | 0   | 0   | 15  | 2   | 0   | 0   | 79  | 2   | 0   | 0   |
| 2071 | 10  | 0   | 0   | 15  | 2   | 0   | 0   | 79  | 2   | 0   | 0   |
| 2072 | 10  | 0   | 0   | 15  | 2   | 0   | 0   | 79  | 2   | 0   | 0   |
| 2073 | 10  | 0   | 0   | 15  | 2   | 0   | 0   | 79  | 2   | 0   | 0   |
| 2074 | 10  | 0   | 0   | 15  | 2   | 0   | 0   | 79  | 2   | 0   | 0   |
| 2075 | 10  | 0   | 0   | 15  | 2   | 0   | 0   | 79  | 2   | 0   | 0   |
| 2076 | 10  | 0   | 0   | 15  | 2   | 0   | 0   | 79  | 2   | 0   | 0   |
| 2077 | 10  | 0   | 0   | 15  | 2   | 0   | 0   | 79  | 2   | 0   | 0   |
| 2078 | 10  | 0   | 0   | 15  | 2   | 0   | 0   | 79  | 2   | 0   | 0   |
| 2079 | 10  | 0   | 0   | 15  | 2   | 0   | 0   | 79  | 2   | 0   | 0   |
| 2080 | 10  | 0   | 0   | 15  | 2   | 0   | 0   | 79  | 2   | 0   | 0   |
| 2081 | 10  | 0   | 0   | 15  | 2   | 0   | 0   | 79  | 2   | 0   | 0   |
| 2082 | 10  | 0   | 0   | 15  | 2   | 0   | 0   | 79  | 2   | 0   | 0   |
| 2083 | 10  | 0   | 0   | 15  | 2   | 0   | 0   | 79  | 2   | 0   | 0   |
| 2084 | 10  | 0   | 0   | 15  | 2   | 0   | 0   | 79  | 2   | 0   | 0   |
| 2085 | 10  | 0   | 0   | 15  | 2   | 0   | 0   | 79  | 2   | 0   | 0   |
| 2086 | 10  | 0   | 0   | 15  | 2   | 0   | 0   | 79  | 2   | 0   | 0   |
| 2087 | 10  | 0   | 0   | 15  | 2   | 0   | 0   | 79  | 2   | 0   | 0   |
| 2088 | 10  | 0   | 0   | 15  | 2   | 0   | 0   | 79  | 2   | 0   | 0   |
| 2089 | 10  | 0   | 0   | 15  | 2   | 0   | 0   | 79  | 2   | 0   | 0   |
| 2090 | 10  | 0   | 0   | 15  | 2   | 0   | 0   | 79  | 2   | 0   | 0   |

|      | 111 | 112 | 113 | 114 | 115 | 116 | 117 | 118 | 119 | 120 | 121 |
|------|-----|-----|-----|-----|-----|-----|-----|-----|-----|-----|-----|
| 2002 | 0   | 0   | 0   | 0   | 0   | 0   | 0   | 0   | 0   | 0   | 0   |
| 2003 | 0   | 0   | 0   | 0   | 0   | 0   | 0   | 0   | 0   | 0   | 0   |
| 2004 | 0   | 0   | 0   | 0   | 0   | 0   | 0   | 0   | 0   | 0   | 0   |
| 2005 | 0   | 0   | 0   | 0   | 0   | 0   | 0   | 0   | 0   | 0   | 0   |
| 2006 | 0   | 0   | 0   | 0   | 0   | 0   | 0   | 0   | 0   | 0   | 0   |
| 2007 | 0   | 0   | 0   | 0   | 0   | 0   | 0   | 0   | 0   | 0   | 0   |
| 2008 | 0   | 0   | 0   | 0   | 0   | 0   | 0   | 0   | 0   | 0   | 0   |
| 2009 | 0   | 0   | 0   | 0   | 0   | 0   | 0   | 0   | 0   | 0   | 0   |
| 2010 | 0   | 0   | 0   | 0   | 0   | 0   | 0   | 0   | 0   | 0   | 0   |
| 2011 | 0   | 0   | 0   | 0   | 0   | 0   | 0   | 0   | 0   | 0   | 0   |
| 2012 | 0   | 0   | 0   | 0   | 0   | 0   | 0   | 0   | 0   | 0   | 0   |
| 2013 | 0   | 0   | 0   | 0   | 0   | 0   | 0   | 0   | 0   | 0   | 0   |
| 2014 | 0   | 0   | 0   | 0   | 0   | 0   | 0   | 0   | 0   | 0   | 0   |
| 2015 | 0   | 0   | 0   | 0   | 0   | 0   | 0   | 0   | 0   | 0   | 0   |
| 2016 | 0   | 0   | 0   | 0   | 0   | 0   | 0   | 0   | 0   | 0   | 0   |
| 2017 | 0   | 0   | 0   | 0   | 0   | 0   | 0   | 0   | 0   | 0   | 0   |
| 2018 | 0   | 0   | 0   | 0   | 0   | 0   | 0   | 0   | 0   | 0   | 0   |
| 2019 | 0   | 0   | 0   | 0   | 0   | 0   | 0   | 0   | 0   | 0   | 0   |
| 2020 | 0   | 0   | 0   | 0   | 0   | 0   | 0   | 0   | 0   | 0   | 0   |
| 2021 | 0   | 0   | 0   | 0   | 0   | 0   | 0   | 0   | 0   | 0   | 0   |
| 2022 | 0   | 0   | 0   | 0   | 0   | 0   | 0   | 0   | 0   | 0   | 0   |
| 2023 | 0   | 0   | 0   | 0   | 0   | 0   | 0   | 0   | 0   | 0   | 0   |
| 2024 | 0   | 0   | 0   | 0   | 0   | 0   | 0   | 0   | 0   | 0   | 0   |
| 2025 | 0   | 0   | 0   | 0   | 0   | 0   | 0   | 0   | 0   | 0   | 0   |
| 2026 | 0   | 0   | 0   | 0   | 0   | 0   | 0   | 0   | 0   | 0   | 0   |
| 2027 | 0   | 0   | 0   | 0   | 0   | 0   | 0   | 0   | 0   | 0   | 0   |
| 2028 | 0   | 0   | 0   | 0   | 0   | 0   | 0   | 0   | 0   | 0   | 0   |
| 2029 | 0   | 0   | 0   | 0   | 0   | 0   | 0   | 0   | 0   | 0   | 0   |
| 2030 | 0   | 0   | 0   | 0   | 0   | 0   | 0   | 0   | 0   | 0   | 0   |
| 2031 | 0   | 0   | 0   | 0   | 0   | 0   | 0   | 0   | 0   | 0   | 0   |
| 2032 | 0   | 0   | 0   | 0   | 0   | 0   | 0   | 0   | 0   | 0   | 0   |
| 2033 | 0   | 0   | 0   | 0   | 0   | 0   | 0   | 0   | 0   | 0   | 0   |
| 2034 | 0   | 0   | 0   | 0   | 0   | 0   | 0   | 0   | 0   | 0   | 0   |
| 2035 | 0   | 0   | 0   | 0   | 0   | 0   | 0   | 0   | 0   | 0   | 0   |
| 2036 | 0   | 0   | 0   | 0   | 0   | 0   | 0   | 0   | 0   | 0   | 0   |
| 2037 | 0   | 0   | 0   | 0   | 0   | 0   | 0   | 0   | 0   | 0   | 0   |
| 2038 | 0   | 0   | 0   | 0   | 0   | 0   | 0   | 0   | 0   | 0   | 0   |
| 2039 | 0   | 0   | 0   | 0   | 0   | 0   | 0   | 0   | 0   | 0   | 0   |
| 2040 | 0   | 0   | 0   | 0   | 0   | 0   | 0   | 0   | 0   | 0   | 0   |
| 2041 | 0   | 0   | 0   | 0   | 0   | 0   | 0   | 0   | 0   | 0   | 0   |
| 2042 | 0   | 0   | 0   | 0   | 0   | 0   | 0   | 0   | 0   | 0   | 0   |
| 2043 | 0   | 0   | 0   | 0   | 0   | 0   | 0   | 0   | 0   | 0   | 0   |
| 2044 | 0   | 0   | 0   | 0   | 0   | 0   | 0   | 0   | 0   | 0   | 0   |
| 2045 | 0   | 0   | 0   | 0   | 0   | 0   | 0   | 0   | 0   | 0   | 0   |
| 2046 | 0   | 0   | 0   | 0   | 0   | 0   | 0   | 0   | 0   | 0   | 0   |
| 2047 | 0   | 0   | 0   | 0   | 0   | 0   | 0   | 0   | 0   | 0   | 0   |
| 2048 | 0   | 0   | 0   | 0   | 0   | 0   | 0   | 0   | 0   | 0   | 0   |
| 2049 | 0   | 0   | 0   | 0   | 0   | 0   | 0   | 0   | 0   | 0   | 0   |
| 2050 | 0   | 0   | 0   | 0   | 0   | 0   | 0   | 0   | 0   | 0   | 0   |
| 2051 | 0   | 0   | 0   | 0   | 0   | 0   | 0   | 0   | 0   | 0   | 0   |
| 2052 | 0   | 0   | 0   | 0   | 0   | 0   | 0   | 0   | 0   | 0   | 0   |
| 2053 | 0   | 0   | 0   | 0   | 0   | 0   | 0   | 0   | 0   | 0   | 0   |
| 2054 | 0   | 0   | 0   | 0   | 0   | 0   | 0   | 0   | 0   | 0   | 0   |
| 2055 | 0   | 0   | 0   | 0   | 0   | 0   | 0   | 0   | 0   | 0   | 0   |
| 2056 | 0   | 0   | 0   | 0   | 0   | 0   | 0   | 0   | 0   | 0   | 0   |
| 2057 | 0   | 0   | 0   | 0   | 0   | 0   | 0   | 0   | 0   | 0   | 0   |
| 2058 | 0   | 0   | 0   | 0   | 0   | 0   | 0   | 0   | 0   | 0   | 0   |
| 2059 | 0   | 0   | 0   | 0   | 0   | 0   | 0   | 0   | 0   | 0   | 0   |

|      | 111 | 112 | 113 | 114 | 115 | 116 | 117 | 118 | 119 | 120 | 121 |
|------|-----|-----|-----|-----|-----|-----|-----|-----|-----|-----|-----|
| 2060 | 0   | 0   | 0   | 0   | 0   | 0   | 0   | 0   | 0   | 0   | 0   |
| 2061 | 0   | 0   | 0   | 0   | 0   | 0   | 0   | 0   | 0   | 0   | 0   |
| 2062 | 0   | 0   | 0   | 0   | 0   | 0   | 0   | 0   | 0   | 0   | 0   |
| 2063 | 0   | 0   | 0   | 0   | 0   | 0   | 0   | 0   | 0   | 0   | 0   |
| 2064 | 0   | 0   | 0   | 0   | 0   | 0   | 0   | 0   | 0   | 0   | 0   |
| 2065 | 0   | 0   | 0   | 0   | 0   | 0   | 0   | 0   | 0   | 0   | 0   |
| 2066 | 0   | 0   | 0   | 0   | 0   | 0   | 0   | 0   | 0   | 0   | 0   |
| 2067 | 0   | 0   | 0   | 0   | 0   | 0   | 0   | 0   | 0   | 0   | 0   |
| 2068 | 0   | 0   | 0   | 0   | 0   | 0   | 0   | 0   | 0   | 0   | 0   |
| 2069 | 0   | 0   | 0   | 0   | 0   | 0   | 0   | 0   | 0   | 0   | 0   |
| 2070 | 0   | 0   | 0   | 0   | 0   | 0   | 0   | 0   | 0   | 0   | 0   |
| 2071 | 0   | 0   | 0   | 0   | 0   | 0   | 0   | 0   | 0   | 0   | 0   |
| 2072 | 0   | 0   | 0   | 0   | 0   | 0   | 0   | 0   | 0   | 0   | 0   |
| 2073 | 0   | 0   | 0   | 0   | 0   | 0   | 0   | 0   | 0   | 0   | 0   |
| 2074 | 0   | 0   | 0   | 0   | 0   | 0   | 0   | 0   | 0   | 0   | 0   |
| 2075 | 0   | 0   | 0   | 0   | 0   | 0   | 0   | 0   | 0   | 0   | 0   |
| 2076 | 0   | 0   | 0   | 0   | 0   | 0   | 0   | 0   | 0   | 0   | 0   |
| 2077 | 0   | 0   | 0   | 0   | 0   | 0   | 0   | 0   | 0   | 0   | 0   |
| 2078 | 0   | 0   | 0   | 0   | 0   | 0   | 0   | 0   | 0   | 0   | 0   |
| 2079 | 0   | 0   | 0   | 0   | 0   | 0   | 0   | 0   | 0   | 0   | 0   |
| 2080 | 0   | 0   | 0   | 0   | 0   | 0   | 0   | 0   | 0   | 0   | 0   |
| 2081 | 0   | 0   | 0   | 0   | 0   | 0   | 0   | 0   | 0   | 0   | 0   |
| 2082 | 0   | 0   | 0   | 0   | 0   | 0   | 0   | 0   | 0   | 0   | 0   |
| 2083 | 0   | 0   | 0   | 0   | 0   | 0   | 0   | 0   | 0   | 0   | 0   |
| 2084 | 0   | 0   | 0   | 0   | 0   | 0   | 0   | 0   | 0   | 0   | 0   |
| 2085 | 0   | 0   | 0   | 0   | 0   | 0   | 0   | 0   | 0   | 0   | 0   |
| 2086 | 0   | 0   | 0   | 0   | 0   | 0   | 0   | 0   | 0   | 0   | 0   |
| 2087 | 0   | 0   | 0   | 0   | 0   | 0   | 0   | 0   | 0   | 0   | 0   |
| 2088 | 0   | 0   | 0   | 0   | 0   | 0   | 0   | 0   | 0   | 0   | 0   |
| 2089 | 0   | 0   | 0   | 0   | 0   | 0   | 0   | 0   | 0   | 0   | 0   |
| 2090 | 0   | 0   | 0   | 0   | 0   | 0   | 0   | 0   | 0   | 0   | 0   |

|      | 122 | 123 | 124 | 125 | 126 | 127 | 128 | 129 | 130 | 131 | 132 |
|------|-----|-----|-----|-----|-----|-----|-----|-----|-----|-----|-----|
| 2002 | 0   | 0   | 0   | 0   | 0   | 0   | 0   | 0   | 0   | 0   | 0   |
| 2003 | 0   | 0   | 0   | 0   | 0   | 0   | 0   | 0   | 0   | 0   | 0   |
| 2004 | 0   | 0   | 0   | 0   | 0   | 0   | 0   | 0   | 0   | 0   | 0   |
| 2005 | 0   | 0   | 0   | 0   | 0   | 0   | 0   | 0   | 0   | 0   | 0   |
| 2006 | 0   | 0   | 0   | 0   | 0   | 0   | 0   | 0   | 0   | 0   | 0   |
| 2007 | 0   | 0   | 0   | 0   | 0   | 0   | 0   | 0   | 0   | 0   | 0   |
| 2008 | 0   | 0   | 0   | 0   | 0   | 0   | 0   | 0   | 0   | 0   | 0   |
| 2009 | 0   | 0   | 0   | 0   | 0   | 0   | 0   | 0   | 0   | 0   | 0   |
| 2010 | 0   | 0   | 0   | 0   | 0   | 0   | 0   | 0   | 0   | 0   | 0   |
| 2011 | 0   | 0   | 0   | 0   | 0   | 0   | 0   | 0   | 0   | 0   | 0   |
| 2012 | 0   | 0   | 0   | 0   | 0   | 0   | 0   | 0   | 0   | 0   | 0   |
| 2013 | 0   | 0   | 0   | 0   | 0   | 0   | 0   | 0   | 0   | 0   | 0   |
| 2014 | 0   | 0   | 0   | 0   | 0   | 0   | 0   | 0   | 0   | 0   | 0   |
| 2015 | 0   | 0   | 0   | 0   | 0   | 0   | 0   | 0   | 0   | 0   | 0   |
| 2016 | 0   | 0   | 0   | 0   | 0   | 0   | 0   | 0   | 0   | 0   | 0   |
| 2017 | 0   | 0   | 0   | 0   | 0   | 0   | 0   | 0   | 0   | 0   | 0   |
| 2018 | 0   | 0   | 0   | 0   | 0   | 0   | 0   | 0   | 0   | 0   | 0   |
| 2019 | 0   | 0   | 0   | 0   | 0   | 0   | 0   | 0   | 0   | 0   | 0   |
| 2020 | 0   | 0   | 0   | 0   | 0   | 0   | 0   | 0   | 0   | 0   | 0   |
| 2021 | 0   | 0   | 0   | 0   | 0   | 0   | 0   | 0   | 0   | 0   | 0   |
| 2022 | 0   | 0   | 0   | 0   | 0   | 0   | 0   | 0   | 0   | 0   | 0   |
| 2023 | 0   | 0   | 0   | 0   | 0   | 0   | 0   | 0   | 1   | 0   | 0   |
| 2024 | 0   | 0   | 0   | 0   | 0   | 0   | 0   | 0   | 2   | 0   | 0   |
| 2025 | 0   | 0   | 0   | 0   | 0   | 0   | 0   | 0   | 2   | 0   | 0   |
| 2026 | 0   | 0   | 0   | 0   | 0   | 0   | 0   | 0   | 6   | 0   | 0   |
| 2027 | 0   | 0   | 0   | 3   | 0   | 0   | 0   | 0   | 7   | 0   | 0   |
| 2028 | 0   | 0   | 0   | 3   | 0   | 2   | 0   | 0   | 9   | 2   | 2   |
| 2029 | 0   | 0   | 0   | 5   | 0   | 2   | 0   | 0   | 9   | 2   | 2   |
| 2030 | 0   | 0   | 0   | 5   | 0   | 2   | 0   | 0   | 9   | 2   | 2   |
| 2031 | 0   | 0   | 0   | 5   | 0   | 4   | 0   | 0   | 9   | 2   | 2   |
| 2032 | 0   | 0   | 0   | 6   | 0   | 5   | 0   | 0   | 9   | 2   | 2   |
| 2033 | 0   | 0   | 0   | 8   | 0   | 7   | 0   | 0   | 9   | 2   | 2   |
| 2034 | 0   | 0   | 0   | 8   | 0   | 7   | 0   | 0   | 9   | 2   | 2   |
| 2035 | 0   | 0   | 0   | 10  | 0   | 7   | 0   | 0   | 9   | 2   | 2   |
| 2036 | 0   | 0   | 0   | 10  | 0   | 7   | 0   | 0   | 9   | 2   | 2   |
| 2037 | 0   | 0   | 0   | 10  | 0   | 7   | 0   | 0   | 9   | 2   | 2   |
| 2038 | 0   | 0   | 0   | 10  | 0   | 7   | 0   | 0   | 9   | 2   | 2   |
| 2039 | 0   | 0   | 0   | 10  | 0   | 7   | 0   | 0   | 9   | 2   | 2   |
| 2040 | 0   | 0   | 0   | 10  | 0   | 7   | 0   | 0   | 9   | 2   | 2   |
| 2041 | 0   | 0   | 0   | 10  | 0   | 7   | 0   | 0   | 9   | 2   | 2   |
| 2042 | 0   | 0   | 0   | 10  | 0   | 7   | 0   | 0   | 9   | 2   | 2   |
| 2043 | 0   | 0   | 0   | 10  | 0   | 7   | 0   | 0   | 9   | 2   | 2   |
| 2044 | 0   | 0   | 0   | 10  | 0   | 7   | 0   | 0   | 9   | 2   | 2   |
| 2045 | 0   | 0   | 0   | 10  | 0   | 7   | 0   | 0   | 9   | 2   | 2   |
| 2046 | 0   | 0   | 0   | 10  | 0   | 7   | 0   | 0   | 9   | 2   | 2   |
| 2047 | 0   | 0   | 0   | 10  | 0   | 7   | 0   | 0   | 9   | 2   | 2   |
| 2048 | 0   | 0   | 0   | 10  | 0   | 7   | 0   | 0   | 9   | 2   | 2   |
| 2049 | 0   | 0   | 0   | 10  | 0   | 7   | 0   | 0   | 9   | 2   | 2   |
| 2050 | 0   | 0   | 0   | 10  | 0   | 7   | 0   | 0   | 9   | 2   | 2   |
| 2051 | 0   | 0   | 0   | 10  | 0   | 7   | 0   | 0   | 9   | 2   | 2   |
| 2052 | 0   | 0   | 0   | 10  | 0   | 7   | 0   | 0   | 9   | 2   | 2   |
| 2053 | 0   | 0   | 0   | 10  | 0   | 7   | 0   | 0   | 9   | 2   | 2   |
| 2054 | 0   | 0   | 0   | 10  | 0   | 7   | 0   | 0   | 9   | 2   | 2   |
| 2055 | 0   | 0   | 0   | 10  | 0   | 7   | 0   | 0   | 9   | 2   | 2   |
| 2056 | 0   | 0   | 0   | 10  | 0   | 7   | 0   | 0   | 9   | 2   | 2   |
| 2057 | 0   | 0   | 0   | 10  | 0   | 7   | 0   | 0   | 9   | 2   | 2   |
| 2058 | 0   | 0   | 0   | 10  | 0   | 7   | 0   | 0   | 9   | 2   | 2   |
| 2059 | 0   | 0   | 0   | 10  | 0   | 7   | 0   | 0   | 9   | 2   | 2   |

|      | 122 | 123 | 124 | 125 | 126 | 127 | 128 | 129 | 130 | 131 | 132 |
|------|-----|-----|-----|-----|-----|-----|-----|-----|-----|-----|-----|
| 2060 | 0   | 0   | 0   | 10  | 0   | 7   | 0   | 0   | 9   | 2   | 2   |
| 2061 | 0   | 0   | 0   | 10  | 0   | 7   | 0   | 0   | 9   | 2   | 2   |
| 2062 | 0   | 0   | 0   | 10  | 0   | 7   | 0   | 0   | 9   | 2   | 2   |
| 2063 | 0   | 0   | 0   | 10  | 0   | 7   | 0   | 0   | 9   | 2   | 2   |
| 2064 | 0   | 0   | 0   | 10  | 0   | 7   | 0   | 0   | 9   | 2   | 2   |
| 2065 | 0   | 0   | 0   | 10  | 0   | 7   | 0   | 0   | 9   | 2   | 2   |
| 2066 | 0   | 0   | 0   | 10  | 0   | 7   | 0   | 0   | 9   | 2   | 2   |
| 2067 | 0   | 0   | 0   | 10  | 0   | 7   | 0   | 0   | 9   | 2   | 2   |
| 2068 | 0   | 0   | 0   | 10  | 0   | 7   | 0   | 0   | 9   | 2   | 2   |
| 2069 | 0   | 0   | 0   | 10  | 0   | 7   | 0   | 0   | 9   | 2   | 2   |
| 2070 | 0   | 0   | 0   | 10  | 0   | 7   | 0   | 0   | 9   | 2   | 2   |
| 2071 | 0   | 0   | 0   | 10  | 0   | 7   | 0   | 0   | 9   | 2   | 2   |
| 2072 | 0   | 0   | 0   | 10  | 0   | 7   | 0   | 0   | 9   | 2   | 2   |
| 2073 | 0   | 0   | 0   | 10  | 0   | 7   | 0   | 0   | 9   | 2   | 2   |
| 2074 | 0   | 0   | 0   | 10  | 0   | 7   | 0   | 0   | 9   | 2   | 2   |
| 2075 | 0   | 0   | 0   | 10  | 0   | 7   | 0   | 0   | 9   | 2   | 2   |
| 2076 | 0   | 0   | 0   | 10  | 0   | 7   | 0   | 0   | 9   | 2   | 2   |
| 2077 | 0   | 0   | 0   | 10  | 0   | 7   | 0   | 0   | 9   | 2   | 2   |
| 2078 | 0   | 0   | 0   | 10  | 0   | 7   | 0   | 0   | 9   | 2   | 2   |
| 2079 | 0   | 0   | 0   | 10  | 0   | 7   | 0   | 0   | 9   | 2   | 2   |
| 2080 | 0   | 0   | 0   | 10  | 0   | 7   | 0   | 0   | 9   | 2   | 2   |
| 2081 | 0   | 0   | 0   | 10  | 0   | 7   | 0   | 0   | 9   | 2   | 2   |
| 2082 | 0   | 0   | 0   | 10  | 0   | 7   | 0   | 0   | 9   | 2   | 2   |
| 2083 | 0   | 0   | 0   | 10  | 0   | 7   | 0   | 0   | 9   | 2   | 2   |
| 2084 | 0   | 0   | 0   | 10  | 0   | 7   | 0   | 0   | 9   | 2   | 2   |
| 2085 | 0   | 0   | 0   | 10  | 0   | 7   | 0   | 0   | 9   | 2   | 2   |
| 2086 | 0   | 0   | 0   | 10  | 0   | 7   | 0   | 0   | 9   | 2   | 2   |
| 2087 | 0   | 0   | 0   | 10  | 0   | 7   | 0   | 0   | 9   | 2   | 2   |
| 2088 | 0   | 0   | 0   | 10  | 0   | 7   | 0   | 0   | 9   | 2   | 2   |
| 2089 | 0   | 0   | 0   | 10  | 0   | 7   | 0   | 0   | 9   | 2   | 2   |
| 2090 | 0   | 0   | 0   | 10  | 0   | 7   | 0   | 0   | 9   | 2   | 2   |



|      | 133 | 134 | 135 | 136 | 137 | 138 | 139 | 140 | 141 | 142 | 143 |
|------|-----|-----|-----|-----|-----|-----|-----|-----|-----|-----|-----|
| 2002 | 0   | 0   | 0   | 0   | 0   | 0   | 0   | 0   | 0   | 0   | 0   |
| 2003 | 0   | 0   | 0   | 0   | 0   | 0   | 0   | 0   | 0   | 0   | 0   |
| 2004 | 0   | 0   | 0   | 0   | 0   | 0   | 0   | 0   | 0   | 0   | 0   |
| 2005 | 0   | 0   | 0   | 0   | 0   | 0   | 0   | 0   | 0   | 0   | 0   |
| 2006 | 0   | 0   | 0   | 0   | 0   | 0   | 0   | 0   | 0   | 0   | 0   |
| 2007 | 0   | 0   | 0   | 0   | 0   | 0   | 0   | 0   | 0   | 0   | 0   |
| 2008 | 0   | 0   | 0   | 0   | 0   | 0   | 0   | 0   | 0   | 0   | 0   |
| 2009 | 0   | 0   | 0   | 0   | 0   | 0   | 0   | 0   | 0   | 0   | 0   |
| 2010 | 0   | 0   | 0   | 0   | 0   | 0   | 0   | 0   | 0   | 0   | 0   |
| 2011 | 0   | 0   | 0   | 0   | 0   | 0   | 0   | 0   | 0   | 0   | 0   |
| 2012 | 0   | 0   | 0   | 0   | 0   | 0   | 0   | 0   | 0   | 0   | 0   |
| 2013 | 0   | 0   | 0   | 0   | 0   | 0   | 0   | 0   | 0   | 0   | 0   |
| 2014 | 0   | 0   | 0   | 0   | 0   | 0   | 0   | 0   | 0   | 0   | 0   |
| 2015 | 0   | 0   | 0   | 0   | 0   | 0   | 0   | 0   | 0   | 0   | 0   |
| 2016 | 0   | 0   | 0   | 0   | 0   | 0   | 0   | 0   | 0   | 0   | 0   |
| 2017 | 0   | 0   | 0   | 0   | 0   | 0   | 0   | 0   | 0   | 0   | 0   |
| 2018 | 0   | 0   | 0   | 0   | 0   | 0   | 0   | 0   | 0   | 0   | 0   |
| 2019 | 0   | 0   | 0   | 0   | 0   | 0   | 0   | 0   | 0   | 0   | 0   |
| 2020 | 0   | 0   | 0   | 0   | 0   | 0   | 0   | 0   | 0   | 0   | 0   |
| 2021 | 0   | 0   | 0   | 0   | 0   | 0   | 0   | 0   | 0   | 0   | 0   |
| 2022 | 0   | 0   | 0   | 0   | 0   | 0   | 0   | 0   | 0   | 0   | 0   |
| 2023 | 0   | 0   | 0   | 0   | 0   | 0   | 0   | 0   | 0   | 0   | 0   |
| 2024 | 0   | 0   | 0   | 0   | 0   | 0   | 0   | 0   | 0   | 0   | 0   |
| 2025 | 0   | 0   | 0   | 0   | 0   | 0   | 0   | 0   | 0   | 0   | 0   |
| 2026 | 0   | 0   | 0   | 0   | 0   | 0   | 0   | 0   | 0   | 0   | 0   |
| 2027 | 0   | 0   | 0   | 0   | 0   | 0   | 0   | 0   | 0   | 0   | 0   |
| 2028 | 0   | 0   | 2   | 0   | 0   | 0   | 0   | 0   | 0   | 0   | 0   |
| 2029 | 0   | 1   | 2   | 0   | 0   | 0   | 0   | 0   | 0   | 0   | 0   |
| 2030 | 0   | 1   | 2   | 0   | 0   | 0   | 0   | 0   | 0   | 0   | 0   |
| 2031 | 0   | 1   | 2   | 0   | 0   | 0   | 0   | 0   | 0   | 0   | 0   |
| 2032 | 0   | 3   | 2   | 0   | 0   | 0   | 0   | 0   | 0   | 0   | 0   |
| 2033 | 0   | 3   | 2   | 0   | 0   | 0   | 0   | 0   | 0   | 0   | 0   |
| 2034 | 0   | 7   | 2   | 0   | 0   | 0   | 0   | 0   | 0   | 0   | 0   |
| 2035 | 0   | 9   | 2   | 0   | 0   | 0   | 0   | 0   | 0   | 0   | 0   |
| 2036 | 0   | 10  | 2   | 0   | 0   | 0   | 0   | 0   | 0   | 0   | 0   |
| 2037 | 0   | 10  | 2   | 0   | 0   | 0   | 0   | 0   | 0   | 0   | 0   |
| 2038 | 0   | 14  | 2   | 0   | 0   | 0   | 0   | 0   | 0   | 0   | 0   |
| 2039 | 0   | 15  | 2   | 0   | 0   | 0   | 0   | 0   | 0   | 0   | 0   |
| 2040 | 0   | 17  | 2   | 0   | 0   | 0   | 0   | 0   | 0   | 0   | 0   |
| 2041 | 0   | 17  | 2   | 0   | 0   | 0   | 0   | 0   | 0   | 0   | 0   |
| 2042 | 0   | 17  | 2   | 0   | 0   | 0   | 0   | 0   | 0   | 0   | 0   |
| 2043 | 0   | 17  | 2   | 0   | 0   | 0   | 0   | 0   | 0   | 0   | 0   |
| 2044 | 0   | 17  | 2   | 0   | 0   | 0   | 0   | 0   | 0   | 0   | 0   |
| 2045 | 0   | 17  | 2   | 0   | 0   | 0   | 0   | 0   | 0   | 0   | 0   |
| 2046 | 0   | 17  | 2   | 0   | 0   | 0   | 0   | 0   | 0   | 0   | 0   |
| 2047 | 0   | 17  | 2   | 0   | 0   | 0   | 0   | 0   | 0   | 0   | 0   |
| 2048 | 0   | 17  | 2   | 0   | 0   | 0   | 0   | 0   | 0   | 0   | 0   |
| 2049 | 0   | 17  | 2   | 0   | 0   | 0   | 0   | 0   | 0   | 0   | 0   |
| 2050 | 0   | 17  | 2   | 0   | 0   | 0   | 0   | 0   | 0   | 0   | 0   |
| 2051 | 0   | 17  | 2   | 0   | 0   | 0   | 0   | 0   | 0   | 0   | 0   |
| 2052 | 0   | 17  | 2   | 0   | 0   | 0   | 0   | 0   | 0   | 0   | 0   |
| 2053 | 0   | 17  | 2   | 0   | 0   | 0   | 0   | 0   | 0   | 0   | 0   |
| 2054 | 0   | 17  | 2   | 0   | 0   | 0   | 0   | 0   | 0   | 0   | 0   |
| 2055 | 0   | 17  | 2   | 0   | 0   | 0   | 0   | 0   | 0   | 0   | 0   |
| 2056 | 0   | 17  | 2   | 0   | 0   | 0   | 0   | 0   | 0   | 0   | 0   |
| 2057 | 0   | 17  | 2   | 0   | 0   | 0   | 0   | 0   | 0   | 0   | 0   |
| 2058 | 0   | 17  | 2   | 0   | 0   | 0   | 0   | 0   | 0   | 0   | 0   |
| 2059 | 0   | 17  | 2   | 0   | 0   | 0   | 0   | 0   | 0   | 0   | 0   |

|      | 133 | 134 | 135 | 136 | 137 | 138 | 139 | 140 | 141 | 142 | 143 |
|------|-----|-----|-----|-----|-----|-----|-----|-----|-----|-----|-----|
| 2060 | 0   | 17  | 2   | 0   | 0   | 0   | 0   | 0   | 0   | 0   | 0   |
| 2061 | 0   | 17  | 2   | 0   | 0   | 0   | 0   | 0   | 0   | 0   | 0   |
| 2062 | 0   | 17  | 2   | 0   | 0   | 0   | 0   | 0   | 0   | 0   | 0   |
| 2063 | 0   | 17  | 2   | 0   | 0   | 0   | 0   | 0   | 0   | 0   | 0   |
| 2064 | 0   | 17  | 2   | 0   | 0   | 0   | 0   | 0   | 0   | 0   | 0   |
| 2065 | 0   | 17  | 2   | 0   | 0   | 0   | 0   | 0   | 0   | 0   | 0   |
| 2066 | 0   | 17  | 2   | 0   | 0   | 0   | 0   | 0   | 0   | 0   | 0   |
| 2067 | 0   | 17  | 2   | 0   | 0   | 0   | 0   | 0   | 0   | 0   | 0   |
| 2068 | 0   | 17  | 2   | 0   | 0   | 0   | 0   | 0   | 0   | 0   | 0   |
| 2069 | 0   | 17  | 2   | 0   | 0   | 0   | 0   | 0   | 0   | 0   | 0   |
| 2070 | 0   | 17  | 2   | 0   | 0   | 0   | 0   | 0   | 0   | 0   | 0   |
| 2071 | 0   | 17  | 2   | 0   | 0   | 0   | 0   | 0   | 0   | 0   | 0   |
| 2072 | 0   | 17  | 2   | 0   | 0   | 0   | 0   | 0   | 0   | 0   | 0   |
| 2073 | 0   | 17  | 2   | 0   | 0   | 0   | 0   | 0   | 0   | 0   | 0   |
| 2074 | 0   | 17  | 2   | 0   | 0   | 0   | 0   | 0   | 0   | 0   | 0   |
| 2075 | 0   | 17  | 2   | 0   | 0   | 0   | 0   | 0   | 0   | 0   | 0   |
| 2076 | 0   | 17  | 2   | 0   | 0   | 0   | 0   | 0   | 0   | 0   | 0   |
| 2077 | 0   | 17  | 2   | 0   | 0   | 0   | 0   | 0   | 0   | 0   | 0   |
| 2078 | 0   | 17  | 2   | 0   | 0   | 0   | 0   | 0   | 0   | 0   | 0   |
| 2079 | 0   | 17  | 2   | 0   | 0   | 0   | 0   | 0   | 0   | 0   | 0   |
| 2080 | 0   | 17  | 2   | 0   | 0   | 0   | 0   | 0   | 0   | 0   | 0   |
| 2081 | 0   | 17  | 2   | 0   | 0   | 0   | 0   | 0   | 0   | 0   | 0   |
| 2082 | 0   | 17  | 2   | 0   | 0   | 0   | 0   | 0   | 0   | 0   | 0   |
| 2083 | 0   | 17  | 2   | 0   | 0   | 0   | 0   | 0   | 0   | 0   | 0   |
| 2084 | 0   | 17  | 2   | 0   | 0   | 0   | 0   | 0   | 0   | 0   | 0   |
| 2085 | 0   | 17  | 2   | 0   | 0   | 0   | 0   | 0   | 0   | 0   | 0   |
| 2086 | 0   | 17  | 2   | 0   | 0   | 0   | 0   | 0   | 0   | 0   | 0   |
| 2087 | 0   | 17  | 2   | 0   | 0   | 0   | 0   | 0   | 0   | 0   | 0   |
| 2088 | 0   | 17  | 2   | 0   | 0   | 0   | 0   | 0   | 0   | 0   | 0   |
| 2089 | 0   | 17  | 2   | 0   | 0   | 0   | 0   | 0   | 0   | 0   | 0   |
| 2090 | 0   | 17  | 2   | 0   | 0   | 0   | 0   | 0   | 0   | 0   | 0   |

|      | 144 | 145 | 146 | 147 | 148 | 149 | 150 | 151 | 152 | 153 | 154 |
|------|-----|-----|-----|-----|-----|-----|-----|-----|-----|-----|-----|
| 2002 | 0   | 0   | 0   | 0   | 0   | 0   | 0   | 0   | 0   | 0   | 0   |
| 2003 | 0   | 0   | 0   | 0   | 0   | 0   | 0   | 0   | 0   | 0   | 0   |
| 2004 | 0   | 0   | 0   | 0   | 0   | 0   | 0   | 0   | 0   | 0   | 0   |
| 2005 | 0   | 0   | 0   | 0   | 0   | 0   | 0   | 0   | 0   | 0   | 0   |
| 2006 | 0   | 0   | 0   | 0   | 0   | 0   | 0   | 0   | 0   | 0   | 0   |
| 2007 | 0   | 0   | 0   | 0   | 0   | 0   | 0   | 0   | 0   | 0   | 0   |
| 2008 | 0   | 0   | 0   | 0   | 0   | 0   | 0   | 0   | 0   | 0   | 0   |
| 2009 | 0   | 0   | 0   | 0   | 0   | 0   | 0   | 0   | 0   | 0   | 0   |
| 2010 | 0   | 0   | 0   | 0   | 0   | 0   | 0   | 0   | 0   | 0   | 0   |
| 2011 | 0   | 0   | 0   | 0   | 0   | 0   | 0   | 0   | 0   | 0   | 0   |
| 2012 | 0   | 0   | 0   | 0   | 0   | 0   | 0   | 0   | 0   | 0   | 0   |
| 2013 | 0   | 0   | 0   | 0   | 0   | 0   | 0   | 0   | 0   | 0   | 0   |
| 2014 | 0   | 0   | 0   | 0   | 0   | 0   | 0   | 0   | 0   | 0   | 0   |
| 2015 | 0   | 0   | 0   | 0   | 0   | 0   | 0   | 0   | 0   | 0   | 0   |
| 2016 | 0   | 0   | 0   | 0   | 0   | 0   | 0   | 0   | 0   | 0   | 0   |
| 2017 | 0   | 0   | 0   | 0   | 0   | 0   | 0   | 0   | 0   | 0   | 0   |
| 2018 | 0   | 0   | 0   | 0   | 0   | 0   | 0   | 0   | 0   | 0   | 0   |
| 2019 | 0   | 0   | 0   | 0   | 0   | 0   | 0   | 0   | 0   | 0   | 0   |
| 2020 | 0   | 0   | 0   | 0   | 0   | 0   | 0   | 0   | 0   | 0   | 0   |
| 2021 | 0   | 0   | 0   | 0   | 0   | 0   | 0   | 0   | 0   | 0   | 0   |
| 2022 | 0   | 0   | 0   | 0   | 0   | 0   | 0   | 0   | 0   | 0   | 0   |
| 2023 | 0   | 0   | 0   | 0   | 4   | 0   | 0   | 0   | 0   | 0   | 0   |
| 2024 | 0   | 0   | 0   | 0   | 4   | 0   | 0   | 0   | 0   | 0   | 0   |
| 2025 | 0   | 0   | 0   | 0   | 4   | 0   | 0   | 0   | 0   | 0   | 0   |
| 2026 | 0   | 0   | 0   | 0   | 4   | 0   | 0   | 0   | 0   | 0   | 0   |
| 2027 | 0   | 0   | 0   | 0   | 4   | 0   | 0   | 0   | 9   | 0   | 1   |
| 2028 | 0   | 0   | 0   | 0   | 4   | 0   | 0   | 0   | 13  | 0   | 13  |
| 2029 | 0   | 0   | 0   | 0   | 4   | 0   | 0   | 0   | 18  | 0   | 13  |
| 2030 | 0   | 0   | 0   | 0   | 4   | 0   | 0   | 0   | 32  | 0   | 13  |
| 2031 | 0   | 0   | 0   | 0   | 4   | 0   | 0   | 0   | 36  | 0   | 15  |
| 2032 | 0   | 0   | 0   | 0   | 4   | 0   | 0   | 0   | 37  | 0   | 16  |
| 2033 | 0   | 0   | 0   | 0   | 4   | 0   | 0   | 0   | 39  | 0   | 18  |
| 2034 | 0   | 0   | 0   | 0   | 4   | 0   | 0   | 0   | 39  | 0   | 18  |
| 2035 | 0   | 0   | 0   | 0   | 4   | 0   | 0   | 0   | 44  | 0   | 18  |
| 2036 | 0   | 0   | 0   | 0   | 4   | 0   | 0   | 0   | 44  | 0   | 18  |
| 2037 | 0   | 0   | 0   | 0   | 4   | 0   | 0   | 0   | 44  | 0   | 18  |
| 2038 | 0   | 0   | 0   | 0   | 4   | 0   | 0   | 0   | 44  | 0   | 18  |
| 2039 | 0   | 0   | 0   | 0   | 4   | 0   | 0   | 0   | 44  | 0   | 18  |
| 2040 | 0   | 0   | 0   | 0   | 4   | 0   | 0   | 0   | 44  | 0   | 18  |
| 2041 | 0   | 0   | 0   | 0   | 4   | 0   | 0   | 0   | 44  | 0   | 18  |
| 2042 | 0   | 0   | 0   | 0   | 4   | 0   | 0   | 0   | 44  | 0   | 18  |
| 2043 | 0   | 0   | 0   | 0   | 4   | 0   | 0   | 0   | 44  | 0   | 18  |
| 2044 | 0   | 0   | 0   | 0   | 4   | 0   | 0   | 0   | 44  | 0   | 18  |
| 2045 | 0   | 0   | 0   | 0   | 4   | 0   | 0   | 0   | 44  | 0   | 18  |
| 2046 | 0   | 0   | 0   | 0   | 4   | 0   | 0   | 0   | 44  | 0   | 18  |
| 2047 | 0   | 0   | 0   | 0   | 4   | 0   | 0   | 0   | 44  | 0   | 18  |
| 2048 | 0   | 0   | 0   | 0   | 4   | 0   | 0   | 0   | 44  | 0   | 18  |
| 2049 | 0   | 0   | 0   | 0   | 4   | 0   | 0   | 0   | 44  | 0   | 18  |
| 2050 | 0   | 0   | 0   | 0   | 4   | 0   | 0   | 0   | 44  | 0   | 18  |
| 2051 | 0   | 0   | 0   | 0   | 4   | 0   | 0   | 0   | 44  | 0   | 18  |
| 2052 | 0   | 0   | 0   | 0   | 4   | 0   | 0   | 0   | 44  | 0   | 18  |
| 2053 | 0   | 0   | 0   | 0   | 4   | 0   | 0   | 0   | 44  | 0   | 18  |
| 2054 | 0   | 0   | 0   | 0   | 4   | 0   | 0   | 0   | 44  | 0   | 18  |
| 2055 | 0   | 0   | 0   | 0   | 4   | 0   | 0   | 0   | 44  | 0   | 18  |
| 2056 | 0   | 0   | 0   | 0   | 4   | 0   | 0   | 0   | 44  | 0   | 18  |
| 2057 | 0   | 0   | 0   | 0   | 4   | 0   | 0   | 0   | 44  | 0   | 18  |
| 2058 | 0   | 0   | 0   | 0   | 4   | 0   | 0   | 0   | 44  | 0   | 18  |
| 2059 | 0   | 0   | 0   | 0   | 4   | 0   | 0   | 0   | 44  | 0   | 18  |

|      | 144 | 145 | 146 | 147 | 148 | 149 | 150 | 151 | 152 | 153 | 154 |
|------|-----|-----|-----|-----|-----|-----|-----|-----|-----|-----|-----|
| 2060 | 0   | 0   | 0   | 0   | 4   | 0   | 0   | 0   | 44  | 0   | 18  |
| 2061 | 0   | 0   | 0   | 0   | 4   | 0   | 0   | 0   | 44  | 0   | 18  |
| 2062 | 0   | 0   | 0   | 0   | 4   | 0   | 0   | 0   | 44  | 0   | 18  |
| 2063 | 0   | 0   | 0   | 0   | 4   | 0   | 0   | 0   | 44  | 0   | 18  |
| 2064 | 0   | 0   | 0   | 0   | 4   | 0   | 0   | 0   | 44  | 0   | 18  |
| 2065 | 0   | 0   | 0   | 0   | 4   | 0   | 0   | 0   | 44  | 0   | 18  |
| 2066 | 0   | 0   | 0   | 0   | 4   | 0   | 0   | 0   | 44  | 0   | 18  |
| 2067 | 0   | 0   | 0   | 0   | 4   | 0   | 0   | 0   | 44  | 0   | 18  |
| 2068 | 0   | 0   | 0   | 0   | 4   | 0   | 0   | 0   | 44  | 0   | 18  |
| 2069 | 0   | 0   | 0   | 0   | 4   | 0   | 0   | 0   | 44  | 0   | 18  |
| 2070 | 0   | 0   | 0   | 0   | 4   | 0   | 0   | 0   | 44  | 0   | 18  |
| 2071 | 0   | 0   | 0   | 0   | 4   | 0   | 0   | 0   | 44  | 0   | 18  |
| 2072 | 0   | 0   | 0   | 0   | 4   | 0   | 0   | 0   | 44  | 0   | 18  |
| 2073 | 0   | 0   | 0   | 0   | 4   | 0   | 0   | 0   | 44  | 0   | 18  |
| 2074 | 0   | 0   | 0   | 0   | 4   | 0   | 0   | 0   | 44  | 0   | 18  |
| 2075 | 0   | 0   | 0   | 0   | 4   | 0   | 0   | 0   | 44  | 0   | 18  |
| 2076 | 0   | 0   | 0   | 0   | 4   | 0   | 0   | 0   | 44  | 0   | 18  |
| 2077 | 0   | 0   | 0   | 0   | 4   | 0   | 0   | 0   | 44  | 0   | 18  |
| 2078 | 0   | 0   | 0   | 0   | 4   | 0   | 0   | 0   | 44  | 0   | 18  |
| 2079 | 0   | 0   | 0   | 0   | 4   | 0   | 0   | 0   | 44  | 0   | 18  |
| 2080 | 0   | 0   | 0   | 0   | 4   | 0   | 0   | 0   | 44  | 0   | 18  |
| 2081 | 0   | 0   | 0   | 0   | 4   | 0   | 0   | 0   | 44  | 0   | 18  |
| 2082 | 0   | 0   | 0   | 0   | 4   | 0   | 0   | 0   | 44  | 0   | 18  |
| 2083 | 0   | 0   | 0   | 0   | 4   | 0   | 0   | 0   | 44  | 0   | 18  |
| 2084 | 0   | 0   | 0   | 0   | 4   | 0   | 0   | 0   | 44  | 0   | 18  |
| 2085 | 0   | 0   | 0   | 0   | 4   | 0   | 0   | 0   | 44  | 0   | 18  |
| 2086 | 0   | 0   | 0   | 0   | 4   | 0   | 0   | 0   | 44  | 0   | 18  |
| 2087 | 0   | 0   | 0   | 0   | 4   | 0   | 0   | 0   | 44  | 0   | 18  |
| 2088 | 0   | 0   | 0   | 0   | 4   | 0   | 0   | 0   | 44  | 0   | 18  |
| 2089 | 0   | 0   | 0   | 0   | 4   | 0   | 0   | 0   | 44  | 0   | 18  |
| 2090 | 0   | 0   | 0   | 0   | 4   | 0   | 0   | 0   | 44  | 0   | 18  |

|      | 155 | 156 | 157 | 158 | 159 | 160 | 161 | 162 |
|------|-----|-----|-----|-----|-----|-----|-----|-----|
| 2002 | 0   | 0   | 0   | 0   | 0   | 0   | 0   | 0   |
| 2003 | 0   | 0   | 0   | 0   | 0   | 0   | 0   | 0   |
| 2004 | 0   | 0   | 0   | 0   | 0   | 0   | 0   | 0   |
| 2005 | 0   | 0   | 0   | 0   | 0   | 0   | 0   | 0   |
| 2006 | 0   | 0   | 0   | 0   | 0   | 0   | 0   | 0   |
| 2007 | 0   | 0   | 0   | 0   | 0   | 0   | 0   | 0   |
| 2008 | 0   | 0   | 0   | 0   | 0   | 0   | 0   | 0   |
| 2009 | 0   | 0   | 0   | 0   | 0   | 0   | 0   | 0   |
| 2010 | 0   | 0   | 0   | 0   | 0   | 0   | 0   | 0   |
| 2011 | 0   | 0   | 0   | 0   | 0   | 0   | 0   | 0   |
| 2012 | 0   | 0   | 0   | 0   | 0   | 0   | 0   | 0   |
| 2013 | 0   | 0   | 0   | 0   | 0   | 0   | 0   | 0   |
| 2014 | 0   | 0   | 0   | 0   | 0   | 0   | 0   | 0   |
| 2015 | 0   | 0   | 0   | 0   | 0   | 0   | 0   | 0   |
| 2016 | 0   | 0   | 0   | 0   | 0   | 0   | 0   | 0   |
| 2017 | 0   | 0   | 0   | 0   | 0   | 0   | 0   | 0   |
| 2018 | 0   | 0   | 0   | 0   | 0   | 0   | 0   | 0   |
| 2019 | 0   | 0   | 0   | 0   | 0   | 0   | 0   | 0   |
| 2020 | 0   | 0   | 0   | 0   | 0   | 0   | 0   | 0   |
| 2021 | 0   | 0   | 0   | 0   | 0   | 0   | 0   | 0   |
| 2022 | 0   | 0   | 9   | 0   | 0   | 0   | 0   | 0   |
| 2023 | 0   | 0   | 11  | 0   | 0   | 0   | 0   | 0   |
| 2024 | 0   | 0   | 15  | 0   | 0   | 0   | 0   | 0   |
| 2025 | 0   | 0   | 15  | 0   | 0   | 0   | 0   | 0   |
| 2026 | 0   | 0   | 19  | 0   | 0   | 0   | 0   | 0   |
| 2027 | 0   | 0   | 20  | 1   | 0   | 0   | 1   | 1   |
| 2028 | 0   | 0   | 22  | 5   | 2   | 0   | 14  | 3   |
| 2029 | 0   | 0   | 22  | 5   | 2   | 0   | 34  | 3   |
| 2030 | 0   | 0   | 22  | 5   | 2   | 0   | 58  | 3   |
| 2031 | 0   | 0   | 22  | 5   | 2   | 0   | 91  | 3   |
| 2032 | 0   | 0   | 22  | 5   | 2   | 0   | 99  | 3   |
| 2033 | 0   | 0   | 22  | 5   | 2   | 0   | 104 | 3   |
| 2034 | 0   | 0   | 22  | 5   | 2   | 0   | 112 | 3   |
| 2035 | 0   | 0   | 22  | 5   | 2   | 0   | 117 | 3   |
| 2036 | 0   | 0   | 22  | 5   | 2   | 0   | 118 | 3   |
| 2037 | 0   | 0   | 22  | 5   | 2   | 0   | 118 | 3   |
| 2038 | 0   | 0   | 22  | 5   | 2   | 0   | 122 | 3   |
| 2039 | 0   | 0   | 22  | 5   | 2   | 0   | 123 | 3   |
| 2040 | 0   | 0   | 22  | 5   | 2   | 0   | 125 | 3   |
| 2041 | 0   | 0   | 22  | 5   | 2   | 0   | 125 | 3   |
| 2042 | 0   | 0   | 22  | 5   | 2   | 0   | 125 | 3   |
| 2043 | 0   | 0   | 22  | 5   | 2   | 0   | 125 | 3   |
| 2044 | 0   | 0   | 22  | 5   | 2   | 0   | 125 | 3   |
| 2045 | 0   | 0   | 22  | 5   | 2   | 0   | 125 | 3   |
| 2046 | 0   | 0   | 22  | 5   | 2   | 0   | 125 | 3   |
| 2047 | 0   | 0   | 22  | 5   | 2   | 0   | 125 | 3   |
| 2048 | 0   | 0   | 22  | 5   | 2   | 0   | 125 | 3   |
| 2049 | 0   | 0   | 22  | 5   | 2   | 0   | 125 | 3   |
| 2050 | 0   | 0   | 22  | 5   | 2   | 0   | 125 | 3   |
| 2051 | 0   | 0   | 22  | 5   | 2   | 0   | 125 | 3   |
| 2052 | 0   | 0   | 22  | 5   | 2   | 0   | 125 | 3   |
| 2053 | 0   | 0   | 22  | 5   | 2   | 0   | 125 | 3   |
| 2054 | 0   | 0   | 22  | 5   | 2   | 0   | 125 | 3   |
| 2055 | 0   | 0   | 22  | 5   | 2   | 0   | 125 | 3   |
| 2056 | 0   | 0   | 22  | 5   | 2   | 0   | 125 | 3   |
| 2057 | 0   | 0   | 22  | 5   | 2   | 0   | 125 | 3   |
| 2058 | 0   | 0   | 22  | 5   | 2   | 0   | 125 | 3   |
| 2059 | 0   | 0   | 22  | 5   | 2   | 0   | 125 | 3   |

|      | 155 | 156 | 157 | 158 | 159 | 160 | 161 | 162 |
|------|-----|-----|-----|-----|-----|-----|-----|-----|
| 2060 | 0   | 0   | 22  | 5   | 2   | 0   | 125 | 3   |
| 2061 | 0   | 0   | 22  | 5   | 2   | 0   | 125 | 3   |
| 2062 | 0   | 0   | 22  | 5   | 2   | 0   | 125 | 3   |
| 2063 | 0   | 0   | 22  | 5   | 2   | 0   | 125 | 3   |
| 2064 | 0   | 0   | 22  | 5   | 2   | 0   | 125 | 3   |
| 2065 | 0   | 0   | 22  | 5   | 2   | 0   | 125 | 3   |
| 2066 | 0   | 0   | 22  | 5   | 2   | 0   | 125 | 3   |
| 2067 | 0   | 0   | 22  | 5   | 2   | 0   | 125 | 3   |
| 2068 | 0   | 0   | 22  | 5   | 2   | 0   | 125 | 3   |
| 2069 | 0   | 0   | 22  | 5   | 2   | 0   | 125 | 3   |
| 2070 | 0   | 0   | 22  | 5   | 2   | 0   | 125 | 3   |
| 2071 | 0   | 0   | 22  | 5   | 2   | 0   | 125 | 3   |
| 2072 | 0   | 0   | 22  | 5   | 2   | 0   | 125 | 3   |
| 2073 | 0   | 0   | 22  | 5   | 2   | 0   | 125 | 3   |
| 2074 | 0   | 0   | 22  | 5   | 2   | 0   | 125 | 3   |
| 2075 | 0   | 0   | 22  | 5   | 2   | 0   | 125 | 3   |
| 2076 | 0   | 0   | 22  | 5   | 2   | 0   | 125 | 3   |
| 2077 | 0   | 0   | 22  | 5   | 2   | 0   | 125 | 3   |
| 2078 | 0   | 0   | 22  | 5   | 2   | 0   | 125 | 3   |
| 2079 | 0   | 0   | 22  | 5   | 2   | 0   | 125 | 3   |
| 2080 | 0   | 0   | 22  | 5   | 2   | 0   | 125 | 3   |
| 2081 | 0   | 0   | 22  | 5   | 2   | 0   | 125 | 3   |
| 2082 | 0   | 0   | 22  | 5   | 2   | 0   | 125 | 3   |
| 2083 | 0   | 0   | 22  | 5   | 2   | 0   | 125 | 3   |
| 2084 | 0   | 0   | 22  | 5   | 2   | 0   | 125 | 3   |
| 2085 | 0   | 0   | 22  | 5   | 2   | 0   | 125 | 3   |
| 2086 | 0   | 0   | 22  | 5   | 2   | 0   | 125 | 3   |
| 2087 | 0   | 0   | 22  | 5   | 2   | 0   | 125 | 3   |
| 2088 | 0   | 0   | 22  | 5   | 2   | 0   | 125 | 3   |
| 2089 | 0   | 0   | 22  | 5   | 2   | 0   | 125 | 3   |
| 2090 | 0   | 0   | 22  | 5   | 2   | 0   | 125 | 3   |

|      | 1   | 2   | 3  | 4   | 5   | 6   | 7 | 8   | 9   | 10   | 11   | 12   |
|------|-----|-----|----|-----|-----|-----|---|-----|-----|------|------|------|
| 2002 | 0   | 0   | 0  | 0   | 0   | 0   | 0 | 0   | 0   | 0    | 0    | 0    |
| 2003 | 0   | 0   | 0  | 0   | 0   | 0   | 0 | 0   | 0   | 0    | 0    | 0    |
| 2004 | 0   | 0   | 0  | 0   | 0   | 0   | 0 | 0   | 0   | 0    | 0    | 0    |
| 2005 | 0   | 0   | 0  | 0   | 0   | 0   | 0 | 0   | 0   | 0    | 0    | 0    |
| 2006 | 0   | 0   | 0  | 0   | 0   | 0   | 0 | 0   | 0   | 0    | 0    | 0    |
| 2007 | 0   | 0   | 0  | 0   | 0   | 0   | 0 | 0   | 0   | 0    | 0    | 0    |
| 2008 | 0   | 0   | 0  | 0   | 0   | 0   | 0 | 0   | 0   | 0    | 0    | 0    |
| 2009 | 0   | 0   | 0  | 0   | 0   | 0   | 0 | 0   | 0   | 0    | 0    | 0    |
| 2010 | 0   | 0   | 0  | 0   | 0   | 0   | 0 | 0   | 0   | 0    | 0    | 0    |
| 2011 | 0   | 0   | 0  | 0   | 0   | 0   | 0 | 0   | 0   | 0    | 0    | 0    |
| 2012 | 0   | 0   | 0  | 0   | 0   | 0   | 0 | 0   | 0   | 0    | 0    | 0    |
| 2013 | 0   | 0   | 0  | 0   | 0   | 0   | 0 | 0   | 0   | 0    | 0    | 0    |
| 2014 | 0   | 0   | 0  | 0   | 0   | 0   | 0 | 0   | 0   | 0    | 0    | 0    |
| 2015 | 0   | 0   | 0  | 0   | 0   | 0   | 0 | 0   | 0   | 0    | 0    | 0    |
| 2016 | 0   | 0   | 0  | 0   | 0   | 0   | 0 | 0   | 0   | 0    | 0    | 0    |
| 2017 | 0   | 0   | 0  | 0   | 0   | 0   | 0 | 0   | 0   | 0    | 0    | 0    |
| 2018 | 0   | 0   | 0  | 0   | 0   | 0   | 0 | 0   | 0   | 0    | 0    | 0    |
| 2019 | 0   | 0   | 0  | 0   | 0   | 0   | 0 | 0   | 0   | 0    | 0    | 0    |
| 2020 | 0   | 0   | 0  | 0   | 0   | 0   | 0 | 0   | 0   | 0    | 0    | 0    |
| 2021 | 0   | 0   | 0  | 0   | 0   | 0   | 0 | 0   | 0   | 0    | 0    | 0    |
| 2022 | 0   | 0   | 0  | 0   | 0   | 0   | 0 | 0   | 0   | 0    | 0    | 0    |
| 2023 | 0   | 0   | 0  | 0   | 0   | 0   | 0 | 0   | 0   | 0    | 0    | 0    |
| 2024 | 0   | 0   | 0  | 0   | 0   | 0   | 0 | 0   | 0   | 0    | 0    | 0    |
| 2025 | 0   | 0   | 0  | 0   | 0   | 0   | 0 | 0   | 0   | 0    | 0    | 0    |
| 2026 | 0   | 0   | 0  | 0   | 0   | 0   | 0 | 0   | 0   | 15   | 15   | 0    |
| 2027 | 0   | 0   | 0  | 0   | 0   | 0   | 0 | 0   | 0   | 45   | 45   | 0    |
| 2028 | 0   | 0   | 0  | 0   | 0   | 0   | 0 | 0   | 0   | 130  | 130  | 0    |
| 2029 | 0   | 0   | 0  | 0   | 0   | 0   | 0 | 0   | 0   | 234  | 232  | 0    |
| 2030 | 0   | 0   | 0  | 1   | 0   | 0   | 0 | 0   | 0   | 351  | 348  | 0    |
| 2031 | 0   | 0   | 0  | 1   | 0   | 0   | 0 | 0   | 0   | 498  | 492  | 6    |
| 2032 | 0   | 0   | 0  | 1   | 0   | 0   | 0 | 0   | 0   | 602  | 595  | 28   |
| 2033 | 0   | 0   | 0  | 2   | 0   | 0   | 0 | 3   | 0   | 714  | 707  | 59   |
| 2034 | 0   | 0   | 0  | 5   | 0   | 0   | 0 | 7   | 0   | 811  | 804  | 125  |
| 2035 | 0   | 0   | 0  | 17  | 0   | 0   | 0 | 30  | 0   | 874  | 864  | 223  |
| 2036 | 1   | 1   | 0  | 32  | 1   | 1   | 1 | 59  | 1   | 987  | 978  | 371  |
| 2037 | 1   | 1   | 0  | 55  | 1   | 1   | 1 | 85  | 1   | 1060 | 1051 | 507  |
| 2038 | 3   | 4   | 0  | 79  | 5   | 3   | 2 | 152 | 4   | 1105 | 1097 | 612  |
| 2039 | 7   | 10  | 0  | 106 | 14  | 5   | 3 | 205 | 10  | 1172 | 1164 | 677  |
| 2040 | 10  | 16  | 0  | 125 | 22  | 10  | 3 | 242 | 16  | 1231 | 1224 | 783  |
| 2041 | 20  | 30  | 0  | 181 | 46  | 28  | 4 | 298 | 30  | 1290 | 1282 | 882  |
| 2042 | 35  | 45  | 0  | 208 | 65  | 48  | 4 | 396 | 45  | 1350 | 1342 | 981  |
| 2043 | 54  | 65  | 0  | 239 | 100 | 76  | 6 | 473 | 65  | 1429 | 1422 | 1058 |
| 2044 | 76  | 90  | 6  | 264 | 120 | 98  | 6 | 519 | 90  | 1473 | 1464 | 1146 |
| 2045 | 90  | 104 | 19 | 285 | 137 | 119 | 6 | 598 | 104 | 1507 | 1497 | 1199 |
| 2046 | 102 | 113 | 29 | 301 | 140 | 131 | 6 | 623 | 113 | 1564 | 1554 | 1262 |
| 2047 | 106 | 116 | 37 | 313 | 148 | 141 | 6 | 668 | 116 | 1602 | 1593 | 1337 |
| 2048 | 106 | 116 | 37 | 322 | 148 | 144 | 6 | 697 | 116 | 1652 | 1643 | 1419 |
| 2049 | 106 | 116 | 37 | 322 | 148 | 144 | 6 | 721 | 116 | 1681 | 1672 | 1462 |
| 2050 | 106 | 116 | 37 | 332 | 148 | 144 | 6 | 761 | 116 | 1723 | 1713 | 1493 |
| 2051 | 106 | 116 | 37 | 332 | 148 | 144 | 6 | 783 | 116 | 1749 | 1741 | 1526 |
| 2052 | 106 | 116 | 37 | 332 | 148 | 144 | 6 | 805 | 116 | 1789 | 1782 | 1549 |
| 2053 | 106 | 116 | 37 | 332 | 148 | 144 | 6 | 827 | 116 | 1831 | 1822 | 1585 |
| 2054 | 106 | 116 | 37 | 332 | 148 | 144 | 6 | 842 | 116 | 1866 | 1856 | 1610 |
| 2055 | 106 | 116 | 37 | 332 | 148 | 144 | 6 | 861 | 116 | 1902 | 1887 | 1639 |
| 2056 | 106 | 116 | 37 | 332 | 148 | 144 | 6 | 868 | 116 | 1919 | 1905 | 1645 |
| 2057 | 106 | 116 | 37 | 332 | 148 | 144 | 6 | 873 | 116 | 1946 | 1933 | 1665 |
| 2058 | 106 | 116 | 37 | 332 | 148 | 144 | 6 | 875 | 116 | 1965 | 1950 | 1670 |
| 2059 | 106 | 116 | 37 | 332 | 148 | 144 | 6 | 875 | 116 | 1990 | 1972 | 1683 |

|      | 1   | 2   | 3  | 4   | 5   | 6   | 7 | 8   | 9   | 10   | 11   | 12   |
|------|-----|-----|----|-----|-----|-----|---|-----|-----|------|------|------|
| 2060 | 106 | 116 | 37 | 332 | 148 | 144 | 6 | 875 | 116 | 2016 | 1998 | 1693 |
| 2061 | 106 | 116 | 37 | 332 | 148 | 144 | 6 | 875 | 116 | 2045 | 2024 | 1695 |
| 2062 | 106 | 116 | 37 | 332 | 148 | 144 | 6 | 875 | 116 | 2075 | 2057 | 1710 |
| 2063 | 106 | 116 | 37 | 332 | 148 | 144 | 6 | 875 | 116 | 2106 | 2091 | 1720 |
| 2064 | 106 | 116 | 37 | 332 | 148 | 144 | 6 | 875 | 116 | 2133 | 2117 | 1728 |
| 2065 | 106 | 116 | 37 | 332 | 148 | 144 | 6 | 875 | 116 | 2140 | 2124 | 1728 |
| 2066 | 106 | 116 | 37 | 332 | 148 | 144 | 6 | 875 | 116 | 2140 | 2124 | 1728 |
| 2067 | 106 | 116 | 37 | 332 | 148 | 144 | 6 | 875 | 116 | 2140 | 2124 | 1728 |
| 2068 | 106 | 116 | 37 | 332 | 148 | 144 | 6 | 875 | 116 | 2140 | 2124 | 1728 |
| 2069 | 106 | 116 | 37 | 332 | 148 | 144 | 6 | 875 | 116 | 2140 | 2124 | 1728 |
| 2070 | 106 | 116 | 37 | 332 | 148 | 144 | 6 | 875 | 116 | 2140 | 2124 | 1728 |
| 2071 | 106 | 116 | 37 | 332 | 148 | 144 | 6 | 875 | 116 | 2140 | 2124 | 1728 |
| 2072 | 106 | 116 | 37 | 332 | 148 | 144 | 6 | 875 | 116 | 2140 | 2124 | 1728 |
| 2073 | 106 | 116 | 37 | 332 | 148 | 144 | 6 | 875 | 116 | 2140 | 2124 | 1728 |
| 2074 | 106 | 116 | 37 | 332 | 148 | 144 | 6 | 875 | 116 | 2140 | 2124 | 1728 |
| 2075 | 106 | 116 | 37 | 332 | 148 | 144 | 6 | 875 | 116 | 2140 | 2124 | 1728 |
| 2076 | 106 | 116 | 37 | 332 | 148 | 144 | 6 | 875 | 116 | 2140 | 2124 | 1728 |
| 2077 | 106 | 116 | 37 | 332 | 148 | 144 | 6 | 875 | 116 | 2140 | 2124 | 1728 |
| 2078 | 106 | 116 | 37 | 332 | 148 | 144 | 6 | 875 | 116 | 2140 | 2124 | 1728 |
| 2079 | 106 | 116 | 37 | 332 | 148 | 144 | 6 | 875 | 116 | 2140 | 2124 | 1728 |
| 2080 | 106 | 116 | 37 | 332 | 148 | 144 | 6 | 875 | 116 | 2140 | 2124 | 1728 |
| 2081 | 106 | 116 | 37 | 332 | 148 | 144 | 6 | 875 | 116 | 2140 | 2124 | 1728 |
| 2082 | 106 | 116 | 37 | 332 | 148 | 144 | 6 | 875 | 116 | 2140 | 2124 | 1728 |
| 2083 | 106 | 116 | 37 | 332 | 148 | 144 | 6 | 875 | 116 | 2140 | 2124 | 1728 |
| 2084 | 106 | 116 | 37 | 332 | 148 | 144 | 6 | 875 | 116 | 2140 | 2124 | 1728 |
| 2085 | 106 | 116 | 37 | 332 | 148 | 144 | 6 | 875 | 116 | 2140 | 2124 | 1728 |
| 2086 | 106 | 116 | 37 | 332 | 148 | 144 | 6 | 875 | 116 | 2140 | 2124 | 1728 |
| 2087 | 106 | 116 | 37 | 332 | 148 | 144 | 6 | 875 | 116 | 2140 | 2124 | 1728 |
| 2088 | 106 | 116 | 37 | 332 | 148 | 144 | 6 | 875 | 116 | 2140 | 2124 | 1728 |
| 2089 | 106 | 116 | 37 | 332 | 148 | 144 | 6 | 875 | 116 | 2140 | 2124 | 1728 |
| 2090 | 106 | 116 | 37 | 332 | 148 | 144 | 6 | 875 | 116 | 2140 | 2124 | 1728 |



|      | 13   | 14   | 15   | 16  | 17   | 18   | 19   | 20   | 21   | 22   | 23   | 24   |
|------|------|------|------|-----|------|------|------|------|------|------|------|------|
| 2002 | 0    | 0    | 0    | 0   | 0    | 0    | 0    | 0    | 0    | 0    | 0    | 0    |
| 2003 | 0    | 0    | 0    | 0   | 0    | 0    | 0    | 0    | 0    | 0    | 0    | 0    |
| 2004 | 0    | 0    | 0    | 0   | 0    | 0    | 0    | 0    | 0    | 0    | 0    | 0    |
| 2005 | 0    | 0    | 0    | 0   | 0    | 0    | 0    | 0    | 0    | 0    | 0    | 0    |
| 2006 | 0    | 0    | 0    | 0   | 0    | 0    | 0    | 0    | 0    | 0    | 0    | 0    |
| 2007 | 0    | 0    | 0    | 0   | 0    | 0    | 0    | 0    | 0    | 0    | 0    | 0    |
| 2008 | 0    | 0    | 0    | 0   | 0    | 0    | 0    | 0    | 0    | 0    | 0    | 0    |
| 2009 | 0    | 0    | 0    | 0   | 0    | 0    | 0    | 0    | 0    | 0    | 0    | 0    |
| 2010 | 0    | 0    | 0    | 0   | 0    | 0    | 0    | 0    | 0    | 0    | 0    | 0    |
| 2011 | 0    | 0    | 0    | 0   | 0    | 0    | 0    | 0    | 0    | 0    | 0    | 0    |
| 2012 | 0    | 0    | 0    | 0   | 0    | 0    | 0    | 0    | 0    | 0    | 0    | 0    |
| 2013 | 0    | 0    | 0    | 0   | 0    | 0    | 0    | 0    | 0    | 0    | 0    | 0    |
| 2014 | 0    | 0    | 0    | 0   | 0    | 0    | 0    | 0    | 0    | 0    | 0    | 0    |
| 2015 | 0    | 0    | 0    | 0   | 0    | 0    | 0    | 0    | 0    | 0    | 0    | 0    |
| 2016 | 0    | 0    | 0    | 0   | 0    | 0    | 0    | 0    | 0    | 0    | 0    | 0    |
| 2017 | 0    | 0    | 0    | 0   | 0    | 0    | 0    | 0    | 0    | 0    | 0    | 0    |
| 2018 | 0    | 0    | 0    | 0   | 0    | 0    | 0    | 0    | 0    | 0    | 0    | 0    |
| 2019 | 0    | 0    | 0    | 0   | 0    | 0    | 0    | 0    | 0    | 0    | 0    | 0    |
| 2020 | 0    | 0    | 0    | 0   | 0    | 0    | 0    | 0    | 0    | 0    | 0    | 0    |
| 2021 | 7    | 0    | 0    | 0   | 0    | 0    | 0    | 0    | 0    | 3    | 0    | 0    |
| 2022 | 56   | 0    | 0    | 0   | 0    | 0    | 0    | 0    | 0    | 28   | 0    | 0    |
| 2023 | 171  | 0    | 0    | 0   | 0    | 0    | 0    | 0    | 0    | 59   | 0    | 0    |
| 2024 | 319  | 0    | 0    | 0   | 0    | 0    | 0    | 0    | 0    | 123  | 0    | 0    |
| 2025 | 417  | 0    | 0    | 0   | 0    | 0    | 0    | 0    | 0    | 200  | 0    | 0    |
| 2026 | 558  | 13   | 6    | 0   | 2    | 15   | 1    | 1    | 0    | 359  | 0    | 15   |
| 2027 | 649  | 34   | 72   | 1   | 6    | 45   | 23   | 24   | 0    | 537  | 8    | 63   |
| 2028 | 760  | 55   | 141  | 7   | 17   | 130  | 37   | 40   | 0    | 772  | 24   | 139  |
| 2029 | 837  | 106  | 209  | 14  | 39   | 232  | 76   | 79   | 0    | 952  | 49   | 254  |
| 2030 | 940  | 153  | 280  | 16  | 69   | 348  | 155  | 157  | 0    | 1164 | 96   | 368  |
| 2031 | 1019 | 292  | 364  | 18  | 123  | 496  | 266  | 262  | 8    | 1338 | 190  | 507  |
| 2032 | 1083 | 389  | 435  | 27  | 167  | 597  | 404  | 392  | 27   | 1537 | 290  | 616  |
| 2033 | 1137 | 546  | 532  | 30  | 276  | 709  | 561  | 542  | 55   | 1712 | 402  | 735  |
| 2034 | 1188 | 704  | 618  | 37  | 356  | 807  | 781  | 761  | 133  | 1922 | 523  | 883  |
| 2035 | 1241 | 830  | 683  | 45  | 445  | 872  | 1006 | 986  | 204  | 2116 | 660  | 969  |
| 2036 | 1273 | 912  | 757  | 50  | 530  | 995  | 1233 | 1205 | 289  | 2285 | 875  | 1060 |
| 2037 | 1321 | 964  | 837  | 53  | 667  | 1068 | 1432 | 1401 | 395  | 2466 | 1168 | 1176 |
| 2038 | 1356 | 1010 | 935  | 68  | 813  | 1114 | 1617 | 1585 | 537  | 2654 | 1409 | 1289 |
| 2039 | 1406 | 1070 | 985  | 87  | 987  | 1182 | 1789 | 1764 | 740  | 2830 | 1681 | 1431 |
| 2040 | 1439 | 1145 | 1066 | 96  | 1169 | 1230 | 1951 | 1927 | 964  | 2967 | 1922 | 1570 |
| 2041 | 1484 | 1190 | 1133 | 127 | 1366 | 1293 | 2124 | 2094 | 1184 | 3141 | 2156 | 1691 |
| 2042 | 1516 | 1241 | 1211 | 142 | 1571 | 1353 | 2305 | 2273 | 1357 | 3288 | 2355 | 1837 |
| 2043 | 1576 | 1276 | 1283 | 170 | 1799 | 1431 | 2487 | 2460 | 1517 | 3450 | 2565 | 1959 |
| 2044 | 1595 | 1309 | 1339 | 185 | 2004 | 1471 | 2640 | 2611 | 1693 | 3618 | 2767 | 2067 |
| 2045 | 1638 | 1358 | 1410 | 205 | 2208 | 1505 | 2821 | 2790 | 1887 | 3750 | 2984 | 2180 |
| 2046 | 1678 | 1410 | 1449 | 223 | 2359 | 1557 | 2959 | 2932 | 2031 | 3846 | 3179 | 2244 |
| 2047 | 1721 | 1457 | 1521 | 242 | 2510 | 1601 | 3085 | 3059 | 2212 | 3961 | 3388 | 2351 |
| 2048 | 1783 | 1538 | 1592 | 276 | 2639 | 1652 | 3231 | 3198 | 2389 | 4060 | 3552 | 2400 |
| 2049 | 1824 | 1582 | 1642 | 296 | 2822 | 1680 | 3316 | 3285 | 2503 | 4097 | 3641 | 2444 |
| 2050 | 1874 | 1640 | 1675 | 329 | 2934 | 1723 | 3381 | 3352 | 2598 | 4127 | 3701 | 2500 |
| 2051 | 1916 | 1698 | 1713 | 356 | 3030 | 1749 | 3448 | 3422 | 2676 | 4162 | 3761 | 2539 |
| 2052 | 1979 | 1748 | 1748 | 383 | 3104 | 1788 | 3481 | 3457 | 2733 | 4176 | 3845 | 2574 |
| 2053 | 2028 | 1783 | 1774 | 408 | 3212 | 1828 | 3521 | 3493 | 2785 | 4193 | 3915 | 2593 |
| 2054 | 2082 | 1828 | 1793 | 444 | 3307 | 1865 | 3558 | 3531 | 2849 | 4218 | 3951 | 2609 |
| 2055 | 2137 | 1857 | 1811 | 460 | 3393 | 1898 | 3571 | 3544 | 2870 | 4237 | 4007 | 2624 |
| 2056 | 2196 | 1900 | 1831 | 464 | 3425 | 1920 | 3585 | 3558 | 2897 | 4256 | 4016 | 2624 |
| 2057 | 2246 | 1941 | 1841 | 464 | 3464 | 1950 | 3602 | 3577 | 2917 | 4286 | 4071 | 2624 |
| 2058 | 2297 | 1955 | 1841 | 464 | 3513 | 1965 | 3612 | 3588 | 2928 | 4303 | 4093 | 2624 |
| 2059 | 2343 | 1994 | 1841 | 464 | 3554 | 1996 | 3626 | 3602 | 2932 | 4329 | 4110 | 2624 |

|      | 13   | 14   | 15   | 16  | 17   | 18   | 19   | 20   | 21   | 22   | 23   | 24   |
|------|------|------|------|-----|------|------|------|------|------|------|------|------|
| 2060 | 2380 | 2014 | 1841 | 464 | 3595 | 2021 | 3634 | 3611 | 2932 | 4336 | 4120 | 2624 |
| 2061 | 2430 | 2032 | 1841 | 464 | 3636 | 2050 | 3643 | 3620 | 2932 | 4341 | 4125 | 2624 |
| 2062 | 2465 | 2052 | 1841 | 464 | 3668 | 2077 | 3658 | 3636 | 2936 | 4341 | 4136 | 2624 |
| 2063 | 2491 | 2073 | 1841 | 464 | 3707 | 2106 | 3660 | 3638 | 2938 | 4341 | 4139 | 2624 |
| 2064 | 2506 | 2102 | 1841 | 464 | 3725 | 2130 | 3660 | 3638 | 2944 | 4341 | 4150 | 2624 |
| 2065 | 2506 | 2123 | 1841 | 464 | 3778 | 2137 | 3660 | 3638 | 2944 | 4341 | 4160 | 2624 |
| 2066 | 2506 | 2142 | 1841 | 464 | 3806 | 2137 | 3660 | 3638 | 2944 | 4341 | 4167 | 2624 |
| 2067 | 2506 | 2159 | 1841 | 464 | 3842 | 2137 | 3660 | 3638 | 2944 | 4341 | 4178 | 2624 |
| 2068 | 2506 | 2167 | 1841 | 464 | 3871 | 2137 | 3660 | 3638 | 2944 | 4341 | 4178 | 2624 |
| 2069 | 2506 | 2167 | 1841 | 464 | 3891 | 2137 | 3660 | 3638 | 2944 | 4341 | 4178 | 2624 |
| 2070 | 2506 | 2167 | 1841 | 464 | 3916 | 2137 | 3660 | 3638 | 2944 | 4341 | 4178 | 2624 |
| 2071 | 2506 | 2167 | 1841 | 464 | 3932 | 2137 | 3660 | 3638 | 2944 | 4341 | 4178 | 2624 |
| 2072 | 2506 | 2167 | 1841 | 464 | 3965 | 2137 | 3660 | 3638 | 2944 | 4341 | 4178 | 2624 |
| 2073 | 2506 | 2167 | 1841 | 464 | 3987 | 2137 | 3660 | 3638 | 2944 | 4341 | 4178 | 2624 |
| 2074 | 2506 | 2167 | 1841 | 464 | 4014 | 2137 | 3660 | 3638 | 2944 | 4341 | 4178 | 2624 |
| 2075 | 2506 | 2167 | 1841 | 464 | 4045 | 2137 | 3660 | 3638 | 2944 | 4341 | 4178 | 2624 |
| 2076 | 2506 | 2167 | 1841 | 464 | 4067 | 2137 | 3660 | 3638 | 2944 | 4341 | 4178 | 2624 |
| 2077 | 2506 | 2167 | 1841 | 464 | 4093 | 2137 | 3660 | 3638 | 2944 | 4341 | 4178 | 2624 |
| 2078 | 2506 | 2167 | 1841 | 464 | 4103 | 2137 | 3660 | 3638 | 2944 | 4341 | 4178 | 2624 |
| 2079 | 2506 | 2167 | 1841 | 464 | 4103 | 2137 | 3660 | 3638 | 2944 | 4341 | 4178 | 2624 |
| 2080 | 2506 | 2167 | 1841 | 464 | 4103 | 2137 | 3660 | 3638 | 2944 | 4341 | 4178 | 2624 |
| 2081 | 2506 | 2167 | 1841 | 464 | 4103 | 2137 | 3660 | 3638 | 2944 | 4341 | 4178 | 2624 |
| 2082 | 2506 | 2167 | 1841 | 464 | 4103 | 2137 | 3660 | 3638 | 2944 | 4341 | 4178 | 2624 |
| 2083 | 2506 | 2167 | 1841 | 464 | 4103 | 2137 | 3660 | 3638 | 2944 | 4341 | 4178 | 2624 |
| 2084 | 2506 | 2167 | 1841 | 464 | 4103 | 2137 | 3660 | 3638 | 2944 | 4341 | 4178 | 2624 |
| 2085 | 2506 | 2167 | 1841 | 464 | 4103 | 2137 | 3660 | 3638 | 2944 | 4341 | 4178 | 2624 |
| 2086 | 2506 | 2167 | 1841 | 464 | 4103 | 2137 | 3660 | 3638 | 2944 | 4341 | 4178 | 2624 |
| 2087 | 2506 | 2167 | 1841 | 464 | 4103 | 2137 | 3660 | 3638 | 2944 | 4341 | 4178 | 2624 |
| 2088 | 2506 | 2167 | 1841 | 464 | 4103 | 2137 | 3660 | 3638 | 2944 | 4341 | 4178 | 2624 |
| 2089 | 2506 | 2167 | 1841 | 464 | 4103 | 2137 | 3660 | 3638 | 2944 | 4341 | 4178 | 2624 |
| 2090 | 2506 | 2167 | 1841 | 464 | 4103 | 2137 | 3660 | 3638 | 2944 | 4341 | 4178 | 2624 |

|      | 25   | 26   | 27   | 28 | 29  | 30 | 31  | 32  | 33  | 34 | 35  | 36  |
|------|------|------|------|----|-----|----|-----|-----|-----|----|-----|-----|
| 2002 | 0    | 0    | 0    | 0  | 0   | 0  | 0   | 0   | 0   | 0  | 0   | 0   |
| 2003 | 0    | 0    | 0    | 0  | 0   | 0  | 0   | 0   | 0   | 0  | 0   | 0   |
| 2004 | 0    | 0    | 0    | 0  | 0   | 0  | 0   | 0   | 0   | 0  | 0   | 0   |
| 2005 | 0    | 0    | 0    | 0  | 0   | 0  | 0   | 0   | 0   | 0  | 0   | 0   |
| 2006 | 0    | 0    | 0    | 0  | 0   | 0  | 0   | 0   | 0   | 0  | 0   | 0   |
| 2007 | 0    | 0    | 0    | 0  | 0   | 0  | 0   | 0   | 0   | 0  | 0   | 0   |
| 2008 | 0    | 0    | 0    | 0  | 0   | 0  | 0   | 0   | 0   | 0  | 0   | 0   |
| 2009 | 0    | 0    | 0    | 0  | 0   | 0  | 0   | 0   | 0   | 0  | 0   | 0   |
| 2010 | 0    | 0    | 0    | 0  | 0   | 0  | 0   | 0   | 0   | 0  | 0   | 0   |
| 2011 | 0    | 0    | 0    | 0  | 0   | 0  | 0   | 0   | 0   | 0  | 0   | 0   |
| 2012 | 0    | 0    | 0    | 0  | 0   | 0  | 0   | 0   | 0   | 0  | 0   | 0   |
| 2013 | 0    | 0    | 0    | 0  | 0   | 0  | 0   | 0   | 0   | 0  | 0   | 0   |
| 2014 | 0    | 0    | 0    | 0  | 0   | 0  | 0   | 0   | 0   | 0  | 0   | 0   |
| 2015 | 0    | 0    | 0    | 0  | 0   | 0  | 0   | 0   | 0   | 0  | 0   | 0   |
| 2016 | 0    | 0    | 0    | 0  | 0   | 0  | 0   | 0   | 0   | 0  | 0   | 0   |
| 2017 | 0    | 0    | 0    | 0  | 0   | 0  | 0   | 0   | 0   | 0  | 0   | 0   |
| 2018 | 0    | 0    | 0    | 0  | 0   | 0  | 0   | 0   | 0   | 0  | 0   | 0   |
| 2019 | 0    | 0    | 0    | 0  | 0   | 0  | 0   | 0   | 0   | 0  | 0   | 0   |
| 2020 | 0    | 0    | 0    | 0  | 0   | 0  | 0   | 0   | 0   | 0  | 0   | 0   |
| 2021 | 0    | 0    | 0    | 0  | 0   | 0  | 0   | 0   | 0   | 0  | 0   | 0   |
| 2022 | 0    | 0    | 0    | 0  | 0   | 0  | 0   | 0   | 0   | 0  | 0   | 0   |
| 2023 | 0    | 0    | 0    | 0  | 0   | 0  | 0   | 0   | 0   | 0  | 0   | 0   |
| 2024 | 0    | 0    | 0    | 0  | 0   | 0  | 0   | 0   | 0   | 0  | 0   | 0   |
| 2025 | 0    | 0    | 0    | 0  | 0   | 0  | 0   | 0   | 0   | 0  | 0   | 0   |
| 2026 | 40   | 1    | 1    | 0  | 0   | 0  | 0   | 0   | 0   | 0  | 0   | 0   |
| 2027 | 140  | 4    | 23   | 0  | 0   | 0  | 0   | 0   | 0   | 0  | 0   | 0   |
| 2028 | 281  | 7    | 37   | 0  | 0   | 0  | 0   | 0   | 0   | 0  | 0   | 0   |
| 2029 | 441  | 19   | 77   | 0  | 0   | 0  | 0   | 0   | 0   | 0  | 0   | 0   |
| 2030 | 552  | 26   | 157  | 0  | 0   | 0  | 1   | 0   | 0   | 0  | 0   | 0   |
| 2031 | 731  | 42   | 267  | 0  | 0   | 0  | 1   | 0   | 0   | 0  | 0   | 0   |
| 2032 | 851  | 60   | 399  | 0  | 0   | 0  | 1   | 0   | 0   | 0  | 0   | 0   |
| 2033 | 952  | 93   | 552  | 0  | 0   | 0  | 1   | 0   | 0   | 0  | 3   | 0   |
| 2034 | 1029 | 131  | 775  | 0  | 0   | 0  | 4   | 0   | 0   | 0  | 7   | 0   |
| 2035 | 1126 | 170  | 999  | 0  | 0   | 0  | 12  | 0   | 0   | 0  | 30  | 0   |
| 2036 | 1236 | 222  | 1225 | 1  | 1   | 0  | 27  | 1   | 1   | 1  | 59  | 1   |
| 2037 | 1334 | 278  | 1423 | 1  | 1   | 0  | 53  | 1   | 1   | 1  | 85  | 1   |
| 2038 | 1399 | 363  | 1603 | 3  | 4   | 0  | 76  | 5   | 2   | 2  | 152 | 4   |
| 2039 | 1472 | 488  | 1775 | 7  | 10  | 0  | 107 | 14  | 4   | 3  | 205 | 10  |
| 2040 | 1546 | 612  | 1937 | 10 | 15  | 0  | 126 | 22  | 7   | 3  | 242 | 15  |
| 2041 | 1612 | 754  | 2109 | 17 | 28  | 0  | 182 | 42  | 17  | 4  | 298 | 26  |
| 2042 | 1688 | 912  | 2289 | 30 | 44  | 0  | 209 | 57  | 27  | 4  | 395 | 40  |
| 2043 | 1751 | 1112 | 2487 | 51 | 63  | 0  | 241 | 84  | 49  | 6  | 472 | 60  |
| 2044 | 1834 | 1328 | 2644 | 70 | 82  | 3  | 269 | 103 | 69  | 6  | 520 | 79  |
| 2045 | 1875 | 1559 | 2836 | 85 | 96  | 15 | 290 | 116 | 85  | 6  | 600 | 93  |
| 2046 | 1921 | 1831 | 2981 | 94 | 106 | 24 | 303 | 118 | 98  | 6  | 625 | 101 |
| 2047 | 1949 | 2116 | 3101 | 96 | 110 | 32 | 312 | 119 | 102 | 6  | 670 | 105 |
| 2048 | 1987 | 2331 | 3234 | 96 | 110 | 32 | 321 | 119 | 106 | 6  | 701 | 105 |
| 2049 | 2003 | 2534 | 3322 | 96 | 110 | 32 | 321 | 119 | 107 | 6  | 725 | 105 |
| 2050 | 2020 | 2789 | 3386 | 96 | 110 | 32 | 330 | 119 | 107 | 6  | 761 | 105 |
| 2051 | 2031 | 2973 | 3453 | 96 | 110 | 32 | 330 | 119 | 107 | 6  | 784 | 105 |
| 2052 | 2040 | 3119 | 3482 | 96 | 110 | 32 | 330 | 119 | 107 | 6  | 806 | 105 |
| 2053 | 2053 | 3342 | 3515 | 96 | 110 | 32 | 330 | 119 | 107 | 6  | 826 | 105 |
| 2054 | 2053 | 3496 | 3553 | 96 | 110 | 32 | 330 | 119 | 107 | 6  | 841 | 105 |
| 2055 | 2053 | 3654 | 3564 | 96 | 110 | 32 | 330 | 119 | 107 | 6  | 856 | 105 |
| 2056 | 2053 | 3775 | 3577 | 96 | 110 | 32 | 330 | 119 | 107 | 6  | 863 | 105 |
| 2057 | 2053 | 3894 | 3594 | 96 | 110 | 32 | 330 | 119 | 107 | 6  | 868 | 105 |
| 2058 | 2053 | 3970 | 3603 | 96 | 110 | 32 | 330 | 119 | 107 | 6  | 871 | 105 |
| 2059 | 2053 | 4037 | 3617 | 96 | 110 | 32 | 330 | 119 | 107 | 6  | 871 | 105 |

|      | 25   | 26   | 27   | 28 | 29  | 30 | 31  | 32  | 33  | 34 | 35  | 36  |
|------|------|------|------|----|-----|----|-----|-----|-----|----|-----|-----|
| 2060 | 2053 | 4135 | 3626 | 96 | 110 | 32 | 330 | 119 | 107 | 6  | 871 | 105 |
| 2061 | 2053 | 4197 | 3635 | 96 | 110 | 32 | 330 | 119 | 107 | 6  | 871 | 105 |
| 2062 | 2053 | 4257 | 3652 | 96 | 110 | 32 | 330 | 119 | 107 | 6  | 871 | 105 |
| 2063 | 2053 | 4305 | 3654 | 96 | 110 | 32 | 330 | 119 | 107 | 6  | 871 | 105 |
| 2064 | 2053 | 4344 | 3654 | 96 | 110 | 32 | 330 | 119 | 107 | 6  | 871 | 105 |
| 2065 | 2053 | 4388 | 3654 | 96 | 110 | 32 | 330 | 119 | 107 | 6  | 871 | 105 |
| 2066 | 2053 | 4410 | 3654 | 96 | 110 | 32 | 330 | 119 | 107 | 6  | 871 | 105 |
| 2067 | 2053 | 4424 | 3654 | 96 | 110 | 32 | 330 | 119 | 107 | 6  | 871 | 105 |
| 2068 | 2053 | 4442 | 3654 | 96 | 110 | 32 | 330 | 119 | 107 | 6  | 871 | 105 |
| 2069 | 2053 | 4453 | 3654 | 96 | 110 | 32 | 330 | 119 | 107 | 6  | 871 | 105 |
| 2070 | 2053 | 4463 | 3654 | 96 | 110 | 32 | 330 | 119 | 107 | 6  | 871 | 105 |
| 2071 | 2053 | 4472 | 3654 | 96 | 110 | 32 | 330 | 119 | 107 | 6  | 871 | 105 |
| 2072 | 2053 | 4486 | 3654 | 96 | 110 | 32 | 330 | 119 | 107 | 6  | 871 | 105 |
| 2073 | 2053 | 4496 | 3654 | 96 | 110 | 32 | 330 | 119 | 107 | 6  | 871 | 105 |
| 2074 | 2053 | 4505 | 3654 | 96 | 110 | 32 | 330 | 119 | 107 | 6  | 871 | 105 |
| 2075 | 2053 | 4519 | 3654 | 96 | 110 | 32 | 330 | 119 | 107 | 6  | 871 | 105 |
| 2076 | 2053 | 4522 | 3654 | 96 | 110 | 32 | 330 | 119 | 107 | 6  | 871 | 105 |
| 2077 | 2053 | 4522 | 3654 | 96 | 110 | 32 | 330 | 119 | 107 | 6  | 871 | 105 |
| 2078 | 2053 | 4522 | 3654 | 96 | 110 | 32 | 330 | 119 | 107 | 6  | 871 | 105 |
| 2079 | 2053 | 4522 | 3654 | 96 | 110 | 32 | 330 | 119 | 107 | 6  | 871 | 105 |
| 2080 | 2053 | 4522 | 3654 | 96 | 110 | 32 | 330 | 119 | 107 | 6  | 871 | 105 |
| 2081 | 2053 | 4522 | 3654 | 96 | 110 | 32 | 330 | 119 | 107 | 6  | 871 | 105 |
| 2082 | 2053 | 4522 | 3654 | 96 | 110 | 32 | 330 | 119 | 107 | 6  | 871 | 105 |
| 2083 | 2053 | 4522 | 3654 | 96 | 110 | 32 | 330 | 119 | 107 | 6  | 871 | 105 |
| 2084 | 2053 | 4522 | 3654 | 96 | 110 | 32 | 330 | 119 | 107 | 6  | 871 | 105 |
| 2085 | 2053 | 4522 | 3654 | 96 | 110 | 32 | 330 | 119 | 107 | 6  | 871 | 105 |
| 2086 | 2053 | 4522 | 3654 | 96 | 110 | 32 | 330 | 119 | 107 | 6  | 871 | 105 |
| 2087 | 2053 | 4522 | 3654 | 96 | 110 | 32 | 330 | 119 | 107 | 6  | 871 | 105 |
| 2088 | 2053 | 4522 | 3654 | 96 | 110 | 32 | 330 | 119 | 107 | 6  | 871 | 105 |
| 2089 | 2053 | 4522 | 3654 | 96 | 110 | 32 | 330 | 119 | 107 | 6  | 871 | 105 |
| 2090 | 2053 | 4522 | 3654 | 96 | 110 | 32 | 330 | 119 | 107 | 6  | 871 | 105 |

|      | 37   | 38   | 39   | 40   | 41   | 42   | 43  | 44   | 45   | 46   | 47   | 48   |
|------|------|------|------|------|------|------|-----|------|------|------|------|------|
| 2002 | 0    | 0    | 0    | 0    | 0    | 0    | 0   | 0    | 0    | 0    | 0    | 0    |
| 2003 | 0    | 0    | 0    | 0    | 0    | 0    | 0   | 0    | 0    | 0    | 0    | 0    |
| 2004 | 0    | 0    | 0    | 0    | 0    | 0    | 0   | 0    | 0    | 0    | 0    | 0    |
| 2005 | 0    | 0    | 0    | 0    | 0    | 0    | 0   | 0    | 0    | 0    | 0    | 0    |
| 2006 | 0    | 0    | 0    | 0    | 0    | 0    | 0   | 0    | 0    | 0    | 0    | 0    |
| 2007 | 0    | 0    | 0    | 0    | 0    | 0    | 0   | 0    | 0    | 0    | 0    | 0    |
| 2008 | 0    | 0    | 0    | 0    | 0    | 0    | 0   | 0    | 0    | 0    | 0    | 0    |
| 2009 | 0    | 0    | 0    | 0    | 0    | 0    | 0   | 0    | 0    | 0    | 0    | 0    |
| 2010 | 0    | 0    | 0    | 0    | 0    | 0    | 0   | 0    | 0    | 0    | 0    | 0    |
| 2011 | 0    | 0    | 0    | 0    | 0    | 0    | 0   | 0    | 0    | 0    | 0    | 0    |
| 2012 | 0    | 0    | 0    | 0    | 0    | 0    | 0   | 0    | 0    | 0    | 0    | 0    |
| 2013 | 0    | 0    | 0    | 0    | 0    | 0    | 0   | 0    | 0    | 0    | 0    | 0    |
| 2014 | 0    | 0    | 0    | 0    | 0    | 0    | 0   | 0    | 0    | 0    | 0    | 0    |
| 2015 | 0    | 0    | 0    | 0    | 0    | 0    | 0   | 0    | 0    | 0    | 0    | 0    |
| 2016 | 0    | 0    | 0    | 0    | 0    | 0    | 0   | 0    | 0    | 0    | 0    | 0    |
| 2017 | 0    | 0    | 0    | 0    | 0    | 0    | 0   | 0    | 0    | 0    | 0    | 0    |
| 2018 | 0    | 0    | 0    | 0    | 0    | 0    | 0   | 0    | 0    | 0    | 0    | 0    |
| 2019 | 0    | 0    | 0    | 0    | 0    | 0    | 0   | 0    | 0    | 0    | 0    | 0    |
| 2020 | 0    | 0    | 0    | 0    | 0    | 0    | 0   | 0    | 0    | 0    | 0    | 0    |
| 2021 | 0    | 0    | 0    | 7    | 0    | 0    | 0   | 0    | 0    | 0    | 0    | 0    |
| 2022 | 0    | 0    | 0    | 56   | 0    | 0    | 0   | 0    | 0    | 0    | 0    | 0    |
| 2023 | 0    | 0    | 0    | 171  | 0    | 0    | 0   | 0    | 0    | 0    | 0    | 0    |
| 2024 | 0    | 0    | 0    | 319  | 0    | 0    | 0   | 0    | 0    | 0    | 0    | 0    |
| 2025 | 0    | 0    | 0    | 417  | 0    | 0    | 0   | 0    | 0    | 0    | 0    | 0    |
| 2026 | 15   | 15   | 0    | 558  | 13   | 6    | 0   | 2    | 15   | 1    | 1    | 0    |
| 2027 | 45   | 45   | 0    | 649  | 34   | 72   | 1   | 6    | 45   | 23   | 24   | 0    |
| 2028 | 130  | 130  | 0    | 760  | 55   | 141  | 7   | 17   | 130  | 35   | 38   | 0    |
| 2029 | 234  | 232  | 0    | 837  | 106  | 207  | 14  | 37   | 232  | 72   | 75   | 0    |
| 2030 | 352  | 348  | 0    | 940  | 153  | 272  | 16  | 67   | 348  | 151  | 152  | 0    |
| 2031 | 500  | 492  | 6    | 1018 | 292  | 360  | 18  | 116  | 494  | 259  | 254  | 8    |
| 2032 | 601  | 596  | 28   | 1081 | 392  | 431  | 26  | 157  | 595  | 395  | 381  | 27   |
| 2033 | 712  | 706  | 59   | 1134 | 549  | 528  | 28  | 262  | 705  | 551  | 530  | 53   |
| 2034 | 809  | 802  | 125  | 1186 | 709  | 613  | 35  | 341  | 802  | 775  | 755  | 128  |
| 2035 | 872  | 863  | 223  | 1237 | 834  | 693  | 44  | 429  | 868  | 999  | 979  | 199  |
| 2036 | 987  | 976  | 371  | 1269 | 918  | 777  | 47  | 518  | 989  | 1223 | 1195 | 286  |
| 2037 | 1060 | 1049 | 507  | 1318 | 971  | 854  | 47  | 658  | 1065 | 1416 | 1386 | 391  |
| 2038 | 1107 | 1095 | 609  | 1365 | 1025 | 953  | 57  | 804  | 1120 | 1605 | 1574 | 527  |
| 2039 | 1173 | 1162 | 670  | 1401 | 1085 | 1002 | 72  | 986  | 1183 | 1779 | 1752 | 727  |
| 2040 | 1235 | 1222 | 771  | 1438 | 1164 | 1081 | 81  | 1187 | 1234 | 1940 | 1912 | 943  |
| 2041 | 1293 | 1279 | 868  | 1503 | 1217 | 1156 | 109 | 1382 | 1293 | 2115 | 2080 | 1159 |
| 2042 | 1352 | 1340 | 965  | 1560 | 1255 | 1246 | 122 | 1585 | 1356 | 2299 | 2262 | 1322 |
| 2043 | 1434 | 1423 | 1040 | 1627 | 1294 | 1320 | 149 | 1828 | 1429 | 2494 | 2442 | 1479 |
| 2044 | 1474 | 1467 | 1129 | 1640 | 1332 | 1382 | 166 | 2026 | 1471 | 2652 | 2596 | 1652 |
| 2045 | 1513 | 1508 | 1185 | 1690 | 1386 | 1441 | 183 | 2224 | 1512 | 2838 | 2780 | 1844 |
| 2046 | 1570 | 1570 | 1251 | 1730 | 1431 | 1477 | 197 | 2386 | 1571 | 2989 | 2920 | 1991 |
| 2047 | 1605 | 1603 | 1324 | 1784 | 1481 | 1560 | 217 | 2536 | 1604 | 3110 | 3054 | 2174 |
| 2048 | 1656 | 1651 | 1419 | 1862 | 1559 | 1627 | 251 | 2692 | 1655 | 3249 | 3198 | 2357 |
| 2049 | 1688 | 1676 | 1456 | 1908 | 1592 | 1678 | 275 | 2859 | 1686 | 3339 | 3283 | 2482 |
| 2050 | 1727 | 1714 | 1488 | 1949 | 1649 | 1703 | 310 | 2972 | 1728 | 3394 | 3354 | 2578 |
| 2051 | 1756 | 1739 | 1514 | 1989 | 1696 | 1733 | 332 | 3060 | 1754 | 3465 | 3424 | 2645 |
| 2052 | 1794 | 1779 | 1538 | 2044 | 1741 | 1763 | 358 | 3136 | 1798 | 3496 | 3452 | 2700 |
| 2053 | 1841 | 1816 | 1573 | 2092 | 1786 | 1781 | 379 | 3240 | 1840 | 3530 | 3492 | 2753 |
| 2054 | 1879 | 1847 | 1602 | 2135 | 1829 | 1799 | 414 | 3335 | 1870 | 3566 | 3531 | 2818 |
| 2055 | 1909 | 1881 | 1624 | 2183 | 1854 | 1812 | 427 | 3417 | 1896 | 3584 | 3550 | 2840 |
| 2056 | 1928 | 1899 | 1630 | 2229 | 1901 | 1825 | 431 | 3451 | 1917 | 3602 | 3566 | 2868 |
| 2057 | 1960 | 1926 | 1649 | 2271 | 1940 | 1829 | 431 | 3497 | 1949 | 3618 | 3585 | 2889 |
| 2058 | 1980 | 1943 | 1655 | 2316 | 1954 | 1829 | 431 | 3544 | 1969 | 3632 | 3595 | 2901 |
| 2059 | 2007 | 1968 | 1669 | 2352 | 1993 | 1829 | 431 | 3592 | 1998 | 3644 | 3607 | 2906 |

|      | 37   | 38   | 39   | 40   | 41   | 42   | 43  | 44   | 45   | 46   | 47   | 48   |
|------|------|------|------|------|------|------|-----|------|------|------|------|------|
| 2060 | 2027 | 1990 | 1677 | 2383 | 2011 | 1829 | 431 | 3627 | 2022 | 3650 | 3612 | 2906 |
| 2061 | 2052 | 2019 | 1682 | 2418 | 2031 | 1829 | 431 | 3669 | 2046 | 3659 | 3621 | 2906 |
| 2062 | 2079 | 2048 | 1696 | 2450 | 2049 | 1829 | 431 | 3702 | 2072 | 3673 | 3634 | 2908 |
| 2063 | 2108 | 2080 | 1704 | 2464 | 2072 | 1829 | 431 | 3733 | 2099 | 3674 | 3636 | 2913 |
| 2064 | 2130 | 2104 | 1710 | 2467 | 2092 | 1829 | 431 | 3761 | 2121 | 3674 | 3636 | 2918 |
| 2065 | 2135 | 2111 | 1710 | 2467 | 2111 | 1829 | 431 | 3815 | 2128 | 3674 | 3636 | 2918 |
| 2066 | 2135 | 2111 | 1710 | 2467 | 2128 | 1829 | 431 | 3840 | 2128 | 3674 | 3636 | 2918 |
| 2067 | 2135 | 2111 | 1710 | 2467 | 2142 | 1829 | 431 | 3870 | 2128 | 3674 | 3636 | 2918 |
| 2068 | 2135 | 2111 | 1710 | 2467 | 2146 | 1829 | 431 | 3896 | 2128 | 3674 | 3636 | 2918 |
| 2069 | 2135 | 2111 | 1710 | 2467 | 2146 | 1829 | 431 | 3916 | 2128 | 3674 | 3636 | 2918 |
| 2070 | 2135 | 2111 | 1710 | 2467 | 2146 | 1829 | 431 | 3943 | 2128 | 3674 | 3636 | 2918 |
| 2071 | 2135 | 2111 | 1710 | 2467 | 2146 | 1829 | 431 | 3964 | 2128 | 3674 | 3636 | 2918 |
| 2072 | 2135 | 2111 | 1710 | 2467 | 2146 | 1829 | 431 | 3992 | 2128 | 3674 | 3636 | 2918 |
| 2073 | 2135 | 2111 | 1710 | 2467 | 2146 | 1829 | 431 | 4016 | 2128 | 3674 | 3636 | 2918 |
| 2074 | 2135 | 2111 | 1710 | 2467 | 2146 | 1829 | 431 | 4038 | 2128 | 3674 | 3636 | 2918 |
| 2075 | 2135 | 2111 | 1710 | 2467 | 2146 | 1829 | 431 | 4065 | 2128 | 3674 | 3636 | 2918 |
| 2076 | 2135 | 2111 | 1710 | 2467 | 2146 | 1829 | 431 | 4087 | 2128 | 3674 | 3636 | 2918 |
| 2077 | 2135 | 2111 | 1710 | 2467 | 2146 | 1829 | 431 | 4111 | 2128 | 3674 | 3636 | 2918 |
| 2078 | 2135 | 2111 | 1710 | 2467 | 2146 | 1829 | 431 | 4121 | 2128 | 3674 | 3636 | 2918 |
| 2079 | 2135 | 2111 | 1710 | 2467 | 2146 | 1829 | 431 | 4121 | 2128 | 3674 | 3636 | 2918 |
| 2080 | 2135 | 2111 | 1710 | 2467 | 2146 | 1829 | 431 | 4121 | 2128 | 3674 | 3636 | 2918 |
| 2081 | 2135 | 2111 | 1710 | 2467 | 2146 | 1829 | 431 | 4121 | 2128 | 3674 | 3636 | 2918 |
| 2082 | 2135 | 2111 | 1710 | 2467 | 2146 | 1829 | 431 | 4121 | 2128 | 3674 | 3636 | 2918 |
| 2083 | 2135 | 2111 | 1710 | 2467 | 2146 | 1829 | 431 | 4121 | 2128 | 3674 | 3636 | 2918 |
| 2084 | 2135 | 2111 | 1710 | 2467 | 2146 | 1829 | 431 | 4121 | 2128 | 3674 | 3636 | 2918 |
| 2085 | 2135 | 2111 | 1710 | 2467 | 2146 | 1829 | 431 | 4121 | 2128 | 3674 | 3636 | 2918 |
| 2086 | 2135 | 2111 | 1710 | 2467 | 2146 | 1829 | 431 | 4121 | 2128 | 3674 | 3636 | 2918 |
| 2087 | 2135 | 2111 | 1710 | 2467 | 2146 | 1829 | 431 | 4121 | 2128 | 3674 | 3636 | 2918 |
| 2088 | 2135 | 2111 | 1710 | 2467 | 2146 | 1829 | 431 | 4121 | 2128 | 3674 | 3636 | 2918 |
| 2089 | 2135 | 2111 | 1710 | 2467 | 2146 | 1829 | 431 | 4121 | 2128 | 3674 | 3636 | 2918 |
| 2090 | 2135 | 2111 | 1710 | 2467 | 2146 | 1829 | 431 | 4121 | 2128 | 3674 | 3636 | 2918 |

|      | 49   | 50   | 51   | 52   | 53   | 54   | 55 | 56 | 57 | 58  | 59  | 60  |
|------|------|------|------|------|------|------|----|----|----|-----|-----|-----|
| 2002 | 0    | 0    | 0    | 0    | 0    | 0    | 0  | 0  | 0  | 0   | 0   | 0   |
| 2003 | 0    | 0    | 0    | 0    | 0    | 0    | 0  | 0  | 0  | 0   | 0   | 0   |
| 2004 | 0    | 0    | 0    | 0    | 0    | 0    | 0  | 0  | 0  | 0   | 0   | 0   |
| 2005 | 0    | 0    | 0    | 0    | 0    | 0    | 0  | 0  | 0  | 0   | 0   | 0   |
| 2006 | 0    | 0    | 0    | 0    | 0    | 0    | 0  | 0  | 0  | 0   | 0   | 0   |
| 2007 | 0    | 0    | 0    | 0    | 0    | 0    | 0  | 0  | 0  | 0   | 0   | 0   |
| 2008 | 0    | 0    | 0    | 0    | 0    | 0    | 0  | 0  | 0  | 0   | 0   | 0   |
| 2009 | 0    | 0    | 0    | 0    | 0    | 0    | 0  | 0  | 0  | 0   | 0   | 0   |
| 2010 | 0    | 0    | 0    | 0    | 0    | 0    | 0  | 0  | 0  | 0   | 0   | 0   |
| 2011 | 0    | 0    | 0    | 0    | 0    | 0    | 0  | 0  | 0  | 0   | 0   | 0   |
| 2012 | 0    | 0    | 0    | 0    | 0    | 0    | 0  | 0  | 0  | 0   | 0   | 0   |
| 2013 | 0    | 0    | 0    | 0    | 0    | 0    | 0  | 0  | 0  | 0   | 0   | 0   |
| 2014 | 0    | 0    | 0    | 0    | 0    | 0    | 0  | 0  | 0  | 0   | 0   | 0   |
| 2015 | 0    | 0    | 0    | 0    | 0    | 0    | 0  | 0  | 0  | 0   | 0   | 0   |
| 2016 | 0    | 0    | 0    | 0    | 0    | 0    | 0  | 0  | 0  | 0   | 0   | 0   |
| 2017 | 0    | 0    | 0    | 0    | 0    | 0    | 0  | 0  | 0  | 0   | 0   | 0   |
| 2018 | 0    | 0    | 0    | 0    | 0    | 0    | 0  | 0  | 0  | 0   | 0   | 0   |
| 2019 | 0    | 0    | 0    | 0    | 0    | 0    | 0  | 0  | 0  | 0   | 0   | 0   |
| 2020 | 0    | 0    | 0    | 0    | 0    | 0    | 0  | 0  | 0  | 0   | 0   | 0   |
| 2021 | 3    | 0    | 0    | 0    | 0    | 0    | 0  | 0  | 0  | 0   | 0   | 0   |
| 2022 | 28   | 0    | 0    | 0    | 0    | 0    | 0  | 0  | 0  | 0   | 0   | 0   |
| 2023 | 57   | 0    | 0    | 0    | 0    | 0    | 0  | 0  | 0  | 0   | 0   | 0   |
| 2024 | 120  | 0    | 0    | 0    | 0    | 0    | 0  | 0  | 0  | 0   | 0   | 0   |
| 2025 | 195  | 0    | 0    | 0    | 0    | 0    | 0  | 0  | 0  | 0   | 0   | 0   |
| 2026 | 349  | 0    | 15   | 40   | 1    | 1    | 0  | 0  | 0  | 0   | 0   | 0   |
| 2027 | 527  | 8    | 63   | 140  | 4    | 23   | 0  | 0  | 0  | 0   | 0   | 0   |
| 2028 | 761  | 24   | 139  | 280  | 7    | 35   | 0  | 0  | 0  | 0   | 0   | 0   |
| 2029 | 941  | 49   | 254  | 439  | 19   | 72   | 0  | 0  | 0  | 0   | 0   | 0   |
| 2030 | 1155 | 96   | 368  | 548  | 27   | 149  | 0  | 0  | 0  | 0   | 0   | 0   |
| 2031 | 1328 | 188  | 507  | 728  | 43   | 251  | 0  | 0  | 0  | 1   | 0   | 0   |
| 2032 | 1528 | 286  | 616  | 850  | 60   | 378  | 0  | 0  | 0  | 1   | 0   | 0   |
| 2033 | 1702 | 393  | 733  | 951  | 91   | 526  | 0  | 0  | 0  | 1   | 0   | 0   |
| 2034 | 1913 | 510  | 880  | 1025 | 123  | 745  | 0  | 0  | 0  | 3   | 0   | 0   |
| 2035 | 2104 | 644  | 969  | 1125 | 161  | 969  | 0  | 0  | 0  | 13  | 0   | 0   |
| 2036 | 2277 | 853  | 1056 | 1236 | 215  | 1196 | 0  | 0  | 0  | 17  | 0   | 0   |
| 2037 | 2467 | 1145 | 1171 | 1331 | 269  | 1385 | 1  | 1  | 0  | 35  | 1   | 1   |
| 2038 | 2648 | 1389 | 1283 | 1396 | 353  | 1570 | 1  | 1  | 0  | 53  | 2   | 1   |
| 2039 | 2821 | 1658 | 1428 | 1467 | 471  | 1748 | 1  | 1  | 0  | 80  | 4   | 4   |
| 2040 | 2965 | 1907 | 1568 | 1541 | 588  | 1906 | 2  | 2  | 0  | 91  | 6   | 4   |
| 2041 | 3140 | 2156 | 1690 | 1612 | 725  | 2081 | 3  | 3  | 0  | 138 | 9   | 7   |
| 2042 | 3288 | 2355 | 1841 | 1692 | 875  | 2255 | 6  | 7  | 0  | 164 | 16  | 14  |
| 2043 | 3454 | 2563 | 1982 | 1747 | 1078 | 2451 | 12 | 13 | 0  | 190 | 27  | 24  |
| 2044 | 3610 | 2768 | 2106 | 1827 | 1291 | 2610 | 22 | 21 | 0  | 217 | 49  | 40  |
| 2045 | 3752 | 2984 | 2203 | 1872 | 1528 | 2791 | 37 | 33 | 0  | 235 | 70  | 66  |
| 2046 | 3847 | 3175 | 2286 | 1926 | 1810 | 2943 | 41 | 42 | 0  | 258 | 88  | 82  |
| 2047 | 3980 | 3381 | 2380 | 1960 | 2107 | 3068 | 47 | 46 | 5  | 281 | 100 | 100 |
| 2048 | 4070 | 3556 | 2428 | 1998 | 2323 | 3208 | 49 | 50 | 5  | 289 | 108 | 107 |
| 2049 | 4105 | 3643 | 2473 | 2017 | 2527 | 3300 | 53 | 53 | 5  | 295 | 114 | 109 |
| 2050 | 4131 | 3708 | 2531 | 2031 | 2781 | 3351 | 53 | 53 | 5  | 301 | 117 | 110 |
| 2051 | 4165 | 3770 | 2568 | 2039 | 2962 | 3430 | 53 | 53 | 5  | 301 | 118 | 110 |
| 2052 | 4181 | 3858 | 2601 | 2047 | 3109 | 3462 | 53 | 53 | 5  | 301 | 118 | 110 |
| 2053 | 4197 | 3932 | 2619 | 2058 | 3329 | 3495 | 53 | 53 | 5  | 301 | 118 | 110 |
| 2054 | 4222 | 3976 | 2634 | 2058 | 3476 | 3529 | 53 | 53 | 5  | 301 | 118 | 110 |
| 2055 | 4240 | 4023 | 2649 | 2058 | 3632 | 3548 | 53 | 53 | 5  | 301 | 118 | 110 |
| 2056 | 4260 | 4031 | 2649 | 2058 | 3752 | 3568 | 53 | 53 | 5  | 301 | 118 | 110 |
| 2057 | 4287 | 4083 | 2649 | 2058 | 3869 | 3586 | 53 | 53 | 5  | 301 | 118 | 110 |
| 2058 | 4302 | 4107 | 2649 | 2058 | 3949 | 3597 | 53 | 53 | 5  | 301 | 118 | 110 |
| 2059 | 4327 | 4122 | 2649 | 2058 | 4029 | 3606 | 53 | 53 | 5  | 301 | 118 | 110 |

|      | 49   | 50   | 51   | 52   | 53   | 54   | 55 | 56 | 57 | 58  | 59  | 60  |
|------|------|------|------|------|------|------|----|----|----|-----|-----|-----|
| 2060 | 4331 | 4141 | 2649 | 2058 | 4128 | 3612 | 53 | 53 | 5  | 301 | 118 | 110 |
| 2061 | 4336 | 4145 | 2649 | 2058 | 4190 | 3622 | 53 | 53 | 5  | 301 | 118 | 110 |
| 2062 | 4336 | 4155 | 2649 | 2058 | 4243 | 3635 | 53 | 53 | 5  | 301 | 118 | 110 |
| 2063 | 4336 | 4157 | 2649 | 2058 | 4302 | 3637 | 53 | 53 | 5  | 301 | 118 | 110 |
| 2064 | 4336 | 4166 | 2649 | 2058 | 4340 | 3637 | 53 | 53 | 5  | 301 | 118 | 110 |
| 2065 | 4336 | 4174 | 2649 | 2058 | 4387 | 3637 | 53 | 53 | 5  | 301 | 118 | 110 |
| 2066 | 4336 | 4181 | 2649 | 2058 | 4407 | 3637 | 53 | 53 | 5  | 301 | 118 | 110 |
| 2067 | 4336 | 4189 | 2649 | 2058 | 4419 | 3637 | 53 | 53 | 5  | 301 | 118 | 110 |
| 2068 | 4336 | 4189 | 2649 | 2058 | 4447 | 3637 | 53 | 53 | 5  | 301 | 118 | 110 |
| 2069 | 4336 | 4189 | 2649 | 2058 | 4462 | 3637 | 53 | 53 | 5  | 301 | 118 | 110 |
| 2070 | 4336 | 4189 | 2649 | 2058 | 4474 | 3637 | 53 | 53 | 5  | 301 | 118 | 110 |
| 2071 | 4336 | 4189 | 2649 | 2058 | 4485 | 3637 | 53 | 53 | 5  | 301 | 118 | 110 |
| 2072 | 4336 | 4189 | 2649 | 2058 | 4495 | 3637 | 53 | 53 | 5  | 301 | 118 | 110 |
| 2073 | 4336 | 4189 | 2649 | 2058 | 4501 | 3637 | 53 | 53 | 5  | 301 | 118 | 110 |
| 2074 | 4336 | 4189 | 2649 | 2058 | 4509 | 3637 | 53 | 53 | 5  | 301 | 118 | 110 |
| 2075 | 4336 | 4189 | 2649 | 2058 | 4521 | 3637 | 53 | 53 | 5  | 301 | 118 | 110 |
| 2076 | 4336 | 4189 | 2649 | 2058 | 4524 | 3637 | 53 | 53 | 5  | 301 | 118 | 110 |
| 2077 | 4336 | 4189 | 2649 | 2058 | 4524 | 3637 | 53 | 53 | 5  | 301 | 118 | 110 |
| 2078 | 4336 | 4189 | 2649 | 2058 | 4524 | 3637 | 53 | 53 | 5  | 301 | 118 | 110 |
| 2079 | 4336 | 4189 | 2649 | 2058 | 4524 | 3637 | 53 | 53 | 5  | 301 | 118 | 110 |
| 2080 | 4336 | 4189 | 2649 | 2058 | 4524 | 3637 | 53 | 53 | 5  | 301 | 118 | 110 |
| 2081 | 4336 | 4189 | 2649 | 2058 | 4524 | 3637 | 53 | 53 | 5  | 301 | 118 | 110 |
| 2082 | 4336 | 4189 | 2649 | 2058 | 4524 | 3637 | 53 | 53 | 5  | 301 | 118 | 110 |
| 2083 | 4336 | 4189 | 2649 | 2058 | 4524 | 3637 | 53 | 53 | 5  | 301 | 118 | 110 |
| 2084 | 4336 | 4189 | 2649 | 2058 | 4524 | 3637 | 53 | 53 | 5  | 301 | 118 | 110 |
| 2085 | 4336 | 4189 | 2649 | 2058 | 4524 | 3637 | 53 | 53 | 5  | 301 | 118 | 110 |
| 2086 | 4336 | 4189 | 2649 | 2058 | 4524 | 3637 | 53 | 53 | 5  | 301 | 118 | 110 |
| 2087 | 4336 | 4189 | 2649 | 2058 | 4524 | 3637 | 53 | 53 | 5  | 301 | 118 | 110 |
| 2088 | 4336 | 4189 | 2649 | 2058 | 4524 | 3637 | 53 | 53 | 5  | 301 | 118 | 110 |
| 2089 | 4336 | 4189 | 2649 | 2058 | 4524 | 3637 | 53 | 53 | 5  | 301 | 118 | 110 |
| 2090 | 4336 | 4189 | 2649 | 2058 | 4524 | 3637 | 53 | 53 | 5  | 301 | 118 | 110 |



|      | 61 | 62  | 63 | 64   | 65   | 66   | 67   | 68   | 69   | 70  | 71   | 72   |
|------|----|-----|----|------|------|------|------|------|------|-----|------|------|
| 2002 | 0  | 0   | 0  | 0    | 0    | 0    | 0    | 0    | 0    | 0   | 0    | 0    |
| 2003 | 0  | 0   | 0  | 0    | 0    | 0    | 0    | 0    | 0    | 0   | 0    | 0    |
| 2004 | 0  | 0   | 0  | 0    | 0    | 0    | 0    | 0    | 0    | 0   | 0    | 0    |
| 2005 | 0  | 0   | 0  | 0    | 0    | 0    | 0    | 0    | 0    | 0   | 0    | 0    |
| 2006 | 0  | 0   | 0  | 0    | 0    | 0    | 0    | 0    | 0    | 0   | 0    | 0    |
| 2007 | 0  | 0   | 0  | 0    | 0    | 0    | 0    | 0    | 0    | 0   | 0    | 0    |
| 2008 | 0  | 0   | 0  | 0    | 0    | 0    | 0    | 0    | 0    | 0   | 0    | 0    |
| 2009 | 0  | 0   | 0  | 0    | 0    | 0    | 0    | 0    | 0    | 0   | 0    | 0    |
| 2010 | 0  | 0   | 0  | 0    | 0    | 0    | 0    | 0    | 0    | 0   | 0    | 0    |
| 2011 | 0  | 0   | 0  | 0    | 0    | 0    | 0    | 0    | 0    | 0   | 0    | 0    |
| 2012 | 0  | 0   | 0  | 0    | 0    | 0    | 0    | 0    | 0    | 0   | 0    | 0    |
| 2013 | 0  | 0   | 0  | 0    | 0    | 0    | 0    | 0    | 0    | 0   | 0    | 0    |
| 2014 | 0  | 0   | 0  | 0    | 0    | 0    | 0    | 0    | 0    | 0   | 0    | 0    |
| 2015 | 0  | 0   | 0  | 0    | 0    | 0    | 0    | 0    | 0    | 0   | 0    | 0    |
| 2016 | 0  | 0   | 0  | 0    | 0    | 0    | 0    | 0    | 0    | 0   | 0    | 0    |
| 2017 | 0  | 0   | 0  | 0    | 0    | 0    | 0    | 0    | 0    | 0   | 0    | 0    |
| 2018 | 0  | 0   | 0  | 0    | 0    | 0    | 0    | 0    | 0    | 0   | 0    | 0    |
| 2019 | 0  | 0   | 0  | 0    | 0    | 0    | 0    | 0    | 0    | 0   | 0    | 0    |
| 2020 | 0  | 0   | 0  | 0    | 0    | 0    | 0    | 0    | 0    | 0   | 0    | 0    |
| 2021 | 0  | 0   | 0  | 0    | 0    | 0    | 7    | 0    | 0    | 0   | 0    | 0    |
| 2022 | 0  | 0   | 0  | 0    | 0    | 0    | 74   | 0    | 0    | 0   | 0    | 0    |
| 2023 | 0  | 0   | 0  | 0    | 0    | 0    | 196  | 0    | 0    | 0   | 0    | 0    |
| 2024 | 0  | 0   | 0  | 0    | 0    | 0    | 332  | 0    | 0    | 0   | 0    | 0    |
| 2025 | 0  | 0   | 0  | 0    | 0    | 0    | 411  | 0    | 0    | 0   | 0    | 0    |
| 2026 | 0  | 0   | 0  | 15   | 15   | 0    | 554  | 13   | 6    | 0   | 2    | 15   |
| 2027 | 0  | 0   | 0  | 59   | 45   | 0    | 657  | 42   | 71   | 1   | 16   | 46   |
| 2028 | 0  | 0   | 0  | 156  | 127  | 0    | 777  | 77   | 135  | 6   | 36   | 132  |
| 2029 | 0  | 0   | 0  | 260  | 217  | 0    | 866  | 156  | 187  | 14  | 95   | 229  |
| 2030 | 0  | 0   | 0  | 372  | 329  | 0    | 983  | 233  | 242  | 14  | 155  | 341  |
| 2031 | 0  | 0   | 0  | 510  | 466  | 6    | 1068 | 374  | 319  | 15  | 239  | 479  |
| 2032 | 0  | 0   | 0  | 603  | 559  | 22   | 1142 | 481  | 391  | 25  | 309  | 570  |
| 2033 | 0  | 0   | 0  | 707  | 662  | 58   | 1195 | 634  | 495  | 27  | 418  | 672  |
| 2034 | 0  | 1   | 0  | 834  | 784  | 126  | 1254 | 804  | 594  | 32  | 558  | 797  |
| 2035 | 0  | 4   | 0  | 932  | 884  | 222  | 1316 | 952  | 697  | 40  | 668  | 900  |
| 2036 | 0  | 12  | 0  | 1053 | 1003 | 368  | 1361 | 1039 | 788  | 43  | 816  | 1019 |
| 2037 | 1  | 21  | 1  | 1144 | 1095 | 505  | 1430 | 1107 | 859  | 43  | 973  | 1111 |
| 2038 | 1  | 45  | 1  | 1215 | 1160 | 607  | 1481 | 1171 | 962  | 54  | 1179 | 1177 |
| 2039 | 1  | 76  | 1  | 1273 | 1222 | 681  | 1533 | 1253 | 1016 | 59  | 1378 | 1237 |
| 2040 | 2  | 112 | 2  | 1325 | 1281 | 781  | 1581 | 1334 | 1093 | 70  | 1604 | 1293 |
| 2041 | 3  | 166 | 3  | 1394 | 1349 | 878  | 1634 | 1404 | 1174 | 108 | 1806 | 1362 |
| 2042 | 4  | 241 | 7  | 1464 | 1438 | 999  | 1693 | 1467 | 1259 | 122 | 2019 | 1436 |
| 2043 | 4  | 301 | 13 | 1542 | 1512 | 1083 | 1772 | 1522 | 1321 | 142 | 2215 | 1511 |
| 2044 | 12 | 343 | 23 | 1599 | 1567 | 1176 | 1807 | 1568 | 1373 | 159 | 2376 | 1565 |
| 2045 | 12 | 418 | 35 | 1638 | 1609 | 1239 | 1860 | 1629 | 1439 | 177 | 2555 | 1604 |
| 2046 | 12 | 440 | 37 | 1732 | 1702 | 1322 | 1908 | 1695 | 1491 | 193 | 2744 | 1700 |
| 2047 | 12 | 483 | 43 | 1783 | 1743 | 1384 | 1943 | 1747 | 1556 | 211 | 2925 | 1758 |
| 2048 | 12 | 513 | 45 | 1859 | 1822 | 1480 | 1996 | 1839 | 1598 | 235 | 3124 | 1834 |
| 2049 | 12 | 532 | 49 | 1896 | 1858 | 1521 | 2033 | 1896 | 1654 | 256 | 3332 | 1869 |
| 2050 | 12 | 566 | 49 | 1960 | 1926 | 1573 | 2072 | 1959 | 1675 | 276 | 3474 | 1932 |
| 2051 | 12 | 591 | 49 | 1993 | 1965 | 1609 | 2112 | 2003 | 1700 | 291 | 3567 | 1974 |
| 2052 | 12 | 611 | 49 | 2033 | 2000 | 1661 | 2154 | 2037 | 1725 | 311 | 3670 | 2007 |
| 2053 | 12 | 627 | 49 | 2062 | 2033 | 1701 | 2189 | 2060 | 1737 | 324 | 3776 | 2033 |
| 2054 | 12 | 636 | 49 | 2081 | 2053 | 1737 | 2222 | 2086 | 1752 | 333 | 3865 | 2055 |
| 2055 | 12 | 641 | 49 | 2098 | 2077 | 1770 | 2268 | 2109 | 1763 | 334 | 3939 | 2071 |
| 2056 | 12 | 646 | 49 | 2113 | 2090 | 1778 | 2298 | 2156 | 1763 | 334 | 3993 | 2084 |
| 2057 | 12 | 653 | 49 | 2142 | 2121 | 1798 | 2338 | 2195 | 1763 | 334 | 4048 | 2112 |
| 2058 | 12 | 655 | 49 | 2160 | 2137 | 1801 | 2364 | 2211 | 1763 | 334 | 4136 | 2129 |
| 2059 | 12 | 657 | 49 | 2181 | 2157 | 1813 | 2385 | 2240 | 1763 | 334 | 4218 | 2148 |

|      | 61 | 62  | 63 | 64   | 65   | 66   | 67   | 68   | 69   | 70  | 71   | 72   |
|------|----|-----|----|------|------|------|------|------|------|-----|------|------|
| 2060 | 12 | 659 | 49 | 2195 | 2172 | 1817 | 2400 | 2261 | 1763 | 334 | 4250 | 2163 |
| 2061 | 12 | 659 | 49 | 2213 | 2188 | 1821 | 2405 | 2275 | 1763 | 334 | 4298 | 2180 |
| 2062 | 12 | 659 | 49 | 2233 | 2211 | 1838 | 2405 | 2295 | 1763 | 334 | 4352 | 2200 |
| 2063 | 12 | 659 | 49 | 2239 | 2219 | 1850 | 2405 | 2309 | 1763 | 334 | 4408 | 2206 |
| 2064 | 12 | 659 | 49 | 2242 | 2229 | 1860 | 2405 | 2333 | 1763 | 334 | 4431 | 2210 |
| 2065 | 12 | 659 | 49 | 2242 | 2229 | 1861 | 2405 | 2346 | 1763 | 334 | 4462 | 2210 |
| 2066 | 12 | 659 | 49 | 2242 | 2229 | 1861 | 2405 | 2359 | 1763 | 334 | 4480 | 2210 |
| 2067 | 12 | 659 | 49 | 2242 | 2229 | 1861 | 2405 | 2370 | 1763 | 334 | 4496 | 2210 |
| 2068 | 12 | 659 | 49 | 2242 | 2229 | 1861 | 2405 | 2371 | 1763 | 334 | 4510 | 2210 |
| 2069 | 12 | 659 | 49 | 2242 | 2229 | 1861 | 2405 | 2371 | 1763 | 334 | 4526 | 2210 |
| 2070 | 12 | 659 | 49 | 2242 | 2229 | 1861 | 2405 | 2371 | 1763 | 334 | 4551 | 2210 |
| 2071 | 12 | 659 | 49 | 2242 | 2229 | 1861 | 2405 | 2371 | 1763 | 334 | 4569 | 2210 |
| 2072 | 12 | 659 | 49 | 2242 | 2229 | 1861 | 2405 | 2371 | 1763 | 334 | 4586 | 2210 |
| 2073 | 12 | 659 | 49 | 2242 | 2229 | 1861 | 2405 | 2371 | 1763 | 334 | 4603 | 2210 |
| 2074 | 12 | 659 | 49 | 2242 | 2229 | 1861 | 2405 | 2371 | 1763 | 334 | 4619 | 2210 |
| 2075 | 12 | 659 | 49 | 2242 | 2229 | 1861 | 2405 | 2371 | 1763 | 334 | 4637 | 2210 |
| 2076 | 12 | 659 | 49 | 2242 | 2229 | 1861 | 2405 | 2371 | 1763 | 334 | 4644 | 2210 |
| 2077 | 12 | 659 | 49 | 2242 | 2229 | 1861 | 2405 | 2371 | 1763 | 334 | 4648 | 2210 |
| 2078 | 12 | 659 | 49 | 2242 | 2229 | 1861 | 2405 | 2371 | 1763 | 334 | 4648 | 2210 |
| 2079 | 12 | 659 | 49 | 2242 | 2229 | 1861 | 2405 | 2371 | 1763 | 334 | 4648 | 2210 |
| 2080 | 12 | 659 | 49 | 2242 | 2229 | 1861 | 2405 | 2371 | 1763 | 334 | 4648 | 2210 |
| 2081 | 12 | 659 | 49 | 2242 | 2229 | 1861 | 2405 | 2371 | 1763 | 334 | 4648 | 2210 |
| 2082 | 12 | 659 | 49 | 2242 | 2229 | 1861 | 2405 | 2371 | 1763 | 334 | 4648 | 2210 |
| 2083 | 12 | 659 | 49 | 2242 | 2229 | 1861 | 2405 | 2371 | 1763 | 334 | 4648 | 2210 |
| 2084 | 12 | 659 | 49 | 2242 | 2229 | 1861 | 2405 | 2371 | 1763 | 334 | 4648 | 2210 |
| 2085 | 12 | 659 | 49 | 2242 | 2229 | 1861 | 2405 | 2371 | 1763 | 334 | 4648 | 2210 |
| 2086 | 12 | 659 | 49 | 2242 | 2229 | 1861 | 2405 | 2371 | 1763 | 334 | 4648 | 2210 |
| 2087 | 12 | 659 | 49 | 2242 | 2229 | 1861 | 2405 | 2371 | 1763 | 334 | 4648 | 2210 |
| 2088 | 12 | 659 | 49 | 2242 | 2229 | 1861 | 2405 | 2371 | 1763 | 334 | 4648 | 2210 |
| 2089 | 12 | 659 | 49 | 2242 | 2229 | 1861 | 2405 | 2371 | 1763 | 334 | 4648 | 2210 |
| 2090 | 12 | 659 | 49 | 2242 | 2229 | 1861 | 2405 | 2371 | 1763 | 334 | 4648 | 2210 |

|      | 73   | 74   | 75   | 76   | 77   | 78   | 79   | 80   | 81   | 82 | 83 | 84 |
|------|------|------|------|------|------|------|------|------|------|----|----|----|
| 2002 | 0    | 0    | 0    | 0    | 0    | 0    | 0    | 0    | 0    | 0  | 0  | 0  |
| 2003 | 0    | 0    | 0    | 0    | 0    | 0    | 0    | 0    | 0    | 0  | 0  | 0  |
| 2004 | 0    | 0    | 0    | 0    | 0    | 0    | 0    | 0    | 0    | 0  | 0  | 0  |
| 2005 | 0    | 0    | 0    | 0    | 0    | 0    | 0    | 0    | 0    | 0  | 0  | 0  |
| 2006 | 0    | 0    | 0    | 0    | 0    | 0    | 0    | 0    | 0    | 0  | 0  | 0  |
| 2007 | 0    | 0    | 0    | 0    | 0    | 0    | 0    | 0    | 0    | 0  | 0  | 0  |
| 2008 | 0    | 0    | 0    | 0    | 0    | 0    | 0    | 0    | 0    | 0  | 0  | 0  |
| 2009 | 0    | 0    | 0    | 0    | 0    | 0    | 0    | 0    | 0    | 0  | 0  | 0  |
| 2010 | 0    | 0    | 0    | 0    | 0    | 0    | 0    | 0    | 0    | 0  | 0  | 0  |
| 2011 | 0    | 0    | 0    | 0    | 0    | 0    | 0    | 0    | 0    | 0  | 0  | 0  |
| 2012 | 0    | 0    | 0    | 0    | 0    | 0    | 0    | 0    | 0    | 0  | 0  | 0  |
| 2013 | 0    | 0    | 0    | 0    | 0    | 0    | 0    | 0    | 0    | 0  | 0  | 0  |
| 2014 | 0    | 0    | 0    | 0    | 0    | 0    | 0    | 0    | 0    | 0  | 0  | 0  |
| 2015 | 0    | 0    | 0    | 0    | 0    | 0    | 0    | 0    | 0    | 0  | 0  | 0  |
| 2016 | 0    | 0    | 0    | 0    | 0    | 0    | 0    | 0    | 0    | 0  | 0  | 0  |
| 2017 | 0    | 0    | 0    | 0    | 0    | 0    | 0    | 0    | 0    | 0  | 0  | 0  |
| 2018 | 0    | 0    | 0    | 0    | 0    | 0    | 0    | 0    | 0    | 0  | 0  | 0  |
| 2019 | 0    | 0    | 0    | 0    | 0    | 0    | 0    | 0    | 0    | 0  | 0  | 0  |
| 2020 | 0    | 0    | 0    | 0    | 0    | 0    | 0    | 0    | 0    | 0  | 0  | 0  |
| 2021 | 0    | 0    | 0    | 3    | 0    | 0    | 0    | 0    | 0    | 0  | 0  | 0  |
| 2022 | 0    | 0    | 0    | 39   | 0    | 0    | 0    | 0    | 0    | 0  | 0  | 0  |
| 2023 | 0    | 0    | 0    | 102  | 0    | 0    | 0    | 0    | 0    | 0  | 0  | 0  |
| 2024 | 0    | 0    | 0    | 208  | 0    | 0    | 0    | 0    | 0    | 0  | 0  | 0  |
| 2025 | 0    | 0    | 0    | 337  | 0    | 0    | 0    | 0    | 0    | 0  | 0  | 0  |
| 2026 | 1    | 1    | 0    | 466  | 0    | 15   | 40   | 1    | 1    | 0  | 0  | 0  |
| 2027 | 23   | 22   | 0    | 642  | 39   | 59   | 136  | 3    | 25   | 0  | 0  | 0  |
| 2028 | 72   | 63   | 0    | 867  | 75   | 147  | 261  | 7    | 75   | 0  | 0  | 0  |
| 2029 | 153  | 124  | 0    | 1036 | 118  | 261  | 390  | 10   | 145  | 0  | 0  | 0  |
| 2030 | 252  | 205  | 0    | 1243 | 220  | 371  | 488  | 18   | 236  | 0  | 0  | 0  |
| 2031 | 375  | 318  | 8    | 1415 | 319  | 493  | 661  | 34   | 351  | 0  | 0  | 0  |
| 2032 | 545  | 484  | 39   | 1613 | 400  | 567  | 788  | 82   | 518  | 0  | 0  | 0  |
| 2033 | 689  | 621  | 66   | 1820 | 548  | 691  | 896  | 159  | 656  | 0  | 0  | 0  |
| 2034 | 908  | 844  | 145  | 2053 | 731  | 836  | 1003 | 224  | 879  | 0  | 0  | 0  |
| 2035 | 1109 | 1031 | 230  | 2268 | 872  | 975  | 1110 | 300  | 1075 | 0  | 0  | 0  |
| 2036 | 1295 | 1222 | 331  | 2468 | 1059 | 1080 | 1227 | 397  | 1263 | 0  | 0  | 0  |
| 2037 | 1484 | 1409 | 443  | 2660 | 1346 | 1210 | 1333 | 512  | 1447 | 1  | 1  | 0  |
| 2038 | 1730 | 1654 | 588  | 2836 | 1564 | 1340 | 1412 | 606  | 1689 | 1  | 1  | 0  |
| 2039 | 1944 | 1871 | 765  | 3017 | 1830 | 1488 | 1474 | 758  | 1901 | 1  | 1  | 0  |
| 2040 | 2126 | 2051 | 979  | 3202 | 2090 | 1632 | 1558 | 890  | 2083 | 2  | 2  | 0  |
| 2041 | 2328 | 2254 | 1187 | 3409 | 2381 | 1766 | 1636 | 1066 | 2294 | 2  | 2  | 0  |
| 2042 | 2518 | 2446 | 1350 | 3620 | 2616 | 1916 | 1720 | 1251 | 2491 | 7  | 7  | 0  |
| 2043 | 2741 | 2655 | 1496 | 3802 | 2842 | 2082 | 1781 | 1462 | 2708 | 15 | 15 | 0  |
| 2044 | 2909 | 2830 | 1658 | 3924 | 3071 | 2220 | 1861 | 1670 | 2877 | 22 | 22 | 0  |
| 2045 | 3103 | 3031 | 1909 | 4037 | 3328 | 2304 | 1910 | 1961 | 3069 | 34 | 34 | 0  |
| 2046 | 3265 | 3203 | 2074 | 4172 | 3563 | 2386 | 1970 | 2238 | 3227 | 47 | 47 | 1  |
| 2047 | 3394 | 3317 | 2274 | 4284 | 3776 | 2493 | 1997 | 2527 | 3351 | 58 | 58 | 4  |
| 2048 | 3533 | 3469 | 2485 | 4349 | 3937 | 2539 | 2028 | 2714 | 3492 | 64 | 64 | 5  |
| 2049 | 3610 | 3554 | 2665 | 4377 | 4049 | 2593 | 2046 | 2929 | 3565 | 68 | 68 | 5  |
| 2050 | 3696 | 3632 | 2775 | 4401 | 4124 | 2646 | 2052 | 3164 | 3644 | 68 | 68 | 5  |
| 2051 | 3760 | 3689 | 2866 | 4431 | 4203 | 2673 | 2056 | 3373 | 3706 | 68 | 68 | 5  |
| 2052 | 3788 | 3716 | 2948 | 4447 | 4291 | 2695 | 2061 | 3558 | 3733 | 68 | 68 | 5  |
| 2053 | 3819 | 3752 | 2999 | 4459 | 4367 | 2702 | 2061 | 3799 | 3768 | 68 | 68 | 5  |
| 2054 | 3849 | 3780 | 3063 | 4473 | 4425 | 2713 | 2061 | 3950 | 3799 | 68 | 68 | 5  |
| 2055 | 3861 | 3792 | 3098 | 4488 | 4484 | 2716 | 2061 | 4106 | 3815 | 68 | 68 | 5  |
| 2056 | 3885 | 3816 | 3136 | 4501 | 4492 | 2716 | 2061 | 4221 | 3840 | 68 | 68 | 5  |
| 2057 | 3899 | 3832 | 3158 | 4516 | 4516 | 2716 | 2061 | 4366 | 3855 | 68 | 68 | 5  |
| 2058 | 3904 | 3836 | 3179 | 4525 | 4530 | 2716 | 2061 | 4449 | 3860 | 68 | 68 | 5  |
| 2059 | 3909 | 3843 | 3184 | 4532 | 4537 | 2716 | 2061 | 4536 | 3867 | 68 | 68 | 5  |

|      | 73   | 74   | 75   | 76   | 77   | 78   | 79   | 80   | 81   | 82 | 83 | 84 |
|------|------|------|------|------|------|------|------|------|------|----|----|----|
| 2060 | 3910 | 3845 | 3185 | 4533 | 4551 | 2716 | 2061 | 4626 | 3870 | 68 | 68 | 5  |
| 2061 | 3914 | 3848 | 3187 | 4533 | 4556 | 2716 | 2061 | 4708 | 3873 | 68 | 68 | 5  |
| 2062 | 3917 | 3851 | 3188 | 4533 | 4561 | 2716 | 2061 | 4770 | 3876 | 68 | 68 | 5  |
| 2063 | 3917 | 3851 | 3189 | 4533 | 4563 | 2716 | 2061 | 4829 | 3876 | 68 | 68 | 5  |
| 2064 | 3917 | 3851 | 3189 | 4533 | 4567 | 2716 | 2061 | 4859 | 3876 | 68 | 68 | 5  |
| 2065 | 3917 | 3851 | 3189 | 4533 | 4568 | 2716 | 2061 | 4899 | 3876 | 68 | 68 | 5  |
| 2066 | 3917 | 3851 | 3189 | 4533 | 4570 | 2716 | 2061 | 4922 | 3876 | 68 | 68 | 5  |
| 2067 | 3917 | 3851 | 3189 | 4533 | 4570 | 2716 | 2061 | 4935 | 3876 | 68 | 68 | 5  |
| 2068 | 3917 | 3851 | 3189 | 4533 | 4570 | 2716 | 2061 | 4968 | 3876 | 68 | 68 | 5  |
| 2069 | 3917 | 3851 | 3189 | 4533 | 4570 | 2716 | 2061 | 4978 | 3876 | 68 | 68 | 5  |
| 2070 | 3917 | 3851 | 3189 | 4533 | 4570 | 2716 | 2061 | 4988 | 3876 | 68 | 68 | 5  |
| 2071 | 3917 | 3851 | 3189 | 4533 | 4570 | 2716 | 2061 | 4994 | 3876 | 68 | 68 | 5  |
| 2072 | 3917 | 3851 | 3189 | 4533 | 4570 | 2716 | 2061 | 5000 | 3876 | 68 | 68 | 5  |
| 2073 | 3917 | 3851 | 3189 | 4533 | 4570 | 2716 | 2061 | 5003 | 3876 | 68 | 68 | 5  |
| 2074 | 3917 | 3851 | 3189 | 4533 | 4570 | 2716 | 2061 | 5005 | 3876 | 68 | 68 | 5  |
| 2075 | 3917 | 3851 | 3189 | 4533 | 4570 | 2716 | 2061 | 5009 | 3876 | 68 | 68 | 5  |
| 2076 | 3917 | 3851 | 3189 | 4533 | 4570 | 2716 | 2061 | 5009 | 3876 | 68 | 68 | 5  |
| 2077 | 3917 | 3851 | 3189 | 4533 | 4570 | 2716 | 2061 | 5009 | 3876 | 68 | 68 | 5  |
| 2078 | 3917 | 3851 | 3189 | 4533 | 4570 | 2716 | 2061 | 5009 | 3876 | 68 | 68 | 5  |
| 2079 | 3917 | 3851 | 3189 | 4533 | 4570 | 2716 | 2061 | 5009 | 3876 | 68 | 68 | 5  |
| 2080 | 3917 | 3851 | 3189 | 4533 | 4570 | 2716 | 2061 | 5009 | 3876 | 68 | 68 | 5  |
| 2081 | 3917 | 3851 | 3189 | 4533 | 4570 | 2716 | 2061 | 5009 | 3876 | 68 | 68 | 5  |
| 2082 | 3917 | 3851 | 3189 | 4533 | 4570 | 2716 | 2061 | 5009 | 3876 | 68 | 68 | 5  |
| 2083 | 3917 | 3851 | 3189 | 4533 | 4570 | 2716 | 2061 | 5009 | 3876 | 68 | 68 | 5  |
| 2084 | 3917 | 3851 | 3189 | 4533 | 4570 | 2716 | 2061 | 5009 | 3876 | 68 | 68 | 5  |
| 2085 | 3917 | 3851 | 3189 | 4533 | 4570 | 2716 | 2061 | 5009 | 3876 | 68 | 68 | 5  |
| 2086 | 3917 | 3851 | 3189 | 4533 | 4570 | 2716 | 2061 | 5009 | 3876 | 68 | 68 | 5  |
| 2087 | 3917 | 3851 | 3189 | 4533 | 4570 | 2716 | 2061 | 5009 | 3876 | 68 | 68 | 5  |
| 2088 | 3917 | 3851 | 3189 | 4533 | 4570 | 2716 | 2061 | 5009 | 3876 | 68 | 68 | 5  |
| 2089 | 3917 | 3851 | 3189 | 4533 | 4570 | 2716 | 2061 | 5009 | 3876 | 68 | 68 | 5  |
| 2090 | 3917 | 3851 | 3189 | 4533 | 4570 | 2716 | 2061 | 5009 | 3876 | 68 | 68 | 5  |

|      | 85  | 86  | 87  | 88 | 89  | 90 | 91   | 92   | 93   | 94   | 95   | 96   |
|------|-----|-----|-----|----|-----|----|------|------|------|------|------|------|
| 2002 | 0   | 0   | 0   | 0  | 0   | 0  | 0    | 0    | 0    | 0    | 0    | 0    |
| 2003 | 0   | 0   | 0   | 0  | 0   | 0  | 0    | 0    | 0    | 0    | 0    | 0    |
| 2004 | 0   | 0   | 0   | 0  | 0   | 0  | 0    | 0    | 0    | 0    | 0    | 0    |
| 2005 | 0   | 0   | 0   | 0  | 0   | 0  | 0    | 0    | 0    | 0    | 0    | 0    |
| 2006 | 0   | 0   | 0   | 0  | 0   | 0  | 0    | 0    | 0    | 0    | 0    | 0    |
| 2007 | 0   | 0   | 0   | 0  | 0   | 0  | 0    | 0    | 0    | 0    | 0    | 0    |
| 2008 | 0   | 0   | 0   | 0  | 0   | 0  | 0    | 0    | 0    | 0    | 0    | 0    |
| 2009 | 0   | 0   | 0   | 0  | 0   | 0  | 0    | 0    | 0    | 0    | 0    | 0    |
| 2010 | 0   | 0   | 0   | 0  | 0   | 0  | 0    | 0    | 0    | 0    | 0    | 0    |
| 2011 | 0   | 0   | 0   | 0  | 0   | 0  | 0    | 0    | 0    | 0    | 0    | 0    |
| 2012 | 0   | 0   | 0   | 0  | 0   | 0  | 0    | 0    | 0    | 0    | 0    | 0    |
| 2013 | 0   | 0   | 0   | 0  | 0   | 0  | 0    | 0    | 0    | 0    | 0    | 0    |
| 2014 | 0   | 0   | 0   | 0  | 0   | 0  | 0    | 0    | 0    | 0    | 0    | 0    |
| 2015 | 0   | 0   | 0   | 0  | 0   | 0  | 0    | 0    | 0    | 0    | 0    | 0    |
| 2016 | 0   | 0   | 0   | 0  | 0   | 0  | 0    | 0    | 0    | 0    | 0    | 0    |
| 2017 | 0   | 0   | 0   | 0  | 0   | 0  | 0    | 0    | 0    | 0    | 0    | 0    |
| 2018 | 0   | 0   | 0   | 0  | 0   | 0  | 0    | 0    | 0    | 0    | 0    | 0    |
| 2019 | 0   | 0   | 0   | 0  | 0   | 0  | 0    | 0    | 0    | 0    | 0    | 0    |
| 2020 | 0   | 0   | 0   | 0  | 0   | 0  | 0    | 0    | 0    | 0    | 0    | 0    |
| 2021 | 0   | 0   | 0   | 0  | 0   | 0  | 0    | 0    | 0    | 7    | 0    | 0    |
| 2022 | 0   | 0   | 0   | 0  | 0   | 0  | 0    | 0    | 0    | 72   | 0    | 0    |
| 2023 | 0   | 0   | 0   | 0  | 0   | 0  | 0    | 0    | 0    | 189  | 0    | 0    |
| 2024 | 0   | 0   | 0   | 0  | 0   | 0  | 0    | 0    | 0    | 319  | 0    | 0    |
| 2025 | 0   | 0   | 0   | 0  | 0   | 0  | 0    | 0    | 0    | 394  | 0    | 0    |
| 2026 | 0   | 0   | 0   | 0  | 0   | 0  | 15   | 15   | 0    | 543  | 13   | 6    |
| 2027 | 0   | 0   | 0   | 0  | 0   | 0  | 48   | 45   | 0    | 639  | 34   | 71   |
| 2028 | 0   | 0   | 0   | 0  | 0   | 0  | 135  | 127  | 0    | 767  | 65   | 132  |
| 2029 | 0   | 0   | 0   | 0  | 0   | 0  | 228  | 216  | 0    | 859  | 135  | 182  |
| 2030 | 0   | 0   | 0   | 0  | 0   | 0  | 340  | 326  | 0    | 976  | 200  | 236  |
| 2031 | 1   | 0   | 0   | 0  | 0   | 0  | 477  | 463  | 6    | 1063 | 330  | 316  |
| 2032 | 1   | 0   | 0   | 0  | 0   | 0  | 570  | 556  | 22   | 1138 | 434  | 388  |
| 2033 | 1   | 0   | 0   | 0  | 0   | 0  | 673  | 659  | 57   | 1193 | 584  | 493  |
| 2034 | 1   | 0   | 0   | 0  | 1   | 0  | 795  | 781  | 121  | 1251 | 755  | 593  |
| 2035 | 6   | 0   | 0   | 0  | 2   | 0  | 892  | 878  | 214  | 1313 | 897  | 689  |
| 2036 | 8   | 0   | 0   | 0  | 8   | 0  | 1009 | 995  | 357  | 1357 | 988  | 786  |
| 2037 | 25  | 1   | 1   | 1  | 15  | 1  | 1105 | 1091 | 490  | 1434 | 1057 | 858  |
| 2038 | 36  | 2   | 1   | 1  | 38  | 1  | 1164 | 1150 | 593  | 1480 | 1125 | 957  |
| 2039 | 60  | 4   | 4   | 1  | 66  | 1  | 1227 | 1213 | 668  | 1510 | 1204 | 1005 |
| 2040 | 78  | 6   | 4   | 2  | 101 | 2  | 1287 | 1273 | 768  | 1554 | 1286 | 1087 |
| 2041 | 127 | 8   | 7   | 2  | 151 | 2  | 1351 | 1337 | 860  | 1606 | 1352 | 1175 |
| 2042 | 152 | 11  | 14  | 4  | 229 | 7  | 1439 | 1425 | 979  | 1655 | 1416 | 1259 |
| 2043 | 181 | 23  | 22  | 4  | 289 | 15 | 1523 | 1509 | 1060 | 1721 | 1461 | 1330 |
| 2044 | 207 | 45  | 39  | 7  | 328 | 22 | 1570 | 1556 | 1154 | 1750 | 1504 | 1381 |
| 2045 | 229 | 71  | 65  | 7  | 405 | 34 | 1611 | 1597 | 1219 | 1785 | 1567 | 1447 |
| 2046 | 248 | 89  | 84  | 7  | 427 | 47 | 1696 | 1682 | 1301 | 1837 | 1632 | 1494 |
| 2047 | 270 | 103 | 99  | 7  | 471 | 58 | 1727 | 1713 | 1368 | 1883 | 1689 | 1560 |
| 2048 | 281 | 104 | 103 | 7  | 502 | 64 | 1790 | 1776 | 1465 | 1952 | 1782 | 1618 |
| 2049 | 287 | 108 | 107 | 7  | 524 | 68 | 1828 | 1814 | 1499 | 2000 | 1826 | 1671 |
| 2050 | 295 | 108 | 107 | 7  | 559 | 68 | 1882 | 1868 | 1553 | 2047 | 1898 | 1691 |
| 2051 | 295 | 108 | 107 | 7  | 588 | 68 | 1922 | 1908 | 1603 | 2088 | 1941 | 1720 |
| 2052 | 295 | 108 | 107 | 7  | 613 | 68 | 1963 | 1949 | 1661 | 2147 | 1979 | 1744 |
| 2053 | 295 | 108 | 107 | 7  | 633 | 68 | 2002 | 1988 | 1701 | 2190 | 2006 | 1756 |
| 2054 | 295 | 108 | 107 | 7  | 649 | 68 | 2030 | 2016 | 1737 | 2238 | 2035 | 1770 |
| 2055 | 295 | 108 | 107 | 7  | 659 | 68 | 2059 | 2045 | 1779 | 2291 | 2056 | 1781 |
| 2056 | 295 | 108 | 107 | 7  | 668 | 68 | 2069 | 2055 | 1788 | 2333 | 2097 | 1781 |
| 2057 | 295 | 108 | 107 | 7  | 682 | 68 | 2102 | 2088 | 1815 | 2384 | 2133 | 1781 |
| 2058 | 295 | 108 | 107 | 7  | 689 | 68 | 2119 | 2105 | 1818 | 2427 | 2149 | 1781 |
| 2059 | 295 | 108 | 107 | 7  | 696 | 68 | 2139 | 2125 | 1831 | 2461 | 2180 | 1781 |

|      | 85  | 86  | 87  | 88 | 89  | 90 | 91   | 92   | 93   | 94   | 95   | 96   |
|------|-----|-----|-----|----|-----|----|------|------|------|------|------|------|
| 2060 | 295 | 108 | 107 | 7  | 697 | 68 | 2158 | 2144 | 1837 | 2496 | 2207 | 1781 |
| 2061 | 295 | 108 | 107 | 7  | 697 | 68 | 2179 | 2165 | 1844 | 2528 | 2228 | 1781 |
| 2062 | 295 | 108 | 107 | 7  | 697 | 68 | 2205 | 2191 | 1861 | 2556 | 2248 | 1781 |
| 2063 | 295 | 108 | 107 | 7  | 697 | 68 | 2217 | 2203 | 1871 | 2560 | 2270 | 1781 |
| 2064 | 295 | 108 | 107 | 7  | 697 | 68 | 2230 | 2216 | 1880 | 2560 | 2294 | 1781 |
| 2065 | 295 | 108 | 107 | 7  | 697 | 68 | 2230 | 2216 | 1881 | 2560 | 2310 | 1781 |
| 2066 | 295 | 108 | 107 | 7  | 697 | 68 | 2230 | 2216 | 1881 | 2560 | 2326 | 1781 |
| 2067 | 295 | 108 | 107 | 7  | 697 | 68 | 2230 | 2216 | 1881 | 2560 | 2335 | 1781 |
| 2068 | 295 | 108 | 107 | 7  | 697 | 68 | 2230 | 2216 | 1881 | 2560 | 2337 | 1781 |
| 2069 | 295 | 108 | 107 | 7  | 697 | 68 | 2230 | 2216 | 1881 | 2560 | 2337 | 1781 |
| 2070 | 295 | 108 | 107 | 7  | 697 | 68 | 2230 | 2216 | 1881 | 2560 | 2337 | 1781 |
| 2071 | 295 | 108 | 107 | 7  | 697 | 68 | 2230 | 2216 | 1881 | 2560 | 2337 | 1781 |
| 2072 | 295 | 108 | 107 | 7  | 697 | 68 | 2230 | 2216 | 1881 | 2560 | 2337 | 1781 |
| 2073 | 295 | 108 | 107 | 7  | 697 | 68 | 2230 | 2216 | 1881 | 2560 | 2337 | 1781 |
| 2074 | 295 | 108 | 107 | 7  | 697 | 68 | 2230 | 2216 | 1881 | 2560 | 2337 | 1781 |
| 2075 | 295 | 108 | 107 | 7  | 697 | 68 | 2230 | 2216 | 1881 | 2560 | 2337 | 1781 |
| 2076 | 295 | 108 | 107 | 7  | 697 | 68 | 2230 | 2216 | 1881 | 2560 | 2337 | 1781 |
| 2077 | 295 | 108 | 107 | 7  | 697 | 68 | 2230 | 2216 | 1881 | 2560 | 2337 | 1781 |
| 2078 | 295 | 108 | 107 | 7  | 697 | 68 | 2230 | 2216 | 1881 | 2560 | 2337 | 1781 |
| 2079 | 295 | 108 | 107 | 7  | 697 | 68 | 2230 | 2216 | 1881 | 2560 | 2337 | 1781 |
| 2080 | 295 | 108 | 107 | 7  | 697 | 68 | 2230 | 2216 | 1881 | 2560 | 2337 | 1781 |
| 2081 | 295 | 108 | 107 | 7  | 697 | 68 | 2230 | 2216 | 1881 | 2560 | 2337 | 1781 |
| 2082 | 295 | 108 | 107 | 7  | 697 | 68 | 2230 | 2216 | 1881 | 2560 | 2337 | 1781 |
| 2083 | 295 | 108 | 107 | 7  | 697 | 68 | 2230 | 2216 | 1881 | 2560 | 2337 | 1781 |
| 2084 | 295 | 108 | 107 | 7  | 697 | 68 | 2230 | 2216 | 1881 | 2560 | 2337 | 1781 |
| 2085 | 295 | 108 | 107 | 7  | 697 | 68 | 2230 | 2216 | 1881 | 2560 | 2337 | 1781 |
| 2086 | 295 | 108 | 107 | 7  | 697 | 68 | 2230 | 2216 | 1881 | 2560 | 2337 | 1781 |
| 2087 | 295 | 108 | 107 | 7  | 697 | 68 | 2230 | 2216 | 1881 | 2560 | 2337 | 1781 |
| 2088 | 295 | 108 | 107 | 7  | 697 | 68 | 2230 | 2216 | 1881 | 2560 | 2337 | 1781 |
| 2089 | 295 | 108 | 107 | 7  | 697 | 68 | 2230 | 2216 | 1881 | 2560 | 2337 | 1781 |
| 2090 | 295 | 108 | 107 | 7  | 697 | 68 | 2230 | 2216 | 1881 | 2560 | 2337 | 1781 |

|      | 97  | 98   | 99   | 100  | 101  | 102  | 103  | 104  | 105  | 106  | 107  | 108  |
|------|-----|------|------|------|------|------|------|------|------|------|------|------|
| 2002 | 0   | 0    | 0    | 0    | 0    | 0    | 0    | 0    | 0    | 0    | 0    | 0    |
| 2003 | 0   | 0    | 0    | 0    | 0    | 0    | 0    | 0    | 0    | 0    | 0    | 0    |
| 2004 | 0   | 0    | 0    | 0    | 0    | 0    | 0    | 0    | 0    | 0    | 0    | 0    |
| 2005 | 0   | 0    | 0    | 0    | 0    | 0    | 0    | 0    | 0    | 0    | 0    | 0    |
| 2006 | 0   | 0    | 0    | 0    | 0    | 0    | 0    | 0    | 0    | 0    | 0    | 0    |
| 2007 | 0   | 0    | 0    | 0    | 0    | 0    | 0    | 0    | 0    | 0    | 0    | 0    |
| 2008 | 0   | 0    | 0    | 0    | 0    | 0    | 0    | 0    | 0    | 0    | 0    | 0    |
| 2009 | 0   | 0    | 0    | 0    | 0    | 0    | 0    | 0    | 0    | 0    | 0    | 0    |
| 2010 | 0   | 0    | 0    | 0    | 0    | 0    | 0    | 0    | 0    | 0    | 0    | 0    |
| 2011 | 0   | 0    | 0    | 0    | 0    | 0    | 0    | 0    | 0    | 0    | 0    | 0    |
| 2012 | 0   | 0    | 0    | 0    | 0    | 0    | 0    | 0    | 0    | 0    | 0    | 0    |
| 2013 | 0   | 0    | 0    | 0    | 0    | 0    | 0    | 0    | 0    | 0    | 0    | 0    |
| 2014 | 0   | 0    | 0    | 0    | 0    | 0    | 0    | 0    | 0    | 0    | 0    | 0    |
| 2015 | 0   | 0    | 0    | 0    | 0    | 0    | 0    | 0    | 0    | 0    | 0    | 0    |
| 2016 | 0   | 0    | 0    | 0    | 0    | 0    | 0    | 0    | 0    | 0    | 0    | 0    |
| 2017 | 0   | 0    | 0    | 0    | 0    | 0    | 0    | 0    | 0    | 0    | 0    | 0    |
| 2018 | 0   | 0    | 0    | 0    | 0    | 0    | 0    | 0    | 0    | 0    | 0    | 0    |
| 2019 | 0   | 0    | 0    | 0    | 0    | 0    | 0    | 0    | 0    | 0    | 0    | 0    |
| 2020 | 0   | 0    | 0    | 0    | 0    | 0    | 0    | 0    | 0    | 0    | 0    | 0    |
| 2021 | 0   | 0    | 0    | 0    | 0    | 0    | 3    | 0    | 0    | 0    | 0    | 0    |
| 2022 | 0   | 0    | 0    | 0    | 0    | 0    | 39   | 0    | 0    | 0    | 0    | 0    |
| 2023 | 0   | 0    | 0    | 0    | 0    | 0    | 83   | 0    | 0    | 0    | 0    | 0    |
| 2024 | 0   | 0    | 0    | 0    | 0    | 0    | 174  | 0    | 0    | 0    | 0    | 0    |
| 2025 | 0   | 0    | 0    | 0    | 0    | 0    | 276  | 0    | 0    | 0    | 0    | 0    |
| 2026 | 0   | 2    | 15   | 1    | 1    | 0    | 404  | 0    | 15   | 40   | 1    | 1    |
| 2027 | 1   | 12   | 45   | 21   | 22   | 0    | 578  | 31   | 59   | 136  | 3    | 23   |
| 2028 | 4   | 27   | 127  | 59   | 59   | 0    | 797  | 57   | 139  | 261  | 7    | 66   |
| 2029 | 12  | 76   | 216  | 129  | 120  | 0    | 964  | 95   | 244  | 389  | 10   | 128  |
| 2030 | 12  | 126  | 327  | 216  | 194  | 0    | 1168 | 192  | 354  | 486  | 18   | 207  |
| 2031 | 13  | 198  | 464  | 326  | 296  | 8    | 1330 | 280  | 469  | 661  | 33   | 312  |
| 2032 | 22  | 248  | 557  | 494  | 461  | 39   | 1532 | 359  | 542  | 785  | 75   | 479  |
| 2033 | 24  | 336  | 660  | 627  | 596  | 63   | 1747 | 506  | 651  | 890  | 150  | 614  |
| 2034 | 29  | 469  | 782  | 840  | 809  | 133  | 1989 | 659  | 799  | 997  | 215  | 827  |
| 2035 | 38  | 574  | 879  | 1030 | 999  | 203  | 2201 | 806  | 929  | 1103 | 285  | 1017 |
| 2036 | 41  | 699  | 996  | 1220 | 1189 | 296  | 2394 | 993  | 1033 | 1216 | 379  | 1207 |
| 2037 | 41  | 858  | 1092 | 1403 | 1372 | 402  | 2587 | 1278 | 1158 | 1323 | 490  | 1390 |
| 2038 | 53  | 1048 | 1151 | 1656 | 1625 | 538  | 2768 | 1500 | 1286 | 1405 | 580  | 1643 |
| 2039 | 58  | 1248 | 1214 | 1866 | 1835 | 707  | 2945 | 1753 | 1438 | 1465 | 729  | 1853 |
| 2040 | 69  | 1478 | 1274 | 2040 | 2009 | 919  | 3131 | 2007 | 1582 | 1545 | 864  | 2027 |
| 2041 | 107 | 1682 | 1338 | 2247 | 2216 | 1127 | 3330 | 2296 | 1722 | 1626 | 1040 | 2234 |
| 2042 | 123 | 1890 | 1426 | 2436 | 2405 | 1282 | 3519 | 2524 | 1889 | 1717 | 1213 | 2423 |
| 2043 | 144 | 2102 | 1510 | 2648 | 2617 | 1429 | 3705 | 2756 | 2048 | 1784 | 1412 | 2635 |
| 2044 | 163 | 2266 | 1557 | 2820 | 2789 | 1591 | 3830 | 2974 | 2186 | 1860 | 1624 | 2807 |
| 2045 | 179 | 2450 | 1598 | 3020 | 2989 | 1821 | 3958 | 3239 | 2283 | 1905 | 1918 | 3007 |
| 2046 | 194 | 2629 | 1683 | 3183 | 3152 | 1968 | 4081 | 3461 | 2369 | 1965 | 2197 | 3170 |
| 2047 | 210 | 2813 | 1714 | 3308 | 3277 | 2161 | 4218 | 3677 | 2474 | 1993 | 2487 | 3295 |
| 2048 | 243 | 3000 | 1777 | 3453 | 3422 | 2376 | 4297 | 3851 | 2524 | 2025 | 2678 | 3440 |
| 2049 | 265 | 3200 | 1815 | 3535 | 3504 | 2570 | 4330 | 3968 | 2579 | 2042 | 2892 | 3522 |
| 2050 | 286 | 3327 | 1869 | 3621 | 3590 | 2685 | 4359 | 4042 | 2636 | 2045 | 3117 | 3608 |
| 2051 | 307 | 3452 | 1909 | 3687 | 3656 | 2771 | 4390 | 4130 | 2661 | 2046 | 3317 | 3674 |
| 2052 | 327 | 3559 | 1950 | 3713 | 3682 | 2855 | 4405 | 4208 | 2685 | 2050 | 3503 | 3700 |
| 2053 | 348 | 3666 | 1989 | 3744 | 3713 | 2916 | 4418 | 4289 | 2692 | 2050 | 3743 | 3731 |
| 2054 | 371 | 3774 | 2017 | 3772 | 3741 | 2977 | 4436 | 4347 | 2703 | 2050 | 3896 | 3759 |
| 2055 | 373 | 3858 | 2046 | 3786 | 3755 | 3011 | 4451 | 4401 | 2706 | 2050 | 4052 | 3773 |
| 2056 | 373 | 3900 | 2056 | 3813 | 3782 | 3055 | 4467 | 4417 | 2706 | 2050 | 4179 | 3800 |
| 2057 | 373 | 3947 | 2089 | 3829 | 3798 | 3083 | 4484 | 4441 | 2706 | 2050 | 4329 | 3816 |
| 2058 | 373 | 4014 | 2106 | 3831 | 3800 | 3103 | 4497 | 4455 | 2706 | 2050 | 4416 | 3818 |
| 2059 | 373 | 4076 | 2126 | 3835 | 3804 | 3109 | 4510 | 4461 | 2706 | 2050 | 4502 | 3822 |

|      | 97  | 98   | 99   | 100  | 101  | 102  | 103  | 104  | 105  | 106  | 107  | 108  |
|------|-----|------|------|------|------|------|------|------|------|------|------|------|
| 2060 | 373 | 4110 | 2145 | 3837 | 3806 | 3112 | 4511 | 4474 | 2706 | 2050 | 4599 | 3824 |
| 2061 | 373 | 4160 | 2166 | 3839 | 3808 | 3114 | 4511 | 4480 | 2706 | 2050 | 4683 | 3826 |
| 2062 | 373 | 4208 | 2192 | 3841 | 3810 | 3115 | 4511 | 4484 | 2706 | 2050 | 4754 | 3828 |
| 2063 | 373 | 4260 | 2204 | 3841 | 3810 | 3117 | 4511 | 4487 | 2706 | 2050 | 4820 | 3828 |
| 2064 | 373 | 4288 | 2217 | 3841 | 3810 | 3117 | 4511 | 4489 | 2706 | 2050 | 4850 | 3828 |
| 2065 | 373 | 4331 | 2217 | 3841 | 3810 | 3118 | 4511 | 4490 | 2706 | 2050 | 4886 | 3828 |
| 2066 | 373 | 4356 | 2217 | 3841 | 3810 | 3118 | 4511 | 4492 | 2706 | 2050 | 4904 | 3828 |
| 2067 | 373 | 4381 | 2217 | 3841 | 3810 | 3118 | 4511 | 4492 | 2706 | 2050 | 4918 | 3828 |
| 2068 | 373 | 4400 | 2217 | 3841 | 3810 | 3118 | 4511 | 4492 | 2706 | 2050 | 4948 | 3828 |
| 2069 | 373 | 4414 | 2217 | 3841 | 3810 | 3118 | 4511 | 4492 | 2706 | 2050 | 4961 | 3828 |
| 2070 | 373 | 4443 | 2217 | 3841 | 3810 | 3118 | 4511 | 4492 | 2706 | 2050 | 4972 | 3828 |
| 2071 | 373 | 4460 | 2217 | 3841 | 3810 | 3118 | 4511 | 4492 | 2706 | 2050 | 4974 | 3828 |
| 2072 | 373 | 4481 | 2217 | 3841 | 3810 | 3118 | 4511 | 4492 | 2706 | 2050 | 4979 | 3828 |
| 2073 | 373 | 4498 | 2217 | 3841 | 3810 | 3118 | 4511 | 4492 | 2706 | 2050 | 4980 | 3828 |
| 2074 | 373 | 4519 | 2217 | 3841 | 3810 | 3118 | 4511 | 4492 | 2706 | 2050 | 4981 | 3828 |
| 2075 | 373 | 4544 | 2217 | 3841 | 3810 | 3118 | 4511 | 4492 | 2706 | 2050 | 4984 | 3828 |
| 2076 | 373 | 4556 | 2217 | 3841 | 3810 | 3118 | 4511 | 4492 | 2706 | 2050 | 4984 | 3828 |
| 2077 | 373 | 4570 | 2217 | 3841 | 3810 | 3118 | 4511 | 4492 | 2706 | 2050 | 4984 | 3828 |
| 2078 | 373 | 4570 | 2217 | 3841 | 3810 | 3118 | 4511 | 4492 | 2706 | 2050 | 4984 | 3828 |
| 2079 | 373 | 4570 | 2217 | 3841 | 3810 | 3118 | 4511 | 4492 | 2706 | 2050 | 4984 | 3828 |
| 2080 | 373 | 4570 | 2217 | 3841 | 3810 | 3118 | 4511 | 4492 | 2706 | 2050 | 4984 | 3828 |
| 2081 | 373 | 4570 | 2217 | 3841 | 3810 | 3118 | 4511 | 4492 | 2706 | 2050 | 4984 | 3828 |
| 2082 | 373 | 4570 | 2217 | 3841 | 3810 | 3118 | 4511 | 4492 | 2706 | 2050 | 4984 | 3828 |
| 2083 | 373 | 4570 | 2217 | 3841 | 3810 | 3118 | 4511 | 4492 | 2706 | 2050 | 4984 | 3828 |
| 2084 | 373 | 4570 | 2217 | 3841 | 3810 | 3118 | 4511 | 4492 | 2706 | 2050 | 4984 | 3828 |
| 2085 | 373 | 4570 | 2217 | 3841 | 3810 | 3118 | 4511 | 4492 | 2706 | 2050 | 4984 | 3828 |
| 2086 | 373 | 4570 | 2217 | 3841 | 3810 | 3118 | 4511 | 4492 | 2706 | 2050 | 4984 | 3828 |
| 2087 | 373 | 4570 | 2217 | 3841 | 3810 | 3118 | 4511 | 4492 | 2706 | 2050 | 4984 | 3828 |
| 2088 | 373 | 4570 | 2217 | 3841 | 3810 | 3118 | 4511 | 4492 | 2706 | 2050 | 4984 | 3828 |
| 2089 | 373 | 4570 | 2217 | 3841 | 3810 | 3118 | 4511 | 4492 | 2706 | 2050 | 4984 | 3828 |
| 2090 | 373 | 4570 | 2217 | 3841 | 3810 | 3118 | 4511 | 4492 | 2706 | 2050 | 4984 | 3828 |



|      | 109 | 110 | 111 | 112 | 113 | 114 | 115 | 116 | 117 | 118  | 119  | 120  |
|------|-----|-----|-----|-----|-----|-----|-----|-----|-----|------|------|------|
| 2002 | 0   | 0   | 0   | 0   | 0   | 0   | 0   | 0   | 0   | 0    | 0    | 0    |
| 2003 | 0   | 0   | 0   | 0   | 0   | 0   | 0   | 0   | 0   | 0    | 0    | 0    |
| 2004 | 0   | 0   | 0   | 0   | 0   | 0   | 0   | 0   | 0   | 0    | 0    | 0    |
| 2005 | 0   | 0   | 0   | 0   | 0   | 0   | 0   | 0   | 0   | 0    | 0    | 0    |
| 2006 | 0   | 0   | 0   | 0   | 0   | 0   | 0   | 0   | 0   | 0    | 0    | 0    |
| 2007 | 0   | 0   | 0   | 0   | 0   | 0   | 0   | 0   | 0   | 0    | 0    | 0    |
| 2008 | 0   | 0   | 0   | 0   | 0   | 0   | 0   | 0   | 0   | 0    | 0    | 0    |
| 2009 | 0   | 0   | 0   | 0   | 0   | 0   | 0   | 0   | 0   | 0    | 0    | 0    |
| 2010 | 0   | 0   | 0   | 0   | 0   | 0   | 0   | 0   | 0   | 0    | 0    | 0    |
| 2011 | 0   | 0   | 0   | 0   | 0   | 0   | 0   | 0   | 0   | 0    | 0    | 0    |
| 2012 | 0   | 0   | 0   | 0   | 0   | 0   | 0   | 0   | 0   | 0    | 0    | 0    |
| 2013 | 0   | 0   | 0   | 0   | 0   | 0   | 0   | 0   | 0   | 0    | 0    | 0    |
| 2014 | 0   | 0   | 0   | 0   | 0   | 0   | 0   | 0   | 0   | 0    | 0    | 0    |
| 2015 | 0   | 0   | 0   | 0   | 0   | 0   | 0   | 0   | 0   | 0    | 0    | 0    |
| 2016 | 0   | 0   | 0   | 0   | 0   | 0   | 0   | 0   | 0   | 0    | 0    | 0    |
| 2017 | 0   | 0   | 0   | 0   | 0   | 0   | 0   | 0   | 0   | 0    | 0    | 0    |
| 2018 | 0   | 0   | 0   | 0   | 0   | 0   | 0   | 0   | 0   | 0    | 0    | 0    |
| 2019 | 0   | 0   | 0   | 0   | 0   | 0   | 0   | 0   | 0   | 0    | 0    | 0    |
| 2020 | 0   | 0   | 0   | 0   | 0   | 0   | 0   | 0   | 0   | 0    | 0    | 0    |
| 2021 | 0   | 0   | 0   | 0   | 0   | 0   | 0   | 0   | 0   | 0    | 0    | 0    |
| 2022 | 0   | 0   | 0   | 0   | 0   | 0   | 0   | 0   | 0   | 0    | 0    | 0    |
| 2023 | 0   | 0   | 0   | 0   | 0   | 0   | 0   | 0   | 0   | 0    | 0    | 0    |
| 2024 | 0   | 0   | 0   | 0   | 0   | 0   | 0   | 0   | 0   | 0    | 0    | 0    |
| 2025 | 0   | 0   | 0   | 0   | 0   | 0   | 0   | 0   | 0   | 0    | 0    | 0    |
| 2026 | 0   | 0   | 0   | 0   | 0   | 0   | 0   | 0   | 0   | 15   | 15   | 0    |
| 2027 | 0   | 0   | 0   | 0   | 0   | 0   | 0   | 0   | 0   | 45   | 45   | 0    |
| 2028 | 0   | 0   | 0   | 0   | 0   | 0   | 0   | 0   | 0   | 128  | 128  | 0    |
| 2029 | 0   | 0   | 0   | 0   | 0   | 0   | 0   | 0   | 0   | 230  | 230  | 0    |
| 2030 | 0   | 0   | 0   | 1   | 0   | 0   | 0   | 0   | 0   | 346  | 346  | 0    |
| 2031 | 0   | 0   | 0   | 1   | 0   | 0   | 0   | 0   | 0   | 491  | 489  | 6    |
| 2032 | 0   | 0   | 0   | 1   | 0   | 0   | 0   | 0   | 0   | 592  | 587  | 28   |
| 2033 | 0   | 0   | 0   | 2   | 0   | 0   | 0   | 3   | 0   | 703  | 698  | 59   |
| 2034 | 0   | 0   | 0   | 5   | 0   | 0   | 0   | 7   | 0   | 798  | 792  | 125  |
| 2035 | 0   | 0   | 0   | 17  | 0   | 0   | 0   | 30  | 0   | 858  | 857  | 223  |
| 2036 | 1   | 1   | 0   | 32  | 1   | 1   | 1   | 59  | 1   | 970  | 974  | 369  |
| 2037 | 1   | 1   | 0   | 55  | 1   | 1   | 1   | 85  | 1   | 1043 | 1048 | 505  |
| 2038 | 5   | 4   | 0   | 79  | 5   | 3   | 2   | 152 | 4   | 1088 | 1094 | 606  |
| 2039 | 11  | 10  | 0   | 111 | 14  | 5   | 3   | 205 | 10  | 1157 | 1160 | 668  |
| 2040 | 15  | 16  | 0   | 130 | 22  | 10  | 3   | 242 | 15  | 1217 | 1224 | 771  |
| 2041 | 29  | 30  | 0   | 186 | 46  | 30  | 5   | 298 | 32  | 1275 | 1282 | 870  |
| 2042 | 44  | 45  | 0   | 213 | 65  | 50  | 5   | 396 | 50  | 1336 | 1343 | 962  |
| 2043 | 67  | 65  | 0   | 245 | 100 | 82  | 10  | 474 | 76  | 1416 | 1429 | 1040 |
| 2044 | 92  | 90  | 6   | 273 | 119 | 104 | 10  | 518 | 99  | 1458 | 1471 | 1127 |
| 2045 | 106 | 104 | 22  | 292 | 136 | 126 | 10  | 595 | 114 | 1491 | 1506 | 1184 |
| 2046 | 115 | 113 | 31  | 306 | 139 | 136 | 10  | 620 | 122 | 1549 | 1562 | 1247 |
| 2047 | 118 | 116 | 39  | 316 | 147 | 144 | 10  | 664 | 125 | 1586 | 1602 | 1324 |
| 2048 | 118 | 116 | 42  | 326 | 147 | 147 | 10  | 694 | 127 | 1634 | 1653 | 1403 |
| 2049 | 118 | 116 | 42  | 326 | 147 | 147 | 10  | 718 | 129 | 1668 | 1683 | 1441 |
| 2050 | 118 | 116 | 42  | 334 | 147 | 147 | 10  | 756 | 129 | 1711 | 1725 | 1472 |
| 2051 | 118 | 116 | 42  | 334 | 147 | 147 | 10  | 786 | 129 | 1744 | 1761 | 1509 |
| 2052 | 118 | 116 | 42  | 334 | 147 | 147 | 10  | 809 | 129 | 1787 | 1803 | 1531 |
| 2053 | 118 | 116 | 42  | 334 | 147 | 147 | 10  | 831 | 129 | 1830 | 1842 | 1557 |
| 2054 | 118 | 116 | 42  | 334 | 147 | 147 | 10  | 849 | 129 | 1858 | 1872 | 1577 |
| 2055 | 118 | 116 | 42  | 334 | 147 | 147 | 10  | 866 | 129 | 1884 | 1903 | 1600 |
| 2056 | 118 | 116 | 42  | 334 | 147 | 147 | 10  | 875 | 129 | 1903 | 1922 | 1604 |
| 2057 | 118 | 116 | 42  | 334 | 147 | 147 | 10  | 880 | 129 | 1927 | 1951 | 1624 |
| 2058 | 118 | 116 | 42  | 334 | 147 | 147 | 10  | 883 | 129 | 1940 | 1964 | 1629 |
| 2059 | 118 | 116 | 42  | 334 | 147 | 147 | 10  | 886 | 129 | 1966 | 1985 | 1642 |

|      | 109 | 110 | 111 | 112 | 113 | 114 | 115 | 116 | 117 | 118  | 119  | 120  |
|------|-----|-----|-----|-----|-----|-----|-----|-----|-----|------|------|------|
| 2060 | 118 | 116 | 42  | 334 | 147 | 147 | 10  | 886 | 129 | 1992 | 2013 | 1652 |
| 2061 | 118 | 116 | 42  | 334 | 147 | 147 | 10  | 886 | 129 | 2026 | 2039 | 1657 |
| 2062 | 118 | 116 | 42  | 334 | 147 | 147 | 10  | 886 | 129 | 2061 | 2071 | 1677 |
| 2063 | 118 | 116 | 42  | 334 | 147 | 147 | 10  | 886 | 129 | 2098 | 2110 | 1690 |
| 2064 | 118 | 116 | 42  | 334 | 147 | 147 | 10  | 886 | 129 | 2127 | 2135 | 1698 |
| 2065 | 118 | 116 | 42  | 334 | 147 | 147 | 10  | 886 | 129 | 2134 | 2142 | 1698 |
| 2066 | 118 | 116 | 42  | 334 | 147 | 147 | 10  | 886 | 129 | 2134 | 2142 | 1698 |
| 2067 | 118 | 116 | 42  | 334 | 147 | 147 | 10  | 886 | 129 | 2134 | 2142 | 1698 |
| 2068 | 118 | 116 | 42  | 334 | 147 | 147 | 10  | 886 | 129 | 2134 | 2142 | 1698 |
| 2069 | 118 | 116 | 42  | 334 | 147 | 147 | 10  | 886 | 129 | 2134 | 2142 | 1698 |
| 2070 | 118 | 116 | 42  | 334 | 147 | 147 | 10  | 886 | 129 | 2134 | 2142 | 1698 |
| 2071 | 118 | 116 | 42  | 334 | 147 | 147 | 10  | 886 | 129 | 2134 | 2142 | 1698 |
| 2072 | 118 | 116 | 42  | 334 | 147 | 147 | 10  | 886 | 129 | 2134 | 2142 | 1698 |
| 2073 | 118 | 116 | 42  | 334 | 147 | 147 | 10  | 886 | 129 | 2134 | 2142 | 1698 |
| 2074 | 118 | 116 | 42  | 334 | 147 | 147 | 10  | 886 | 129 | 2134 | 2142 | 1698 |
| 2075 | 118 | 116 | 42  | 334 | 147 | 147 | 10  | 886 | 129 | 2134 | 2142 | 1698 |
| 2076 | 118 | 116 | 42  | 334 | 147 | 147 | 10  | 886 | 129 | 2134 | 2142 | 1698 |
| 2077 | 118 | 116 | 42  | 334 | 147 | 147 | 10  | 886 | 129 | 2134 | 2142 | 1698 |
| 2078 | 118 | 116 | 42  | 334 | 147 | 147 | 10  | 886 | 129 | 2134 | 2142 | 1698 |
| 2079 | 118 | 116 | 42  | 334 | 147 | 147 | 10  | 886 | 129 | 2134 | 2142 | 1698 |
| 2080 | 118 | 116 | 42  | 334 | 147 | 147 | 10  | 886 | 129 | 2134 | 2142 | 1698 |
| 2081 | 118 | 116 | 42  | 334 | 147 | 147 | 10  | 886 | 129 | 2134 | 2142 | 1698 |
| 2082 | 118 | 116 | 42  | 334 | 147 | 147 | 10  | 886 | 129 | 2134 | 2142 | 1698 |
| 2083 | 118 | 116 | 42  | 334 | 147 | 147 | 10  | 886 | 129 | 2134 | 2142 | 1698 |
| 2084 | 118 | 116 | 42  | 334 | 147 | 147 | 10  | 886 | 129 | 2134 | 2142 | 1698 |
| 2085 | 118 | 116 | 42  | 334 | 147 | 147 | 10  | 886 | 129 | 2134 | 2142 | 1698 |
| 2086 | 118 | 116 | 42  | 334 | 147 | 147 | 10  | 886 | 129 | 2134 | 2142 | 1698 |
| 2087 | 118 | 116 | 42  | 334 | 147 | 147 | 10  | 886 | 129 | 2134 | 2142 | 1698 |
| 2088 | 118 | 116 | 42  | 334 | 147 | 147 | 10  | 886 | 129 | 2134 | 2142 | 1698 |
| 2089 | 118 | 116 | 42  | 334 | 147 | 147 | 10  | 886 | 129 | 2134 | 2142 | 1698 |
| 2090 | 118 | 116 | 42  | 334 | 147 | 147 | 10  | 886 | 129 | 2134 | 2142 | 1698 |

|      | 121  | 122  | 123  | 124 | 125  | 126  | 127  | 128  | 129  | 130  | 131  | 132  |
|------|------|------|------|-----|------|------|------|------|------|------|------|------|
| 2002 | 0    | 0    | 0    | 0   | 0    | 0    | 0    | 0    | 0    | 0    | 0    | 0    |
| 2003 | 0    | 0    | 0    | 0   | 0    | 0    | 0    | 0    | 0    | 0    | 0    | 0    |
| 2004 | 0    | 0    | 0    | 0   | 0    | 0    | 0    | 0    | 0    | 0    | 0    | 0    |
| 2005 | 0    | 0    | 0    | 0   | 0    | 0    | 0    | 0    | 0    | 0    | 0    | 0    |
| 2006 | 0    | 0    | 0    | 0   | 0    | 0    | 0    | 0    | 0    | 0    | 0    | 0    |
| 2007 | 0    | 0    | 0    | 0   | 0    | 0    | 0    | 0    | 0    | 0    | 0    | 0    |
| 2008 | 0    | 0    | 0    | 0   | 0    | 0    | 0    | 0    | 0    | 0    | 0    | 0    |
| 2009 | 0    | 0    | 0    | 0   | 0    | 0    | 0    | 0    | 0    | 0    | 0    | 0    |
| 2010 | 0    | 0    | 0    | 0   | 0    | 0    | 0    | 0    | 0    | 0    | 0    | 0    |
| 2011 | 0    | 0    | 0    | 0   | 0    | 0    | 0    | 0    | 0    | 0    | 0    | 0    |
| 2012 | 0    | 0    | 0    | 0   | 0    | 0    | 0    | 0    | 0    | 0    | 0    | 0    |
| 2013 | 0    | 0    | 0    | 0   | 0    | 0    | 0    | 0    | 0    | 0    | 0    | 0    |
| 2014 | 0    | 0    | 0    | 0   | 0    | 0    | 0    | 0    | 0    | 0    | 0    | 0    |
| 2015 | 0    | 0    | 0    | 0   | 0    | 0    | 0    | 0    | 0    | 0    | 0    | 0    |
| 2016 | 0    | 0    | 0    | 0   | 0    | 0    | 0    | 0    | 0    | 0    | 0    | 0    |
| 2017 | 0    | 0    | 0    | 0   | 0    | 0    | 0    | 0    | 0    | 0    | 0    | 0    |
| 2018 | 0    | 0    | 0    | 0   | 0    | 0    | 0    | 0    | 0    | 0    | 0    | 0    |
| 2019 | 0    | 0    | 0    | 0   | 0    | 0    | 0    | 0    | 0    | 0    | 0    | 0    |
| 2020 | 0    | 0    | 0    | 0   | 0    | 0    | 0    | 0    | 0    | 0    | 0    | 0    |
| 2021 | 7    | 0    | 0    | 0   | 0    | 0    | 0    | 0    | 0    | 3    | 0    | 0    |
| 2022 | 56   | 0    | 0    | 0   | 0    | 0    | 0    | 0    | 0    | 28   | 0    | 0    |
| 2023 | 171  | 0    | 0    | 0   | 0    | 0    | 0    | 0    | 0    | 54   | 0    | 0    |
| 2024 | 318  | 0    | 0    | 0   | 0    | 0    | 0    | 0    | 0    | 115  | 0    | 0    |
| 2025 | 415  | 0    | 0    | 0   | 0    | 0    | 0    | 0    | 0    | 190  | 0    | 0    |
| 2026 | 556  | 13   | 6    | 0   | 2    | 15   | 1    | 1    | 0    | 345  | 0    | 15   |
| 2027 | 647  | 34   | 72   | 1   | 6    | 45   | 23   | 23   | 0    | 522  | 8    | 63   |
| 2028 | 760  | 53   | 139  | 5   | 17   | 128  | 37   | 39   | 0    | 757  | 24   | 136  |
| 2029 | 837  | 104  | 205  | 12  | 33   | 230  | 76   | 78   | 0    | 936  | 49   | 249  |
| 2030 | 940  | 151  | 275  | 14  | 59   | 346  | 154  | 157  | 0    | 1148 | 96   | 362  |
| 2031 | 1018 | 290  | 357  | 16  | 105  | 489  | 257  | 262  | 8    | 1319 | 190  | 500  |
| 2032 | 1082 | 387  | 429  | 25  | 143  | 587  | 386  | 393  | 27   | 1512 | 290  | 604  |
| 2033 | 1137 | 544  | 525  | 28  | 250  | 698  | 533  | 543  | 53   | 1686 | 396  | 722  |
| 2034 | 1187 | 698  | 609  | 35  | 328  | 791  | 752  | 762  | 131  | 1895 | 511  | 866  |
| 2035 | 1228 | 823  | 681  | 43  | 416  | 856  | 977  | 987  | 202  | 2082 | 649  | 957  |
| 2036 | 1256 | 905  | 746  | 49  | 491  | 972  | 1194 | 1207 | 287  | 2243 | 861  | 1046 |
| 2037 | 1301 | 957  | 830  | 51  | 616  | 1045 | 1393 | 1405 | 392  | 2423 | 1154 | 1159 |
| 2038 | 1331 | 1003 | 930  | 63  | 752  | 1091 | 1578 | 1590 | 532  | 2595 | 1393 | 1263 |
| 2039 | 1353 | 1063 | 978  | 76  | 924  | 1156 | 1753 | 1763 | 735  | 2761 | 1663 | 1408 |
| 2040 | 1376 | 1138 | 1060 | 88  | 1101 | 1218 | 1912 | 1930 | 959  | 2881 | 1905 | 1545 |
| 2041 | 1424 | 1183 | 1125 | 122 | 1292 | 1277 | 2073 | 2097 | 1179 | 3046 | 2129 | 1670 |
| 2042 | 1457 | 1236 | 1201 | 138 | 1494 | 1338 | 2252 | 2277 | 1349 | 3153 | 2335 | 1809 |
| 2043 | 1528 | 1272 | 1278 | 170 | 1717 | 1424 | 2427 | 2455 | 1509 | 3344 | 2535 | 1932 |
| 2044 | 1561 | 1306 | 1338 | 186 | 1910 | 1466 | 2587 | 2608 | 1682 | 3465 | 2734 | 2029 |
| 2045 | 1612 | 1355 | 1407 | 206 | 2108 | 1499 | 2786 | 2804 | 1877 | 3585 | 2952 | 2144 |
| 2046 | 1674 | 1408 | 1439 | 222 | 2260 | 1557 | 2929 | 2946 | 2024 | 3696 | 3158 | 2205 |
| 2047 | 1714 | 1461 | 1490 | 238 | 2420 | 1594 | 3064 | 3083 | 2201 | 3803 | 3368 | 2287 |
| 2048 | 1770 | 1533 | 1562 | 281 | 2560 | 1648 | 3199 | 3215 | 2373 | 3910 | 3537 | 2358 |
| 2049 | 1805 | 1575 | 1607 | 301 | 2733 | 1683 | 3284 | 3294 | 2487 | 3959 | 3626 | 2407 |
| 2050 | 1868 | 1635 | 1644 | 328 | 2851 | 1727 | 3344 | 3356 | 2585 | 4013 | 3686 | 2463 |
| 2051 | 1930 | 1689 | 1679 | 359 | 2958 | 1768 | 3419 | 3431 | 2663 | 4054 | 3744 | 2497 |
| 2052 | 2009 | 1742 | 1725 | 388 | 3036 | 1811 | 3453 | 3466 | 2720 | 4077 | 3823 | 2541 |
| 2053 | 2064 | 1780 | 1755 | 421 | 3113 | 1845 | 3489 | 3501 | 2768 | 4097 | 3885 | 2569 |
| 2054 | 2119 | 1827 | 1779 | 470 | 3219 | 1869 | 3526 | 3536 | 2839 | 4125 | 3931 | 2595 |
| 2055 | 2171 | 1858 | 1804 | 484 | 3313 | 1895 | 3539 | 3550 | 2861 | 4156 | 3988 | 2611 |
| 2056 | 2219 | 1900 | 1831 | 488 | 3347 | 1917 | 3553 | 3565 | 2888 | 4187 | 3998 | 2620 |
| 2057 | 2277 | 1944 | 1854 | 488 | 3387 | 1944 | 3570 | 3581 | 2908 | 4220 | 4056 | 2625 |
| 2058 | 2321 | 1958 | 1855 | 488 | 3439 | 1958 | 3577 | 3590 | 2917 | 4244 | 4075 | 2625 |
| 2059 | 2371 | 1996 | 1855 | 488 | 3491 | 1990 | 3591 | 3600 | 2919 | 4272 | 4093 | 2625 |

|      | 121  | 122  | 123  | 124 | 125  | 126  | 127  | 128  | 129  | 130  | 131  | 132  |
|------|------|------|------|-----|------|------|------|------|------|------|------|------|
| 2060 | 2409 | 2014 | 1855 | 488 | 3531 | 2012 | 3597 | 3613 | 2919 | 4292 | 4105 | 2625 |
| 2061 | 2452 | 2033 | 1855 | 488 | 3577 | 2044 | 3605 | 3621 | 2919 | 4306 | 4110 | 2625 |
| 2062 | 2495 | 2057 | 1855 | 488 | 3610 | 2075 | 3623 | 3637 | 2923 | 4320 | 4119 | 2625 |
| 2063 | 2532 | 2083 | 1855 | 488 | 3652 | 2113 | 3625 | 3639 | 2925 | 4320 | 4127 | 2625 |
| 2064 | 2565 | 2111 | 1855 | 488 | 3678 | 2140 | 3625 | 3639 | 2932 | 4320 | 4138 | 2625 |
| 2065 | 2572 | 2140 | 1855 | 488 | 3721 | 2147 | 3625 | 3639 | 2932 | 4320 | 4149 | 2625 |
| 2066 | 2572 | 2160 | 1855 | 488 | 3746 | 2147 | 3625 | 3639 | 2932 | 4320 | 4158 | 2625 |
| 2067 | 2572 | 2177 | 1855 | 488 | 3771 | 2147 | 3625 | 3639 | 2932 | 4320 | 4169 | 2625 |
| 2068 | 2572 | 2185 | 1855 | 488 | 3800 | 2147 | 3625 | 3639 | 2932 | 4320 | 4169 | 2625 |
| 2069 | 2572 | 2185 | 1855 | 488 | 3818 | 2147 | 3625 | 3639 | 2932 | 4320 | 4169 | 2625 |
| 2070 | 2572 | 2185 | 1855 | 488 | 3844 | 2147 | 3625 | 3639 | 2932 | 4320 | 4169 | 2625 |
| 2071 | 2572 | 2185 | 1855 | 488 | 3856 | 2147 | 3625 | 3639 | 2932 | 4320 | 4169 | 2625 |
| 2072 | 2572 | 2185 | 1855 | 488 | 3888 | 2147 | 3625 | 3639 | 2932 | 4320 | 4169 | 2625 |
| 2073 | 2572 | 2185 | 1855 | 488 | 3912 | 2147 | 3625 | 3639 | 2932 | 4320 | 4169 | 2625 |
| 2074 | 2572 | 2185 | 1855 | 488 | 3939 | 2147 | 3625 | 3639 | 2932 | 4320 | 4169 | 2625 |
| 2075 | 2572 | 2185 | 1855 | 488 | 3977 | 2147 | 3625 | 3639 | 2932 | 4320 | 4169 | 2625 |
| 2076 | 2572 | 2185 | 1855 | 488 | 4004 | 2147 | 3625 | 3639 | 2932 | 4320 | 4169 | 2625 |
| 2077 | 2572 | 2185 | 1855 | 488 | 4032 | 2147 | 3625 | 3639 | 2932 | 4320 | 4169 | 2625 |
| 2078 | 2572 | 2185 | 1855 | 488 | 4043 | 2147 | 3625 | 3639 | 2932 | 4320 | 4169 | 2625 |
| 2079 | 2572 | 2185 | 1855 | 488 | 4043 | 2147 | 3625 | 3639 | 2932 | 4320 | 4169 | 2625 |
| 2080 | 2572 | 2185 | 1855 | 488 | 4043 | 2147 | 3625 | 3639 | 2932 | 4320 | 4169 | 2625 |
| 2081 | 2572 | 2185 | 1855 | 488 | 4043 | 2147 | 3625 | 3639 | 2932 | 4320 | 4169 | 2625 |
| 2082 | 2572 | 2185 | 1855 | 488 | 4043 | 2147 | 3625 | 3639 | 2932 | 4320 | 4169 | 2625 |
| 2083 | 2572 | 2185 | 1855 | 488 | 4043 | 2147 | 3625 | 3639 | 2932 | 4320 | 4169 | 2625 |
| 2084 | 2572 | 2185 | 1855 | 488 | 4043 | 2147 | 3625 | 3639 | 2932 | 4320 | 4169 | 2625 |
| 2085 | 2572 | 2185 | 1855 | 488 | 4043 | 2147 | 3625 | 3639 | 2932 | 4320 | 4169 | 2625 |
| 2086 | 2572 | 2185 | 1855 | 488 | 4043 | 2147 | 3625 | 3639 | 2932 | 4320 | 4169 | 2625 |
| 2087 | 2572 | 2185 | 1855 | 488 | 4043 | 2147 | 3625 | 3639 | 2932 | 4320 | 4169 | 2625 |
| 2088 | 2572 | 2185 | 1855 | 488 | 4043 | 2147 | 3625 | 3639 | 2932 | 4320 | 4169 | 2625 |
| 2089 | 2572 | 2185 | 1855 | 488 | 4043 | 2147 | 3625 | 3639 | 2932 | 4320 | 4169 | 2625 |
| 2090 | 2572 | 2185 | 1855 | 488 | 4043 | 2147 | 3625 | 3639 | 2932 | 4320 | 4169 | 2625 |

|      | 133  | 134  | 135  | 136 | 137 | 138 | 139 | 140 | 141 | 142 | 143 | 144 |
|------|------|------|------|-----|-----|-----|-----|-----|-----|-----|-----|-----|
| 2002 | 0    | 0    | 0    | 0   | 0   | 0   | 0   | 0   | 0   | 0   | 0   | 0   |
| 2003 | 0    | 0    | 0    | 0   | 0   | 0   | 0   | 0   | 0   | 0   | 0   | 0   |
| 2004 | 0    | 0    | 0    | 0   | 0   | 0   | 0   | 0   | 0   | 0   | 0   | 0   |
| 2005 | 0    | 0    | 0    | 0   | 0   | 0   | 0   | 0   | 0   | 0   | 0   | 0   |
| 2006 | 0    | 0    | 0    | 0   | 0   | 0   | 0   | 0   | 0   | 0   | 0   | 0   |
| 2007 | 0    | 0    | 0    | 0   | 0   | 0   | 0   | 0   | 0   | 0   | 0   | 0   |
| 2008 | 0    | 0    | 0    | 0   | 0   | 0   | 0   | 0   | 0   | 0   | 0   | 0   |
| 2009 | 0    | 0    | 0    | 0   | 0   | 0   | 0   | 0   | 0   | 0   | 0   | 0   |
| 2010 | 0    | 0    | 0    | 0   | 0   | 0   | 0   | 0   | 0   | 0   | 0   | 0   |
| 2011 | 0    | 0    | 0    | 0   | 0   | 0   | 0   | 0   | 0   | 0   | 0   | 0   |
| 2012 | 0    | 0    | 0    | 0   | 0   | 0   | 0   | 0   | 0   | 0   | 0   | 0   |
| 2013 | 0    | 0    | 0    | 0   | 0   | 0   | 0   | 0   | 0   | 0   | 0   | 0   |
| 2014 | 0    | 0    | 0    | 0   | 0   | 0   | 0   | 0   | 0   | 0   | 0   | 0   |
| 2015 | 0    | 0    | 0    | 0   | 0   | 0   | 0   | 0   | 0   | 0   | 0   | 0   |
| 2016 | 0    | 0    | 0    | 0   | 0   | 0   | 0   | 0   | 0   | 0   | 0   | 0   |
| 2017 | 0    | 0    | 0    | 0   | 0   | 0   | 0   | 0   | 0   | 0   | 0   | 0   |
| 2018 | 0    | 0    | 0    | 0   | 0   | 0   | 0   | 0   | 0   | 0   | 0   | 0   |
| 2019 | 0    | 0    | 0    | 0   | 0   | 0   | 0   | 0   | 0   | 0   | 0   | 0   |
| 2020 | 0    | 0    | 0    | 0   | 0   | 0   | 0   | 0   | 0   | 0   | 0   | 0   |
| 2021 | 0    | 0    | 0    | 0   | 0   | 0   | 0   | 0   | 0   | 0   | 0   | 0   |
| 2022 | 0    | 0    | 0    | 0   | 0   | 0   | 0   | 0   | 0   | 0   | 0   | 0   |
| 2023 | 0    | 0    | 0    | 0   | 0   | 0   | 0   | 0   | 0   | 0   | 0   | 0   |
| 2024 | 0    | 0    | 0    | 0   | 0   | 0   | 0   | 0   | 0   | 0   | 0   | 0   |
| 2025 | 0    | 0    | 0    | 0   | 0   | 0   | 0   | 0   | 0   | 0   | 0   | 0   |
| 2026 | 40   | 1    | 1    | 0   | 0   | 0   | 0   | 0   | 0   | 0   | 0   | 0   |
| 2027 | 140  | 4    | 23   | 0   | 0   | 0   | 0   | 0   | 0   | 0   | 0   | 0   |
| 2028 | 279  | 7    | 37   | 0   | 0   | 0   | 0   | 0   | 0   | 0   | 0   | 0   |
| 2029 | 436  | 19   | 76   | 0   | 0   | 0   | 0   | 0   | 0   | 0   | 0   | 0   |
| 2030 | 545  | 27   | 154  | 0   | 0   | 0   | 0   | 0   | 0   | 0   | 0   | 0   |
| 2031 | 718  | 43   | 259  | 0   | 0   | 0   | 1   | 0   | 0   | 0   | 0   | 0   |
| 2032 | 839  | 60   | 389  | 0   | 0   | 0   | 1   | 0   | 0   | 0   | 0   | 0   |
| 2033 | 941  | 85   | 539  | 0   | 0   | 0   | 1   | 0   | 0   | 0   | 0   | 0   |
| 2034 | 1020 | 117  | 758  | 0   | 0   | 0   | 1   | 0   | 0   | 0   | 1   | 0   |
| 2035 | 1114 | 155  | 983  | 0   | 0   | 0   | 7   | 0   | 0   | 0   | 3   | 0   |
| 2036 | 1212 | 211  | 1202 | 0   | 0   | 0   | 8   | 0   | 0   | 0   | 8   | 0   |
| 2037 | 1304 | 267  | 1401 | 0   | 1   | 0   | 26  | 1   | 1   | 1   | 11  | 1   |
| 2038 | 1368 | 349  | 1586 | 1   | 1   | 0   | 42  | 1   | 1   | 1   | 31  | 1   |
| 2039 | 1443 | 460  | 1761 | 1   | 1   | 0   | 64  | 3   | 4   | 1   | 55  | 1   |
| 2040 | 1514 | 574  | 1925 | 2   | 2   | 0   | 77  | 5   | 4   | 2   | 90  | 2   |
| 2041 | 1574 | 710  | 2091 | 2   | 2   | 0   | 125 | 7   | 7   | 2   | 143 | 2   |
| 2042 | 1656 | 866  | 2271 | 4   | 4   | 0   | 151 | 10  | 15  | 3   | 215 | 4   |
| 2043 | 1714 | 1054 | 2448 | 7   | 12  | 0   | 177 | 21  | 21  | 4   | 277 | 9   |
| 2044 | 1804 | 1265 | 2601 | 16  | 18  | 0   | 203 | 45  | 36  | 6   | 315 | 17  |
| 2045 | 1850 | 1481 | 2794 | 28  | 30  | 0   | 221 | 66  | 62  | 6   | 392 | 29  |
| 2046 | 1893 | 1760 | 2935 | 39  | 37  | 0   | 246 | 81  | 77  | 6   | 414 | 40  |
| 2047 | 1924 | 2042 | 3071 | 48  | 46  | 3   | 267 | 93  | 89  | 6   | 457 | 52  |
| 2048 | 1960 | 2261 | 3203 | 51  | 53  | 6   | 274 | 96  | 94  | 6   | 489 | 55  |
| 2049 | 1975 | 2453 | 3284 | 51  | 58  | 7   | 276 | 102 | 98  | 6   | 507 | 57  |
| 2050 | 1989 | 2713 | 3349 | 51  | 58  | 8   | 282 | 103 | 98  | 6   | 543 | 57  |
| 2051 | 1996 | 2908 | 3426 | 51  | 58  | 8   | 282 | 103 | 98  | 6   | 572 | 57  |
| 2052 | 2004 | 3046 | 3465 | 51  | 58  | 8   | 282 | 103 | 98  | 6   | 599 | 57  |
| 2053 | 2015 | 3257 | 3501 | 51  | 58  | 8   | 282 | 103 | 98  | 6   | 617 | 57  |
| 2054 | 2015 | 3412 | 3539 | 51  | 58  | 8   | 282 | 103 | 98  | 6   | 635 | 57  |
| 2055 | 2015 | 3562 | 3551 | 51  | 58  | 8   | 282 | 103 | 98  | 6   | 645 | 57  |
| 2056 | 2015 | 3696 | 3565 | 51  | 58  | 8   | 282 | 103 | 98  | 6   | 652 | 57  |
| 2057 | 2015 | 3817 | 3582 | 51  | 58  | 8   | 282 | 103 | 98  | 6   | 667 | 57  |
| 2058 | 2015 | 3896 | 3589 | 51  | 58  | 8   | 282 | 103 | 98  | 6   | 674 | 57  |
| 2059 | 2015 | 3956 | 3600 | 51  | 58  | 8   | 282 | 103 | 98  | 6   | 678 | 57  |

|      | 133  | 134  | 135  | 136 | 137 | 138 | 139 | 140 | 141 | 142 | 143 | 144 |
|------|------|------|------|-----|-----|-----|-----|-----|-----|-----|-----|-----|
| 2060 | 2015 | 4040 | 3607 | 51  | 58  | 8   | 282 | 103 | 98  | 6   | 678 | 57  |
| 2061 | 2015 | 4106 | 3613 | 51  | 58  | 8   | 282 | 103 | 98  | 6   | 678 | 57  |
| 2062 | 2015 | 4164 | 3628 | 51  | 58  | 8   | 282 | 103 | 98  | 6   | 678 | 57  |
| 2063 | 2015 | 4221 | 3630 | 51  | 58  | 8   | 282 | 103 | 98  | 6   | 678 | 57  |
| 2064 | 2015 | 4268 | 3630 | 51  | 58  | 8   | 282 | 103 | 98  | 6   | 678 | 57  |
| 2065 | 2015 | 4315 | 3630 | 51  | 58  | 8   | 282 | 103 | 98  | 6   | 678 | 57  |
| 2066 | 2015 | 4334 | 3630 | 51  | 58  | 8   | 282 | 103 | 98  | 6   | 678 | 57  |
| 2067 | 2015 | 4353 | 3630 | 51  | 58  | 8   | 282 | 103 | 98  | 6   | 678 | 57  |
| 2068 | 2015 | 4372 | 3630 | 51  | 58  | 8   | 282 | 103 | 98  | 6   | 678 | 57  |
| 2069 | 2015 | 4383 | 3630 | 51  | 58  | 8   | 282 | 103 | 98  | 6   | 678 | 57  |
| 2070 | 2015 | 4393 | 3630 | 51  | 58  | 8   | 282 | 103 | 98  | 6   | 678 | 57  |
| 2071 | 2015 | 4399 | 3630 | 51  | 58  | 8   | 282 | 103 | 98  | 6   | 678 | 57  |
| 2072 | 2015 | 4411 | 3630 | 51  | 58  | 8   | 282 | 103 | 98  | 6   | 678 | 57  |
| 2073 | 2015 | 4418 | 3630 | 51  | 58  | 8   | 282 | 103 | 98  | 6   | 678 | 57  |
| 2074 | 2015 | 4424 | 3630 | 51  | 58  | 8   | 282 | 103 | 98  | 6   | 678 | 57  |
| 2075 | 2015 | 4437 | 3630 | 51  | 58  | 8   | 282 | 103 | 98  | 6   | 678 | 57  |
| 2076 | 2015 | 4440 | 3630 | 51  | 58  | 8   | 282 | 103 | 98  | 6   | 678 | 57  |
| 2077 | 2015 | 4440 | 3630 | 51  | 58  | 8   | 282 | 103 | 98  | 6   | 678 | 57  |
| 2078 | 2015 | 4440 | 3630 | 51  | 58  | 8   | 282 | 103 | 98  | 6   | 678 | 57  |
| 2079 | 2015 | 4440 | 3630 | 51  | 58  | 8   | 282 | 103 | 98  | 6   | 678 | 57  |
| 2080 | 2015 | 4440 | 3630 | 51  | 58  | 8   | 282 | 103 | 98  | 6   | 678 | 57  |
| 2081 | 2015 | 4440 | 3630 | 51  | 58  | 8   | 282 | 103 | 98  | 6   | 678 | 57  |
| 2082 | 2015 | 4440 | 3630 | 51  | 58  | 8   | 282 | 103 | 98  | 6   | 678 | 57  |
| 2083 | 2015 | 4440 | 3630 | 51  | 58  | 8   | 282 | 103 | 98  | 6   | 678 | 57  |
| 2084 | 2015 | 4440 | 3630 | 51  | 58  | 8   | 282 | 103 | 98  | 6   | 678 | 57  |
| 2085 | 2015 | 4440 | 3630 | 51  | 58  | 8   | 282 | 103 | 98  | 6   | 678 | 57  |
| 2086 | 2015 | 4440 | 3630 | 51  | 58  | 8   | 282 | 103 | 98  | 6   | 678 | 57  |
| 2087 | 2015 | 4440 | 3630 | 51  | 58  | 8   | 282 | 103 | 98  | 6   | 678 | 57  |
| 2088 | 2015 | 4440 | 3630 | 51  | 58  | 8   | 282 | 103 | 98  | 6   | 678 | 57  |
| 2089 | 2015 | 4440 | 3630 | 51  | 58  | 8   | 282 | 103 | 98  | 6   | 678 | 57  |
| 2090 | 2015 | 4440 | 3630 | 51  | 58  | 8   | 282 | 103 | 98  | 6   | 678 | 57  |

|      | 145  | 146  | 147  | 148  | 149  | 150  | 151 | 152  | 153  | 154  | 155  | 156  |
|------|------|------|------|------|------|------|-----|------|------|------|------|------|
| 2002 | 0    | 0    | 0    | 0    | 0    | 0    | 0   | 0    | 0    | 0    | 0    | 0    |
| 2003 | 0    | 0    | 0    | 0    | 0    | 0    | 0   | 0    | 0    | 0    | 0    | 0    |
| 2004 | 0    | 0    | 0    | 0    | 0    | 0    | 0   | 0    | 0    | 0    | 0    | 0    |
| 2005 | 0    | 0    | 0    | 0    | 0    | 0    | 0   | 0    | 0    | 0    | 0    | 0    |
| 2006 | 0    | 0    | 0    | 0    | 0    | 0    | 0   | 0    | 0    | 0    | 0    | 0    |
| 2007 | 0    | 0    | 0    | 0    | 0    | 0    | 0   | 0    | 0    | 0    | 0    | 0    |
| 2008 | 0    | 0    | 0    | 0    | 0    | 0    | 0   | 0    | 0    | 0    | 0    | 0    |
| 2009 | 0    | 0    | 0    | 0    | 0    | 0    | 0   | 0    | 0    | 0    | 0    | 0    |
| 2010 | 0    | 0    | 0    | 0    | 0    | 0    | 0   | 0    | 0    | 0    | 0    | 0    |
| 2011 | 0    | 0    | 0    | 0    | 0    | 0    | 0   | 0    | 0    | 0    | 0    | 0    |
| 2012 | 0    | 0    | 0    | 0    | 0    | 0    | 0   | 0    | 0    | 0    | 0    | 0    |
| 2013 | 0    | 0    | 0    | 0    | 0    | 0    | 0   | 0    | 0    | 0    | 0    | 0    |
| 2014 | 0    | 0    | 0    | 0    | 0    | 0    | 0   | 0    | 0    | 0    | 0    | 0    |
| 2015 | 0    | 0    | 0    | 0    | 0    | 0    | 0   | 0    | 0    | 0    | 0    | 0    |
| 2016 | 0    | 0    | 0    | 0    | 0    | 0    | 0   | 0    | 0    | 0    | 0    | 0    |
| 2017 | 0    | 0    | 0    | 0    | 0    | 0    | 0   | 0    | 0    | 0    | 0    | 0    |
| 2018 | 0    | 0    | 0    | 0    | 0    | 0    | 0   | 0    | 0    | 0    | 0    | 0    |
| 2019 | 0    | 0    | 0    | 0    | 0    | 0    | 0   | 0    | 0    | 0    | 0    | 0    |
| 2020 | 0    | 0    | 0    | 0    | 0    | 0    | 0   | 0    | 0    | 0    | 0    | 0    |
| 2021 | 0    | 0    | 0    | 7    | 0    | 0    | 0   | 0    | 0    | 0    | 0    | 0    |
| 2022 | 0    | 0    | 0    | 62   | 0    | 0    | 0   | 0    | 0    | 0    | 0    | 0    |
| 2023 | 0    | 0    | 0    | 177  | 0    | 0    | 0   | 0    | 0    | 0    | 0    | 0    |
| 2024 | 0    | 0    | 0    | 307  | 0    | 0    | 0   | 0    | 0    | 0    | 0    | 0    |
| 2025 | 0    | 0    | 0    | 386  | 0    | 0    | 0   | 0    | 0    | 0    | 0    | 0    |
| 2026 | 15   | 15   | 0    | 531  | 13   | 6    | 0   | 2    | 15   | 1    | 1    | 0    |
| 2027 | 44   | 45   | 0    | 631  | 32   | 71   | 1   | 6    | 44   | 19   | 21   | 0    |
| 2028 | 123  | 129  | 0    | 750  | 60   | 131  | 4   | 10   | 124  | 29   | 49   | 0    |
| 2029 | 211  | 218  | 0    | 847  | 123  | 181  | 12  | 24   | 214  | 81   | 110  | 0    |
| 2030 | 315  | 323  | 0    | 965  | 183  | 238  | 12  | 67   | 322  | 153  | 187  | 0    |
| 2031 | 443  | 454  | 6    | 1050 | 314  | 316  | 13  | 136  | 456  | 248  | 283  | 8    |
| 2032 | 530  | 545  | 22   | 1122 | 415  | 385  | 22  | 186  | 546  | 402  | 442  | 39   |
| 2033 | 633  | 643  | 57   | 1184 | 565  | 490  | 24  | 264  | 652  | 547  | 575  | 61   |
| 2034 | 755  | 760  | 121  | 1242 | 731  | 590  | 29  | 391  | 772  | 759  | 783  | 131  |
| 2035 | 844  | 860  | 215  | 1303 | 863  | 689  | 38  | 496  | 863  | 953  | 978  | 200  |
| 2036 | 971  | 975  | 352  | 1347 | 948  | 773  | 41  | 620  | 983  | 1126 | 1162 | 289  |
| 2037 | 1062 | 1065 | 487  | 1422 | 1022 | 850  | 41  | 782  | 1079 | 1317 | 1345 | 388  |
| 2038 | 1126 | 1120 | 589  | 1475 | 1091 | 956  | 51  | 968  | 1146 | 1553 | 1583 | 522  |
| 2039 | 1196 | 1185 | 666  | 1505 | 1187 | 1010 | 59  | 1156 | 1209 | 1760 | 1792 | 695  |
| 2040 | 1258 | 1244 | 768  | 1556 | 1272 | 1086 | 69  | 1388 | 1268 | 1937 | 1968 | 903  |
| 2041 | 1322 | 1307 | 865  | 1604 | 1341 | 1163 | 104 | 1593 | 1336 | 2138 | 2176 | 1110 |
| 2042 | 1407 | 1393 | 977  | 1656 | 1397 | 1265 | 117 | 1794 | 1422 | 2339 | 2365 | 1257 |
| 2043 | 1485 | 1489 | 1054 | 1746 | 1445 | 1341 | 137 | 1999 | 1515 | 2539 | 2564 | 1418 |
| 2044 | 1534 | 1538 | 1145 | 1786 | 1488 | 1393 | 156 | 2171 | 1562 | 2705 | 2729 | 1587 |
| 2045 | 1573 | 1581 | 1211 | 1836 | 1554 | 1453 | 174 | 2348 | 1605 | 2910 | 2928 | 1804 |
| 2046 | 1656 | 1664 | 1298 | 1895 | 1622 | 1513 | 192 | 2546 | 1681 | 3074 | 3097 | 1944 |
| 2047 | 1690 | 1695 | 1377 | 1940 | 1680 | 1590 | 208 | 2737 | 1713 | 3203 | 3229 | 2133 |
| 2048 | 1757 | 1751 | 1458 | 1984 | 1772 | 1643 | 244 | 2913 | 1766 | 3355 | 3382 | 2339 |
| 2049 | 1800 | 1789 | 1501 | 2023 | 1823 | 1707 | 268 | 3127 | 1804 | 3440 | 3466 | 2533 |
| 2050 | 1859 | 1841 | 1551 | 2060 | 1883 | 1727 | 291 | 3261 | 1852 | 3516 | 3555 | 2656 |
| 2051 | 1898 | 1882 | 1601 | 2102 | 1924 | 1756 | 311 | 3363 | 1889 | 3581 | 3621 | 2764 |
| 2052 | 1935 | 1926 | 1656 | 2151 | 1962 | 1787 | 331 | 3467 | 1931 | 3615 | 3650 | 2851 |
| 2053 | 1965 | 1966 | 1699 | 2194 | 1989 | 1802 | 352 | 3578 | 1972 | 3649 | 3682 | 2910 |
| 2054 | 1993 | 1995 | 1734 | 2231 | 2018 | 1815 | 375 | 3690 | 2008 | 3677 | 3712 | 2974 |
| 2055 | 2018 | 2024 | 1768 | 2279 | 2053 | 1827 | 377 | 3785 | 2038 | 3692 | 3730 | 3012 |
| 2056 | 2034 | 2038 | 1783 | 2316 | 2082 | 1836 | 377 | 3828 | 2053 | 3716 | 3757 | 3053 |
| 2057 | 2064 | 2071 | 1813 | 2365 | 2119 | 1840 | 377 | 3873 | 2086 | 3732 | 3774 | 3085 |
| 2058 | 2080 | 2088 | 1820 | 2395 | 2131 | 1840 | 377 | 3929 | 2105 | 3734 | 3777 | 3109 |
| 2059 | 2102 | 2108 | 1834 | 2427 | 2161 | 1840 | 377 | 3986 | 2126 | 3739 | 3781 | 3115 |

|      | 145  | 146  | 147  | 148  | 149  | 150  | 151 | 152  | 153  | 154  | 155  | 156  |
|------|------|------|------|------|------|------|-----|------|------|------|------|------|
| 2060 | 2122 | 2126 | 1842 | 2451 | 2188 | 1840 | 377 | 4017 | 2145 | 3740 | 3782 | 3120 |
| 2061 | 2148 | 2147 | 1849 | 2469 | 2203 | 1840 | 377 | 4068 | 2166 | 3746 | 3786 | 3122 |
| 2062 | 2176 | 2173 | 1867 | 2475 | 2225 | 1840 | 377 | 4111 | 2192 | 3748 | 3790 | 3123 |
| 2063 | 2190 | 2185 | 1882 | 2475 | 2246 | 1840 | 377 | 4158 | 2204 | 3748 | 3790 | 3124 |
| 2064 | 2201 | 2198 | 1893 | 2475 | 2267 | 1840 | 377 | 4188 | 2217 | 3748 | 3790 | 3124 |
| 2065 | 2201 | 2198 | 1899 | 2475 | 2284 | 1840 | 377 | 4233 | 2217 | 3748 | 3790 | 3125 |
| 2066 | 2201 | 2198 | 1901 | 2475 | 2298 | 1840 | 377 | 4261 | 2217 | 3748 | 3790 | 3125 |
| 2067 | 2201 | 2198 | 1901 | 2475 | 2309 | 1840 | 377 | 4291 | 2217 | 3748 | 3790 | 3125 |
| 2068 | 2201 | 2198 | 1901 | 2475 | 2315 | 1840 | 377 | 4315 | 2217 | 3748 | 3790 | 3125 |
| 2069 | 2201 | 2198 | 1901 | 2475 | 2315 | 1840 | 377 | 4330 | 2217 | 3748 | 3790 | 3125 |
| 2070 | 2201 | 2198 | 1901 | 2475 | 2315 | 1840 | 377 | 4359 | 2217 | 3748 | 3790 | 3125 |
| 2071 | 2201 | 2198 | 1901 | 2475 | 2315 | 1840 | 377 | 4378 | 2217 | 3748 | 3790 | 3125 |
| 2072 | 2201 | 2198 | 1901 | 2475 | 2315 | 1840 | 377 | 4400 | 2217 | 3748 | 3790 | 3125 |
| 2073 | 2201 | 2198 | 1901 | 2475 | 2315 | 1840 | 377 | 4417 | 2217 | 3748 | 3790 | 3125 |
| 2074 | 2201 | 2198 | 1901 | 2475 | 2315 | 1840 | 377 | 4438 | 2217 | 3748 | 3790 | 3125 |
| 2075 | 2201 | 2198 | 1901 | 2475 | 2315 | 1840 | 377 | 4463 | 2217 | 3748 | 3790 | 3125 |
| 2076 | 2201 | 2198 | 1901 | 2475 | 2315 | 1840 | 377 | 4475 | 2217 | 3748 | 3790 | 3125 |
| 2077 | 2201 | 2198 | 1901 | 2475 | 2315 | 1840 | 377 | 4489 | 2217 | 3748 | 3790 | 3125 |
| 2078 | 2201 | 2198 | 1901 | 2475 | 2315 | 1840 | 377 | 4489 | 2217 | 3748 | 3790 | 3125 |
| 2079 | 2201 | 2198 | 1901 | 2475 | 2315 | 1840 | 377 | 4489 | 2217 | 3748 | 3790 | 3125 |
| 2080 | 2201 | 2198 | 1901 | 2475 | 2315 | 1840 | 377 | 4489 | 2217 | 3748 | 3790 | 3125 |
| 2081 | 2201 | 2198 | 1901 | 2475 | 2315 | 1840 | 377 | 4489 | 2217 | 3748 | 3790 | 3125 |
| 2082 | 2201 | 2198 | 1901 | 2475 | 2315 | 1840 | 377 | 4489 | 2217 | 3748 | 3790 | 3125 |
| 2083 | 2201 | 2198 | 1901 | 2475 | 2315 | 1840 | 377 | 4489 | 2217 | 3748 | 3790 | 3125 |
| 2084 | 2201 | 2198 | 1901 | 2475 | 2315 | 1840 | 377 | 4489 | 2217 | 3748 | 3790 | 3125 |
| 2085 | 2201 | 2198 | 1901 | 2475 | 2315 | 1840 | 377 | 4489 | 2217 | 3748 | 3790 | 3125 |
| 2086 | 2201 | 2198 | 1901 | 2475 | 2315 | 1840 | 377 | 4489 | 2217 | 3748 | 3790 | 3125 |
| 2087 | 2201 | 2198 | 1901 | 2475 | 2315 | 1840 | 377 | 4489 | 2217 | 3748 | 3790 | 3125 |
| 2088 | 2201 | 2198 | 1901 | 2475 | 2315 | 1840 | 377 | 4489 | 2217 | 3748 | 3790 | 3125 |
| 2089 | 2201 | 2198 | 1901 | 2475 | 2315 | 1840 | 377 | 4489 | 2217 | 3748 | 3790 | 3125 |
| 2090 | 2201 | 2198 | 1901 | 2475 | 2315 | 1840 | 377 | 4489 | 2217 | 3748 | 3790 | 3125 |



|      | 157  | 158  | 159  | 160  | 161  | 162  |
|------|------|------|------|------|------|------|
| 2002 | 0    | 0    | 0    | 0    | 0    | 0    |
| 2003 | 0    | 0    | 0    | 0    | 0    | 0    |
| 2004 | 0    | 0    | 0    | 0    | 0    | 0    |
| 2005 | 0    | 0    | 0    | 0    | 0    | 0    |
| 2006 | 0    | 0    | 0    | 0    | 0    | 0    |
| 2007 | 0    | 0    | 0    | 0    | 0    | 0    |
| 2008 | 0    | 0    | 0    | 0    | 0    | 0    |
| 2009 | 0    | 0    | 0    | 0    | 0    | 0    |
| 2010 | 0    | 0    | 0    | 0    | 0    | 0    |
| 2011 | 0    | 0    | 0    | 0    | 0    | 0    |
| 2012 | 0    | 0    | 0    | 0    | 0    | 0    |
| 2013 | 0    | 0    | 0    | 0    | 0    | 0    |
| 2014 | 0    | 0    | 0    | 0    | 0    | 0    |
| 2015 | 0    | 0    | 0    | 0    | 0    | 0    |
| 2016 | 0    | 0    | 0    | 0    | 0    | 0    |
| 2017 | 0    | 0    | 0    | 0    | 0    | 0    |
| 2018 | 0    | 0    | 0    | 0    | 0    | 0    |
| 2019 | 0    | 0    | 0    | 0    | 0    | 0    |
| 2020 | 0    | 0    | 0    | 0    | 0    | 0    |
| 2021 | 3    | 0    | 0    | 0    | 0    | 0    |
| 2022 | 24   | 0    | 0    | 0    | 0    | 0    |
| 2023 | 48   | 0    | 0    | 0    | 0    | 0    |
| 2024 | 125  | 0    | 0    | 0    | 0    | 0    |
| 2025 | 220  | 0    | 0    | 0    | 0    | 0    |
| 2026 | 347  | 0    | 15   | 40   | 1    | 1    |
| 2027 | 520  | 20   | 57   | 136  | 3    | 19   |
| 2028 | 745  | 33   | 135  | 259  | 5    | 49   |
| 2029 | 910  | 65   | 238  | 390  | 8    | 105  |
| 2030 | 1107 | 148  | 347  | 484  | 16   | 177  |
| 2031 | 1269 | 229  | 470  | 650  | 23   | 277  |
| 2032 | 1475 | 306  | 541  | 773  | 52   | 439  |
| 2033 | 1675 | 452  | 644  | 880  | 111  | 573  |
| 2034 | 1920 | 598  | 785  | 984  | 160  | 791  |
| 2035 | 2141 | 736  | 915  | 1091 | 216  | 980  |
| 2036 | 2335 | 929  | 1020 | 1208 | 294  | 1168 |
| 2037 | 2532 | 1216 | 1148 | 1318 | 392  | 1349 |
| 2038 | 2712 | 1429 | 1281 | 1396 | 481  | 1587 |
| 2039 | 2892 | 1688 | 1432 | 1459 | 618  | 1800 |
| 2040 | 3067 | 1944 | 1572 | 1540 | 750  | 1982 |
| 2041 | 3259 | 2232 | 1710 | 1621 | 937  | 2185 |
| 2042 | 3438 | 2450 | 1877 | 1713 | 1121 | 2388 |
| 2043 | 3627 | 2679 | 2042 | 1771 | 1322 | 2589 |
| 2044 | 3769 | 2897 | 2179 | 1850 | 1531 | 2763 |
| 2045 | 3894 | 3157 | 2287 | 1899 | 1802 | 2962 |
| 2046 | 4025 | 3399 | 2370 | 1955 | 2078 | 3126 |
| 2047 | 4165 | 3611 | 2482 | 1977 | 2372 | 3255 |
| 2048 | 4243 | 3783 | 2543 | 2010 | 2564 | 3408 |
| 2049 | 4277 | 3893 | 2606 | 2027 | 2778 | 3494 |
| 2050 | 4307 | 3967 | 2665 | 2029 | 3006 | 3578 |
| 2051 | 4340 | 4052 | 2694 | 2030 | 3205 | 3642 |
| 2052 | 4361 | 4136 | 2720 | 2036 | 3401 | 3673 |
| 2053 | 4372 | 4214 | 2731 | 2036 | 3638 | 3702 |
| 2054 | 4385 | 4267 | 2742 | 2036 | 3788 | 3722 |
| 2055 | 4400 | 4327 | 2748 | 2036 | 3939 | 3739 |
| 2056 | 4416 | 4340 | 2748 | 2036 | 4080 | 3764 |
| 2057 | 4436 | 4367 | 2748 | 2036 | 4225 | 3781 |
| 2058 | 4449 | 4385 | 2748 | 2036 | 4316 | 3782 |
| 2059 | 4463 | 4392 | 2748 | 2036 | 4406 | 3786 |

|      | 157  | 158  | 159  | 160  | 161  | 162  |
|------|------|------|------|------|------|------|
| 2060 | 4464 | 4404 | 2748 | 2036 | 4508 | 3786 |
| 2061 | 4464 | 4410 | 2748 | 2036 | 4596 | 3789 |
| 2062 | 4464 | 4414 | 2748 | 2036 | 4671 | 3793 |
| 2063 | 4464 | 4417 | 2748 | 2036 | 4730 | 3793 |
| 2064 | 4464 | 4419 | 2748 | 2036 | 4765 | 3793 |
| 2065 | 4464 | 4420 | 2748 | 2036 | 4800 | 3793 |
| 2066 | 4464 | 4422 | 2748 | 2036 | 4810 | 3793 |
| 2067 | 4464 | 4422 | 2748 | 2036 | 4827 | 3793 |
| 2068 | 4464 | 4422 | 2748 | 2036 | 4857 | 3793 |
| 2069 | 4464 | 4422 | 2748 | 2036 | 4869 | 3793 |
| 2070 | 4464 | 4422 | 2748 | 2036 | 4880 | 3793 |
| 2071 | 4464 | 4422 | 2748 | 2036 | 4881 | 3793 |
| 2072 | 4464 | 4422 | 2748 | 2036 | 4885 | 3793 |
| 2073 | 4464 | 4422 | 2748 | 2036 | 4885 | 3793 |
| 2074 | 4464 | 4422 | 2748 | 2036 | 4887 | 3793 |
| 2075 | 4464 | 4422 | 2748 | 2036 | 4892 | 3793 |
| 2076 | 4464 | 4422 | 2748 | 2036 | 4892 | 3793 |
| 2077 | 4464 | 4422 | 2748 | 2036 | 4892 | 3793 |
| 2078 | 4464 | 4422 | 2748 | 2036 | 4892 | 3793 |
| 2079 | 4464 | 4422 | 2748 | 2036 | 4892 | 3793 |
| 2080 | 4464 | 4422 | 2748 | 2036 | 4892 | 3793 |
| 2081 | 4464 | 4422 | 2748 | 2036 | 4892 | 3793 |
| 2082 | 4464 | 4422 | 2748 | 2036 | 4892 | 3793 |
| 2083 | 4464 | 4422 | 2748 | 2036 | 4892 | 3793 |
| 2084 | 4464 | 4422 | 2748 | 2036 | 4892 | 3793 |
| 2085 | 4464 | 4422 | 2748 | 2036 | 4892 | 3793 |
| 2086 | 4464 | 4422 | 2748 | 2036 | 4892 | 3793 |
| 2087 | 4464 | 4422 | 2748 | 2036 | 4892 | 3793 |
| 2088 | 4464 | 4422 | 2748 | 2036 | 4892 | 3793 |
| 2089 | 4464 | 4422 | 2748 | 2036 | 4892 | 3793 |
| 2090 | 4464 | 4422 | 2748 | 2036 | 4892 | 3793 |

|      | 1    | 2   | 3   | 4   | 5   | 6   | 7   | 8   | 9   | 10   | 11  |
|------|------|-----|-----|-----|-----|-----|-----|-----|-----|------|-----|
| 2002 | 0    | 0   | 0   | 0   | 0   | 0   | 0   | 0   | 0   | 0    | 0   |
| 2003 | 0    | 0   | 0   | 0   | 0   | 0   | 0   | 0   | 0   | 0    | 0   |
| 2004 | 0    | 0   | 0   | 0   | 0   | 0   | 0   | 0   | 0   | 0    | 0   |
| 2005 | 0    | 0   | 0   | 0   | 0   | 0   | 0   | 0   | 0   | 0    | 0   |
| 2006 | 0    | 0   | 0   | 0   | 0   | 0   | 0   | 0   | 0   | 0    | 0   |
| 2007 | 0    | 0   | 0   | 0   | 0   | 0   | 0   | 0   | 0   | 0    | 0   |
| 2008 | 0    | 0   | 0   | 0   | 0   | 0   | 0   | 0   | 0   | 0    | 0   |
| 2009 | 0    | 0   | 0   | 0   | 0   | 0   | 0   | 0   | 0   | 0    | 0   |
| 2010 | 0    | 0   | 0   | 0   | 0   | 0   | 0   | 0   | 0   | 0    | 0   |
| 2011 | 0    | 0   | 0   | 0   | 0   | 0   | 0   | 0   | 0   | 0    | 0   |
| 2012 | 0    | 0   | 0   | 0   | 0   | 0   | 0   | 0   | 0   | 0    | 0   |
| 2013 | 0    | 0   | 0   | 0   | 0   | 0   | 0   | 0   | 0   | 0    | 0   |
| 2014 | 0    | 0   | 0   | 0   | 0   | 0   | 0   | 0   | 0   | 0    | 0   |
| 2015 | 0    | 0   | 0   | 0   | 0   | 0   | 0   | 0   | 0   | 0    | 0   |
| 2016 | 0    | 0   | 0   | 0   | 0   | 0   | 0   | 0   | 0   | 0    | 0   |
| 2017 | 0    | 0   | 0   | 0   | 0   | 0   | 0   | 0   | 0   | 0    | 0   |
| 2018 | 0    | 0   | 0   | 0   | 0   | 0   | 0   | 0   | 0   | 0    | 0   |
| 2019 | 0    | 0   | 0   | 0   | 0   | 0   | 0   | 0   | 0   | 0    | 0   |
| 2020 | 0    | 0   | 0   | 0   | 0   | 0   | 0   | 0   | 0   | 0    | 0   |
| 2021 | 0    | 0   | 0   | 0   | 0   | 0   | 0   | 0   | 0   | 0    | 0   |
| 2022 | 0    | 0   | 0   | 0   | 0   | 0   | 0   | 0   | 0   | 0    | 0   |
| 2023 | 0    | 0   | 0   | 0   | 0   | 0   | 0   | 0   | 0   | 0    | 0   |
| 2024 | 0    | 0   | 0   | 0   | 0   | 0   | 0   | 0   | 0   | 0    | 0   |
| 2025 | 0    | 0   | 0   | 0   | 0   | 0   | 0   | 0   | 0   | 0    | 0   |
| 2026 | 0    | 0   | 0   | 0   | 0   | 0   | 0   | 0   | 0   | 0    | 0   |
| 2027 | 0    | 0   | 0   | 0   | 0   | 0   | 0   | 0   | 0   | 10   | 0   |
| 2028 | 0    | 0   | 0   | 0   | 0   | 0   | 0   | 0   | 0   | 10   | 0   |
| 2029 | 0    | 0   | 0   | 0   | 0   | 0   | 0   | 0   | 0   | 24   | 4   |
| 2030 | 0    | 0   | 0   | 0   | 0   | 0   | 0   | 0   | 0   | 38   | 4   |
| 2031 | 0    | 0   | 0   | 0   | 0   | 0   | 0   | 0   | 0   | 54   | 4   |
| 2032 | 0    | 0   | 0   | 0   | 0   | 0   | 0   | 0   | 0   | 94   | 9   |
| 2033 | 6    | 0   | 0   | 9   | 0   | 0   | 0   | 0   | 0   | 130  | 17  |
| 2034 | 6    | 0   | 0   | 9   | 0   | 0   | 0   | 0   | 0   | 146  | 22  |
| 2035 | 6    | 0   | 0   | 13  | 0   | 0   | 0   | 0   | 0   | 163  | 27  |
| 2036 | 26   | 0   | 0   | 22  | 0   | 0   | 0   | 0   | 0   | 216  | 27  |
| 2037 | 31   | 0   | 0   | 29  | 0   | 10  | 0   | 0   | 0   | 265  | 27  |
| 2038 | 38   | 0   | 0   | 35  | 0   | 24  | 0   | 0   | 0   | 297  | 47  |
| 2039 | 64   | 0   | 0   | 56  | 0   | 24  | 10  | 10  | 10  | 331  | 58  |
| 2040 | 89   | 0   | 0   | 66  | 0   | 25  | 16  | 16  | 16  | 350  | 61  |
| 2041 | 95   | 0   | 0   | 94  | 0   | 25  | 35  | 35  | 35  | 373  | 84  |
| 2042 | 123  | 12  | 0   | 170 | 0   | 34  | 49  | 49  | 49  | 405  | 105 |
| 2043 | 145  | 12  | 0   | 287 | 11  | 34  | 66  | 66  | 66  | 439  | 120 |
| 2044 | 227  | 12  | 0   | 381 | 31  | 52  | 92  | 92  | 92  | 458  | 122 |
| 2045 | 334  | 24  | 1   | 528 | 68  | 89  | 127 | 127 | 127 | 493  | 122 |
| 2046 | 456  | 25  | 1   | 660 | 118 | 150 | 162 | 162 | 162 | 522  | 123 |
| 2047 | 621  | 25  | 1   | 739 | 171 | 210 | 212 | 212 | 212 | 545  | 123 |
| 2048 | 773  | 45  | 35  | 775 | 247 | 303 | 305 | 305 | 305 | 565  | 126 |
| 2049 | 849  | 75  | 72  | 807 | 324 | 391 | 393 | 393 | 393 | 602  | 133 |
| 2050 | 983  | 107 | 115 | 807 | 383 | 424 | 437 | 437 | 437 | 684  | 149 |
| 2051 | 1159 | 130 | 155 | 814 | 449 | 509 | 512 | 512 | 512 | 785  | 169 |
| 2052 | 1284 | 170 | 245 | 814 | 571 | 609 | 603 | 603 | 603 | 925  | 171 |
| 2053 | 1365 | 192 | 287 | 814 | 681 | 698 | 698 | 698 | 698 | 1104 | 181 |
| 2054 | 1427 | 251 | 369 | 814 | 755 | 765 | 765 | 765 | 765 | 1255 | 215 |
| 2055 | 1434 | 289 | 411 | 814 | 790 | 789 | 789 | 789 | 789 | 1350 | 242 |
| 2056 | 1442 | 290 | 444 | 814 | 797 | 797 | 797 | 797 | 797 | 1395 | 256 |
| 2057 | 1442 | 308 | 535 | 814 | 807 | 806 | 806 | 806 | 806 | 1431 | 272 |
| 2058 | 1449 | 308 | 626 | 814 | 807 | 807 | 807 | 807 | 807 | 1442 | 301 |
| 2059 | 1449 | 313 | 683 | 814 | 814 | 814 | 807 | 807 | 807 | 1442 | 311 |

|      | 1    | 2   | 3   | 4   | 5   | 6   | 7   | 8   | 9   | 10   | 11  |
|------|------|-----|-----|-----|-----|-----|-----|-----|-----|------|-----|
| 2060 | 1449 | 313 | 755 | 814 | 814 | 814 | 807 | 807 | 807 | 1448 | 312 |
| 2061 | 1449 | 313 | 770 | 814 | 814 | 814 | 807 | 807 | 807 | 1448 | 312 |
| 2062 | 1449 | 313 | 800 | 814 | 814 | 814 | 807 | 807 | 807 | 1448 | 312 |
| 2063 | 1449 | 313 | 806 | 814 | 814 | 814 | 807 | 807 | 807 | 1448 | 312 |
| 2064 | 1449 | 313 | 812 | 814 | 814 | 814 | 807 | 807 | 807 | 1448 | 312 |
| 2065 | 1449 | 313 | 812 | 814 | 814 | 814 | 807 | 807 | 807 | 1448 | 312 |
| 2066 | 1449 | 313 | 814 | 814 | 814 | 814 | 807 | 807 | 807 | 1448 | 312 |
| 2067 | 1449 | 313 | 814 | 814 | 814 | 814 | 807 | 807 | 807 | 1448 | 312 |
| 2068 | 1449 | 313 | 814 | 814 | 814 | 814 | 807 | 807 | 807 | 1448 | 312 |
| 2069 | 1449 | 313 | 814 | 814 | 814 | 814 | 807 | 807 | 807 | 1448 | 312 |
| 2070 | 1449 | 313 | 814 | 814 | 814 | 814 | 807 | 807 | 807 | 1448 | 312 |
| 2071 | 1449 | 313 | 814 | 814 | 814 | 814 | 807 | 807 | 807 | 1448 | 312 |
| 2072 | 1449 | 313 | 814 | 814 | 814 | 814 | 807 | 807 | 807 | 1448 | 312 |
| 2073 | 1449 | 313 | 814 | 814 | 814 | 814 | 807 | 807 | 807 | 1448 | 312 |
| 2074 | 1449 | 313 | 814 | 814 | 814 | 814 | 807 | 807 | 807 | 1448 | 312 |
| 2075 | 1449 | 313 | 814 | 814 | 814 | 814 | 807 | 807 | 807 | 1448 | 312 |
| 2076 | 1449 | 313 | 814 | 814 | 814 | 814 | 807 | 807 | 807 | 1448 | 312 |
| 2077 | 1449 | 313 | 814 | 814 | 814 | 814 | 807 | 807 | 807 | 1448 | 312 |
| 2078 | 1449 | 313 | 814 | 814 | 814 | 814 | 807 | 807 | 807 | 1448 | 312 |
| 2079 | 1449 | 313 | 814 | 814 | 814 | 814 | 807 | 807 | 807 | 1448 | 312 |
| 2080 | 1449 | 313 | 814 | 814 | 814 | 814 | 807 | 807 | 807 | 1448 | 312 |
| 2081 | 1449 | 313 | 814 | 814 | 814 | 814 | 807 | 807 | 807 | 1448 | 312 |
| 2082 | 1449 | 313 | 814 | 814 | 814 | 814 | 807 | 807 | 807 | 1448 | 312 |
| 2083 | 1449 | 313 | 814 | 814 | 814 | 814 | 807 | 807 | 807 | 1448 | 312 |
| 2084 | 1449 | 313 | 814 | 814 | 814 | 814 | 807 | 807 | 807 | 1448 | 312 |
| 2085 | 1449 | 313 | 814 | 814 | 814 | 814 | 807 | 807 | 807 | 1448 | 312 |
| 2086 | 1449 | 313 | 814 | 814 | 814 | 814 | 807 | 807 | 807 | 1448 | 312 |
| 2087 | 1449 | 313 | 814 | 814 | 814 | 814 | 807 | 807 | 807 | 1448 | 312 |
| 2088 | 1449 | 313 | 814 | 814 | 814 | 814 | 807 | 807 | 807 | 1448 | 312 |
| 2089 | 1449 | 313 | 814 | 814 | 814 | 814 | 807 | 807 | 807 | 1448 | 312 |
| 2090 | 1449 | 313 | 814 | 814 | 814 | 814 | 807 | 807 | 807 | 1448 | 312 |

|      | 12  | 13  | 14  | 15  | 16  | 17  | 18  | 19   | 20  | 21  | 22  |
|------|-----|-----|-----|-----|-----|-----|-----|------|-----|-----|-----|
| 2002 | 0   | 0   | 0   | 0   | 0   | 0   | 0   | 0    | 0   | 0   | 0   |
| 2003 | 0   | 0   | 0   | 0   | 0   | 0   | 0   | 0    | 0   | 0   | 0   |
| 2004 | 0   | 0   | 0   | 0   | 0   | 0   | 0   | 0    | 0   | 0   | 0   |
| 2005 | 0   | 0   | 0   | 0   | 0   | 0   | 0   | 0    | 0   | 0   | 0   |
| 2006 | 0   | 0   | 0   | 0   | 0   | 0   | 0   | 0    | 0   | 0   | 0   |
| 2007 | 0   | 0   | 0   | 0   | 0   | 0   | 0   | 0    | 0   | 0   | 0   |
| 2008 | 0   | 0   | 0   | 0   | 0   | 0   | 0   | 0    | 0   | 0   | 0   |
| 2009 | 0   | 0   | 0   | 0   | 0   | 0   | 0   | 0    | 0   | 0   | 0   |
| 2010 | 0   | 0   | 0   | 0   | 0   | 0   | 0   | 0    | 0   | 0   | 0   |
| 2011 | 0   | 0   | 0   | 0   | 0   | 0   | 0   | 0    | 0   | 0   | 0   |
| 2012 | 0   | 0   | 0   | 0   | 0   | 0   | 0   | 0    | 0   | 0   | 0   |
| 2013 | 0   | 0   | 0   | 0   | 0   | 0   | 0   | 0    | 0   | 0   | 0   |
| 2014 | 0   | 0   | 0   | 0   | 0   | 0   | 0   | 0    | 0   | 0   | 0   |
| 2015 | 0   | 0   | 0   | 0   | 0   | 0   | 0   | 0    | 0   | 0   | 0   |
| 2016 | 0   | 0   | 0   | 0   | 0   | 0   | 0   | 0    | 0   | 0   | 0   |
| 2017 | 0   | 0   | 0   | 0   | 0   | 0   | 0   | 0    | 0   | 0   | 0   |
| 2018 | 0   | 0   | 0   | 0   | 0   | 0   | 0   | 0    | 0   | 0   | 0   |
| 2019 | 0   | 0   | 0   | 0   | 0   | 0   | 0   | 0    | 0   | 0   | 0   |
| 2020 | 0   | 0   | 0   | 0   | 0   | 0   | 0   | 0    | 0   | 0   | 0   |
| 2021 | 0   | 5   | 0   | 0   | 0   | 0   | 0   | 0    | 0   | 0   | 1   |
| 2022 | 0   | 5   | 0   | 0   | 0   | 0   | 0   | 0    | 0   | 0   | 1   |
| 2023 | 0   | 11  | 0   | 0   | 0   | 0   | 0   | 0    | 0   | 0   | 2   |
| 2024 | 0   | 16  | 0   | 0   | 0   | 0   | 0   | 0    | 0   | 0   | 10  |
| 2025 | 0   | 30  | 0   | 0   | 0   | 0   | 0   | 0    | 0   | 0   | 17  |
| 2026 | 0   | 51  | 0   | 0   | 0   | 0   | 0   | 0    | 0   | 0   | 31  |
| 2027 | 0   | 71  | 0   | 10  | 10  | 4   | 10  | 8    | 0   | 0   | 46  |
| 2028 | 0   | 85  | 0   | 10  | 10  | 4   | 10  | 8    | 0   | 0   | 67  |
| 2029 | 0   | 92  | 8   | 10  | 11  | 4   | 11  | 17   | 4   | 0   | 72  |
| 2030 | 0   | 119 | 20  | 31  | 20  | 13  | 20  | 23   | 4   | 0   | 81  |
| 2031 | 0   | 159 | 20  | 43  | 28  | 21  | 28  | 31   | 4   | 0   | 91  |
| 2032 | 0   | 197 | 28  | 74  | 45  | 38  | 45  | 49   | 4   | 0   | 100 |
| 2033 | 0   | 230 | 32  | 91  | 70  | 63  | 70  | 81   | 16  | 0   | 140 |
| 2034 | 0   | 278 | 32  | 109 | 77  | 70  | 77  | 97   | 22  | 0   | 167 |
| 2035 | 10  | 305 | 32  | 116 | 78  | 71  | 78  | 110  | 27  | 10  | 203 |
| 2036 | 11  | 325 | 33  | 134 | 88  | 81  | 88  | 124  | 27  | 11  | 223 |
| 2037 | 21  | 331 | 60  | 152 | 113 | 106 | 113 | 151  | 27  | 11  | 240 |
| 2038 | 31  | 359 | 69  | 188 | 142 | 135 | 142 | 175  | 27  | 11  | 267 |
| 2039 | 34  | 362 | 82  | 225 | 170 | 163 | 170 | 239  | 36  | 21  | 298 |
| 2040 | 44  | 373 | 86  | 252 | 187 | 180 | 187 | 288  | 51  | 23  | 337 |
| 2041 | 52  | 373 | 94  | 278 | 206 | 199 | 206 | 318  | 54  | 33  | 360 |
| 2042 | 62  | 377 | 116 | 300 | 231 | 224 | 231 | 341  | 61  | 41  | 366 |
| 2043 | 94  | 390 | 140 | 312 | 262 | 255 | 262 | 376  | 77  | 41  | 366 |
| 2044 | 117 | 404 | 168 | 321 | 283 | 276 | 283 | 419  | 102 | 52  | 366 |
| 2045 | 146 | 423 | 181 | 337 | 292 | 285 | 292 | 441  | 112 | 78  | 406 |
| 2046 | 154 | 435 | 199 | 342 | 292 | 285 | 292 | 461  | 112 | 105 | 477 |
| 2047 | 154 | 436 | 214 | 359 | 313 | 306 | 313 | 530  | 127 | 130 | 614 |
| 2048 | 180 | 441 | 251 | 368 | 322 | 315 | 322 | 610  | 141 | 140 | 724 |
| 2049 | 210 | 508 | 359 | 392 | 349 | 342 | 349 | 735  | 159 | 155 | 765 |
| 2050 | 275 | 643 | 396 | 405 | 385 | 378 | 385 | 845  | 171 | 247 | 785 |
| 2051 | 332 | 729 | 409 | 445 | 407 | 400 | 407 | 1008 | 171 | 301 | 798 |
| 2052 | 364 | 769 | 444 | 540 | 464 | 457 | 464 | 1183 | 201 | 349 | 798 |
| 2053 | 401 | 789 | 549 | 624 | 533 | 526 | 533 | 1304 | 228 | 382 | 804 |
| 2054 | 429 | 808 | 642 | 698 | 607 | 600 | 607 | 1367 | 251 | 417 | 804 |
| 2055 | 479 | 814 | 690 | 747 | 689 | 682 | 689 | 1404 | 256 | 439 | 804 |
| 2056 | 542 | 814 | 737 | 780 | 743 | 736 | 743 | 1425 | 282 | 494 | 804 |
| 2057 | 600 | 814 | 770 | 808 | 780 | 773 | 780 | 1440 | 309 | 557 | 804 |
| 2058 | 653 | 814 | 798 | 808 | 805 | 798 | 805 | 1440 | 310 | 630 | 804 |
| 2059 | 680 | 814 | 808 | 808 | 811 | 804 | 811 | 1441 | 311 | 663 | 804 |

|      | 12  | 13  | 14  | 15  | 16  | 17  | 18  | 19   | 20  | 21  | 22  |
|------|-----|-----|-----|-----|-----|-----|-----|------|-----|-----|-----|
| 2060 | 683 | 814 | 808 | 808 | 811 | 804 | 811 | 1441 | 311 | 690 | 804 |
| 2061 | 713 | 814 | 808 | 808 | 811 | 804 | 811 | 1441 | 312 | 723 | 804 |
| 2062 | 753 | 814 | 808 | 808 | 811 | 804 | 811 | 1441 | 312 | 760 | 804 |
| 2063 | 789 | 814 | 808 | 808 | 811 | 804 | 811 | 1441 | 312 | 790 | 804 |
| 2064 | 808 | 814 | 808 | 808 | 811 | 804 | 811 | 1441 | 312 | 808 | 804 |
| 2065 | 808 | 814 | 808 | 808 | 811 | 804 | 811 | 1441 | 312 | 808 | 804 |
| 2066 | 808 | 814 | 808 | 808 | 811 | 804 | 811 | 1441 | 312 | 808 | 804 |
| 2067 | 808 | 814 | 808 | 808 | 811 | 804 | 811 | 1441 | 312 | 808 | 804 |
| 2068 | 808 | 814 | 808 | 808 | 811 | 804 | 811 | 1441 | 312 | 808 | 804 |
| 2069 | 808 | 814 | 808 | 808 | 811 | 804 | 811 | 1441 | 312 | 808 | 804 |
| 2070 | 808 | 814 | 808 | 808 | 811 | 804 | 811 | 1441 | 312 | 808 | 804 |
| 2071 | 808 | 814 | 808 | 808 | 811 | 804 | 811 | 1441 | 312 | 808 | 804 |
| 2072 | 808 | 814 | 808 | 808 | 811 | 804 | 811 | 1441 | 312 | 808 | 804 |
| 2073 | 808 | 814 | 808 | 808 | 811 | 804 | 811 | 1441 | 312 | 808 | 804 |
| 2074 | 808 | 814 | 808 | 808 | 811 | 804 | 811 | 1441 | 312 | 808 | 804 |
| 2075 | 808 | 814 | 808 | 808 | 811 | 804 | 811 | 1441 | 312 | 808 | 804 |
| 2076 | 808 | 814 | 808 | 808 | 811 | 804 | 811 | 1441 | 312 | 808 | 804 |
| 2077 | 808 | 814 | 808 | 808 | 811 | 804 | 811 | 1441 | 312 | 808 | 804 |
| 2078 | 808 | 814 | 808 | 808 | 811 | 804 | 811 | 1441 | 312 | 808 | 804 |
| 2079 | 808 | 814 | 808 | 808 | 811 | 804 | 811 | 1441 | 312 | 808 | 804 |
| 2080 | 808 | 814 | 808 | 808 | 811 | 804 | 811 | 1441 | 312 | 808 | 804 |
| 2081 | 808 | 814 | 808 | 808 | 811 | 804 | 811 | 1441 | 312 | 808 | 804 |
| 2082 | 808 | 814 | 808 | 808 | 811 | 804 | 811 | 1441 | 312 | 808 | 804 |
| 2083 | 808 | 814 | 808 | 808 | 811 | 804 | 811 | 1441 | 312 | 808 | 804 |
| 2084 | 808 | 814 | 808 | 808 | 811 | 804 | 811 | 1441 | 312 | 808 | 804 |
| 2085 | 808 | 814 | 808 | 808 | 811 | 804 | 811 | 1441 | 312 | 808 | 804 |
| 2086 | 808 | 814 | 808 | 808 | 811 | 804 | 811 | 1441 | 312 | 808 | 804 |
| 2087 | 808 | 814 | 808 | 808 | 811 | 804 | 811 | 1441 | 312 | 808 | 804 |
| 2088 | 808 | 814 | 808 | 808 | 811 | 804 | 811 | 1441 | 312 | 808 | 804 |
| 2089 | 808 | 814 | 808 | 808 | 811 | 804 | 811 | 1441 | 312 | 808 | 804 |
| 2090 | 808 | 814 | 808 | 808 | 811 | 804 | 811 | 1441 | 312 | 808 | 804 |

|      | 23  | 24  | 25  | 26  | 27  | 28   | 29  | 30  | 31  | 32  | 33  |
|------|-----|-----|-----|-----|-----|------|-----|-----|-----|-----|-----|
| 2002 | 0   | 0   | 0   | 0   | 0   | 0    | 0   | 0   | 0   | 0   | 0   |
| 2003 | 0   | 0   | 0   | 0   | 0   | 0    | 0   | 0   | 0   | 0   | 0   |
| 2004 | 0   | 0   | 0   | 0   | 0   | 0    | 0   | 0   | 0   | 0   | 0   |
| 2005 | 0   | 0   | 0   | 0   | 0   | 0    | 0   | 0   | 0   | 0   | 0   |
| 2006 | 0   | 0   | 0   | 0   | 0   | 0    | 0   | 0   | 0   | 0   | 0   |
| 2007 | 0   | 0   | 0   | 0   | 0   | 0    | 0   | 0   | 0   | 0   | 0   |
| 2008 | 0   | 0   | 0   | 0   | 0   | 0    | 0   | 0   | 0   | 0   | 0   |
| 2009 | 0   | 0   | 0   | 0   | 0   | 0    | 0   | 0   | 0   | 0   | 0   |
| 2010 | 0   | 0   | 0   | 0   | 0   | 0    | 0   | 0   | 0   | 0   | 0   |
| 2011 | 0   | 0   | 0   | 0   | 0   | 0    | 0   | 0   | 0   | 0   | 0   |
| 2012 | 0   | 0   | 0   | 0   | 0   | 0    | 0   | 0   | 0   | 0   | 0   |
| 2013 | 0   | 0   | 0   | 0   | 0   | 0    | 0   | 0   | 0   | 0   | 0   |
| 2014 | 0   | 0   | 0   | 0   | 0   | 0    | 0   | 0   | 0   | 0   | 0   |
| 2015 | 0   | 0   | 0   | 0   | 0   | 0    | 0   | 0   | 0   | 0   | 0   |
| 2016 | 0   | 0   | 0   | 0   | 0   | 0    | 0   | 0   | 0   | 0   | 0   |
| 2017 | 0   | 0   | 0   | 0   | 0   | 0    | 0   | 0   | 0   | 0   | 0   |
| 2018 | 0   | 0   | 0   | 0   | 0   | 0    | 0   | 0   | 0   | 0   | 0   |
| 2019 | 0   | 0   | 0   | 0   | 0   | 0    | 0   | 0   | 0   | 0   | 0   |
| 2020 | 0   | 0   | 0   | 0   | 0   | 0    | 0   | 0   | 0   | 0   | 0   |
| 2021 | 0   | 0   | 0   | 0   | 0   | 0    | 0   | 0   | 0   | 0   | 0   |
| 2022 | 0   | 0   | 0   | 0   | 0   | 0    | 0   | 0   | 0   | 0   | 0   |
| 2023 | 0   | 0   | 0   | 0   | 0   | 0    | 0   | 0   | 0   | 0   | 0   |
| 2024 | 0   | 0   | 0   | 0   | 0   | 0    | 0   | 0   | 0   | 0   | 0   |
| 2025 | 0   | 0   | 0   | 0   | 0   | 0    | 0   | 0   | 0   | 0   | 0   |
| 2026 | 0   | 0   | 0   | 0   | 0   | 0    | 0   | 0   | 0   | 0   | 0   |
| 2027 | 0   | 9   | 10  | 0   | 8   | 0    | 0   | 0   | 0   | 0   | 0   |
| 2028 | 0   | 9   | 10  | 0   | 8   | 0    | 0   | 0   | 2   | 0   | 0   |
| 2029 | 8   | 17  | 11  | 0   | 9   | 0    | 0   | 0   | 4   | 0   | 0   |
| 2030 | 11  | 40  | 11  | 0   | 9   | 0    | 0   | 0   | 19  | 0   | 0   |
| 2031 | 11  | 50  | 20  | 9   | 18  | 0    | 0   | 0   | 26  | 0   | 1   |
| 2032 | 29  | 69  | 35  | 24  | 33  | 0    | 0   | 0   | 44  | 0   | 15  |
| 2033 | 47  | 83  | 65  | 54  | 63  | 12   | 0   | 0   | 67  | 0   | 39  |
| 2034 | 57  | 83  | 72  | 61  | 70  | 13   | 1   | 0   | 91  | 0   | 72  |
| 2035 | 57  | 92  | 80  | 69  | 78  | 19   | 4   | 0   | 95  | 0   | 103 |
| 2036 | 58  | 102 | 81  | 70  | 79  | 47   | 11  | 0   | 102 | 1   | 132 |
| 2037 | 58  | 151 | 100 | 89  | 98  | 85   | 23  | 0   | 107 | 1   | 136 |
| 2038 | 71  | 186 | 120 | 109 | 118 | 90   | 26  | 0   | 117 | 16  | 140 |
| 2039 | 72  | 216 | 148 | 137 | 146 | 138  | 34  | 2   | 124 | 23  | 146 |
| 2040 | 84  | 255 | 168 | 157 | 166 | 168  | 34  | 16  | 136 | 47  | 151 |
| 2041 | 85  | 283 | 179 | 168 | 177 | 178  | 38  | 25  | 165 | 59  | 164 |
| 2042 | 94  | 302 | 196 | 185 | 194 | 212  | 47  | 58  | 238 | 107 | 175 |
| 2043 | 117 | 302 | 223 | 212 | 221 | 235  | 47  | 65  | 354 | 143 | 194 |
| 2044 | 156 | 328 | 263 | 252 | 261 | 349  | 56  | 96  | 439 | 196 | 230 |
| 2045 | 185 | 330 | 273 | 262 | 271 | 474  | 69  | 113 | 541 | 241 | 291 |
| 2046 | 208 | 350 | 293 | 282 | 291 | 581  | 80  | 138 | 659 | 276 | 343 |
| 2047 | 229 | 374 | 303 | 292 | 301 | 689  | 96  | 177 | 739 | 318 | 388 |
| 2048 | 318 | 405 | 361 | 350 | 359 | 794  | 113 | 218 | 768 | 378 | 439 |
| 2049 | 371 | 418 | 400 | 389 | 398 | 898  | 129 | 255 | 795 | 438 | 513 |
| 2050 | 406 | 483 | 439 | 428 | 437 | 1020 | 162 | 298 | 804 | 521 | 591 |
| 2051 | 439 | 589 | 494 | 483 | 492 | 1150 | 191 | 341 | 807 | 595 | 654 |
| 2052 | 520 | 660 | 585 | 574 | 583 | 1254 | 224 | 389 | 811 | 667 | 710 |
| 2053 | 587 | 717 | 657 | 646 | 655 | 1336 | 251 | 435 | 814 | 722 | 753 |
| 2054 | 650 | 759 | 720 | 709 | 718 | 1392 | 274 | 495 | 814 | 764 | 789 |
| 2055 | 720 | 788 | 760 | 749 | 758 | 1430 | 293 | 550 | 814 | 794 | 802 |
| 2056 | 760 | 803 | 789 | 778 | 787 | 1435 | 302 | 602 | 814 | 803 | 804 |
| 2057 | 789 | 809 | 808 | 797 | 806 | 1443 | 306 | 653 | 814 | 805 | 811 |
| 2058 | 808 | 809 | 808 | 797 | 806 | 1444 | 310 | 697 | 814 | 811 | 811 |
| 2059 | 808 | 809 | 808 | 797 | 806 | 1448 | 311 | 733 | 814 | 813 | 811 |

|      | 23  | 24  | 25  | 26  | 27  | 28   | 29  | 30  | 31  | 32  | 33  |
|------|-----|-----|-----|-----|-----|------|-----|-----|-----|-----|-----|
| 2060 | 808 | 809 | 808 | 797 | 806 | 1448 | 311 | 766 | 814 | 813 | 811 |
| 2061 | 808 | 809 | 808 | 797 | 806 | 1448 | 311 | 790 | 814 | 813 | 811 |
| 2062 | 808 | 809 | 808 | 797 | 806 | 1448 | 311 | 806 | 814 | 813 | 811 |
| 2063 | 808 | 809 | 808 | 797 | 806 | 1448 | 311 | 809 | 814 | 813 | 811 |
| 2064 | 808 | 809 | 808 | 797 | 806 | 1448 | 311 | 810 | 814 | 813 | 811 |
| 2065 | 808 | 809 | 808 | 797 | 806 | 1448 | 311 | 812 | 814 | 813 | 811 |
| 2066 | 808 | 809 | 808 | 797 | 806 | 1448 | 311 | 814 | 814 | 813 | 811 |
| 2067 | 808 | 809 | 808 | 797 | 806 | 1448 | 311 | 814 | 814 | 813 | 811 |
| 2068 | 808 | 809 | 808 | 797 | 806 | 1448 | 311 | 814 | 814 | 813 | 811 |
| 2069 | 808 | 809 | 808 | 797 | 806 | 1448 | 311 | 814 | 814 | 813 | 811 |
| 2070 | 808 | 809 | 808 | 797 | 806 | 1448 | 311 | 814 | 814 | 813 | 811 |
| 2071 | 808 | 809 | 808 | 797 | 806 | 1448 | 311 | 814 | 814 | 813 | 811 |
| 2072 | 808 | 809 | 808 | 797 | 806 | 1448 | 311 | 814 | 814 | 813 | 811 |
| 2073 | 808 | 809 | 808 | 797 | 806 | 1448 | 311 | 814 | 814 | 813 | 811 |
| 2074 | 808 | 809 | 808 | 797 | 806 | 1448 | 311 | 814 | 814 | 813 | 811 |
| 2075 | 808 | 809 | 808 | 797 | 806 | 1448 | 311 | 814 | 814 | 813 | 811 |
| 2076 | 808 | 809 | 808 | 797 | 806 | 1448 | 311 | 814 | 814 | 813 | 811 |
| 2077 | 808 | 809 | 808 | 797 | 806 | 1448 | 311 | 814 | 814 | 813 | 811 |
| 2078 | 808 | 809 | 808 | 797 | 806 | 1448 | 311 | 814 | 814 | 813 | 811 |
| 2079 | 808 | 809 | 808 | 797 | 806 | 1448 | 311 | 814 | 814 | 813 | 811 |
| 2080 | 808 | 809 | 808 | 797 | 806 | 1448 | 311 | 814 | 814 | 813 | 811 |
| 2081 | 808 | 809 | 808 | 797 | 806 | 1448 | 311 | 814 | 814 | 813 | 811 |
| 2082 | 808 | 809 | 808 | 797 | 806 | 1448 | 311 | 814 | 814 | 813 | 811 |
| 2083 | 808 | 809 | 808 | 797 | 806 | 1448 | 311 | 814 | 814 | 813 | 811 |
| 2084 | 808 | 809 | 808 | 797 | 806 | 1448 | 311 | 814 | 814 | 813 | 811 |
| 2085 | 808 | 809 | 808 | 797 | 806 | 1448 | 311 | 814 | 814 | 813 | 811 |
| 2086 | 808 | 809 | 808 | 797 | 806 | 1448 | 311 | 814 | 814 | 813 | 811 |
| 2087 | 808 | 809 | 808 | 797 | 806 | 1448 | 311 | 814 | 814 | 813 | 811 |
| 2088 | 808 | 809 | 808 | 797 | 806 | 1448 | 311 | 814 | 814 | 813 | 811 |
| 2089 | 808 | 809 | 808 | 797 | 806 | 1448 | 311 | 814 | 814 | 813 | 811 |
| 2090 | 808 | 809 | 808 | 797 | 806 | 1448 | 311 | 814 | 814 | 813 | 811 |



|      | 34  | 35  | 36  | 37   | 38  | 39  | 40  | 41  | 42  | 43  | 44  |
|------|-----|-----|-----|------|-----|-----|-----|-----|-----|-----|-----|
| 2002 | 0   | 0   | 0   | 0    | 0   | 0   | 0   | 0   | 0   | 0   | 0   |
| 2003 | 0   | 0   | 0   | 0    | 0   | 0   | 0   | 0   | 0   | 0   | 0   |
| 2004 | 0   | 0   | 0   | 0    | 0   | 0   | 0   | 0   | 0   | 0   | 0   |
| 2005 | 0   | 0   | 0   | 0    | 0   | 0   | 0   | 0   | 0   | 0   | 0   |
| 2006 | 0   | 0   | 0   | 0    | 0   | 0   | 0   | 0   | 0   | 0   | 0   |
| 2007 | 0   | 0   | 0   | 0    | 0   | 0   | 0   | 0   | 0   | 0   | 0   |
| 2008 | 0   | 0   | 0   | 0    | 0   | 0   | 0   | 0   | 0   | 0   | 0   |
| 2009 | 0   | 0   | 0   | 0    | 0   | 0   | 0   | 0   | 0   | 0   | 0   |
| 2010 | 0   | 0   | 0   | 0    | 0   | 0   | 0   | 0   | 0   | 0   | 0   |
| 2011 | 0   | 0   | 0   | 0    | 0   | 0   | 0   | 0   | 0   | 0   | 0   |
| 2012 | 0   | 0   | 0   | 0    | 0   | 0   | 0   | 0   | 0   | 0   | 0   |
| 2013 | 0   | 0   | 0   | 0    | 0   | 0   | 0   | 0   | 0   | 0   | 0   |
| 2014 | 0   | 0   | 0   | 0    | 0   | 0   | 0   | 0   | 0   | 0   | 0   |
| 2015 | 0   | 0   | 0   | 0    | 0   | 0   | 0   | 0   | 0   | 0   | 0   |
| 2016 | 0   | 0   | 0   | 0    | 0   | 0   | 0   | 0   | 0   | 0   | 0   |
| 2017 | 0   | 0   | 0   | 0    | 0   | 0   | 0   | 0   | 0   | 0   | 0   |
| 2018 | 0   | 0   | 0   | 0    | 0   | 0   | 0   | 0   | 0   | 0   | 0   |
| 2019 | 0   | 0   | 0   | 0    | 0   | 0   | 0   | 0   | 0   | 0   | 0   |
| 2020 | 0   | 0   | 0   | 0    | 0   | 0   | 0   | 0   | 0   | 0   | 0   |
| 2021 | 0   | 0   | 0   | 0    | 0   | 0   | 5   | 0   | 0   | 0   | 0   |
| 2022 | 0   | 0   | 0   | 0    | 0   | 0   | 5   | 0   | 0   | 0   | 0   |
| 2023 | 0   | 0   | 0   | 0    | 0   | 0   | 16  | 0   | 0   | 0   | 0   |
| 2024 | 0   | 0   | 0   | 0    | 0   | 0   | 28  | 0   | 0   | 0   | 0   |
| 2025 | 0   | 0   | 0   | 0    | 0   | 0   | 41  | 0   | 0   | 0   | 0   |
| 2026 | 0   | 0   | 0   | 7    | 4   | 0   | 62  | 4   | 23  | 7   | 1   |
| 2027 | 0   | 0   | 0   | 16   | 6   | 0   | 78  | 13  | 44  | 13  | 3   |
| 2028 | 0   | 0   | 0   | 25   | 15  | 0   | 103 | 18  | 60  | 22  | 12  |
| 2029 | 0   | 0   | 0   | 47   | 32  | 0   | 124 | 34  | 84  | 42  | 32  |
| 2030 | 0   | 0   | 0   | 60   | 39  | 0   | 164 | 52  | 99  | 57  | 47  |
| 2031 | 0   | 0   | 0   | 77   | 51  | 2   | 209 | 68  | 117 | 73  | 63  |
| 2032 | 0   | 0   | 0   | 121  | 68  | 16  | 240 | 89  | 125 | 107 | 97  |
| 2033 | 1   | 1   | 1   | 157  | 84  | 29  | 271 | 104 | 149 | 132 | 122 |
| 2034 | 2   | 2   | 2   | 197  | 102 | 42  | 303 | 123 | 164 | 157 | 147 |
| 2035 | 8   | 8   | 8   | 225  | 120 | 62  | 318 | 139 | 185 | 182 | 172 |
| 2036 | 35  | 35  | 35  | 276  | 145 | 91  | 335 | 172 | 227 | 223 | 213 |
| 2037 | 60  | 60  | 60  | 310  | 151 | 126 | 346 | 202 | 258 | 248 | 238 |
| 2038 | 65  | 65  | 65  | 328  | 151 | 159 | 368 | 214 | 279 | 264 | 254 |
| 2039 | 93  | 93  | 93  | 361  | 151 | 187 | 375 | 227 | 307 | 279 | 269 |
| 2040 | 107 | 107 | 107 | 390  | 151 | 201 | 375 | 232 | 331 | 298 | 288 |
| 2041 | 116 | 116 | 116 | 421  | 153 | 233 | 375 | 254 | 341 | 316 | 306 |
| 2042 | 129 | 129 | 129 | 459  | 154 | 260 | 388 | 288 | 352 | 328 | 318 |
| 2043 | 136 | 136 | 136 | 496  | 158 | 278 | 409 | 310 | 356 | 338 | 328 |
| 2044 | 178 | 178 | 178 | 538  | 158 | 283 | 422 | 328 | 357 | 352 | 342 |
| 2045 | 224 | 224 | 224 | 564  | 161 | 283 | 429 | 337 | 362 | 361 | 351 |
| 2046 | 266 | 266 | 266 | 581  | 164 | 286 | 434 | 346 | 375 | 368 | 358 |
| 2047 | 319 | 319 | 319 | 596  | 165 | 296 | 445 | 355 | 391 | 377 | 367 |
| 2048 | 385 | 385 | 385 | 612  | 171 | 314 | 451 | 368 | 415 | 389 | 379 |
| 2049 | 445 | 445 | 445 | 639  | 173 | 346 | 564 | 417 | 476 | 405 | 395 |
| 2050 | 525 | 525 | 525 | 773  | 185 | 377 | 678 | 465 | 539 | 459 | 449 |
| 2051 | 601 | 601 | 601 | 886  | 200 | 411 | 748 | 523 | 614 | 522 | 512 |
| 2052 | 669 | 669 | 669 | 1014 | 218 | 446 | 775 | 591 | 680 | 590 | 580 |
| 2053 | 722 | 722 | 722 | 1141 | 239 | 486 | 794 | 663 | 737 | 655 | 645 |
| 2054 | 766 | 766 | 766 | 1268 | 262 | 534 | 806 | 728 | 771 | 721 | 711 |
| 2055 | 799 | 799 | 799 | 1347 | 281 | 586 | 813 | 766 | 791 | 762 | 752 |
| 2056 | 803 | 803 | 803 | 1395 | 295 | 647 | 813 | 787 | 805 | 788 | 778 |
| 2057 | 809 | 809 | 809 | 1424 | 303 | 697 | 813 | 802 | 810 | 805 | 795 |
| 2058 | 809 | 809 | 809 | 1438 | 311 | 731 | 813 | 810 | 814 | 810 | 800 |
| 2059 | 809 | 809 | 809 | 1445 | 313 | 752 | 813 | 810 | 814 | 810 | 800 |

|      | 34  | 35  | 36  | 37   | 38  | 39  | 40  | 41  | 42  | 43  | 44  |
|------|-----|-----|-----|------|-----|-----|-----|-----|-----|-----|-----|
| 2060 | 809 | 809 | 809 | 1445 | 313 | 768 | 813 | 813 | 814 | 810 | 800 |
| 2061 | 809 | 809 | 809 | 1448 | 313 | 781 | 813 | 813 | 814 | 810 | 800 |
| 2062 | 809 | 809 | 809 | 1448 | 313 | 793 | 813 | 813 | 814 | 810 | 800 |
| 2063 | 809 | 809 | 809 | 1448 | 313 | 806 | 813 | 813 | 814 | 810 | 800 |
| 2064 | 809 | 809 | 809 | 1448 | 313 | 811 | 813 | 813 | 814 | 810 | 800 |
| 2065 | 809 | 809 | 809 | 1448 | 313 | 811 | 813 | 813 | 814 | 810 | 800 |
| 2066 | 809 | 809 | 809 | 1448 | 313 | 811 | 813 | 813 | 814 | 810 | 800 |
| 2067 | 809 | 809 | 809 | 1448 | 313 | 811 | 813 | 813 | 814 | 810 | 800 |
| 2068 | 809 | 809 | 809 | 1448 | 313 | 811 | 813 | 813 | 814 | 810 | 800 |
| 2069 | 809 | 809 | 809 | 1448 | 313 | 811 | 813 | 813 | 814 | 810 | 800 |
| 2070 | 809 | 809 | 809 | 1448 | 313 | 811 | 813 | 813 | 814 | 810 | 800 |
| 2071 | 809 | 809 | 809 | 1448 | 313 | 811 | 813 | 813 | 814 | 810 | 800 |
| 2072 | 809 | 809 | 809 | 1448 | 313 | 811 | 813 | 813 | 814 | 810 | 800 |
| 2073 | 809 | 809 | 809 | 1448 | 313 | 811 | 813 | 813 | 814 | 810 | 800 |
| 2074 | 809 | 809 | 809 | 1448 | 313 | 811 | 813 | 813 | 814 | 810 | 800 |
| 2075 | 809 | 809 | 809 | 1448 | 313 | 811 | 813 | 813 | 814 | 810 | 800 |
| 2076 | 809 | 809 | 809 | 1448 | 313 | 811 | 813 | 813 | 814 | 810 | 800 |
| 2077 | 809 | 809 | 809 | 1448 | 313 | 811 | 813 | 813 | 814 | 810 | 800 |
| 2078 | 809 | 809 | 809 | 1448 | 313 | 811 | 813 | 813 | 814 | 810 | 800 |
| 2079 | 809 | 809 | 809 | 1448 | 313 | 811 | 813 | 813 | 814 | 810 | 800 |
| 2080 | 809 | 809 | 809 | 1448 | 313 | 811 | 813 | 813 | 814 | 810 | 800 |
| 2081 | 809 | 809 | 809 | 1448 | 313 | 811 | 813 | 813 | 814 | 810 | 800 |
| 2082 | 809 | 809 | 809 | 1448 | 313 | 811 | 813 | 813 | 814 | 810 | 800 |
| 2083 | 809 | 809 | 809 | 1448 | 313 | 811 | 813 | 813 | 814 | 810 | 800 |
| 2084 | 809 | 809 | 809 | 1448 | 313 | 811 | 813 | 813 | 814 | 810 | 800 |
| 2085 | 809 | 809 | 809 | 1448 | 313 | 811 | 813 | 813 | 814 | 810 | 800 |
| 2086 | 809 | 809 | 809 | 1448 | 313 | 811 | 813 | 813 | 814 | 810 | 800 |
| 2087 | 809 | 809 | 809 | 1448 | 313 | 811 | 813 | 813 | 814 | 810 | 800 |
| 2088 | 809 | 809 | 809 | 1448 | 313 | 811 | 813 | 813 | 814 | 810 | 800 |
| 2089 | 809 | 809 | 809 | 1448 | 313 | 811 | 813 | 813 | 814 | 810 | 800 |
| 2090 | 809 | 809 | 809 | 1448 | 313 | 811 | 813 | 813 | 814 | 810 | 800 |

|      | 45  | 46   | 47  | 48  | 49  | 50  | 51  | 52  | 53  | 54  | 55   |
|------|-----|------|-----|-----|-----|-----|-----|-----|-----|-----|------|
| 2002 | 0   | 0    | 0   | 0   | 0   | 0   | 0   | 0   | 0   | 0   | 0    |
| 2003 | 0   | 0    | 0   | 0   | 0   | 0   | 0   | 0   | 0   | 0   | 0    |
| 2004 | 0   | 0    | 0   | 0   | 0   | 0   | 0   | 0   | 0   | 0   | 0    |
| 2005 | 0   | 0    | 0   | 0   | 0   | 0   | 0   | 0   | 0   | 0   | 0    |
| 2006 | 0   | 0    | 0   | 0   | 0   | 0   | 0   | 0   | 0   | 0   | 0    |
| 2007 | 0   | 0    | 0   | 0   | 0   | 0   | 0   | 0   | 0   | 0   | 0    |
| 2008 | 0   | 0    | 0   | 0   | 0   | 0   | 0   | 0   | 0   | 0   | 0    |
| 2009 | 0   | 0    | 0   | 0   | 0   | 0   | 0   | 0   | 0   | 0   | 0    |
| 2010 | 0   | 0    | 0   | 0   | 0   | 0   | 0   | 0   | 0   | 0   | 0    |
| 2011 | 0   | 0    | 0   | 0   | 0   | 0   | 0   | 0   | 0   | 0   | 0    |
| 2012 | 0   | 0    | 0   | 0   | 0   | 0   | 0   | 0   | 0   | 0   | 0    |
| 2013 | 0   | 0    | 0   | 0   | 0   | 0   | 0   | 0   | 0   | 0   | 0    |
| 2014 | 0   | 0    | 0   | 0   | 0   | 0   | 0   | 0   | 0   | 0   | 0    |
| 2015 | 0   | 0    | 0   | 0   | 0   | 0   | 0   | 0   | 0   | 0   | 0    |
| 2016 | 0   | 0    | 0   | 0   | 0   | 0   | 0   | 0   | 0   | 0   | 0    |
| 2017 | 0   | 0    | 0   | 0   | 0   | 0   | 0   | 0   | 0   | 0   | 0    |
| 2018 | 0   | 0    | 0   | 0   | 0   | 0   | 0   | 0   | 0   | 0   | 0    |
| 2019 | 0   | 0    | 0   | 0   | 0   | 0   | 0   | 0   | 0   | 0   | 0    |
| 2020 | 0   | 0    | 0   | 0   | 0   | 0   | 0   | 0   | 0   | 0   | 0    |
| 2021 | 0   | 0    | 0   | 0   | 3   | 0   | 0   | 0   | 0   | 0   | 0    |
| 2022 | 0   | 0    | 0   | 0   | 4   | 0   | 0   | 0   | 0   | 0   | 0    |
| 2023 | 0   | 0    | 0   | 0   | 9   | 0   | 0   | 0   | 0   | 0   | 0    |
| 2024 | 0   | 0    | 0   | 0   | 15  | 0   | 0   | 0   | 0   | 0   | 0    |
| 2025 | 0   | 0    | 0   | 0   | 22  | 0   | 0   | 0   | 0   | 0   | 0    |
| 2026 | 7   | 7    | 6   | 0   | 37  | 4   | 14  | 7   | 2   | 7   | 21   |
| 2027 | 13  | 13   | 9   | 0   | 53  | 6   | 24  | 15  | 5   | 13  | 63   |
| 2028 | 22  | 17   | 13  | 0   | 69  | 9   | 41  | 19  | 9   | 17  | 124  |
| 2029 | 42  | 22   | 17  | 0   | 76  | 16  | 62  | 24  | 13  | 22  | 203  |
| 2030 | 57  | 37   | 29  | 0   | 84  | 24  | 84  | 39  | 28  | 37  | 284  |
| 2031 | 73  | 50   | 36  | 5   | 105 | 27  | 104 | 50  | 39  | 48  | 343  |
| 2032 | 107 | 71   | 39  | 10  | 120 | 47  | 122 | 61  | 48  | 59  | 418  |
| 2033 | 132 | 92   | 44  | 22  | 168 | 62  | 138 | 80  | 65  | 78  | 496  |
| 2034 | 157 | 113  | 50  | 29  | 190 | 79  | 153 | 90  | 75  | 88  | 545  |
| 2035 | 182 | 141  | 59  | 44  | 219 | 98  | 175 | 104 | 89  | 102 | 580  |
| 2036 | 223 | 171  | 83  | 56  | 246 | 112 | 223 | 133 | 118 | 131 | 598  |
| 2037 | 248 | 200  | 92  | 83  | 265 | 134 | 248 | 157 | 142 | 155 | 623  |
| 2038 | 264 | 249  | 106 | 103 | 292 | 155 | 271 | 195 | 180 | 193 | 639  |
| 2039 | 279 | 302  | 119 | 128 | 318 | 184 | 289 | 223 | 208 | 221 | 669  |
| 2040 | 298 | 331  | 132 | 149 | 351 | 193 | 315 | 240 | 225 | 238 | 696  |
| 2041 | 316 | 360  | 151 | 172 | 361 | 215 | 325 | 261 | 246 | 259 | 712  |
| 2042 | 328 | 384  | 153 | 182 | 366 | 233 | 332 | 281 | 266 | 279 | 726  |
| 2043 | 338 | 420  | 153 | 203 | 366 | 250 | 346 | 302 | 287 | 300 | 729  |
| 2044 | 352 | 467  | 154 | 227 | 368 | 266 | 349 | 322 | 307 | 320 | 749  |
| 2045 | 361 | 489  | 154 | 239 | 425 | 271 | 364 | 328 | 313 | 326 | 774  |
| 2046 | 368 | 515  | 158 | 243 | 533 | 291 | 374 | 339 | 324 | 337 | 870  |
| 2047 | 377 | 587  | 163 | 244 | 642 | 325 | 397 | 363 | 348 | 361 | 1018 |
| 2048 | 389 | 703  | 174 | 267 | 722 | 382 | 452 | 414 | 399 | 412 | 1177 |
| 2049 | 405 | 815  | 190 | 299 | 766 | 432 | 517 | 469 | 454 | 467 | 1290 |
| 2050 | 459 | 930  | 205 | 341 | 786 | 476 | 584 | 524 | 509 | 522 | 1372 |
| 2051 | 522 | 1058 | 224 | 382 | 798 | 542 | 652 | 592 | 577 | 590 | 1420 |
| 2052 | 590 | 1201 | 247 | 416 | 798 | 608 | 717 | 663 | 648 | 661 | 1441 |
| 2053 | 655 | 1302 | 270 | 457 | 804 | 675 | 757 | 723 | 708 | 721 | 1444 |
| 2054 | 721 | 1365 | 286 | 506 | 804 | 723 | 783 | 766 | 751 | 764 | 1444 |
| 2055 | 762 | 1402 | 298 | 553 | 804 | 758 | 798 | 787 | 772 | 785 | 1444 |
| 2056 | 788 | 1425 | 303 | 611 | 804 | 783 | 804 | 802 | 787 | 800 | 1444 |
| 2057 | 805 | 1436 | 311 | 666 | 804 | 798 | 810 | 809 | 794 | 807 | 1444 |
| 2058 | 810 | 1436 | 313 | 713 | 804 | 808 | 810 | 809 | 794 | 807 | 1444 |
| 2059 | 810 | 1436 | 313 | 744 | 804 | 808 | 811 | 813 | 798 | 811 | 1444 |

|      | 45  | 46   | 47  | 48  | 49  | 50  | 51  | 52  | 53  | 54  | 55   |
|------|-----|------|-----|-----|-----|-----|-----|-----|-----|-----|------|
| 2060 | 810 | 1436 | 313 | 764 | 804 | 808 | 811 | 813 | 798 | 811 | 1444 |
| 2061 | 810 | 1436 | 313 | 779 | 804 | 808 | 811 | 813 | 798 | 811 | 1444 |
| 2062 | 810 | 1436 | 313 | 790 | 804 | 808 | 811 | 813 | 798 | 811 | 1444 |
| 2063 | 810 | 1436 | 313 | 803 | 804 | 808 | 811 | 813 | 798 | 811 | 1444 |
| 2064 | 810 | 1436 | 313 | 810 | 804 | 808 | 811 | 813 | 798 | 811 | 1444 |
| 2065 | 810 | 1436 | 313 | 812 | 804 | 808 | 811 | 813 | 798 | 811 | 1444 |
| 2066 | 810 | 1436 | 313 | 812 | 804 | 808 | 811 | 813 | 798 | 811 | 1444 |
| 2067 | 810 | 1436 | 313 | 814 | 804 | 808 | 811 | 813 | 798 | 811 | 1444 |
| 2068 | 810 | 1436 | 313 | 814 | 804 | 808 | 811 | 813 | 798 | 811 | 1444 |
| 2069 | 810 | 1436 | 313 | 814 | 804 | 808 | 811 | 813 | 798 | 811 | 1444 |
| 2070 | 810 | 1436 | 313 | 814 | 804 | 808 | 811 | 813 | 798 | 811 | 1444 |
| 2071 | 810 | 1436 | 313 | 814 | 804 | 808 | 811 | 813 | 798 | 811 | 1444 |
| 2072 | 810 | 1436 | 313 | 814 | 804 | 808 | 811 | 813 | 798 | 811 | 1444 |
| 2073 | 810 | 1436 | 313 | 814 | 804 | 808 | 811 | 813 | 798 | 811 | 1444 |
| 2074 | 810 | 1436 | 313 | 814 | 804 | 808 | 811 | 813 | 798 | 811 | 1444 |
| 2075 | 810 | 1436 | 313 | 814 | 804 | 808 | 811 | 813 | 798 | 811 | 1444 |
| 2076 | 810 | 1436 | 313 | 814 | 804 | 808 | 811 | 813 | 798 | 811 | 1444 |
| 2077 | 810 | 1436 | 313 | 814 | 804 | 808 | 811 | 813 | 798 | 811 | 1444 |
| 2078 | 810 | 1436 | 313 | 814 | 804 | 808 | 811 | 813 | 798 | 811 | 1444 |
| 2079 | 810 | 1436 | 313 | 814 | 804 | 808 | 811 | 813 | 798 | 811 | 1444 |
| 2080 | 810 | 1436 | 313 | 814 | 804 | 808 | 811 | 813 | 798 | 811 | 1444 |
| 2081 | 810 | 1436 | 313 | 814 | 804 | 808 | 811 | 813 | 798 | 811 | 1444 |
| 2082 | 810 | 1436 | 313 | 814 | 804 | 808 | 811 | 813 | 798 | 811 | 1444 |
| 2083 | 810 | 1436 | 313 | 814 | 804 | 808 | 811 | 813 | 798 | 811 | 1444 |
| 2084 | 810 | 1436 | 313 | 814 | 804 | 808 | 811 | 813 | 798 | 811 | 1444 |
| 2085 | 810 | 1436 | 313 | 814 | 804 | 808 | 811 | 813 | 798 | 811 | 1444 |
| 2086 | 810 | 1436 | 313 | 814 | 804 | 808 | 811 | 813 | 798 | 811 | 1444 |
| 2087 | 810 | 1436 | 313 | 814 | 804 | 808 | 811 | 813 | 798 | 811 | 1444 |
| 2088 | 810 | 1436 | 313 | 814 | 804 | 808 | 811 | 813 | 798 | 811 | 1444 |
| 2089 | 810 | 1436 | 313 | 814 | 804 | 808 | 811 | 813 | 798 | 811 | 1444 |
| 2090 | 810 | 1436 | 313 | 814 | 804 | 808 | 811 | 813 | 798 | 811 | 1444 |

|      | 56  | 57  | 58  | 59  | 60  | 61  | 62  | 63  | 64   | 65  | 66  |
|------|-----|-----|-----|-----|-----|-----|-----|-----|------|-----|-----|
| 2002 | 0   | 0   | 0   | 0   | 0   | 0   | 0   | 0   | 0    | 0   | 0   |
| 2003 | 0   | 0   | 0   | 0   | 0   | 0   | 0   | 0   | 0    | 0   | 0   |
| 2004 | 0   | 0   | 0   | 0   | 0   | 0   | 0   | 0   | 0    | 0   | 0   |
| 2005 | 0   | 0   | 0   | 0   | 0   | 0   | 0   | 0   | 0    | 0   | 0   |
| 2006 | 0   | 0   | 0   | 0   | 0   | 0   | 0   | 0   | 0    | 0   | 0   |
| 2007 | 0   | 0   | 0   | 0   | 0   | 0   | 0   | 0   | 0    | 0   | 0   |
| 2008 | 0   | 0   | 0   | 0   | 0   | 0   | 0   | 0   | 0    | 0   | 0   |
| 2009 | 0   | 0   | 0   | 0   | 0   | 0   | 0   | 0   | 0    | 0   | 0   |
| 2010 | 0   | 0   | 0   | 0   | 0   | 0   | 0   | 0   | 0    | 0   | 0   |
| 2011 | 0   | 0   | 0   | 0   | 0   | 0   | 0   | 0   | 0    | 0   | 0   |
| 2012 | 0   | 0   | 0   | 0   | 0   | 0   | 0   | 0   | 0    | 0   | 0   |
| 2013 | 0   | 0   | 0   | 0   | 0   | 0   | 0   | 0   | 0    | 0   | 0   |
| 2014 | 0   | 0   | 0   | 0   | 0   | 0   | 0   | 0   | 0    | 0   | 0   |
| 2015 | 0   | 0   | 0   | 0   | 0   | 0   | 0   | 0   | 0    | 0   | 0   |
| 2016 | 0   | 0   | 0   | 0   | 0   | 0   | 0   | 0   | 0    | 0   | 0   |
| 2017 | 0   | 0   | 0   | 0   | 0   | 0   | 0   | 0   | 0    | 0   | 0   |
| 2018 | 0   | 0   | 0   | 0   | 0   | 0   | 0   | 0   | 0    | 0   | 0   |
| 2019 | 0   | 0   | 0   | 0   | 0   | 0   | 0   | 0   | 0    | 0   | 0   |
| 2020 | 0   | 0   | 0   | 0   | 0   | 0   | 0   | 0   | 0    | 0   | 0   |
| 2021 | 0   | 0   | 30  | 0   | 0   | 0   | 0   | 0   | 0    | 0   | 0   |
| 2022 | 0   | 0   | 84  | 0   | 0   | 0   | 0   | 0   | 0    | 0   | 0   |
| 2023 | 0   | 0   | 117 | 0   | 0   | 0   | 0   | 0   | 0    | 0   | 0   |
| 2024 | 0   | 0   | 165 | 0   | 0   | 0   | 0   | 0   | 0    | 0   | 0   |
| 2025 | 0   | 0   | 185 | 0   | 0   | 0   | 0   | 0   | 0    | 0   | 0   |
| 2026 | 0   | 0   | 210 | 0   | 0   | 0   | 0   | 0   | 54   | 0   | 0   |
| 2027 | 0   | 0   | 248 | 10  | 10  | 10  | 10  | 10  | 139  | 0   | 0   |
| 2028 | 6   | 0   | 305 | 13  | 13  | 13  | 13  | 13  | 247  | 0   | 0   |
| 2029 | 6   | 0   | 322 | 48  | 48  | 48  | 48  | 48  | 336  | 30  | 0   |
| 2030 | 18  | 0   | 342 | 90  | 90  | 90  | 90  | 90  | 402  | 50  | 0   |
| 2031 | 18  | 0   | 358 | 114 | 114 | 114 | 114 | 114 | 459  | 71  | 0   |
| 2032 | 37  | 0   | 369 | 162 | 162 | 162 | 162 | 162 | 499  | 77  | 0   |
| 2033 | 53  | 10  | 379 | 218 | 218 | 218 | 218 | 218 | 552  | 85  | 10  |
| 2034 | 83  | 23  | 399 | 256 | 256 | 256 | 256 | 256 | 582  | 99  | 33  |
| 2035 | 84  | 30  | 409 | 277 | 277 | 277 | 277 | 277 | 599  | 109 | 114 |
| 2036 | 93  | 40  | 439 | 298 | 309 | 298 | 298 | 298 | 630  | 129 | 165 |
| 2037 | 93  | 90  | 444 | 308 | 319 | 308 | 308 | 308 | 654  | 148 | 206 |
| 2038 | 103 | 151 | 444 | 319 | 331 | 319 | 319 | 319 | 677  | 160 | 233 |
| 2039 | 113 | 197 | 473 | 341 | 345 | 341 | 341 | 341 | 694  | 163 | 262 |
| 2040 | 115 | 238 | 475 | 351 | 351 | 351 | 351 | 351 | 704  | 163 | 274 |
| 2041 | 117 | 267 | 485 | 351 | 351 | 351 | 351 | 351 | 724  | 173 | 296 |
| 2042 | 117 | 277 | 492 | 351 | 361 | 361 | 361 | 361 | 745  | 181 | 316 |
| 2043 | 117 | 289 | 511 | 351 | 361 | 361 | 361 | 361 | 765  | 181 | 366 |
| 2044 | 117 | 299 | 567 | 351 | 361 | 371 | 371 | 371 | 785  | 185 | 390 |
| 2045 | 117 | 319 | 661 | 361 | 361 | 381 | 381 | 381 | 795  | 195 | 410 |
| 2046 | 121 | 340 | 741 | 409 | 408 | 420 | 420 | 420 | 797  | 196 | 412 |
| 2047 | 130 | 347 | 808 | 478 | 480 | 479 | 479 | 479 | 797  | 196 | 412 |
| 2048 | 156 | 351 | 808 | 528 | 540 | 548 | 548 | 548 | 805  | 196 | 422 |
| 2049 | 166 | 361 | 814 | 608 | 620 | 640 | 640 | 640 | 848  | 196 | 431 |
| 2050 | 212 | 371 | 814 | 698 | 708 | 728 | 728 | 728 | 997  | 196 | 431 |
| 2051 | 281 | 469 | 814 | 775 | 785 | 785 | 785 | 785 | 1190 | 208 | 441 |
| 2052 | 294 | 486 | 814 | 797 | 797 | 807 | 807 | 807 | 1313 | 242 | 451 |
| 2053 | 300 | 506 | 814 | 799 | 806 | 809 | 809 | 809 | 1365 | 262 | 517 |
| 2054 | 307 | 527 | 814 | 811 | 807 | 812 | 812 | 812 | 1401 | 272 | 587 |
| 2055 | 309 | 590 | 814 | 811 | 813 | 812 | 812 | 812 | 1428 | 291 | 646 |
| 2056 | 313 | 661 | 814 | 811 | 813 | 814 | 814 | 814 | 1439 | 302 | 708 |
| 2057 | 313 | 735 | 814 | 811 | 813 | 814 | 814 | 814 | 1448 | 312 | 740 |
| 2058 | 313 | 787 | 814 | 811 | 813 | 814 | 814 | 814 | 1448 | 312 | 769 |
| 2059 | 313 | 800 | 814 | 811 | 813 | 814 | 814 | 814 | 1448 | 312 | 788 |

|      | 56  | 57  | 58  | 59  | 60  | 61  | 62  | 63  | 64   | 65  | 66  |
|------|-----|-----|-----|-----|-----|-----|-----|-----|------|-----|-----|
| 2060 | 313 | 803 | 814 | 811 | 813 | 814 | 814 | 814 | 1448 | 312 | 798 |
| 2061 | 313 | 812 | 814 | 811 | 813 | 814 | 814 | 814 | 1448 | 312 | 808 |
| 2062 | 313 | 812 | 814 | 811 | 813 | 814 | 814 | 814 | 1448 | 312 | 813 |
| 2063 | 313 | 812 | 814 | 811 | 813 | 814 | 814 | 814 | 1448 | 312 | 813 |
| 2064 | 313 | 812 | 814 | 811 | 813 | 814 | 814 | 814 | 1448 | 312 | 813 |
| 2065 | 313 | 812 | 814 | 811 | 813 | 814 | 814 | 814 | 1448 | 312 | 813 |
| 2066 | 313 | 812 | 814 | 811 | 813 | 814 | 814 | 814 | 1448 | 312 | 813 |
| 2067 | 313 | 812 | 814 | 811 | 813 | 814 | 814 | 814 | 1448 | 312 | 813 |
| 2068 | 313 | 812 | 814 | 811 | 813 | 814 | 814 | 814 | 1448 | 312 | 813 |
| 2069 | 313 | 812 | 814 | 811 | 813 | 814 | 814 | 814 | 1448 | 312 | 813 |
| 2070 | 313 | 812 | 814 | 811 | 813 | 814 | 814 | 814 | 1448 | 312 | 813 |
| 2071 | 313 | 812 | 814 | 811 | 813 | 814 | 814 | 814 | 1448 | 312 | 813 |
| 2072 | 313 | 812 | 814 | 811 | 813 | 814 | 814 | 814 | 1448 | 312 | 813 |
| 2073 | 313 | 812 | 814 | 811 | 813 | 814 | 814 | 814 | 1448 | 312 | 813 |
| 2074 | 313 | 812 | 814 | 811 | 813 | 814 | 814 | 814 | 1448 | 312 | 813 |
| 2075 | 313 | 812 | 814 | 811 | 813 | 814 | 814 | 814 | 1448 | 312 | 813 |
| 2076 | 313 | 812 | 814 | 811 | 813 | 814 | 814 | 814 | 1448 | 312 | 813 |
| 2077 | 313 | 812 | 814 | 811 | 813 | 814 | 814 | 814 | 1448 | 312 | 813 |
| 2078 | 313 | 812 | 814 | 811 | 813 | 814 | 814 | 814 | 1448 | 312 | 813 |
| 2079 | 313 | 812 | 814 | 811 | 813 | 814 | 814 | 814 | 1448 | 312 | 813 |
| 2080 | 313 | 812 | 814 | 811 | 813 | 814 | 814 | 814 | 1448 | 312 | 813 |
| 2081 | 313 | 812 | 814 | 811 | 813 | 814 | 814 | 814 | 1448 | 312 | 813 |
| 2082 | 313 | 812 | 814 | 811 | 813 | 814 | 814 | 814 | 1448 | 312 | 813 |
| 2083 | 313 | 812 | 814 | 811 | 813 | 814 | 814 | 814 | 1448 | 312 | 813 |
| 2084 | 313 | 812 | 814 | 811 | 813 | 814 | 814 | 814 | 1448 | 312 | 813 |
| 2085 | 313 | 812 | 814 | 811 | 813 | 814 | 814 | 814 | 1448 | 312 | 813 |
| 2086 | 313 | 812 | 814 | 811 | 813 | 814 | 814 | 814 | 1448 | 312 | 813 |
| 2087 | 313 | 812 | 814 | 811 | 813 | 814 | 814 | 814 | 1448 | 312 | 813 |
| 2088 | 313 | 812 | 814 | 811 | 813 | 814 | 814 | 814 | 1448 | 312 | 813 |
| 2089 | 313 | 812 | 814 | 811 | 813 | 814 | 814 | 814 | 1448 | 312 | 813 |
| 2090 | 313 | 812 | 814 | 811 | 813 | 814 | 814 | 814 | 1448 | 312 | 813 |

|      | 67  | 68  | 69  | 70  | 71  | 72  | 73   | 74  | 75  | 76  | 77  |
|------|-----|-----|-----|-----|-----|-----|------|-----|-----|-----|-----|
| 2002 | 0   | 0   | 0   | 0   | 0   | 0   | 0    | 0   | 0   | 0   | 0   |
| 2003 | 0   | 0   | 0   | 0   | 0   | 0   | 0    | 0   | 0   | 0   | 0   |
| 2004 | 0   | 0   | 0   | 0   | 0   | 0   | 0    | 0   | 0   | 0   | 0   |
| 2005 | 0   | 0   | 0   | 0   | 0   | 0   | 0    | 0   | 0   | 0   | 0   |
| 2006 | 0   | 0   | 0   | 0   | 0   | 0   | 0    | 0   | 0   | 0   | 0   |
| 2007 | 0   | 0   | 0   | 0   | 0   | 0   | 0    | 0   | 0   | 0   | 0   |
| 2008 | 0   | 0   | 0   | 0   | 0   | 0   | 0    | 0   | 0   | 0   | 0   |
| 2009 | 0   | 0   | 0   | 0   | 0   | 0   | 0    | 0   | 0   | 0   | 0   |
| 2010 | 0   | 0   | 0   | 0   | 0   | 0   | 0    | 0   | 0   | 0   | 0   |
| 2011 | 0   | 0   | 0   | 0   | 0   | 0   | 0    | 0   | 0   | 0   | 0   |
| 2012 | 0   | 0   | 0   | 0   | 0   | 0   | 0    | 0   | 0   | 0   | 0   |
| 2013 | 0   | 0   | 0   | 0   | 0   | 0   | 0    | 0   | 0   | 0   | 0   |
| 2014 | 0   | 0   | 0   | 0   | 0   | 0   | 0    | 0   | 0   | 0   | 0   |
| 2015 | 0   | 0   | 0   | 0   | 0   | 0   | 0    | 0   | 0   | 0   | 0   |
| 2016 | 0   | 0   | 0   | 0   | 0   | 0   | 0    | 0   | 0   | 0   | 0   |
| 2017 | 0   | 0   | 0   | 0   | 0   | 0   | 0    | 0   | 0   | 0   | 0   |
| 2018 | 0   | 0   | 0   | 0   | 0   | 0   | 0    | 0   | 0   | 0   | 0   |
| 2019 | 0   | 0   | 0   | 0   | 0   | 0   | 0    | 0   | 0   | 0   | 0   |
| 2020 | 0   | 0   | 0   | 0   | 0   | 0   | 0    | 0   | 0   | 0   | 0   |
| 2021 | 85  | 0   | 0   | 0   | 0   | 0   | 0    | 0   | 0   | 73  | 0   |
| 2022 | 157 | 0   | 0   | 0   | 0   | 0   | 0    | 0   | 0   | 145 | 0   |
| 2023 | 209 | 0   | 0   | 0   | 0   | 0   | 0    | 0   | 0   | 196 | 0   |
| 2024 | 255 | 0   | 0   | 0   | 0   | 0   | 0    | 0   | 0   | 242 | 0   |
| 2025 | 271 | 0   | 0   | 0   | 0   | 0   | 0    | 0   | 0   | 258 | 0   |
| 2026 | 291 | 1   | 1   | 1   | 0   | 1   | 48   | 0   | 0   | 278 | 1   |
| 2027 | 317 | 31  | 31  | 31  | 22  | 31  | 128  | 0   | 0   | 300 | 29  |
| 2028 | 327 | 70  | 70  | 70  | 58  | 70  | 236  | 0   | 0   | 310 | 68  |
| 2029 | 354 | 139 | 148 | 139 | 118 | 139 | 325  | 30  | 0   | 337 | 147 |
| 2030 | 378 | 196 | 197 | 196 | 175 | 196 | 391  | 50  | 0   | 365 | 195 |
| 2031 | 380 | 219 | 220 | 219 | 198 | 219 | 448  | 71  | 0   | 367 | 218 |
| 2032 | 403 | 232 | 242 | 242 | 221 | 242 | 486  | 77  | 0   | 381 | 240 |
| 2033 | 414 | 266 | 286 | 283 | 262 | 283 | 530  | 85  | 10  | 385 | 274 |
| 2034 | 444 | 292 | 318 | 315 | 294 | 315 | 556  | 89  | 33  | 405 | 291 |
| 2035 | 457 | 312 | 328 | 325 | 304 | 325 | 579  | 109 | 114 | 415 | 311 |
| 2036 | 464 | 350 | 360 | 357 | 336 | 357 | 610  | 129 | 165 | 433 | 338 |
| 2037 | 464 | 370 | 372 | 372 | 351 | 372 | 620  | 138 | 206 | 444 | 348 |
| 2038 | 464 | 380 | 382 | 382 | 361 | 382 | 650  | 160 | 233 | 451 | 368 |
| 2039 | 474 | 386 | 396 | 386 | 365 | 386 | 670  | 163 | 262 | 451 | 383 |
| 2040 | 474 | 396 | 407 | 396 | 375 | 396 | 683  | 163 | 272 | 451 | 393 |
| 2041 | 474 | 416 | 417 | 416 | 395 | 416 | 700  | 173 | 294 | 461 | 404 |
| 2042 | 484 | 427 | 437 | 427 | 406 | 427 | 730  | 181 | 316 | 471 | 424 |
| 2043 | 494 | 429 | 459 | 429 | 408 | 429 | 734  | 181 | 366 | 483 | 437 |
| 2044 | 506 | 449 | 468 | 449 | 428 | 449 | 744  | 181 | 390 | 503 | 439 |
| 2045 | 510 | 456 | 468 | 461 | 440 | 461 | 754  | 185 | 410 | 615 | 439 |
| 2046 | 615 | 456 | 468 | 468 | 447 | 468 | 772  | 185 | 419 | 712 | 449 |
| 2047 | 702 | 464 | 468 | 468 | 447 | 468 | 845  | 185 | 419 | 762 | 459 |
| 2048 | 746 | 464 | 478 | 468 | 447 | 468 | 1004 | 195 | 429 | 781 | 493 |
| 2049 | 775 | 468 | 560 | 468 | 447 | 468 | 1191 | 218 | 441 | 791 | 607 |
| 2050 | 794 | 495 | 653 | 505 | 484 | 505 | 1306 | 242 | 441 | 791 | 672 |
| 2051 | 804 | 609 | 683 | 613 | 592 | 613 | 1354 | 262 | 457 | 791 | 711 |
| 2052 | 810 | 664 | 723 | 674 | 653 | 674 | 1390 | 272 | 517 | 791 | 748 |
| 2053 | 810 | 710 | 760 | 713 | 692 | 713 | 1417 | 291 | 597 | 791 | 777 |
| 2054 | 810 | 750 | 789 | 750 | 729 | 750 | 1428 | 302 | 655 | 791 | 796 |
| 2055 | 810 | 779 | 808 | 779 | 758 | 779 | 1437 | 312 | 708 | 791 | 806 |
| 2056 | 810 | 798 | 814 | 798 | 777 | 798 | 1437 | 312 | 740 | 791 | 806 |
| 2057 | 810 | 808 | 814 | 808 | 787 | 808 | 1437 | 312 | 769 | 791 | 806 |
| 2058 | 810 | 813 | 814 | 813 | 792 | 813 | 1437 | 312 | 788 | 791 | 806 |
| 2059 | 810 | 813 | 814 | 813 | 792 | 813 | 1437 | 312 | 798 | 791 | 806 |

|      | 67  | 68  | 69  | 70  | 71  | 72  | 73   | 74  | 75  | 76  | 77  |
|------|-----|-----|-----|-----|-----|-----|------|-----|-----|-----|-----|
| 2060 | 810 | 813 | 814 | 813 | 792 | 813 | 1437 | 312 | 808 | 791 | 806 |
| 2061 | 810 | 813 | 814 | 813 | 792 | 813 | 1437 | 312 | 813 | 791 | 806 |
| 2062 | 810 | 813 | 814 | 813 | 792 | 813 | 1437 | 312 | 813 | 791 | 806 |
| 2063 | 810 | 813 | 814 | 813 | 792 | 813 | 1437 | 312 | 813 | 791 | 806 |
| 2064 | 810 | 813 | 814 | 813 | 792 | 813 | 1437 | 312 | 813 | 791 | 806 |
| 2065 | 810 | 813 | 814 | 813 | 792 | 813 | 1437 | 312 | 813 | 791 | 806 |
| 2066 | 810 | 813 | 814 | 813 | 792 | 813 | 1437 | 312 | 813 | 791 | 806 |
| 2067 | 810 | 813 | 814 | 813 | 792 | 813 | 1437 | 312 | 813 | 791 | 806 |
| 2068 | 810 | 813 | 814 | 813 | 792 | 813 | 1437 | 312 | 813 | 791 | 806 |
| 2069 | 810 | 813 | 814 | 813 | 792 | 813 | 1437 | 312 | 813 | 791 | 806 |
| 2070 | 810 | 813 | 814 | 813 | 792 | 813 | 1437 | 312 | 813 | 791 | 806 |
| 2071 | 810 | 813 | 814 | 813 | 792 | 813 | 1437 | 312 | 813 | 791 | 806 |
| 2072 | 810 | 813 | 814 | 813 | 792 | 813 | 1437 | 312 | 813 | 791 | 806 |
| 2073 | 810 | 813 | 814 | 813 | 792 | 813 | 1437 | 312 | 813 | 791 | 806 |
| 2074 | 810 | 813 | 814 | 813 | 792 | 813 | 1437 | 312 | 813 | 791 | 806 |
| 2075 | 810 | 813 | 814 | 813 | 792 | 813 | 1437 | 312 | 813 | 791 | 806 |
| 2076 | 810 | 813 | 814 | 813 | 792 | 813 | 1437 | 312 | 813 | 791 | 806 |
| 2077 | 810 | 813 | 814 | 813 | 792 | 813 | 1437 | 312 | 813 | 791 | 806 |
| 2078 | 810 | 813 | 814 | 813 | 792 | 813 | 1437 | 312 | 813 | 791 | 806 |
| 2079 | 810 | 813 | 814 | 813 | 792 | 813 | 1437 | 312 | 813 | 791 | 806 |
| 2080 | 810 | 813 | 814 | 813 | 792 | 813 | 1437 | 312 | 813 | 791 | 806 |
| 2081 | 810 | 813 | 814 | 813 | 792 | 813 | 1437 | 312 | 813 | 791 | 806 |
| 2082 | 810 | 813 | 814 | 813 | 792 | 813 | 1437 | 312 | 813 | 791 | 806 |
| 2083 | 810 | 813 | 814 | 813 | 792 | 813 | 1437 | 312 | 813 | 791 | 806 |
| 2084 | 810 | 813 | 814 | 813 | 792 | 813 | 1437 | 312 | 813 | 791 | 806 |
| 2085 | 810 | 813 | 814 | 813 | 792 | 813 | 1437 | 312 | 813 | 791 | 806 |
| 2086 | 810 | 813 | 814 | 813 | 792 | 813 | 1437 | 312 | 813 | 791 | 806 |
| 2087 | 810 | 813 | 814 | 813 | 792 | 813 | 1437 | 312 | 813 | 791 | 806 |
| 2088 | 810 | 813 | 814 | 813 | 792 | 813 | 1437 | 312 | 813 | 791 | 806 |
| 2089 | 810 | 813 | 814 | 813 | 792 | 813 | 1437 | 312 | 813 | 791 | 806 |
| 2090 | 810 | 813 | 814 | 813 | 792 | 813 | 1437 | 312 | 813 | 791 | 806 |



|      | 78  | 79  | 80  | 81  | 82   | 83  | 84  | 85  | 86  | 87  | 88  |
|------|-----|-----|-----|-----|------|-----|-----|-----|-----|-----|-----|
| 2002 | 0   | 0   | 0   | 0   | 0    | 0   | 0   | 0   | 0   | 0   | 0   |
| 2003 | 0   | 0   | 0   | 0   | 0    | 0   | 0   | 0   | 0   | 0   | 0   |
| 2004 | 0   | 0   | 0   | 0   | 0    | 0   | 0   | 0   | 0   | 0   | 0   |
| 2005 | 0   | 0   | 0   | 0   | 0    | 0   | 0   | 0   | 0   | 0   | 0   |
| 2006 | 0   | 0   | 0   | 0   | 0    | 0   | 0   | 0   | 0   | 0   | 0   |
| 2007 | 0   | 0   | 0   | 0   | 0    | 0   | 0   | 0   | 0   | 0   | 0   |
| 2008 | 0   | 0   | 0   | 0   | 0    | 0   | 0   | 0   | 0   | 0   | 0   |
| 2009 | 0   | 0   | 0   | 0   | 0    | 0   | 0   | 0   | 0   | 0   | 0   |
| 2010 | 0   | 0   | 0   | 0   | 0    | 0   | 0   | 0   | 0   | 0   | 0   |
| 2011 | 0   | 0   | 0   | 0   | 0    | 0   | 0   | 0   | 0   | 0   | 0   |
| 2012 | 0   | 0   | 0   | 0   | 0    | 0   | 0   | 0   | 0   | 0   | 0   |
| 2013 | 0   | 0   | 0   | 0   | 0    | 0   | 0   | 0   | 0   | 0   | 0   |
| 2014 | 0   | 0   | 0   | 0   | 0    | 0   | 0   | 0   | 0   | 0   | 0   |
| 2015 | 0   | 0   | 0   | 0   | 0    | 0   | 0   | 0   | 0   | 0   | 0   |
| 2016 | 0   | 0   | 0   | 0   | 0    | 0   | 0   | 0   | 0   | 0   | 0   |
| 2017 | 0   | 0   | 0   | 0   | 0    | 0   | 0   | 0   | 0   | 0   | 0   |
| 2018 | 0   | 0   | 0   | 0   | 0    | 0   | 0   | 0   | 0   | 0   | 0   |
| 2019 | 0   | 0   | 0   | 0   | 0    | 0   | 0   | 0   | 0   | 0   | 0   |
| 2020 | 0   | 0   | 0   | 0   | 0    | 0   | 0   | 0   | 0   | 0   | 0   |
| 2021 | 0   | 0   | 0   | 0   | 0    | 0   | 0   | 39  | 0   | 0   | 0   |
| 2022 | 0   | 0   | 0   | 0   | 0    | 0   | 0   | 91  | 0   | 0   | 0   |
| 2023 | 0   | 0   | 0   | 0   | 0    | 0   | 0   | 120 | 0   | 0   | 0   |
| 2024 | 0   | 0   | 0   | 0   | 0    | 0   | 0   | 170 | 0   | 0   | 0   |
| 2025 | 0   | 0   | 0   | 0   | 0    | 0   | 0   | 205 | 0   | 0   | 0   |
| 2026 | 1   | 1   | 0   | 1   | 41   | 5   | 0   | 233 | 16  | 16  | 16  |
| 2027 | 30  | 31  | 12  | 29  | 109  | 13  | 0   | 260 | 43  | 43  | 43  |
| 2028 | 69  | 70  | 36  | 68  | 170  | 22  | 0   | 295 | 74  | 74  | 74  |
| 2029 | 144 | 139 | 83  | 137 | 245  | 32  | 0   | 316 | 109 | 109 | 109 |
| 2030 | 196 | 196 | 123 | 194 | 313  | 43  | 0   | 334 | 146 | 146 | 146 |
| 2031 | 219 | 219 | 143 | 217 | 359  | 51  | 10  | 345 | 169 | 169 | 169 |
| 2032 | 241 | 232 | 156 | 230 | 427  | 66  | 32  | 356 | 214 | 214 | 214 |
| 2033 | 285 | 266 | 190 | 264 | 495  | 82  | 56  | 366 | 257 | 257 | 257 |
| 2034 | 317 | 297 | 221 | 295 | 546  | 93  | 82  | 384 | 286 | 286 | 286 |
| 2035 | 327 | 317 | 241 | 315 | 575  | 102 | 119 | 395 | 306 | 306 | 306 |
| 2036 | 359 | 350 | 274 | 348 | 597  | 106 | 157 | 413 | 314 | 320 | 314 |
| 2037 | 371 | 360 | 284 | 358 | 618  | 110 | 196 | 418 | 327 | 326 | 327 |
| 2038 | 381 | 380 | 304 | 378 | 635  | 112 | 228 | 419 | 332 | 334 | 332 |
| 2039 | 385 | 386 | 310 | 384 | 655  | 116 | 262 | 437 | 342 | 349 | 344 |
| 2040 | 395 | 396 | 320 | 394 | 682  | 120 | 282 | 441 | 353 | 363 | 358 |
| 2041 | 415 | 406 | 330 | 404 | 705  | 120 | 298 | 441 | 363 | 367 | 368 |
| 2042 | 426 | 426 | 350 | 424 | 710  | 120 | 303 | 458 | 366 | 373 | 368 |
| 2043 | 448 | 429 | 353 | 427 | 724  | 120 | 314 | 466 | 366 | 380 | 370 |
| 2044 | 460 | 429 | 353 | 427 | 750  | 123 | 324 | 593 | 379 | 387 | 385 |
| 2045 | 467 | 439 | 363 | 437 | 775  | 126 | 332 | 677 | 390 | 394 | 397 |
| 2046 | 467 | 441 | 365 | 439 | 918  | 155 | 346 | 741 | 461 | 470 | 474 |
| 2047 | 487 | 451 | 375 | 449 | 1031 | 177 | 358 | 797 | 525 | 534 | 539 |
| 2048 | 554 | 498 | 422 | 496 | 1159 | 211 | 365 | 800 | 603 | 611 | 618 |
| 2049 | 644 | 619 | 543 | 617 | 1252 | 239 | 401 | 810 | 667 | 674 | 678 |
| 2050 | 679 | 666 | 590 | 664 | 1323 | 264 | 445 | 810 | 717 | 725 | 728 |
| 2051 | 712 | 710 | 634 | 708 | 1385 | 288 | 490 | 810 | 762 | 769 | 771 |
| 2052 | 749 | 750 | 674 | 748 | 1426 | 303 | 538 | 810 | 791 | 796 | 798 |
| 2053 | 778 | 779 | 703 | 777 | 1436 | 307 | 595 | 810 | 805 | 804 | 805 |
| 2054 | 797 | 798 | 722 | 796 | 1440 | 309 | 644 | 810 | 807 | 807 | 808 |
| 2055 | 807 | 798 | 722 | 796 | 1447 | 312 | 691 | 810 | 811 | 813 | 813 |
| 2056 | 812 | 798 | 722 | 796 | 1447 | 312 | 730 | 810 | 811 | 813 | 813 |
| 2057 | 812 | 798 | 722 | 796 | 1447 | 312 | 767 | 810 | 811 | 813 | 813 |
| 2058 | 812 | 798 | 722 | 796 | 1447 | 312 | 789 | 810 | 811 | 813 | 813 |
| 2059 | 812 | 798 | 722 | 796 | 1447 | 312 | 810 | 810 | 811 | 813 | 813 |

|      | 78  | 79  | 80  | 81  | 82   | 83  | 84  | 85  | 86  | 87  | 88  |
|------|-----|-----|-----|-----|------|-----|-----|-----|-----|-----|-----|
| 2060 | 812 | 798 | 722 | 796 | 1447 | 312 | 812 | 810 | 811 | 813 | 813 |
| 2061 | 812 | 798 | 722 | 796 | 1447 | 312 | 814 | 810 | 811 | 813 | 813 |
| 2062 | 812 | 798 | 722 | 796 | 1447 | 312 | 814 | 810 | 811 | 813 | 813 |
| 2063 | 812 | 798 | 722 | 796 | 1447 | 312 | 814 | 810 | 811 | 813 | 813 |
| 2064 | 812 | 798 | 722 | 796 | 1447 | 312 | 814 | 810 | 811 | 813 | 813 |
| 2065 | 812 | 798 | 722 | 796 | 1447 | 312 | 814 | 810 | 811 | 813 | 813 |
| 2066 | 812 | 798 | 722 | 796 | 1447 | 312 | 814 | 810 | 811 | 813 | 813 |
| 2067 | 812 | 798 | 722 | 796 | 1447 | 312 | 814 | 810 | 811 | 813 | 813 |
| 2068 | 812 | 798 | 722 | 796 | 1447 | 312 | 814 | 810 | 811 | 813 | 813 |
| 2069 | 812 | 798 | 722 | 796 | 1447 | 312 | 814 | 810 | 811 | 813 | 813 |
| 2070 | 812 | 798 | 722 | 796 | 1447 | 312 | 814 | 810 | 811 | 813 | 813 |
| 2071 | 812 | 798 | 722 | 796 | 1447 | 312 | 814 | 810 | 811 | 813 | 813 |
| 2072 | 812 | 798 | 722 | 796 | 1447 | 312 | 814 | 810 | 811 | 813 | 813 |
| 2073 | 812 | 798 | 722 | 796 | 1447 | 312 | 814 | 810 | 811 | 813 | 813 |
| 2074 | 812 | 798 | 722 | 796 | 1447 | 312 | 814 | 810 | 811 | 813 | 813 |
| 2075 | 812 | 798 | 722 | 796 | 1447 | 312 | 814 | 810 | 811 | 813 | 813 |
| 2076 | 812 | 798 | 722 | 796 | 1447 | 312 | 814 | 810 | 811 | 813 | 813 |
| 2077 | 812 | 798 | 722 | 796 | 1447 | 312 | 814 | 810 | 811 | 813 | 813 |
| 2078 | 812 | 798 | 722 | 796 | 1447 | 312 | 814 | 810 | 811 | 813 | 813 |
| 2079 | 812 | 798 | 722 | 796 | 1447 | 312 | 814 | 810 | 811 | 813 | 813 |
| 2080 | 812 | 798 | 722 | 796 | 1447 | 312 | 814 | 810 | 811 | 813 | 813 |
| 2081 | 812 | 798 | 722 | 796 | 1447 | 312 | 814 | 810 | 811 | 813 | 813 |
| 2082 | 812 | 798 | 722 | 796 | 1447 | 312 | 814 | 810 | 811 | 813 | 813 |
| 2083 | 812 | 798 | 722 | 796 | 1447 | 312 | 814 | 810 | 811 | 813 | 813 |
| 2084 | 812 | 798 | 722 | 796 | 1447 | 312 | 814 | 810 | 811 | 813 | 813 |
| 2085 | 812 | 798 | 722 | 796 | 1447 | 312 | 814 | 810 | 811 | 813 | 813 |
| 2086 | 812 | 798 | 722 | 796 | 1447 | 312 | 814 | 810 | 811 | 813 | 813 |
| 2087 | 812 | 798 | 722 | 796 | 1447 | 312 | 814 | 810 | 811 | 813 | 813 |
| 2088 | 812 | 798 | 722 | 796 | 1447 | 312 | 814 | 810 | 811 | 813 | 813 |
| 2089 | 812 | 798 | 722 | 796 | 1447 | 312 | 814 | 810 | 811 | 813 | 813 |
| 2090 | 812 | 798 | 722 | 796 | 1447 | 312 | 814 | 810 | 811 | 813 | 813 |

|      | 89  | 90  | 91   | 92  | 93  | 94  | 95  | 96  | 97  | 98  | 99  |
|------|-----|-----|------|-----|-----|-----|-----|-----|-----|-----|-----|
| 2002 | 0   | 0   | 0    | 0   | 0   | 0   | 0   | 0   | 0   | 0   | 0   |
| 2003 | 0   | 0   | 0    | 0   | 0   | 0   | 0   | 0   | 0   | 0   | 0   |
| 2004 | 0   | 0   | 0    | 0   | 0   | 0   | 0   | 0   | 0   | 0   | 0   |
| 2005 | 0   | 0   | 0    | 0   | 0   | 0   | 0   | 0   | 0   | 0   | 0   |
| 2006 | 0   | 0   | 0    | 0   | 0   | 0   | 0   | 0   | 0   | 0   | 0   |
| 2007 | 0   | 0   | 0    | 0   | 0   | 0   | 0   | 0   | 0   | 0   | 0   |
| 2008 | 0   | 0   | 0    | 0   | 0   | 0   | 0   | 0   | 0   | 0   | 0   |
| 2009 | 0   | 0   | 0    | 0   | 0   | 0   | 0   | 0   | 0   | 0   | 0   |
| 2010 | 0   | 0   | 0    | 0   | 0   | 0   | 0   | 0   | 0   | 0   | 0   |
| 2011 | 0   | 0   | 0    | 0   | 0   | 0   | 0   | 0   | 0   | 0   | 0   |
| 2012 | 0   | 0   | 0    | 0   | 0   | 0   | 0   | 0   | 0   | 0   | 0   |
| 2013 | 0   | 0   | 0    | 0   | 0   | 0   | 0   | 0   | 0   | 0   | 0   |
| 2014 | 0   | 0   | 0    | 0   | 0   | 0   | 0   | 0   | 0   | 0   | 0   |
| 2015 | 0   | 0   | 0    | 0   | 0   | 0   | 0   | 0   | 0   | 0   | 0   |
| 2016 | 0   | 0   | 0    | 0   | 0   | 0   | 0   | 0   | 0   | 0   | 0   |
| 2017 | 0   | 0   | 0    | 0   | 0   | 0   | 0   | 0   | 0   | 0   | 0   |
| 2018 | 0   | 0   | 0    | 0   | 0   | 0   | 0   | 0   | 0   | 0   | 0   |
| 2019 | 0   | 0   | 0    | 0   | 0   | 0   | 0   | 0   | 0   | 0   | 0   |
| 2020 | 0   | 0   | 0    | 0   | 0   | 0   | 0   | 0   | 0   | 0   | 0   |
| 2021 | 0   | 0   | 0    | 0   | 0   | 86  | 0   | 0   | 0   | 0   | 0   |
| 2022 | 0   | 0   | 0    | 0   | 0   | 142 | 0   | 0   | 0   | 0   | 0   |
| 2023 | 0   | 0   | 0    | 0   | 0   | 208 | 0   | 0   | 0   | 0   | 0   |
| 2024 | 0   | 0   | 0    | 0   | 0   | 254 | 0   | 0   | 0   | 0   | 0   |
| 2025 | 0   | 0   | 0    | 0   | 0   | 273 | 0   | 0   | 0   | 0   | 0   |
| 2026 | 16  | 16  | 98   | 17  | 0   | 292 | 47  | 47  | 47  | 42  | 47  |
| 2027 | 43  | 43  | 189  | 41  | 0   | 318 | 102 | 102 | 102 | 91  | 102 |
| 2028 | 74  | 74  | 267  | 57  | 0   | 334 | 141 | 141 | 141 | 126 | 141 |
| 2029 | 109 | 109 | 351  | 77  | 0   | 355 | 189 | 191 | 189 | 168 | 189 |
| 2030 | 146 | 146 | 420  | 95  | 0   | 376 | 235 | 237 | 235 | 214 | 235 |
| 2031 | 169 | 169 | 472  | 109 | 34  | 385 | 268 | 270 | 268 | 244 | 268 |
| 2032 | 214 | 214 | 509  | 117 | 75  | 405 | 284 | 288 | 288 | 264 | 288 |
| 2033 | 257 | 257 | 544  | 123 | 122 | 423 | 306 | 315 | 310 | 286 | 310 |
| 2034 | 286 | 286 | 578  | 133 | 156 | 444 | 324 | 337 | 330 | 306 | 330 |
| 2035 | 306 | 306 | 599  | 139 | 201 | 453 | 335 | 347 | 341 | 317 | 341 |
| 2036 | 314 | 314 | 626  | 148 | 236 | 464 | 355 | 364 | 358 | 334 | 358 |
| 2037 | 327 | 327 | 647  | 156 | 266 | 465 | 367 | 378 | 372 | 348 | 372 |
| 2038 | 332 | 332 | 670  | 163 | 290 | 465 | 384 | 394 | 387 | 363 | 387 |
| 2039 | 344 | 344 | 692  | 171 | 308 | 465 | 400 | 412 | 403 | 379 | 403 |
| 2040 | 358 | 358 | 705  | 174 | 325 | 465 | 411 | 425 | 411 | 387 | 411 |
| 2041 | 368 | 368 | 725  | 179 | 349 | 465 | 422 | 439 | 423 | 399 | 423 |
| 2042 | 368 | 368 | 752  | 185 | 374 | 474 | 434 | 452 | 440 | 416 | 440 |
| 2043 | 370 | 370 | 768  | 189 | 395 | 474 | 444 | 460 | 449 | 425 | 449 |
| 2044 | 385 | 385 | 781  | 193 | 412 | 474 | 448 | 466 | 458 | 434 | 458 |
| 2045 | 397 | 397 | 790  | 194 | 422 | 474 | 449 | 472 | 463 | 439 | 463 |
| 2046 | 474 | 474 | 797  | 196 | 427 | 487 | 449 | 483 | 468 | 444 | 468 |
| 2047 | 539 | 539 | 797  | 196 | 429 | 487 | 449 | 488 | 468 | 444 | 468 |
| 2048 | 618 | 618 | 797  | 196 | 432 | 596 | 454 | 558 | 468 | 444 | 468 |
| 2049 | 678 | 678 | 941  | 216 | 436 | 696 | 523 | 625 | 536 | 512 | 536 |
| 2050 | 728 | 728 | 1079 | 236 | 484 | 751 | 595 | 693 | 604 | 580 | 604 |
| 2051 | 771 | 771 | 1210 | 257 | 535 | 772 | 665 | 739 | 672 | 648 | 672 |
| 2052 | 798 | 798 | 1305 | 276 | 585 | 791 | 724 | 765 | 728 | 704 | 728 |
| 2053 | 805 | 805 | 1365 | 290 | 642 | 803 | 760 | 780 | 762 | 738 | 762 |
| 2054 | 808 | 808 | 1395 | 297 | 693 | 803 | 780 | 796 | 780 | 756 | 780 |
| 2055 | 813 | 813 | 1420 | 303 | 736 | 803 | 796 | 805 | 796 | 772 | 796 |
| 2056 | 813 | 813 | 1434 | 308 | 762 | 803 | 805 | 810 | 805 | 781 | 805 |
| 2057 | 813 | 813 | 1442 | 311 | 783 | 803 | 810 | 814 | 810 | 786 | 810 |
| 2058 | 813 | 813 | 1448 | 313 | 796 | 803 | 814 | 814 | 814 | 790 | 814 |
| 2059 | 813 | 813 | 1448 | 313 | 804 | 803 | 814 | 814 | 814 | 790 | 814 |

|      | 89  | 90  | 91   | 92  | 93  | 94  | 95  | 96  | 97  | 98  | 99  |
|------|-----|-----|------|-----|-----|-----|-----|-----|-----|-----|-----|
| 2060 | 813 | 813 | 1448 | 313 | 808 | 803 | 814 | 814 | 814 | 790 | 814 |
| 2061 | 813 | 813 | 1448 | 313 | 812 | 803 | 814 | 814 | 814 | 790 | 814 |
| 2062 | 813 | 813 | 1448 | 313 | 814 | 803 | 814 | 814 | 814 | 790 | 814 |
| 2063 | 813 | 813 | 1448 | 313 | 814 | 803 | 814 | 814 | 814 | 790 | 814 |
| 2064 | 813 | 813 | 1448 | 313 | 814 | 803 | 814 | 814 | 814 | 790 | 814 |
| 2065 | 813 | 813 | 1448 | 313 | 814 | 803 | 814 | 814 | 814 | 790 | 814 |
| 2066 | 813 | 813 | 1448 | 313 | 814 | 803 | 814 | 814 | 814 | 790 | 814 |
| 2067 | 813 | 813 | 1448 | 313 | 814 | 803 | 814 | 814 | 814 | 790 | 814 |
| 2068 | 813 | 813 | 1448 | 313 | 814 | 803 | 814 | 814 | 814 | 790 | 814 |
| 2069 | 813 | 813 | 1448 | 313 | 814 | 803 | 814 | 814 | 814 | 790 | 814 |
| 2070 | 813 | 813 | 1448 | 313 | 814 | 803 | 814 | 814 | 814 | 790 | 814 |
| 2071 | 813 | 813 | 1448 | 313 | 814 | 803 | 814 | 814 | 814 | 790 | 814 |
| 2072 | 813 | 813 | 1448 | 313 | 814 | 803 | 814 | 814 | 814 | 790 | 814 |
| 2073 | 813 | 813 | 1448 | 313 | 814 | 803 | 814 | 814 | 814 | 790 | 814 |
| 2074 | 813 | 813 | 1448 | 313 | 814 | 803 | 814 | 814 | 814 | 790 | 814 |
| 2075 | 813 | 813 | 1448 | 313 | 814 | 803 | 814 | 814 | 814 | 790 | 814 |
| 2076 | 813 | 813 | 1448 | 313 | 814 | 803 | 814 | 814 | 814 | 790 | 814 |
| 2077 | 813 | 813 | 1448 | 313 | 814 | 803 | 814 | 814 | 814 | 790 | 814 |
| 2078 | 813 | 813 | 1448 | 313 | 814 | 803 | 814 | 814 | 814 | 790 | 814 |
| 2079 | 813 | 813 | 1448 | 313 | 814 | 803 | 814 | 814 | 814 | 790 | 814 |
| 2080 | 813 | 813 | 1448 | 313 | 814 | 803 | 814 | 814 | 814 | 790 | 814 |
| 2081 | 813 | 813 | 1448 | 313 | 814 | 803 | 814 | 814 | 814 | 790 | 814 |
| 2082 | 813 | 813 | 1448 | 313 | 814 | 803 | 814 | 814 | 814 | 790 | 814 |
| 2083 | 813 | 813 | 1448 | 313 | 814 | 803 | 814 | 814 | 814 | 790 | 814 |
| 2084 | 813 | 813 | 1448 | 313 | 814 | 803 | 814 | 814 | 814 | 790 | 814 |
| 2085 | 813 | 813 | 1448 | 313 | 814 | 803 | 814 | 814 | 814 | 790 | 814 |
| 2086 | 813 | 813 | 1448 | 313 | 814 | 803 | 814 | 814 | 814 | 790 | 814 |
| 2087 | 813 | 813 | 1448 | 313 | 814 | 803 | 814 | 814 | 814 | 790 | 814 |
| 2088 | 813 | 813 | 1448 | 313 | 814 | 803 | 814 | 814 | 814 | 790 | 814 |
| 2089 | 813 | 813 | 1448 | 313 | 814 | 803 | 814 | 814 | 814 | 790 | 814 |
| 2090 | 813 | 813 | 1448 | 313 | 814 | 803 | 814 | 814 | 814 | 790 | 814 |

|      | 100  | 101 | 102 | 103 | 104 | 105 | 106 | 107 | 108 | 109  | 110 |
|------|------|-----|-----|-----|-----|-----|-----|-----|-----|------|-----|
| 2002 | 0    | 0   | 0   | 0   | 0   | 0   | 0   | 0   | 0   | 0    | 0   |
| 2003 | 0    | 0   | 0   | 0   | 0   | 0   | 0   | 0   | 0   | 0    | 0   |
| 2004 | 0    | 0   | 0   | 0   | 0   | 0   | 0   | 0   | 0   | 0    | 0   |
| 2005 | 0    | 0   | 0   | 0   | 0   | 0   | 0   | 0   | 0   | 0    | 0   |
| 2006 | 0    | 0   | 0   | 0   | 0   | 0   | 0   | 0   | 0   | 0    | 0   |
| 2007 | 0    | 0   | 0   | 0   | 0   | 0   | 0   | 0   | 0   | 0    | 0   |
| 2008 | 0    | 0   | 0   | 0   | 0   | 0   | 0   | 0   | 0   | 0    | 0   |
| 2009 | 0    | 0   | 0   | 0   | 0   | 0   | 0   | 0   | 0   | 0    | 0   |
| 2010 | 0    | 0   | 0   | 0   | 0   | 0   | 0   | 0   | 0   | 0    | 0   |
| 2011 | 0    | 0   | 0   | 0   | 0   | 0   | 0   | 0   | 0   | 0    | 0   |
| 2012 | 0    | 0   | 0   | 0   | 0   | 0   | 0   | 0   | 0   | 0    | 0   |
| 2013 | 0    | 0   | 0   | 0   | 0   | 0   | 0   | 0   | 0   | 0    | 0   |
| 2014 | 0    | 0   | 0   | 0   | 0   | 0   | 0   | 0   | 0   | 0    | 0   |
| 2015 | 0    | 0   | 0   | 0   | 0   | 0   | 0   | 0   | 0   | 0    | 0   |
| 2016 | 0    | 0   | 0   | 0   | 0   | 0   | 0   | 0   | 0   | 0    | 0   |
| 2017 | 0    | 0   | 0   | 0   | 0   | 0   | 0   | 0   | 0   | 0    | 0   |
| 2018 | 0    | 0   | 0   | 0   | 0   | 0   | 0   | 0   | 0   | 0    | 0   |
| 2019 | 0    | 0   | 0   | 0   | 0   | 0   | 0   | 0   | 0   | 0    | 0   |
| 2020 | 0    | 0   | 0   | 0   | 0   | 0   | 0   | 0   | 0   | 0    | 0   |
| 2021 | 0    | 0   | 0   | 78  | 0   | 0   | 0   | 0   | 0   | 0    | 0   |
| 2022 | 0    | 0   | 0   | 134 | 0   | 0   | 0   | 0   | 0   | 0    | 0   |
| 2023 | 0    | 0   | 0   | 196 | 0   | 0   | 0   | 0   | 0   | 0    | 0   |
| 2024 | 0    | 0   | 0   | 242 | 0   | 0   | 0   | 0   | 0   | 0    | 0   |
| 2025 | 0    | 0   | 0   | 261 | 0   | 0   | 0   | 0   | 0   | 0    | 0   |
| 2026 | 96   | 17  | 0   | 280 | 47  | 47  | 47  | 32  | 47  | 0    | 0   |
| 2027 | 182  | 41  | 0   | 303 | 104 | 102 | 102 | 69  | 100 | 0    | 0   |
| 2028 | 260  | 57  | 0   | 317 | 143 | 141 | 141 | 95  | 139 | 0    | 0   |
| 2029 | 341  | 77  | 0   | 333 | 196 | 190 | 189 | 126 | 187 | 0    | 0   |
| 2030 | 410  | 95  | 0   | 362 | 239 | 236 | 235 | 163 | 233 | 0    | 0   |
| 2031 | 462  | 109 | 34  | 371 | 272 | 269 | 268 | 189 | 266 | 0    | 0   |
| 2032 | 498  | 116 | 75  | 380 | 285 | 288 | 287 | 208 | 285 | 0    | 0   |
| 2033 | 532  | 123 | 122 | 391 | 309 | 315 | 308 | 229 | 306 | 12   | 0   |
| 2034 | 563  | 132 | 156 | 405 | 326 | 337 | 327 | 248 | 325 | 13   | 1   |
| 2035 | 583  | 138 | 201 | 419 | 336 | 346 | 338 | 259 | 336 | 19   | 4   |
| 2036 | 614  | 147 | 236 | 432 | 356 | 363 | 357 | 278 | 355 | 47   | 11  |
| 2037 | 628  | 153 | 266 | 445 | 368 | 375 | 367 | 288 | 365 | 82   | 23  |
| 2038 | 655  | 161 | 290 | 452 | 385 | 390 | 384 | 305 | 382 | 94   | 26  |
| 2039 | 678  | 169 | 308 | 453 | 400 | 403 | 400 | 321 | 398 | 131  | 34  |
| 2040 | 695  | 174 | 325 | 453 | 411 | 411 | 411 | 332 | 409 | 153  | 34  |
| 2041 | 711  | 179 | 349 | 453 | 423 | 424 | 421 | 342 | 419 | 173  | 38  |
| 2042 | 738  | 184 | 374 | 467 | 438 | 441 | 438 | 359 | 436 | 195  | 44  |
| 2043 | 745  | 186 | 394 | 478 | 444 | 451 | 442 | 363 | 440 | 220  | 47  |
| 2044 | 751  | 187 | 408 | 499 | 451 | 459 | 445 | 366 | 443 | 383  | 91  |
| 2045 | 761  | 189 | 418 | 605 | 452 | 472 | 449 | 370 | 447 | 544  | 133 |
| 2046 | 784  | 193 | 425 | 697 | 457 | 489 | 461 | 382 | 459 | 641  | 146 |
| 2047 | 922  | 213 | 432 | 745 | 526 | 558 | 529 | 450 | 527 | 744  | 153 |
| 2048 | 1064 | 234 | 434 | 767 | 599 | 624 | 601 | 522 | 599 | 825  | 160 |
| 2049 | 1200 | 257 | 440 | 785 | 666 | 693 | 671 | 592 | 669 | 889  | 168 |
| 2050 | 1294 | 276 | 487 | 792 | 724 | 741 | 726 | 647 | 724 | 982  | 212 |
| 2051 | 1354 | 290 | 538 | 799 | 760 | 765 | 762 | 683 | 760 | 1093 | 238 |
| 2052 | 1385 | 297 | 591 | 799 | 778 | 780 | 780 | 701 | 778 | 1235 | 284 |
| 2053 | 1410 | 303 | 651 | 799 | 794 | 796 | 796 | 717 | 794 | 1336 | 313 |
| 2054 | 1424 | 308 | 698 | 799 | 803 | 805 | 805 | 726 | 803 | 1398 | 313 |
| 2055 | 1432 | 311 | 741 | 799 | 808 | 810 | 810 | 731 | 808 | 1440 | 313 |
| 2056 | 1438 | 313 | 766 | 799 | 808 | 814 | 814 | 735 | 812 | 1449 | 313 |
| 2057 | 1438 | 313 | 783 | 799 | 808 | 814 | 814 | 735 | 812 | 1449 | 313 |
| 2058 | 1438 | 313 | 796 | 799 | 808 | 814 | 814 | 735 | 812 | 1449 | 313 |
| 2059 | 1438 | 313 | 804 | 799 | 808 | 814 | 814 | 735 | 812 | 1449 | 313 |

|      | 100  | 101 | 102 | 103 | 104 | 105 | 106 | 107 | 108 | 109  | 110 |
|------|------|-----|-----|-----|-----|-----|-----|-----|-----|------|-----|
| 2060 | 1438 | 313 | 808 | 799 | 808 | 814 | 814 | 735 | 812 | 1449 | 313 |
| 2061 | 1438 | 313 | 812 | 799 | 808 | 814 | 814 | 735 | 812 | 1449 | 313 |
| 2062 | 1438 | 313 | 814 | 799 | 808 | 814 | 814 | 735 | 812 | 1449 | 313 |
| 2063 | 1438 | 313 | 814 | 799 | 808 | 814 | 814 | 735 | 812 | 1449 | 313 |
| 2064 | 1438 | 313 | 814 | 799 | 808 | 814 | 814 | 735 | 812 | 1449 | 313 |
| 2065 | 1438 | 313 | 814 | 799 | 808 | 814 | 814 | 735 | 812 | 1449 | 313 |
| 2066 | 1438 | 313 | 814 | 799 | 808 | 814 | 814 | 735 | 812 | 1449 | 313 |
| 2067 | 1438 | 313 | 814 | 799 | 808 | 814 | 814 | 735 | 812 | 1449 | 313 |
| 2068 | 1438 | 313 | 814 | 799 | 808 | 814 | 814 | 735 | 812 | 1449 | 313 |
| 2069 | 1438 | 313 | 814 | 799 | 808 | 814 | 814 | 735 | 812 | 1449 | 313 |
| 2070 | 1438 | 313 | 814 | 799 | 808 | 814 | 814 | 735 | 812 | 1449 | 313 |
| 2071 | 1438 | 313 | 814 | 799 | 808 | 814 | 814 | 735 | 812 | 1449 | 313 |
| 2072 | 1438 | 313 | 814 | 799 | 808 | 814 | 814 | 735 | 812 | 1449 | 313 |
| 2073 | 1438 | 313 | 814 | 799 | 808 | 814 | 814 | 735 | 812 | 1449 | 313 |
| 2074 | 1438 | 313 | 814 | 799 | 808 | 814 | 814 | 735 | 812 | 1449 | 313 |
| 2075 | 1438 | 313 | 814 | 799 | 808 | 814 | 814 | 735 | 812 | 1449 | 313 |
| 2076 | 1438 | 313 | 814 | 799 | 808 | 814 | 814 | 735 | 812 | 1449 | 313 |
| 2077 | 1438 | 313 | 814 | 799 | 808 | 814 | 814 | 735 | 812 | 1449 | 313 |
| 2078 | 1438 | 313 | 814 | 799 | 808 | 814 | 814 | 735 | 812 | 1449 | 313 |
| 2079 | 1438 | 313 | 814 | 799 | 808 | 814 | 814 | 735 | 812 | 1449 | 313 |
| 2080 | 1438 | 313 | 814 | 799 | 808 | 814 | 814 | 735 | 812 | 1449 | 313 |
| 2081 | 1438 | 313 | 814 | 799 | 808 | 814 | 814 | 735 | 812 | 1449 | 313 |
| 2082 | 1438 | 313 | 814 | 799 | 808 | 814 | 814 | 735 | 812 | 1449 | 313 |
| 2083 | 1438 | 313 | 814 | 799 | 808 | 814 | 814 | 735 | 812 | 1449 | 313 |
| 2084 | 1438 | 313 | 814 | 799 | 808 | 814 | 814 | 735 | 812 | 1449 | 313 |
| 2085 | 1438 | 313 | 814 | 799 | 808 | 814 | 814 | 735 | 812 | 1449 | 313 |
| 2086 | 1438 | 313 | 814 | 799 | 808 | 814 | 814 | 735 | 812 | 1449 | 313 |
| 2087 | 1438 | 313 | 814 | 799 | 808 | 814 | 814 | 735 | 812 | 1449 | 313 |
| 2088 | 1438 | 313 | 814 | 799 | 808 | 814 | 814 | 735 | 812 | 1449 | 313 |
| 2089 | 1438 | 313 | 814 | 799 | 808 | 814 | 814 | 735 | 812 | 1449 | 313 |
| 2090 | 1438 | 313 | 814 | 799 | 808 | 814 | 814 | 735 | 812 | 1449 | 313 |

|      | 111 | 112 | 113 | 114 | 115 | 116 | 117 | 118  | 119 | 120 | 121 |
|------|-----|-----|-----|-----|-----|-----|-----|------|-----|-----|-----|
| 2002 | 0   | 0   | 0   | 0   | 0   | 0   | 0   | 0    | 0   | 0   | 0   |
| 2003 | 0   | 0   | 0   | 0   | 0   | 0   | 0   | 0    | 0   | 0   | 0   |
| 2004 | 0   | 0   | 0   | 0   | 0   | 0   | 0   | 0    | 0   | 0   | 0   |
| 2005 | 0   | 0   | 0   | 0   | 0   | 0   | 0   | 0    | 0   | 0   | 0   |
| 2006 | 0   | 0   | 0   | 0   | 0   | 0   | 0   | 0    | 0   | 0   | 0   |
| 2007 | 0   | 0   | 0   | 0   | 0   | 0   | 0   | 0    | 0   | 0   | 0   |
| 2008 | 0   | 0   | 0   | 0   | 0   | 0   | 0   | 0    | 0   | 0   | 0   |
| 2009 | 0   | 0   | 0   | 0   | 0   | 0   | 0   | 0    | 0   | 0   | 0   |
| 2010 | 0   | 0   | 0   | 0   | 0   | 0   | 0   | 0    | 0   | 0   | 0   |
| 2011 | 0   | 0   | 0   | 0   | 0   | 0   | 0   | 0    | 0   | 0   | 0   |
| 2012 | 0   | 0   | 0   | 0   | 0   | 0   | 0   | 0    | 0   | 0   | 0   |
| 2013 | 0   | 0   | 0   | 0   | 0   | 0   | 0   | 0    | 0   | 0   | 0   |
| 2014 | 0   | 0   | 0   | 0   | 0   | 0   | 0   | 0    | 0   | 0   | 0   |
| 2015 | 0   | 0   | 0   | 0   | 0   | 0   | 0   | 0    | 0   | 0   | 0   |
| 2016 | 0   | 0   | 0   | 0   | 0   | 0   | 0   | 0    | 0   | 0   | 0   |
| 2017 | 0   | 0   | 0   | 0   | 0   | 0   | 0   | 0    | 0   | 0   | 0   |
| 2018 | 0   | 0   | 0   | 0   | 0   | 0   | 0   | 0    | 0   | 0   | 0   |
| 2019 | 0   | 0   | 0   | 0   | 0   | 0   | 0   | 0    | 0   | 0   | 0   |
| 2020 | 0   | 0   | 0   | 0   | 0   | 0   | 0   | 0    | 0   | 0   | 0   |
| 2021 | 0   | 0   | 0   | 0   | 0   | 0   | 0   | 0    | 0   | 0   | 5   |
| 2022 | 0   | 0   | 0   | 0   | 0   | 0   | 0   | 0    | 0   | 0   | 5   |
| 2023 | 0   | 0   | 0   | 0   | 0   | 0   | 0   | 0    | 0   | 0   | 16  |
| 2024 | 0   | 0   | 0   | 0   | 0   | 0   | 0   | 0    | 0   | 0   | 33  |
| 2025 | 0   | 0   | 0   | 0   | 0   | 0   | 0   | 0    | 0   | 0   | 51  |
| 2026 | 0   | 0   | 0   | 0   | 0   | 0   | 0   | 7    | 4   | 0   | 81  |
| 2027 | 0   | 0   | 0   | 0   | 0   | 0   | 0   | 18   | 6   | 0   | 89  |
| 2028 | 0   | 2   | 0   | 0   | 0   | 0   | 0   | 27   | 15  | 0   | 104 |
| 2029 | 0   | 4   | 0   | 0   | 0   | 0   | 0   | 51   | 36  | 0   | 123 |
| 2030 | 0   | 19  | 0   | 0   | 0   | 0   | 0   | 75   | 46  | 0   | 161 |
| 2031 | 0   | 29  | 0   | 1   | 0   | 0   | 0   | 97   | 51  | 2   | 200 |
| 2032 | 0   | 47  | 0   | 15  | 0   | 0   | 0   | 142  | 70  | 16  | 229 |
| 2033 | 0   | 70  | 0   | 39  | 1   | 1   | 1   | 179  | 89  | 33  | 252 |
| 2034 | 0   | 87  | 0   | 72  | 2   | 2   | 2   | 208  | 102 | 52  | 292 |
| 2035 | 0   | 91  | 0   | 86  | 8   | 8   | 8   | 243  | 124 | 78  | 307 |
| 2036 | 0   | 96  | 1   | 92  | 35  | 35  | 35  | 314  | 145 | 110 | 331 |
| 2037 | 0   | 102 | 1   | 92  | 60  | 60  | 60  | 362  | 151 | 143 | 332 |
| 2038 | 0   | 110 | 16  | 96  | 68  | 68  | 68  | 382  | 151 | 177 | 351 |
| 2039 | 2   | 125 | 23  | 100 | 93  | 93  | 93  | 396  | 151 | 207 | 366 |
| 2040 | 16  | 137 | 47  | 111 | 109 | 109 | 109 | 414  | 151 | 228 | 375 |
| 2041 | 25  | 161 | 56  | 130 | 122 | 122 | 122 | 443  | 153 | 260 | 375 |
| 2042 | 58  | 268 | 99  | 157 | 129 | 129 | 129 | 476  | 154 | 275 | 375 |
| 2043 | 65  | 393 | 128 | 172 | 149 | 149 | 149 | 513  | 158 | 286 | 383 |
| 2044 | 99  | 472 | 225 | 277 | 215 | 215 | 215 | 541  | 158 | 292 | 395 |
| 2045 | 111 | 558 | 310 | 353 | 304 | 304 | 304 | 568  | 161 | 292 | 411 |
| 2046 | 199 | 646 | 365 | 401 | 372 | 372 | 372 | 586  | 164 | 295 | 423 |
| 2047 | 290 | 722 | 398 | 438 | 426 | 426 | 426 | 594  | 165 | 306 | 439 |
| 2048 | 357 | 769 | 437 | 461 | 452 | 452 | 452 | 604  | 167 | 369 | 441 |
| 2049 | 394 | 809 | 472 | 503 | 490 | 490 | 490 | 639  | 181 | 401 | 441 |
| 2050 | 417 | 814 | 532 | 573 | 558 | 558 | 558 | 739  | 205 | 411 | 602 |
| 2051 | 437 | 814 | 624 | 651 | 648 | 648 | 648 | 800  | 216 | 428 | 722 |
| 2052 | 469 | 814 | 711 | 731 | 727 | 727 | 727 | 905  | 248 | 463 | 786 |
| 2053 | 485 | 814 | 770 | 777 | 777 | 777 | 777 | 1084 | 290 | 500 | 806 |
| 2054 | 513 | 814 | 802 | 809 | 809 | 809 | 809 | 1237 | 306 | 556 | 812 |
| 2055 | 595 | 814 | 814 | 814 | 814 | 814 | 814 | 1328 | 307 | 631 | 814 |
| 2056 | 680 | 814 | 814 | 814 | 814 | 814 | 814 | 1390 | 313 | 699 | 814 |
| 2057 | 742 | 814 | 814 | 814 | 814 | 814 | 814 | 1427 | 313 | 759 | 814 |
| 2058 | 784 | 814 | 814 | 814 | 814 | 814 | 814 | 1448 | 313 | 805 | 814 |
| 2059 | 812 | 814 | 814 | 814 | 814 | 814 | 814 | 1449 | 313 | 814 | 814 |

|      | 111 | 112 | 113 | 114 | 115 | 116 | 117 | 118  | 119 | 120 | 121 |
|------|-----|-----|-----|-----|-----|-----|-----|------|-----|-----|-----|
| 2060 | 814 | 814 | 814 | 814 | 814 | 814 | 814 | 1449 | 313 | 814 | 814 |
| 2061 | 814 | 814 | 814 | 814 | 814 | 814 | 814 | 1449 | 313 | 814 | 814 |
| 2062 | 814 | 814 | 814 | 814 | 814 | 814 | 814 | 1449 | 313 | 814 | 814 |
| 2063 | 814 | 814 | 814 | 814 | 814 | 814 | 814 | 1449 | 313 | 814 | 814 |
| 2064 | 814 | 814 | 814 | 814 | 814 | 814 | 814 | 1449 | 313 | 814 | 814 |
| 2065 | 814 | 814 | 814 | 814 | 814 | 814 | 814 | 1449 | 313 | 814 | 814 |
| 2066 | 814 | 814 | 814 | 814 | 814 | 814 | 814 | 1449 | 313 | 814 | 814 |
| 2067 | 814 | 814 | 814 | 814 | 814 | 814 | 814 | 1449 | 313 | 814 | 814 |
| 2068 | 814 | 814 | 814 | 814 | 814 | 814 | 814 | 1449 | 313 | 814 | 814 |
| 2069 | 814 | 814 | 814 | 814 | 814 | 814 | 814 | 1449 | 313 | 814 | 814 |
| 2070 | 814 | 814 | 814 | 814 | 814 | 814 | 814 | 1449 | 313 | 814 | 814 |
| 2071 | 814 | 814 | 814 | 814 | 814 | 814 | 814 | 1449 | 313 | 814 | 814 |
| 2072 | 814 | 814 | 814 | 814 | 814 | 814 | 814 | 1449 | 313 | 814 | 814 |
| 2073 | 814 | 814 | 814 | 814 | 814 | 814 | 814 | 1449 | 313 | 814 | 814 |
| 2074 | 814 | 814 | 814 | 814 | 814 | 814 | 814 | 1449 | 313 | 814 | 814 |
| 2075 | 814 | 814 | 814 | 814 | 814 | 814 | 814 | 1449 | 313 | 814 | 814 |
| 2076 | 814 | 814 | 814 | 814 | 814 | 814 | 814 | 1449 | 313 | 814 | 814 |
| 2077 | 814 | 814 | 814 | 814 | 814 | 814 | 814 | 1449 | 313 | 814 | 814 |
| 2078 | 814 | 814 | 814 | 814 | 814 | 814 | 814 | 1449 | 313 | 814 | 814 |
| 2079 | 814 | 814 | 814 | 814 | 814 | 814 | 814 | 1449 | 313 | 814 | 814 |
| 2080 | 814 | 814 | 814 | 814 | 814 | 814 | 814 | 1449 | 313 | 814 | 814 |
| 2081 | 814 | 814 | 814 | 814 | 814 | 814 | 814 | 1449 | 313 | 814 | 814 |
| 2082 | 814 | 814 | 814 | 814 | 814 | 814 | 814 | 1449 | 313 | 814 | 814 |
| 2083 | 814 | 814 | 814 | 814 | 814 | 814 | 814 | 1449 | 313 | 814 | 814 |
| 2084 | 814 | 814 | 814 | 814 | 814 | 814 | 814 | 1449 | 313 | 814 | 814 |
| 2085 | 814 | 814 | 814 | 814 | 814 | 814 | 814 | 1449 | 313 | 814 | 814 |
| 2086 | 814 | 814 | 814 | 814 | 814 | 814 | 814 | 1449 | 313 | 814 | 814 |
| 2087 | 814 | 814 | 814 | 814 | 814 | 814 | 814 | 1449 | 313 | 814 | 814 |
| 2088 | 814 | 814 | 814 | 814 | 814 | 814 | 814 | 1449 | 313 | 814 | 814 |
| 2089 | 814 | 814 | 814 | 814 | 814 | 814 | 814 | 1449 | 313 | 814 | 814 |
| 2090 | 814 | 814 | 814 | 814 | 814 | 814 | 814 | 1449 | 313 | 814 | 814 |



|      | 122 | 123 | 124 | 125 | 126 | 127  | 128 | 129 | 130 | 131 | 132 |
|------|-----|-----|-----|-----|-----|------|-----|-----|-----|-----|-----|
| 2002 | 0   | 0   | 0   | 0   | 0   | 0    | 0   | 0   | 0   | 0   | 0   |
| 2003 | 0   | 0   | 0   | 0   | 0   | 0    | 0   | 0   | 0   | 0   | 0   |
| 2004 | 0   | 0   | 0   | 0   | 0   | 0    | 0   | 0   | 0   | 0   | 0   |
| 2005 | 0   | 0   | 0   | 0   | 0   | 0    | 0   | 0   | 0   | 0   | 0   |
| 2006 | 0   | 0   | 0   | 0   | 0   | 0    | 0   | 0   | 0   | 0   | 0   |
| 2007 | 0   | 0   | 0   | 0   | 0   | 0    | 0   | 0   | 0   | 0   | 0   |
| 2008 | 0   | 0   | 0   | 0   | 0   | 0    | 0   | 0   | 0   | 0   | 0   |
| 2009 | 0   | 0   | 0   | 0   | 0   | 0    | 0   | 0   | 0   | 0   | 0   |
| 2010 | 0   | 0   | 0   | 0   | 0   | 0    | 0   | 0   | 0   | 0   | 0   |
| 2011 | 0   | 0   | 0   | 0   | 0   | 0    | 0   | 0   | 0   | 0   | 0   |
| 2012 | 0   | 0   | 0   | 0   | 0   | 0    | 0   | 0   | 0   | 0   | 0   |
| 2013 | 0   | 0   | 0   | 0   | 0   | 0    | 0   | 0   | 0   | 0   | 0   |
| 2014 | 0   | 0   | 0   | 0   | 0   | 0    | 0   | 0   | 0   | 0   | 0   |
| 2015 | 0   | 0   | 0   | 0   | 0   | 0    | 0   | 0   | 0   | 0   | 0   |
| 2016 | 0   | 0   | 0   | 0   | 0   | 0    | 0   | 0   | 0   | 0   | 0   |
| 2017 | 0   | 0   | 0   | 0   | 0   | 0    | 0   | 0   | 0   | 0   | 0   |
| 2018 | 0   | 0   | 0   | 0   | 0   | 0    | 0   | 0   | 0   | 0   | 0   |
| 2019 | 0   | 0   | 0   | 0   | 0   | 0    | 0   | 0   | 0   | 0   | 0   |
| 2020 | 0   | 0   | 0   | 0   | 0   | 0    | 0   | 0   | 0   | 0   | 0   |
| 2021 | 0   | 0   | 0   | 0   | 0   | 0    | 0   | 0   | 3   | 0   | 0   |
| 2022 | 0   | 0   | 0   | 0   | 0   | 0    | 0   | 0   | 6   | 0   | 0   |
| 2023 | 0   | 0   | 0   | 0   | 0   | 0    | 0   | 0   | 12  | 0   | 0   |
| 2024 | 0   | 0   | 0   | 0   | 0   | 0    | 0   | 0   | 21  | 0   | 0   |
| 2025 | 0   | 0   | 0   | 0   | 0   | 0    | 0   | 0   | 32  | 0   | 0   |
| 2026 | 4   | 23  | 7   | 1   | 7   | 7    | 6   | 0   | 43  | 4   | 14  |
| 2027 | 16  | 48  | 13  | 3   | 13  | 15   | 10  | 0   | 63  | 9   | 27  |
| 2028 | 24  | 71  | 22  | 12  | 22  | 21   | 16  | 0   | 73  | 12  | 49  |
| 2029 | 41  | 93  | 46  | 36  | 46  | 29   | 22  | 0   | 76  | 18  | 72  |
| 2030 | 56  | 107 | 68  | 58  | 68  | 47   | 30  | 0   | 85  | 28  | 89  |
| 2031 | 60  | 124 | 89  | 79  | 89  | 63   | 37  | 5   | 106 | 35  | 105 |
| 2032 | 87  | 133 | 113 | 103 | 113 | 83   | 39  | 13  | 123 | 58  | 125 |
| 2033 | 111 | 147 | 140 | 130 | 140 | 107  | 44  | 28  | 171 | 69  | 147 |
| 2034 | 125 | 166 | 159 | 149 | 159 | 117  | 52  | 38  | 199 | 83  | 159 |
| 2035 | 138 | 188 | 188 | 178 | 188 | 141  | 64  | 46  | 237 | 95  | 184 |
| 2036 | 177 | 236 | 247 | 237 | 247 | 177  | 86  | 60  | 259 | 114 | 226 |
| 2037 | 211 | 269 | 273 | 263 | 273 | 219  | 94  | 75  | 272 | 141 | 254 |
| 2038 | 227 | 285 | 278 | 268 | 278 | 267  | 108 | 93  | 295 | 161 | 270 |
| 2039 | 247 | 314 | 287 | 277 | 287 | 321  | 126 | 122 | 320 | 189 | 295 |
| 2040 | 254 | 333 | 300 | 290 | 300 | 348  | 140 | 149 | 341 | 200 | 312 |
| 2041 | 281 | 336 | 311 | 301 | 311 | 373  | 151 | 182 | 349 | 223 | 327 |
| 2042 | 304 | 349 | 324 | 314 | 324 | 394  | 153 | 199 | 357 | 237 | 331 |
| 2043 | 323 | 360 | 340 | 330 | 340 | 428  | 153 | 218 | 361 | 252 | 347 |
| 2044 | 339 | 362 | 346 | 336 | 346 | 455  | 154 | 235 | 362 | 274 | 355 |
| 2045 | 346 | 368 | 356 | 346 | 356 | 483  | 154 | 239 | 368 | 289 | 364 |
| 2046 | 350 | 380 | 363 | 353 | 363 | 509  | 158 | 239 | 444 | 297 | 375 |
| 2047 | 358 | 395 | 370 | 360 | 370 | 610  | 179 | 240 | 599 | 379 | 390 |
| 2048 | 398 | 400 | 373 | 363 | 373 | 724  | 195 | 314 | 707 | 438 | 426 |
| 2049 | 425 | 435 | 405 | 395 | 405 | 780  | 216 | 361 | 773 | 460 | 525 |
| 2050 | 459 | 544 | 453 | 443 | 453 | 855  | 231 | 393 | 796 | 470 | 630 |
| 2051 | 505 | 649 | 493 | 483 | 493 | 1017 | 271 | 426 | 802 | 519 | 711 |
| 2052 | 596 | 723 | 568 | 558 | 568 | 1178 | 301 | 449 | 802 | 634 | 771 |
| 2053 | 704 | 771 | 674 | 664 | 674 | 1296 | 307 | 493 | 805 | 717 | 799 |
| 2054 | 768 | 811 | 751 | 741 | 751 | 1363 | 313 | 546 | 805 | 774 | 809 |
| 2055 | 801 | 814 | 800 | 790 | 800 | 1410 | 313 | 615 | 805 | 809 | 812 |
| 2056 | 814 | 814 | 814 | 804 | 814 | 1440 | 313 | 677 | 805 | 812 | 812 |
| 2057 | 814 | 814 | 814 | 804 | 814 | 1442 | 313 | 722 | 805 | 812 | 812 |
| 2058 | 814 | 814 | 814 | 804 | 814 | 1442 | 313 | 768 | 805 | 812 | 812 |
| 2059 | 814 | 814 | 814 | 804 | 814 | 1442 | 313 | 797 | 805 | 812 | 812 |

|      | 122 | 123 | 124 | 125 | 126 | 127  | 128 | 129 | 130 | 131 | 132 |
|------|-----|-----|-----|-----|-----|------|-----|-----|-----|-----|-----|
| 2060 | 814 | 814 | 814 | 804 | 814 | 1442 | 313 | 814 | 805 | 812 | 812 |
| 2061 | 814 | 814 | 814 | 804 | 814 | 1442 | 313 | 814 | 805 | 812 | 812 |
| 2062 | 814 | 814 | 814 | 804 | 814 | 1442 | 313 | 814 | 805 | 812 | 812 |
| 2063 | 814 | 814 | 814 | 804 | 814 | 1442 | 313 | 814 | 805 | 812 | 812 |
| 2064 | 814 | 814 | 814 | 804 | 814 | 1442 | 313 | 814 | 805 | 812 | 812 |
| 2065 | 814 | 814 | 814 | 804 | 814 | 1442 | 313 | 814 | 805 | 812 | 812 |
| 2066 | 814 | 814 | 814 | 804 | 814 | 1442 | 313 | 814 | 805 | 812 | 812 |
| 2067 | 814 | 814 | 814 | 804 | 814 | 1442 | 313 | 814 | 805 | 812 | 812 |
| 2068 | 814 | 814 | 814 | 804 | 814 | 1442 | 313 | 814 | 805 | 812 | 812 |
| 2069 | 814 | 814 | 814 | 804 | 814 | 1442 | 313 | 814 | 805 | 812 | 812 |
| 2070 | 814 | 814 | 814 | 804 | 814 | 1442 | 313 | 814 | 805 | 812 | 812 |
| 2071 | 814 | 814 | 814 | 804 | 814 | 1442 | 313 | 814 | 805 | 812 | 812 |
| 2072 | 814 | 814 | 814 | 804 | 814 | 1442 | 313 | 814 | 805 | 812 | 812 |
| 2073 | 814 | 814 | 814 | 804 | 814 | 1442 | 313 | 814 | 805 | 812 | 812 |
| 2074 | 814 | 814 | 814 | 804 | 814 | 1442 | 313 | 814 | 805 | 812 | 812 |
| 2075 | 814 | 814 | 814 | 804 | 814 | 1442 | 313 | 814 | 805 | 812 | 812 |
| 2076 | 814 | 814 | 814 | 804 | 814 | 1442 | 313 | 814 | 805 | 812 | 812 |
| 2077 | 814 | 814 | 814 | 804 | 814 | 1442 | 313 | 814 | 805 | 812 | 812 |
| 2078 | 814 | 814 | 814 | 804 | 814 | 1442 | 313 | 814 | 805 | 812 | 812 |
| 2079 | 814 | 814 | 814 | 804 | 814 | 1442 | 313 | 814 | 805 | 812 | 812 |
| 2080 | 814 | 814 | 814 | 804 | 814 | 1442 | 313 | 814 | 805 | 812 | 812 |
| 2081 | 814 | 814 | 814 | 804 | 814 | 1442 | 313 | 814 | 805 | 812 | 812 |
| 2082 | 814 | 814 | 814 | 804 | 814 | 1442 | 313 | 814 | 805 | 812 | 812 |
| 2083 | 814 | 814 | 814 | 804 | 814 | 1442 | 313 | 814 | 805 | 812 | 812 |
| 2084 | 814 | 814 | 814 | 804 | 814 | 1442 | 313 | 814 | 805 | 812 | 812 |
| 2085 | 814 | 814 | 814 | 804 | 814 | 1442 | 313 | 814 | 805 | 812 | 812 |
| 2086 | 814 | 814 | 814 | 804 | 814 | 1442 | 313 | 814 | 805 | 812 | 812 |
| 2087 | 814 | 814 | 814 | 804 | 814 | 1442 | 313 | 814 | 805 | 812 | 812 |
| 2088 | 814 | 814 | 814 | 804 | 814 | 1442 | 313 | 814 | 805 | 812 | 812 |
| 2089 | 814 | 814 | 814 | 804 | 814 | 1442 | 313 | 814 | 805 | 812 | 812 |
| 2090 | 814 | 814 | 814 | 804 | 814 | 1442 | 313 | 814 | 805 | 812 | 812 |

|      | 133 | 134 | 135 | 136  | 137 | 138 | 139 | 140 | 141 | 142 | 143 |
|------|-----|-----|-----|------|-----|-----|-----|-----|-----|-----|-----|
| 2002 | 0   | 0   | 0   | 0    | 0   | 0   | 0   | 0   | 0   | 0   | 0   |
| 2003 | 0   | 0   | 0   | 0    | 0   | 0   | 0   | 0   | 0   | 0   | 0   |
| 2004 | 0   | 0   | 0   | 0    | 0   | 0   | 0   | 0   | 0   | 0   | 0   |
| 2005 | 0   | 0   | 0   | 0    | 0   | 0   | 0   | 0   | 0   | 0   | 0   |
| 2006 | 0   | 0   | 0   | 0    | 0   | 0   | 0   | 0   | 0   | 0   | 0   |
| 2007 | 0   | 0   | 0   | 0    | 0   | 0   | 0   | 0   | 0   | 0   | 0   |
| 2008 | 0   | 0   | 0   | 0    | 0   | 0   | 0   | 0   | 0   | 0   | 0   |
| 2009 | 0   | 0   | 0   | 0    | 0   | 0   | 0   | 0   | 0   | 0   | 0   |
| 2010 | 0   | 0   | 0   | 0    | 0   | 0   | 0   | 0   | 0   | 0   | 0   |
| 2011 | 0   | 0   | 0   | 0    | 0   | 0   | 0   | 0   | 0   | 0   | 0   |
| 2012 | 0   | 0   | 0   | 0    | 0   | 0   | 0   | 0   | 0   | 0   | 0   |
| 2013 | 0   | 0   | 0   | 0    | 0   | 0   | 0   | 0   | 0   | 0   | 0   |
| 2014 | 0   | 0   | 0   | 0    | 0   | 0   | 0   | 0   | 0   | 0   | 0   |
| 2015 | 0   | 0   | 0   | 0    | 0   | 0   | 0   | 0   | 0   | 0   | 0   |
| 2016 | 0   | 0   | 0   | 0    | 0   | 0   | 0   | 0   | 0   | 0   | 0   |
| 2017 | 0   | 0   | 0   | 0    | 0   | 0   | 0   | 0   | 0   | 0   | 0   |
| 2018 | 0   | 0   | 0   | 0    | 0   | 0   | 0   | 0   | 0   | 0   | 0   |
| 2019 | 0   | 0   | 0   | 0    | 0   | 0   | 0   | 0   | 0   | 0   | 0   |
| 2020 | 0   | 0   | 0   | 0    | 0   | 0   | 0   | 0   | 0   | 0   | 0   |
| 2021 | 0   | 0   | 0   | 0    | 0   | 0   | 67  | 0   | 0   | 0   | 0   |
| 2022 | 0   | 0   | 0   | 0    | 0   | 0   | 138 | 0   | 0   | 0   | 0   |
| 2023 | 0   | 0   | 0   | 0    | 0   | 0   | 171 | 0   | 0   | 0   | 0   |
| 2024 | 0   | 0   | 0   | 0    | 0   | 0   | 210 | 0   | 0   | 0   | 0   |
| 2025 | 0   | 0   | 0   | 0    | 0   | 0   | 240 | 0   | 0   | 0   | 0   |
| 2026 | 7   | 2   | 7   | 66   | 23  | 0   | 279 | 40  | 40  | 40  | 40  |
| 2027 | 17  | 6   | 15  | 158  | 41  | 0   | 305 | 102 | 102 | 102 | 102 |
| 2028 | 23  | 12  | 21  | 239  | 56  | 0   | 337 | 144 | 144 | 144 | 144 |
| 2029 | 31  | 20  | 29  | 322  | 82  | 0   | 348 | 193 | 193 | 193 | 193 |
| 2030 | 49  | 38  | 47  | 383  | 84  | 0   | 350 | 222 | 222 | 222 | 222 |
| 2031 | 59  | 46  | 57  | 423  | 94  | 33  | 358 | 247 | 247 | 247 | 247 |
| 2032 | 73  | 56  | 71  | 491  | 113 | 96  | 361 | 285 | 285 | 285 | 285 |
| 2033 | 83  | 66  | 81  | 555  | 117 | 143 | 365 | 321 | 321 | 321 | 321 |
| 2034 | 92  | 75  | 90  | 590  | 117 | 186 | 395 | 339 | 339 | 339 | 339 |
| 2035 | 109 | 92  | 107 | 614  | 117 | 244 | 405 | 345 | 345 | 345 | 345 |
| 2036 | 144 | 127 | 142 | 628  | 117 | 287 | 429 | 345 | 346 | 345 | 345 |
| 2037 | 175 | 158 | 173 | 659  | 117 | 309 | 434 | 346 | 346 | 346 | 346 |
| 2038 | 207 | 190 | 205 | 670  | 117 | 329 | 434 | 347 | 347 | 347 | 347 |
| 2039 | 237 | 220 | 235 | 680  | 120 | 345 | 476 | 357 | 361 | 358 | 358 |
| 2040 | 258 | 241 | 256 | 697  | 122 | 345 | 478 | 369 | 379 | 372 | 372 |
| 2041 | 280 | 263 | 278 | 722  | 125 | 345 | 478 | 389 | 389 | 389 | 389 |
| 2042 | 295 | 278 | 293 | 740  | 125 | 345 | 505 | 394 | 394 | 394 | 394 |
| 2043 | 310 | 293 | 308 | 778  | 125 | 346 | 511 | 394 | 398 | 398 | 398 |
| 2044 | 323 | 306 | 321 | 804  | 133 | 357 | 645 | 428 | 428 | 428 | 428 |
| 2045 | 335 | 318 | 333 | 824  | 140 | 357 | 741 | 444 | 444 | 454 | 454 |
| 2046 | 347 | 330 | 345 | 1005 | 228 | 371 | 807 | 555 | 465 | 566 | 566 |
| 2047 | 401 | 384 | 399 | 1106 | 243 | 371 | 814 | 617 | 594 | 628 | 628 |
| 2048 | 439 | 422 | 437 | 1210 | 267 | 386 | 814 | 686 | 650 | 697 | 697 |
| 2049 | 485 | 468 | 483 | 1312 | 305 | 426 | 814 | 741 | 724 | 752 | 752 |
| 2050 | 535 | 518 | 533 | 1380 | 313 | 519 | 814 | 781 | 779 | 792 | 792 |
| 2051 | 633 | 616 | 631 | 1424 | 313 | 554 | 814 | 809 | 809 | 811 | 811 |
| 2052 | 728 | 711 | 726 | 1449 | 313 | 584 | 814 | 814 | 814 | 814 | 814 |
| 2053 | 783 | 766 | 781 | 1449 | 313 | 636 | 814 | 814 | 814 | 814 | 814 |
| 2054 | 809 | 792 | 807 | 1449 | 313 | 707 | 814 | 814 | 814 | 814 | 814 |
| 2055 | 814 | 797 | 812 | 1449 | 313 | 757 | 814 | 814 | 814 | 814 | 814 |
| 2056 | 814 | 797 | 812 | 1449 | 313 | 797 | 814 | 814 | 814 | 814 | 814 |
| 2057 | 814 | 797 | 812 | 1449 | 313 | 814 | 814 | 814 | 814 | 814 | 814 |
| 2058 | 814 | 797 | 812 | 1449 | 313 | 814 | 814 | 814 | 814 | 814 | 814 |
| 2059 | 814 | 797 | 812 | 1449 | 313 | 814 | 814 | 814 | 814 | 814 | 814 |

|      | 133 | 134 | 135 | 136  | 137 | 138 | 139 | 140 | 141 | 142 | 143 |
|------|-----|-----|-----|------|-----|-----|-----|-----|-----|-----|-----|
| 2060 | 814 | 797 | 812 | 1449 | 313 | 814 | 814 | 814 | 814 | 814 | 814 |
| 2061 | 814 | 797 | 812 | 1449 | 313 | 814 | 814 | 814 | 814 | 814 | 814 |
| 2062 | 814 | 797 | 812 | 1449 | 313 | 814 | 814 | 814 | 814 | 814 | 814 |
| 2063 | 814 | 797 | 812 | 1449 | 313 | 814 | 814 | 814 | 814 | 814 | 814 |
| 2064 | 814 | 797 | 812 | 1449 | 313 | 814 | 814 | 814 | 814 | 814 | 814 |
| 2065 | 814 | 797 | 812 | 1449 | 313 | 814 | 814 | 814 | 814 | 814 | 814 |
| 2066 | 814 | 797 | 812 | 1449 | 313 | 814 | 814 | 814 | 814 | 814 | 814 |
| 2067 | 814 | 797 | 812 | 1449 | 313 | 814 | 814 | 814 | 814 | 814 | 814 |
| 2068 | 814 | 797 | 812 | 1449 | 313 | 814 | 814 | 814 | 814 | 814 | 814 |
| 2069 | 814 | 797 | 812 | 1449 | 313 | 814 | 814 | 814 | 814 | 814 | 814 |
| 2070 | 814 | 797 | 812 | 1449 | 313 | 814 | 814 | 814 | 814 | 814 | 814 |
| 2071 | 814 | 797 | 812 | 1449 | 313 | 814 | 814 | 814 | 814 | 814 | 814 |
| 2072 | 814 | 797 | 812 | 1449 | 313 | 814 | 814 | 814 | 814 | 814 | 814 |
| 2073 | 814 | 797 | 812 | 1449 | 313 | 814 | 814 | 814 | 814 | 814 | 814 |
| 2074 | 814 | 797 | 812 | 1449 | 313 | 814 | 814 | 814 | 814 | 814 | 814 |
| 2075 | 814 | 797 | 812 | 1449 | 313 | 814 | 814 | 814 | 814 | 814 | 814 |
| 2076 | 814 | 797 | 812 | 1449 | 313 | 814 | 814 | 814 | 814 | 814 | 814 |
| 2077 | 814 | 797 | 812 | 1449 | 313 | 814 | 814 | 814 | 814 | 814 | 814 |
| 2078 | 814 | 797 | 812 | 1449 | 313 | 814 | 814 | 814 | 814 | 814 | 814 |
| 2079 | 814 | 797 | 812 | 1449 | 313 | 814 | 814 | 814 | 814 | 814 | 814 |
| 2080 | 814 | 797 | 812 | 1449 | 313 | 814 | 814 | 814 | 814 | 814 | 814 |
| 2081 | 814 | 797 | 812 | 1449 | 313 | 814 | 814 | 814 | 814 | 814 | 814 |
| 2082 | 814 | 797 | 812 | 1449 | 313 | 814 | 814 | 814 | 814 | 814 | 814 |
| 2083 | 814 | 797 | 812 | 1449 | 313 | 814 | 814 | 814 | 814 | 814 | 814 |
| 2084 | 814 | 797 | 812 | 1449 | 313 | 814 | 814 | 814 | 814 | 814 | 814 |
| 2085 | 814 | 797 | 812 | 1449 | 313 | 814 | 814 | 814 | 814 | 814 | 814 |
| 2086 | 814 | 797 | 812 | 1449 | 313 | 814 | 814 | 814 | 814 | 814 | 814 |
| 2087 | 814 | 797 | 812 | 1449 | 313 | 814 | 814 | 814 | 814 | 814 | 814 |
| 2088 | 814 | 797 | 812 | 1449 | 313 | 814 | 814 | 814 | 814 | 814 | 814 |
| 2089 | 814 | 797 | 812 | 1449 | 313 | 814 | 814 | 814 | 814 | 814 | 814 |
| 2090 | 814 | 797 | 812 | 1449 | 313 | 814 | 814 | 814 | 814 | 814 | 814 |

|      | 144 | 145  | 146 | 147 | 148 | 149 | 150 | 151 | 152 | 153 | 154  |
|------|-----|------|-----|-----|-----|-----|-----|-----|-----|-----|------|
| 2002 | 0   | 0    | 0   | 0   | 0   | 0   | 0   | 0   | 0   | 0   | 0    |
| 2003 | 0   | 0    | 0   | 0   | 0   | 0   | 0   | 0   | 0   | 0   | 0    |
| 2004 | 0   | 0    | 0   | 0   | 0   | 0   | 0   | 0   | 0   | 0   | 0    |
| 2005 | 0   | 0    | 0   | 0   | 0   | 0   | 0   | 0   | 0   | 0   | 0    |
| 2006 | 0   | 0    | 0   | 0   | 0   | 0   | 0   | 0   | 0   | 0   | 0    |
| 2007 | 0   | 0    | 0   | 0   | 0   | 0   | 0   | 0   | 0   | 0   | 0    |
| 2008 | 0   | 0    | 0   | 0   | 0   | 0   | 0   | 0   | 0   | 0   | 0    |
| 2009 | 0   | 0    | 0   | 0   | 0   | 0   | 0   | 0   | 0   | 0   | 0    |
| 2010 | 0   | 0    | 0   | 0   | 0   | 0   | 0   | 0   | 0   | 0   | 0    |
| 2011 | 0   | 0    | 0   | 0   | 0   | 0   | 0   | 0   | 0   | 0   | 0    |
| 2012 | 0   | 0    | 0   | 0   | 0   | 0   | 0   | 0   | 0   | 0   | 0    |
| 2013 | 0   | 0    | 0   | 0   | 0   | 0   | 0   | 0   | 0   | 0   | 0    |
| 2014 | 0   | 0    | 0   | 0   | 0   | 0   | 0   | 0   | 0   | 0   | 0    |
| 2015 | 0   | 0    | 0   | 0   | 0   | 0   | 0   | 0   | 0   | 0   | 0    |
| 2016 | 0   | 0    | 0   | 0   | 0   | 0   | 0   | 0   | 0   | 0   | 0    |
| 2017 | 0   | 0    | 0   | 0   | 0   | 0   | 0   | 0   | 0   | 0   | 0    |
| 2018 | 0   | 0    | 0   | 0   | 0   | 0   | 0   | 0   | 0   | 0   | 0    |
| 2019 | 0   | 0    | 0   | 0   | 0   | 0   | 0   | 0   | 0   | 0   | 0    |
| 2020 | 0   | 0    | 0   | 0   | 0   | 0   | 0   | 0   | 0   | 0   | 0    |
| 2021 | 0   | 0    | 0   | 0   | 130 | 0   | 0   | 0   | 0   | 0   | 0    |
| 2022 | 0   | 0    | 0   | 0   | 207 | 0   | 0   | 0   | 0   | 0   | 0    |
| 2023 | 0   | 0    | 0   | 0   | 259 | 0   | 0   | 0   | 0   | 0   | 0    |
| 2024 | 0   | 0    | 0   | 0   | 295 | 0   | 0   | 0   | 0   | 0   | 0    |
| 2025 | 0   | 0    | 0   | 0   | 311 | 0   | 0   | 0   | 0   | 0   | 0    |
| 2026 | 40  | 155  | 54  | 0   | 323 | 110 | 110 | 110 | 81  | 110 | 146  |
| 2027 | 102 | 279  | 109 | 0   | 344 | 204 | 204 | 204 | 164 | 204 | 261  |
| 2028 | 144 | 375  | 127 | 0   | 364 | 256 | 256 | 256 | 212 | 256 | 357  |
| 2029 | 193 | 441  | 140 | 0   | 384 | 278 | 278 | 278 | 234 | 278 | 423  |
| 2030 | 222 | 500  | 154 | 0   | 400 | 312 | 312 | 312 | 268 | 312 | 482  |
| 2031 | 247 | 531  | 163 | 91  | 410 | 333 | 333 | 333 | 289 | 333 | 513  |
| 2032 | 285 | 561  | 163 | 207 | 423 | 348 | 352 | 352 | 308 | 352 | 541  |
| 2033 | 321 | 602  | 163 | 270 | 435 | 370 | 380 | 370 | 326 | 370 | 582  |
| 2034 | 339 | 624  | 173 | 303 | 455 | 390 | 392 | 390 | 346 | 390 | 605  |
| 2035 | 345 | 640  | 173 | 323 | 463 | 390 | 392 | 390 | 346 | 390 | 621  |
| 2036 | 345 | 665  | 173 | 340 | 464 | 396 | 396 | 396 | 352 | 396 | 646  |
| 2037 | 346 | 682  | 177 | 360 | 464 | 406 | 406 | 406 | 362 | 406 | 660  |
| 2038 | 347 | 694  | 177 | 390 | 464 | 416 | 416 | 416 | 372 | 416 | 676  |
| 2039 | 358 | 704  | 177 | 412 | 467 | 418 | 428 | 418 | 374 | 418 | 686  |
| 2040 | 372 | 724  | 181 | 424 | 467 | 428 | 438 | 428 | 384 | 428 | 706  |
| 2041 | 389 | 745  | 191 | 437 | 467 | 439 | 457 | 439 | 395 | 439 | 719  |
| 2042 | 394 | 765  | 196 | 439 | 489 | 452 | 468 | 459 | 415 | 459 | 747  |
| 2043 | 398 | 785  | 196 | 439 | 504 | 464 | 468 | 468 | 424 | 468 | 747  |
| 2044 | 428 | 795  | 196 | 443 | 508 | 464 | 468 | 468 | 424 | 468 | 757  |
| 2045 | 454 | 797  | 196 | 443 | 511 | 465 | 468 | 468 | 424 | 468 | 765  |
| 2046 | 566 | 797  | 196 | 451 | 536 | 465 | 472 | 468 | 424 | 468 | 775  |
| 2047 | 628 | 797  | 196 | 451 | 681 | 468 | 478 | 468 | 424 | 468 | 987  |
| 2048 | 697 | 797  | 196 | 451 | 756 | 468 | 527 | 468 | 424 | 468 | 1178 |
| 2049 | 752 | 1012 | 280 | 451 | 785 | 628 | 680 | 636 | 592 | 636 | 1302 |
| 2050 | 792 | 1201 | 305 | 451 | 804 | 737 | 754 | 743 | 699 | 743 | 1362 |
| 2051 | 811 | 1322 | 311 | 603 | 810 | 776 | 793 | 776 | 732 | 776 | 1399 |
| 2052 | 814 | 1380 | 313 | 702 | 810 | 805 | 814 | 805 | 761 | 805 | 1420 |
| 2053 | 814 | 1417 | 313 | 753 | 810 | 814 | 814 | 814 | 770 | 814 | 1431 |
| 2054 | 814 | 1438 | 313 | 779 | 810 | 814 | 814 | 814 | 770 | 814 | 1431 |
| 2055 | 814 | 1449 | 313 | 805 | 810 | 814 | 814 | 814 | 770 | 814 | 1431 |
| 2056 | 814 | 1449 | 313 | 814 | 810 | 814 | 814 | 814 | 770 | 814 | 1431 |
| 2057 | 814 | 1449 | 313 | 814 | 810 | 814 | 814 | 814 | 770 | 814 | 1431 |
| 2058 | 814 | 1449 | 313 | 814 | 810 | 814 | 814 | 814 | 770 | 814 | 1431 |
| 2059 | 814 | 1449 | 313 | 814 | 810 | 814 | 814 | 814 | 770 | 814 | 1431 |

|      | 144 | 145  | 146 | 147 | 148 | 149 | 150 | 151 | 152 | 153 | 154  |
|------|-----|------|-----|-----|-----|-----|-----|-----|-----|-----|------|
| 2060 | 814 | 1449 | 313 | 814 | 810 | 814 | 814 | 814 | 770 | 814 | 1431 |
| 2061 | 814 | 1449 | 313 | 814 | 810 | 814 | 814 | 814 | 770 | 814 | 1431 |
| 2062 | 814 | 1449 | 313 | 814 | 810 | 814 | 814 | 814 | 770 | 814 | 1431 |
| 2063 | 814 | 1449 | 313 | 814 | 810 | 814 | 814 | 814 | 770 | 814 | 1431 |
| 2064 | 814 | 1449 | 313 | 814 | 810 | 814 | 814 | 814 | 770 | 814 | 1431 |
| 2065 | 814 | 1449 | 313 | 814 | 810 | 814 | 814 | 814 | 770 | 814 | 1431 |
| 2066 | 814 | 1449 | 313 | 814 | 810 | 814 | 814 | 814 | 770 | 814 | 1431 |
| 2067 | 814 | 1449 | 313 | 814 | 810 | 814 | 814 | 814 | 770 | 814 | 1431 |
| 2068 | 814 | 1449 | 313 | 814 | 810 | 814 | 814 | 814 | 770 | 814 | 1431 |
| 2069 | 814 | 1449 | 313 | 814 | 810 | 814 | 814 | 814 | 770 | 814 | 1431 |
| 2070 | 814 | 1449 | 313 | 814 | 810 | 814 | 814 | 814 | 770 | 814 | 1431 |
| 2071 | 814 | 1449 | 313 | 814 | 810 | 814 | 814 | 814 | 770 | 814 | 1431 |
| 2072 | 814 | 1449 | 313 | 814 | 810 | 814 | 814 | 814 | 770 | 814 | 1431 |
| 2073 | 814 | 1449 | 313 | 814 | 810 | 814 | 814 | 814 | 770 | 814 | 1431 |
| 2074 | 814 | 1449 | 313 | 814 | 810 | 814 | 814 | 814 | 770 | 814 | 1431 |
| 2075 | 814 | 1449 | 313 | 814 | 810 | 814 | 814 | 814 | 770 | 814 | 1431 |
| 2076 | 814 | 1449 | 313 | 814 | 810 | 814 | 814 | 814 | 770 | 814 | 1431 |
| 2077 | 814 | 1449 | 313 | 814 | 810 | 814 | 814 | 814 | 770 | 814 | 1431 |
| 2078 | 814 | 1449 | 313 | 814 | 810 | 814 | 814 | 814 | 770 | 814 | 1431 |
| 2079 | 814 | 1449 | 313 | 814 | 810 | 814 | 814 | 814 | 770 | 814 | 1431 |
| 2080 | 814 | 1449 | 313 | 814 | 810 | 814 | 814 | 814 | 770 | 814 | 1431 |
| 2081 | 814 | 1449 | 313 | 814 | 810 | 814 | 814 | 814 | 770 | 814 | 1431 |
| 2082 | 814 | 1449 | 313 | 814 | 810 | 814 | 814 | 814 | 770 | 814 | 1431 |
| 2083 | 814 | 1449 | 313 | 814 | 810 | 814 | 814 | 814 | 770 | 814 | 1431 |
| 2084 | 814 | 1449 | 313 | 814 | 810 | 814 | 814 | 814 | 770 | 814 | 1431 |
| 2085 | 814 | 1449 | 313 | 814 | 810 | 814 | 814 | 814 | 770 | 814 | 1431 |
| 2086 | 814 | 1449 | 313 | 814 | 810 | 814 | 814 | 814 | 770 | 814 | 1431 |
| 2087 | 814 | 1449 | 313 | 814 | 810 | 814 | 814 | 814 | 770 | 814 | 1431 |
| 2088 | 814 | 1449 | 313 | 814 | 810 | 814 | 814 | 814 | 770 | 814 | 1431 |
| 2089 | 814 | 1449 | 313 | 814 | 810 | 814 | 814 | 814 | 770 | 814 | 1431 |
| 2090 | 814 | 1449 | 313 | 814 | 810 | 814 | 814 | 814 | 770 | 814 | 1431 |

|      | 155 | 156 | 157 | 158 | 159 | 160 | 161 | 162 |
|------|-----|-----|-----|-----|-----|-----|-----|-----|
| 2002 | 0   | 0   | 0   | 0   | 0   | 0   | 0   | 0   |
| 2003 | 0   | 0   | 0   | 0   | 0   | 0   | 0   | 0   |
| 2004 | 0   | 0   | 0   | 0   | 0   | 0   | 0   | 0   |
| 2005 | 0   | 0   | 0   | 0   | 0   | 0   | 0   | 0   |
| 2006 | 0   | 0   | 0   | 0   | 0   | 0   | 0   | 0   |
| 2007 | 0   | 0   | 0   | 0   | 0   | 0   | 0   | 0   |
| 2008 | 0   | 0   | 0   | 0   | 0   | 0   | 0   | 0   |
| 2009 | 0   | 0   | 0   | 0   | 0   | 0   | 0   | 0   |
| 2010 | 0   | 0   | 0   | 0   | 0   | 0   | 0   | 0   |
| 2011 | 0   | 0   | 0   | 0   | 0   | 0   | 0   | 0   |
| 2012 | 0   | 0   | 0   | 0   | 0   | 0   | 0   | 0   |
| 2013 | 0   | 0   | 0   | 0   | 0   | 0   | 0   | 0   |
| 2014 | 0   | 0   | 0   | 0   | 0   | 0   | 0   | 0   |
| 2015 | 0   | 0   | 0   | 0   | 0   | 0   | 0   | 0   |
| 2016 | 0   | 0   | 0   | 0   | 0   | 0   | 0   | 0   |
| 2017 | 0   | 0   | 0   | 0   | 0   | 0   | 0   | 0   |
| 2018 | 0   | 0   | 0   | 0   | 0   | 0   | 0   | 0   |
| 2019 | 0   | 0   | 0   | 0   | 0   | 0   | 0   | 0   |
| 2020 | 0   | 0   | 0   | 0   | 0   | 0   | 0   | 0   |
| 2021 | 0   | 0   | 113 | 0   | 0   | 0   | 0   | 0   |
| 2022 | 0   | 0   | 190 | 0   | 0   | 0   | 0   | 0   |
| 2023 | 0   | 0   | 241 | 0   | 0   | 0   | 0   | 0   |
| 2024 | 0   | 0   | 277 | 0   | 0   | 0   | 0   | 0   |
| 2025 | 0   | 0   | 293 | 0   | 0   | 0   | 0   | 0   |
| 2026 | 54  | 0   | 305 | 107 | 109 | 110 | 53  | 107 |
| 2027 | 109 | 0   | 322 | 209 | 202 | 204 | 110 | 201 |
| 2028 | 127 | 0   | 338 | 261 | 254 | 256 | 137 | 253 |
| 2029 | 140 | 0   | 358 | 284 | 276 | 278 | 157 | 275 |
| 2030 | 154 | 0   | 378 | 317 | 310 | 312 | 187 | 309 |
| 2031 | 163 | 91  | 388 | 338 | 331 | 333 | 208 | 330 |
| 2032 | 163 | 207 | 391 | 350 | 350 | 352 | 227 | 349 |
| 2033 | 163 | 270 | 395 | 379 | 375 | 370 | 245 | 367 |
| 2034 | 173 | 303 | 415 | 397 | 390 | 390 | 265 | 387 |
| 2035 | 173 | 323 | 428 | 397 | 390 | 390 | 265 | 387 |
| 2036 | 173 | 340 | 438 | 401 | 394 | 396 | 271 | 393 |
| 2037 | 177 | 360 | 446 | 411 | 404 | 406 | 281 | 403 |
| 2038 | 177 | 390 | 446 | 421 | 414 | 416 | 291 | 413 |
| 2039 | 177 | 412 | 446 | 423 | 416 | 418 | 293 | 415 |
| 2040 | 181 | 424 | 446 | 433 | 426 | 428 | 303 | 425 |
| 2041 | 191 | 437 | 446 | 445 | 437 | 438 | 313 | 435 |
| 2042 | 196 | 439 | 468 | 456 | 457 | 459 | 334 | 456 |
| 2043 | 196 | 439 | 488 | 456 | 466 | 459 | 334 | 456 |
| 2044 | 196 | 439 | 518 | 463 | 466 | 461 | 336 | 458 |
| 2045 | 196 | 444 | 671 | 463 | 478 | 461 | 336 | 458 |
| 2046 | 196 | 451 | 748 | 463 | 507 | 476 | 351 | 473 |
| 2047 | 196 | 451 | 776 | 463 | 527 | 627 | 502 | 624 |
| 2048 | 284 | 451 | 786 | 633 | 673 | 733 | 608 | 730 |
| 2049 | 305 | 451 | 792 | 738 | 750 | 776 | 651 | 773 |
| 2050 | 310 | 603 | 792 | 779 | 789 | 805 | 680 | 802 |
| 2051 | 313 | 701 | 792 | 803 | 811 | 814 | 689 | 811 |
| 2052 | 313 | 763 | 792 | 809 | 812 | 814 | 689 | 811 |
| 2053 | 313 | 795 | 792 | 809 | 812 | 814 | 689 | 811 |
| 2054 | 313 | 801 | 792 | 809 | 812 | 814 | 689 | 811 |
| 2055 | 313 | 811 | 792 | 809 | 812 | 814 | 689 | 811 |
| 2056 | 313 | 814 | 792 | 809 | 812 | 814 | 689 | 811 |
| 2057 | 313 | 814 | 792 | 809 | 812 | 814 | 689 | 811 |
| 2058 | 313 | 814 | 792 | 809 | 812 | 814 | 689 | 811 |
| 2059 | 313 | 814 | 792 | 809 | 812 | 814 | 689 | 811 |

|      | 155 | 156 | 157 | 158 | 159 | 160 | 161 | 162 |
|------|-----|-----|-----|-----|-----|-----|-----|-----|
| 2060 | 313 | 814 | 792 | 809 | 812 | 814 | 689 | 811 |
| 2061 | 313 | 814 | 792 | 809 | 812 | 814 | 689 | 811 |
| 2062 | 313 | 814 | 792 | 809 | 812 | 814 | 689 | 811 |
| 2063 | 313 | 814 | 792 | 809 | 812 | 814 | 689 | 811 |
| 2064 | 313 | 814 | 792 | 809 | 812 | 814 | 689 | 811 |
| 2065 | 313 | 814 | 792 | 809 | 812 | 814 | 689 | 811 |
| 2066 | 313 | 814 | 792 | 809 | 812 | 814 | 689 | 811 |
| 2067 | 313 | 814 | 792 | 809 | 812 | 814 | 689 | 811 |
| 2068 | 313 | 814 | 792 | 809 | 812 | 814 | 689 | 811 |
| 2069 | 313 | 814 | 792 | 809 | 812 | 814 | 689 | 811 |
| 2070 | 313 | 814 | 792 | 809 | 812 | 814 | 689 | 811 |
| 2071 | 313 | 814 | 792 | 809 | 812 | 814 | 689 | 811 |
| 2072 | 313 | 814 | 792 | 809 | 812 | 814 | 689 | 811 |
| 2073 | 313 | 814 | 792 | 809 | 812 | 814 | 689 | 811 |
| 2074 | 313 | 814 | 792 | 809 | 812 | 814 | 689 | 811 |
| 2075 | 313 | 814 | 792 | 809 | 812 | 814 | 689 | 811 |
| 2076 | 313 | 814 | 792 | 809 | 812 | 814 | 689 | 811 |
| 2077 | 313 | 814 | 792 | 809 | 812 | 814 | 689 | 811 |
| 2078 | 313 | 814 | 792 | 809 | 812 | 814 | 689 | 811 |
| 2079 | 313 | 814 | 792 | 809 | 812 | 814 | 689 | 811 |
| 2080 | 313 | 814 | 792 | 809 | 812 | 814 | 689 | 811 |
| 2081 | 313 | 814 | 792 | 809 | 812 | 814 | 689 | 811 |
| 2082 | 313 | 814 | 792 | 809 | 812 | 814 | 689 | 811 |
| 2083 | 313 | 814 | 792 | 809 | 812 | 814 | 689 | 811 |
| 2084 | 313 | 814 | 792 | 809 | 812 | 814 | 689 | 811 |
| 2085 | 313 | 814 | 792 | 809 | 812 | 814 | 689 | 811 |
| 2086 | 313 | 814 | 792 | 809 | 812 | 814 | 689 | 811 |
| 2087 | 313 | 814 | 792 | 809 | 812 | 814 | 689 | 811 |
| 2088 | 313 | 814 | 792 | 809 | 812 | 814 | 689 | 811 |
| 2089 | 313 | 814 | 792 | 809 | 812 | 814 | 689 | 811 |
| 2090 | 313 | 814 | 792 | 809 | 812 | 814 | 689 | 811 |



|      | 1    | 2    | 3    | 4    | 5    | 6    | 7    | 8    | 9    | 10   | 11   | 12   |
|------|------|------|------|------|------|------|------|------|------|------|------|------|
| 2002 | 0    | 0    | 0    | 0    | 0    | 0    | 0    | 0    | 0    | 0    | 0    | 0    |
| 2003 | 0    | 0    | 0    | 0    | 0    | 0    | 0    | 0    | 0    | 0    | 0    | 0    |
| 2004 | 0    | 0    | 0    | 0    | 0    | 0    | 0    | 0    | 0    | 0    | 0    | 0    |
| 2005 | 0    | 0    | 0    | 0    | 0    | 0    | 0    | 0    | 0    | 0    | 0    | 0    |
| 2006 | 0    | 0    | 0    | 0    | 0    | 0    | 0    | 0    | 0    | 0    | 0    | 0    |
| 2007 | 0    | 0    | 0    | 0    | 0    | 0    | 0    | 0    | 0    | 0    | 0    | 0    |
| 2008 | 0    | 0    | 0    | 0    | 0    | 0    | 0    | 0    | 0    | 0    | 0    | 0    |
| 2009 | 0    | 0    | 0    | 0    | 0    | 0    | 0    | 0    | 0    | 0    | 0    | 0    |
| 2010 | 0    | 0    | 0    | 0    | 0    | 0    | 0    | 0    | 0    | 0    | 0    | 0    |
| 2011 | 0    | 0    | 0    | 0    | 0    | 0    | 0    | 0    | 0    | 0    | 0    | 0    |
| 2012 | 0    | 0    | 0    | 0    | 0    | 0    | 0    | 0    | 0    | 0    | 0    | 0    |
| 2013 | 0    | 0    | 0    | 0    | 0    | 0    | 0    | 0    | 0    | 0    | 0    | 0    |
| 2014 | 0    | 0    | 0    | 0    | 0    | 0    | 0    | 0    | 0    | 0    | 0    | 0    |
| 2015 | 0    | 0    | 0    | 0    | 0    | 0    | 0    | 0    | 0    | 0    | 0    | 0    |
| 2016 | 0    | 0    | 0    | 0    | 0    | 0    | 0    | 0    | 0    | 0    | 0    | 0    |
| 2017 | 0    | 0    | 0    | 0    | 0    | 0    | 0    | 0    | 0    | 0    | 0    | 0    |
| 2018 | 0    | 0    | 0    | 0    | 0    | 0    | 0    | 0    | 0    | 0    | 0    | 0    |
| 2019 | 0    | 0    | 0    | 0    | 0    | 0    | 0    | 0    | 0    | 0    | 0    | 0    |
| 2020 | 0    | 0    | 0    | 254  | 0    | 0    | 0    | 0    | 0    | 0    | 0    | 0    |
| 2021 | 0    | 0    | 0    | 506  | 0    | 0    | 0    | 0    | 0    | 0    | 0    | 0    |
| 2022 | 0    | 0    | 0    | 760  | 0    | 0    | 0    | 0    | 0    | 0    | 0    | 0    |
| 2023 | 0    | 0    | 0    | 1017 | 0    | 0    | 0    | 0    | 0    | 0    | 0    | 0    |
| 2024 | 0    | 0    | 0    | 1268 | 0    | 0    | 0    | 0    | 0    | 0    | 0    | 0    |
| 2025 | 256  | 256  | 0    | 1537 | 256  | 256  | 256  | 256  | 256  | 71   | 71   | 0    |
| 2026 | 506  | 506  | 0    | 1793 | 506  | 506  | 506  | 506  | 506  | 160  | 167  | 0    |
| 2027 | 757  | 757  | 0    | 2050 | 757  | 757  | 757  | 757  | 757  | 246  | 258  | 0    |
| 2028 | 1011 | 1011 | 0    | 2306 | 1011 | 1011 | 1011 | 1011 | 1011 | 357  | 373  | 0    |
| 2029 | 1261 | 1261 | 0    | 2592 | 1261 | 1261 | 1261 | 1261 | 1261 | 471  | 492  | 0    |
| 2030 | 1513 | 1513 | 256  | 2874 | 1513 | 1513 | 1513 | 1513 | 1513 | 610  | 644  | 66   |
| 2031 | 1771 | 1771 | 509  | 3142 | 1771 | 1775 | 1771 | 1771 | 1771 | 774  | 824  | 169  |
| 2032 | 2027 | 2027 | 759  | 3442 | 2027 | 2054 | 2027 | 2020 | 2027 | 941  | 1014 | 285  |
| 2033 | 2289 | 2292 | 1016 | 3759 | 2277 | 2333 | 2292 | 2280 | 2292 | 1119 | 1202 | 425  |
| 2034 | 2553 | 2556 | 1271 | 4016 | 2536 | 2606 | 2556 | 2505 | 2556 | 1287 | 1372 | 570  |
| 2035 | 2830 | 2833 | 1523 | 4336 | 2803 | 2880 | 2833 | 2720 | 2833 | 1457 | 1561 | 740  |
| 2036 | 3141 | 3145 | 1790 | 4592 | 3086 | 3147 | 3146 | 2928 | 3145 | 1607 | 1750 | 904  |
| 2037 | 3439 | 3450 | 2052 | 4788 | 3361 | 3442 | 3453 | 3159 | 3450 | 1736 | 1930 | 1075 |
| 2038 | 3763 | 3779 | 2314 | 5016 | 3701 | 3749 | 3787 | 3376 | 3779 | 1866 | 2083 | 1276 |
| 2039 | 4007 | 4048 | 2577 | 5258 | 3979 | 4015 | 4067 | 3553 | 4043 | 1986 | 2215 | 1463 |
| 2040 | 4318 | 4375 | 2858 | 5497 | 4306 | 4329 | 4401 | 3795 | 4364 | 2162 | 2409 | 1623 |
| 2041 | 4552 | 4619 | 3141 | 5652 | 4556 | 4565 | 4673 | 3945 | 4596 | 2318 | 2582 | 1793 |
| 2042 | 4809 | 4938 | 3464 | 5751 | 4899 | 4878 | 5016 | 4169 | 4908 | 2497 | 2767 | 2004 |
| 2043 | 4961 | 5058 | 3780 | 5886 | 4939 | 5024 | 5147 | 4278 | 5037 | 2658 | 2945 | 2202 |
| 2044 | 5093 | 5238 | 4040 | 5971 | 5107 | 5184 | 5309 | 4440 | 5199 | 2802 | 3108 | 2387 |
| 2045 | 5235 | 5459 | 4157 | 6041 | 5299 | 5391 | 5507 | 4638 | 5397 | 2903 | 3249 | 2566 |
| 2046 | 5341 | 5648 | 4360 | 6100 | 5484 | 5542 | 5690 | 4821 | 5580 | 3005 | 3375 | 2722 |
| 2047 | 5413 | 5852 | 4598 | 6109 | 5640 | 5700 | 5866 | 4997 | 5756 | 3090 | 3480 | 2827 |
| 2048 | 5459 | 6021 | 4802 | 6109 | 5764 | 5816 | 5975 | 5106 | 5865 | 3126 | 3542 | 2975 |
| 2049 | 5543 | 6159 | 4989 | 6109 | 5865 | 5895 | 6070 | 5201 | 5960 | 3173 | 3604 | 3178 |
| 2050 | 5659 | 6324 | 5166 | 6109 | 6000 | 6039 | 6206 | 5337 | 6096 | 3337 | 3815 | 3362 |
| 2051 | 5695 | 6493 | 5348 | 6109 | 6159 | 6201 | 6354 | 5485 | 6244 | 3449 | 3989 | 3488 |
| 2052 | 5695 | 6646 | 5491 | 6109 | 6274 | 6275 | 6420 | 5551 | 6310 | 3547 | 4159 | 3650 |
| 2053 | 5695 | 6747 | 5604 | 6109 | 6293 | 6292 | 6437 | 5568 | 6327 | 3620 | 4376 | 3843 |
| 2054 | 5695 | 6811 | 5766 | 6109 | 6293 | 6292 | 6437 | 5568 | 6327 | 3661 | 4572 | 4001 |
| 2055 | 5695 | 6823 | 5928 | 6109 | 6293 | 6292 | 6437 | 5568 | 6327 | 3661 | 4688 | 4189 |
| 2056 | 5695 | 6823 | 6127 | 6109 | 6293 | 6292 | 6437 | 5568 | 6327 | 3661 | 4751 | 4363 |
| 2057 | 5695 | 6823 | 6261 | 6109 | 6293 | 6292 | 6437 | 5568 | 6327 | 3661 | 4793 | 4502 |
| 2058 | 5695 | 6823 | 6337 | 6109 | 6293 | 6292 | 6437 | 5568 | 6327 | 3661 | 4813 | 4599 |
| 2059 | 5695 | 6823 | 6383 | 6109 | 6293 | 6292 | 6437 | 5568 | 6327 | 3661 | 4813 | 4655 |

|      | 1    | 2    | 3    | 4    | 5    | 6    | 7    | 8    | 9    | 10   | 11   | 12   |
|------|------|------|------|------|------|------|------|------|------|------|------|------|
| 2060 | 5695 | 6823 | 6400 | 6109 | 6293 | 6292 | 6437 | 5568 | 6327 | 3661 | 4813 | 4696 |
| 2061 | 5695 | 6823 | 6400 | 6109 | 6293 | 6292 | 6437 | 5568 | 6327 | 3661 | 4813 | 4714 |
| 2062 | 5695 | 6823 | 6400 | 6109 | 6293 | 6292 | 6437 | 5568 | 6327 | 3661 | 4813 | 4723 |
| 2063 | 5695 | 6823 | 6400 | 6109 | 6293 | 6292 | 6437 | 5568 | 6327 | 3661 | 4813 | 4723 |
| 2064 | 5695 | 6823 | 6400 | 6109 | 6293 | 6292 | 6437 | 5568 | 6327 | 3661 | 4813 | 4723 |
| 2065 | 5695 | 6823 | 6400 | 6109 | 6293 | 6292 | 6437 | 5568 | 6327 | 3661 | 4813 | 4723 |
| 2066 | 5695 | 6823 | 6400 | 6109 | 6293 | 6292 | 6437 | 5568 | 6327 | 3661 | 4813 | 4723 |
| 2067 | 5695 | 6823 | 6400 | 6109 | 6293 | 6292 | 6437 | 5568 | 6327 | 3661 | 4813 | 4723 |
| 2068 | 5695 | 6823 | 6400 | 6109 | 6293 | 6292 | 6437 | 5568 | 6327 | 3661 | 4813 | 4723 |
| 2069 | 5695 | 6823 | 6400 | 6109 | 6293 | 6292 | 6437 | 5568 | 6327 | 3661 | 4813 | 4723 |
| 2070 | 5695 | 6823 | 6400 | 6109 | 6293 | 6292 | 6437 | 5568 | 6327 | 3661 | 4813 | 4723 |
| 2071 | 5695 | 6823 | 6400 | 6109 | 6293 | 6292 | 6437 | 5568 | 6327 | 3661 | 4813 | 4723 |
| 2072 | 5695 | 6823 | 6400 | 6109 | 6293 | 6292 | 6437 | 5568 | 6327 | 3661 | 4813 | 4723 |
| 2073 | 5695 | 6823 | 6400 | 6109 | 6293 | 6292 | 6437 | 5568 | 6327 | 3661 | 4813 | 4723 |
| 2074 | 5695 | 6823 | 6400 | 6109 | 6293 | 6292 | 6437 | 5568 | 6327 | 3661 | 4813 | 4723 |
| 2075 | 5695 | 6823 | 6400 | 6109 | 6293 | 6292 | 6437 | 5568 | 6327 | 3661 | 4813 | 4723 |
| 2076 | 5695 | 6823 | 6400 | 6109 | 6293 | 6292 | 6437 | 5568 | 6327 | 3661 | 4813 | 4723 |
| 2077 | 5695 | 6823 | 6400 | 6109 | 6293 | 6292 | 6437 | 5568 | 6327 | 3661 | 4813 | 4723 |
| 2078 | 5695 | 6823 | 6400 | 6109 | 6293 | 6292 | 6437 | 5568 | 6327 | 3661 | 4813 | 4723 |
| 2079 | 5695 | 6823 | 6400 | 6109 | 6293 | 6292 | 6437 | 5568 | 6327 | 3661 | 4813 | 4723 |
| 2080 | 5695 | 6823 | 6400 | 6109 | 6293 | 6292 | 6437 | 5568 | 6327 | 3661 | 4813 | 4723 |
| 2081 | 5695 | 6823 | 6400 | 6109 | 6293 | 6292 | 6437 | 5568 | 6327 | 3661 | 4813 | 4723 |
| 2082 | 5695 | 6823 | 6400 | 6109 | 6293 | 6292 | 6437 | 5568 | 6327 | 3661 | 4813 | 4723 |
| 2083 | 5695 | 6823 | 6400 | 6109 | 6293 | 6292 | 6437 | 5568 | 6327 | 3661 | 4813 | 4723 |
| 2084 | 5695 | 6823 | 6400 | 6109 | 6293 | 6292 | 6437 | 5568 | 6327 | 3661 | 4813 | 4723 |
| 2085 | 5695 | 6823 | 6400 | 6109 | 6293 | 6292 | 6437 | 5568 | 6327 | 3661 | 4813 | 4723 |
| 2086 | 5695 | 6823 | 6400 | 6109 | 6293 | 6292 | 6437 | 5568 | 6327 | 3661 | 4813 | 4723 |
| 2087 | 5695 | 6823 | 6400 | 6109 | 6293 | 6292 | 6437 | 5568 | 6327 | 3661 | 4813 | 4723 |
| 2088 | 5695 | 6823 | 6400 | 6109 | 6293 | 6292 | 6437 | 5568 | 6327 | 3661 | 4813 | 4723 |
| 2089 | 5695 | 6823 | 6400 | 6109 | 6293 | 6292 | 6437 | 5568 | 6327 | 3661 | 4813 | 4723 |
| 2090 | 5695 | 6823 | 6400 | 6109 | 6293 | 6292 | 6437 | 5568 | 6327 | 3661 | 4813 | 4723 |

|      | 13   | 14   | 15   | 16   | 17   | 18   | 19   | 20   | 21   | 22   | 23   | 24   |
|------|------|------|------|------|------|------|------|------|------|------|------|------|
| 2002 | 0    | 0    | 0    | 0    | 0    | 0    | 0    | 0    | 0    | 0    | 0    | 0    |
| 2003 | 0    | 0    | 0    | 0    | 0    | 0    | 0    | 0    | 0    | 0    | 0    | 0    |
| 2004 | 0    | 0    | 0    | 0    | 0    | 0    | 0    | 0    | 0    | 0    | 0    | 0    |
| 2005 | 0    | 0    | 0    | 0    | 0    | 0    | 0    | 0    | 0    | 0    | 0    | 0    |
| 2006 | 0    | 0    | 0    | 0    | 0    | 0    | 0    | 0    | 0    | 0    | 0    | 0    |
| 2007 | 0    | 0    | 0    | 0    | 0    | 0    | 0    | 0    | 0    | 0    | 0    | 0    |
| 2008 | 0    | 0    | 0    | 0    | 0    | 0    | 0    | 0    | 0    | 0    | 0    | 0    |
| 2009 | 0    | 0    | 0    | 0    | 0    | 0    | 0    | 0    | 0    | 0    | 0    | 0    |
| 2010 | 0    | 0    | 0    | 0    | 0    | 0    | 0    | 0    | 0    | 0    | 0    | 0    |
| 2011 | 0    | 0    | 0    | 0    | 0    | 0    | 0    | 0    | 0    | 0    | 0    | 0    |
| 2012 | 0    | 0    | 0    | 0    | 0    | 0    | 0    | 0    | 0    | 0    | 0    | 0    |
| 2013 | 0    | 0    | 0    | 0    | 0    | 0    | 0    | 0    | 0    | 0    | 0    | 0    |
| 2014 | 0    | 0    | 0    | 0    | 0    | 0    | 0    | 0    | 0    | 0    | 0    | 0    |
| 2015 | 0    | 0    | 0    | 0    | 0    | 0    | 0    | 0    | 0    | 0    | 0    | 0    |
| 2016 | 0    | 0    | 0    | 0    | 0    | 0    | 0    | 0    | 0    | 0    | 0    | 0    |
| 2017 | 0    | 0    | 0    | 0    | 0    | 0    | 0    | 0    | 0    | 0    | 0    | 0    |
| 2018 | 0    | 0    | 0    | 0    | 0    | 0    | 0    | 0    | 0    | 0    | 0    | 0    |
| 2019 | 0    | 0    | 0    | 0    | 0    | 0    | 0    | 0    | 0    | 0    | 0    | 0    |
| 2020 | 90   | 0    | 0    | 0    | 0    | 0    | 0    | 0    | 0    | 10   | 0    | 0    |
| 2021 | 181  | 0    | 0    | 0    | 0    | 0    | 0    | 0    | 0    | 26   | 0    | 0    |
| 2022 | 287  | 0    | 0    | 0    | 0    | 0    | 0    | 0    | 0    | 48   | 0    | 0    |
| 2023 | 403  | 0    | 0    | 0    | 0    | 0    | 0    | 0    | 0    | 95   | 0    | 0    |
| 2024 | 562  | 0    | 0    | 0    | 0    | 0    | 0    | 0    | 0    | 134  | 0    | 0    |
| 2025 | 689  | 64   | 174  | 244  | 4    | 71   | 17   | 17   | 0    | 185  | 12   | 63   |
| 2026 | 830  | 151  | 345  | 488  | 27   | 165  | 52   | 54   | 0    | 235  | 25   | 177  |
| 2027 | 992  | 251  | 516  | 742  | 36   | 251  | 79   | 86   | 0    | 286  | 35   | 261  |
| 2028 | 1187 | 381  | 680  | 984  | 64   | 370  | 115  | 128  | 0    | 340  | 60   | 393  |
| 2029 | 1388 | 505  | 838  | 1239 | 117  | 494  | 182  | 200  | 0    | 412  | 96   | 535  |
| 2030 | 1564 | 672  | 1009 | 1504 | 159  | 648  | 252  | 282  | 10   | 503  | 143  | 647  |
| 2031 | 1741 | 822  | 1168 | 1746 | 207  | 821  | 310  | 356  | 46   | 594  | 185  | 784  |
| 2032 | 1947 | 988  | 1336 | 1991 | 271  | 999  | 368  | 428  | 99   | 700  | 239  | 916  |
| 2033 | 2095 | 1172 | 1483 | 2233 | 352  | 1177 | 443  | 516  | 160  | 788  | 298  | 1018 |
| 2034 | 2256 | 1345 | 1655 | 2491 | 432  | 1345 | 528  | 609  | 238  | 884  | 361  | 1165 |
| 2035 | 2414 | 1510 | 1809 | 2750 | 503  | 1534 | 615  | 705  | 319  | 967  | 414  | 1320 |
| 2036 | 2543 | 1683 | 1971 | 2977 | 597  | 1711 | 708  | 811  | 393  | 1057 | 478  | 1461 |
| 2037 | 2690 | 1830 | 2148 | 3179 | 678  | 1867 | 799  | 926  | 501  | 1135 | 560  | 1592 |
| 2038 | 2838 | 1962 | 2300 | 3355 | 723  | 2004 | 905  | 1062 | 599  | 1205 | 641  | 1692 |
| 2039 | 2975 | 2093 | 2474 | 3536 | 769  | 2136 | 985  | 1179 | 713  | 1284 | 717  | 1793 |
| 2040 | 3086 | 2230 | 2625 | 3760 | 819  | 2316 | 1055 | 1274 | 843  | 1363 | 770  | 1931 |
| 2041 | 3200 | 2401 | 2782 | 3970 | 888  | 2474 | 1124 | 1364 | 956  | 1459 | 831  | 2071 |
| 2042 | 3310 | 2568 | 2989 | 4187 | 986  | 2658 | 1206 | 1462 | 1058 | 1579 | 877  | 2275 |
| 2043 | 3400 | 2724 | 3147 | 4382 | 1081 | 2825 | 1288 | 1573 | 1181 | 1683 | 945  | 2419 |
| 2044 | 3492 | 2880 | 3269 | 4552 | 1167 | 2977 | 1368 | 1665 | 1294 | 1726 | 1008 | 2578 |
| 2045 | 3548 | 3029 | 3406 | 4708 | 1262 | 3107 | 1469 | 1775 | 1392 | 1833 | 1063 | 2735 |
| 2046 | 3588 | 3163 | 3537 | 4841 | 1323 | 3222 | 1535 | 1862 | 1497 | 2001 | 1103 | 2883 |
| 2047 | 3609 | 3247 | 3710 | 4977 | 1371 | 3326 | 1649 | 2003 | 1520 | 2086 | 1253 | 3012 |
| 2048 | 3619 | 3351 | 3755 | 5049 | 1410 | 3376 | 1764 | 2186 | 1666 | 2097 | 1430 | 3213 |
| 2049 | 3846 | 3483 | 3869 | 5101 | 1462 | 3428 | 1878 | 2362 | 1880 | 2097 | 1525 | 3402 |
| 2050 | 3925 | 3578 | 4089 | 5292 | 1653 | 3619 | 1972 | 2531 | 2063 | 2097 | 1682 | 3589 |
| 2051 | 3932 | 3762 | 4285 | 5465 | 1826 | 3792 | 2066 | 2740 | 2165 | 2097 | 1858 | 3723 |
| 2052 | 3932 | 3952 | 4435 | 5646 | 2007 | 3973 | 2125 | 2961 | 2342 | 2097 | 2023 | 3791 |
| 2053 | 3932 | 4119 | 4561 | 5796 | 2157 | 4123 | 2141 | 3114 | 2519 | 2097 | 2151 | 3818 |
| 2054 | 3932 | 4221 | 4612 | 5921 | 2282 | 4248 | 2141 | 3198 | 2686 | 2097 | 2248 | 3819 |
| 2055 | 3932 | 4268 | 4618 | 5965 | 2326 | 4292 | 2141 | 3255 | 2880 | 2097 | 2268 | 3819 |
| 2056 | 3932 | 4277 | 4618 | 5975 | 2336 | 4302 | 2141 | 3292 | 3069 | 2097 | 2268 | 3819 |
| 2057 | 3932 | 4277 | 4618 | 5975 | 2336 | 4302 | 2141 | 3299 | 3240 | 2097 | 2268 | 3819 |
| 2058 | 3932 | 4277 | 4618 | 5975 | 2336 | 4302 | 2141 | 3299 | 3376 | 2097 | 2268 | 3819 |
| 2059 | 3932 | 4277 | 4618 | 5975 | 2336 | 4302 | 2141 | 3299 | 3443 | 2097 | 2268 | 3819 |

|      | 13   | 14   | 15   | 16   | 17   | 18   | 19   | 20   | 21   | 22   | 23   | 24   |
|------|------|------|------|------|------|------|------|------|------|------|------|------|
| 2060 | 3932 | 4277 | 4618 | 5975 | 2336 | 4302 | 2141 | 3299 | 3484 | 2097 | 2268 | 3819 |
| 2061 | 3932 | 4277 | 4618 | 5975 | 2336 | 4302 | 2141 | 3299 | 3508 | 2097 | 2268 | 3819 |
| 2062 | 3932 | 4277 | 4618 | 5975 | 2336 | 4302 | 2141 | 3299 | 3513 | 2097 | 2268 | 3819 |
| 2063 | 3932 | 4277 | 4618 | 5975 | 2336 | 4302 | 2141 | 3299 | 3513 | 2097 | 2268 | 3819 |
| 2064 | 3932 | 4277 | 4618 | 5975 | 2336 | 4302 | 2141 | 3299 | 3513 | 2097 | 2268 | 3819 |
| 2065 | 3932 | 4277 | 4618 | 5975 | 2336 | 4302 | 2141 | 3299 | 3513 | 2097 | 2268 | 3819 |
| 2066 | 3932 | 4277 | 4618 | 5975 | 2336 | 4302 | 2141 | 3299 | 3513 | 2097 | 2268 | 3819 |
| 2067 | 3932 | 4277 | 4618 | 5975 | 2336 | 4302 | 2141 | 3299 | 3513 | 2097 | 2268 | 3819 |
| 2068 | 3932 | 4277 | 4618 | 5975 | 2336 | 4302 | 2141 | 3299 | 3513 | 2097 | 2268 | 3819 |
| 2069 | 3932 | 4277 | 4618 | 5975 | 2336 | 4302 | 2141 | 3299 | 3513 | 2097 | 2268 | 3819 |
| 2070 | 3932 | 4277 | 4618 | 5975 | 2336 | 4302 | 2141 | 3299 | 3513 | 2097 | 2268 | 3819 |
| 2071 | 3932 | 4277 | 4618 | 5975 | 2336 | 4302 | 2141 | 3299 | 3513 | 2097 | 2268 | 3819 |
| 2072 | 3932 | 4277 | 4618 | 5975 | 2336 | 4302 | 2141 | 3299 | 3513 | 2097 | 2268 | 3819 |
| 2073 | 3932 | 4277 | 4618 | 5975 | 2336 | 4302 | 2141 | 3299 | 3513 | 2097 | 2268 | 3819 |
| 2074 | 3932 | 4277 | 4618 | 5975 | 2336 | 4302 | 2141 | 3299 | 3513 | 2097 | 2268 | 3819 |
| 2075 | 3932 | 4277 | 4618 | 5975 | 2336 | 4302 | 2141 | 3299 | 3513 | 2097 | 2268 | 3819 |
| 2076 | 3932 | 4277 | 4618 | 5975 | 2336 | 4302 | 2141 | 3299 | 3513 | 2097 | 2268 | 3819 |
| 2077 | 3932 | 4277 | 4618 | 5975 | 2336 | 4302 | 2141 | 3299 | 3513 | 2097 | 2268 | 3819 |
| 2078 | 3932 | 4277 | 4618 | 5975 | 2336 | 4302 | 2141 | 3299 | 3513 | 2097 | 2268 | 3819 |
| 2079 | 3932 | 4277 | 4618 | 5975 | 2336 | 4302 | 2141 | 3299 | 3513 | 2097 | 2268 | 3819 |
| 2080 | 3932 | 4277 | 4618 | 5975 | 2336 | 4302 | 2141 | 3299 | 3513 | 2097 | 2268 | 3819 |
| 2081 | 3932 | 4277 | 4618 | 5975 | 2336 | 4302 | 2141 | 3299 | 3513 | 2097 | 2268 | 3819 |
| 2082 | 3932 | 4277 | 4618 | 5975 | 2336 | 4302 | 2141 | 3299 | 3513 | 2097 | 2268 | 3819 |
| 2083 | 3932 | 4277 | 4618 | 5975 | 2336 | 4302 | 2141 | 3299 | 3513 | 2097 | 2268 | 3819 |
| 2084 | 3932 | 4277 | 4618 | 5975 | 2336 | 4302 | 2141 | 3299 | 3513 | 2097 | 2268 | 3819 |
| 2085 | 3932 | 4277 | 4618 | 5975 | 2336 | 4302 | 2141 | 3299 | 3513 | 2097 | 2268 | 3819 |
| 2086 | 3932 | 4277 | 4618 | 5975 | 2336 | 4302 | 2141 | 3299 | 3513 | 2097 | 2268 | 3819 |
| 2087 | 3932 | 4277 | 4618 | 5975 | 2336 | 4302 | 2141 | 3299 | 3513 | 2097 | 2268 | 3819 |
| 2088 | 3932 | 4277 | 4618 | 5975 | 2336 | 4302 | 2141 | 3299 | 3513 | 2097 | 2268 | 3819 |
| 2089 | 3932 | 4277 | 4618 | 5975 | 2336 | 4302 | 2141 | 3299 | 3513 | 2097 | 2268 | 3819 |
| 2090 | 3932 | 4277 | 4618 | 5975 | 2336 | 4302 | 2141 | 3299 | 3513 | 2097 | 2268 | 3819 |

|      | 25   | 26   | 27   | 28   | 29   | 30   | 31   | 32   | 33   | 34   | 35   | 36   |
|------|------|------|------|------|------|------|------|------|------|------|------|------|
| 2002 | 0    | 0    | 0    | 0    | 0    | 0    | 0    | 0    | 0    | 0    | 0    | 0    |
| 2003 | 0    | 0    | 0    | 0    | 0    | 0    | 0    | 0    | 0    | 0    | 0    | 0    |
| 2004 | 0    | 0    | 0    | 0    | 0    | 0    | 0    | 0    | 0    | 0    | 0    | 0    |
| 2005 | 0    | 0    | 0    | 0    | 0    | 0    | 0    | 0    | 0    | 0    | 0    | 0    |
| 2006 | 0    | 0    | 0    | 0    | 0    | 0    | 0    | 0    | 0    | 0    | 0    | 0    |
| 2007 | 0    | 0    | 0    | 0    | 0    | 0    | 0    | 0    | 0    | 0    | 0    | 0    |
| 2008 | 0    | 0    | 0    | 0    | 0    | 0    | 0    | 0    | 0    | 0    | 0    | 0    |
| 2009 | 0    | 0    | 0    | 0    | 0    | 0    | 0    | 0    | 0    | 0    | 0    | 0    |
| 2010 | 0    | 0    | 0    | 0    | 0    | 0    | 0    | 0    | 0    | 0    | 0    | 0    |
| 2011 | 0    | 0    | 0    | 0    | 0    | 0    | 0    | 0    | 0    | 0    | 0    | 0    |
| 2012 | 0    | 0    | 0    | 0    | 0    | 0    | 0    | 0    | 0    | 0    | 0    | 0    |
| 2013 | 0    | 0    | 0    | 0    | 0    | 0    | 0    | 0    | 0    | 0    | 0    | 0    |
| 2014 | 0    | 0    | 0    | 0    | 0    | 0    | 0    | 0    | 0    | 0    | 0    | 0    |
| 2015 | 0    | 0    | 0    | 0    | 0    | 0    | 0    | 0    | 0    | 0    | 0    | 0    |
| 2016 | 0    | 0    | 0    | 0    | 0    | 0    | 0    | 0    | 0    | 0    | 0    | 0    |
| 2017 | 0    | 0    | 0    | 0    | 0    | 0    | 0    | 0    | 0    | 0    | 0    | 0    |
| 2018 | 0    | 0    | 0    | 0    | 0    | 0    | 0    | 0    | 0    | 0    | 0    | 0    |
| 2019 | 0    | 0    | 0    | 0    | 0    | 0    | 0    | 0    | 0    | 0    | 0    | 0    |
| 2020 | 0    | 0    | 0    | 0    | 0    | 0    | 254  | 0    | 0    | 0    | 0    | 0    |
| 2021 | 0    | 0    | 0    | 0    | 0    | 0    | 506  | 0    | 0    | 0    | 0    | 0    |
| 2022 | 0    | 0    | 0    | 0    | 0    | 0    | 760  | 0    | 0    | 0    | 0    | 0    |
| 2023 | 0    | 0    | 0    | 0    | 0    | 0    | 1017 | 0    | 0    | 0    | 0    | 0    |
| 2024 | 0    | 0    | 0    | 0    | 0    | 0    | 1268 | 0    | 0    | 0    | 0    | 0    |
| 2025 | 64   | 1    | 17   | 256  | 256  | 0    | 1537 | 256  | 256  | 256  | 256  | 256  |
| 2026 | 158  | 6    | 52   | 506  | 506  | 0    | 1793 | 506  | 506  | 506  | 506  | 506  |
| 2027 | 252  | 11   | 82   | 757  | 757  | 0    | 2050 | 757  | 757  | 757  | 757  | 757  |
| 2028 | 365  | 24   | 126  | 1011 | 1011 | 0    | 2306 | 1011 | 1011 | 1011 | 1011 | 1011 |
| 2029 | 491  | 62   | 200  | 1261 | 1261 | 0    | 2592 | 1261 | 1261 | 1261 | 1261 | 1261 |
| 2030 | 638  | 91   | 275  | 1513 | 1513 | 256  | 2871 | 1513 | 1513 | 1513 | 1513 | 1513 |
| 2031 | 780  | 108  | 341  | 1771 | 1771 | 509  | 3136 | 1771 | 1775 | 1771 | 1771 | 1771 |
| 2032 | 939  | 135  | 411  | 2027 | 2027 | 759  | 3435 | 2027 | 2053 | 2027 | 2020 | 2027 |
| 2033 | 1086 | 173  | 491  | 2289 | 2292 | 1016 | 3751 | 2277 | 2327 | 2292 | 2280 | 2292 |
| 2034 | 1242 | 221  | 575  | 2553 | 2556 | 1271 | 4022 | 2536 | 2591 | 2556 | 2505 | 2556 |
| 2035 | 1432 | 275  | 667  | 2830 | 2833 | 1523 | 4343 | 2803 | 2864 | 2833 | 2720 | 2833 |
| 2036 | 1607 | 335  | 773  | 3141 | 3145 | 1790 | 4599 | 3086 | 3118 | 3146 | 2928 | 3145 |
| 2037 | 1792 | 385  | 884  | 3432 | 3447 | 2052 | 4792 | 3361 | 3406 | 3446 | 3159 | 3443 |
| 2038 | 1944 | 435  | 990  | 3757 | 3772 | 2314 | 5031 | 3701 | 3676 | 3774 | 3368 | 3766 |
| 2039 | 2125 | 490  | 1096 | 4007 | 4036 | 2577 | 5263 | 3979 | 3961 | 4050 | 3554 | 4032 |
| 2040 | 2288 | 531  | 1190 | 4320 | 4372 | 2858 | 5501 | 4306 | 4266 | 4386 | 3797 | 4360 |
| 2041 | 2480 | 594  | 1276 | 4555 | 4603 | 3141 | 5645 | 4553 | 4544 | 4656 | 3935 | 4587 |
| 2042 | 2697 | 637  | 1363 | 4807 | 4898 | 3457 | 5721 | 4912 | 4832 | 5004 | 4170 | 4908 |
| 2043 | 2869 | 699  | 1453 | 4988 | 5063 | 3777 | 5807 | 4984 | 5135 | 5149 | 4284 | 5050 |
| 2044 | 3033 | 757  | 1540 | 5048 | 5225 | 4023 | 5898 | 5125 | 5261 | 5278 | 4413 | 5179 |
| 2045 | 3197 | 802  | 1648 | 5130 | 5424 | 4177 | 5973 | 5281 | 5432 | 5443 | 4578 | 5344 |
| 2046 | 3329 | 860  | 1728 | 5229 | 5609 | 4360 | 6043 | 5447 | 5611 | 5599 | 4734 | 5500 |
| 2047 | 3464 | 995  | 1863 | 5325 | 5797 | 4550 | 6078 | 5587 | 5750 | 5758 | 4893 | 5659 |
| 2048 | 3644 | 1175 | 2043 | 5398 | 5971 | 4728 | 6089 | 5717 | 5867 | 5880 | 5015 | 5781 |
| 2049 | 3802 | 1333 | 2201 | 5461 | 6112 | 4905 | 6102 | 5827 | 5970 | 5992 | 5127 | 5893 |
| 2050 | 3969 | 1500 | 2368 | 5530 | 6278 | 5062 | 6104 | 5945 | 6081 | 6092 | 5227 | 5993 |
| 2051 | 4135 | 1666 | 2534 | 5594 | 6437 | 5231 | 6105 | 6062 | 6171 | 6205 | 5340 | 6106 |
| 2052 | 4286 | 1817 | 2685 | 5639 | 6577 | 5382 | 6107 | 6171 | 6238 | 6291 | 5426 | 6192 |
| 2053 | 4367 | 1898 | 2766 | 5672 | 6678 | 5503 | 6108 | 6233 | 6282 | 6354 | 5489 | 6255 |
| 2054 | 4393 | 1924 | 2792 | 5690 | 6740 | 5649 | 6108 | 6272 | 6313 | 6394 | 5529 | 6295 |
| 2055 | 4393 | 1924 | 2792 | 5704 | 6796 | 5799 | 6108 | 6300 | 6326 | 6426 | 5561 | 6327 |
| 2056 | 4393 | 1924 | 2792 | 5706 | 6815 | 5944 | 6108 | 6309 | 6330 | 6431 | 5566 | 6332 |
| 2057 | 4393 | 1924 | 2792 | 5708 | 6822 | 6081 | 6108 | 6311 | 6335 | 6437 | 5572 | 6338 |
| 2058 | 4393 | 1924 | 2792 | 5708 | 6829 | 6181 | 6108 | 6317 | 6335 | 6437 | 5572 | 6338 |
| 2059 | 4393 | 1924 | 2792 | 5709 | 6832 | 6262 | 6108 | 6318 | 6335 | 6437 | 5572 | 6338 |

|      | 25   | 26   | 27   | 28   | 29   | 30   | 31   | 32   | 33   | 34   | 35   | 36   |
|------|------|------|------|------|------|------|------|------|------|------|------|------|
| 2060 | 4393 | 1924 | 2792 | 5709 | 6832 | 6326 | 6108 | 6318 | 6335 | 6437 | 5572 | 6338 |
| 2061 | 4393 | 1924 | 2792 | 5709 | 6832 | 6371 | 6108 | 6318 | 6335 | 6437 | 5572 | 6338 |
| 2062 | 4393 | 1924 | 2792 | 5709 | 6832 | 6393 | 6108 | 6318 | 6335 | 6437 | 5572 | 6338 |
| 2063 | 4393 | 1924 | 2792 | 5709 | 6832 | 6398 | 6108 | 6318 | 6335 | 6437 | 5572 | 6338 |
| 2064 | 4393 | 1924 | 2792 | 5709 | 6832 | 6400 | 6108 | 6318 | 6335 | 6437 | 5572 | 6338 |
| 2065 | 4393 | 1924 | 2792 | 5709 | 6832 | 6403 | 6108 | 6318 | 6335 | 6437 | 5572 | 6338 |
| 2066 | 4393 | 1924 | 2792 | 5709 | 6832 | 6404 | 6108 | 6318 | 6335 | 6437 | 5572 | 6338 |
| 2067 | 4393 | 1924 | 2792 | 5709 | 6832 | 6404 | 6108 | 6318 | 6335 | 6437 | 5572 | 6338 |
| 2068 | 4393 | 1924 | 2792 | 5709 | 6832 | 6404 | 6108 | 6318 | 6335 | 6437 | 5572 | 6338 |
| 2069 | 4393 | 1924 | 2792 | 5709 | 6832 | 6404 | 6108 | 6318 | 6335 | 6437 | 5572 | 6338 |
| 2070 | 4393 | 1924 | 2792 | 5709 | 6832 | 6404 | 6108 | 6318 | 6335 | 6437 | 5572 | 6338 |
| 2071 | 4393 | 1924 | 2792 | 5709 | 6832 | 6404 | 6108 | 6318 | 6335 | 6437 | 5572 | 6338 |
| 2072 | 4393 | 1924 | 2792 | 5709 | 6832 | 6404 | 6108 | 6318 | 6335 | 6437 | 5572 | 6338 |
| 2073 | 4393 | 1924 | 2792 | 5709 | 6832 | 6404 | 6108 | 6318 | 6335 | 6437 | 5572 | 6338 |
| 2074 | 4393 | 1924 | 2792 | 5709 | 6832 | 6404 | 6108 | 6318 | 6335 | 6437 | 5572 | 6338 |
| 2075 | 4393 | 1924 | 2792 | 5709 | 6832 | 6404 | 6108 | 6318 | 6335 | 6437 | 5572 | 6338 |
| 2076 | 4393 | 1924 | 2792 | 5709 | 6832 | 6404 | 6108 | 6318 | 6335 | 6437 | 5572 | 6338 |
| 2077 | 4393 | 1924 | 2792 | 5709 | 6832 | 6404 | 6108 | 6318 | 6335 | 6437 | 5572 | 6338 |
| 2078 | 4393 | 1924 | 2792 | 5709 | 6832 | 6404 | 6108 | 6318 | 6335 | 6437 | 5572 | 6338 |
| 2079 | 4393 | 1924 | 2792 | 5709 | 6832 | 6404 | 6108 | 6318 | 6335 | 6437 | 5572 | 6338 |
| 2080 | 4393 | 1924 | 2792 | 5709 | 6832 | 6404 | 6108 | 6318 | 6335 | 6437 | 5572 | 6338 |
| 2081 | 4393 | 1924 | 2792 | 5709 | 6832 | 6404 | 6108 | 6318 | 6335 | 6437 | 5572 | 6338 |
| 2082 | 4393 | 1924 | 2792 | 5709 | 6832 | 6404 | 6108 | 6318 | 6335 | 6437 | 5572 | 6338 |
| 2083 | 4393 | 1924 | 2792 | 5709 | 6832 | 6404 | 6108 | 6318 | 6335 | 6437 | 5572 | 6338 |
| 2084 | 4393 | 1924 | 2792 | 5709 | 6832 | 6404 | 6108 | 6318 | 6335 | 6437 | 5572 | 6338 |
| 2085 | 4393 | 1924 | 2792 | 5709 | 6832 | 6404 | 6108 | 6318 | 6335 | 6437 | 5572 | 6338 |
| 2086 | 4393 | 1924 | 2792 | 5709 | 6832 | 6404 | 6108 | 6318 | 6335 | 6437 | 5572 | 6338 |
| 2087 | 4393 | 1924 | 2792 | 5709 | 6832 | 6404 | 6108 | 6318 | 6335 | 6437 | 5572 | 6338 |
| 2088 | 4393 | 1924 | 2792 | 5709 | 6832 | 6404 | 6108 | 6318 | 6335 | 6437 | 5572 | 6338 |
| 2089 | 4393 | 1924 | 2792 | 5709 | 6832 | 6404 | 6108 | 6318 | 6335 | 6437 | 5572 | 6338 |
| 2090 | 4393 | 1924 | 2792 | 5709 | 6832 | 6404 | 6108 | 6318 | 6335 | 6437 | 5572 | 6338 |

|      | 37   | 38   | 39   | 40   | 41   | 42   | 43   | 44   | 45   | 46   | 47   | 48   |
|------|------|------|------|------|------|------|------|------|------|------|------|------|
| 2002 | 0    | 0    | 0    | 0    | 0    | 0    | 0    | 0    | 0    | 0    | 0    | 0    |
| 2003 | 0    | 0    | 0    | 0    | 0    | 0    | 0    | 0    | 0    | 0    | 0    | 0    |
| 2004 | 0    | 0    | 0    | 0    | 0    | 0    | 0    | 0    | 0    | 0    | 0    | 0    |
| 2005 | 0    | 0    | 0    | 0    | 0    | 0    | 0    | 0    | 0    | 0    | 0    | 0    |
| 2006 | 0    | 0    | 0    | 0    | 0    | 0    | 0    | 0    | 0    | 0    | 0    | 0    |
| 2007 | 0    | 0    | 0    | 0    | 0    | 0    | 0    | 0    | 0    | 0    | 0    | 0    |
| 2008 | 0    | 0    | 0    | 0    | 0    | 0    | 0    | 0    | 0    | 0    | 0    | 0    |
| 2009 | 0    | 0    | 0    | 0    | 0    | 0    | 0    | 0    | 0    | 0    | 0    | 0    |
| 2010 | 0    | 0    | 0    | 0    | 0    | 0    | 0    | 0    | 0    | 0    | 0    | 0    |
| 2011 | 0    | 0    | 0    | 0    | 0    | 0    | 0    | 0    | 0    | 0    | 0    | 0    |
| 2012 | 0    | 0    | 0    | 0    | 0    | 0    | 0    | 0    | 0    | 0    | 0    | 0    |
| 2013 | 0    | 0    | 0    | 0    | 0    | 0    | 0    | 0    | 0    | 0    | 0    | 0    |
| 2014 | 0    | 0    | 0    | 0    | 0    | 0    | 0    | 0    | 0    | 0    | 0    | 0    |
| 2015 | 0    | 0    | 0    | 0    | 0    | 0    | 0    | 0    | 0    | 0    | 0    | 0    |
| 2016 | 0    | 0    | 0    | 0    | 0    | 0    | 0    | 0    | 0    | 0    | 0    | 0    |
| 2017 | 0    | 0    | 0    | 0    | 0    | 0    | 0    | 0    | 0    | 0    | 0    | 0    |
| 2018 | 0    | 0    | 0    | 0    | 0    | 0    | 0    | 0    | 0    | 0    | 0    | 0    |
| 2019 | 0    | 0    | 0    | 0    | 0    | 0    | 0    | 0    | 0    | 0    | 0    | 0    |
| 2020 | 0    | 0    | 0    | 90   | 0    | 0    | 0    | 0    | 0    | 0    | 0    | 0    |
| 2021 | 0    | 0    | 0    | 181  | 0    | 0    | 0    | 0    | 0    | 0    | 0    | 0    |
| 2022 | 0    | 0    | 0    | 287  | 0    | 0    | 0    | 0    | 0    | 0    | 0    | 0    |
| 2023 | 0    | 0    | 0    | 403  | 0    | 0    | 0    | 0    | 0    | 0    | 0    | 0    |
| 2024 | 0    | 0    | 0    | 553  | 0    | 0    | 0    | 0    | 0    | 0    | 0    | 0    |
| 2025 | 71   | 71   | 0    | 680  | 64   | 174  | 244  | 4    | 71   | 17   | 17   | 0    |
| 2026 | 158  | 165  | 0    | 824  | 151  | 339  | 486  | 26   | 163  | 47   | 50   | 0    |
| 2027 | 244  | 256  | 0    | 987  | 246  | 502  | 740  | 35   | 249  | 74   | 81   | 0    |
| 2028 | 354  | 370  | 0    | 1181 | 371  | 657  | 980  | 64   | 365  | 115  | 125  | 0    |
| 2029 | 463  | 479  | 0    | 1384 | 486  | 814  | 1226 | 110  | 480  | 179  | 193  | 0    |
| 2030 | 600  | 620  | 66   | 1554 | 652  | 978  | 1477 | 151  | 623  | 249  | 272  | 10   |
| 2031 | 769  | 798  | 169  | 1734 | 809  | 1134 | 1714 | 208  | 798  | 307  | 341  | 46   |
| 2032 | 931  | 979  | 279  | 1946 | 964  | 1303 | 1959 | 270  | 971  | 364  | 413  | 92   |
| 2033 | 1105 | 1171 | 412  | 2103 | 1140 | 1451 | 2205 | 346  | 1151 | 433  | 500  | 151  |
| 2034 | 1272 | 1351 | 551  | 2267 | 1319 | 1622 | 2471 | 425  | 1322 | 517  | 599  | 228  |
| 2035 | 1442 | 1542 | 708  | 2433 | 1505 | 1765 | 2736 | 492  | 1520 | 596  | 688  | 313  |
| 2036 | 1595 | 1721 | 859  | 2576 | 1668 | 1937 | 2972 | 590  | 1706 | 689  | 787  | 382  |
| 2037 | 1744 | 1897 | 1020 | 2720 | 1833 | 2114 | 3186 | 669  | 1868 | 779  | 889  | 489  |
| 2038 | 1885 | 2054 | 1222 | 2868 | 1950 | 2275 | 3385 | 724  | 2024 | 885  | 1016 | 596  |
| 2039 | 2013 | 2207 | 1407 | 2997 | 2086 | 2442 | 3584 | 779  | 2183 | 962  | 1132 | 706  |
| 2040 | 2185 | 2406 | 1559 | 3111 | 2228 | 2607 | 3796 | 828  | 2351 | 1041 | 1230 | 825  |
| 2041 | 2335 | 2580 | 1729 | 3259 | 2402 | 2762 | 4012 | 894  | 2499 | 1122 | 1325 | 923  |
| 2042 | 2501 | 2763 | 1935 | 3343 | 2592 | 2971 | 4225 | 983  | 2674 | 1207 | 1423 | 1014 |
| 2043 | 2647 | 2944 | 2137 | 3424 | 2742 | 3146 | 4421 | 1074 | 2842 | 1288 | 1544 | 1130 |
| 2044 | 2784 | 3121 | 2356 | 3499 | 2899 | 3275 | 4586 | 1161 | 2990 | 1361 | 1654 | 1236 |
| 2045 | 2895 | 3264 | 2550 | 3561 | 3056 | 3414 | 4747 | 1257 | 3130 | 1464 | 1776 | 1339 |
| 2046 | 3004 | 3394 | 2720 | 3633 | 3201 | 3532 | 4891 | 1330 | 3246 | 1528 | 1866 | 1472 |
| 2047 | 3093 | 3506 | 2825 | 3650 | 3262 | 3714 | 5037 | 1389 | 3363 | 1603 | 2020 | 1523 |
| 2048 | 3139 | 3579 | 2948 | 3663 | 3355 | 3805 | 5111 | 1421 | 3414 | 1693 | 2199 | 1654 |
| 2049 | 3168 | 3640 | 3155 | 3789 | 3515 | 3977 | 5172 | 1482 | 3475 | 1785 | 2389 | 1839 |
| 2050 | 3268 | 3850 | 3330 | 3884 | 3658 | 4127 | 5336 | 1646 | 3639 | 1860 | 2555 | 2016 |
| 2051 | 3352 | 4011 | 3473 | 3933 | 3781 | 4271 | 5486 | 1796 | 3789 | 1938 | 2739 | 2159 |
| 2052 | 3433 | 4198 | 3635 | 3950 | 3928 | 4410 | 5639 | 1949 | 3942 | 2018 | 2943 | 2314 |
| 2053 | 3507 | 4394 | 3801 | 3958 | 4070 | 4511 | 5773 | 2083 | 4076 | 2078 | 3106 | 2487 |
| 2054 | 3583 | 4579 | 3948 | 3966 | 4173 | 4558 | 5893 | 2203 | 4196 | 2107 | 3191 | 2642 |
| 2055 | 3620 | 4687 | 4112 | 3969 | 4225 | 4584 | 5948 | 2258 | 4251 | 2122 | 3239 | 2807 |
| 2056 | 3640 | 4750 | 4289 | 3969 | 4256 | 4600 | 5986 | 2296 | 4289 | 2135 | 3274 | 2968 |
| 2057 | 3655 | 4793 | 4440 | 3969 | 4277 | 4606 | 6007 | 2317 | 4310 | 2138 | 3297 | 3139 |
| 2058 | 3663 | 4821 | 4543 | 3969 | 4287 | 4610 | 6013 | 2323 | 4316 | 2138 | 3304 | 3287 |
| 2059 | 3665 | 4828 | 4602 | 3969 | 4287 | 4610 | 6013 | 2323 | 4316 | 2138 | 3304 | 3366 |

|      | 37   | 38   | 39   | 40   | 41   | 42   | 43   | 44   | 45   | 46   | 47   | 48   |
|------|------|------|------|------|------|------|------|------|------|------|------|------|
| 2060 | 3665 | 4828 | 4638 | 3969 | 4291 | 4610 | 6013 | 2323 | 4316 | 2138 | 3304 | 3411 |
| 2061 | 3666 | 4828 | 4665 | 3969 | 4291 | 4610 | 6013 | 2323 | 4316 | 2138 | 3304 | 3443 |
| 2062 | 3666 | 4828 | 4693 | 3969 | 4291 | 4610 | 6013 | 2323 | 4316 | 2138 | 3304 | 3472 |
| 2063 | 3666 | 4828 | 4720 | 3969 | 4291 | 4610 | 6013 | 2323 | 4316 | 2138 | 3304 | 3495 |
| 2064 | 3666 | 4828 | 4730 | 3969 | 4291 | 4610 | 6013 | 2323 | 4316 | 2138 | 3304 | 3512 |
| 2065 | 3666 | 4828 | 4730 | 3969 | 4291 | 4610 | 6013 | 2323 | 4316 | 2138 | 3304 | 3515 |
| 2066 | 3666 | 4828 | 4730 | 3969 | 4291 | 4610 | 6013 | 2323 | 4316 | 2138 | 3304 | 3515 |
| 2067 | 3666 | 4828 | 4730 | 3969 | 4291 | 4610 | 6013 | 2323 | 4316 | 2138 | 3304 | 3517 |
| 2068 | 3666 | 4828 | 4730 | 3969 | 4291 | 4610 | 6013 | 2323 | 4316 | 2138 | 3304 | 3517 |
| 2069 | 3666 | 4828 | 4730 | 3969 | 4291 | 4610 | 6013 | 2323 | 4316 | 2138 | 3304 | 3517 |
| 2070 | 3666 | 4828 | 4730 | 3969 | 4291 | 4610 | 6013 | 2323 | 4316 | 2138 | 3304 | 3517 |
| 2071 | 3666 | 4828 | 4730 | 3969 | 4291 | 4610 | 6013 | 2323 | 4316 | 2138 | 3304 | 3517 |
| 2072 | 3666 | 4828 | 4730 | 3969 | 4291 | 4610 | 6013 | 2323 | 4316 | 2138 | 3304 | 3517 |
| 2073 | 3666 | 4828 | 4730 | 3969 | 4291 | 4610 | 6013 | 2323 | 4316 | 2138 | 3304 | 3517 |
| 2074 | 3666 | 4828 | 4730 | 3969 | 4291 | 4610 | 6013 | 2323 | 4316 | 2138 | 3304 | 3517 |
| 2075 | 3666 | 4828 | 4730 | 3969 | 4291 | 4610 | 6013 | 2323 | 4316 | 2138 | 3304 | 3517 |
| 2076 | 3666 | 4828 | 4730 | 3969 | 4291 | 4610 | 6013 | 2323 | 4316 | 2138 | 3304 | 3517 |
| 2077 | 3666 | 4828 | 4730 | 3969 | 4291 | 4610 | 6013 | 2323 | 4316 | 2138 | 3304 | 3517 |
| 2078 | 3666 | 4828 | 4730 | 3969 | 4291 | 4610 | 6013 | 2323 | 4316 | 2138 | 3304 | 3517 |
| 2079 | 3666 | 4828 | 4730 | 3969 | 4291 | 4610 | 6013 | 2323 | 4316 | 2138 | 3304 | 3517 |
| 2080 | 3666 | 4828 | 4730 | 3969 | 4291 | 4610 | 6013 | 2323 | 4316 | 2138 | 3304 | 3517 |
| 2081 | 3666 | 4828 | 4730 | 3969 | 4291 | 4610 | 6013 | 2323 | 4316 | 2138 | 3304 | 3517 |
| 2082 | 3666 | 4828 | 4730 | 3969 | 4291 | 4610 | 6013 | 2323 | 4316 | 2138 | 3304 | 3517 |
| 2083 | 3666 | 4828 | 4730 | 3969 | 4291 | 4610 | 6013 | 2323 | 4316 | 2138 | 3304 | 3517 |
| 2084 | 3666 | 4828 | 4730 | 3969 | 4291 | 4610 | 6013 | 2323 | 4316 | 2138 | 3304 | 3517 |
| 2085 | 3666 | 4828 | 4730 | 3969 | 4291 | 4610 | 6013 | 2323 | 4316 | 2138 | 3304 | 3517 |
| 2086 | 3666 | 4828 | 4730 | 3969 | 4291 | 4610 | 6013 | 2323 | 4316 | 2138 | 3304 | 3517 |
| 2087 | 3666 | 4828 | 4730 | 3969 | 4291 | 4610 | 6013 | 2323 | 4316 | 2138 | 3304 | 3517 |
| 2088 | 3666 | 4828 | 4730 | 3969 | 4291 | 4610 | 6013 | 2323 | 4316 | 2138 | 3304 | 3517 |
| 2089 | 3666 | 4828 | 4730 | 3969 | 4291 | 4610 | 6013 | 2323 | 4316 | 2138 | 3304 | 3517 |
| 2090 | 3666 | 4828 | 4730 | 3969 | 4291 | 4610 | 6013 | 2323 | 4316 | 2138 | 3304 | 3517 |



|      | 49   | 50   | 51   | 52   | 53   | 54   | 55   | 56   | 57   | 58   | 59   | 60   |
|------|------|------|------|------|------|------|------|------|------|------|------|------|
| 2002 | 0    | 0    | 0    | 0    | 0    | 0    | 0    | 0    | 0    | 0    | 0    | 0    |
| 2003 | 0    | 0    | 0    | 0    | 0    | 0    | 0    | 0    | 0    | 0    | 0    | 0    |
| 2004 | 0    | 0    | 0    | 0    | 0    | 0    | 0    | 0    | 0    | 0    | 0    | 0    |
| 2005 | 0    | 0    | 0    | 0    | 0    | 0    | 0    | 0    | 0    | 0    | 0    | 0    |
| 2006 | 0    | 0    | 0    | 0    | 0    | 0    | 0    | 0    | 0    | 0    | 0    | 0    |
| 2007 | 0    | 0    | 0    | 0    | 0    | 0    | 0    | 0    | 0    | 0    | 0    | 0    |
| 2008 | 0    | 0    | 0    | 0    | 0    | 0    | 0    | 0    | 0    | 0    | 0    | 0    |
| 2009 | 0    | 0    | 0    | 0    | 0    | 0    | 0    | 0    | 0    | 0    | 0    | 0    |
| 2010 | 0    | 0    | 0    | 0    | 0    | 0    | 0    | 0    | 0    | 0    | 0    | 0    |
| 2011 | 0    | 0    | 0    | 0    | 0    | 0    | 0    | 0    | 0    | 0    | 0    | 0    |
| 2012 | 0    | 0    | 0    | 0    | 0    | 0    | 0    | 0    | 0    | 0    | 0    | 0    |
| 2013 | 0    | 0    | 0    | 0    | 0    | 0    | 0    | 0    | 0    | 0    | 0    | 0    |
| 2014 | 0    | 0    | 0    | 0    | 0    | 0    | 0    | 0    | 0    | 0    | 0    | 0    |
| 2015 | 0    | 0    | 0    | 0    | 0    | 0    | 0    | 0    | 0    | 0    | 0    | 0    |
| 2016 | 0    | 0    | 0    | 0    | 0    | 0    | 0    | 0    | 0    | 0    | 0    | 0    |
| 2017 | 0    | 0    | 0    | 0    | 0    | 0    | 0    | 0    | 0    | 0    | 0    | 0    |
| 2018 | 0    | 0    | 0    | 0    | 0    | 0    | 0    | 0    | 0    | 0    | 0    | 0    |
| 2019 | 0    | 0    | 0    | 0    | 0    | 0    | 0    | 0    | 0    | 0    | 0    | 0    |
| 2020 | 10   | 0    | 0    | 0    | 0    | 0    | 0    | 0    | 0    | 254  | 0    | 0    |
| 2021 | 26   | 0    | 0    | 0    | 0    | 0    | 0    | 0    | 0    | 527  | 0    | 0    |
| 2022 | 48   | 0    | 0    | 0    | 0    | 0    | 0    | 0    | 0    | 825  | 0    | 0    |
| 2023 | 97   | 0    | 0    | 0    | 0    | 0    | 0    | 0    | 0    | 1067 | 0    | 0    |
| 2024 | 135  | 0    | 0    | 0    | 0    | 0    | 0    | 0    | 0    | 1324 | 0    | 0    |
| 2025 | 188  | 12   | 63   | 64   | 1    | 17   | 256  | 256  | 0    | 1586 | 256  | 256  |
| 2026 | 235  | 21   | 170  | 151  | 1    | 47   | 508  | 518  | 0    | 1882 | 518  | 518  |
| 2027 | 286  | 31   | 248  | 243  | 6    | 76   | 804  | 831  | 0    | 2147 | 826  | 826  |
| 2028 | 341  | 59   | 377  | 355  | 23   | 121  | 1054 | 1108 | 0    | 2380 | 1106 | 1106 |
| 2029 | 410  | 94   | 510  | 470  | 53   | 189  | 1293 | 1414 | 0    | 2635 | 1393 | 1393 |
| 2030 | 499  | 139  | 623  | 611  | 82   | 268  | 1519 | 1721 | 256  | 2917 | 1681 | 1681 |
| 2031 | 592  | 179  | 758  | 751  | 99   | 337  | 1748 | 2015 | 528  | 3198 | 1947 | 1947 |
| 2032 | 696  | 234  | 897  | 910  | 129  | 405  | 1968 | 2292 | 824  | 3502 | 2196 | 2196 |
| 2033 | 774  | 296  | 992  | 1056 | 167  | 484  | 2209 | 2594 | 1153 | 3808 | 2449 | 2449 |
| 2034 | 869  | 363  | 1139 | 1213 | 214  | 572  | 2447 | 2876 | 1465 | 4100 | 2707 | 2707 |
| 2035 | 954  | 424  | 1276 | 1400 | 265  | 659  | 2699 | 3137 | 1832 | 4384 | 2978 | 2977 |
| 2036 | 1048 | 483  | 1413 | 1548 | 323  | 753  | 2990 | 3443 | 2175 | 4746 | 3284 | 3275 |
| 2037 | 1128 | 560  | 1541 | 1729 | 371  | 852  | 3287 | 3729 | 2475 | 4981 | 3528 | 3559 |
| 2038 | 1202 | 639  | 1664 | 1901 | 421  | 972  | 3547 | 4042 | 2729 | 5198 | 3831 | 3902 |
| 2039 | 1281 | 711  | 1765 | 2078 | 478  | 1081 | 3847 | 4352 | 2987 | 5461 | 4142 | 4182 |
| 2040 | 1363 | 769  | 1913 | 2239 | 517  | 1169 | 4193 | 4715 | 3224 | 5696 | 4448 | 4494 |
| 2041 | 1466 | 826  | 2055 | 2436 | 584  | 1260 | 4559 | 5060 | 3486 | 5927 | 4824 | 4853 |
| 2042 | 1591 | 877  | 2254 | 2648 | 628  | 1351 | 4841 | 5341 | 3747 | 5989 | 5093 | 5142 |
| 2043 | 1699 | 941  | 2386 | 2815 | 684  | 1438 | 5259 | 5742 | 4014 | 6026 | 5426 | 5492 |
| 2044 | 1741 | 991  | 2558 | 2995 | 738  | 1529 | 5455 | 6031 | 4294 | 6113 | 5706 | 5724 |
| 2045 | 1804 | 1047 | 2700 | 3178 | 790  | 1646 | 5467 | 6055 | 4626 | 6135 | 5745 | 5764 |
| 2046 | 1920 | 1087 | 2843 | 3309 | 843  | 1730 | 5649 | 6297 | 4971 | 6135 | 5966 | 5987 |
| 2047 | 2007 | 1205 | 2967 | 3418 | 952  | 1839 | 5722 | 6479 | 5214 | 6135 | 6108 | 6126 |
| 2048 | 2063 | 1377 | 3126 | 3580 | 1114 | 2001 | 5750 | 6654 | 5270 | 6135 | 6240 | 6254 |
| 2049 | 2090 | 1496 | 3272 | 3737 | 1271 | 2158 | 5754 | 6768 | 5490 | 6135 | 6308 | 6316 |
| 2050 | 2100 | 1622 | 3413 | 3863 | 1397 | 2284 | 5754 | 6847 | 5707 | 6135 | 6324 | 6330 |
| 2051 | 2106 | 1771 | 3545 | 4000 | 1534 | 2421 | 5754 | 6884 | 5876 | 6135 | 6324 | 6330 |
| 2052 | 2106 | 1916 | 3661 | 4153 | 1687 | 2574 | 5754 | 6884 | 5995 | 6135 | 6324 | 6330 |
| 2053 | 2110 | 2056 | 3715 | 4258 | 1792 | 2679 | 5754 | 6884 | 6164 | 6135 | 6324 | 6330 |
| 2054 | 2110 | 2143 | 3751 | 4313 | 1847 | 2734 | 5754 | 6884 | 6309 | 6135 | 6324 | 6330 |
| 2055 | 2110 | 2193 | 3772 | 4344 | 1878 | 2765 | 5754 | 6884 | 6391 | 6135 | 6324 | 6330 |
| 2056 | 2110 | 2225 | 3780 | 4365 | 1899 | 2786 | 5754 | 6884 | 6430 | 6135 | 6324 | 6330 |
| 2057 | 2110 | 2246 | 3787 | 4373 | 1907 | 2794 | 5754 | 6884 | 6434 | 6135 | 6324 | 6330 |
| 2058 | 2110 | 2256 | 3787 | 4373 | 1907 | 2794 | 5754 | 6884 | 6434 | 6135 | 6324 | 6330 |
| 2059 | 2110 | 2256 | 3788 | 4378 | 1912 | 2799 | 5754 | 6884 | 6434 | 6135 | 6324 | 6330 |

|      | 49   | 50   | 51   | 52   | 53   | 54   | 55   | 56   | 57   | 58   | 59   | 60   |
|------|------|------|------|------|------|------|------|------|------|------|------|------|
| 2060 | 2110 | 2256 | 3788 | 4378 | 1912 | 2799 | 5754 | 6884 | 6434 | 6135 | 6324 | 6330 |
| 2061 | 2110 | 2256 | 3788 | 4378 | 1912 | 2799 | 5754 | 6884 | 6434 | 6135 | 6324 | 6330 |
| 2062 | 2110 | 2256 | 3788 | 4378 | 1912 | 2799 | 5754 | 6884 | 6434 | 6135 | 6324 | 6330 |
| 2063 | 2110 | 2256 | 3788 | 4378 | 1912 | 2799 | 5754 | 6884 | 6434 | 6135 | 6324 | 6330 |
| 2064 | 2110 | 2256 | 3788 | 4378 | 1912 | 2799 | 5754 | 6884 | 6434 | 6135 | 6324 | 6330 |
| 2065 | 2110 | 2256 | 3788 | 4378 | 1912 | 2799 | 5754 | 6884 | 6434 | 6135 | 6324 | 6330 |
| 2066 | 2110 | 2256 | 3788 | 4378 | 1912 | 2799 | 5754 | 6884 | 6434 | 6135 | 6324 | 6330 |
| 2067 | 2110 | 2256 | 3788 | 4378 | 1912 | 2799 | 5754 | 6884 | 6434 | 6135 | 6324 | 6330 |
| 2068 | 2110 | 2256 | 3788 | 4378 | 1912 | 2799 | 5754 | 6884 | 6434 | 6135 | 6324 | 6330 |
| 2069 | 2110 | 2256 | 3788 | 4378 | 1912 | 2799 | 5754 | 6884 | 6434 | 6135 | 6324 | 6330 |
| 2070 | 2110 | 2256 | 3788 | 4378 | 1912 | 2799 | 5754 | 6884 | 6434 | 6135 | 6324 | 6330 |
| 2071 | 2110 | 2256 | 3788 | 4378 | 1912 | 2799 | 5754 | 6884 | 6434 | 6135 | 6324 | 6330 |
| 2072 | 2110 | 2256 | 3788 | 4378 | 1912 | 2799 | 5754 | 6884 | 6434 | 6135 | 6324 | 6330 |
| 2073 | 2110 | 2256 | 3788 | 4378 | 1912 | 2799 | 5754 | 6884 | 6434 | 6135 | 6324 | 6330 |
| 2074 | 2110 | 2256 | 3788 | 4378 | 1912 | 2799 | 5754 | 6884 | 6434 | 6135 | 6324 | 6330 |
| 2075 | 2110 | 2256 | 3788 | 4378 | 1912 | 2799 | 5754 | 6884 | 6434 | 6135 | 6324 | 6330 |
| 2076 | 2110 | 2256 | 3788 | 4378 | 1912 | 2799 | 5754 | 6884 | 6434 | 6135 | 6324 | 6330 |
| 2077 | 2110 | 2256 | 3788 | 4378 | 1912 | 2799 | 5754 | 6884 | 6434 | 6135 | 6324 | 6330 |
| 2078 | 2110 | 2256 | 3788 | 4378 | 1912 | 2799 | 5754 | 6884 | 6434 | 6135 | 6324 | 6330 |
| 2079 | 2110 | 2256 | 3788 | 4378 | 1912 | 2799 | 5754 | 6884 | 6434 | 6135 | 6324 | 6330 |
| 2080 | 2110 | 2256 | 3788 | 4378 | 1912 | 2799 | 5754 | 6884 | 6434 | 6135 | 6324 | 6330 |
| 2081 | 2110 | 2256 | 3788 | 4378 | 1912 | 2799 | 5754 | 6884 | 6434 | 6135 | 6324 | 6330 |
| 2082 | 2110 | 2256 | 3788 | 4378 | 1912 | 2799 | 5754 | 6884 | 6434 | 6135 | 6324 | 6330 |
| 2083 | 2110 | 2256 | 3788 | 4378 | 1912 | 2799 | 5754 | 6884 | 6434 | 6135 | 6324 | 6330 |
| 2084 | 2110 | 2256 | 3788 | 4378 | 1912 | 2799 | 5754 | 6884 | 6434 | 6135 | 6324 | 6330 |
| 2085 | 2110 | 2256 | 3788 | 4378 | 1912 | 2799 | 5754 | 6884 | 6434 | 6135 | 6324 | 6330 |
| 2086 | 2110 | 2256 | 3788 | 4378 | 1912 | 2799 | 5754 | 6884 | 6434 | 6135 | 6324 | 6330 |
| 2087 | 2110 | 2256 | 3788 | 4378 | 1912 | 2799 | 5754 | 6884 | 6434 | 6135 | 6324 | 6330 |
| 2088 | 2110 | 2256 | 3788 | 4378 | 1912 | 2799 | 5754 | 6884 | 6434 | 6135 | 6324 | 6330 |
| 2089 | 2110 | 2256 | 3788 | 4378 | 1912 | 2799 | 5754 | 6884 | 6434 | 6135 | 6324 | 6330 |
| 2090 | 2110 | 2256 | 3788 | 4378 | 1912 | 2799 | 5754 | 6884 | 6434 | 6135 | 6324 | 6330 |

|      | 61   | 62   | 63   | 64   | 65   | 66   | 67   | 68   | 69   | 70   | 71   | 72   |
|------|------|------|------|------|------|------|------|------|------|------|------|------|
| 2002 | 0    | 0    | 0    | 0    | 0    | 0    | 0    | 0    | 0    | 0    | 0    | 0    |
| 2003 | 0    | 0    | 0    | 0    | 0    | 0    | 0    | 0    | 0    | 0    | 0    | 0    |
| 2004 | 0    | 0    | 0    | 0    | 0    | 0    | 0    | 0    | 0    | 0    | 0    | 0    |
| 2005 | 0    | 0    | 0    | 0    | 0    | 0    | 0    | 0    | 0    | 0    | 0    | 0    |
| 2006 | 0    | 0    | 0    | 0    | 0    | 0    | 0    | 0    | 0    | 0    | 0    | 0    |
| 2007 | 0    | 0    | 0    | 0    | 0    | 0    | 0    | 0    | 0    | 0    | 0    | 0    |
| 2008 | 0    | 0    | 0    | 0    | 0    | 0    | 0    | 0    | 0    | 0    | 0    | 0    |
| 2009 | 0    | 0    | 0    | 0    | 0    | 0    | 0    | 0    | 0    | 0    | 0    | 0    |
| 2010 | 0    | 0    | 0    | 0    | 0    | 0    | 0    | 0    | 0    | 0    | 0    | 0    |
| 2011 | 0    | 0    | 0    | 0    | 0    | 0    | 0    | 0    | 0    | 0    | 0    | 0    |
| 2012 | 0    | 0    | 0    | 0    | 0    | 0    | 0    | 0    | 0    | 0    | 0    | 0    |
| 2013 | 0    | 0    | 0    | 0    | 0    | 0    | 0    | 0    | 0    | 0    | 0    | 0    |
| 2014 | 0    | 0    | 0    | 0    | 0    | 0    | 0    | 0    | 0    | 0    | 0    | 0    |
| 2015 | 0    | 0    | 0    | 0    | 0    | 0    | 0    | 0    | 0    | 0    | 0    | 0    |
| 2016 | 0    | 0    | 0    | 0    | 0    | 0    | 0    | 0    | 0    | 0    | 0    | 0    |
| 2017 | 0    | 0    | 0    | 0    | 0    | 0    | 0    | 0    | 0    | 0    | 0    | 0    |
| 2018 | 0    | 0    | 0    | 0    | 0    | 0    | 0    | 0    | 0    | 0    | 0    | 0    |
| 2019 | 0    | 0    | 0    | 0    | 0    | 0    | 0    | 0    | 0    | 0    | 0    | 0    |
| 2020 | 0    | 0    | 0    | 0    | 0    | 0    | 90   | 0    | 0    | 0    | 0    | 0    |
| 2021 | 0    | 0    | 0    | 0    | 0    | 0    | 241  | 0    | 0    | 0    | 0    | 0    |
| 2022 | 0    | 0    | 0    | 0    | 0    | 0    | 406  | 0    | 0    | 0    | 0    | 0    |
| 2023 | 0    | 0    | 0    | 0    | 0    | 0    | 540  | 0    | 0    | 0    | 0    | 0    |
| 2024 | 0    | 0    | 0    | 0    | 0    | 0    | 678  | 0    | 0    | 0    | 0    | 0    |
| 2025 | 256  | 256  | 256  | 71   | 71   | 0    | 801  | 64   | 174  | 244  | 4    | 71   |
| 2026 | 518  | 518  | 518  | 222  | 284  | 0    | 937  | 238  | 448  | 584  | 15   | 278  |
| 2027 | 826  | 826  | 826  | 355  | 481  | 0    | 1094 | 388  | 705  | 916  | 33   | 449  |
| 2028 | 1106 | 1106 | 1106 | 498  | 692  | 0    | 1286 | 550  | 967  | 1255 | 59   | 649  |
| 2029 | 1393 | 1393 | 1393 | 599  | 865  | 0    | 1477 | 678  | 1166 | 1538 | 100  | 801  |
| 2030 | 1681 | 1681 | 1681 | 733  | 1046 | 66   | 1663 | 843  | 1348 | 1807 | 137  | 946  |
| 2031 | 1947 | 1947 | 1947 | 895  | 1247 | 311  | 1842 | 1026 | 1507 | 2074 | 187  | 1134 |
| 2032 | 2196 | 2196 | 2196 | 1044 | 1436 | 548  | 2056 | 1194 | 1678 | 2343 | 236  | 1313 |
| 2033 | 2449 | 2448 | 2449 | 1208 | 1638 | 771  | 2218 | 1391 | 1837 | 2592 | 292  | 1494 |
| 2034 | 2707 | 2699 | 2707 | 1379 | 1846 | 1011 | 2422 | 1570 | 2009 | 2875 | 352  | 1671 |
| 2035 | 2978 | 2956 | 2978 | 1572 | 2045 | 1204 | 2579 | 1758 | 2165 | 3164 | 406  | 1866 |
| 2036 | 3284 | 3240 | 3284 | 1733 | 2234 | 1380 | 2728 | 1925 | 2345 | 3389 | 485  | 2033 |
| 2037 | 3529 | 3458 | 3529 | 1898 | 2393 | 1560 | 2874 | 2076 | 2544 | 3596 | 551  | 2199 |
| 2038 | 3834 | 3687 | 3834 | 2036 | 2552 | 1785 | 3015 | 2221 | 2741 | 3798 | 623  | 2348 |
| 2039 | 4144 | 3912 | 4144 | 2175 | 2711 | 1978 | 3177 | 2350 | 2935 | 4007 | 678  | 2500 |
| 2040 | 4506 | 4163 | 4506 | 2362 | 2901 | 2134 | 3292 | 2500 | 3107 | 4254 | 739  | 2690 |
| 2041 | 4883 | 4444 | 4875 | 2505 | 3069 | 2351 | 3422 | 2675 | 3275 | 4476 | 824  | 2842 |
| 2042 | 5179 | 4661 | 5165 | 2663 | 3235 | 2547 | 3598 | 2882 | 3450 | 4712 | 887  | 3005 |
| 2043 | 5621 | 5018 | 5588 | 2816 | 3399 | 2723 | 3750 | 3041 | 3585 | 4902 | 951  | 3171 |
| 2044 | 5844 | 5197 | 5807 | 2942 | 3544 | 2903 | 3837 | 3153 | 3741 | 5075 | 985  | 3301 |
| 2045 | 5871 | 5224 | 5834 | 3049 | 3654 | 3056 | 3837 | 3252 | 3959 | 5237 | 1037 | 3408 |
| 2046 | 6085 | 5438 | 6048 | 3154 | 3756 | 3214 | 3998 | 3350 | 4039 | 5383 | 1088 | 3517 |
| 2047 | 6247 | 5600 | 6210 | 3166 | 3776 | 3358 | 4027 | 3360 | 4098 | 5410 | 1096 | 3534 |
| 2048 | 6365 | 5718 | 6328 | 3169 | 3786 | 3406 | 4031 | 3360 | 4336 | 5415 | 1101 | 3539 |
| 2049 | 6415 | 5768 | 6378 | 3397 | 4031 | 3406 | 4031 | 3606 | 4527 | 5659 | 1345 | 3783 |
| 2050 | 6425 | 5778 | 6388 | 3512 | 4249 | 3647 | 4031 | 3821 | 4616 | 5871 | 1557 | 3995 |
| 2051 | 6425 | 5778 | 6388 | 3559 | 4463 | 3874 | 4031 | 3965 | 4660 | 6009 | 1695 | 4133 |
| 2052 | 6425 | 5778 | 6388 | 3559 | 4587 | 4101 | 4031 | 4035 | 4675 | 6072 | 1758 | 4196 |
| 2053 | 6425 | 5778 | 6388 | 3559 | 4643 | 4290 | 4031 | 4064 | 4675 | 6100 | 1786 | 4224 |
| 2054 | 6425 | 5778 | 6388 | 3559 | 4683 | 4409 | 4031 | 4067 | 4675 | 6103 | 1789 | 4227 |
| 2055 | 6425 | 5778 | 6388 | 3559 | 4700 | 4512 | 4031 | 4067 | 4675 | 6103 | 1789 | 4227 |
| 2056 | 6425 | 5778 | 6388 | 3559 | 4708 | 4562 | 4031 | 4067 | 4675 | 6103 | 1789 | 4227 |
| 2057 | 6425 | 5778 | 6388 | 3559 | 4708 | 4575 | 4031 | 4067 | 4675 | 6103 | 1789 | 4227 |
| 2058 | 6425 | 5778 | 6388 | 3559 | 4708 | 4576 | 4031 | 4067 | 4675 | 6103 | 1789 | 4227 |
| 2059 | 6425 | 5778 | 6388 | 3559 | 4708 | 4576 | 4031 | 4067 | 4675 | 6103 | 1789 | 4227 |

|      | 61   | 62   | 63   | 64   | 65   | 66   | 67   | 68   | 69   | 70   | 71   | 72   |
|------|------|------|------|------|------|------|------|------|------|------|------|------|
| 2060 | 6425 | 5778 | 6388 | 3559 | 4708 | 4576 | 4031 | 4067 | 4675 | 6103 | 1789 | 4227 |
| 2061 | 6425 | 5778 | 6388 | 3559 | 4708 | 4576 | 4031 | 4067 | 4675 | 6103 | 1789 | 4227 |
| 2062 | 6425 | 5778 | 6388 | 3559 | 4708 | 4576 | 4031 | 4067 | 4675 | 6103 | 1789 | 4227 |
| 2063 | 6425 | 5778 | 6388 | 3559 | 4708 | 4576 | 4031 | 4067 | 4675 | 6103 | 1789 | 4227 |
| 2064 | 6425 | 5778 | 6388 | 3559 | 4708 | 4576 | 4031 | 4067 | 4675 | 6103 | 1789 | 4227 |
| 2065 | 6425 | 5778 | 6388 | 3559 | 4708 | 4576 | 4031 | 4067 | 4675 | 6103 | 1789 | 4227 |
| 2066 | 6425 | 5778 | 6388 | 3559 | 4708 | 4576 | 4031 | 4067 | 4675 | 6103 | 1789 | 4227 |
| 2067 | 6425 | 5778 | 6388 | 3559 | 4708 | 4576 | 4031 | 4067 | 4675 | 6103 | 1789 | 4227 |
| 2068 | 6425 | 5778 | 6388 | 3559 | 4708 | 4576 | 4031 | 4067 | 4675 | 6103 | 1789 | 4227 |
| 2069 | 6425 | 5778 | 6388 | 3559 | 4708 | 4576 | 4031 | 4067 | 4675 | 6103 | 1789 | 4227 |
| 2070 | 6425 | 5778 | 6388 | 3559 | 4708 | 4576 | 4031 | 4067 | 4675 | 6103 | 1789 | 4227 |
| 2071 | 6425 | 5778 | 6388 | 3559 | 4708 | 4576 | 4031 | 4067 | 4675 | 6103 | 1789 | 4227 |
| 2072 | 6425 | 5778 | 6388 | 3559 | 4708 | 4576 | 4031 | 4067 | 4675 | 6103 | 1789 | 4227 |
| 2073 | 6425 | 5778 | 6388 | 3559 | 4708 | 4576 | 4031 | 4067 | 4675 | 6103 | 1789 | 4227 |
| 2074 | 6425 | 5778 | 6388 | 3559 | 4708 | 4576 | 4031 | 4067 | 4675 | 6103 | 1789 | 4227 |
| 2075 | 6425 | 5778 | 6388 | 3559 | 4708 | 4576 | 4031 | 4067 | 4675 | 6103 | 1789 | 4227 |
| 2076 | 6425 | 5778 | 6388 | 3559 | 4708 | 4576 | 4031 | 4067 | 4675 | 6103 | 1789 | 4227 |
| 2077 | 6425 | 5778 | 6388 | 3559 | 4708 | 4576 | 4031 | 4067 | 4675 | 6103 | 1789 | 4227 |
| 2078 | 6425 | 5778 | 6388 | 3559 | 4708 | 4576 | 4031 | 4067 | 4675 | 6103 | 1789 | 4227 |
| 2079 | 6425 | 5778 | 6388 | 3559 | 4708 | 4576 | 4031 | 4067 | 4675 | 6103 | 1789 | 4227 |
| 2080 | 6425 | 5778 | 6388 | 3559 | 4708 | 4576 | 4031 | 4067 | 4675 | 6103 | 1789 | 4227 |
| 2081 | 6425 | 5778 | 6388 | 3559 | 4708 | 4576 | 4031 | 4067 | 4675 | 6103 | 1789 | 4227 |
| 2082 | 6425 | 5778 | 6388 | 3559 | 4708 | 4576 | 4031 | 4067 | 4675 | 6103 | 1789 | 4227 |
| 2083 | 6425 | 5778 | 6388 | 3559 | 4708 | 4576 | 4031 | 4067 | 4675 | 6103 | 1789 | 4227 |
| 2084 | 6425 | 5778 | 6388 | 3559 | 4708 | 4576 | 4031 | 4067 | 4675 | 6103 | 1789 | 4227 |
| 2085 | 6425 | 5778 | 6388 | 3559 | 4708 | 4576 | 4031 | 4067 | 4675 | 6103 | 1789 | 4227 |
| 2086 | 6425 | 5778 | 6388 | 3559 | 4708 | 4576 | 4031 | 4067 | 4675 | 6103 | 1789 | 4227 |
| 2087 | 6425 | 5778 | 6388 | 3559 | 4708 | 4576 | 4031 | 4067 | 4675 | 6103 | 1789 | 4227 |
| 2088 | 6425 | 5778 | 6388 | 3559 | 4708 | 4576 | 4031 | 4067 | 4675 | 6103 | 1789 | 4227 |
| 2089 | 6425 | 5778 | 6388 | 3559 | 4708 | 4576 | 4031 | 4067 | 4675 | 6103 | 1789 | 4227 |
| 2090 | 6425 | 5778 | 6388 | 3559 | 4708 | 4576 | 4031 | 4067 | 4675 | 6103 | 1789 | 4227 |

|      | 73   | 74   | 75   | 76   | 77   | 78   | 79   | 80   | 81   | 82   | 83   | 84   |
|------|------|------|------|------|------|------|------|------|------|------|------|------|
| 2002 | 0    | 0    | 0    | 0    | 0    | 0    | 0    | 0    | 0    | 0    | 0    | 0    |
| 2003 | 0    | 0    | 0    | 0    | 0    | 0    | 0    | 0    | 0    | 0    | 0    | 0    |
| 2004 | 0    | 0    | 0    | 0    | 0    | 0    | 0    | 0    | 0    | 0    | 0    | 0    |
| 2005 | 0    | 0    | 0    | 0    | 0    | 0    | 0    | 0    | 0    | 0    | 0    | 0    |
| 2006 | 0    | 0    | 0    | 0    | 0    | 0    | 0    | 0    | 0    | 0    | 0    | 0    |
| 2007 | 0    | 0    | 0    | 0    | 0    | 0    | 0    | 0    | 0    | 0    | 0    | 0    |
| 2008 | 0    | 0    | 0    | 0    | 0    | 0    | 0    | 0    | 0    | 0    | 0    | 0    |
| 2009 | 0    | 0    | 0    | 0    | 0    | 0    | 0    | 0    | 0    | 0    | 0    | 0    |
| 2010 | 0    | 0    | 0    | 0    | 0    | 0    | 0    | 0    | 0    | 0    | 0    | 0    |
| 2011 | 0    | 0    | 0    | 0    | 0    | 0    | 0    | 0    | 0    | 0    | 0    | 0    |
| 2012 | 0    | 0    | 0    | 0    | 0    | 0    | 0    | 0    | 0    | 0    | 0    | 0    |
| 2013 | 0    | 0    | 0    | 0    | 0    | 0    | 0    | 0    | 0    | 0    | 0    | 0    |
| 2014 | 0    | 0    | 0    | 0    | 0    | 0    | 0    | 0    | 0    | 0    | 0    | 0    |
| 2015 | 0    | 0    | 0    | 0    | 0    | 0    | 0    | 0    | 0    | 0    | 0    | 0    |
| 2016 | 0    | 0    | 0    | 0    | 0    | 0    | 0    | 0    | 0    | 0    | 0    | 0    |
| 2017 | 0    | 0    | 0    | 0    | 0    | 0    | 0    | 0    | 0    | 0    | 0    | 0    |
| 2018 | 0    | 0    | 0    | 0    | 0    | 0    | 0    | 0    | 0    | 0    | 0    | 0    |
| 2019 | 0    | 0    | 0    | 0    | 0    | 0    | 0    | 0    | 0    | 0    | 0    | 0    |
| 2020 | 0    | 0    | 0    | 10   | 0    | 0    | 0    | 0    | 0    | 0    | 0    | 0    |
| 2021 | 0    | 0    | 0    | 21   | 0    | 0    | 0    | 0    | 0    | 0    | 0    | 0    |
| 2022 | 0    | 0    | 0    | 58   | 0    | 0    | 0    | 0    | 0    | 0    | 0    | 0    |
| 2023 | 0    | 0    | 0    | 125  | 0    | 0    | 0    | 0    | 0    | 0    | 0    | 0    |
| 2024 | 0    | 0    | 0    | 165  | 0    | 0    | 0    | 0    | 0    | 0    | 0    | 0    |
| 2025 | 17   | 17   | 0    | 219  | 12   | 63   | 64   | 1    | 17   | 256  | 256  | 0    |
| 2026 | 52   | 164  | 0    | 271  | 73   | 276  | 273  | 1    | 137  | 477  | 513  | 0    |
| 2027 | 94   | 289  | 0    | 321  | 135  | 444  | 478  | 2    | 234  | 722  | 818  | 0    |
| 2028 | 146  | 411  | 0    | 377  | 191  | 675  | 698  | 20   | 317  | 944  | 1092 | 0    |
| 2029 | 210  | 520  | 0    | 446  | 236  | 845  | 862  | 33   | 406  | 1175 | 1388 | 0    |
| 2030 | 289  | 641  | 10   | 532  | 295  | 967  | 1007 | 57   | 508  | 1422 | 1692 | 256  |
| 2031 | 357  | 732  | 191  | 614  | 358  | 1118 | 1170 | 82   | 593  | 1670 | 1978 | 518  |
| 2032 | 427  | 840  | 373  | 713  | 414  | 1248 | 1345 | 115  | 694  | 1893 | 2254 | 792  |
| 2033 | 496  | 947  | 524  | 782  | 484  | 1350 | 1497 | 153  | 780  | 2128 | 2541 | 1103 |
| 2034 | 589  | 1080 | 673  | 899  | 548  | 1488 | 1673 | 202  | 883  | 2377 | 2830 | 1394 |
| 2035 | 660  | 1168 | 790  | 984  | 608  | 1608 | 1859 | 242  | 962  | 2625 | 3098 | 1731 |
| 2036 | 734  | 1272 | 902  | 1075 | 673  | 1732 | 2024 | 282  | 1043 | 2915 | 3406 | 2038 |
| 2037 | 820  | 1359 | 1019 | 1146 | 740  | 1867 | 2217 | 335  | 1132 | 3180 | 3688 | 2330 |
| 2038 | 907  | 1458 | 1168 | 1240 | 793  | 2002 | 2387 | 393  | 1232 | 3479 | 4002 | 2592 |
| 2039 | 996  | 1552 | 1272 | 1303 | 832  | 2129 | 2555 | 423  | 1313 | 3793 | 4332 | 2866 |
| 2040 | 1098 | 1664 | 1381 | 1382 | 885  | 2297 | 2737 | 474  | 1414 | 4105 | 4667 | 3128 |
| 2041 | 1169 | 1759 | 1522 | 1506 | 936  | 2463 | 2937 | 535  | 1499 | 4458 | 5043 | 3404 |
| 2042 | 1279 | 1890 | 1618 | 1674 | 1013 | 2652 | 3169 | 591  | 1615 | 4710 | 5300 | 3667 |
| 2043 | 1364 | 1966 | 1738 | 1712 | 1086 | 2802 | 3350 | 643  | 1703 | 5041 | 5645 | 3949 |
| 2044 | 1431 | 2060 | 1840 | 1743 | 1143 | 2951 | 3543 | 689  | 1783 | 5363 | 5990 | 4226 |
| 2045 | 1502 | 2143 | 1896 | 1890 | 1183 | 3083 | 3682 | 734  | 1867 | 5382 | 6031 | 4595 |
| 2046 | 1518 | 2164 | 2006 | 1915 | 1191 | 3113 | 3709 | 761  | 1894 | 5485 | 6248 | 4888 |
| 2047 | 1725 | 2414 | 2074 | 1915 | 1426 | 3349 | 3941 | 993  | 2126 | 5557 | 6411 | 5197 |
| 2048 | 1840 | 2640 | 2095 | 1915 | 1632 | 3539 | 4143 | 1195 | 2328 | 5625 | 6573 | 5247 |
| 2049 | 1893 | 2843 | 2331 | 1915 | 1779 | 3645 | 4289 | 1341 | 2474 | 5666 | 6679 | 5434 |
| 2050 | 1893 | 2961 | 2548 | 1915 | 1848 | 3696 | 4359 | 1411 | 2544 | 5693 | 6752 | 5612 |
| 2051 | 1893 | 3024 | 2781 | 1915 | 1876 | 3718 | 4389 | 1441 | 2574 | 5718 | 6815 | 5779 |
| 2052 | 1893 | 3064 | 2970 | 1915 | 1879 | 3720 | 4392 | 1444 | 2577 | 5730 | 6853 | 5907 |
| 2053 | 1893 | 3081 | 3100 | 1915 | 1879 | 3720 | 4392 | 1444 | 2577 | 5733 | 6862 | 6036 |
| 2054 | 1893 | 3089 | 3183 | 1915 | 1879 | 3720 | 4392 | 1444 | 2577 | 5734 | 6865 | 6150 |
| 2055 | 1893 | 3089 | 3233 | 1915 | 1879 | 3720 | 4392 | 1444 | 2577 | 5737 | 6872 | 6241 |
| 2056 | 1893 | 3089 | 3246 | 1915 | 1879 | 3720 | 4392 | 1444 | 2577 | 5737 | 6872 | 6317 |
| 2057 | 1893 | 3089 | 3247 | 1915 | 1879 | 3720 | 4392 | 1444 | 2577 | 5737 | 6872 | 6369 |
| 2058 | 1893 | 3089 | 3247 | 1915 | 1879 | 3720 | 4392 | 1444 | 2577 | 5737 | 6872 | 6404 |
| 2059 | 1893 | 3089 | 3247 | 1915 | 1879 | 3720 | 4392 | 1444 | 2577 | 5737 | 6872 | 6427 |

|      | 73   | 74   | 75   | 76   | 77   | 78   | 79   | 80   | 81   | 82   | 83   | 84   |
|------|------|------|------|------|------|------|------|------|------|------|------|------|
| 2060 | 1893 | 3089 | 3247 | 1915 | 1879 | 3720 | 4392 | 1444 | 2577 | 5737 | 6872 | 6432 |
| 2061 | 1893 | 3089 | 3247 | 1915 | 1879 | 3720 | 4392 | 1444 | 2577 | 5737 | 6872 | 6435 |
| 2062 | 1893 | 3089 | 3247 | 1915 | 1879 | 3720 | 4392 | 1444 | 2577 | 5737 | 6872 | 6435 |
| 2063 | 1893 | 3089 | 3247 | 1915 | 1879 | 3720 | 4392 | 1444 | 2577 | 5737 | 6872 | 6435 |
| 2064 | 1893 | 3089 | 3247 | 1915 | 1879 | 3720 | 4392 | 1444 | 2577 | 5737 | 6872 | 6435 |
| 2065 | 1893 | 3089 | 3247 | 1915 | 1879 | 3720 | 4392 | 1444 | 2577 | 5737 | 6872 | 6435 |
| 2066 | 1893 | 3089 | 3247 | 1915 | 1879 | 3720 | 4392 | 1444 | 2577 | 5737 | 6872 | 6435 |
| 2067 | 1893 | 3089 | 3247 | 1915 | 1879 | 3720 | 4392 | 1444 | 2577 | 5737 | 6872 | 6435 |
| 2068 | 1893 | 3089 | 3247 | 1915 | 1879 | 3720 | 4392 | 1444 | 2577 | 5737 | 6872 | 6435 |
| 2069 | 1893 | 3089 | 3247 | 1915 | 1879 | 3720 | 4392 | 1444 | 2577 | 5737 | 6872 | 6435 |
| 2070 | 1893 | 3089 | 3247 | 1915 | 1879 | 3720 | 4392 | 1444 | 2577 | 5737 | 6872 | 6435 |
| 2071 | 1893 | 3089 | 3247 | 1915 | 1879 | 3720 | 4392 | 1444 | 2577 | 5737 | 6872 | 6435 |
| 2072 | 1893 | 3089 | 3247 | 1915 | 1879 | 3720 | 4392 | 1444 | 2577 | 5737 | 6872 | 6435 |
| 2073 | 1893 | 3089 | 3247 | 1915 | 1879 | 3720 | 4392 | 1444 | 2577 | 5737 | 6872 | 6435 |
| 2074 | 1893 | 3089 | 3247 | 1915 | 1879 | 3720 | 4392 | 1444 | 2577 | 5737 | 6872 | 6435 |
| 2075 | 1893 | 3089 | 3247 | 1915 | 1879 | 3720 | 4392 | 1444 | 2577 | 5737 | 6872 | 6435 |
| 2076 | 1893 | 3089 | 3247 | 1915 | 1879 | 3720 | 4392 | 1444 | 2577 | 5737 | 6872 | 6435 |
| 2077 | 1893 | 3089 | 3247 | 1915 | 1879 | 3720 | 4392 | 1444 | 2577 | 5737 | 6872 | 6435 |
| 2078 | 1893 | 3089 | 3247 | 1915 | 1879 | 3720 | 4392 | 1444 | 2577 | 5737 | 6872 | 6435 |
| 2079 | 1893 | 3089 | 3247 | 1915 | 1879 | 3720 | 4392 | 1444 | 2577 | 5737 | 6872 | 6435 |
| 2080 | 1893 | 3089 | 3247 | 1915 | 1879 | 3720 | 4392 | 1444 | 2577 | 5737 | 6872 | 6435 |
| 2081 | 1893 | 3089 | 3247 | 1915 | 1879 | 3720 | 4392 | 1444 | 2577 | 5737 | 6872 | 6435 |
| 2082 | 1893 | 3089 | 3247 | 1915 | 1879 | 3720 | 4392 | 1444 | 2577 | 5737 | 6872 | 6435 |
| 2083 | 1893 | 3089 | 3247 | 1915 | 1879 | 3720 | 4392 | 1444 | 2577 | 5737 | 6872 | 6435 |
| 2084 | 1893 | 3089 | 3247 | 1915 | 1879 | 3720 | 4392 | 1444 | 2577 | 5737 | 6872 | 6435 |
| 2085 | 1893 | 3089 | 3247 | 1915 | 1879 | 3720 | 4392 | 1444 | 2577 | 5737 | 6872 | 6435 |
| 2086 | 1893 | 3089 | 3247 | 1915 | 1879 | 3720 | 4392 | 1444 | 2577 | 5737 | 6872 | 6435 |
| 2087 | 1893 | 3089 | 3247 | 1915 | 1879 | 3720 | 4392 | 1444 | 2577 | 5737 | 6872 | 6435 |
| 2088 | 1893 | 3089 | 3247 | 1915 | 1879 | 3720 | 4392 | 1444 | 2577 | 5737 | 6872 | 6435 |
| 2089 | 1893 | 3089 | 3247 | 1915 | 1879 | 3720 | 4392 | 1444 | 2577 | 5737 | 6872 | 6435 |
| 2090 | 1893 | 3089 | 3247 | 1915 | 1879 | 3720 | 4392 | 1444 | 2577 | 5737 | 6872 | 6435 |

|      | 85   | 86   | 87   | 88   | 89   | 90   | 91   | 92   | 93   | 94   | 95   | 96   |
|------|------|------|------|------|------|------|------|------|------|------|------|------|
| 2002 | 0    | 0    | 0    | 0    | 0    | 0    | 0    | 0    | 0    | 0    | 0    | 0    |
| 2003 | 0    | 0    | 0    | 0    | 0    | 0    | 0    | 0    | 0    | 0    | 0    | 0    |
| 2004 | 0    | 0    | 0    | 0    | 0    | 0    | 0    | 0    | 0    | 0    | 0    | 0    |
| 2005 | 0    | 0    | 0    | 0    | 0    | 0    | 0    | 0    | 0    | 0    | 0    | 0    |
| 2006 | 0    | 0    | 0    | 0    | 0    | 0    | 0    | 0    | 0    | 0    | 0    | 0    |
| 2007 | 0    | 0    | 0    | 0    | 0    | 0    | 0    | 0    | 0    | 0    | 0    | 0    |
| 2008 | 0    | 0    | 0    | 0    | 0    | 0    | 0    | 0    | 0    | 0    | 0    | 0    |
| 2009 | 0    | 0    | 0    | 0    | 0    | 0    | 0    | 0    | 0    | 0    | 0    | 0    |
| 2010 | 0    | 0    | 0    | 0    | 0    | 0    | 0    | 0    | 0    | 0    | 0    | 0    |
| 2011 | 0    | 0    | 0    | 0    | 0    | 0    | 0    | 0    | 0    | 0    | 0    | 0    |
| 2012 | 0    | 0    | 0    | 0    | 0    | 0    | 0    | 0    | 0    | 0    | 0    | 0    |
| 2013 | 0    | 0    | 0    | 0    | 0    | 0    | 0    | 0    | 0    | 0    | 0    | 0    |
| 2014 | 0    | 0    | 0    | 0    | 0    | 0    | 0    | 0    | 0    | 0    | 0    | 0    |
| 2015 | 0    | 0    | 0    | 0    | 0    | 0    | 0    | 0    | 0    | 0    | 0    | 0    |
| 2016 | 0    | 0    | 0    | 0    | 0    | 0    | 0    | 0    | 0    | 0    | 0    | 0    |
| 2017 | 0    | 0    | 0    | 0    | 0    | 0    | 0    | 0    | 0    | 0    | 0    | 0    |
| 2018 | 0    | 0    | 0    | 0    | 0    | 0    | 0    | 0    | 0    | 0    | 0    | 0    |
| 2019 | 0    | 0    | 0    | 0    | 0    | 0    | 0    | 0    | 0    | 0    | 0    | 0    |
| 2020 | 254  | 0    | 0    | 0    | 0    | 0    | 0    | 0    | 0    | 90   | 0    | 0    |
| 2021 | 491  | 0    | 0    | 0    | 0    | 0    | 0    | 0    | 0    | 194  | 0    | 0    |
| 2022 | 756  | 0    | 0    | 0    | 0    | 0    | 0    | 0    | 0    | 336  | 0    | 0    |
| 2023 | 1011 | 0    | 0    | 0    | 0    | 0    | 0    | 0    | 0    | 468  | 0    | 0    |
| 2024 | 1264 | 0    | 0    | 0    | 0    | 0    | 0    | 0    | 0    | 603  | 0    | 0    |
| 2025 | 1524 | 256  | 256  | 256  | 256  | 256  | 71   | 71   | 0    | 730  | 64   | 174  |
| 2026 | 1806 | 502  | 502  | 502  | 502  | 502  | 176  | 267  | 0    | 874  | 207  | 405  |
| 2027 | 2063 | 788  | 788  | 788  | 788  | 788  | 282  | 443  | 0    | 1038 | 335  | 625  |
| 2028 | 2316 | 1040 | 1040 | 1040 | 1040 | 1040 | 414  | 643  | 0    | 1221 | 489  | 858  |
| 2029 | 2572 | 1311 | 1311 | 1311 | 1311 | 1311 | 525  | 816  | 0    | 1411 | 617  | 1059 |
| 2030 | 2876 | 1589 | 1589 | 1589 | 1589 | 1589 | 651  | 992  | 66   | 1600 | 782  | 1247 |
| 2031 | 3158 | 1860 | 1860 | 1860 | 1860 | 1860 | 825  | 1202 | 277  | 1773 | 967  | 1406 |
| 2032 | 3412 | 2106 | 2106 | 2106 | 2106 | 2106 | 977  | 1383 | 474  | 1988 | 1131 | 1585 |
| 2033 | 3725 | 2366 | 2366 | 2366 | 2365 | 2366 | 1150 | 1585 | 663  | 2151 | 1323 | 1744 |
| 2034 | 4060 | 2637 | 2637 | 2637 | 2631 | 2637 | 1332 | 1791 | 887  | 2371 | 1501 | 1930 |
| 2035 | 4339 | 2894 | 2894 | 2894 | 2879 | 2894 | 1518 | 1992 | 1090 | 2542 | 1704 | 2088 |
| 2036 | 4713 | 3198 | 3216 | 3198 | 3167 | 3198 | 1689 | 2181 | 1272 | 2677 | 1895 | 2290 |
| 2037 | 4968 | 3470 | 3495 | 3471 | 3407 | 3471 | 1848 | 2353 | 1453 | 2818 | 2054 | 2480 |
| 2038 | 5177 | 3779 | 3824 | 3782 | 3667 | 3782 | 2000 | 2521 | 1680 | 2963 | 2216 | 2646 |
| 2039 | 5440 | 4102 | 4097 | 4104 | 3905 | 4104 | 2147 | 2682 | 1884 | 3076 | 2358 | 2829 |
| 2040 | 5699 | 4418 | 4419 | 4429 | 4113 | 4429 | 2307 | 2852 | 2032 | 3164 | 2517 | 3012 |
| 2041 | 5888 | 4746 | 4725 | 4803 | 4369 | 4795 | 2458 | 3018 | 2242 | 3271 | 2693 | 3188 |
| 2042 | 5967 | 5055 | 5060 | 5069 | 4546 | 5052 | 2620 | 3201 | 2444 | 3378 | 2870 | 3371 |
| 2043 | 5973 | 5360 | 5389 | 5432 | 4830 | 5395 | 2775 | 3368 | 2628 | 3449 | 3031 | 3519 |
| 2044 | 6048 | 5681 | 5690 | 5789 | 5099 | 5728 | 2904 | 3506 | 2814 | 3503 | 3152 | 3657 |
| 2045 | 6083 | 5711 | 5711 | 5821 | 5131 | 5760 | 3004 | 3614 | 2972 | 3588 | 3256 | 3845 |
| 2046 | 6115 | 5879 | 5880 | 5990 | 5300 | 5929 | 3105 | 3720 | 3132 | 3613 | 3352 | 3989 |
| 2047 | 6140 | 5999 | 6004 | 6110 | 5420 | 6049 | 3174 | 3789 | 3272 | 3618 | 3370 | 4012 |
| 2048 | 6142 | 6117 | 6117 | 6227 | 5537 | 6166 | 3174 | 3789 | 3368 | 3742 | 3375 | 4191 |
| 2049 | 6146 | 6195 | 6195 | 6301 | 5611 | 6240 | 3280 | 4019 | 3377 | 3820 | 3556 | 4347 |
| 2050 | 6146 | 6246 | 6245 | 6349 | 5659 | 6288 | 3368 | 4225 | 3567 | 3854 | 3718 | 4474 |
| 2051 | 6146 | 6288 | 6288 | 6393 | 5703 | 6332 | 3452 | 4419 | 3744 | 3869 | 3865 | 4546 |
| 2052 | 6146 | 6318 | 6315 | 6419 | 5729 | 6358 | 3509 | 4552 | 3927 | 3877 | 3971 | 4588 |
| 2053 | 6146 | 6329 | 6323 | 6425 | 5735 | 6364 | 3537 | 4626 | 4095 | 3885 | 4027 | 4613 |
| 2054 | 6146 | 6332 | 6325 | 6427 | 5737 | 6366 | 3553 | 4665 | 4246 | 3885 | 4057 | 4633 |
| 2055 | 6146 | 6335 | 6330 | 6432 | 5742 | 6371 | 3564 | 4695 | 4369 | 3885 | 4077 | 4644 |
| 2056 | 6146 | 6335 | 6330 | 6432 | 5742 | 6371 | 3570 | 4710 | 4450 | 3885 | 4088 | 4650 |
| 2057 | 6146 | 6335 | 6330 | 6432 | 5742 | 6371 | 3573 | 4718 | 4494 | 3885 | 4094 | 4654 |
| 2058 | 6146 | 6335 | 6330 | 6432 | 5742 | 6371 | 3575 | 4724 | 4521 | 3885 | 4098 | 4654 |
| 2059 | 6146 | 6335 | 6330 | 6432 | 5742 | 6371 | 3575 | 4724 | 4534 | 3885 | 4098 | 4654 |

|      | 85   | 86   | 87   | 88   | 89   | 90   | 91   | 92   | 93   | 94   | 95   | 96   |
|------|------|------|------|------|------|------|------|------|------|------|------|------|
| 2060 | 6146 | 6335 | 6330 | 6432 | 5742 | 6371 | 3575 | 4724 | 4544 | 3885 | 4098 | 4654 |
| 2061 | 6146 | 6335 | 6330 | 6432 | 5742 | 6371 | 3575 | 4724 | 4550 | 3885 | 4098 | 4654 |
| 2062 | 6146 | 6335 | 6330 | 6432 | 5742 | 6371 | 3575 | 4724 | 4554 | 3885 | 4098 | 4654 |
| 2063 | 6146 | 6335 | 6330 | 6432 | 5742 | 6371 | 3575 | 4724 | 4554 | 3885 | 4098 | 4654 |
| 2064 | 6146 | 6335 | 6330 | 6432 | 5742 | 6371 | 3575 | 4724 | 4554 | 3885 | 4098 | 4654 |
| 2065 | 6146 | 6335 | 6330 | 6432 | 5742 | 6371 | 3575 | 4724 | 4554 | 3885 | 4098 | 4654 |
| 2066 | 6146 | 6335 | 6330 | 6432 | 5742 | 6371 | 3575 | 4724 | 4554 | 3885 | 4098 | 4654 |
| 2067 | 6146 | 6335 | 6330 | 6432 | 5742 | 6371 | 3575 | 4724 | 4554 | 3885 | 4098 | 4654 |
| 2068 | 6146 | 6335 | 6330 | 6432 | 5742 | 6371 | 3575 | 4724 | 4554 | 3885 | 4098 | 4654 |
| 2069 | 6146 | 6335 | 6330 | 6432 | 5742 | 6371 | 3575 | 4724 | 4554 | 3885 | 4098 | 4654 |
| 2070 | 6146 | 6335 | 6330 | 6432 | 5742 | 6371 | 3575 | 4724 | 4554 | 3885 | 4098 | 4654 |
| 2071 | 6146 | 6335 | 6330 | 6432 | 5742 | 6371 | 3575 | 4724 | 4554 | 3885 | 4098 | 4654 |
| 2072 | 6146 | 6335 | 6330 | 6432 | 5742 | 6371 | 3575 | 4724 | 4554 | 3885 | 4098 | 4654 |
| 2073 | 6146 | 6335 | 6330 | 6432 | 5742 | 6371 | 3575 | 4724 | 4554 | 3885 | 4098 | 4654 |
| 2074 | 6146 | 6335 | 6330 | 6432 | 5742 | 6371 | 3575 | 4724 | 4554 | 3885 | 4098 | 4654 |
| 2075 | 6146 | 6335 | 6330 | 6432 | 5742 | 6371 | 3575 | 4724 | 4554 | 3885 | 4098 | 4654 |
| 2076 | 6146 | 6335 | 6330 | 6432 | 5742 | 6371 | 3575 | 4724 | 4554 | 3885 | 4098 | 4654 |
| 2077 | 6146 | 6335 | 6330 | 6432 | 5742 | 6371 | 3575 | 4724 | 4554 | 3885 | 4098 | 4654 |
| 2078 | 6146 | 6335 | 6330 | 6432 | 5742 | 6371 | 3575 | 4724 | 4554 | 3885 | 4098 | 4654 |
| 2079 | 6146 | 6335 | 6330 | 6432 | 5742 | 6371 | 3575 | 4724 | 4554 | 3885 | 4098 | 4654 |
| 2080 | 6146 | 6335 | 6330 | 6432 | 5742 | 6371 | 3575 | 4724 | 4554 | 3885 | 4098 | 4654 |
| 2081 | 6146 | 6335 | 6330 | 6432 | 5742 | 6371 | 3575 | 4724 | 4554 | 3885 | 4098 | 4654 |
| 2082 | 6146 | 6335 | 6330 | 6432 | 5742 | 6371 | 3575 | 4724 | 4554 | 3885 | 4098 | 4654 |
| 2083 | 6146 | 6335 | 6330 | 6432 | 5742 | 6371 | 3575 | 4724 | 4554 | 3885 | 4098 | 4654 |
| 2084 | 6146 | 6335 | 6330 | 6432 | 5742 | 6371 | 3575 | 4724 | 4554 | 3885 | 4098 | 4654 |
| 2085 | 6146 | 6335 | 6330 | 6432 | 5742 | 6371 | 3575 | 4724 | 4554 | 3885 | 4098 | 4654 |
| 2086 | 6146 | 6335 | 6330 | 6432 | 5742 | 6371 | 3575 | 4724 | 4554 | 3885 | 4098 | 4654 |
| 2087 | 6146 | 6335 | 6330 | 6432 | 5742 | 6371 | 3575 | 4724 | 4554 | 3885 | 4098 | 4654 |
| 2088 | 6146 | 6335 | 6330 | 6432 | 5742 | 6371 | 3575 | 4724 | 4554 | 3885 | 4098 | 4654 |
| 2089 | 6146 | 6335 | 6330 | 6432 | 5742 | 6371 | 3575 | 4724 | 4554 | 3885 | 4098 | 4654 |
| 2090 | 6146 | 6335 | 6330 | 6432 | 5742 | 6371 | 3575 | 4724 | 4554 | 3885 | 4098 | 4654 |



|      | 97   | 98   | 99   | 100  | 101  | 102  | 103  | 104  | 105  | 106  | 107  | 108  |
|------|------|------|------|------|------|------|------|------|------|------|------|------|
| 2002 | 0    | 0    | 0    | 0    | 0    | 0    | 0    | 0    | 0    | 0    | 0    | 0    |
| 2003 | 0    | 0    | 0    | 0    | 0    | 0    | 0    | 0    | 0    | 0    | 0    | 0    |
| 2004 | 0    | 0    | 0    | 0    | 0    | 0    | 0    | 0    | 0    | 0    | 0    | 0    |
| 2005 | 0    | 0    | 0    | 0    | 0    | 0    | 0    | 0    | 0    | 0    | 0    | 0    |
| 2006 | 0    | 0    | 0    | 0    | 0    | 0    | 0    | 0    | 0    | 0    | 0    | 0    |
| 2007 | 0    | 0    | 0    | 0    | 0    | 0    | 0    | 0    | 0    | 0    | 0    | 0    |
| 2008 | 0    | 0    | 0    | 0    | 0    | 0    | 0    | 0    | 0    | 0    | 0    | 0    |
| 2009 | 0    | 0    | 0    | 0    | 0    | 0    | 0    | 0    | 0    | 0    | 0    | 0    |
| 2010 | 0    | 0    | 0    | 0    | 0    | 0    | 0    | 0    | 0    | 0    | 0    | 0    |
| 2011 | 0    | 0    | 0    | 0    | 0    | 0    | 0    | 0    | 0    | 0    | 0    | 0    |
| 2012 | 0    | 0    | 0    | 0    | 0    | 0    | 0    | 0    | 0    | 0    | 0    | 0    |
| 2013 | 0    | 0    | 0    | 0    | 0    | 0    | 0    | 0    | 0    | 0    | 0    | 0    |
| 2014 | 0    | 0    | 0    | 0    | 0    | 0    | 0    | 0    | 0    | 0    | 0    | 0    |
| 2015 | 0    | 0    | 0    | 0    | 0    | 0    | 0    | 0    | 0    | 0    | 0    | 0    |
| 2016 | 0    | 0    | 0    | 0    | 0    | 0    | 0    | 0    | 0    | 0    | 0    | 0    |
| 2017 | 0    | 0    | 0    | 0    | 0    | 0    | 0    | 0    | 0    | 0    | 0    | 0    |
| 2018 | 0    | 0    | 0    | 0    | 0    | 0    | 0    | 0    | 0    | 0    | 0    | 0    |
| 2019 | 0    | 0    | 0    | 0    | 0    | 0    | 0    | 0    | 0    | 0    | 0    | 0    |
| 2020 | 0    | 0    | 0    | 0    | 0    | 0    | 10   | 0    | 0    | 0    | 0    | 0    |
| 2021 | 0    | 0    | 0    | 0    | 0    | 0    | 21   | 0    | 0    | 0    | 0    | 0    |
| 2022 | 0    | 0    | 0    | 0    | 0    | 0    | 57   | 0    | 0    | 0    | 0    | 0    |
| 2023 | 0    | 0    | 0    | 0    | 0    | 0    | 121  | 0    | 0    | 0    | 0    | 0    |
| 2024 | 0    | 0    | 0    | 0    | 0    | 0    | 166  | 0    | 0    | 0    | 0    | 0    |
| 2025 | 244  | 4    | 71   | 17   | 17   | 0    | 216  | 12   | 63   | 64   | 1    | 17   |
| 2026 | 537  | 15   | 236  | 43   | 149  | 0    | 275  | 64   | 238  | 230  | 1    | 111  |
| 2027 | 829  | 27   | 381  | 78   | 257  | 0    | 335  | 113  | 377  | 392  | 2    | 185  |
| 2028 | 1134 | 58   | 558  | 125  | 371  | 0    | 389  | 165  | 583  | 581  | 19   | 272  |
| 2029 | 1419 | 99   | 702  | 180  | 486  | 0    | 459  | 213  | 762  | 744  | 28   | 356  |
| 2030 | 1695 | 146  | 851  | 254  | 613  | 10   | 549  | 260  | 901  | 896  | 52   | 456  |
| 2031 | 1969 | 204  | 1042 | 317  | 713  | 157  | 614  | 310  | 1052 | 1063 | 75   | 536  |
| 2032 | 2232 | 267  | 1211 | 397  | 820  | 305  | 709  | 373  | 1200 | 1235 | 103  | 631  |
| 2033 | 2491 | 325  | 1397 | 474  | 924  | 431  | 781  | 437  | 1307 | 1393 | 141  | 721  |
| 2034 | 2790 | 389  | 1593 | 578  | 1050 | 575  | 894  | 518  | 1454 | 1581 | 187  | 837  |
| 2035 | 3066 | 449  | 1789 | 659  | 1145 | 716  | 976  | 587  | 1572 | 1772 | 228  | 927  |
| 2036 | 3308 | 541  | 1970 | 747  | 1255 | 834  | 1081 | 669  | 1711 | 1949 | 273  | 1027 |
| 2037 | 3523 | 606  | 2136 | 824  | 1340 | 953  | 1167 | 742  | 1842 | 2139 | 322  | 1108 |
| 2038 | 3738 | 682  | 2296 | 917  | 1452 | 1106 | 1249 | 803  | 1978 | 2318 | 378  | 1211 |
| 2039 | 3941 | 736  | 2449 | 1011 | 1561 | 1227 | 1309 | 850  | 2081 | 2501 | 424  | 1312 |
| 2040 | 4167 | 787  | 2614 | 1114 | 1676 | 1332 | 1378 | 907  | 2253 | 2693 | 479  | 1421 |
| 2041 | 4397 | 870  | 2773 | 1183 | 1756 | 1468 | 1473 | 967  | 2400 | 2897 | 529  | 1496 |
| 2042 | 4632 | 941  | 2945 | 1293 | 1888 | 1578 | 1612 | 1041 | 2614 | 3136 | 585  | 1616 |
| 2043 | 4824 | 999  | 3107 | 1384 | 1984 | 1707 | 1676 | 1119 | 2759 | 3318 | 643  | 1710 |
| 2044 | 4978 | 1040 | 3240 | 1468 | 2073 | 1816 | 1697 | 1181 | 2923 | 3519 | 682  | 1797 |
| 2045 | 5117 | 1098 | 3344 | 1554 | 2167 | 1896 | 1800 | 1247 | 3074 | 3667 | 733  | 1889 |
| 2046 | 5239 | 1138 | 3447 | 1568 | 2200 | 2010 | 1868 | 1258 | 3097 | 3692 | 758  | 1914 |
| 2047 | 5360 | 1163 | 3516 | 1668 | 2418 | 2115 | 1900 | 1433 | 3268 | 3862 | 928  | 2084 |
| 2048 | 5360 | 1163 | 3516 | 1753 | 2624 | 2135 | 1914 | 1587 | 3425 | 4017 | 1083 | 2239 |
| 2049 | 5542 | 1345 | 3698 | 1839 | 2823 | 2159 | 1923 | 1734 | 3559 | 4169 | 1235 | 2391 |
| 2050 | 5700 | 1503 | 3856 | 1894 | 2953 | 2353 | 1927 | 1831 | 3636 | 4263 | 1329 | 2485 |
| 2051 | 5847 | 1650 | 4003 | 1924 | 3029 | 2524 | 1930 | 1886 | 3668 | 4317 | 1383 | 2539 |
| 2052 | 5943 | 1746 | 4099 | 1940 | 3069 | 2700 | 1930 | 1915 | 3693 | 4346 | 1412 | 2568 |
| 2053 | 5997 | 1800 | 4153 | 1951 | 3099 | 2876 | 1930 | 1935 | 3713 | 4366 | 1432 | 2588 |
| 2054 | 6025 | 1828 | 4181 | 1957 | 3114 | 3032 | 1930 | 1946 | 3724 | 4377 | 1443 | 2599 |
| 2055 | 6045 | 1848 | 4201 | 1960 | 3122 | 3145 | 1930 | 1952 | 3730 | 4383 | 1449 | 2605 |
| 2056 | 6056 | 1859 | 4212 | 1962 | 3128 | 3217 | 1930 | 1952 | 3734 | 4387 | 1453 | 2609 |
| 2057 | 6062 | 1865 | 4218 | 1962 | 3128 | 3255 | 1930 | 1952 | 3734 | 4387 | 1453 | 2609 |
| 2058 | 6066 | 1869 | 4222 | 1962 | 3128 | 3285 | 1930 | 1952 | 3734 | 4387 | 1453 | 2609 |
| 2059 | 6066 | 1869 | 4222 | 1962 | 3128 | 3298 | 1930 | 1952 | 3734 | 4387 | 1453 | 2609 |

|      | 97   | 98   | 99   | 100  | 101  | 102  | 103  | 104  | 105  | 106  | 107  | 108  |
|------|------|------|------|------|------|------|------|------|------|------|------|------|
| 2060 | 6066 | 1869 | 4222 | 1962 | 3128 | 3308 | 1930 | 1952 | 3734 | 4387 | 1453 | 2609 |
| 2061 | 6066 | 1869 | 4222 | 1962 | 3128 | 3314 | 1930 | 1952 | 3734 | 4387 | 1453 | 2609 |
| 2062 | 6066 | 1869 | 4222 | 1962 | 3128 | 3318 | 1930 | 1952 | 3734 | 4387 | 1453 | 2609 |
| 2063 | 6066 | 1869 | 4222 | 1962 | 3128 | 3318 | 1930 | 1952 | 3734 | 4387 | 1453 | 2609 |
| 2064 | 6066 | 1869 | 4222 | 1962 | 3128 | 3318 | 1930 | 1952 | 3734 | 4387 | 1453 | 2609 |
| 2065 | 6066 | 1869 | 4222 | 1962 | 3128 | 3318 | 1930 | 1952 | 3734 | 4387 | 1453 | 2609 |
| 2066 | 6066 | 1869 | 4222 | 1962 | 3128 | 3318 | 1930 | 1952 | 3734 | 4387 | 1453 | 2609 |
| 2067 | 6066 | 1869 | 4222 | 1962 | 3128 | 3318 | 1930 | 1952 | 3734 | 4387 | 1453 | 2609 |
| 2068 | 6066 | 1869 | 4222 | 1962 | 3128 | 3318 | 1930 | 1952 | 3734 | 4387 | 1453 | 2609 |
| 2069 | 6066 | 1869 | 4222 | 1962 | 3128 | 3318 | 1930 | 1952 | 3734 | 4387 | 1453 | 2609 |
| 2070 | 6066 | 1869 | 4222 | 1962 | 3128 | 3318 | 1930 | 1952 | 3734 | 4387 | 1453 | 2609 |
| 2071 | 6066 | 1869 | 4222 | 1962 | 3128 | 3318 | 1930 | 1952 | 3734 | 4387 | 1453 | 2609 |
| 2072 | 6066 | 1869 | 4222 | 1962 | 3128 | 3318 | 1930 | 1952 | 3734 | 4387 | 1453 | 2609 |
| 2073 | 6066 | 1869 | 4222 | 1962 | 3128 | 3318 | 1930 | 1952 | 3734 | 4387 | 1453 | 2609 |
| 2074 | 6066 | 1869 | 4222 | 1962 | 3128 | 3318 | 1930 | 1952 | 3734 | 4387 | 1453 | 2609 |
| 2075 | 6066 | 1869 | 4222 | 1962 | 3128 | 3318 | 1930 | 1952 | 3734 | 4387 | 1453 | 2609 |
| 2076 | 6066 | 1869 | 4222 | 1962 | 3128 | 3318 | 1930 | 1952 | 3734 | 4387 | 1453 | 2609 |
| 2077 | 6066 | 1869 | 4222 | 1962 | 3128 | 3318 | 1930 | 1952 | 3734 | 4387 | 1453 | 2609 |
| 2078 | 6066 | 1869 | 4222 | 1962 | 3128 | 3318 | 1930 | 1952 | 3734 | 4387 | 1453 | 2609 |
| 2079 | 6066 | 1869 | 4222 | 1962 | 3128 | 3318 | 1930 | 1952 | 3734 | 4387 | 1453 | 2609 |
| 2080 | 6066 | 1869 | 4222 | 1962 | 3128 | 3318 | 1930 | 1952 | 3734 | 4387 | 1453 | 2609 |
| 2081 | 6066 | 1869 | 4222 | 1962 | 3128 | 3318 | 1930 | 1952 | 3734 | 4387 | 1453 | 2609 |
| 2082 | 6066 | 1869 | 4222 | 1962 | 3128 | 3318 | 1930 | 1952 | 3734 | 4387 | 1453 | 2609 |
| 2083 | 6066 | 1869 | 4222 | 1962 | 3128 | 3318 | 1930 | 1952 | 3734 | 4387 | 1453 | 2609 |
| 2084 | 6066 | 1869 | 4222 | 1962 | 3128 | 3318 | 1930 | 1952 | 3734 | 4387 | 1453 | 2609 |
| 2085 | 6066 | 1869 | 4222 | 1962 | 3128 | 3318 | 1930 | 1952 | 3734 | 4387 | 1453 | 2609 |
| 2086 | 6066 | 1869 | 4222 | 1962 | 3128 | 3318 | 1930 | 1952 | 3734 | 4387 | 1453 | 2609 |
| 2087 | 6066 | 1869 | 4222 | 1962 | 3128 | 3318 | 1930 | 1952 | 3734 | 4387 | 1453 | 2609 |
| 2088 | 6066 | 1869 | 4222 | 1962 | 3128 | 3318 | 1930 | 1952 | 3734 | 4387 | 1453 | 2609 |
| 2089 | 6066 | 1869 | 4222 | 1962 | 3128 | 3318 | 1930 | 1952 | 3734 | 4387 | 1453 | 2609 |
| 2090 | 6066 | 1869 | 4222 | 1962 | 3128 | 3318 | 1930 | 1952 | 3734 | 4387 | 1453 | 2609 |

|      | 109  | 110  | 111  | 112  | 113  | 114  | 115  | 116  | 117  | 118  | 119  | 120  |
|------|------|------|------|------|------|------|------|------|------|------|------|------|
| 2002 | 0    | 0    | 0    | 0    | 0    | 0    | 0    | 0    | 0    | 0    | 0    | 0    |
| 2003 | 0    | 0    | 0    | 0    | 0    | 0    | 0    | 0    | 0    | 0    | 0    | 0    |
| 2004 | 0    | 0    | 0    | 0    | 0    | 0    | 0    | 0    | 0    | 0    | 0    | 0    |
| 2005 | 0    | 0    | 0    | 0    | 0    | 0    | 0    | 0    | 0    | 0    | 0    | 0    |
| 2006 | 0    | 0    | 0    | 0    | 0    | 0    | 0    | 0    | 0    | 0    | 0    | 0    |
| 2007 | 0    | 0    | 0    | 0    | 0    | 0    | 0    | 0    | 0    | 0    | 0    | 0    |
| 2008 | 0    | 0    | 0    | 0    | 0    | 0    | 0    | 0    | 0    | 0    | 0    | 0    |
| 2009 | 0    | 0    | 0    | 0    | 0    | 0    | 0    | 0    | 0    | 0    | 0    | 0    |
| 2010 | 0    | 0    | 0    | 0    | 0    | 0    | 0    | 0    | 0    | 0    | 0    | 0    |
| 2011 | 0    | 0    | 0    | 0    | 0    | 0    | 0    | 0    | 0    | 0    | 0    | 0    |
| 2012 | 0    | 0    | 0    | 0    | 0    | 0    | 0    | 0    | 0    | 0    | 0    | 0    |
| 2013 | 0    | 0    | 0    | 0    | 0    | 0    | 0    | 0    | 0    | 0    | 0    | 0    |
| 2014 | 0    | 0    | 0    | 0    | 0    | 0    | 0    | 0    | 0    | 0    | 0    | 0    |
| 2015 | 0    | 0    | 0    | 0    | 0    | 0    | 0    | 0    | 0    | 0    | 0    | 0    |
| 2016 | 0    | 0    | 0    | 0    | 0    | 0    | 0    | 0    | 0    | 0    | 0    | 0    |
| 2017 | 0    | 0    | 0    | 0    | 0    | 0    | 0    | 0    | 0    | 0    | 0    | 0    |
| 2018 | 0    | 0    | 0    | 0    | 0    | 0    | 0    | 0    | 0    | 0    | 0    | 0    |
| 2019 | 0    | 0    | 0    | 0    | 0    | 0    | 0    | 0    | 0    | 0    | 0    | 0    |
| 2020 | 0    | 0    | 0    | 254  | 0    | 0    | 0    | 0    | 0    | 0    | 0    | 0    |
| 2021 | 0    | 0    | 0    | 506  | 0    | 0    | 0    | 0    | 0    | 0    | 0    | 0    |
| 2022 | 0    | 0    | 0    | 760  | 0    | 0    | 0    | 0    | 0    | 0    | 0    | 0    |
| 2023 | 0    | 0    | 0    | 1017 | 0    | 0    | 0    | 0    | 0    | 0    | 0    | 0    |
| 2024 | 0    | 0    | 0    | 1268 | 0    | 0    | 0    | 0    | 0    | 0    | 0    | 0    |
| 2025 | 256  | 256  | 0    | 1537 | 256  | 256  | 256  | 256  | 256  | 71   | 71   | 0    |
| 2026 | 506  | 506  | 0    | 1793 | 506  | 506  | 506  | 506  | 506  | 160  | 160  | 0    |
| 2027 | 757  | 757  | 0    | 2050 | 757  | 757  | 757  | 757  | 757  | 244  | 254  | 0    |
| 2028 | 1011 | 1011 | 0    | 2304 | 1011 | 1011 | 1011 | 1011 | 1011 | 350  | 360  | 0    |
| 2029 | 1261 | 1261 | 0    | 2588 | 1261 | 1261 | 1261 | 1261 | 1261 | 447  | 460  | 0    |
| 2030 | 1513 | 1513 | 256  | 2854 | 1513 | 1513 | 1513 | 1513 | 1513 | 575  | 596  | 66   |
| 2031 | 1771 | 1771 | 509  | 3112 | 1771 | 1771 | 1771 | 1771 | 1771 | 733  | 769  | 167  |
| 2032 | 2027 | 2027 | 759  | 3394 | 2027 | 2036 | 2027 | 2020 | 2027 | 875  | 935  | 269  |
| 2033 | 2277 | 2292 | 1016 | 3684 | 2277 | 2289 | 2286 | 2274 | 2286 | 1040 | 1122 | 391  |
| 2034 | 2540 | 2555 | 1271 | 3924 | 2536 | 2529 | 2549 | 2498 | 2549 | 1189 | 1284 | 517  |
| 2035 | 2811 | 2826 | 1523 | 4244 | 2803 | 2789 | 2820 | 2707 | 2820 | 1342 | 1454 | 671  |
| 2036 | 3093 | 3117 | 1790 | 4500 | 3085 | 3050 | 3105 | 2887 | 3104 | 1470 | 1616 | 798  |
| 2037 | 3361 | 3409 | 2052 | 4696 | 3360 | 3349 | 3387 | 3093 | 3384 | 1595 | 1766 | 932  |
| 2038 | 3676 | 3731 | 2314 | 4927 | 3685 | 3650 | 3713 | 3298 | 3705 | 1725 | 1906 | 1090 |
| 2039 | 3912 | 3992 | 2575 | 5158 | 3955 | 3917 | 3965 | 3452 | 3947 | 1851 | 2048 | 1244 |
| 2040 | 4212 | 4319 | 2840 | 5389 | 4259 | 4211 | 4290 | 3676 | 4248 | 2032 | 2246 | 1386 |
| 2041 | 4439 | 4559 | 3114 | 5518 | 4500 | 4452 | 4573 | 3831 | 4489 | 2183 | 2424 | 1535 |
| 2042 | 4739 | 4884 | 3404 | 5573 | 4797 | 4736 | 4939 | 4075 | 4823 | 2347 | 2632 | 1747 |
| 2043 | 4838 | 4998 | 3710 | 5646 | 4806 | 4845 | 4983 | 4107 | 4864 | 2505 | 2826 | 1941 |
| 2044 | 4842 | 5114 | 3925 | 5721 | 4851 | 4895 | 5069 | 4193 | 4950 | 2654 | 2997 | 2136 |
| 2045 | 4899 | 5291 | 4022 | 5795 | 4979 | 5036 | 5189 | 4313 | 5070 | 2737 | 3134 | 2326 |
| 2046 | 4972 | 5448 | 4111 | 5842 | 5138 | 5202 | 5313 | 4437 | 5194 | 2826 | 3254 | 2487 |
| 2047 | 5064 | 5614 | 4229 | 5964 | 5280 | 5333 | 5445 | 4569 | 5326 | 2908 | 3342 | 2591 |
| 2048 | 5149 | 5797 | 4366 | 6040 | 5418 | 5487 | 5593 | 4717 | 5474 | 2954 | 3401 | 2676 |
| 2049 | 5228 | 5941 | 4554 | 6054 | 5539 | 5595 | 5710 | 4834 | 5591 | 3034 | 3462 | 2868 |
| 2050 | 5312 | 6075 | 4738 | 6077 | 5650 | 5699 | 5824 | 4948 | 5705 | 3097 | 3649 | 3064 |
| 2051 | 5370 | 6228 | 4883 | 6095 | 5746 | 5797 | 5901 | 5025 | 5782 | 3219 | 3800 | 3232 |
| 2052 | 5424 | 6387 | 5063 | 6095 | 5822 | 5902 | 5987 | 5111 | 5868 | 3262 | 3949 | 3367 |
| 2053 | 5495 | 6515 | 5234 | 6105 | 5959 | 6025 | 6136 | 5260 | 6017 | 3285 | 4088 | 3510 |
| 2054 | 5564 | 6642 | 5372 | 6105 | 6096 | 6112 | 6242 | 5366 | 6123 | 3309 | 4278 | 3651 |
| 2055 | 5586 | 6726 | 5487 | 6105 | 6165 | 6183 | 6314 | 5438 | 6195 | 3425 | 4463 | 3759 |
| 2056 | 5624 | 6795 | 5563 | 6105 | 6228 | 6246 | 6377 | 5501 | 6258 | 3522 | 4600 | 3872 |
| 2057 | 5673 | 6795 | 5729 | 6105 | 6278 | 6276 | 6405 | 5529 | 6286 | 3575 | 4680 | 4043 |
| 2058 | 5674 | 6822 | 5889 | 6105 | 6283 | 6284 | 6413 | 5537 | 6294 | 3595 | 4731 | 4220 |
| 2059 | 5687 | 6822 | 6046 | 6105 | 6292 | 6287 | 6418 | 5542 | 6299 | 3632 | 4763 | 4384 |

|      | 109  | 110  | 111  | 112  | 113  | 114  | 115  | 116  | 117  | 118  | 119  | 120  |
|------|------|------|------|------|------|------|------|------|------|------|------|------|
| 2060 | 5687 | 6822 | 6169 | 6105 | 6292 | 6295 | 6426 | 5550 | 6307 | 3655 | 4784 | 4508 |
| 2061 | 5687 | 6822 | 6265 | 6105 | 6292 | 6295 | 6426 | 5550 | 6307 | 3672 | 4794 | 4574 |
| 2062 | 5687 | 6822 | 6330 | 6105 | 6292 | 6295 | 6426 | 5550 | 6307 | 3672 | 4801 | 4618 |
| 2063 | 5687 | 6822 | 6379 | 6105 | 6292 | 6295 | 6426 | 5550 | 6307 | 3672 | 4801 | 4658 |
| 2064 | 5687 | 6822 | 6389 | 6105 | 6292 | 6295 | 6426 | 5550 | 6307 | 3672 | 4801 | 4698 |
| 2065 | 5687 | 6822 | 6394 | 6105 | 6292 | 6295 | 6426 | 5550 | 6307 | 3672 | 4801 | 4729 |
| 2066 | 5687 | 6822 | 6394 | 6105 | 6292 | 6295 | 6426 | 5550 | 6307 | 3672 | 4801 | 4744 |
| 2067 | 5687 | 6822 | 6394 | 6105 | 6292 | 6295 | 6426 | 5550 | 6307 | 3672 | 4801 | 4744 |
| 2068 | 5687 | 6822 | 6394 | 6105 | 6292 | 6295 | 6426 | 5550 | 6307 | 3672 | 4801 | 4744 |
| 2069 | 5687 | 6822 | 6394 | 6105 | 6292 | 6295 | 6426 | 5550 | 6307 | 3672 | 4801 | 4744 |
| 2070 | 5687 | 6822 | 6394 | 6105 | 6292 | 6295 | 6426 | 5550 | 6307 | 3672 | 4801 | 4744 |
| 2071 | 5687 | 6822 | 6394 | 6105 | 6292 | 6295 | 6426 | 5550 | 6307 | 3672 | 4801 | 4744 |
| 2072 | 5687 | 6822 | 6394 | 6105 | 6292 | 6295 | 6426 | 5550 | 6307 | 3672 | 4801 | 4744 |
| 2073 | 5687 | 6822 | 6394 | 6105 | 6292 | 6295 | 6426 | 5550 | 6307 | 3672 | 4801 | 4744 |
| 2074 | 5687 | 6822 | 6394 | 6105 | 6292 | 6295 | 6426 | 5550 | 6307 | 3672 | 4801 | 4744 |
| 2075 | 5687 | 6822 | 6394 | 6105 | 6292 | 6295 | 6426 | 5550 | 6307 | 3672 | 4801 | 4744 |
| 2076 | 5687 | 6822 | 6394 | 6105 | 6292 | 6295 | 6426 | 5550 | 6307 | 3672 | 4801 | 4744 |
| 2077 | 5687 | 6822 | 6394 | 6105 | 6292 | 6295 | 6426 | 5550 | 6307 | 3672 | 4801 | 4744 |
| 2078 | 5687 | 6822 | 6394 | 6105 | 6292 | 6295 | 6426 | 5550 | 6307 | 3672 | 4801 | 4744 |
| 2079 | 5687 | 6822 | 6394 | 6105 | 6292 | 6295 | 6426 | 5550 | 6307 | 3672 | 4801 | 4744 |
| 2080 | 5687 | 6822 | 6394 | 6105 | 6292 | 6295 | 6426 | 5550 | 6307 | 3672 | 4801 | 4744 |
| 2081 | 5687 | 6822 | 6394 | 6105 | 6292 | 6295 | 6426 | 5550 | 6307 | 3672 | 4801 | 4744 |
| 2082 | 5687 | 6822 | 6394 | 6105 | 6292 | 6295 | 6426 | 5550 | 6307 | 3672 | 4801 | 4744 |
| 2083 | 5687 | 6822 | 6394 | 6105 | 6292 | 6295 | 6426 | 5550 | 6307 | 3672 | 4801 | 4744 |
| 2084 | 5687 | 6822 | 6394 | 6105 | 6292 | 6295 | 6426 | 5550 | 6307 | 3672 | 4801 | 4744 |
| 2085 | 5687 | 6822 | 6394 | 6105 | 6292 | 6295 | 6426 | 5550 | 6307 | 3672 | 4801 | 4744 |
| 2086 | 5687 | 6822 | 6394 | 6105 | 6292 | 6295 | 6426 | 5550 | 6307 | 3672 | 4801 | 4744 |
| 2087 | 5687 | 6822 | 6394 | 6105 | 6292 | 6295 | 6426 | 5550 | 6307 | 3672 | 4801 | 4744 |
| 2088 | 5687 | 6822 | 6394 | 6105 | 6292 | 6295 | 6426 | 5550 | 6307 | 3672 | 4801 | 4744 |
| 2089 | 5687 | 6822 | 6394 | 6105 | 6292 | 6295 | 6426 | 5550 | 6307 | 3672 | 4801 | 4744 |
| 2090 | 5687 | 6822 | 6394 | 6105 | 6292 | 6295 | 6426 | 5550 | 6307 | 3672 | 4801 | 4744 |

|      | 121  | 122  | 123  | 124  | 125  | 126  | 127  | 128  | 129  | 130  | 131  | 132  |
|------|------|------|------|------|------|------|------|------|------|------|------|------|
| 2002 | 0    | 0    | 0    | 0    | 0    | 0    | 0    | 0    | 0    | 0    | 0    | 0    |
| 2003 | 0    | 0    | 0    | 0    | 0    | 0    | 0    | 0    | 0    | 0    | 0    | 0    |
| 2004 | 0    | 0    | 0    | 0    | 0    | 0    | 0    | 0    | 0    | 0    | 0    | 0    |
| 2005 | 0    | 0    | 0    | 0    | 0    | 0    | 0    | 0    | 0    | 0    | 0    | 0    |
| 2006 | 0    | 0    | 0    | 0    | 0    | 0    | 0    | 0    | 0    | 0    | 0    | 0    |
| 2007 | 0    | 0    | 0    | 0    | 0    | 0    | 0    | 0    | 0    | 0    | 0    | 0    |
| 2008 | 0    | 0    | 0    | 0    | 0    | 0    | 0    | 0    | 0    | 0    | 0    | 0    |
| 2009 | 0    | 0    | 0    | 0    | 0    | 0    | 0    | 0    | 0    | 0    | 0    | 0    |
| 2010 | 0    | 0    | 0    | 0    | 0    | 0    | 0    | 0    | 0    | 0    | 0    | 0    |
| 2011 | 0    | 0    | 0    | 0    | 0    | 0    | 0    | 0    | 0    | 0    | 0    | 0    |
| 2012 | 0    | 0    | 0    | 0    | 0    | 0    | 0    | 0    | 0    | 0    | 0    | 0    |
| 2013 | 0    | 0    | 0    | 0    | 0    | 0    | 0    | 0    | 0    | 0    | 0    | 0    |
| 2014 | 0    | 0    | 0    | 0    | 0    | 0    | 0    | 0    | 0    | 0    | 0    | 0    |
| 2015 | 0    | 0    | 0    | 0    | 0    | 0    | 0    | 0    | 0    | 0    | 0    | 0    |
| 2016 | 0    | 0    | 0    | 0    | 0    | 0    | 0    | 0    | 0    | 0    | 0    | 0    |
| 2017 | 0    | 0    | 0    | 0    | 0    | 0    | 0    | 0    | 0    | 0    | 0    | 0    |
| 2018 | 0    | 0    | 0    | 0    | 0    | 0    | 0    | 0    | 0    | 0    | 0    | 0    |
| 2019 | 0    | 0    | 0    | 0    | 0    | 0    | 0    | 0    | 0    | 0    | 0    | 0    |
| 2020 | 90   | 0    | 0    | 0    | 0    | 0    | 0    | 0    | 0    | 10   | 0    | 0    |
| 2021 | 181  | 0    | 0    | 0    | 0    | 0    | 0    | 0    | 0    | 26   | 0    | 0    |
| 2022 | 287  | 0    | 0    | 0    | 0    | 0    | 0    | 0    | 0    | 48   | 0    | 0    |
| 2023 | 398  | 0    | 0    | 0    | 0    | 0    | 0    | 0    | 0    | 95   | 0    | 0    |
| 2024 | 540  | 0    | 0    | 0    | 0    | 0    | 0    | 0    | 0    | 133  | 0    | 0    |
| 2025 | 657  | 64   | 174  | 244  | 4    | 71   | 17   | 17   | 0    | 184  | 12   | 63   |
| 2026 | 791  | 147  | 327  | 481  | 27   | 160  | 50   | 50   | 0    | 227  | 25   | 168  |
| 2027 | 952  | 241  | 474  | 728  | 36   | 244  | 76   | 81   | 0    | 274  | 35   | 244  |
| 2028 | 1137 | 363  | 608  | 955  | 64   | 350  | 112  | 117  | 0    | 333  | 57   | 353  |
| 2029 | 1330 | 477  | 747  | 1187 | 105  | 452  | 176  | 181  | 0    | 413  | 87   | 479  |
| 2030 | 1487 | 627  | 908  | 1427 | 138  | 580  | 240  | 245  | 10   | 508  | 124  | 581  |
| 2031 | 1661 | 770  | 1057 | 1646 | 179  | 739  | 298  | 312  | 41   | 586  | 161  | 717  |
| 2032 | 1837 | 915  | 1243 | 1882 | 230  | 901  | 350  | 386  | 88   | 677  | 203  | 846  |
| 2033 | 2000 | 1083 | 1398 | 2123 | 300  | 1073 | 424  | 478  | 140  | 737  | 260  | 935  |
| 2034 | 2144 | 1234 | 1546 | 2355 | 361  | 1225 | 506  | 574  | 208  | 819  | 309  | 1068 |
| 2035 | 2287 | 1389 | 1699 | 2592 | 413  | 1391 | 586  | 662  | 286  | 875  | 350  | 1197 |
| 2036 | 2440 | 1522 | 1828 | 2765 | 470  | 1516 | 653  | 736  | 346  | 978  | 398  | 1299 |
| 2037 | 2564 | 1640 | 1989 | 2962 | 547  | 1666 | 734  | 837  | 427  | 1060 | 448  | 1413 |
| 2038 | 2691 | 1761 | 2149 | 3146 | 599  | 1801 | 816  | 952  | 507  | 1119 | 503  | 1523 |
| 2039 | 2801 | 1877 | 2304 | 3337 | 647  | 1934 | 870  | 1049 | 594  | 1185 | 547  | 1635 |
| 2040 | 2904 | 2007 | 2452 | 3562 | 697  | 2116 | 962  | 1135 | 690  | 1265 | 592  | 1791 |
| 2041 | 3030 | 2158 | 2638 | 3772 | 761  | 2273 | 1020 | 1207 | 777  | 1350 | 629  | 1939 |
| 2042 | 3131 | 2308 | 2865 | 4000 | 864  | 2468 | 1104 | 1318 | 865  | 1494 | 667  | 2151 |
| 2043 | 3225 | 2454 | 3041 | 4188 | 949  | 2625 | 1180 | 1435 | 974  | 1572 | 737  | 2293 |
| 2044 | 3306 | 2626 | 3172 | 4373 | 1050 | 2795 | 1261 | 1553 | 1065 | 1667 | 830  | 2429 |
| 2045 | 3368 | 2790 | 3316 | 4518 | 1136 | 2914 | 1351 | 1670 | 1165 | 1747 | 880  | 2588 |
| 2046 | 3416 | 2925 | 3443 | 4651 | 1188 | 3021 | 1440 | 1761 | 1293 | 1757 | 911  | 2750 |
| 2047 | 3467 | 2992 | 3574 | 4746 | 1218 | 3098 | 1494 | 1877 | 1341 | 1807 | 992  | 2855 |
| 2048 | 3499 | 3101 | 3641 | 4806 | 1251 | 3147 | 1531 | 2065 | 1429 | 1870 | 1121 | 2948 |
| 2049 | 3518 | 3255 | 3729 | 4884 | 1329 | 3225 | 1674 | 2220 | 1577 | 1976 | 1299 | 3039 |
| 2050 | 3573 | 3397 | 3819 | 5036 | 1481 | 3377 | 1744 | 2384 | 1748 | 2037 | 1433 | 3127 |
| 2051 | 3637 | 3494 | 3897 | 5168 | 1613 | 3509 | 1773 | 2516 | 1914 | 2076 | 1537 | 3205 |
| 2052 | 3724 | 3584 | 4015 | 5260 | 1705 | 3601 | 1806 | 2692 | 2068 | 2097 | 1619 | 3366 |
| 2053 | 3795 | 3680 | 4165 | 5339 | 1784 | 3680 | 1876 | 2878 | 2197 | 2109 | 1708 | 3530 |
| 2054 | 3822 | 3807 | 4313 | 5442 | 1887 | 3783 | 2010 | 3049 | 2346 | 2113 | 1861 | 3653 |
| 2055 | 3842 | 3973 | 4432 | 5614 | 2059 | 3955 | 2065 | 3162 | 2481 | 2116 | 2011 | 3722 |
| 2056 | 3856 | 4087 | 4503 | 5741 | 2186 | 4082 | 2106 | 3230 | 2606 | 2116 | 2118 | 3773 |
| 2057 | 3860 | 4168 | 4547 | 5828 | 2273 | 4169 | 2136 | 3268 | 2746 | 2116 | 2187 | 3794 |
| 2058 | 3860 | 4212 | 4565 | 5873 | 2318 | 4214 | 2166 | 3289 | 2919 | 2116 | 2231 | 3806 |
| 2059 | 3864 | 4233 | 4580 | 5912 | 2357 | 4253 | 2183 | 3304 | 3113 | 2116 | 2252 | 3809 |

|      | 121  | 122  | 123  | 124  | 125  | 126  | 127  | 128  | 129  | 130  | 131  | 132  |
|------|------|------|------|------|------|------|------|------|------|------|------|------|
| 2060 | 3864 | 4245 | 4582 | 5933 | 2378 | 4274 | 2183 | 3304 | 3233 | 2116 | 2264 | 3810 |
| 2061 | 3864 | 4255 | 4582 | 5945 | 2390 | 4286 | 2183 | 3304 | 3316 | 2116 | 2266 | 3813 |
| 2062 | 3864 | 4255 | 4582 | 5947 | 2392 | 4288 | 2183 | 3304 | 3375 | 2116 | 2266 | 3813 |
| 2063 | 3864 | 4255 | 4582 | 5947 | 2392 | 4288 | 2183 | 3304 | 3419 | 2116 | 2266 | 3813 |
| 2064 | 3864 | 4255 | 4582 | 5947 | 2392 | 4288 | 2183 | 3304 | 3459 | 2116 | 2266 | 3813 |
| 2065 | 3864 | 4255 | 4582 | 5947 | 2392 | 4288 | 2183 | 3304 | 3498 | 2116 | 2266 | 3813 |
| 2066 | 3864 | 4255 | 4582 | 5947 | 2392 | 4288 | 2183 | 3304 | 3504 | 2116 | 2266 | 3813 |
| 2067 | 3864 | 4255 | 4582 | 5947 | 2392 | 4288 | 2183 | 3304 | 3504 | 2116 | 2266 | 3813 |
| 2068 | 3864 | 4255 | 4582 | 5947 | 2392 | 4288 | 2183 | 3304 | 3504 | 2116 | 2266 | 3813 |
| 2069 | 3864 | 4255 | 4582 | 5947 | 2392 | 4288 | 2183 | 3304 | 3504 | 2116 | 2266 | 3813 |
| 2070 | 3864 | 4255 | 4582 | 5947 | 2392 | 4288 | 2183 | 3304 | 3504 | 2116 | 2266 | 3813 |
| 2071 | 3864 | 4255 | 4582 | 5947 | 2392 | 4288 | 2183 | 3304 | 3504 | 2116 | 2266 | 3813 |
| 2072 | 3864 | 4255 | 4582 | 5947 | 2392 | 4288 | 2183 | 3304 | 3504 | 2116 | 2266 | 3813 |
| 2073 | 3864 | 4255 | 4582 | 5947 | 2392 | 4288 | 2183 | 3304 | 3504 | 2116 | 2266 | 3813 |
| 2074 | 3864 | 4255 | 4582 | 5947 | 2392 | 4288 | 2183 | 3304 | 3504 | 2116 | 2266 | 3813 |
| 2075 | 3864 | 4255 | 4582 | 5947 | 2392 | 4288 | 2183 | 3304 | 3504 | 2116 | 2266 | 3813 |
| 2076 | 3864 | 4255 | 4582 | 5947 | 2392 | 4288 | 2183 | 3304 | 3504 | 2116 | 2266 | 3813 |
| 2077 | 3864 | 4255 | 4582 | 5947 | 2392 | 4288 | 2183 | 3304 | 3504 | 2116 | 2266 | 3813 |
| 2078 | 3864 | 4255 | 4582 | 5947 | 2392 | 4288 | 2183 | 3304 | 3504 | 2116 | 2266 | 3813 |
| 2079 | 3864 | 4255 | 4582 | 5947 | 2392 | 4288 | 2183 | 3304 | 3504 | 2116 | 2266 | 3813 |
| 2080 | 3864 | 4255 | 4582 | 5947 | 2392 | 4288 | 2183 | 3304 | 3504 | 2116 | 2266 | 3813 |
| 2081 | 3864 | 4255 | 4582 | 5947 | 2392 | 4288 | 2183 | 3304 | 3504 | 2116 | 2266 | 3813 |
| 2082 | 3864 | 4255 | 4582 | 5947 | 2392 | 4288 | 2183 | 3304 | 3504 | 2116 | 2266 | 3813 |
| 2083 | 3864 | 4255 | 4582 | 5947 | 2392 | 4288 | 2183 | 3304 | 3504 | 2116 | 2266 | 3813 |
| 2084 | 3864 | 4255 | 4582 | 5947 | 2392 | 4288 | 2183 | 3304 | 3504 | 2116 | 2266 | 3813 |
| 2085 | 3864 | 4255 | 4582 | 5947 | 2392 | 4288 | 2183 | 3304 | 3504 | 2116 | 2266 | 3813 |
| 2086 | 3864 | 4255 | 4582 | 5947 | 2392 | 4288 | 2183 | 3304 | 3504 | 2116 | 2266 | 3813 |
| 2087 | 3864 | 4255 | 4582 | 5947 | 2392 | 4288 | 2183 | 3304 | 3504 | 2116 | 2266 | 3813 |
| 2088 | 3864 | 4255 | 4582 | 5947 | 2392 | 4288 | 2183 | 3304 | 3504 | 2116 | 2266 | 3813 |
| 2089 | 3864 | 4255 | 4582 | 5947 | 2392 | 4288 | 2183 | 3304 | 3504 | 2116 | 2266 | 3813 |
| 2090 | 3864 | 4255 | 4582 | 5947 | 2392 | 4288 | 2183 | 3304 | 3504 | 2116 | 2266 | 3813 |

|      | 133  | 134  | 135  | 136  | 137  | 138  | 139  | 140  | 141  | 142  | 143  | 144  |
|------|------|------|------|------|------|------|------|------|------|------|------|------|
| 2002 | 0    | 0    | 0    | 0    | 0    | 0    | 0    | 0    | 0    | 0    | 0    | 0    |
| 2003 | 0    | 0    | 0    | 0    | 0    | 0    | 0    | 0    | 0    | 0    | 0    | 0    |
| 2004 | 0    | 0    | 0    | 0    | 0    | 0    | 0    | 0    | 0    | 0    | 0    | 0    |
| 2005 | 0    | 0    | 0    | 0    | 0    | 0    | 0    | 0    | 0    | 0    | 0    | 0    |
| 2006 | 0    | 0    | 0    | 0    | 0    | 0    | 0    | 0    | 0    | 0    | 0    | 0    |
| 2007 | 0    | 0    | 0    | 0    | 0    | 0    | 0    | 0    | 0    | 0    | 0    | 0    |
| 2008 | 0    | 0    | 0    | 0    | 0    | 0    | 0    | 0    | 0    | 0    | 0    | 0    |
| 2009 | 0    | 0    | 0    | 0    | 0    | 0    | 0    | 0    | 0    | 0    | 0    | 0    |
| 2010 | 0    | 0    | 0    | 0    | 0    | 0    | 0    | 0    | 0    | 0    | 0    | 0    |
| 2011 | 0    | 0    | 0    | 0    | 0    | 0    | 0    | 0    | 0    | 0    | 0    | 0    |
| 2012 | 0    | 0    | 0    | 0    | 0    | 0    | 0    | 0    | 0    | 0    | 0    | 0    |
| 2013 | 0    | 0    | 0    | 0    | 0    | 0    | 0    | 0    | 0    | 0    | 0    | 0    |
| 2014 | 0    | 0    | 0    | 0    | 0    | 0    | 0    | 0    | 0    | 0    | 0    | 0    |
| 2015 | 0    | 0    | 0    | 0    | 0    | 0    | 0    | 0    | 0    | 0    | 0    | 0    |
| 2016 | 0    | 0    | 0    | 0    | 0    | 0    | 0    | 0    | 0    | 0    | 0    | 0    |
| 2017 | 0    | 0    | 0    | 0    | 0    | 0    | 0    | 0    | 0    | 0    | 0    | 0    |
| 2018 | 0    | 0    | 0    | 0    | 0    | 0    | 0    | 0    | 0    | 0    | 0    | 0    |
| 2019 | 0    | 0    | 0    | 0    | 0    | 0    | 0    | 0    | 0    | 0    | 0    | 0    |
| 2020 | 0    | 0    | 0    | 0    | 0    | 0    | 254  | 0    | 0    | 0    | 0    | 0    |
| 2021 | 0    | 0    | 0    | 0    | 0    | 0    | 462  | 0    | 0    | 0    | 0    | 0    |
| 2022 | 0    | 0    | 0    | 0    | 0    | 0    | 700  | 0    | 0    | 0    | 0    | 0    |
| 2023 | 0    | 0    | 0    | 0    | 0    | 0    | 950  | 0    | 0    | 0    | 0    | 0    |
| 2024 | 0    | 0    | 0    | 0    | 0    | 0    | 1210 | 0    | 0    | 0    | 0    | 0    |
| 2025 | 64   | 1    | 17   | 256  | 256  | 0    | 1461 | 256  | 256  | 256  | 256  | 256  |
| 2026 | 151  | 6    | 50   | 452  | 493  | 0    | 1743 | 478  | 478  | 478  | 478  | 478  |
| 2027 | 241  | 11   | 76   | 665  | 775  | 0    | 2000 | 712  | 712  | 712  | 712  | 712  |
| 2028 | 345  | 24   | 112  | 867  | 1038 | 0    | 2255 | 952  | 952  | 952  | 952  | 952  |
| 2029 | 465  | 54   | 176  | 1079 | 1314 | 0    | 2519 | 1212 | 1212 | 1212 | 1212 | 1212 |
| 2030 | 595  | 83   | 240  | 1327 | 1616 | 256  | 2838 | 1494 | 1494 | 1494 | 1494 | 1494 |
| 2031 | 732  | 100  | 298  | 1587 | 1894 | 495  | 3124 | 1766 | 1766 | 1766 | 1766 | 1766 |
| 2032 | 885  | 129  | 357  | 1814 | 2165 | 710  | 3401 | 2036 | 2036 | 2036 | 2036 | 2036 |
| 2033 | 1042 | 164  | 440  | 2050 | 2445 | 978  | 3677 | 2303 | 2303 | 2303 | 2302 | 2303 |
| 2034 | 1201 | 209  | 535  | 2300 | 2749 | 1252 | 4008 | 2567 | 2567 | 2567 | 2560 | 2567 |
| 2035 | 1390 | 252  | 625  | 2576 | 3030 | 1566 | 4272 | 2836 | 2836 | 2836 | 2823 | 2836 |
| 2036 | 1529 | 286  | 696  | 2830 | 3345 | 1861 | 4636 | 3146 | 3159 | 3146 | 3120 | 3146 |
| 2037 | 1684 | 327  | 776  | 3127 | 3631 | 2170 | 4884 | 3452 | 3453 | 3452 | 3393 | 3452 |
| 2038 | 1820 | 364  | 866  | 3393 | 3947 | 2453 | 5086 | 3726 | 3759 | 3728 | 3611 | 3728 |
| 2039 | 1971 | 401  | 942  | 3717 | 4256 | 2741 | 5340 | 4034 | 4036 | 4041 | 3854 | 4041 |
| 2040 | 2122 | 436  | 1029 | 4015 | 4565 | 3033 | 5605 | 4330 | 4362 | 4349 | 4039 | 4349 |
| 2041 | 2305 | 481  | 1102 | 4345 | 4882 | 3325 | 5798 | 4643 | 4669 | 4685 | 4280 | 4682 |
| 2042 | 2509 | 522  | 1189 | 4636 | 5236 | 3593 | 5909 | 4985 | 5007 | 4999 | 4503 | 4988 |
| 2043 | 2695 | 587  | 1283 | 4996 | 5597 | 3876 | 5918 | 5265 | 5312 | 5355 | 4780 | 5327 |
| 2044 | 2877 | 662  | 1388 | 5307 | 5924 | 4143 | 5990 | 5616 | 5632 | 5714 | 5042 | 5663 |
| 2045 | 3051 | 727  | 1502 | 5314 | 5953 | 4498 | 6020 | 5617 | 5657 | 5724 | 5052 | 5673 |
| 2046 | 3212 | 787  | 1597 | 5357 | 6087 | 4823 | 6052 | 5734 | 5669 | 5831 | 5159 | 5780 |
| 2047 | 3302 | 877  | 1687 | 5431 | 6254 | 5134 | 6103 | 5839 | 5767 | 5946 | 5274 | 5895 |
| 2048 | 3455 | 1030 | 1840 | 5497 | 6430 | 5205 | 6138 | 5949 | 5887 | 6056 | 5384 | 6005 |
| 2049 | 3602 | 1177 | 1987 | 5554 | 6557 | 5226 | 6143 | 6051 | 6005 | 6148 | 5476 | 6097 |
| 2050 | 3694 | 1269 | 2079 | 5615 | 6661 | 5335 | 6159 | 6134 | 6079 | 6231 | 5559 | 6180 |
| 2051 | 3768 | 1343 | 2153 | 5648 | 6750 | 5498 | 6159 | 6199 | 6153 | 6306 | 5634 | 6255 |
| 2052 | 3874 | 1449 | 2259 | 5685 | 6826 | 5673 | 6159 | 6246 | 6227 | 6363 | 5691 | 6312 |
| 2053 | 4039 | 1614 | 2424 | 5729 | 6856 | 5798 | 6159 | 6297 | 6289 | 6409 | 5737 | 6358 |
| 2054 | 4198 | 1773 | 2583 | 5735 | 6856 | 5878 | 6159 | 6314 | 6325 | 6411 | 5739 | 6360 |
| 2055 | 4290 | 1865 | 2675 | 5747 | 6878 | 5997 | 6159 | 6326 | 6327 | 6425 | 5753 | 6374 |
| 2056 | 4352 | 1927 | 2737 | 5747 | 6879 | 6112 | 6159 | 6328 | 6339 | 6430 | 5758 | 6379 |
| 2057 | 4396 | 1971 | 2781 | 5753 | 6879 | 6191 | 6159 | 6331 | 6339 | 6430 | 5758 | 6379 |
| 2058 | 4417 | 1992 | 2802 | 5753 | 6879 | 6274 | 6159 | 6333 | 6339 | 6430 | 5758 | 6379 |
| 2059 | 4429 | 2004 | 2814 | 5753 | 6879 | 6338 | 6159 | 6333 | 6339 | 6430 | 5758 | 6379 |

|      | 133  | 134  | 135  | 136  | 137  | 138  | 139  | 140  | 141  | 142  | 143  | 144  |
|------|------|------|------|------|------|------|------|------|------|------|------|------|
| 2060 | 4429 | 2004 | 2814 | 5753 | 6879 | 6386 | 6159 | 6333 | 6339 | 6430 | 5758 | 6379 |
| 2061 | 4429 | 2004 | 2814 | 5753 | 6879 | 6419 | 6159 | 6333 | 6339 | 6430 | 5758 | 6379 |
| 2062 | 4429 | 2004 | 2814 | 5753 | 6879 | 6429 | 6159 | 6333 | 6339 | 6430 | 5758 | 6379 |
| 2063 | 4429 | 2004 | 2814 | 5753 | 6879 | 6429 | 6159 | 6333 | 6339 | 6430 | 5758 | 6379 |
| 2064 | 4429 | 2004 | 2814 | 5753 | 6879 | 6429 | 6159 | 6333 | 6339 | 6430 | 5758 | 6379 |
| 2065 | 4429 | 2004 | 2814 | 5753 | 6879 | 6429 | 6159 | 6333 | 6339 | 6430 | 5758 | 6379 |
| 2066 | 4429 | 2004 | 2814 | 5753 | 6879 | 6429 | 6159 | 6333 | 6339 | 6430 | 5758 | 6379 |
| 2067 | 4429 | 2004 | 2814 | 5753 | 6879 | 6429 | 6159 | 6333 | 6339 | 6430 | 5758 | 6379 |
| 2068 | 4429 | 2004 | 2814 | 5753 | 6879 | 6429 | 6159 | 6333 | 6339 | 6430 | 5758 | 6379 |
| 2069 | 4429 | 2004 | 2814 | 5753 | 6879 | 6429 | 6159 | 6333 | 6339 | 6430 | 5758 | 6379 |
| 2070 | 4429 | 2004 | 2814 | 5753 | 6879 | 6429 | 6159 | 6333 | 6339 | 6430 | 5758 | 6379 |
| 2071 | 4429 | 2004 | 2814 | 5753 | 6879 | 6429 | 6159 | 6333 | 6339 | 6430 | 5758 | 6379 |
| 2072 | 4429 | 2004 | 2814 | 5753 | 6879 | 6429 | 6159 | 6333 | 6339 | 6430 | 5758 | 6379 |
| 2073 | 4429 | 2004 | 2814 | 5753 | 6879 | 6429 | 6159 | 6333 | 6339 | 6430 | 5758 | 6379 |
| 2074 | 4429 | 2004 | 2814 | 5753 | 6879 | 6429 | 6159 | 6333 | 6339 | 6430 | 5758 | 6379 |
| 2075 | 4429 | 2004 | 2814 | 5753 | 6879 | 6429 | 6159 | 6333 | 6339 | 6430 | 5758 | 6379 |
| 2076 | 4429 | 2004 | 2814 | 5753 | 6879 | 6429 | 6159 | 6333 | 6339 | 6430 | 5758 | 6379 |
| 2077 | 4429 | 2004 | 2814 | 5753 | 6879 | 6429 | 6159 | 6333 | 6339 | 6430 | 5758 | 6379 |
| 2078 | 4429 | 2004 | 2814 | 5753 | 6879 | 6429 | 6159 | 6333 | 6339 | 6430 | 5758 | 6379 |
| 2079 | 4429 | 2004 | 2814 | 5753 | 6879 | 6429 | 6159 | 6333 | 6339 | 6430 | 5758 | 6379 |
| 2080 | 4429 | 2004 | 2814 | 5753 | 6879 | 6429 | 6159 | 6333 | 6339 | 6430 | 5758 | 6379 |
| 2081 | 4429 | 2004 | 2814 | 5753 | 6879 | 6429 | 6159 | 6333 | 6339 | 6430 | 5758 | 6379 |
| 2082 | 4429 | 2004 | 2814 | 5753 | 6879 | 6429 | 6159 | 6333 | 6339 | 6430 | 5758 | 6379 |
| 2083 | 4429 | 2004 | 2814 | 5753 | 6879 | 6429 | 6159 | 6333 | 6339 | 6430 | 5758 | 6379 |
| 2084 | 4429 | 2004 | 2814 | 5753 | 6879 | 6429 | 6159 | 6333 | 6339 | 6430 | 5758 | 6379 |
| 2085 | 4429 | 2004 | 2814 | 5753 | 6879 | 6429 | 6159 | 6333 | 6339 | 6430 | 5758 | 6379 |
| 2086 | 4429 | 2004 | 2814 | 5753 | 6879 | 6429 | 6159 | 6333 | 6339 | 6430 | 5758 | 6379 |
| 2087 | 4429 | 2004 | 2814 | 5753 | 6879 | 6429 | 6159 | 6333 | 6339 | 6430 | 5758 | 6379 |
| 2088 | 4429 | 2004 | 2814 | 5753 | 6879 | 6429 | 6159 | 6333 | 6339 | 6430 | 5758 | 6379 |
| 2089 | 4429 | 2004 | 2814 | 5753 | 6879 | 6429 | 6159 | 6333 | 6339 | 6430 | 5758 | 6379 |
| 2090 | 4429 | 2004 | 2814 | 5753 | 6879 | 6429 | 6159 | 6333 | 6339 | 6430 | 5758 | 6379 |



|      | 145  | 146  | 147  | 148  | 149  | 150  | 151  | 152  | 153  | 154  | 155  | 156  |
|------|------|------|------|------|------|------|------|------|------|------|------|------|
| 2002 | 0    | 0    | 0    | 0    | 0    | 0    | 0    | 0    | 0    | 0    | 0    | 0    |
| 2003 | 0    | 0    | 0    | 0    | 0    | 0    | 0    | 0    | 0    | 0    | 0    | 0    |
| 2004 | 0    | 0    | 0    | 0    | 0    | 0    | 0    | 0    | 0    | 0    | 0    | 0    |
| 2005 | 0    | 0    | 0    | 0    | 0    | 0    | 0    | 0    | 0    | 0    | 0    | 0    |
| 2006 | 0    | 0    | 0    | 0    | 0    | 0    | 0    | 0    | 0    | 0    | 0    | 0    |
| 2007 | 0    | 0    | 0    | 0    | 0    | 0    | 0    | 0    | 0    | 0    | 0    | 0    |
| 2008 | 0    | 0    | 0    | 0    | 0    | 0    | 0    | 0    | 0    | 0    | 0    | 0    |
| 2009 | 0    | 0    | 0    | 0    | 0    | 0    | 0    | 0    | 0    | 0    | 0    | 0    |
| 2010 | 0    | 0    | 0    | 0    | 0    | 0    | 0    | 0    | 0    | 0    | 0    | 0    |
| 2011 | 0    | 0    | 0    | 0    | 0    | 0    | 0    | 0    | 0    | 0    | 0    | 0    |
| 2012 | 0    | 0    | 0    | 0    | 0    | 0    | 0    | 0    | 0    | 0    | 0    | 0    |
| 2013 | 0    | 0    | 0    | 0    | 0    | 0    | 0    | 0    | 0    | 0    | 0    | 0    |
| 2014 | 0    | 0    | 0    | 0    | 0    | 0    | 0    | 0    | 0    | 0    | 0    | 0    |
| 2015 | 0    | 0    | 0    | 0    | 0    | 0    | 0    | 0    | 0    | 0    | 0    | 0    |
| 2016 | 0    | 0    | 0    | 0    | 0    | 0    | 0    | 0    | 0    | 0    | 0    | 0    |
| 2017 | 0    | 0    | 0    | 0    | 0    | 0    | 0    | 0    | 0    | 0    | 0    | 0    |
| 2018 | 0    | 0    | 0    | 0    | 0    | 0    | 0    | 0    | 0    | 0    | 0    | 0    |
| 2019 | 0    | 0    | 0    | 0    | 0    | 0    | 0    | 0    | 0    | 0    | 0    | 0    |
| 2020 | 0    | 0    | 0    | 90   | 0    | 0    | 0    | 0    | 0    | 0    | 0    | 0    |
| 2021 | 0    | 0    | 0    | 156  | 0    | 0    | 0    | 0    | 0    | 0    | 0    | 0    |
| 2022 | 0    | 0    | 0    | 269  | 0    | 0    | 0    | 0    | 0    | 0    | 0    | 0    |
| 2023 | 0    | 0    | 0    | 397  | 0    | 0    | 0    | 0    | 0    | 0    | 0    | 0    |
| 2024 | 0    | 0    | 0    | 541  | 0    | 0    | 0    | 0    | 0    | 0    | 0    | 0    |
| 2025 | 71   | 71   | 0    | 689  | 64   | 174  | 244  | 4    | 71   | 17   | 17   | 0    |
| 2026 | 115  | 194  | 0    | 845  | 128  | 323  | 459  | 10   | 155  | 20   | 87   | 0    |
| 2027 | 188  | 313  | 0    | 1014 | 210  | 492  | 693  | 16   | 250  | 40   | 142  | 0    |
| 2028 | 287  | 510  | 0    | 1200 | 355  | 699  | 975  | 27   | 407  | 67   | 240  | 0    |
| 2029 | 404  | 690  | 0    | 1394 | 514  | 923  | 1281 | 75   | 577  | 137  | 374  | 0    |
| 2030 | 538  | 879  | 66   | 1583 | 676  | 1115 | 1560 | 125  | 730  | 197  | 501  | 10   |
| 2031 | 756  | 1104 | 201  | 1766 | 873  | 1283 | 1845 | 182  | 936  | 304  | 615  | 81   |
| 2032 | 927  | 1309 | 309  | 1977 | 1041 | 1467 | 2111 | 237  | 1102 | 404  | 752  | 143  |
| 2033 | 1085 | 1522 | 446  | 2145 | 1221 | 1614 | 2371 | 295  | 1284 | 471  | 874  | 223  |
| 2034 | 1272 | 1737 | 646  | 2348 | 1411 | 1807 | 2672 | 377  | 1489 | 566  | 998  | 353  |
| 2035 | 1462 | 1951 | 888  | 2534 | 1618 | 1974 | 2959 | 447  | 1694 | 643  | 1108 | 524  |
| 2036 | 1645 | 2156 | 1106 | 2681 | 1821 | 2172 | 3217 | 544  | 1885 | 756  | 1237 | 681  |
| 2037 | 1812 | 2330 | 1304 | 2839 | 1997 | 2355 | 3452 | 620  | 2062 | 843  | 1319 | 819  |
| 2038 | 1978 | 2509 | 1520 | 2980 | 2165 | 2531 | 3665 | 696  | 2223 | 944  | 1448 | 961  |
| 2039 | 2146 | 2677 | 1725 | 3100 | 2323 | 2717 | 3893 | 767  | 2401 | 1059 | 1558 | 1096 |
| 2040 | 2316 | 2838 | 1872 | 3196 | 2483 | 2893 | 4117 | 827  | 2573 | 1157 | 1661 | 1206 |
| 2041 | 2456 | 2994 | 2092 | 3327 | 2663 | 3085 | 4347 | 900  | 2730 | 1231 | 1739 | 1357 |
| 2042 | 2628 | 3162 | 2310 | 3446 | 2852 | 3264 | 4583 | 971  | 2904 | 1352 | 1854 | 1477 |
| 2043 | 2777 | 3333 | 2528 | 3567 | 3005 | 3398 | 4769 | 1036 | 3055 | 1460 | 1963 | 1628 |
| 2044 | 2904 | 3478 | 2709 | 3665 | 3138 | 3539 | 4928 | 1091 | 3198 | 1538 | 2052 | 1757 |
| 2045 | 3006 | 3600 | 2877 | 3686 | 3256 | 3688 | 5081 | 1160 | 3323 | 1631 | 2179 | 1848 |
| 2046 | 3123 | 3697 | 3041 | 3686 | 3364 | 3860 | 5210 | 1206 | 3422 | 1644 | 2220 | 1965 |
| 2047 | 3198 | 3801 | 3192 | 3726 | 3391 | 3931 | 5350 | 1238 | 3510 | 1658 | 2234 | 2082 |
| 2048 | 3198 | 3805 | 3307 | 3801 | 3391 | 3931 | 5352 | 1240 | 3512 | 1681 | 2357 | 2104 |
| 2049 | 3219 | 3931 | 3339 | 3887 | 3454 | 4000 | 5405 | 1293 | 3565 | 1750 | 2554 | 2138 |
| 2050 | 3247 | 4117 | 3342 | 3908 | 3559 | 4118 | 5506 | 1394 | 3666 | 1854 | 2756 | 2218 |
| 2051 | 3312 | 4310 | 3419 | 3926 | 3715 | 4290 | 5676 | 1564 | 3836 | 1936 | 2917 | 2315 |
| 2052 | 3418 | 4475 | 3526 | 3946 | 3874 | 4411 | 5819 | 1707 | 3979 | 1974 | 3023 | 2451 |
| 2053 | 3493 | 4591 | 3679 | 3958 | 3971 | 4489 | 5899 | 1787 | 4059 | 2001 | 3079 | 2648 |
| 2054 | 3528 | 4647 | 3868 | 3962 | 4041 | 4534 | 5969 | 1857 | 4129 | 2024 | 3117 | 2868 |
| 2055 | 3555 | 4685 | 4061 | 3962 | 4085 | 4573 | 6013 | 1901 | 4173 | 2044 | 3138 | 3037 |
| 2056 | 3578 | 4706 | 4225 | 3962 | 4106 | 4594 | 6034 | 1922 | 4194 | 2052 | 3158 | 3141 |
| 2057 | 3598 | 4726 | 4348 | 3962 | 4118 | 4606 | 6046 | 1934 | 4206 | 2052 | 3158 | 3208 |
| 2058 | 3606 | 4736 | 4425 | 3962 | 4128 | 4606 | 6056 | 1944 | 4216 | 2052 | 3158 | 3259 |
| 2059 | 3606 | 4743 | 4478 | 3962 | 4128 | 4606 | 6058 | 1946 | 4218 | 2052 | 3158 | 3285 |

|      | 145  | 146  | 147  | 148  | 149  | 150  | 151  | 152  | 153  | 154  | 155  | 156  |
|------|------|------|------|------|------|------|------|------|------|------|------|------|
| 2060 | 3606 | 4743 | 4500 | 3962 | 4128 | 4606 | 6058 | 1946 | 4218 | 2052 | 3158 | 3300 |
| 2061 | 3606 | 4743 | 4515 | 3962 | 4128 | 4606 | 6058 | 1946 | 4218 | 2052 | 3158 | 3310 |
| 2062 | 3606 | 4743 | 4525 | 3962 | 4128 | 4606 | 6058 | 1946 | 4218 | 2052 | 3158 | 3320 |
| 2063 | 3606 | 4743 | 4535 | 3962 | 4128 | 4606 | 6058 | 1946 | 4218 | 2052 | 3158 | 3320 |
| 2064 | 3606 | 4743 | 4535 | 3962 | 4128 | 4606 | 6058 | 1946 | 4218 | 2052 | 3158 | 3320 |
| 2065 | 3606 | 4743 | 4535 | 3962 | 4128 | 4606 | 6058 | 1946 | 4218 | 2052 | 3158 | 3320 |
| 2066 | 3606 | 4743 | 4535 | 3962 | 4128 | 4606 | 6058 | 1946 | 4218 | 2052 | 3158 | 3320 |
| 2067 | 3606 | 4743 | 4535 | 3962 | 4128 | 4606 | 6058 | 1946 | 4218 | 2052 | 3158 | 3320 |
| 2068 | 3606 | 4743 | 4535 | 3962 | 4128 | 4606 | 6058 | 1946 | 4218 | 2052 | 3158 | 3320 |
| 2069 | 3606 | 4743 | 4535 | 3962 | 4128 | 4606 | 6058 | 1946 | 4218 | 2052 | 3158 | 3320 |
| 2070 | 3606 | 4743 | 4535 | 3962 | 4128 | 4606 | 6058 | 1946 | 4218 | 2052 | 3158 | 3320 |
| 2071 | 3606 | 4743 | 4535 | 3962 | 4128 | 4606 | 6058 | 1946 | 4218 | 2052 | 3158 | 3320 |
| 2072 | 3606 | 4743 | 4535 | 3962 | 4128 | 4606 | 6058 | 1946 | 4218 | 2052 | 3158 | 3320 |
| 2073 | 3606 | 4743 | 4535 | 3962 | 4128 | 4606 | 6058 | 1946 | 4218 | 2052 | 3158 | 3320 |
| 2074 | 3606 | 4743 | 4535 | 3962 | 4128 | 4606 | 6058 | 1946 | 4218 | 2052 | 3158 | 3320 |
| 2075 | 3606 | 4743 | 4535 | 3962 | 4128 | 4606 | 6058 | 1946 | 4218 | 2052 | 3158 | 3320 |
| 2076 | 3606 | 4743 | 4535 | 3962 | 4128 | 4606 | 6058 | 1946 | 4218 | 2052 | 3158 | 3320 |
| 2077 | 3606 | 4743 | 4535 | 3962 | 4128 | 4606 | 6058 | 1946 | 4218 | 2052 | 3158 | 3320 |
| 2078 | 3606 | 4743 | 4535 | 3962 | 4128 | 4606 | 6058 | 1946 | 4218 | 2052 | 3158 | 3320 |
| 2079 | 3606 | 4743 | 4535 | 3962 | 4128 | 4606 | 6058 | 1946 | 4218 | 2052 | 3158 | 3320 |
| 2080 | 3606 | 4743 | 4535 | 3962 | 4128 | 4606 | 6058 | 1946 | 4218 | 2052 | 3158 | 3320 |
| 2081 | 3606 | 4743 | 4535 | 3962 | 4128 | 4606 | 6058 | 1946 | 4218 | 2052 | 3158 | 3320 |
| 2082 | 3606 | 4743 | 4535 | 3962 | 4128 | 4606 | 6058 | 1946 | 4218 | 2052 | 3158 | 3320 |
| 2083 | 3606 | 4743 | 4535 | 3962 | 4128 | 4606 | 6058 | 1946 | 4218 | 2052 | 3158 | 3320 |
| 2084 | 3606 | 4743 | 4535 | 3962 | 4128 | 4606 | 6058 | 1946 | 4218 | 2052 | 3158 | 3320 |
| 2085 | 3606 | 4743 | 4535 | 3962 | 4128 | 4606 | 6058 | 1946 | 4218 | 2052 | 3158 | 3320 |
| 2086 | 3606 | 4743 | 4535 | 3962 | 4128 | 4606 | 6058 | 1946 | 4218 | 2052 | 3158 | 3320 |
| 2087 | 3606 | 4743 | 4535 | 3962 | 4128 | 4606 | 6058 | 1946 | 4218 | 2052 | 3158 | 3320 |
| 2088 | 3606 | 4743 | 4535 | 3962 | 4128 | 4606 | 6058 | 1946 | 4218 | 2052 | 3158 | 3320 |
| 2089 | 3606 | 4743 | 4535 | 3962 | 4128 | 4606 | 6058 | 1946 | 4218 | 2052 | 3158 | 3320 |
| 2090 | 3606 | 4743 | 4535 | 3962 | 4128 | 4606 | 6058 | 1946 | 4218 | 2052 | 3158 | 3320 |

|      | 157  | 158  | 159  | 160  | 161  | 162  |
|------|------|------|------|------|------|------|
| 2002 | 0    | 0    | 0    | 0    | 0    | 0    |
| 2003 | 0    | 0    | 0    | 0    | 0    | 0    |
| 2004 | 0    | 0    | 0    | 0    | 0    | 0    |
| 2005 | 0    | 0    | 0    | 0    | 0    | 0    |
| 2006 | 0    | 0    | 0    | 0    | 0    | 0    |
| 2007 | 0    | 0    | 0    | 0    | 0    | 0    |
| 2008 | 0    | 0    | 0    | 0    | 0    | 0    |
| 2009 | 0    | 0    | 0    | 0    | 0    | 0    |
| 2010 | 0    | 0    | 0    | 0    | 0    | 0    |
| 2011 | 0    | 0    | 0    | 0    | 0    | 0    |
| 2012 | 0    | 0    | 0    | 0    | 0    | 0    |
| 2013 | 0    | 0    | 0    | 0    | 0    | 0    |
| 2014 | 0    | 0    | 0    | 0    | 0    | 0    |
| 2015 | 0    | 0    | 0    | 0    | 0    | 0    |
| 2016 | 0    | 0    | 0    | 0    | 0    | 0    |
| 2017 | 0    | 0    | 0    | 0    | 0    | 0    |
| 2018 | 0    | 0    | 0    | 0    | 0    | 0    |
| 2019 | 0    | 0    | 0    | 0    | 0    | 0    |
| 2020 | 10   | 0    | 0    | 0    | 0    | 0    |
| 2021 | 20   | 0    | 0    | 0    | 0    | 0    |
| 2022 | 44   | 0    | 0    | 0    | 0    | 0    |
| 2023 | 96   | 0    | 0    | 0    | 0    | 0    |
| 2024 | 147  | 0    | 0    | 0    | 0    | 0    |
| 2025 | 219  | 12   | 63   | 64   | 1    | 17   |
| 2026 | 289  | 20   | 164  | 148  | 1    | 44   |
| 2027 | 361  | 35   | 257  | 260  | 2    | 80   |
| 2028 | 421  | 78   | 445  | 428  | 7    | 156  |
| 2029 | 492  | 153  | 643  | 615  | 18   | 269  |
| 2030 | 580  | 212  | 784  | 771  | 42   | 363  |
| 2031 | 657  | 273  | 939  | 951  | 62   | 458  |
| 2032 | 763  | 337  | 1088 | 1126 | 87   | 554  |
| 2033 | 844  | 388  | 1188 | 1282 | 132  | 646  |
| 2034 | 941  | 472  | 1343 | 1472 | 186  | 759  |
| 2035 | 1016 | 548  | 1471 | 1673 | 239  | 863  |
| 2036 | 1127 | 651  | 1629 | 1864 | 300  | 979  |
| 2037 | 1210 | 734  | 1761 | 2056 | 349  | 1064 |
| 2038 | 1301 | 805  | 1899 | 2250 | 420  | 1181 |
| 2039 | 1362 | 867  | 2007 | 2450 | 478  | 1297 |
| 2040 | 1434 | 926  | 2177 | 2644 | 530  | 1401 |
| 2041 | 1528 | 994  | 2310 | 2843 | 584  | 1478 |
| 2042 | 1644 | 1055 | 2521 | 3084 | 629  | 1597 |
| 2043 | 1699 | 1152 | 2658 | 3276 | 700  | 1707 |
| 2044 | 1713 | 1216 | 2820 | 3472 | 748  | 1792 |
| 2045 | 1749 | 1289 | 2982 | 3659 | 803  | 1902 |
| 2046 | 1805 | 1309 | 3010 | 3678 | 822  | 1921 |
| 2047 | 1899 | 1319 | 3033 | 3732 | 876  | 1975 |
| 2048 | 1932 | 1369 | 3119 | 3834 | 978  | 2077 |
| 2049 | 1950 | 1461 | 3225 | 3993 | 1137 | 2236 |
| 2050 | 1962 | 1632 | 3389 | 4143 | 1287 | 2386 |
| 2051 | 1972 | 1774 | 3495 | 4242 | 1386 | 2485 |
| 2052 | 1972 | 1864 | 3561 | 4310 | 1454 | 2553 |
| 2053 | 1972 | 1929 | 3606 | 4354 | 1498 | 2597 |
| 2054 | 1972 | 1968 | 3645 | 4375 | 1519 | 2618 |
| 2055 | 1972 | 1989 | 3666 | 4387 | 1531 | 2630 |
| 2056 | 1972 | 2001 | 3678 | 4397 | 1541 | 2640 |
| 2057 | 1972 | 2011 | 3688 | 4399 | 1543 | 2642 |
| 2058 | 1972 | 2013 | 3688 | 4399 | 1543 | 2642 |
| 2059 | 1972 | 2013 | 3688 | 4399 | 1543 | 2642 |

|      | 157  | 158  | 159  | 160  | 161  | 162  |
|------|------|------|------|------|------|------|
| 2060 | 1972 | 2013 | 3688 | 4399 | 1543 | 2642 |
| 2061 | 1972 | 2013 | 3688 | 4399 | 1543 | 2642 |
| 2062 | 1972 | 2013 | 3688 | 4399 | 1543 | 2642 |
| 2063 | 1972 | 2013 | 3688 | 4399 | 1543 | 2642 |
| 2064 | 1972 | 2013 | 3688 | 4399 | 1543 | 2642 |
| 2065 | 1972 | 2013 | 3688 | 4399 | 1543 | 2642 |
| 2066 | 1972 | 2013 | 3688 | 4399 | 1543 | 2642 |
| 2067 | 1972 | 2013 | 3688 | 4399 | 1543 | 2642 |
| 2068 | 1972 | 2013 | 3688 | 4399 | 1543 | 2642 |
| 2069 | 1972 | 2013 | 3688 | 4399 | 1543 | 2642 |
| 2070 | 1972 | 2013 | 3688 | 4399 | 1543 | 2642 |
| 2071 | 1972 | 2013 | 3688 | 4399 | 1543 | 2642 |
| 2072 | 1972 | 2013 | 3688 | 4399 | 1543 | 2642 |
| 2073 | 1972 | 2013 | 3688 | 4399 | 1543 | 2642 |
| 2074 | 1972 | 2013 | 3688 | 4399 | 1543 | 2642 |
| 2075 | 1972 | 2013 | 3688 | 4399 | 1543 | 2642 |
| 2076 | 1972 | 2013 | 3688 | 4399 | 1543 | 2642 |
| 2077 | 1972 | 2013 | 3688 | 4399 | 1543 | 2642 |
| 2078 | 1972 | 2013 | 3688 | 4399 | 1543 | 2642 |
| 2079 | 1972 | 2013 | 3688 | 4399 | 1543 | 2642 |
| 2080 | 1972 | 2013 | 3688 | 4399 | 1543 | 2642 |
| 2081 | 1972 | 2013 | 3688 | 4399 | 1543 | 2642 |
| 2082 | 1972 | 2013 | 3688 | 4399 | 1543 | 2642 |
| 2083 | 1972 | 2013 | 3688 | 4399 | 1543 | 2642 |
| 2084 | 1972 | 2013 | 3688 | 4399 | 1543 | 2642 |
| 2085 | 1972 | 2013 | 3688 | 4399 | 1543 | 2642 |
| 2086 | 1972 | 2013 | 3688 | 4399 | 1543 | 2642 |
| 2087 | 1972 | 2013 | 3688 | 4399 | 1543 | 2642 |
| 2088 | 1972 | 2013 | 3688 | 4399 | 1543 | 2642 |
| 2089 | 1972 | 2013 | 3688 | 4399 | 1543 | 2642 |
| 2090 | 1972 | 2013 | 3688 | 4399 | 1543 | 2642 |

|      | 1 | 2 | 3 | 4 | 5 | 6 | 7 | 8 | 9 | 10 | 11 | 12 |
|------|---|---|---|---|---|---|---|---|---|----|----|----|
| 2002 | 0 | 0 | 0 | 0 | 0 | 0 | 0 | 0 | 0 | 0  | 0  | 0  |
| 2003 | 0 | 0 | 0 | 0 | 0 | 0 | 0 | 0 | 0 | 0  | 0  | 0  |
| 2004 | 0 | 0 | 0 | 0 | 0 | 0 | 0 | 0 | 0 | 0  | 0  | 0  |
| 2005 | 0 | 0 | 0 | 0 | 0 | 0 | 0 | 0 | 0 | 0  | 0  | 0  |
| 2006 | 0 | 0 | 0 | 0 | 0 | 0 | 0 | 0 | 0 | 0  | 0  | 0  |
| 2007 | 0 | 0 | 0 | 0 | 0 | 0 | 0 | 0 | 0 | 0  | 0  | 0  |
| 2008 | 0 | 0 | 0 | 0 | 0 | 0 | 0 | 0 | 0 | 0  | 0  | 0  |
| 2009 | 0 | 0 | 0 | 0 | 0 | 0 | 0 | 0 | 0 | 0  | 0  | 0  |
| 2010 | 0 | 0 | 0 | 0 | 0 | 0 | 0 | 0 | 0 | 0  | 0  | 0  |
| 2011 | 0 | 0 | 0 | 0 | 0 | 0 | 0 | 0 | 0 | 0  | 0  | 0  |
| 2012 | 0 | 0 | 0 | 0 | 0 | 0 | 0 | 0 | 0 | 0  | 0  | 0  |
| 2013 | 0 | 0 | 0 | 0 | 0 | 0 | 0 | 0 | 0 | 0  | 0  | 0  |
| 2014 | 0 | 0 | 0 | 0 | 0 | 0 | 0 | 0 | 0 | 0  | 0  | 0  |
| 2015 | 0 | 0 | 0 | 0 | 0 | 0 | 0 | 0 | 0 | 0  | 0  | 0  |
| 2016 | 0 | 0 | 0 | 0 | 0 | 0 | 0 | 0 | 0 | 0  | 0  | 0  |
| 2017 | 0 | 0 | 0 | 0 | 0 | 0 | 0 | 0 | 0 | 0  | 0  | 0  |
| 2018 | 0 | 0 | 0 | 0 | 0 | 0 | 0 | 0 | 0 | 0  | 0  | 0  |
| 2019 | 0 | 0 | 0 | 0 | 0 | 0 | 0 | 0 | 0 | 0  | 0  | 0  |
| 2020 | 0 | 0 | 0 | 0 | 0 | 0 | 0 | 0 | 0 | 0  | 0  | 0  |
| 2021 | 0 | 0 | 0 | 0 | 0 | 0 | 0 | 0 | 0 | 0  | 0  | 0  |
| 2022 | 0 | 0 | 0 | 0 | 0 | 0 | 0 | 0 | 0 | 0  | 0  | 0  |
| 2023 | 0 | 0 | 0 | 0 | 0 | 0 | 0 | 0 | 0 | 0  | 0  | 0  |
| 2024 | 0 | 0 | 0 | 0 | 0 | 0 | 0 | 0 | 0 | 0  | 0  | 0  |
| 2025 | 0 | 0 | 0 | 0 | 0 | 0 | 0 | 0 | 0 | 0  | 0  | 0  |
| 2026 | 0 | 0 | 0 | 0 | 0 | 0 | 0 | 0 | 0 | 0  | 0  | 0  |
| 2027 | 0 | 0 | 0 | 0 | 0 | 0 | 0 | 0 | 0 | 0  | 0  | 0  |
| 2028 | 0 | 0 | 0 | 0 | 0 | 0 | 0 | 0 | 0 | 0  | 0  | 0  |
| 2029 | 0 | 0 | 0 | 0 | 0 | 0 | 0 | 0 | 0 | 0  | 0  | 0  |
| 2030 | 0 | 0 | 0 | 0 | 0 | 0 | 0 | 0 | 0 | 0  | 0  | 0  |
| 2031 | 0 | 0 | 0 | 0 | 0 | 0 | 0 | 0 | 0 | 0  | 0  | 0  |
| 2032 | 0 | 0 | 0 | 0 | 0 | 0 | 0 | 0 | 0 | 0  | 0  | 0  |
| 2033 | 0 | 0 | 0 | 0 | 0 | 0 | 0 | 0 | 0 | 0  | 0  | 0  |
| 2034 | 0 | 0 | 0 | 0 | 0 | 0 | 0 | 0 | 0 | 0  | 0  | 0  |
| 2035 | 0 | 0 | 0 | 0 | 0 | 0 | 0 | 0 | 0 | 0  | 0  | 0  |
| 2036 | 0 | 0 | 0 | 0 | 0 | 0 | 0 | 0 | 0 | 0  | 0  | 0  |
| 2037 | 0 | 0 | 0 | 0 | 0 | 0 | 0 | 0 | 0 | 0  | 0  | 0  |
| 2038 | 0 | 0 | 0 | 0 | 0 | 0 | 0 | 0 | 0 | 0  | 0  | 0  |
| 2039 | 0 | 0 | 0 | 0 | 0 | 0 | 0 | 0 | 0 | 0  | 0  | 0  |
| 2040 | 0 | 0 | 0 | 0 | 0 | 0 | 0 | 0 | 0 | 0  | 0  | 0  |
| 2041 | 0 | 0 | 0 | 0 | 0 | 0 | 0 | 0 | 0 | 0  | 0  | 0  |
| 2042 | 0 | 0 | 0 | 0 | 0 | 0 | 0 | 0 | 0 | 0  | 0  | 0  |
| 2043 | 0 | 0 | 0 | 0 | 0 | 0 | 0 | 0 | 0 | 0  | 0  | 0  |
| 2044 | 0 | 0 | 0 | 0 | 0 | 0 | 0 | 0 | 0 | 0  | 0  | 0  |
| 2045 | 0 | 0 | 0 | 0 | 0 | 0 | 0 | 0 | 0 | 0  | 0  | 0  |
| 2046 | 0 | 0 | 0 | 0 | 0 | 0 | 0 | 0 | 0 | 0  | 0  | 0  |
| 2047 | 0 | 0 | 0 | 0 | 0 | 0 | 0 | 0 | 0 | 0  | 0  | 0  |
| 2048 | 0 | 0 | 0 | 0 | 0 | 0 | 0 | 0 | 0 | 0  | 0  | 0  |
| 2049 | 0 | 0 | 0 | 0 | 0 | 0 | 0 | 0 | 0 | 0  | 0  | 0  |
| 2050 | 0 | 0 | 0 | 0 | 0 | 0 | 0 | 0 | 0 | 0  | 0  | 0  |
| 2051 | 0 | 0 | 0 | 0 | 0 | 0 | 0 | 0 | 0 | 0  | 0  | 0  |
| 2052 | 0 | 0 | 0 | 0 | 0 | 0 | 0 | 0 | 0 | 0  | 0  | 0  |
| 2053 | 0 | 0 | 0 | 0 | 0 | 0 | 0 | 0 | 0 | 0  | 0  | 0  |
| 2054 | 0 | 0 | 0 | 0 | 0 | 0 | 0 | 0 | 0 | 0  | 0  | 0  |
| 2055 | 0 | 0 | 0 | 0 | 0 | 0 | 0 | 0 | 0 | 0  | 0  | 0  |
| 2056 | 0 | 0 | 0 | 0 | 0 | 0 | 0 | 0 | 0 | 0  | 0  | 0  |
| 2057 | 0 | 0 | 0 | 0 | 0 | 0 | 0 | 0 | 0 | 0  | 0  | 0  |
| 2058 | 0 | 0 | 0 | 0 | 0 | 0 | 0 | 0 | 0 | 0  | 0  | 0  |
| 2059 | 0 | 0 | 0 | 0 | 0 | 0 | 0 | 0 | 0 | 0  | 0  | 0  |

|      | 1 | 2 | 3 | 4 | 5 | 6 | 7 | 8 | 9 | 10 | 11 | 12 |
|------|---|---|---|---|---|---|---|---|---|----|----|----|
| 2060 | 0 | 0 | 0 | 0 | 0 | 0 | 0 | 0 | 0 | 0  | 0  | 0  |
| 2061 | 0 | 0 | 0 | 0 | 0 | 0 | 0 | 0 | 0 | 0  | 0  | 0  |
| 2062 | 0 | 0 | 0 | 0 | 0 | 0 | 0 | 0 | 0 | 0  | 0  | 0  |
| 2063 | 0 | 0 | 0 | 0 | 0 | 0 | 0 | 0 | 0 | 0  | 0  | 0  |
| 2064 | 0 | 0 | 0 | 0 | 0 | 0 | 0 | 0 | 0 | 0  | 0  | 0  |
| 2065 | 0 | 0 | 0 | 0 | 0 | 0 | 0 | 0 | 0 | 0  | 0  | 0  |
| 2066 | 0 | 0 | 0 | 0 | 0 | 0 | 0 | 0 | 0 | 0  | 0  | 0  |
| 2067 | 0 | 0 | 0 | 0 | 0 | 0 | 0 | 0 | 0 | 0  | 0  | 0  |
| 2068 | 0 | 0 | 0 | 0 | 0 | 0 | 0 | 0 | 0 | 0  | 0  | 0  |
| 2069 | 0 | 0 | 0 | 0 | 0 | 0 | 0 | 0 | 0 | 0  | 0  | 0  |
| 2070 | 0 | 0 | 0 | 0 | 0 | 0 | 0 | 0 | 0 | 0  | 0  | 0  |
| 2071 | 0 | 0 | 0 | 0 | 0 | 0 | 0 | 0 | 0 | 0  | 0  | 0  |
| 2072 | 0 | 0 | 0 | 0 | 0 | 0 | 0 | 0 | 0 | 0  | 0  | 0  |
| 2073 | 0 | 0 | 0 | 0 | 0 | 0 | 0 | 0 | 0 | 0  | 0  | 0  |
| 2074 | 0 | 0 | 0 | 0 | 0 | 0 | 0 | 0 | 0 | 0  | 0  | 0  |
| 2075 | 0 | 0 | 0 | 0 | 0 | 0 | 0 | 0 | 0 | 0  | 0  | 0  |
| 2076 | 0 | 0 | 0 | 0 | 0 | 0 | 0 | 0 | 0 | 0  | 0  | 0  |
| 2077 | 0 | 0 | 0 | 0 | 0 | 0 | 0 | 0 | 0 | 0  | 0  | 0  |
| 2078 | 0 | 0 | 0 | 0 | 0 | 0 | 0 | 0 | 0 | 0  | 0  | 0  |
| 2079 | 0 | 0 | 0 | 0 | 0 | 0 | 0 | 0 | 0 | 0  | 0  | 0  |
| 2080 | 0 | 0 | 0 | 0 | 0 | 0 | 0 | 0 | 0 | 0  | 0  | 0  |
| 2081 | 0 | 0 | 0 | 0 | 0 | 0 | 0 | 0 | 0 | 0  | 0  | 0  |
| 2082 | 0 | 0 | 0 | 0 | 0 | 0 | 0 | 0 | 0 | 0  | 0  | 0  |
| 2083 | 0 | 0 | 0 | 0 | 0 | 0 | 0 | 0 | 0 | 0  | 0  | 0  |
| 2084 | 0 | 0 | 0 | 0 | 0 | 0 | 0 | 0 | 0 | 0  | 0  | 0  |
| 2085 | 0 | 0 | 0 | 0 | 0 | 0 | 0 | 0 | 0 | 0  | 0  | 0  |
| 2086 | 0 | 0 | 0 | 0 | 0 | 0 | 0 | 0 | 0 | 0  | 0  | 0  |
| 2087 | 0 | 0 | 0 | 0 | 0 | 0 | 0 | 0 | 0 | 0  | 0  | 0  |
| 2088 | 0 | 0 | 0 | 0 | 0 | 0 | 0 | 0 | 0 | 0  | 0  | 0  |
| 2089 | 0 | 0 | 0 | 0 | 0 | 0 | 0 | 0 | 0 | 0  | 0  | 0  |
| 2090 | 0 | 0 | 0 | 0 | 0 | 0 | 0 | 0 | 0 | 0  | 0  | 0  |

|      | 13 | 14 | 15 | 16 | 17 | 18 | 19 | 20 | 21 | 22 | 23 | 24 |
|------|----|----|----|----|----|----|----|----|----|----|----|----|
| 2002 | 0  | 0  | 0  | 0  | 0  | 0  | 0  | 0  | 0  | 0  | 0  | 0  |
| 2003 | 0  | 0  | 0  | 0  | 0  | 0  | 0  | 0  | 0  | 0  | 0  | 0  |
| 2004 | 0  | 0  | 0  | 0  | 0  | 0  | 0  | 0  | 0  | 0  | 0  | 0  |
| 2005 | 0  | 0  | 0  | 0  | 0  | 0  | 0  | 0  | 0  | 0  | 0  | 0  |
| 2006 | 0  | 0  | 0  | 0  | 0  | 0  | 0  | 0  | 0  | 0  | 0  | 0  |
| 2007 | 0  | 0  | 0  | 0  | 0  | 0  | 0  | 0  | 0  | 0  | 0  | 0  |
| 2008 | 0  | 0  | 0  | 0  | 0  | 0  | 0  | 0  | 0  | 0  | 0  | 0  |
| 2009 | 0  | 0  | 0  | 0  | 0  | 0  | 0  | 0  | 0  | 0  | 0  | 0  |
| 2010 | 0  | 0  | 0  | 0  | 0  | 0  | 0  | 0  | 0  | 0  | 0  | 0  |
| 2011 | 0  | 0  | 0  | 0  | 0  | 0  | 0  | 0  | 0  | 0  | 0  | 0  |
| 2012 | 0  | 0  | 0  | 0  | 0  | 0  | 0  | 0  | 0  | 0  | 0  | 0  |
| 2013 | 0  | 0  | 0  | 0  | 0  | 0  | 0  | 0  | 0  | 0  | 0  | 0  |
| 2014 | 0  | 0  | 0  | 0  | 0  | 0  | 0  | 0  | 0  | 0  | 0  | 0  |
| 2015 | 0  | 0  | 0  | 0  | 0  | 0  | 0  | 0  | 0  | 0  | 0  | 0  |
| 2016 | 0  | 0  | 0  | 0  | 0  | 0  | 0  | 0  | 0  | 0  | 0  | 0  |
| 2017 | 0  | 0  | 0  | 0  | 0  | 0  | 0  | 0  | 0  | 0  | 0  | 0  |
| 2018 | 0  | 0  | 0  | 0  | 0  | 0  | 0  | 0  | 0  | 0  | 0  | 0  |
| 2019 | 0  | 0  | 0  | 0  | 0  | 0  | 0  | 0  | 0  | 0  | 0  | 0  |
| 2020 | 0  | 0  | 0  | 0  | 0  | 0  | 0  | 0  | 0  | 0  | 0  | 0  |
| 2021 | 0  | 0  | 0  | 0  | 0  | 0  | 0  | 0  | 0  | 4  | 0  | 0  |
| 2022 | 0  | 0  | 0  | 0  | 0  | 0  | 0  | 0  | 0  | 4  | 0  | 0  |
| 2023 | 0  | 0  | 0  | 0  | 0  | 0  | 0  | 0  | 0  | 9  | 0  | 0  |
| 2024 | 0  | 0  | 0  | 0  | 0  | 0  | 0  | 0  | 0  | 9  | 0  | 0  |
| 2025 | 0  | 0  | 0  | 0  | 0  | 0  | 0  | 0  | 0  | 9  | 0  | 0  |
| 2026 | 0  | 0  | 0  | 0  | 0  | 0  | 0  | 0  | 0  | 9  | 0  | 0  |
| 2027 | 0  | 0  | 0  | 0  | 6  | 0  | 2  | 0  | 0  | 9  | 0  | 1  |
| 2028 | 0  | 0  | 0  | 0  | 6  | 0  | 2  | 0  | 0  | 9  | 0  | 1  |
| 2029 | 0  | 0  | 0  | 0  | 7  | 0  | 7  | 0  | 0  | 9  | 0  | 1  |
| 2030 | 0  | 0  | 0  | 0  | 7  | 0  | 7  | 0  | 0  | 9  | 0  | 1  |
| 2031 | 0  | 0  | 0  | 0  | 7  | 0  | 7  | 0  | 0  | 9  | 0  | 1  |
| 2032 | 0  | 0  | 0  | 0  | 7  | 0  | 7  | 0  | 0  | 9  | 0  | 1  |
| 2033 | 0  | 0  | 0  | 0  | 7  | 0  | 7  | 0  | 0  | 9  | 0  | 1  |
| 2034 | 0  | 0  | 0  | 0  | 7  | 0  | 7  | 0  | 0  | 9  | 0  | 1  |
| 2035 | 0  | 0  | 0  | 0  | 7  | 0  | 7  | 0  | 0  | 9  | 0  | 1  |
| 2036 | 0  | 0  | 0  | 0  | 7  | 0  | 7  | 0  | 0  | 9  | 0  | 1  |
| 2037 | 0  | 0  | 0  | 0  | 7  | 0  | 7  | 0  | 0  | 9  | 0  | 1  |
| 2038 | 0  | 0  | 0  | 0  | 7  | 0  | 7  | 0  | 0  | 9  | 0  | 1  |
| 2039 | 0  | 0  | 0  | 0  | 7  | 0  | 7  | 0  | 0  | 9  | 0  | 1  |
| 2040 | 0  | 0  | 0  | 0  | 7  | 0  | 7  | 0  | 0  | 9  | 0  | 1  |
| 2041 | 0  | 0  | 0  | 0  | 7  | 0  | 7  | 0  | 0  | 9  | 0  | 1  |
| 2042 | 0  | 0  | 0  | 0  | 7  | 0  | 7  | 0  | 0  | 9  | 0  | 1  |
| 2043 | 0  | 0  | 0  | 0  | 7  | 0  | 7  | 0  | 0  | 9  | 0  | 1  |
| 2044 | 0  | 0  | 0  | 0  | 7  | 0  | 7  | 0  | 0  | 9  | 0  | 1  |
| 2045 | 0  | 0  | 0  | 0  | 7  | 0  | 7  | 0  | 0  | 9  | 0  | 1  |
| 2046 | 0  | 0  | 0  | 0  | 7  | 0  | 7  | 0  | 0  | 9  | 0  | 1  |
| 2047 | 0  | 0  | 0  | 0  | 7  | 0  | 7  | 0  | 0  | 9  | 0  | 1  |
| 2048 | 0  | 0  | 0  | 0  | 7  | 0  | 7  | 0  | 0  | 9  | 0  | 1  |
| 2049 | 0  | 0  | 0  | 0  | 7  | 0  | 7  | 0  | 0  | 9  | 0  | 1  |
| 2050 | 0  | 0  | 0  | 0  | 7  | 0  | 7  | 0  | 0  | 9  | 0  | 1  |
| 2051 | 0  | 0  | 0  | 0  | 7  | 0  | 7  | 0  | 0  | 9  | 0  | 1  |
| 2052 | 0  | 0  | 0  | 0  | 7  | 0  | 7  | 0  | 0  | 9  | 0  | 1  |
| 2053 | 0  | 0  | 0  | 0  | 7  | 0  | 7  | 0  | 0  | 9  | 0  | 1  |
| 2054 | 0  | 0  | 0  | 0  | 7  | 0  | 7  | 0  | 0  | 9  | 0  | 1  |
| 2055 | 0  | 0  | 0  | 0  | 7  | 0  | 7  | 0  | 0  | 9  | 0  | 1  |
| 2056 | 0  | 0  | 0  | 0  | 7  | 0  | 7  | 0  | 0  | 9  | 0  | 1  |
| 2057 | 0  | 0  | 0  | 0  | 7  | 0  | 7  | 0  | 0  | 9  | 0  | 1  |
| 2058 | 0  | 0  | 0  | 0  | 7  | 0  | 7  | 0  | 0  | 9  | 0  | 1  |
| 2059 | 0  | 0  | 0  | 0  | 7  | 0  | 7  | 0  | 0  | 9  | 0  | 1  |

|      | 13 | 14 | 15 | 16 | 17 | 18 | 19 | 20 | 21 | 22 | 23 | 24 |
|------|----|----|----|----|----|----|----|----|----|----|----|----|
| 2060 | 0  | 0  | 0  | 0  | 7  | 0  | 7  | 0  | 0  | 9  | 0  | 1  |
| 2061 | 0  | 0  | 0  | 0  | 7  | 0  | 7  | 0  | 0  | 9  | 0  | 1  |
| 2062 | 0  | 0  | 0  | 0  | 7  | 0  | 7  | 0  | 0  | 9  | 0  | 1  |
| 2063 | 0  | 0  | 0  | 0  | 7  | 0  | 7  | 0  | 0  | 9  | 0  | 1  |
| 2064 | 0  | 0  | 0  | 0  | 7  | 0  | 7  | 0  | 0  | 9  | 0  | 1  |
| 2065 | 0  | 0  | 0  | 0  | 7  | 0  | 7  | 0  | 0  | 9  | 0  | 1  |
| 2066 | 0  | 0  | 0  | 0  | 7  | 0  | 7  | 0  | 0  | 9  | 0  | 1  |
| 2067 | 0  | 0  | 0  | 0  | 7  | 0  | 7  | 0  | 0  | 9  | 0  | 1  |
| 2068 | 0  | 0  | 0  | 0  | 7  | 0  | 7  | 0  | 0  | 9  | 0  | 1  |
| 2069 | 0  | 0  | 0  | 0  | 7  | 0  | 7  | 0  | 0  | 9  | 0  | 1  |
| 2070 | 0  | 0  | 0  | 0  | 7  | 0  | 7  | 0  | 0  | 9  | 0  | 1  |
| 2071 | 0  | 0  | 0  | 0  | 7  | 0  | 7  | 0  | 0  | 9  | 0  | 1  |
| 2072 | 0  | 0  | 0  | 0  | 7  | 0  | 7  | 0  | 0  | 9  | 0  | 1  |
| 2073 | 0  | 0  | 0  | 0  | 7  | 0  | 7  | 0  | 0  | 9  | 0  | 1  |
| 2074 | 0  | 0  | 0  | 0  | 7  | 0  | 7  | 0  | 0  | 9  | 0  | 1  |
| 2075 | 0  | 0  | 0  | 0  | 7  | 0  | 7  | 0  | 0  | 9  | 0  | 1  |
| 2076 | 0  | 0  | 0  | 0  | 7  | 0  | 7  | 0  | 0  | 9  | 0  | 1  |
| 2077 | 0  | 0  | 0  | 0  | 7  | 0  | 7  | 0  | 0  | 9  | 0  | 1  |
| 2078 | 0  | 0  | 0  | 0  | 7  | 0  | 7  | 0  | 0  | 9  | 0  | 1  |
| 2079 | 0  | 0  | 0  | 0  | 7  | 0  | 7  | 0  | 0  | 9  | 0  | 1  |
| 2080 | 0  | 0  | 0  | 0  | 7  | 0  | 7  | 0  | 0  | 9  | 0  | 1  |
| 2081 | 0  | 0  | 0  | 0  | 7  | 0  | 7  | 0  | 0  | 9  | 0  | 1  |
| 2082 | 0  | 0  | 0  | 0  | 7  | 0  | 7  | 0  | 0  | 9  | 0  | 1  |
| 2083 | 0  | 0  | 0  | 0  | 7  | 0  | 7  | 0  | 0  | 9  | 0  | 1  |
| 2084 | 0  | 0  | 0  | 0  | 7  | 0  | 7  | 0  | 0  | 9  | 0  | 1  |
| 2085 | 0  | 0  | 0  | 0  | 7  | 0  | 7  | 0  | 0  | 9  | 0  | 1  |
| 2086 | 0  | 0  | 0  | 0  | 7  | 0  | 7  | 0  | 0  | 9  | 0  | 1  |
| 2087 | 0  | 0  | 0  | 0  | 7  | 0  | 7  | 0  | 0  | 9  | 0  | 1  |
| 2088 | 0  | 0  | 0  | 0  | 7  | 0  | 7  | 0  | 0  | 9  | 0  | 1  |
| 2089 | 0  | 0  | 0  | 0  | 7  | 0  | 7  | 0  | 0  | 9  | 0  | 1  |
| 2090 | 0  | 0  | 0  | 0  | 7  | 0  | 7  | 0  | 0  | 9  | 0  | 1  |



|      | 25 | 26 | 27 | 28 | 29 | 30 | 31 | 32 | 33 | 34 | 35 | 36 |
|------|----|----|----|----|----|----|----|----|----|----|----|----|
| 2002 | 0  | 0  | 0  | 0  | 0  | 0  | 0  | 0  | 0  | 0  | 0  | 0  |
| 2003 | 0  | 0  | 0  | 0  | 0  | 0  | 0  | 0  | 0  | 0  | 0  | 0  |
| 2004 | 0  | 0  | 0  | 0  | 0  | 0  | 0  | 0  | 0  | 0  | 0  | 0  |
| 2005 | 0  | 0  | 0  | 0  | 0  | 0  | 0  | 0  | 0  | 0  | 0  | 0  |
| 2006 | 0  | 0  | 0  | 0  | 0  | 0  | 0  | 0  | 0  | 0  | 0  | 0  |
| 2007 | 0  | 0  | 0  | 0  | 0  | 0  | 0  | 0  | 0  | 0  | 0  | 0  |
| 2008 | 0  | 0  | 0  | 0  | 0  | 0  | 0  | 0  | 0  | 0  | 0  | 0  |
| 2009 | 0  | 0  | 0  | 0  | 0  | 0  | 0  | 0  | 0  | 0  | 0  | 0  |
| 2010 | 0  | 0  | 0  | 0  | 0  | 0  | 0  | 0  | 0  | 0  | 0  | 0  |
| 2011 | 0  | 0  | 0  | 0  | 0  | 0  | 0  | 0  | 0  | 0  | 0  | 0  |
| 2012 | 0  | 0  | 0  | 0  | 0  | 0  | 0  | 0  | 0  | 0  | 0  | 0  |
| 2013 | 0  | 0  | 0  | 0  | 0  | 0  | 0  | 0  | 0  | 0  | 0  | 0  |
| 2014 | 0  | 0  | 0  | 0  | 0  | 0  | 0  | 0  | 0  | 0  | 0  | 0  |
| 2015 | 0  | 0  | 0  | 0  | 0  | 0  | 0  | 0  | 0  | 0  | 0  | 0  |
| 2016 | 0  | 0  | 0  | 0  | 0  | 0  | 0  | 0  | 0  | 0  | 0  | 0  |
| 2017 | 0  | 0  | 0  | 0  | 0  | 0  | 0  | 0  | 0  | 0  | 0  | 0  |
| 2018 | 0  | 0  | 0  | 0  | 0  | 0  | 0  | 0  | 0  | 0  | 0  | 0  |
| 2019 | 0  | 0  | 0  | 0  | 0  | 0  | 0  | 0  | 0  | 0  | 0  | 0  |
| 2020 | 0  | 0  | 0  | 0  | 0  | 0  | 0  | 0  | 0  | 0  | 0  | 0  |
| 2021 | 0  | 0  | 0  | 0  | 0  | 0  | 0  | 0  | 0  | 0  | 0  | 0  |
| 2022 | 0  | 0  | 0  | 0  | 0  | 0  | 0  | 0  | 0  | 0  | 0  | 0  |
| 2023 | 0  | 0  | 0  | 0  | 0  | 0  | 0  | 0  | 0  | 0  | 0  | 0  |
| 2024 | 0  | 0  | 0  | 0  | 0  | 0  | 0  | 0  | 0  | 0  | 0  | 0  |
| 2025 | 0  | 0  | 0  | 0  | 0  | 0  | 0  | 0  | 0  | 0  | 0  | 0  |
| 2026 | 0  | 0  | 0  | 0  | 0  | 0  | 0  | 0  | 0  | 0  | 0  | 0  |
| 2027 | 0  | 10 | 2  | 0  | 0  | 0  | 0  | 0  | 0  | 0  | 0  | 0  |
| 2028 | 0  | 10 | 2  | 0  | 0  | 0  | 0  | 0  | 0  | 0  | 0  | 0  |
| 2029 | 0  | 11 | 2  | 0  | 0  | 0  | 0  | 0  | 0  | 0  | 0  | 0  |
| 2030 | 0  | 11 | 2  | 0  | 0  | 0  | 0  | 0  | 0  | 0  | 0  | 0  |
| 2031 | 0  | 11 | 2  | 0  | 0  | 0  | 0  | 0  | 0  | 0  | 0  | 0  |
| 2032 | 0  | 11 | 2  | 0  | 0  | 0  | 0  | 0  | 0  | 0  | 0  | 0  |
| 2033 | 0  | 11 | 2  | 0  | 0  | 0  | 0  | 0  | 0  | 0  | 0  | 0  |
| 2034 | 0  | 11 | 2  | 0  | 0  | 0  | 0  | 0  | 0  | 0  | 0  | 0  |
| 2035 | 0  | 11 | 2  | 0  | 0  | 0  | 0  | 0  | 0  | 0  | 0  | 0  |
| 2036 | 0  | 11 | 2  | 0  | 0  | 0  | 0  | 0  | 0  | 0  | 0  | 0  |
| 2037 | 0  | 11 | 2  | 0  | 0  | 0  | 0  | 0  | 0  | 0  | 0  | 0  |
| 2038 | 0  | 11 | 2  | 0  | 0  | 0  | 0  | 0  | 0  | 0  | 0  | 0  |
| 2039 | 0  | 11 | 2  | 0  | 0  | 0  | 0  | 0  | 0  | 0  | 0  | 0  |
| 2040 | 0  | 11 | 2  | 0  | 0  | 0  | 0  | 0  | 0  | 0  | 0  | 0  |
| 2041 | 0  | 11 | 2  | 0  | 0  | 0  | 0  | 0  | 0  | 0  | 0  | 0  |
| 2042 | 0  | 11 | 2  | 0  | 0  | 0  | 0  | 0  | 0  | 0  | 0  | 0  |
| 2043 | 0  | 11 | 2  | 0  | 0  | 0  | 0  | 0  | 0  | 0  | 0  | 0  |
| 2044 | 0  | 11 | 2  | 0  | 0  | 0  | 0  | 0  | 0  | 0  | 0  | 0  |
| 2045 | 0  | 11 | 2  | 0  | 0  | 0  | 0  | 0  | 0  | 0  | 0  | 0  |
| 2046 | 0  | 11 | 2  | 0  | 0  | 0  | 0  | 0  | 0  | 0  | 0  | 0  |
| 2047 | 0  | 11 | 2  | 0  | 0  | 0  | 0  | 0  | 0  | 0  | 0  | 0  |
| 2048 | 0  | 11 | 2  | 0  | 0  | 0  | 0  | 0  | 0  | 0  | 0  | 0  |
| 2049 | 0  | 11 | 2  | 0  | 0  | 0  | 0  | 0  | 0  | 0  | 0  | 0  |
| 2050 | 0  | 11 | 2  | 0  | 0  | 0  | 0  | 0  | 0  | 0  | 0  | 0  |
| 2051 | 0  | 11 | 2  | 0  | 0  | 0  | 0  | 0  | 0  | 0  | 0  | 0  |
| 2052 | 0  | 11 | 2  | 0  | 0  | 0  | 0  | 0  | 0  | 0  | 0  | 0  |
| 2053 | 0  | 11 | 2  | 0  | 0  | 0  | 0  | 0  | 0  | 0  | 0  | 0  |
| 2054 | 0  | 11 | 2  | 0  | 0  | 0  | 0  | 0  | 0  | 0  | 0  | 0  |
| 2055 | 0  | 11 | 2  | 0  | 0  | 0  | 0  | 0  | 0  | 0  | 0  | 0  |
| 2056 | 0  | 11 | 2  | 0  | 0  | 0  | 0  | 0  | 0  | 0  | 0  | 0  |
| 2057 | 0  | 11 | 2  | 0  | 0  | 0  | 0  | 0  | 0  | 0  | 0  | 0  |
| 2058 | 0  | 11 | 2  | 0  | 0  | 0  | 0  | 0  | 0  | 0  | 0  | 0  |
| 2059 | 0  | 11 | 2  | 0  | 0  | 0  | 0  | 0  | 0  | 0  | 0  | 0  |

|      | 25 | 26 | 27 | 28 | 29 | 30 | 31 | 32 | 33 | 34 | 35 | 36 |
|------|----|----|----|----|----|----|----|----|----|----|----|----|
| 2060 | 0  | 11 | 2  | 0  | 0  | 0  | 0  | 0  | 0  | 0  | 0  | 0  |
| 2061 | 0  | 11 | 2  | 0  | 0  | 0  | 0  | 0  | 0  | 0  | 0  | 0  |
| 2062 | 0  | 11 | 2  | 0  | 0  | 0  | 0  | 0  | 0  | 0  | 0  | 0  |
| 2063 | 0  | 11 | 2  | 0  | 0  | 0  | 0  | 0  | 0  | 0  | 0  | 0  |
| 2064 | 0  | 11 | 2  | 0  | 0  | 0  | 0  | 0  | 0  | 0  | 0  | 0  |
| 2065 | 0  | 11 | 2  | 0  | 0  | 0  | 0  | 0  | 0  | 0  | 0  | 0  |
| 2066 | 0  | 11 | 2  | 0  | 0  | 0  | 0  | 0  | 0  | 0  | 0  | 0  |
| 2067 | 0  | 11 | 2  | 0  | 0  | 0  | 0  | 0  | 0  | 0  | 0  | 0  |
| 2068 | 0  | 11 | 2  | 0  | 0  | 0  | 0  | 0  | 0  | 0  | 0  | 0  |
| 2069 | 0  | 11 | 2  | 0  | 0  | 0  | 0  | 0  | 0  | 0  | 0  | 0  |
| 2070 | 0  | 11 | 2  | 0  | 0  | 0  | 0  | 0  | 0  | 0  | 0  | 0  |
| 2071 | 0  | 11 | 2  | 0  | 0  | 0  | 0  | 0  | 0  | 0  | 0  | 0  |
| 2072 | 0  | 11 | 2  | 0  | 0  | 0  | 0  | 0  | 0  | 0  | 0  | 0  |
| 2073 | 0  | 11 | 2  | 0  | 0  | 0  | 0  | 0  | 0  | 0  | 0  | 0  |
| 2074 | 0  | 11 | 2  | 0  | 0  | 0  | 0  | 0  | 0  | 0  | 0  | 0  |
| 2075 | 0  | 11 | 2  | 0  | 0  | 0  | 0  | 0  | 0  | 0  | 0  | 0  |
| 2076 | 0  | 11 | 2  | 0  | 0  | 0  | 0  | 0  | 0  | 0  | 0  | 0  |
| 2077 | 0  | 11 | 2  | 0  | 0  | 0  | 0  | 0  | 0  | 0  | 0  | 0  |
| 2078 | 0  | 11 | 2  | 0  | 0  | 0  | 0  | 0  | 0  | 0  | 0  | 0  |
| 2079 | 0  | 11 | 2  | 0  | 0  | 0  | 0  | 0  | 0  | 0  | 0  | 0  |
| 2080 | 0  | 11 | 2  | 0  | 0  | 0  | 0  | 0  | 0  | 0  | 0  | 0  |
| 2081 | 0  | 11 | 2  | 0  | 0  | 0  | 0  | 0  | 0  | 0  | 0  | 0  |
| 2082 | 0  | 11 | 2  | 0  | 0  | 0  | 0  | 0  | 0  | 0  | 0  | 0  |
| 2083 | 0  | 11 | 2  | 0  | 0  | 0  | 0  | 0  | 0  | 0  | 0  | 0  |
| 2084 | 0  | 11 | 2  | 0  | 0  | 0  | 0  | 0  | 0  | 0  | 0  | 0  |
| 2085 | 0  | 11 | 2  | 0  | 0  | 0  | 0  | 0  | 0  | 0  | 0  | 0  |
| 2086 | 0  | 11 | 2  | 0  | 0  | 0  | 0  | 0  | 0  | 0  | 0  | 0  |
| 2087 | 0  | 11 | 2  | 0  | 0  | 0  | 0  | 0  | 0  | 0  | 0  | 0  |
| 2088 | 0  | 11 | 2  | 0  | 0  | 0  | 0  | 0  | 0  | 0  | 0  | 0  |
| 2089 | 0  | 11 | 2  | 0  | 0  | 0  | 0  | 0  | 0  | 0  | 0  | 0  |
| 2090 | 0  | 11 | 2  | 0  | 0  | 0  | 0  | 0  | 0  | 0  | 0  | 0  |

|      | 37 | 38 | 39 | 40 | 41 | 42 | 43 | 44 | 45 | 46 | 47 | 48 |
|------|----|----|----|----|----|----|----|----|----|----|----|----|
| 2002 | 0  | 0  | 0  | 0  | 0  | 0  | 0  | 0  | 0  | 0  | 0  | 0  |
| 2003 | 0  | 0  | 0  | 0  | 0  | 0  | 0  | 0  | 0  | 0  | 0  | 0  |
| 2004 | 0  | 0  | 0  | 0  | 0  | 0  | 0  | 0  | 0  | 0  | 0  | 0  |
| 2005 | 0  | 0  | 0  | 0  | 0  | 0  | 0  | 0  | 0  | 0  | 0  | 0  |
| 2006 | 0  | 0  | 0  | 0  | 0  | 0  | 0  | 0  | 0  | 0  | 0  | 0  |
| 2007 | 0  | 0  | 0  | 0  | 0  | 0  | 0  | 0  | 0  | 0  | 0  | 0  |
| 2008 | 0  | 0  | 0  | 0  | 0  | 0  | 0  | 0  | 0  | 0  | 0  | 0  |
| 2009 | 0  | 0  | 0  | 0  | 0  | 0  | 0  | 0  | 0  | 0  | 0  | 0  |
| 2010 | 0  | 0  | 0  | 0  | 0  | 0  | 0  | 0  | 0  | 0  | 0  | 0  |
| 2011 | 0  | 0  | 0  | 0  | 0  | 0  | 0  | 0  | 0  | 0  | 0  | 0  |
| 2012 | 0  | 0  | 0  | 0  | 0  | 0  | 0  | 0  | 0  | 0  | 0  | 0  |
| 2013 | 0  | 0  | 0  | 0  | 0  | 0  | 0  | 0  | 0  | 0  | 0  | 0  |
| 2014 | 0  | 0  | 0  | 0  | 0  | 0  | 0  | 0  | 0  | 0  | 0  | 0  |
| 2015 | 0  | 0  | 0  | 0  | 0  | 0  | 0  | 0  | 0  | 0  | 0  | 0  |
| 2016 | 0  | 0  | 0  | 0  | 0  | 0  | 0  | 0  | 0  | 0  | 0  | 0  |
| 2017 | 0  | 0  | 0  | 0  | 0  | 0  | 0  | 0  | 0  | 0  | 0  | 0  |
| 2018 | 0  | 0  | 0  | 0  | 0  | 0  | 0  | 0  | 0  | 0  | 0  | 0  |
| 2019 | 0  | 0  | 0  | 0  | 0  | 0  | 0  | 0  | 0  | 0  | 0  | 0  |
| 2020 | 0  | 0  | 0  | 0  | 0  | 0  | 0  | 0  | 0  | 0  | 0  | 0  |
| 2021 | 0  | 0  | 0  | 0  | 0  | 0  | 0  | 0  | 0  | 0  | 0  | 0  |
| 2022 | 0  | 0  | 0  | 0  | 0  | 0  | 0  | 0  | 0  | 0  | 0  | 0  |
| 2023 | 0  | 0  | 0  | 0  | 0  | 0  | 0  | 0  | 0  | 0  | 0  | 0  |
| 2024 | 0  | 0  | 0  | 0  | 0  | 0  | 0  | 0  | 0  | 0  | 0  | 0  |
| 2025 | 0  | 0  | 0  | 0  | 0  | 0  | 0  | 0  | 0  | 0  | 0  | 0  |
| 2026 | 0  | 0  | 0  | 0  | 0  | 0  | 0  | 6  | 0  | 0  | 0  | 0  |
| 2027 | 0  | 0  | 0  | 0  | 0  | 0  | 0  | 10 | 0  | 2  | 0  | 0  |
| 2028 | 0  | 0  | 0  | 0  | 0  | 0  | 0  | 10 | 0  | 2  | 0  | 0  |
| 2029 | 0  | 0  | 0  | 0  | 0  | 0  | 0  | 10 | 0  | 7  | 0  | 0  |
| 2030 | 0  | 0  | 0  | 0  | 0  | 0  | 0  | 10 | 0  | 7  | 0  | 0  |
| 2031 | 0  | 0  | 0  | 0  | 0  | 0  | 0  | 10 | 0  | 7  | 0  | 0  |
| 2032 | 0  | 0  | 0  | 0  | 0  | 0  | 0  | 10 | 0  | 7  | 0  | 0  |
| 2033 | 0  | 0  | 0  | 0  | 0  | 0  | 0  | 10 | 0  | 7  | 0  | 0  |
| 2034 | 0  | 0  | 0  | 0  | 0  | 0  | 0  | 10 | 0  | 7  | 0  | 0  |
| 2035 | 0  | 0  | 0  | 0  | 0  | 0  | 0  | 10 | 0  | 7  | 0  | 0  |
| 2036 | 0  | 0  | 0  | 0  | 0  | 0  | 0  | 10 | 0  | 7  | 0  | 0  |
| 2037 | 0  | 0  | 0  | 0  | 0  | 0  | 0  | 10 | 0  | 7  | 0  | 0  |
| 2038 | 0  | 0  | 0  | 0  | 0  | 0  | 0  | 10 | 0  | 7  | 0  | 0  |
| 2039 | 0  | 0  | 0  | 0  | 0  | 0  | 0  | 10 | 0  | 7  | 0  | 0  |
| 2040 | 0  | 0  | 0  | 0  | 0  | 0  | 0  | 10 | 0  | 7  | 0  | 0  |
| 2041 | 0  | 0  | 0  | 0  | 0  | 0  | 0  | 10 | 0  | 7  | 0  | 0  |
| 2042 | 0  | 0  | 0  | 0  | 0  | 0  | 0  | 10 | 0  | 7  | 0  | 0  |
| 2043 | 0  | 0  | 0  | 0  | 0  | 0  | 0  | 10 | 0  | 7  | 0  | 0  |
| 2044 | 0  | 0  | 0  | 0  | 0  | 0  | 0  | 10 | 0  | 7  | 0  | 0  |
| 2045 | 0  | 0  | 0  | 0  | 0  | 0  | 0  | 10 | 0  | 7  | 0  | 0  |
| 2046 | 0  | 0  | 0  | 0  | 0  | 0  | 0  | 10 | 0  | 7  | 0  | 0  |
| 2047 | 0  | 0  | 0  | 0  | 0  | 0  | 0  | 10 | 0  | 7  | 0  | 0  |
| 2048 | 0  | 0  | 0  | 0  | 0  | 0  | 0  | 10 | 0  | 7  | 0  | 0  |
| 2049 | 0  | 0  | 0  | 0  | 0  | 0  | 0  | 10 | 0  | 7  | 0  | 0  |
| 2050 | 0  | 0  | 0  | 0  | 0  | 0  | 0  | 10 | 0  | 7  | 0  | 0  |
| 2051 | 0  | 0  | 0  | 0  | 0  | 0  | 0  | 10 | 0  | 7  | 0  | 0  |
| 2052 | 0  | 0  | 0  | 0  | 0  | 0  | 0  | 10 | 0  | 7  | 0  | 0  |
| 2053 | 0  | 0  | 0  | 0  | 0  | 0  | 0  | 10 | 0  | 7  | 0  | 0  |
| 2054 | 0  | 0  | 0  | 0  | 0  | 0  | 0  | 10 | 0  | 7  | 0  | 0  |
| 2055 | 0  | 0  | 0  | 0  | 0  | 0  | 0  | 10 | 0  | 7  | 0  | 0  |
| 2056 | 0  | 0  | 0  | 0  | 0  | 0  | 0  | 10 | 0  | 7  | 0  | 0  |
| 2057 | 0  | 0  | 0  | 0  | 0  | 0  | 0  | 10 | 0  | 7  | 0  | 0  |
| 2058 | 0  | 0  | 0  | 0  | 0  | 0  | 0  | 10 | 0  | 7  | 0  | 0  |
| 2059 | 0  | 0  | 0  | 0  | 0  | 0  | 0  | 10 | 0  | 7  | 0  | 0  |

|      | 37 | 38 | 39 | 40 | 41 | 42 | 43 | 44 | 45 | 46 | 47 | 48 |
|------|----|----|----|----|----|----|----|----|----|----|----|----|
| 2060 | 0  | 0  | 0  | 0  | 0  | 0  | 0  | 10 | 0  | 7  | 0  | 0  |
| 2061 | 0  | 0  | 0  | 0  | 0  | 0  | 0  | 10 | 0  | 7  | 0  | 0  |
| 2062 | 0  | 0  | 0  | 0  | 0  | 0  | 0  | 10 | 0  | 7  | 0  | 0  |
| 2063 | 0  | 0  | 0  | 0  | 0  | 0  | 0  | 10 | 0  | 7  | 0  | 0  |
| 2064 | 0  | 0  | 0  | 0  | 0  | 0  | 0  | 10 | 0  | 7  | 0  | 0  |
| 2065 | 0  | 0  | 0  | 0  | 0  | 0  | 0  | 10 | 0  | 7  | 0  | 0  |
| 2066 | 0  | 0  | 0  | 0  | 0  | 0  | 0  | 10 | 0  | 7  | 0  | 0  |
| 2067 | 0  | 0  | 0  | 0  | 0  | 0  | 0  | 10 | 0  | 7  | 0  | 0  |
| 2068 | 0  | 0  | 0  | 0  | 0  | 0  | 0  | 10 | 0  | 7  | 0  | 0  |
| 2069 | 0  | 0  | 0  | 0  | 0  | 0  | 0  | 10 | 0  | 7  | 0  | 0  |
| 2070 | 0  | 0  | 0  | 0  | 0  | 0  | 0  | 10 | 0  | 7  | 0  | 0  |
| 2071 | 0  | 0  | 0  | 0  | 0  | 0  | 0  | 10 | 0  | 7  | 0  | 0  |
| 2072 | 0  | 0  | 0  | 0  | 0  | 0  | 0  | 10 | 0  | 7  | 0  | 0  |
| 2073 | 0  | 0  | 0  | 0  | 0  | 0  | 0  | 10 | 0  | 7  | 0  | 0  |
| 2074 | 0  | 0  | 0  | 0  | 0  | 0  | 0  | 10 | 0  | 7  | 0  | 0  |
| 2075 | 0  | 0  | 0  | 0  | 0  | 0  | 0  | 10 | 0  | 7  | 0  | 0  |
| 2076 | 0  | 0  | 0  | 0  | 0  | 0  | 0  | 10 | 0  | 7  | 0  | 0  |
| 2077 | 0  | 0  | 0  | 0  | 0  | 0  | 0  | 10 | 0  | 7  | 0  | 0  |
| 2078 | 0  | 0  | 0  | 0  | 0  | 0  | 0  | 10 | 0  | 7  | 0  | 0  |
| 2079 | 0  | 0  | 0  | 0  | 0  | 0  | 0  | 10 | 0  | 7  | 0  | 0  |
| 2080 | 0  | 0  | 0  | 0  | 0  | 0  | 0  | 10 | 0  | 7  | 0  | 0  |
| 2081 | 0  | 0  | 0  | 0  | 0  | 0  | 0  | 10 | 0  | 7  | 0  | 0  |
| 2082 | 0  | 0  | 0  | 0  | 0  | 0  | 0  | 10 | 0  | 7  | 0  | 0  |
| 2083 | 0  | 0  | 0  | 0  | 0  | 0  | 0  | 10 | 0  | 7  | 0  | 0  |
| 2084 | 0  | 0  | 0  | 0  | 0  | 0  | 0  | 10 | 0  | 7  | 0  | 0  |
| 2085 | 0  | 0  | 0  | 0  | 0  | 0  | 0  | 10 | 0  | 7  | 0  | 0  |
| 2086 | 0  | 0  | 0  | 0  | 0  | 0  | 0  | 10 | 0  | 7  | 0  | 0  |
| 2087 | 0  | 0  | 0  | 0  | 0  | 0  | 0  | 10 | 0  | 7  | 0  | 0  |
| 2088 | 0  | 0  | 0  | 0  | 0  | 0  | 0  | 10 | 0  | 7  | 0  | 0  |
| 2089 | 0  | 0  | 0  | 0  | 0  | 0  | 0  | 10 | 0  | 7  | 0  | 0  |
| 2090 | 0  | 0  | 0  | 0  | 0  | 0  | 0  | 10 | 0  | 7  | 0  | 0  |

|      | 49 | 50 | 51 | 52 | 53 | 54 | 55 | 56 | 57 | 58 | 59 | 60 |
|------|----|----|----|----|----|----|----|----|----|----|----|----|
| 2002 | 0  | 0  | 0  | 0  | 0  | 0  | 0  | 0  | 0  | 0  | 0  | 0  |
| 2003 | 0  | 0  | 0  | 0  | 0  | 0  | 0  | 0  | 0  | 0  | 0  | 0  |
| 2004 | 0  | 0  | 0  | 0  | 0  | 0  | 0  | 0  | 0  | 0  | 0  | 0  |
| 2005 | 0  | 0  | 0  | 0  | 0  | 0  | 0  | 0  | 0  | 0  | 0  | 0  |
| 2006 | 0  | 0  | 0  | 0  | 0  | 0  | 0  | 0  | 0  | 0  | 0  | 0  |
| 2007 | 0  | 0  | 0  | 0  | 0  | 0  | 0  | 0  | 0  | 0  | 0  | 0  |
| 2008 | 0  | 0  | 0  | 0  | 0  | 0  | 0  | 0  | 0  | 0  | 0  | 0  |
| 2009 | 0  | 0  | 0  | 0  | 0  | 0  | 0  | 0  | 0  | 0  | 0  | 0  |
| 2010 | 0  | 0  | 0  | 0  | 0  | 0  | 0  | 0  | 0  | 0  | 0  | 0  |
| 2011 | 0  | 0  | 0  | 0  | 0  | 0  | 0  | 0  | 0  | 0  | 0  | 0  |
| 2012 | 0  | 0  | 0  | 0  | 0  | 0  | 0  | 0  | 0  | 0  | 0  | 0  |
| 2013 | 0  | 0  | 0  | 0  | 0  | 0  | 0  | 0  | 0  | 0  | 0  | 0  |
| 2014 | 0  | 0  | 0  | 0  | 0  | 0  | 0  | 0  | 0  | 0  | 0  | 0  |
| 2015 | 0  | 0  | 0  | 0  | 0  | 0  | 0  | 0  | 0  | 0  | 0  | 0  |
| 2016 | 0  | 0  | 0  | 0  | 0  | 0  | 0  | 0  | 0  | 0  | 0  | 0  |
| 2017 | 0  | 0  | 0  | 0  | 0  | 0  | 0  | 0  | 0  | 0  | 0  | 0  |
| 2018 | 0  | 0  | 0  | 0  | 0  | 0  | 0  | 0  | 0  | 0  | 0  | 0  |
| 2019 | 0  | 0  | 0  | 0  | 0  | 0  | 0  | 0  | 0  | 0  | 0  | 0  |
| 2020 | 0  | 0  | 0  | 0  | 0  | 0  | 0  | 0  | 0  | 0  | 0  | 0  |
| 2021 | 4  | 0  | 0  | 0  | 0  | 0  | 0  | 0  | 0  | 0  | 0  | 0  |
| 2022 | 4  | 0  | 0  | 0  | 0  | 0  | 0  | 0  | 0  | 0  | 0  | 0  |
| 2023 | 9  | 0  | 0  | 0  | 0  | 0  | 0  | 0  | 0  | 0  | 0  | 0  |
| 2024 | 9  | 0  | 0  | 0  | 0  | 0  | 0  | 0  | 0  | 0  | 0  | 0  |
| 2025 | 9  | 0  | 0  | 0  | 0  | 0  | 0  | 0  | 0  | 0  | 0  | 0  |
| 2026 | 9  | 0  | 0  | 0  | 5  | 0  | 0  | 0  | 0  | 0  | 0  | 0  |
| 2027 | 9  | 2  | 2  | 0  | 10 | 2  | 0  | 0  | 0  | 0  | 0  | 0  |
| 2028 | 9  | 2  | 2  | 0  | 10 | 2  | 0  | 0  | 0  | 0  | 0  | 0  |
| 2029 | 9  | 2  | 2  | 0  | 11 | 2  | 0  | 0  | 0  | 0  | 0  | 0  |
| 2030 | 9  | 2  | 2  | 0  | 11 | 2  | 0  | 0  | 0  | 0  | 0  | 0  |
| 2031 | 9  | 2  | 2  | 0  | 11 | 2  | 0  | 0  | 0  | 0  | 0  | 0  |
| 2032 | 9  | 2  | 2  | 0  | 13 | 2  | 0  | 0  | 0  | 0  | 0  | 0  |
| 2033 | 9  | 2  | 2  | 0  | 15 | 2  | 0  | 0  | 0  | 0  | 0  | 0  |
| 2034 | 9  | 2  | 2  | 0  | 15 | 2  | 0  | 0  | 0  | 0  | 0  | 0  |
| 2035 | 9  | 2  | 2  | 0  | 15 | 2  | 0  | 0  | 0  | 0  | 0  | 0  |
| 2036 | 9  | 2  | 2  | 0  | 15 | 2  | 0  | 0  | 0  | 0  | 0  | 0  |
| 2037 | 9  | 2  | 2  | 0  | 15 | 2  | 0  | 0  | 0  | 0  | 0  | 0  |
| 2038 | 9  | 2  | 2  | 0  | 15 | 2  | 0  | 0  | 0  | 0  | 0  | 0  |
| 2039 | 9  | 2  | 2  | 0  | 15 | 2  | 0  | 0  | 0  | 0  | 0  | 0  |
| 2040 | 9  | 2  | 2  | 0  | 15 | 2  | 0  | 0  | 0  | 0  | 0  | 0  |
| 2041 | 9  | 2  | 2  | 0  | 15 | 2  | 0  | 0  | 0  | 0  | 0  | 0  |
| 2042 | 9  | 2  | 2  | 0  | 15 | 2  | 0  | 0  | 0  | 0  | 0  | 0  |
| 2043 | 9  | 2  | 2  | 0  | 15 | 2  | 0  | 0  | 0  | 0  | 0  | 0  |
| 2044 | 9  | 2  | 2  | 0  | 15 | 2  | 0  | 0  | 0  | 0  | 0  | 0  |
| 2045 | 9  | 2  | 2  | 0  | 15 | 2  | 0  | 0  | 0  | 0  | 0  | 0  |
| 2046 | 9  | 2  | 2  | 0  | 15 | 2  | 0  | 0  | 0  | 0  | 0  | 0  |
| 2047 | 9  | 2  | 2  | 0  | 15 | 2  | 0  | 0  | 0  | 0  | 0  | 0  |
| 2048 | 9  | 2  | 2  | 0  | 15 | 2  | 0  | 0  | 0  | 0  | 0  | 0  |
| 2049 | 9  | 2  | 2  | 0  | 15 | 2  | 0  | 0  | 0  | 0  | 0  | 0  |
| 2050 | 9  | 2  | 2  | 0  | 15 | 2  | 0  | 0  | 0  | 0  | 0  | 0  |
| 2051 | 9  | 2  | 2  | 0  | 15 | 2  | 0  | 0  | 0  | 0  | 0  | 0  |
| 2052 | 9  | 2  | 2  | 0  | 15 | 2  | 0  | 0  | 0  | 0  | 0  | 0  |
| 2053 | 9  | 2  | 2  | 0  | 15 | 2  | 0  | 0  | 0  | 0  | 0  | 0  |
| 2054 | 9  | 2  | 2  | 0  | 15 | 2  | 0  | 0  | 0  | 0  | 0  | 0  |
| 2055 | 9  | 2  | 2  | 0  | 15 | 2  | 0  | 0  | 0  | 0  | 0  | 0  |
| 2056 | 9  | 2  | 2  | 0  | 15 | 2  | 0  | 0  | 0  | 0  | 0  | 0  |
| 2057 | 9  | 2  | 2  | 0  | 15 | 2  | 0  | 0  | 0  | 0  | 0  | 0  |
| 2058 | 9  | 2  | 2  | 0  | 15 | 2  | 0  | 0  | 0  | 0  | 0  | 0  |
| 2059 | 9  | 2  | 2  | 0  | 15 | 2  | 0  | 0  | 0  | 0  | 0  | 0  |

|      | 49 | 50 | 51 | 52 | 53 | 54 | 55 | 56 | 57 | 58 | 59 | 60 |
|------|----|----|----|----|----|----|----|----|----|----|----|----|
| 2060 | 9  | 2  | 2  | 0  | 15 | 2  | 0  | 0  | 0  | 0  | 0  | 0  |
| 2061 | 9  | 2  | 2  | 0  | 15 | 2  | 0  | 0  | 0  | 0  | 0  | 0  |
| 2062 | 9  | 2  | 2  | 0  | 15 | 2  | 0  | 0  | 0  | 0  | 0  | 0  |
| 2063 | 9  | 2  | 2  | 0  | 15 | 2  | 0  | 0  | 0  | 0  | 0  | 0  |
| 2064 | 9  | 2  | 2  | 0  | 15 | 2  | 0  | 0  | 0  | 0  | 0  | 0  |
| 2065 | 9  | 2  | 2  | 0  | 15 | 2  | 0  | 0  | 0  | 0  | 0  | 0  |
| 2066 | 9  | 2  | 2  | 0  | 15 | 2  | 0  | 0  | 0  | 0  | 0  | 0  |
| 2067 | 9  | 2  | 2  | 0  | 15 | 2  | 0  | 0  | 0  | 0  | 0  | 0  |
| 2068 | 9  | 2  | 2  | 0  | 15 | 2  | 0  | 0  | 0  | 0  | 0  | 0  |
| 2069 | 9  | 2  | 2  | 0  | 15 | 2  | 0  | 0  | 0  | 0  | 0  | 0  |
| 2070 | 9  | 2  | 2  | 0  | 15 | 2  | 0  | 0  | 0  | 0  | 0  | 0  |
| 2071 | 9  | 2  | 2  | 0  | 15 | 2  | 0  | 0  | 0  | 0  | 0  | 0  |
| 2072 | 9  | 2  | 2  | 0  | 15 | 2  | 0  | 0  | 0  | 0  | 0  | 0  |
| 2073 | 9  | 2  | 2  | 0  | 15 | 2  | 0  | 0  | 0  | 0  | 0  | 0  |
| 2074 | 9  | 2  | 2  | 0  | 15 | 2  | 0  | 0  | 0  | 0  | 0  | 0  |
| 2075 | 9  | 2  | 2  | 0  | 15 | 2  | 0  | 0  | 0  | 0  | 0  | 0  |
| 2076 | 9  | 2  | 2  | 0  | 15 | 2  | 0  | 0  | 0  | 0  | 0  | 0  |
| 2077 | 9  | 2  | 2  | 0  | 15 | 2  | 0  | 0  | 0  | 0  | 0  | 0  |
| 2078 | 9  | 2  | 2  | 0  | 15 | 2  | 0  | 0  | 0  | 0  | 0  | 0  |
| 2079 | 9  | 2  | 2  | 0  | 15 | 2  | 0  | 0  | 0  | 0  | 0  | 0  |
| 2080 | 9  | 2  | 2  | 0  | 15 | 2  | 0  | 0  | 0  | 0  | 0  | 0  |
| 2081 | 9  | 2  | 2  | 0  | 15 | 2  | 0  | 0  | 0  | 0  | 0  | 0  |
| 2082 | 9  | 2  | 2  | 0  | 15 | 2  | 0  | 0  | 0  | 0  | 0  | 0  |
| 2083 | 9  | 2  | 2  | 0  | 15 | 2  | 0  | 0  | 0  | 0  | 0  | 0  |
| 2084 | 9  | 2  | 2  | 0  | 15 | 2  | 0  | 0  | 0  | 0  | 0  | 0  |
| 2085 | 9  | 2  | 2  | 0  | 15 | 2  | 0  | 0  | 0  | 0  | 0  | 0  |
| 2086 | 9  | 2  | 2  | 0  | 15 | 2  | 0  | 0  | 0  | 0  | 0  | 0  |
| 2087 | 9  | 2  | 2  | 0  | 15 | 2  | 0  | 0  | 0  | 0  | 0  | 0  |
| 2088 | 9  | 2  | 2  | 0  | 15 | 2  | 0  | 0  | 0  | 0  | 0  | 0  |
| 2089 | 9  | 2  | 2  | 0  | 15 | 2  | 0  | 0  | 0  | 0  | 0  | 0  |
| 2090 | 9  | 2  | 2  | 0  | 15 | 2  | 0  | 0  | 0  | 0  | 0  | 0  |

|      | 61 | 62 | 63 | 64 | 65 | 66 | 67 | 68 | 69 | 70 | 71 | 72 |
|------|----|----|----|----|----|----|----|----|----|----|----|----|
| 2002 | 0  | 0  | 0  | 0  | 0  | 0  | 0  | 0  | 0  | 0  | 0  | 0  |
| 2003 | 0  | 0  | 0  | 0  | 0  | 0  | 0  | 0  | 0  | 0  | 0  | 0  |
| 2004 | 0  | 0  | 0  | 0  | 0  | 0  | 0  | 0  | 0  | 0  | 0  | 0  |
| 2005 | 0  | 0  | 0  | 0  | 0  | 0  | 0  | 0  | 0  | 0  | 0  | 0  |
| 2006 | 0  | 0  | 0  | 0  | 0  | 0  | 0  | 0  | 0  | 0  | 0  | 0  |
| 2007 | 0  | 0  | 0  | 0  | 0  | 0  | 0  | 0  | 0  | 0  | 0  | 0  |
| 2008 | 0  | 0  | 0  | 0  | 0  | 0  | 0  | 0  | 0  | 0  | 0  | 0  |
| 2009 | 0  | 0  | 0  | 0  | 0  | 0  | 0  | 0  | 0  | 0  | 0  | 0  |
| 2010 | 0  | 0  | 0  | 0  | 0  | 0  | 0  | 0  | 0  | 0  | 0  | 0  |
| 2011 | 0  | 0  | 0  | 0  | 0  | 0  | 0  | 0  | 0  | 0  | 0  | 0  |
| 2012 | 0  | 0  | 0  | 0  | 0  | 0  | 0  | 0  | 0  | 0  | 0  | 0  |
| 2013 | 0  | 0  | 0  | 0  | 0  | 0  | 0  | 0  | 0  | 0  | 0  | 0  |
| 2014 | 0  | 0  | 0  | 0  | 0  | 0  | 0  | 0  | 0  | 0  | 0  | 0  |
| 2015 | 0  | 0  | 0  | 0  | 0  | 0  | 0  | 0  | 0  | 0  | 0  | 0  |
| 2016 | 0  | 0  | 0  | 0  | 0  | 0  | 0  | 0  | 0  | 0  | 0  | 0  |
| 2017 | 0  | 0  | 0  | 0  | 0  | 0  | 0  | 0  | 0  | 0  | 0  | 0  |
| 2018 | 0  | 0  | 0  | 0  | 0  | 0  | 0  | 0  | 0  | 0  | 0  | 0  |
| 2019 | 0  | 0  | 0  | 0  | 0  | 0  | 0  | 0  | 0  | 0  | 0  | 0  |
| 2020 | 0  | 0  | 0  | 0  | 0  | 0  | 0  | 0  | 0  | 0  | 0  | 0  |
| 2021 | 0  | 0  | 0  | 0  | 0  | 0  | 4  | 0  | 0  | 0  | 0  | 0  |
| 2022 | 0  | 0  | 0  | 0  | 0  | 0  | 4  | 0  | 0  | 0  | 0  | 0  |
| 2023 | 0  | 0  | 0  | 0  | 0  | 0  | 4  | 0  | 0  | 0  | 0  | 0  |
| 2024 | 0  | 0  | 0  | 0  | 0  | 0  | 4  | 0  | 0  | 0  | 0  | 0  |
| 2025 | 0  | 0  | 0  | 0  | 0  | 0  | 4  | 0  | 0  | 0  | 0  | 0  |
| 2026 | 0  | 0  | 0  | 0  | 0  | 0  | 4  | 0  | 0  | 0  | 1  | 0  |
| 2027 | 0  | 0  | 0  | 0  | 0  | 0  | 4  | 0  | 0  | 0  | 9  | 0  |
| 2028 | 0  | 0  | 0  | 0  | 0  | 0  | 4  | 0  | 0  | 0  | 12 | 0  |
| 2029 | 0  | 0  | 0  | 0  | 0  | 0  | 4  | 0  | 0  | 0  | 21 | 0  |
| 2030 | 0  | 0  | 0  | 0  | 0  | 0  | 4  | 0  | 0  | 0  | 21 | 0  |
| 2031 | 0  | 0  | 0  | 0  | 0  | 0  | 4  | 0  | 0  | 0  | 21 | 0  |
| 2032 | 0  | 0  | 0  | 0  | 0  | 0  | 4  | 0  | 0  | 0  | 21 | 0  |
| 2033 | 0  | 0  | 0  | 0  | 0  | 0  | 4  | 0  | 0  | 0  | 21 | 0  |
| 2034 | 0  | 0  | 0  | 0  | 0  | 0  | 4  | 0  | 0  | 0  | 21 | 0  |
| 2035 | 0  | 0  | 0  | 0  | 0  | 0  | 4  | 0  | 0  | 0  | 21 | 0  |
| 2036 | 0  | 0  | 0  | 0  | 0  | 0  | 4  | 0  | 0  | 0  | 21 | 0  |
| 2037 | 0  | 0  | 0  | 0  | 0  | 0  | 4  | 0  | 0  | 0  | 21 | 0  |
| 2038 | 0  | 0  | 0  | 0  | 0  | 0  | 4  | 0  | 0  | 0  | 21 | 0  |
| 2039 | 0  | 0  | 0  | 0  | 0  | 0  | 4  | 0  | 0  | 0  | 21 | 0  |
| 2040 | 0  | 0  | 0  | 0  | 0  | 0  | 4  | 0  | 0  | 0  | 21 | 0  |
| 2041 | 0  | 0  | 0  | 0  | 0  | 0  | 4  | 0  | 0  | 0  | 21 | 0  |
| 2042 | 0  | 0  | 0  | 0  | 0  | 0  | 4  | 0  | 0  | 0  | 21 | 0  |
| 2043 | 0  | 0  | 0  | 0  | 0  | 0  | 4  | 0  | 0  | 0  | 21 | 0  |
| 2044 | 0  | 0  | 0  | 0  | 0  | 0  | 4  | 0  | 0  | 0  | 21 | 0  |
| 2045 | 0  | 0  | 0  | 0  | 0  | 0  | 4  | 0  | 0  | 0  | 21 | 0  |
| 2046 | 0  | 0  | 0  | 0  | 0  | 0  | 4  | 0  | 0  | 0  | 21 | 0  |
| 2047 | 0  | 0  | 0  | 0  | 0  | 0  | 4  | 0  | 0  | 0  | 21 | 0  |
| 2048 | 0  | 0  | 0  | 0  | 0  | 0  | 4  | 0  | 0  | 0  | 21 | 0  |
| 2049 | 0  | 0  | 0  | 0  | 0  | 0  | 4  | 0  | 0  | 0  | 21 | 0  |
| 2050 | 0  | 0  | 0  | 0  | 0  | 0  | 4  | 0  | 0  | 0  | 21 | 0  |
| 2051 | 0  | 0  | 0  | 0  | 0  | 0  | 4  | 0  | 0  | 0  | 21 | 0  |
| 2052 | 0  | 0  | 0  | 0  | 0  | 0  | 4  | 0  | 0  | 0  | 21 | 0  |
| 2053 | 0  | 0  | 0  | 0  | 0  | 0  | 4  | 0  | 0  | 0  | 21 | 0  |
| 2054 | 0  | 0  | 0  | 0  | 0  | 0  | 4  | 0  | 0  | 0  | 21 | 0  |
| 2055 | 0  | 0  | 0  | 0  | 0  | 0  | 4  | 0  | 0  | 0  | 21 | 0  |
| 2056 | 0  | 0  | 0  | 0  | 0  | 0  | 4  | 0  | 0  | 0  | 21 | 0  |
| 2057 | 0  | 0  | 0  | 0  | 0  | 0  | 4  | 0  | 0  | 0  | 21 | 0  |
| 2058 | 0  | 0  | 0  | 0  | 0  | 0  | 4  | 0  | 0  | 0  | 21 | 0  |
| 2059 | 0  | 0  | 0  | 0  | 0  | 0  | 4  | 0  | 0  | 0  | 21 | 0  |

|      | 61 | 62 | 63 | 64 | 65 | 66 | 67 | 68 | 69 | 70 | 71 | 72 |
|------|----|----|----|----|----|----|----|----|----|----|----|----|
| 2060 | 0  | 0  | 0  | 0  | 0  | 0  | 4  | 0  | 0  | 0  | 21 | 0  |
| 2061 | 0  | 0  | 0  | 0  | 0  | 0  | 4  | 0  | 0  | 0  | 21 | 0  |
| 2062 | 0  | 0  | 0  | 0  | 0  | 0  | 4  | 0  | 0  | 0  | 21 | 0  |
| 2063 | 0  | 0  | 0  | 0  | 0  | 0  | 4  | 0  | 0  | 0  | 21 | 0  |
| 2064 | 0  | 0  | 0  | 0  | 0  | 0  | 4  | 0  | 0  | 0  | 21 | 0  |
| 2065 | 0  | 0  | 0  | 0  | 0  | 0  | 4  | 0  | 0  | 0  | 21 | 0  |
| 2066 | 0  | 0  | 0  | 0  | 0  | 0  | 4  | 0  | 0  | 0  | 21 | 0  |
| 2067 | 0  | 0  | 0  | 0  | 0  | 0  | 4  | 0  | 0  | 0  | 21 | 0  |
| 2068 | 0  | 0  | 0  | 0  | 0  | 0  | 4  | 0  | 0  | 0  | 21 | 0  |
| 2069 | 0  | 0  | 0  | 0  | 0  | 0  | 4  | 0  | 0  | 0  | 21 | 0  |
| 2070 | 0  | 0  | 0  | 0  | 0  | 0  | 4  | 0  | 0  | 0  | 21 | 0  |
| 2071 | 0  | 0  | 0  | 0  | 0  | 0  | 4  | 0  | 0  | 0  | 21 | 0  |
| 2072 | 0  | 0  | 0  | 0  | 0  | 0  | 4  | 0  | 0  | 0  | 21 | 0  |
| 2073 | 0  | 0  | 0  | 0  | 0  | 0  | 4  | 0  | 0  | 0  | 21 | 0  |
| 2074 | 0  | 0  | 0  | 0  | 0  | 0  | 4  | 0  | 0  | 0  | 21 | 0  |
| 2075 | 0  | 0  | 0  | 0  | 0  | 0  | 4  | 0  | 0  | 0  | 21 | 0  |
| 2076 | 0  | 0  | 0  | 0  | 0  | 0  | 4  | 0  | 0  | 0  | 21 | 0  |
| 2077 | 0  | 0  | 0  | 0  | 0  | 0  | 4  | 0  | 0  | 0  | 21 | 0  |
| 2078 | 0  | 0  | 0  | 0  | 0  | 0  | 4  | 0  | 0  | 0  | 21 | 0  |
| 2079 | 0  | 0  | 0  | 0  | 0  | 0  | 4  | 0  | 0  | 0  | 21 | 0  |
| 2080 | 0  | 0  | 0  | 0  | 0  | 0  | 4  | 0  | 0  | 0  | 21 | 0  |
| 2081 | 0  | 0  | 0  | 0  | 0  | 0  | 4  | 0  | 0  | 0  | 21 | 0  |
| 2082 | 0  | 0  | 0  | 0  | 0  | 0  | 4  | 0  | 0  | 0  | 21 | 0  |
| 2083 | 0  | 0  | 0  | 0  | 0  | 0  | 4  | 0  | 0  | 0  | 21 | 0  |
| 2084 | 0  | 0  | 0  | 0  | 0  | 0  | 4  | 0  | 0  | 0  | 21 | 0  |
| 2085 | 0  | 0  | 0  | 0  | 0  | 0  | 4  | 0  | 0  | 0  | 21 | 0  |
| 2086 | 0  | 0  | 0  | 0  | 0  | 0  | 4  | 0  | 0  | 0  | 21 | 0  |
| 2087 | 0  | 0  | 0  | 0  | 0  | 0  | 4  | 0  | 0  | 0  | 21 | 0  |
| 2088 | 0  | 0  | 0  | 0  | 0  | 0  | 4  | 0  | 0  | 0  | 21 | 0  |
| 2089 | 0  | 0  | 0  | 0  | 0  | 0  | 4  | 0  | 0  | 0  | 21 | 0  |
| 2090 | 0  | 0  | 0  | 0  | 0  | 0  | 4  | 0  | 0  | 0  | 21 | 0  |



|      | 73 | 74 | 75 | 76 | 77 | 78 | 79 | 80 | 81 | 82 | 83 | 84 |
|------|----|----|----|----|----|----|----|----|----|----|----|----|
| 2002 | 0  | 0  | 0  | 0  | 0  | 0  | 0  | 0  | 0  | 0  | 0  | 0  |
| 2003 | 0  | 0  | 0  | 0  | 0  | 0  | 0  | 0  | 0  | 0  | 0  | 0  |
| 2004 | 0  | 0  | 0  | 0  | 0  | 0  | 0  | 0  | 0  | 0  | 0  | 0  |
| 2005 | 0  | 0  | 0  | 0  | 0  | 0  | 0  | 0  | 0  | 0  | 0  | 0  |
| 2006 | 0  | 0  | 0  | 0  | 0  | 0  | 0  | 0  | 0  | 0  | 0  | 0  |
| 2007 | 0  | 0  | 0  | 0  | 0  | 0  | 0  | 0  | 0  | 0  | 0  | 0  |
| 2008 | 0  | 0  | 0  | 0  | 0  | 0  | 0  | 0  | 0  | 0  | 0  | 0  |
| 2009 | 0  | 0  | 0  | 0  | 0  | 0  | 0  | 0  | 0  | 0  | 0  | 0  |
| 2010 | 0  | 0  | 0  | 0  | 0  | 0  | 0  | 0  | 0  | 0  | 0  | 0  |
| 2011 | 0  | 0  | 0  | 0  | 0  | 0  | 0  | 0  | 0  | 0  | 0  | 0  |
| 2012 | 0  | 0  | 0  | 0  | 0  | 0  | 0  | 0  | 0  | 0  | 0  | 0  |
| 2013 | 0  | 0  | 0  | 0  | 0  | 0  | 0  | 0  | 0  | 0  | 0  | 0  |
| 2014 | 0  | 0  | 0  | 0  | 0  | 0  | 0  | 0  | 0  | 0  | 0  | 0  |
| 2015 | 0  | 0  | 0  | 0  | 0  | 0  | 0  | 0  | 0  | 0  | 0  | 0  |
| 2016 | 0  | 0  | 0  | 0  | 0  | 0  | 0  | 0  | 0  | 0  | 0  | 0  |
| 2017 | 0  | 0  | 0  | 0  | 0  | 0  | 0  | 0  | 0  | 0  | 0  | 0  |
| 2018 | 0  | 0  | 0  | 0  | 0  | 0  | 0  | 0  | 0  | 0  | 0  | 0  |
| 2019 | 0  | 0  | 0  | 0  | 0  | 0  | 0  | 0  | 0  | 0  | 0  | 0  |
| 2020 | 0  | 0  | 0  | 0  | 0  | 0  | 0  | 0  | 0  | 0  | 0  | 0  |
| 2021 | 0  | 0  | 0  | 16 | 0  | 0  | 0  | 0  | 0  | 0  | 0  | 0  |
| 2022 | 0  | 0  | 0  | 16 | 0  | 0  | 0  | 0  | 0  | 0  | 0  | 0  |
| 2023 | 0  | 0  | 0  | 17 | 0  | 0  | 0  | 0  | 0  | 0  | 0  | 0  |
| 2024 | 0  | 0  | 0  | 17 | 0  | 0  | 0  | 0  | 0  | 0  | 0  | 0  |
| 2025 | 0  | 0  | 0  | 17 | 0  | 0  | 0  | 0  | 0  | 0  | 0  | 0  |
| 2026 | 6  | 0  | 0  | 17 | 0  | 0  | 0  | 1  | 0  | 0  | 0  | 0  |
| 2027 | 11 | 0  | 0  | 17 | 2  | 1  | 0  | 19 | 2  | 0  | 0  | 0  |
| 2028 | 11 | 0  | 0  | 17 | 2  | 1  | 0  | 34 | 2  | 0  | 0  | 0  |
| 2029 | 11 | 0  | 0  | 17 | 2  | 1  | 0  | 56 | 2  | 0  | 0  | 0  |
| 2030 | 11 | 0  | 0  | 17 | 2  | 1  | 0  | 73 | 2  | 0  | 0  | 0  |
| 2031 | 11 | 0  | 0  | 17 | 2  | 1  | 0  | 76 | 2  | 0  | 0  | 0  |
| 2032 | 11 | 0  | 0  | 17 | 2  | 1  | 0  | 76 | 2  | 0  | 0  | 0  |
| 2033 | 11 | 0  | 0  | 17 | 2  | 1  | 0  | 76 | 2  | 0  | 0  | 0  |
| 2034 | 11 | 0  | 0  | 17 | 2  | 1  | 0  | 76 | 2  | 0  | 0  | 0  |
| 2035 | 11 | 0  | 0  | 17 | 2  | 1  | 0  | 76 | 2  | 0  | 0  | 0  |
| 2036 | 11 | 0  | 0  | 17 | 2  | 1  | 0  | 76 | 2  | 0  | 0  | 0  |
| 2037 | 11 | 0  | 0  | 17 | 2  | 1  | 0  | 76 | 2  | 0  | 0  | 0  |
| 2038 | 11 | 0  | 0  | 17 | 2  | 1  | 0  | 76 | 2  | 0  | 0  | 0  |
| 2039 | 11 | 0  | 0  | 17 | 2  | 1  | 0  | 76 | 2  | 0  | 0  | 0  |
| 2040 | 11 | 0  | 0  | 17 | 2  | 1  | 0  | 76 | 2  | 0  | 0  | 0  |
| 2041 | 11 | 0  | 0  | 17 | 2  | 1  | 0  | 76 | 2  | 0  | 0  | 0  |
| 2042 | 11 | 0  | 0  | 17 | 2  | 1  | 0  | 76 | 2  | 0  | 0  | 0  |
| 2043 | 11 | 0  | 0  | 17 | 2  | 1  | 0  | 76 | 2  | 0  | 0  | 0  |
| 2044 | 11 | 0  | 0  | 17 | 2  | 1  | 0  | 76 | 2  | 0  | 0  | 0  |
| 2045 | 11 | 0  | 0  | 17 | 2  | 1  | 0  | 76 | 2  | 0  | 0  | 0  |
| 2046 | 11 | 0  | 0  | 17 | 2  | 1  | 0  | 76 | 2  | 0  | 0  | 0  |
| 2047 | 11 | 0  | 0  | 17 | 2  | 1  | 0  | 76 | 2  | 0  | 0  | 0  |
| 2048 | 11 | 0  | 0  | 17 | 2  | 1  | 0  | 76 | 2  | 0  | 0  | 0  |
| 2049 | 11 | 0  | 0  | 17 | 2  | 1  | 0  | 76 | 2  | 0  | 0  | 0  |
| 2050 | 11 | 0  | 0  | 17 | 2  | 1  | 0  | 76 | 2  | 0  | 0  | 0  |
| 2051 | 11 | 0  | 0  | 17 | 2  | 1  | 0  | 76 | 2  | 0  | 0  | 0  |
| 2052 | 11 | 0  | 0  | 17 | 2  | 1  | 0  | 76 | 2  | 0  | 0  | 0  |
| 2053 | 11 | 0  | 0  | 17 | 2  | 1  | 0  | 76 | 2  | 0  | 0  | 0  |
| 2054 | 11 | 0  | 0  | 17 | 2  | 1  | 0  | 76 | 2  | 0  | 0  | 0  |
| 2055 | 11 | 0  | 0  | 17 | 2  | 1  | 0  | 76 | 2  | 0  | 0  | 0  |
| 2056 | 11 | 0  | 0  | 17 | 2  | 1  | 0  | 76 | 2  | 0  | 0  | 0  |
| 2057 | 11 | 0  | 0  | 17 | 2  | 1  | 0  | 76 | 2  | 0  | 0  | 0  |
| 2058 | 11 | 0  | 0  | 17 | 2  | 1  | 0  | 76 | 2  | 0  | 0  | 0  |
| 2059 | 11 | 0  | 0  | 17 | 2  | 1  | 0  | 76 | 2  | 0  | 0  | 0  |

|      | 73 | 74 | 75 | 76 | 77 | 78 | 79 | 80 | 81 | 82 | 83 | 84 |
|------|----|----|----|----|----|----|----|----|----|----|----|----|
| 2060 | 11 | 0  | 0  | 17 | 2  | 1  | 0  | 76 | 2  | 0  | 0  | 0  |
| 2061 | 11 | 0  | 0  | 17 | 2  | 1  | 0  | 76 | 2  | 0  | 0  | 0  |
| 2062 | 11 | 0  | 0  | 17 | 2  | 1  | 0  | 76 | 2  | 0  | 0  | 0  |
| 2063 | 11 | 0  | 0  | 17 | 2  | 1  | 0  | 76 | 2  | 0  | 0  | 0  |
| 2064 | 11 | 0  | 0  | 17 | 2  | 1  | 0  | 76 | 2  | 0  | 0  | 0  |
| 2065 | 11 | 0  | 0  | 17 | 2  | 1  | 0  | 76 | 2  | 0  | 0  | 0  |
| 2066 | 11 | 0  | 0  | 17 | 2  | 1  | 0  | 76 | 2  | 0  | 0  | 0  |
| 2067 | 11 | 0  | 0  | 17 | 2  | 1  | 0  | 76 | 2  | 0  | 0  | 0  |
| 2068 | 11 | 0  | 0  | 17 | 2  | 1  | 0  | 76 | 2  | 0  | 0  | 0  |
| 2069 | 11 | 0  | 0  | 17 | 2  | 1  | 0  | 76 | 2  | 0  | 0  | 0  |
| 2070 | 11 | 0  | 0  | 17 | 2  | 1  | 0  | 76 | 2  | 0  | 0  | 0  |
| 2071 | 11 | 0  | 0  | 17 | 2  | 1  | 0  | 76 | 2  | 0  | 0  | 0  |
| 2072 | 11 | 0  | 0  | 17 | 2  | 1  | 0  | 76 | 2  | 0  | 0  | 0  |
| 2073 | 11 | 0  | 0  | 17 | 2  | 1  | 0  | 76 | 2  | 0  | 0  | 0  |
| 2074 | 11 | 0  | 0  | 17 | 2  | 1  | 0  | 76 | 2  | 0  | 0  | 0  |
| 2075 | 11 | 0  | 0  | 17 | 2  | 1  | 0  | 76 | 2  | 0  | 0  | 0  |
| 2076 | 11 | 0  | 0  | 17 | 2  | 1  | 0  | 76 | 2  | 0  | 0  | 0  |
| 2077 | 11 | 0  | 0  | 17 | 2  | 1  | 0  | 76 | 2  | 0  | 0  | 0  |
| 2078 | 11 | 0  | 0  | 17 | 2  | 1  | 0  | 76 | 2  | 0  | 0  | 0  |
| 2079 | 11 | 0  | 0  | 17 | 2  | 1  | 0  | 76 | 2  | 0  | 0  | 0  |
| 2080 | 11 | 0  | 0  | 17 | 2  | 1  | 0  | 76 | 2  | 0  | 0  | 0  |
| 2081 | 11 | 0  | 0  | 17 | 2  | 1  | 0  | 76 | 2  | 0  | 0  | 0  |
| 2082 | 11 | 0  | 0  | 17 | 2  | 1  | 0  | 76 | 2  | 0  | 0  | 0  |
| 2083 | 11 | 0  | 0  | 17 | 2  | 1  | 0  | 76 | 2  | 0  | 0  | 0  |
| 2084 | 11 | 0  | 0  | 17 | 2  | 1  | 0  | 76 | 2  | 0  | 0  | 0  |
| 2085 | 11 | 0  | 0  | 17 | 2  | 1  | 0  | 76 | 2  | 0  | 0  | 0  |
| 2086 | 11 | 0  | 0  | 17 | 2  | 1  | 0  | 76 | 2  | 0  | 0  | 0  |
| 2087 | 11 | 0  | 0  | 17 | 2  | 1  | 0  | 76 | 2  | 0  | 0  | 0  |
| 2088 | 11 | 0  | 0  | 17 | 2  | 1  | 0  | 76 | 2  | 0  | 0  | 0  |
| 2089 | 11 | 0  | 0  | 17 | 2  | 1  | 0  | 76 | 2  | 0  | 0  | 0  |
| 2090 | 11 | 0  | 0  | 17 | 2  | 1  | 0  | 76 | 2  | 0  | 0  | 0  |

|      | 85 | 86 | 87 | 88 | 89 | 90 | 91 | 92 | 93 | 94 | 95 | 96 |
|------|----|----|----|----|----|----|----|----|----|----|----|----|
| 2002 | 0  | 0  | 0  | 0  | 0  | 0  | 0  | 0  | 0  | 0  | 0  | 0  |
| 2003 | 0  | 0  | 0  | 0  | 0  | 0  | 0  | 0  | 0  | 0  | 0  | 0  |
| 2004 | 0  | 0  | 0  | 0  | 0  | 0  | 0  | 0  | 0  | 0  | 0  | 0  |
| 2005 | 0  | 0  | 0  | 0  | 0  | 0  | 0  | 0  | 0  | 0  | 0  | 0  |
| 2006 | 0  | 0  | 0  | 0  | 0  | 0  | 0  | 0  | 0  | 0  | 0  | 0  |
| 2007 | 0  | 0  | 0  | 0  | 0  | 0  | 0  | 0  | 0  | 0  | 0  | 0  |
| 2008 | 0  | 0  | 0  | 0  | 0  | 0  | 0  | 0  | 0  | 0  | 0  | 0  |
| 2009 | 0  | 0  | 0  | 0  | 0  | 0  | 0  | 0  | 0  | 0  | 0  | 0  |
| 2010 | 0  | 0  | 0  | 0  | 0  | 0  | 0  | 0  | 0  | 0  | 0  | 0  |
| 2011 | 0  | 0  | 0  | 0  | 0  | 0  | 0  | 0  | 0  | 0  | 0  | 0  |
| 2012 | 0  | 0  | 0  | 0  | 0  | 0  | 0  | 0  | 0  | 0  | 0  | 0  |
| 2013 | 0  | 0  | 0  | 0  | 0  | 0  | 0  | 0  | 0  | 0  | 0  | 0  |
| 2014 | 0  | 0  | 0  | 0  | 0  | 0  | 0  | 0  | 0  | 0  | 0  | 0  |
| 2015 | 0  | 0  | 0  | 0  | 0  | 0  | 0  | 0  | 0  | 0  | 0  | 0  |
| 2016 | 0  | 0  | 0  | 0  | 0  | 0  | 0  | 0  | 0  | 0  | 0  | 0  |
| 2017 | 0  | 0  | 0  | 0  | 0  | 0  | 0  | 0  | 0  | 0  | 0  | 0  |
| 2018 | 0  | 0  | 0  | 0  | 0  | 0  | 0  | 0  | 0  | 0  | 0  | 0  |
| 2019 | 0  | 0  | 0  | 0  | 0  | 0  | 0  | 0  | 0  | 0  | 0  | 0  |
| 2020 | 0  | 0  | 0  | 0  | 0  | 0  | 0  | 0  | 0  | 0  | 0  | 0  |
| 2021 | 0  | 0  | 0  | 0  | 0  | 0  | 0  | 0  | 0  | 0  | 0  | 0  |
| 2022 | 0  | 0  | 0  | 0  | 0  | 0  | 0  | 0  | 0  | 3  | 0  | 0  |
| 2023 | 0  | 0  | 0  | 0  | 0  | 0  | 0  | 0  | 0  | 3  | 0  | 0  |
| 2024 | 0  | 0  | 0  | 0  | 0  | 0  | 0  | 0  | 0  | 3  | 0  | 0  |
| 2025 | 0  | 0  | 0  | 0  | 0  | 0  | 0  | 0  | 0  | 3  | 0  | 0  |
| 2026 | 0  | 0  | 0  | 0  | 0  | 0  | 0  | 0  | 0  | 3  | 0  | 0  |
| 2027 | 0  | 0  | 0  | 0  | 0  | 0  | 0  | 0  | 0  | 3  | 0  | 0  |
| 2028 | 0  | 0  | 0  | 0  | 0  | 0  | 0  | 0  | 0  | 3  | 0  | 0  |
| 2029 | 0  | 0  | 0  | 0  | 0  | 0  | 0  | 0  | 0  | 3  | 0  | 0  |
| 2030 | 0  | 0  | 0  | 0  | 0  | 0  | 0  | 0  | 0  | 3  | 0  | 0  |
| 2031 | 0  | 0  | 0  | 0  | 0  | 0  | 0  | 0  | 0  | 3  | 0  | 0  |
| 2032 | 0  | 0  | 0  | 0  | 0  | 0  | 0  | 0  | 0  | 3  | 0  | 0  |
| 2033 | 0  | 0  | 0  | 0  | 0  | 0  | 0  | 0  | 0  | 3  | 0  | 0  |
| 2034 | 0  | 0  | 0  | 0  | 0  | 0  | 0  | 0  | 0  | 3  | 0  | 0  |
| 2035 | 0  | 0  | 0  | 0  | 0  | 0  | 0  | 0  | 0  | 3  | 0  | 0  |
| 2036 | 0  | 0  | 0  | 0  | 0  | 0  | 0  | 0  | 0  | 3  | 0  | 0  |
| 2037 | 0  | 0  | 0  | 0  | 0  | 0  | 0  | 0  | 0  | 3  | 0  | 0  |
| 2038 | 0  | 0  | 0  | 0  | 0  | 0  | 0  | 0  | 0  | 3  | 0  | 0  |
| 2039 | 0  | 0  | 0  | 0  | 0  | 0  | 0  | 0  | 0  | 3  | 0  | 0  |
| 2040 | 0  | 0  | 0  | 0  | 0  | 0  | 0  | 0  | 0  | 3  | 0  | 0  |
| 2041 | 0  | 0  | 0  | 0  | 0  | 0  | 0  | 0  | 0  | 3  | 0  | 0  |
| 2042 | 0  | 0  | 0  | 0  | 0  | 0  | 0  | 0  | 0  | 3  | 0  | 0  |
| 2043 | 0  | 0  | 0  | 0  | 0  | 0  | 0  | 0  | 0  | 3  | 0  | 0  |
| 2044 | 0  | 0  | 0  | 0  | 0  | 0  | 0  | 0  | 0  | 3  | 0  | 0  |
| 2045 | 0  | 0  | 0  | 0  | 0  | 0  | 0  | 0  | 0  | 3  | 0  | 0  |
| 2046 | 0  | 0  | 0  | 0  | 0  | 0  | 0  | 0  | 0  | 3  | 0  | 0  |
| 2047 | 0  | 0  | 0  | 0  | 0  | 0  | 0  | 0  | 0  | 3  | 0  | 0  |
| 2048 | 0  | 0  | 0  | 0  | 0  | 0  | 0  | 0  | 0  | 3  | 0  | 0  |
| 2049 | 0  | 0  | 0  | 0  | 0  | 0  | 0  | 0  | 0  | 3  | 0  | 0  |
| 2050 | 0  | 0  | 0  | 0  | 0  | 0  | 0  | 0  | 0  | 3  | 0  | 0  |
| 2051 | 0  | 0  | 0  | 0  | 0  | 0  | 0  | 0  | 0  | 3  | 0  | 0  |
| 2052 | 0  | 0  | 0  | 0  | 0  | 0  | 0  | 0  | 0  | 3  | 0  | 0  |
| 2053 | 0  | 0  | 0  | 0  | 0  | 0  | 0  | 0  | 0  | 3  | 0  | 0  |
| 2054 | 0  | 0  | 0  | 0  | 0  | 0  | 0  | 0  | 0  | 3  | 0  | 0  |
| 2055 | 0  | 0  | 0  | 0  | 0  | 0  | 0  | 0  | 0  | 3  | 0  | 0  |
| 2056 | 0  | 0  | 0  | 0  | 0  | 0  | 0  | 0  | 0  | 3  | 0  | 0  |
| 2057 | 0  | 0  | 0  | 0  | 0  | 0  | 0  | 0  | 0  | 3  | 0  | 0  |
| 2058 | 0  | 0  | 0  | 0  | 0  | 0  | 0  | 0  | 0  | 3  | 0  | 0  |
| 2059 | 0  | 0  | 0  | 0  | 0  | 0  | 0  | 0  | 0  | 3  | 0  | 0  |

|      | 85 | 86 | 87 | 88 | 89 | 90 | 91 | 92 | 93 | 94 | 95 | 96 |
|------|----|----|----|----|----|----|----|----|----|----|----|----|
| 2060 | 0  | 0  | 0  | 0  | 0  | 0  | 0  | 0  | 0  | 3  | 0  | 0  |
| 2061 | 0  | 0  | 0  | 0  | 0  | 0  | 0  | 0  | 0  | 3  | 0  | 0  |
| 2062 | 0  | 0  | 0  | 0  | 0  | 0  | 0  | 0  | 0  | 3  | 0  | 0  |
| 2063 | 0  | 0  | 0  | 0  | 0  | 0  | 0  | 0  | 0  | 3  | 0  | 0  |
| 2064 | 0  | 0  | 0  | 0  | 0  | 0  | 0  | 0  | 0  | 3  | 0  | 0  |
| 2065 | 0  | 0  | 0  | 0  | 0  | 0  | 0  | 0  | 0  | 3  | 0  | 0  |
| 2066 | 0  | 0  | 0  | 0  | 0  | 0  | 0  | 0  | 0  | 3  | 0  | 0  |
| 2067 | 0  | 0  | 0  | 0  | 0  | 0  | 0  | 0  | 0  | 3  | 0  | 0  |
| 2068 | 0  | 0  | 0  | 0  | 0  | 0  | 0  | 0  | 0  | 3  | 0  | 0  |
| 2069 | 0  | 0  | 0  | 0  | 0  | 0  | 0  | 0  | 0  | 3  | 0  | 0  |
| 2070 | 0  | 0  | 0  | 0  | 0  | 0  | 0  | 0  | 0  | 3  | 0  | 0  |
| 2071 | 0  | 0  | 0  | 0  | 0  | 0  | 0  | 0  | 0  | 3  | 0  | 0  |
| 2072 | 0  | 0  | 0  | 0  | 0  | 0  | 0  | 0  | 0  | 3  | 0  | 0  |
| 2073 | 0  | 0  | 0  | 0  | 0  | 0  | 0  | 0  | 0  | 3  | 0  | 0  |
| 2074 | 0  | 0  | 0  | 0  | 0  | 0  | 0  | 0  | 0  | 3  | 0  | 0  |
| 2075 | 0  | 0  | 0  | 0  | 0  | 0  | 0  | 0  | 0  | 3  | 0  | 0  |
| 2076 | 0  | 0  | 0  | 0  | 0  | 0  | 0  | 0  | 0  | 3  | 0  | 0  |
| 2077 | 0  | 0  | 0  | 0  | 0  | 0  | 0  | 0  | 0  | 3  | 0  | 0  |
| 2078 | 0  | 0  | 0  | 0  | 0  | 0  | 0  | 0  | 0  | 3  | 0  | 0  |
| 2079 | 0  | 0  | 0  | 0  | 0  | 0  | 0  | 0  | 0  | 3  | 0  | 0  |
| 2080 | 0  | 0  | 0  | 0  | 0  | 0  | 0  | 0  | 0  | 3  | 0  | 0  |
| 2081 | 0  | 0  | 0  | 0  | 0  | 0  | 0  | 0  | 0  | 3  | 0  | 0  |
| 2082 | 0  | 0  | 0  | 0  | 0  | 0  | 0  | 0  | 0  | 3  | 0  | 0  |
| 2083 | 0  | 0  | 0  | 0  | 0  | 0  | 0  | 0  | 0  | 3  | 0  | 0  |
| 2084 | 0  | 0  | 0  | 0  | 0  | 0  | 0  | 0  | 0  | 3  | 0  | 0  |
| 2085 | 0  | 0  | 0  | 0  | 0  | 0  | 0  | 0  | 0  | 3  | 0  | 0  |
| 2086 | 0  | 0  | 0  | 0  | 0  | 0  | 0  | 0  | 0  | 3  | 0  | 0  |
| 2087 | 0  | 0  | 0  | 0  | 0  | 0  | 0  | 0  | 0  | 3  | 0  | 0  |
| 2088 | 0  | 0  | 0  | 0  | 0  | 0  | 0  | 0  | 0  | 3  | 0  | 0  |
| 2089 | 0  | 0  | 0  | 0  | 0  | 0  | 0  | 0  | 0  | 3  | 0  | 0  |
| 2090 | 0  | 0  | 0  | 0  | 0  | 0  | 0  | 0  | 0  | 3  | 0  | 0  |

|      | 97 | 98 | 99 | 100 | 101 | 102 | 103 | 104 | 105 | 106 | 107 | 108 |
|------|----|----|----|-----|-----|-----|-----|-----|-----|-----|-----|-----|
| 2002 | 0  | 0  | 0  | 0   | 0   | 0   | 0   | 0   | 0   | 0   | 0   | 0   |
| 2003 | 0  | 0  | 0  | 0   | 0   | 0   | 0   | 0   | 0   | 0   | 0   | 0   |
| 2004 | 0  | 0  | 0  | 0   | 0   | 0   | 0   | 0   | 0   | 0   | 0   | 0   |
| 2005 | 0  | 0  | 0  | 0   | 0   | 0   | 0   | 0   | 0   | 0   | 0   | 0   |
| 2006 | 0  | 0  | 0  | 0   | 0   | 0   | 0   | 0   | 0   | 0   | 0   | 0   |
| 2007 | 0  | 0  | 0  | 0   | 0   | 0   | 0   | 0   | 0   | 0   | 0   | 0   |
| 2008 | 0  | 0  | 0  | 0   | 0   | 0   | 0   | 0   | 0   | 0   | 0   | 0   |
| 2009 | 0  | 0  | 0  | 0   | 0   | 0   | 0   | 0   | 0   | 0   | 0   | 0   |
| 2010 | 0  | 0  | 0  | 0   | 0   | 0   | 0   | 0   | 0   | 0   | 0   | 0   |
| 2011 | 0  | 0  | 0  | 0   | 0   | 0   | 0   | 0   | 0   | 0   | 0   | 0   |
| 2012 | 0  | 0  | 0  | 0   | 0   | 0   | 0   | 0   | 0   | 0   | 0   | 0   |
| 2013 | 0  | 0  | 0  | 0   | 0   | 0   | 0   | 0   | 0   | 0   | 0   | 0   |
| 2014 | 0  | 0  | 0  | 0   | 0   | 0   | 0   | 0   | 0   | 0   | 0   | 0   |
| 2015 | 0  | 0  | 0  | 0   | 0   | 0   | 0   | 0   | 0   | 0   | 0   | 0   |
| 2016 | 0  | 0  | 0  | 0   | 0   | 0   | 0   | 0   | 0   | 0   | 0   | 0   |
| 2017 | 0  | 0  | 0  | 0   | 0   | 0   | 0   | 0   | 0   | 0   | 0   | 0   |
| 2018 | 0  | 0  | 0  | 0   | 0   | 0   | 0   | 0   | 0   | 0   | 0   | 0   |
| 2019 | 0  | 0  | 0  | 0   | 0   | 0   | 0   | 0   | 0   | 0   | 0   | 0   |
| 2020 | 0  | 0  | 0  | 0   | 0   | 0   | 0   | 0   | 0   | 0   | 0   | 0   |
| 2021 | 0  | 0  | 0  | 0   | 0   | 0   | 8   | 0   | 0   | 0   | 0   | 0   |
| 2022 | 0  | 0  | 0  | 0   | 0   | 0   | 11  | 0   | 0   | 0   | 0   | 0   |
| 2023 | 0  | 0  | 0  | 0   | 0   | 0   | 15  | 0   | 0   | 0   | 0   | 0   |
| 2024 | 0  | 0  | 0  | 0   | 0   | 0   | 15  | 0   | 0   | 0   | 0   | 0   |
| 2025 | 0  | 0  | 0  | 0   | 0   | 0   | 15  | 0   | 0   | 0   | 0   | 0   |
| 2026 | 0  | 5  | 0  | 2   | 0   | 0   | 15  | 0   | 0   | 0   | 15  | 0   |
| 2027 | 0  | 11 | 0  | 7   | 0   | 0   | 15  | 2   | 0   | 0   | 33  | 2   |
| 2028 | 0  | 15 | 0  | 7   | 0   | 0   | 15  | 2   | 0   | 0   | 46  | 2   |
| 2029 | 0  | 21 | 0  | 10  | 0   | 0   | 15  | 2   | 0   | 0   | 63  | 2   |
| 2030 | 0  | 21 | 0  | 10  | 0   | 0   | 15  | 2   | 0   | 0   | 72  | 2   |
| 2031 | 0  | 24 | 0  | 10  | 0   | 0   | 15  | 2   | 0   | 0   | 79  | 2   |
| 2032 | 0  | 24 | 0  | 10  | 0   | 0   | 15  | 2   | 0   | 0   | 79  | 2   |
| 2033 | 0  | 24 | 0  | 10  | 0   | 0   | 15  | 2   | 0   | 0   | 79  | 2   |
| 2034 | 0  | 24 | 0  | 10  | 0   | 0   | 15  | 2   | 0   | 0   | 79  | 2   |
| 2035 | 0  | 24 | 0  | 10  | 0   | 0   | 15  | 2   | 0   | 0   | 79  | 2   |
| 2036 | 0  | 24 | 0  | 10  | 0   | 0   | 15  | 2   | 0   | 0   | 79  | 2   |
| 2037 | 0  | 24 | 0  | 10  | 0   | 0   | 15  | 2   | 0   | 0   | 79  | 2   |
| 2038 | 0  | 24 | 0  | 10  | 0   | 0   | 15  | 2   | 0   | 0   | 79  | 2   |
| 2039 | 0  | 24 | 0  | 10  | 0   | 0   | 15  | 2   | 0   | 0   | 79  | 2   |
| 2040 | 0  | 24 | 0  | 10  | 0   | 0   | 15  | 2   | 0   | 0   | 79  | 2   |
| 2041 | 0  | 24 | 0  | 10  | 0   | 0   | 15  | 2   | 0   | 0   | 79  | 2   |
| 2042 | 0  | 24 | 0  | 10  | 0   | 0   | 15  | 2   | 0   | 0   | 79  | 2   |
| 2043 | 0  | 24 | 0  | 10  | 0   | 0   | 15  | 2   | 0   | 0   | 79  | 2   |
| 2044 | 0  | 24 | 0  | 10  | 0   | 0   | 15  | 2   | 0   | 0   | 79  | 2   |
| 2045 | 0  | 24 | 0  | 10  | 0   | 0   | 15  | 2   | 0   | 0   | 79  | 2   |
| 2046 | 0  | 24 | 0  | 10  | 0   | 0   | 15  | 2   | 0   | 0   | 79  | 2   |
| 2047 | 0  | 24 | 0  | 10  | 0   | 0   | 15  | 2   | 0   | 0   | 79  | 2   |
| 2048 | 0  | 24 | 0  | 10  | 0   | 0   | 15  | 2   | 0   | 0   | 79  | 2   |
| 2049 | 0  | 24 | 0  | 10  | 0   | 0   | 15  | 2   | 0   | 0   | 79  | 2   |
| 2050 | 0  | 24 | 0  | 10  | 0   | 0   | 15  | 2   | 0   | 0   | 79  | 2   |
| 2051 | 0  | 24 | 0  | 10  | 0   | 0   | 15  | 2   | 0   | 0   | 79  | 2   |
| 2052 | 0  | 24 | 0  | 10  | 0   | 0   | 15  | 2   | 0   | 0   | 79  | 2   |
| 2053 | 0  | 24 | 0  | 10  | 0   | 0   | 15  | 2   | 0   | 0   | 79  | 2   |
| 2054 | 0  | 24 | 0  | 10  | 0   | 0   | 15  | 2   | 0   | 0   | 79  | 2   |
| 2055 | 0  | 24 | 0  | 10  | 0   | 0   | 15  | 2   | 0   | 0   | 79  | 2   |
| 2056 | 0  | 24 | 0  | 10  | 0   | 0   | 15  | 2   | 0   | 0   | 79  | 2   |
| 2057 | 0  | 24 | 0  | 10  | 0   | 0   | 15  | 2   | 0   | 0   | 79  | 2   |
| 2058 | 0  | 24 | 0  | 10  | 0   | 0   | 15  | 2   | 0   | 0   | 79  | 2   |
| 2059 | 0  | 24 | 0  | 10  | 0   | 0   | 15  | 2   | 0   | 0   | 79  | 2   |

|      | 97 | 98 | 99 | 100 | 101 | 102 | 103 | 104 | 105 | 106 | 107 | 108 |
|------|----|----|----|-----|-----|-----|-----|-----|-----|-----|-----|-----|
| 2060 | 0  | 24 | 0  | 10  | 0   | 0   | 15  | 2   | 0   | 0   | 79  | 2   |
| 2061 | 0  | 24 | 0  | 10  | 0   | 0   | 15  | 2   | 0   | 0   | 79  | 2   |
| 2062 | 0  | 24 | 0  | 10  | 0   | 0   | 15  | 2   | 0   | 0   | 79  | 2   |
| 2063 | 0  | 24 | 0  | 10  | 0   | 0   | 15  | 2   | 0   | 0   | 79  | 2   |
| 2064 | 0  | 24 | 0  | 10  | 0   | 0   | 15  | 2   | 0   | 0   | 79  | 2   |
| 2065 | 0  | 24 | 0  | 10  | 0   | 0   | 15  | 2   | 0   | 0   | 79  | 2   |
| 2066 | 0  | 24 | 0  | 10  | 0   | 0   | 15  | 2   | 0   | 0   | 79  | 2   |
| 2067 | 0  | 24 | 0  | 10  | 0   | 0   | 15  | 2   | 0   | 0   | 79  | 2   |
| 2068 | 0  | 24 | 0  | 10  | 0   | 0   | 15  | 2   | 0   | 0   | 79  | 2   |
| 2069 | 0  | 24 | 0  | 10  | 0   | 0   | 15  | 2   | 0   | 0   | 79  | 2   |
| 2070 | 0  | 24 | 0  | 10  | 0   | 0   | 15  | 2   | 0   | 0   | 79  | 2   |
| 2071 | 0  | 24 | 0  | 10  | 0   | 0   | 15  | 2   | 0   | 0   | 79  | 2   |
| 2072 | 0  | 24 | 0  | 10  | 0   | 0   | 15  | 2   | 0   | 0   | 79  | 2   |
| 2073 | 0  | 24 | 0  | 10  | 0   | 0   | 15  | 2   | 0   | 0   | 79  | 2   |
| 2074 | 0  | 24 | 0  | 10  | 0   | 0   | 15  | 2   | 0   | 0   | 79  | 2   |
| 2075 | 0  | 24 | 0  | 10  | 0   | 0   | 15  | 2   | 0   | 0   | 79  | 2   |
| 2076 | 0  | 24 | 0  | 10  | 0   | 0   | 15  | 2   | 0   | 0   | 79  | 2   |
| 2077 | 0  | 24 | 0  | 10  | 0   | 0   | 15  | 2   | 0   | 0   | 79  | 2   |
| 2078 | 0  | 24 | 0  | 10  | 0   | 0   | 15  | 2   | 0   | 0   | 79  | 2   |
| 2079 | 0  | 24 | 0  | 10  | 0   | 0   | 15  | 2   | 0   | 0   | 79  | 2   |
| 2080 | 0  | 24 | 0  | 10  | 0   | 0   | 15  | 2   | 0   | 0   | 79  | 2   |
| 2081 | 0  | 24 | 0  | 10  | 0   | 0   | 15  | 2   | 0   | 0   | 79  | 2   |
| 2082 | 0  | 24 | 0  | 10  | 0   | 0   | 15  | 2   | 0   | 0   | 79  | 2   |
| 2083 | 0  | 24 | 0  | 10  | 0   | 0   | 15  | 2   | 0   | 0   | 79  | 2   |
| 2084 | 0  | 24 | 0  | 10  | 0   | 0   | 15  | 2   | 0   | 0   | 79  | 2   |
| 2085 | 0  | 24 | 0  | 10  | 0   | 0   | 15  | 2   | 0   | 0   | 79  | 2   |
| 2086 | 0  | 24 | 0  | 10  | 0   | 0   | 15  | 2   | 0   | 0   | 79  | 2   |
| 2087 | 0  | 24 | 0  | 10  | 0   | 0   | 15  | 2   | 0   | 0   | 79  | 2   |
| 2088 | 0  | 24 | 0  | 10  | 0   | 0   | 15  | 2   | 0   | 0   | 79  | 2   |
| 2089 | 0  | 24 | 0  | 10  | 0   | 0   | 15  | 2   | 0   | 0   | 79  | 2   |
| 2090 | 0  | 24 | 0  | 10  | 0   | 0   | 15  | 2   | 0   | 0   | 79  | 2   |

|      | 109 | 110 | 111 | 112 | 113 | 114 | 115 | 116 | 117 | 118 | 119 | 120 |
|------|-----|-----|-----|-----|-----|-----|-----|-----|-----|-----|-----|-----|
| 2002 | 0   | 0   | 0   | 0   | 0   | 0   | 0   | 0   | 0   | 0   | 0   | 0   |
| 2003 | 0   | 0   | 0   | 0   | 0   | 0   | 0   | 0   | 0   | 0   | 0   | 0   |
| 2004 | 0   | 0   | 0   | 0   | 0   | 0   | 0   | 0   | 0   | 0   | 0   | 0   |
| 2005 | 0   | 0   | 0   | 0   | 0   | 0   | 0   | 0   | 0   | 0   | 0   | 0   |
| 2006 | 0   | 0   | 0   | 0   | 0   | 0   | 0   | 0   | 0   | 0   | 0   | 0   |
| 2007 | 0   | 0   | 0   | 0   | 0   | 0   | 0   | 0   | 0   | 0   | 0   | 0   |
| 2008 | 0   | 0   | 0   | 0   | 0   | 0   | 0   | 0   | 0   | 0   | 0   | 0   |
| 2009 | 0   | 0   | 0   | 0   | 0   | 0   | 0   | 0   | 0   | 0   | 0   | 0   |
| 2010 | 0   | 0   | 0   | 0   | 0   | 0   | 0   | 0   | 0   | 0   | 0   | 0   |
| 2011 | 0   | 0   | 0   | 0   | 0   | 0   | 0   | 0   | 0   | 0   | 0   | 0   |
| 2012 | 0   | 0   | 0   | 0   | 0   | 0   | 0   | 0   | 0   | 0   | 0   | 0   |
| 2013 | 0   | 0   | 0   | 0   | 0   | 0   | 0   | 0   | 0   | 0   | 0   | 0   |
| 2014 | 0   | 0   | 0   | 0   | 0   | 0   | 0   | 0   | 0   | 0   | 0   | 0   |
| 2015 | 0   | 0   | 0   | 0   | 0   | 0   | 0   | 0   | 0   | 0   | 0   | 0   |
| 2016 | 0   | 0   | 0   | 0   | 0   | 0   | 0   | 0   | 0   | 0   | 0   | 0   |
| 2017 | 0   | 0   | 0   | 0   | 0   | 0   | 0   | 0   | 0   | 0   | 0   | 0   |
| 2018 | 0   | 0   | 0   | 0   | 0   | 0   | 0   | 0   | 0   | 0   | 0   | 0   |
| 2019 | 0   | 0   | 0   | 0   | 0   | 0   | 0   | 0   | 0   | 0   | 0   | 0   |
| 2020 | 0   | 0   | 0   | 0   | 0   | 0   | 0   | 0   | 0   | 0   | 0   | 0   |
| 2021 | 0   | 0   | 0   | 0   | 0   | 0   | 0   | 0   | 0   | 0   | 0   | 0   |
| 2022 | 0   | 0   | 0   | 0   | 0   | 0   | 0   | 0   | 0   | 0   | 0   | 0   |
| 2023 | 0   | 0   | 0   | 0   | 0   | 0   | 0   | 0   | 0   | 0   | 0   | 0   |
| 2024 | 0   | 0   | 0   | 0   | 0   | 0   | 0   | 0   | 0   | 0   | 0   | 0   |
| 2025 | 0   | 0   | 0   | 0   | 0   | 0   | 0   | 0   | 0   | 0   | 0   | 0   |
| 2026 | 0   | 0   | 0   | 0   | 0   | 0   | 0   | 0   | 0   | 0   | 0   | 0   |
| 2027 | 0   | 0   | 0   | 0   | 0   | 0   | 0   | 0   | 0   | 0   | 0   | 0   |
| 2028 | 0   | 0   | 0   | 0   | 0   | 0   | 0   | 0   | 0   | 0   | 0   | 0   |
| 2029 | 0   | 0   | 0   | 0   | 0   | 0   | 0   | 0   | 0   | 0   | 0   | 0   |
| 2030 | 0   | 0   | 0   | 0   | 0   | 0   | 0   | 0   | 0   | 0   | 0   | 0   |
| 2031 | 0   | 0   | 0   | 0   | 0   | 0   | 0   | 0   | 0   | 0   | 0   | 0   |
| 2032 | 0   | 0   | 0   | 0   | 0   | 0   | 0   | 0   | 0   | 0   | 0   | 0   |
| 2033 | 0   | 0   | 0   | 0   | 0   | 0   | 0   | 0   | 0   | 0   | 0   | 0   |
| 2034 | 0   | 0   | 0   | 0   | 0   | 0   | 0   | 0   | 0   | 0   | 0   | 0   |
| 2035 | 0   | 0   | 0   | 0   | 0   | 0   | 0   | 0   | 0   | 0   | 0   | 0   |
| 2036 | 0   | 0   | 0   | 0   | 0   | 0   | 0   | 0   | 0   | 0   | 0   | 0   |
| 2037 | 0   | 0   | 0   | 0   | 0   | 0   | 0   | 0   | 0   | 0   | 0   | 0   |
| 2038 | 0   | 0   | 0   | 0   | 0   | 0   | 0   | 0   | 0   | 0   | 0   | 0   |
| 2039 | 0   | 0   | 0   | 0   | 0   | 0   | 0   | 0   | 0   | 0   | 0   | 0   |
| 2040 | 0   | 0   | 0   | 0   | 0   | 0   | 0   | 0   | 0   | 0   | 0   | 0   |
| 2041 | 0   | 0   | 0   | 0   | 0   | 0   | 0   | 0   | 0   | 0   | 0   | 0   |
| 2042 | 0   | 0   | 0   | 0   | 0   | 0   | 0   | 0   | 0   | 0   | 0   | 0   |
| 2043 | 0   | 0   | 0   | 0   | 0   | 0   | 0   | 0   | 0   | 0   | 0   | 0   |
| 2044 | 0   | 0   | 0   | 0   | 0   | 0   | 0   | 0   | 0   | 0   | 0   | 0   |
| 2045 | 0   | 0   | 0   | 0   | 0   | 0   | 0   | 0   | 0   | 0   | 0   | 0   |
| 2046 | 0   | 0   | 0   | 0   | 0   | 0   | 0   | 0   | 0   | 0   | 0   | 0   |
| 2047 | 0   | 0   | 0   | 0   | 0   | 0   | 0   | 0   | 0   | 0   | 0   | 0   |
| 2048 | 0   | 0   | 0   | 0   | 0   | 0   | 0   | 0   | 0   | 0   | 0   | 0   |
| 2049 | 0   | 0   | 0   | 0   | 0   | 0   | 0   | 0   | 0   | 0   | 0   | 0   |
| 2050 | 0   | 0   | 0   | 0   | 0   | 0   | 0   | 0   | 0   | 0   | 0   | 0   |
| 2051 | 0   | 0   | 0   | 0   | 0   | 0   | 0   | 0   | 0   | 0   | 0   | 0   |
| 2052 | 0   | 0   | 0   | 0   | 0   | 0   | 0   | 0   | 0   | 0   | 0   | 0   |
| 2053 | 0   | 0   | 0   | 0   | 0   | 0   | 0   | 0   | 0   | 0   | 0   | 0   |
| 2054 | 0   | 0   | 0   | 0   | 0   | 0   | 0   | 0   | 0   | 0   | 0   | 0   |
| 2055 | 0   | 0   | 0   | 0   | 0   | 0   | 0   | 0   | 0   | 0   | 0   | 0   |
| 2056 | 0   | 0   | 0   | 0   | 0   | 0   | 0   | 0   | 0   | 0   | 0   | 0   |
| 2057 | 0   | 0   | 0   | 0   | 0   | 0   | 0   | 0   | 0   | 0   | 0   | 0   |
| 2058 | 0   | 0   | 0   | 0   | 0   | 0   | 0   | 0   | 0   | 0   | 0   | 0   |
| 2059 | 0   | 0   | 0   | 0   | 0   | 0   | 0   | 0   | 0   | 0   | 0   | 0   |

|      | 109 | 110 | 111 | 112 | 113 | 114 | 115 | 116 | 117 | 118 | 119 | 120 |
|------|-----|-----|-----|-----|-----|-----|-----|-----|-----|-----|-----|-----|
| 2060 | 0   | 0   | 0   | 0   | 0   | 0   | 0   | 0   | 0   | 0   | 0   | 0   |
| 2061 | 0   | 0   | 0   | 0   | 0   | 0   | 0   | 0   | 0   | 0   | 0   | 0   |
| 2062 | 0   | 0   | 0   | 0   | 0   | 0   | 0   | 0   | 0   | 0   | 0   | 0   |
| 2063 | 0   | 0   | 0   | 0   | 0   | 0   | 0   | 0   | 0   | 0   | 0   | 0   |
| 2064 | 0   | 0   | 0   | 0   | 0   | 0   | 0   | 0   | 0   | 0   | 0   | 0   |
| 2065 | 0   | 0   | 0   | 0   | 0   | 0   | 0   | 0   | 0   | 0   | 0   | 0   |
| 2066 | 0   | 0   | 0   | 0   | 0   | 0   | 0   | 0   | 0   | 0   | 0   | 0   |
| 2067 | 0   | 0   | 0   | 0   | 0   | 0   | 0   | 0   | 0   | 0   | 0   | 0   |
| 2068 | 0   | 0   | 0   | 0   | 0   | 0   | 0   | 0   | 0   | 0   | 0   | 0   |
| 2069 | 0   | 0   | 0   | 0   | 0   | 0   | 0   | 0   | 0   | 0   | 0   | 0   |
| 2070 | 0   | 0   | 0   | 0   | 0   | 0   | 0   | 0   | 0   | 0   | 0   | 0   |
| 2071 | 0   | 0   | 0   | 0   | 0   | 0   | 0   | 0   | 0   | 0   | 0   | 0   |
| 2072 | 0   | 0   | 0   | 0   | 0   | 0   | 0   | 0   | 0   | 0   | 0   | 0   |
| 2073 | 0   | 0   | 0   | 0   | 0   | 0   | 0   | 0   | 0   | 0   | 0   | 0   |
| 2074 | 0   | 0   | 0   | 0   | 0   | 0   | 0   | 0   | 0   | 0   | 0   | 0   |
| 2075 | 0   | 0   | 0   | 0   | 0   | 0   | 0   | 0   | 0   | 0   | 0   | 0   |
| 2076 | 0   | 0   | 0   | 0   | 0   | 0   | 0   | 0   | 0   | 0   | 0   | 0   |
| 2077 | 0   | 0   | 0   | 0   | 0   | 0   | 0   | 0   | 0   | 0   | 0   | 0   |
| 2078 | 0   | 0   | 0   | 0   | 0   | 0   | 0   | 0   | 0   | 0   | 0   | 0   |
| 2079 | 0   | 0   | 0   | 0   | 0   | 0   | 0   | 0   | 0   | 0   | 0   | 0   |
| 2080 | 0   | 0   | 0   | 0   | 0   | 0   | 0   | 0   | 0   | 0   | 0   | 0   |
| 2081 | 0   | 0   | 0   | 0   | 0   | 0   | 0   | 0   | 0   | 0   | 0   | 0   |
| 2082 | 0   | 0   | 0   | 0   | 0   | 0   | 0   | 0   | 0   | 0   | 0   | 0   |
| 2083 | 0   | 0   | 0   | 0   | 0   | 0   | 0   | 0   | 0   | 0   | 0   | 0   |
| 2084 | 0   | 0   | 0   | 0   | 0   | 0   | 0   | 0   | 0   | 0   | 0   | 0   |
| 2085 | 0   | 0   | 0   | 0   | 0   | 0   | 0   | 0   | 0   | 0   | 0   | 0   |
| 2086 | 0   | 0   | 0   | 0   | 0   | 0   | 0   | 0   | 0   | 0   | 0   | 0   |
| 2087 | 0   | 0   | 0   | 0   | 0   | 0   | 0   | 0   | 0   | 0   | 0   | 0   |
| 2088 | 0   | 0   | 0   | 0   | 0   | 0   | 0   | 0   | 0   | 0   | 0   | 0   |
| 2089 | 0   | 0   | 0   | 0   | 0   | 0   | 0   | 0   | 0   | 0   | 0   | 0   |
| 2090 | 0   | 0   | 0   | 0   | 0   | 0   | 0   | 0   | 0   | 0   | 0   | 0   |



|      | 121 | 122 | 123 | 124 | 125 | 126 | 127 | 128 | 129 | 130 | 131 | 132 |
|------|-----|-----|-----|-----|-----|-----|-----|-----|-----|-----|-----|-----|
| 2002 | 0   | 0   | 0   | 0   | 0   | 0   | 0   | 0   | 0   | 0   | 0   | 0   |
| 2003 | 0   | 0   | 0   | 0   | 0   | 0   | 0   | 0   | 0   | 0   | 0   | 0   |
| 2004 | 0   | 0   | 0   | 0   | 0   | 0   | 0   | 0   | 0   | 0   | 0   | 0   |
| 2005 | 0   | 0   | 0   | 0   | 0   | 0   | 0   | 0   | 0   | 0   | 0   | 0   |
| 2006 | 0   | 0   | 0   | 0   | 0   | 0   | 0   | 0   | 0   | 0   | 0   | 0   |
| 2007 | 0   | 0   | 0   | 0   | 0   | 0   | 0   | 0   | 0   | 0   | 0   | 0   |
| 2008 | 0   | 0   | 0   | 0   | 0   | 0   | 0   | 0   | 0   | 0   | 0   | 0   |
| 2009 | 0   | 0   | 0   | 0   | 0   | 0   | 0   | 0   | 0   | 0   | 0   | 0   |
| 2010 | 0   | 0   | 0   | 0   | 0   | 0   | 0   | 0   | 0   | 0   | 0   | 0   |
| 2011 | 0   | 0   | 0   | 0   | 0   | 0   | 0   | 0   | 0   | 0   | 0   | 0   |
| 2012 | 0   | 0   | 0   | 0   | 0   | 0   | 0   | 0   | 0   | 0   | 0   | 0   |
| 2013 | 0   | 0   | 0   | 0   | 0   | 0   | 0   | 0   | 0   | 0   | 0   | 0   |
| 2014 | 0   | 0   | 0   | 0   | 0   | 0   | 0   | 0   | 0   | 0   | 0   | 0   |
| 2015 | 0   | 0   | 0   | 0   | 0   | 0   | 0   | 0   | 0   | 0   | 0   | 0   |
| 2016 | 0   | 0   | 0   | 0   | 0   | 0   | 0   | 0   | 0   | 0   | 0   | 0   |
| 2017 | 0   | 0   | 0   | 0   | 0   | 0   | 0   | 0   | 0   | 0   | 0   | 0   |
| 2018 | 0   | 0   | 0   | 0   | 0   | 0   | 0   | 0   | 0   | 0   | 0   | 0   |
| 2019 | 0   | 0   | 0   | 0   | 0   | 0   | 0   | 0   | 0   | 0   | 0   | 0   |
| 2020 | 0   | 0   | 0   | 0   | 0   | 0   | 0   | 0   | 0   | 0   | 0   | 0   |
| 2021 | 0   | 0   | 0   | 0   | 0   | 0   | 0   | 0   | 0   | 4   | 0   | 0   |
| 2022 | 0   | 0   | 0   | 0   | 0   | 0   | 0   | 0   | 0   | 4   | 0   | 0   |
| 2023 | 0   | 0   | 0   | 0   | 0   | 0   | 0   | 0   | 0   | 9   | 0   | 0   |
| 2024 | 0   | 0   | 0   | 0   | 0   | 0   | 0   | 0   | 0   | 9   | 0   | 0   |
| 2025 | 0   | 0   | 0   | 0   | 0   | 0   | 0   | 0   | 0   | 9   | 0   | 0   |
| 2026 | 0   | 0   | 0   | 0   | 6   | 0   | 0   | 0   | 0   | 9   | 0   | 0   |
| 2027 | 0   | 0   | 0   | 0   | 10  | 0   | 6   | 0   | 0   | 9   | 2   | 2   |
| 2028 | 0   | 0   | 0   | 0   | 10  | 0   | 6   | 0   | 0   | 9   | 2   | 2   |
| 2029 | 0   | 0   | 0   | 0   | 10  | 0   | 7   | 0   | 0   | 9   | 2   | 2   |
| 2030 | 0   | 0   | 0   | 0   | 10  | 0   | 7   | 0   | 0   | 9   | 2   | 2   |
| 2031 | 0   | 0   | 0   | 0   | 10  | 0   | 7   | 0   | 0   | 9   | 2   | 2   |
| 2032 | 0   | 0   | 0   | 0   | 10  | 0   | 7   | 0   | 0   | 9   | 2   | 2   |
| 2033 | 0   | 0   | 0   | 0   | 10  | 0   | 7   | 0   | 0   | 9   | 2   | 2   |
| 2034 | 0   | 0   | 0   | 0   | 10  | 0   | 7   | 0   | 0   | 9   | 2   | 2   |
| 2035 | 0   | 0   | 0   | 0   | 10  | 0   | 7   | 0   | 0   | 9   | 2   | 2   |
| 2036 | 0   | 0   | 0   | 0   | 10  | 0   | 7   | 0   | 0   | 9   | 2   | 2   |
| 2037 | 0   | 0   | 0   | 0   | 10  | 0   | 7   | 0   | 0   | 9   | 2   | 2   |
| 2038 | 0   | 0   | 0   | 0   | 10  | 0   | 7   | 0   | 0   | 9   | 2   | 2   |
| 2039 | 0   | 0   | 0   | 0   | 10  | 0   | 7   | 0   | 0   | 9   | 2   | 2   |
| 2040 | 0   | 0   | 0   | 0   | 10  | 0   | 7   | 0   | 0   | 9   | 2   | 2   |
| 2041 | 0   | 0   | 0   | 0   | 10  | 0   | 7   | 0   | 0   | 9   | 2   | 2   |
| 2042 | 0   | 0   | 0   | 0   | 10  | 0   | 7   | 0   | 0   | 9   | 2   | 2   |
| 2043 | 0   | 0   | 0   | 0   | 10  | 0   | 7   | 0   | 0   | 9   | 2   | 2   |
| 2044 | 0   | 0   | 0   | 0   | 10  | 0   | 7   | 0   | 0   | 9   | 2   | 2   |
| 2045 | 0   | 0   | 0   | 0   | 10  | 0   | 7   | 0   | 0   | 9   | 2   | 2   |
| 2046 | 0   | 0   | 0   | 0   | 10  | 0   | 7   | 0   | 0   | 9   | 2   | 2   |
| 2047 | 0   | 0   | 0   | 0   | 10  | 0   | 7   | 0   | 0   | 9   | 2   | 2   |
| 2048 | 0   | 0   | 0   | 0   | 10  | 0   | 7   | 0   | 0   | 9   | 2   | 2   |
| 2049 | 0   | 0   | 0   | 0   | 10  | 0   | 7   | 0   | 0   | 9   | 2   | 2   |
| 2050 | 0   | 0   | 0   | 0   | 10  | 0   | 7   | 0   | 0   | 9   | 2   | 2   |
| 2051 | 0   | 0   | 0   | 0   | 10  | 0   | 7   | 0   | 0   | 9   | 2   | 2   |
| 2052 | 0   | 0   | 0   | 0   | 10  | 0   | 7   | 0   | 0   | 9   | 2   | 2   |
| 2053 | 0   | 0   | 0   | 0   | 10  | 0   | 7   | 0   | 0   | 9   | 2   | 2   |
| 2054 | 0   | 0   | 0   | 0   | 10  | 0   | 7   | 0   | 0   | 9   | 2   | 2   |
| 2055 | 0   | 0   | 0   | 0   | 10  | 0   | 7   | 0   | 0   | 9   | 2   | 2   |
| 2056 | 0   | 0   | 0   | 0   | 10  | 0   | 7   | 0   | 0   | 9   | 2   | 2   |
| 2057 | 0   | 0   | 0   | 0   | 10  | 0   | 7   | 0   | 0   | 9   | 2   | 2   |
| 2058 | 0   | 0   | 0   | 0   | 10  | 0   | 7   | 0   | 0   | 9   | 2   | 2   |
| 2059 | 0   | 0   | 0   | 0   | 10  | 0   | 7   | 0   | 0   | 9   | 2   | 2   |

|      | 121 | 122 | 123 | 124 | 125 | 126 | 127 | 128 | 129 | 130 | 131 | 132 |
|------|-----|-----|-----|-----|-----|-----|-----|-----|-----|-----|-----|-----|
| 2060 | 0   | 0   | 0   | 0   | 10  | 0   | 7   | 0   | 0   | 9   | 2   | 2   |
| 2061 | 0   | 0   | 0   | 0   | 10  | 0   | 7   | 0   | 0   | 9   | 2   | 2   |
| 2062 | 0   | 0   | 0   | 0   | 10  | 0   | 7   | 0   | 0   | 9   | 2   | 2   |
| 2063 | 0   | 0   | 0   | 0   | 10  | 0   | 7   | 0   | 0   | 9   | 2   | 2   |
| 2064 | 0   | 0   | 0   | 0   | 10  | 0   | 7   | 0   | 0   | 9   | 2   | 2   |
| 2065 | 0   | 0   | 0   | 0   | 10  | 0   | 7   | 0   | 0   | 9   | 2   | 2   |
| 2066 | 0   | 0   | 0   | 0   | 10  | 0   | 7   | 0   | 0   | 9   | 2   | 2   |
| 2067 | 0   | 0   | 0   | 0   | 10  | 0   | 7   | 0   | 0   | 9   | 2   | 2   |
| 2068 | 0   | 0   | 0   | 0   | 10  | 0   | 7   | 0   | 0   | 9   | 2   | 2   |
| 2069 | 0   | 0   | 0   | 0   | 10  | 0   | 7   | 0   | 0   | 9   | 2   | 2   |
| 2070 | 0   | 0   | 0   | 0   | 10  | 0   | 7   | 0   | 0   | 9   | 2   | 2   |
| 2071 | 0   | 0   | 0   | 0   | 10  | 0   | 7   | 0   | 0   | 9   | 2   | 2   |
| 2072 | 0   | 0   | 0   | 0   | 10  | 0   | 7   | 0   | 0   | 9   | 2   | 2   |
| 2073 | 0   | 0   | 0   | 0   | 10  | 0   | 7   | 0   | 0   | 9   | 2   | 2   |
| 2074 | 0   | 0   | 0   | 0   | 10  | 0   | 7   | 0   | 0   | 9   | 2   | 2   |
| 2075 | 0   | 0   | 0   | 0   | 10  | 0   | 7   | 0   | 0   | 9   | 2   | 2   |
| 2076 | 0   | 0   | 0   | 0   | 10  | 0   | 7   | 0   | 0   | 9   | 2   | 2   |
| 2077 | 0   | 0   | 0   | 0   | 10  | 0   | 7   | 0   | 0   | 9   | 2   | 2   |
| 2078 | 0   | 0   | 0   | 0   | 10  | 0   | 7   | 0   | 0   | 9   | 2   | 2   |
| 2079 | 0   | 0   | 0   | 0   | 10  | 0   | 7   | 0   | 0   | 9   | 2   | 2   |
| 2080 | 0   | 0   | 0   | 0   | 10  | 0   | 7   | 0   | 0   | 9   | 2   | 2   |
| 2081 | 0   | 0   | 0   | 0   | 10  | 0   | 7   | 0   | 0   | 9   | 2   | 2   |
| 2082 | 0   | 0   | 0   | 0   | 10  | 0   | 7   | 0   | 0   | 9   | 2   | 2   |
| 2083 | 0   | 0   | 0   | 0   | 10  | 0   | 7   | 0   | 0   | 9   | 2   | 2   |
| 2084 | 0   | 0   | 0   | 0   | 10  | 0   | 7   | 0   | 0   | 9   | 2   | 2   |
| 2085 | 0   | 0   | 0   | 0   | 10  | 0   | 7   | 0   | 0   | 9   | 2   | 2   |
| 2086 | 0   | 0   | 0   | 0   | 10  | 0   | 7   | 0   | 0   | 9   | 2   | 2   |
| 2087 | 0   | 0   | 0   | 0   | 10  | 0   | 7   | 0   | 0   | 9   | 2   | 2   |
| 2088 | 0   | 0   | 0   | 0   | 10  | 0   | 7   | 0   | 0   | 9   | 2   | 2   |
| 2089 | 0   | 0   | 0   | 0   | 10  | 0   | 7   | 0   | 0   | 9   | 2   | 2   |
| 2090 | 0   | 0   | 0   | 0   | 10  | 0   | 7   | 0   | 0   | 9   | 2   | 2   |

|      | 133 | 134 | 135 | 136 | 137 | 138 | 139 | 140 | 141 | 142 | 143 | 144 |
|------|-----|-----|-----|-----|-----|-----|-----|-----|-----|-----|-----|-----|
| 2002 | 0   | 0   | 0   | 0   | 0   | 0   | 0   | 0   | 0   | 0   | 0   | 0   |
| 2003 | 0   | 0   | 0   | 0   | 0   | 0   | 0   | 0   | 0   | 0   | 0   | 0   |
| 2004 | 0   | 0   | 0   | 0   | 0   | 0   | 0   | 0   | 0   | 0   | 0   | 0   |
| 2005 | 0   | 0   | 0   | 0   | 0   | 0   | 0   | 0   | 0   | 0   | 0   | 0   |
| 2006 | 0   | 0   | 0   | 0   | 0   | 0   | 0   | 0   | 0   | 0   | 0   | 0   |
| 2007 | 0   | 0   | 0   | 0   | 0   | 0   | 0   | 0   | 0   | 0   | 0   | 0   |
| 2008 | 0   | 0   | 0   | 0   | 0   | 0   | 0   | 0   | 0   | 0   | 0   | 0   |
| 2009 | 0   | 0   | 0   | 0   | 0   | 0   | 0   | 0   | 0   | 0   | 0   | 0   |
| 2010 | 0   | 0   | 0   | 0   | 0   | 0   | 0   | 0   | 0   | 0   | 0   | 0   |
| 2011 | 0   | 0   | 0   | 0   | 0   | 0   | 0   | 0   | 0   | 0   | 0   | 0   |
| 2012 | 0   | 0   | 0   | 0   | 0   | 0   | 0   | 0   | 0   | 0   | 0   | 0   |
| 2013 | 0   | 0   | 0   | 0   | 0   | 0   | 0   | 0   | 0   | 0   | 0   | 0   |
| 2014 | 0   | 0   | 0   | 0   | 0   | 0   | 0   | 0   | 0   | 0   | 0   | 0   |
| 2015 | 0   | 0   | 0   | 0   | 0   | 0   | 0   | 0   | 0   | 0   | 0   | 0   |
| 2016 | 0   | 0   | 0   | 0   | 0   | 0   | 0   | 0   | 0   | 0   | 0   | 0   |
| 2017 | 0   | 0   | 0   | 0   | 0   | 0   | 0   | 0   | 0   | 0   | 0   | 0   |
| 2018 | 0   | 0   | 0   | 0   | 0   | 0   | 0   | 0   | 0   | 0   | 0   | 0   |
| 2019 | 0   | 0   | 0   | 0   | 0   | 0   | 0   | 0   | 0   | 0   | 0   | 0   |
| 2020 | 0   | 0   | 0   | 0   | 0   | 0   | 0   | 0   | 0   | 0   | 0   | 0   |
| 2021 | 0   | 0   | 0   | 0   | 0   | 0   | 0   | 0   | 0   | 0   | 0   | 0   |
| 2022 | 0   | 0   | 0   | 0   | 0   | 0   | 0   | 0   | 0   | 0   | 0   | 0   |
| 2023 | 0   | 0   | 0   | 0   | 0   | 0   | 0   | 0   | 0   | 0   | 0   | 0   |
| 2024 | 0   | 0   | 0   | 0   | 0   | 0   | 0   | 0   | 0   | 0   | 0   | 0   |
| 2025 | 0   | 0   | 0   | 0   | 0   | 0   | 0   | 0   | 0   | 0   | 0   | 0   |
| 2026 | 0   | 5   | 0   | 0   | 0   | 0   | 0   | 0   | 0   | 0   | 0   | 0   |
| 2027 | 0   | 11  | 2   | 0   | 0   | 0   | 0   | 0   | 0   | 0   | 0   | 0   |
| 2028 | 0   | 11  | 2   | 0   | 0   | 0   | 0   | 0   | 0   | 0   | 0   | 0   |
| 2029 | 0   | 11  | 2   | 0   | 0   | 0   | 0   | 0   | 0   | 0   | 0   | 0   |
| 2030 | 0   | 11  | 2   | 0   | 0   | 0   | 0   | 0   | 0   | 0   | 0   | 0   |
| 2031 | 0   | 13  | 2   | 0   | 0   | 0   | 0   | 0   | 0   | 0   | 0   | 0   |
| 2032 | 0   | 17  | 2   | 0   | 0   | 0   | 0   | 0   | 0   | 0   | 0   | 0   |
| 2033 | 0   | 17  | 2   | 0   | 0   | 0   | 0   | 0   | 0   | 0   | 0   | 0   |
| 2034 | 0   | 17  | 2   | 0   | 0   | 0   | 0   | 0   | 0   | 0   | 0   | 0   |
| 2035 | 0   | 17  | 2   | 0   | 0   | 0   | 0   | 0   | 0   | 0   | 0   | 0   |
| 2036 | 0   | 17  | 2   | 0   | 0   | 0   | 0   | 0   | 0   | 0   | 0   | 0   |
| 2037 | 0   | 17  | 2   | 0   | 0   | 0   | 0   | 0   | 0   | 0   | 0   | 0   |
| 2038 | 0   | 17  | 2   | 0   | 0   | 0   | 0   | 0   | 0   | 0   | 0   | 0   |
| 2039 | 0   | 17  | 2   | 0   | 0   | 0   | 0   | 0   | 0   | 0   | 0   | 0   |
| 2040 | 0   | 17  | 2   | 0   | 0   | 0   | 0   | 0   | 0   | 0   | 0   | 0   |
| 2041 | 0   | 17  | 2   | 0   | 0   | 0   | 0   | 0   | 0   | 0   | 0   | 0   |
| 2042 | 0   | 17  | 2   | 0   | 0   | 0   | 0   | 0   | 0   | 0   | 0   | 0   |
| 2043 | 0   | 17  | 2   | 0   | 0   | 0   | 0   | 0   | 0   | 0   | 0   | 0   |
| 2044 | 0   | 17  | 2   | 0   | 0   | 0   | 0   | 0   | 0   | 0   | 0   | 0   |
| 2045 | 0   | 17  | 2   | 0   | 0   | 0   | 0   | 0   | 0   | 0   | 0   | 0   |
| 2046 | 0   | 17  | 2   | 0   | 0   | 0   | 0   | 0   | 0   | 0   | 0   | 0   |
| 2047 | 0   | 17  | 2   | 0   | 0   | 0   | 0   | 0   | 0   | 0   | 0   | 0   |
| 2048 | 0   | 17  | 2   | 0   | 0   | 0   | 0   | 0   | 0   | 0   | 0   | 0   |
| 2049 | 0   | 17  | 2   | 0   | 0   | 0   | 0   | 0   | 0   | 0   | 0   | 0   |
| 2050 | 0   | 17  | 2   | 0   | 0   | 0   | 0   | 0   | 0   | 0   | 0   | 0   |
| 2051 | 0   | 17  | 2   | 0   | 0   | 0   | 0   | 0   | 0   | 0   | 0   | 0   |
| 2052 | 0   | 17  | 2   | 0   | 0   | 0   | 0   | 0   | 0   | 0   | 0   | 0   |
| 2053 | 0   | 17  | 2   | 0   | 0   | 0   | 0   | 0   | 0   | 0   | 0   | 0   |
| 2054 | 0   | 17  | 2   | 0   | 0   | 0   | 0   | 0   | 0   | 0   | 0   | 0   |
| 2055 | 0   | 17  | 2   | 0   | 0   | 0   | 0   | 0   | 0   | 0   | 0   | 0   |
| 2056 | 0   | 17  | 2   | 0   | 0   | 0   | 0   | 0   | 0   | 0   | 0   | 0   |
| 2057 | 0   | 17  | 2   | 0   | 0   | 0   | 0   | 0   | 0   | 0   | 0   | 0   |
| 2058 | 0   | 17  | 2   | 0   | 0   | 0   | 0   | 0   | 0   | 0   | 0   | 0   |
| 2059 | 0   | 17  | 2   | 0   | 0   | 0   | 0   | 0   | 0   | 0   | 0   | 0   |

|      | 133 | 134 | 135 | 136 | 137 | 138 | 139 | 140 | 141 | 142 | 143 | 144 |
|------|-----|-----|-----|-----|-----|-----|-----|-----|-----|-----|-----|-----|
| 2060 | 0   | 17  | 2   | 0   | 0   | 0   | 0   | 0   | 0   | 0   | 0   | 0   |
| 2061 | 0   | 17  | 2   | 0   | 0   | 0   | 0   | 0   | 0   | 0   | 0   | 0   |
| 2062 | 0   | 17  | 2   | 0   | 0   | 0   | 0   | 0   | 0   | 0   | 0   | 0   |
| 2063 | 0   | 17  | 2   | 0   | 0   | 0   | 0   | 0   | 0   | 0   | 0   | 0   |
| 2064 | 0   | 17  | 2   | 0   | 0   | 0   | 0   | 0   | 0   | 0   | 0   | 0   |
| 2065 | 0   | 17  | 2   | 0   | 0   | 0   | 0   | 0   | 0   | 0   | 0   | 0   |
| 2066 | 0   | 17  | 2   | 0   | 0   | 0   | 0   | 0   | 0   | 0   | 0   | 0   |
| 2067 | 0   | 17  | 2   | 0   | 0   | 0   | 0   | 0   | 0   | 0   | 0   | 0   |
| 2068 | 0   | 17  | 2   | 0   | 0   | 0   | 0   | 0   | 0   | 0   | 0   | 0   |
| 2069 | 0   | 17  | 2   | 0   | 0   | 0   | 0   | 0   | 0   | 0   | 0   | 0   |
| 2070 | 0   | 17  | 2   | 0   | 0   | 0   | 0   | 0   | 0   | 0   | 0   | 0   |
| 2071 | 0   | 17  | 2   | 0   | 0   | 0   | 0   | 0   | 0   | 0   | 0   | 0   |
| 2072 | 0   | 17  | 2   | 0   | 0   | 0   | 0   | 0   | 0   | 0   | 0   | 0   |
| 2073 | 0   | 17  | 2   | 0   | 0   | 0   | 0   | 0   | 0   | 0   | 0   | 0   |
| 2074 | 0   | 17  | 2   | 0   | 0   | 0   | 0   | 0   | 0   | 0   | 0   | 0   |
| 2075 | 0   | 17  | 2   | 0   | 0   | 0   | 0   | 0   | 0   | 0   | 0   | 0   |
| 2076 | 0   | 17  | 2   | 0   | 0   | 0   | 0   | 0   | 0   | 0   | 0   | 0   |
| 2077 | 0   | 17  | 2   | 0   | 0   | 0   | 0   | 0   | 0   | 0   | 0   | 0   |
| 2078 | 0   | 17  | 2   | 0   | 0   | 0   | 0   | 0   | 0   | 0   | 0   | 0   |
| 2079 | 0   | 17  | 2   | 0   | 0   | 0   | 0   | 0   | 0   | 0   | 0   | 0   |
| 2080 | 0   | 17  | 2   | 0   | 0   | 0   | 0   | 0   | 0   | 0   | 0   | 0   |
| 2081 | 0   | 17  | 2   | 0   | 0   | 0   | 0   | 0   | 0   | 0   | 0   | 0   |
| 2082 | 0   | 17  | 2   | 0   | 0   | 0   | 0   | 0   | 0   | 0   | 0   | 0   |
| 2083 | 0   | 17  | 2   | 0   | 0   | 0   | 0   | 0   | 0   | 0   | 0   | 0   |
| 2084 | 0   | 17  | 2   | 0   | 0   | 0   | 0   | 0   | 0   | 0   | 0   | 0   |
| 2085 | 0   | 17  | 2   | 0   | 0   | 0   | 0   | 0   | 0   | 0   | 0   | 0   |
| 2086 | 0   | 17  | 2   | 0   | 0   | 0   | 0   | 0   | 0   | 0   | 0   | 0   |
| 2087 | 0   | 17  | 2   | 0   | 0   | 0   | 0   | 0   | 0   | 0   | 0   | 0   |
| 2088 | 0   | 17  | 2   | 0   | 0   | 0   | 0   | 0   | 0   | 0   | 0   | 0   |
| 2089 | 0   | 17  | 2   | 0   | 0   | 0   | 0   | 0   | 0   | 0   | 0   | 0   |
| 2090 | 0   | 17  | 2   | 0   | 0   | 0   | 0   | 0   | 0   | 0   | 0   | 0   |

|      | 145 | 146 | 147 | 148 | 149 | 150 | 151 | 152 | 153 | 154 | 155 | 156 |
|------|-----|-----|-----|-----|-----|-----|-----|-----|-----|-----|-----|-----|
| 2002 | 0   | 0   | 0   | 0   | 0   | 0   | 0   | 0   | 0   | 0   | 0   | 0   |
| 2003 | 0   | 0   | 0   | 0   | 0   | 0   | 0   | 0   | 0   | 0   | 0   | 0   |
| 2004 | 0   | 0   | 0   | 0   | 0   | 0   | 0   | 0   | 0   | 0   | 0   | 0   |
| 2005 | 0   | 0   | 0   | 0   | 0   | 0   | 0   | 0   | 0   | 0   | 0   | 0   |
| 2006 | 0   | 0   | 0   | 0   | 0   | 0   | 0   | 0   | 0   | 0   | 0   | 0   |
| 2007 | 0   | 0   | 0   | 0   | 0   | 0   | 0   | 0   | 0   | 0   | 0   | 0   |
| 2008 | 0   | 0   | 0   | 0   | 0   | 0   | 0   | 0   | 0   | 0   | 0   | 0   |
| 2009 | 0   | 0   | 0   | 0   | 0   | 0   | 0   | 0   | 0   | 0   | 0   | 0   |
| 2010 | 0   | 0   | 0   | 0   | 0   | 0   | 0   | 0   | 0   | 0   | 0   | 0   |
| 2011 | 0   | 0   | 0   | 0   | 0   | 0   | 0   | 0   | 0   | 0   | 0   | 0   |
| 2012 | 0   | 0   | 0   | 0   | 0   | 0   | 0   | 0   | 0   | 0   | 0   | 0   |
| 2013 | 0   | 0   | 0   | 0   | 0   | 0   | 0   | 0   | 0   | 0   | 0   | 0   |
| 2014 | 0   | 0   | 0   | 0   | 0   | 0   | 0   | 0   | 0   | 0   | 0   | 0   |
| 2015 | 0   | 0   | 0   | 0   | 0   | 0   | 0   | 0   | 0   | 0   | 0   | 0   |
| 2016 | 0   | 0   | 0   | 0   | 0   | 0   | 0   | 0   | 0   | 0   | 0   | 0   |
| 2017 | 0   | 0   | 0   | 0   | 0   | 0   | 0   | 0   | 0   | 0   | 0   | 0   |
| 2018 | 0   | 0   | 0   | 0   | 0   | 0   | 0   | 0   | 0   | 0   | 0   | 0   |
| 2019 | 0   | 0   | 0   | 0   | 0   | 0   | 0   | 0   | 0   | 0   | 0   | 0   |
| 2020 | 0   | 0   | 0   | 0   | 0   | 0   | 0   | 0   | 0   | 0   | 0   | 0   |
| 2021 | 0   | 0   | 0   | 4   | 0   | 0   | 0   | 0   | 0   | 0   | 0   | 0   |
| 2022 | 0   | 0   | 0   | 4   | 0   | 0   | 0   | 0   | 0   | 0   | 0   | 0   |
| 2023 | 0   | 0   | 0   | 4   | 0   | 0   | 0   | 0   | 0   | 0   | 0   | 0   |
| 2024 | 0   | 0   | 0   | 4   | 0   | 0   | 0   | 0   | 0   | 0   | 0   | 0   |
| 2025 | 0   | 0   | 0   | 4   | 0   | 0   | 0   | 0   | 0   | 0   | 0   | 0   |
| 2026 | 0   | 0   | 0   | 4   | 0   | 0   | 0   | 29  | 0   | 9   | 0   | 0   |
| 2027 | 0   | 0   | 0   | 4   | 0   | 0   | 0   | 40  | 0   | 18  | 0   | 0   |
| 2028 | 0   | 0   | 0   | 4   | 0   | 0   | 0   | 44  | 0   | 18  | 0   | 0   |
| 2029 | 0   | 0   | 0   | 4   | 0   | 0   | 0   | 44  | 0   | 18  | 0   | 0   |
| 2030 | 0   | 0   | 0   | 4   | 0   | 0   | 0   | 44  | 0   | 18  | 0   | 0   |
| 2031 | 0   | 0   | 0   | 4   | 0   | 0   | 0   | 44  | 0   | 18  | 0   | 0   |
| 2032 | 0   | 0   | 0   | 4   | 0   | 0   | 0   | 44  | 0   | 18  | 0   | 0   |
| 2033 | 0   | 0   | 0   | 4   | 0   | 0   | 0   | 44  | 0   | 18  | 0   | 0   |
| 2034 | 0   | 0   | 0   | 4   | 0   | 0   | 0   | 44  | 0   | 18  | 0   | 0   |
| 2035 | 0   | 0   | 0   | 4   | 0   | 0   | 0   | 44  | 0   | 18  | 0   | 0   |
| 2036 | 0   | 0   | 0   | 4   | 0   | 0   | 0   | 44  | 0   | 18  | 0   | 0   |
| 2037 | 0   | 0   | 0   | 4   | 0   | 0   | 0   | 44  | 0   | 18  | 0   | 0   |
| 2038 | 0   | 0   | 0   | 4   | 0   | 0   | 0   | 44  | 0   | 18  | 0   | 0   |
| 2039 | 0   | 0   | 0   | 4   | 0   | 0   | 0   | 44  | 0   | 18  | 0   | 0   |
| 2040 | 0   | 0   | 0   | 4   | 0   | 0   | 0   | 44  | 0   | 18  | 0   | 0   |
| 2041 | 0   | 0   | 0   | 4   | 0   | 0   | 0   | 44  | 0   | 18  | 0   | 0   |
| 2042 | 0   | 0   | 0   | 4   | 0   | 0   | 0   | 44  | 0   | 18  | 0   | 0   |
| 2043 | 0   | 0   | 0   | 4   | 0   | 0   | 0   | 44  | 0   | 18  | 0   | 0   |
| 2044 | 0   | 0   | 0   | 4   | 0   | 0   | 0   | 44  | 0   | 18  | 0   | 0   |
| 2045 | 0   | 0   | 0   | 4   | 0   | 0   | 0   | 44  | 0   | 18  | 0   | 0   |
| 2046 | 0   | 0   | 0   | 4   | 0   | 0   | 0   | 44  | 0   | 18  | 0   | 0   |
| 2047 | 0   | 0   | 0   | 4   | 0   | 0   | 0   | 44  | 0   | 18  | 0   | 0   |
| 2048 | 0   | 0   | 0   | 4   | 0   | 0   | 0   | 44  | 0   | 18  | 0   | 0   |
| 2049 | 0   | 0   | 0   | 4   | 0   | 0   | 0   | 44  | 0   | 18  | 0   | 0   |
| 2050 | 0   | 0   | 0   | 4   | 0   | 0   | 0   | 44  | 0   | 18  | 0   | 0   |
| 2051 | 0   | 0   | 0   | 4   | 0   | 0   | 0   | 44  | 0   | 18  | 0   | 0   |
| 2052 | 0   | 0   | 0   | 4   | 0   | 0   | 0   | 44  | 0   | 18  | 0   | 0   |
| 2053 | 0   | 0   | 0   | 4   | 0   | 0   | 0   | 44  | 0   | 18  | 0   | 0   |
| 2054 | 0   | 0   | 0   | 4   | 0   | 0   | 0   | 44  | 0   | 18  | 0   | 0   |
| 2055 | 0   | 0   | 0   | 4   | 0   | 0   | 0   | 44  | 0   | 18  | 0   | 0   |
| 2056 | 0   | 0   | 0   | 4   | 0   | 0   | 0   | 44  | 0   | 18  | 0   | 0   |
| 2057 | 0   | 0   | 0   | 4   | 0   | 0   | 0   | 44  | 0   | 18  | 0   | 0   |
| 2058 | 0   | 0   | 0   | 4   | 0   | 0   | 0   | 44  | 0   | 18  | 0   | 0   |
| 2059 | 0   | 0   | 0   | 4   | 0   | 0   | 0   | 44  | 0   | 18  | 0   | 0   |

|      | 145 | 146 | 147 | 148 | 149 | 150 | 151 | 152 | 153 | 154 | 155 | 156 |
|------|-----|-----|-----|-----|-----|-----|-----|-----|-----|-----|-----|-----|
| 2060 | 0   | 0   | 0   | 4   | 0   | 0   | 0   | 44  | 0   | 18  | 0   | 0   |
| 2061 | 0   | 0   | 0   | 4   | 0   | 0   | 0   | 44  | 0   | 18  | 0   | 0   |
| 2062 | 0   | 0   | 0   | 4   | 0   | 0   | 0   | 44  | 0   | 18  | 0   | 0   |
| 2063 | 0   | 0   | 0   | 4   | 0   | 0   | 0   | 44  | 0   | 18  | 0   | 0   |
| 2064 | 0   | 0   | 0   | 4   | 0   | 0   | 0   | 44  | 0   | 18  | 0   | 0   |
| 2065 | 0   | 0   | 0   | 4   | 0   | 0   | 0   | 44  | 0   | 18  | 0   | 0   |
| 2066 | 0   | 0   | 0   | 4   | 0   | 0   | 0   | 44  | 0   | 18  | 0   | 0   |
| 2067 | 0   | 0   | 0   | 4   | 0   | 0   | 0   | 44  | 0   | 18  | 0   | 0   |
| 2068 | 0   | 0   | 0   | 4   | 0   | 0   | 0   | 44  | 0   | 18  | 0   | 0   |
| 2069 | 0   | 0   | 0   | 4   | 0   | 0   | 0   | 44  | 0   | 18  | 0   | 0   |
| 2070 | 0   | 0   | 0   | 4   | 0   | 0   | 0   | 44  | 0   | 18  | 0   | 0   |
| 2071 | 0   | 0   | 0   | 4   | 0   | 0   | 0   | 44  | 0   | 18  | 0   | 0   |
| 2072 | 0   | 0   | 0   | 4   | 0   | 0   | 0   | 44  | 0   | 18  | 0   | 0   |
| 2073 | 0   | 0   | 0   | 4   | 0   | 0   | 0   | 44  | 0   | 18  | 0   | 0   |
| 2074 | 0   | 0   | 0   | 4   | 0   | 0   | 0   | 44  | 0   | 18  | 0   | 0   |
| 2075 | 0   | 0   | 0   | 4   | 0   | 0   | 0   | 44  | 0   | 18  | 0   | 0   |
| 2076 | 0   | 0   | 0   | 4   | 0   | 0   | 0   | 44  | 0   | 18  | 0   | 0   |
| 2077 | 0   | 0   | 0   | 4   | 0   | 0   | 0   | 44  | 0   | 18  | 0   | 0   |
| 2078 | 0   | 0   | 0   | 4   | 0   | 0   | 0   | 44  | 0   | 18  | 0   | 0   |
| 2079 | 0   | 0   | 0   | 4   | 0   | 0   | 0   | 44  | 0   | 18  | 0   | 0   |
| 2080 | 0   | 0   | 0   | 4   | 0   | 0   | 0   | 44  | 0   | 18  | 0   | 0   |
| 2081 | 0   | 0   | 0   | 4   | 0   | 0   | 0   | 44  | 0   | 18  | 0   | 0   |
| 2082 | 0   | 0   | 0   | 4   | 0   | 0   | 0   | 44  | 0   | 18  | 0   | 0   |
| 2083 | 0   | 0   | 0   | 4   | 0   | 0   | 0   | 44  | 0   | 18  | 0   | 0   |
| 2084 | 0   | 0   | 0   | 4   | 0   | 0   | 0   | 44  | 0   | 18  | 0   | 0   |
| 2085 | 0   | 0   | 0   | 4   | 0   | 0   | 0   | 44  | 0   | 18  | 0   | 0   |
| 2086 | 0   | 0   | 0   | 4   | 0   | 0   | 0   | 44  | 0   | 18  | 0   | 0   |
| 2087 | 0   | 0   | 0   | 4   | 0   | 0   | 0   | 44  | 0   | 18  | 0   | 0   |
| 2088 | 0   | 0   | 0   | 4   | 0   | 0   | 0   | 44  | 0   | 18  | 0   | 0   |
| 2089 | 0   | 0   | 0   | 4   | 0   | 0   | 0   | 44  | 0   | 18  | 0   | 0   |
| 2090 | 0   | 0   | 0   | 4   | 0   | 0   | 0   | 44  | 0   | 18  | 0   | 0   |

|      | 157 | 158 | 159 | 160 | 161 | 162 |
|------|-----|-----|-----|-----|-----|-----|
| 2002 | 0   | 0   | 0   | 0   | 0   | 0   |
| 2003 | 0   | 0   | 0   | 0   | 0   | 0   |
| 2004 | 0   | 0   | 0   | 0   | 0   | 0   |
| 2005 | 0   | 0   | 0   | 0   | 0   | 0   |
| 2006 | 0   | 0   | 0   | 0   | 0   | 0   |
| 2007 | 0   | 0   | 0   | 0   | 0   | 0   |
| 2008 | 0   | 0   | 0   | 0   | 0   | 0   |
| 2009 | 0   | 0   | 0   | 0   | 0   | 0   |
| 2010 | 0   | 0   | 0   | 0   | 0   | 0   |
| 2011 | 0   | 0   | 0   | 0   | 0   | 0   |
| 2012 | 0   | 0   | 0   | 0   | 0   | 0   |
| 2013 | 0   | 0   | 0   | 0   | 0   | 0   |
| 2014 | 0   | 0   | 0   | 0   | 0   | 0   |
| 2015 | 0   | 0   | 0   | 0   | 0   | 0   |
| 2016 | 0   | 0   | 0   | 0   | 0   | 0   |
| 2017 | 0   | 0   | 0   | 0   | 0   | 0   |
| 2018 | 0   | 0   | 0   | 0   | 0   | 0   |
| 2019 | 0   | 0   | 0   | 0   | 0   | 0   |
| 2020 | 0   | 0   | 0   | 0   | 0   | 0   |
| 2021 | 21  | 0   | 0   | 0   | 0   | 0   |
| 2022 | 21  | 0   | 0   | 0   | 0   | 0   |
| 2023 | 22  | 0   | 0   | 0   | 0   | 0   |
| 2024 | 22  | 0   | 0   | 0   | 0   | 0   |
| 2025 | 22  | 0   | 0   | 0   | 0   | 0   |
| 2026 | 22  | 3   | 1   | 0   | 57  | 3   |
| 2027 | 22  | 5   | 2   | 0   | 94  | 3   |
| 2028 | 22  | 5   | 2   | 0   | 119 | 3   |
| 2029 | 22  | 5   | 2   | 0   | 121 | 3   |
| 2030 | 22  | 5   | 2   | 0   | 125 | 3   |
| 2031 | 22  | 5   | 2   | 0   | 125 | 3   |
| 2032 | 22  | 5   | 2   | 0   | 125 | 3   |
| 2033 | 22  | 5   | 2   | 0   | 125 | 3   |
| 2034 | 22  | 5   | 2   | 0   | 125 | 3   |
| 2035 | 22  | 5   | 2   | 0   | 125 | 3   |
| 2036 | 22  | 5   | 2   | 0   | 125 | 3   |
| 2037 | 22  | 5   | 2   | 0   | 125 | 3   |
| 2038 | 22  | 5   | 2   | 0   | 125 | 3   |
| 2039 | 22  | 5   | 2   | 0   | 125 | 3   |
| 2040 | 22  | 5   | 2   | 0   | 125 | 3   |
| 2041 | 22  | 5   | 2   | 0   | 125 | 3   |
| 2042 | 22  | 5   | 2   | 0   | 125 | 3   |
| 2043 | 22  | 5   | 2   | 0   | 125 | 3   |
| 2044 | 22  | 5   | 2   | 0   | 125 | 3   |
| 2045 | 22  | 5   | 2   | 0   | 125 | 3   |
| 2046 | 22  | 5   | 2   | 0   | 125 | 3   |
| 2047 | 22  | 5   | 2   | 0   | 125 | 3   |
| 2048 | 22  | 5   | 2   | 0   | 125 | 3   |
| 2049 | 22  | 5   | 2   | 0   | 125 | 3   |
| 2050 | 22  | 5   | 2   | 0   | 125 | 3   |
| 2051 | 22  | 5   | 2   | 0   | 125 | 3   |
| 2052 | 22  | 5   | 2   | 0   | 125 | 3   |
| 2053 | 22  | 5   | 2   | 0   | 125 | 3   |
| 2054 | 22  | 5   | 2   | 0   | 125 | 3   |
| 2055 | 22  | 5   | 2   | 0   | 125 | 3   |
| 2056 | 22  | 5   | 2   | 0   | 125 | 3   |
| 2057 | 22  | 5   | 2   | 0   | 125 | 3   |
| 2058 | 22  | 5   | 2   | 0   | 125 | 3   |
| 2059 | 22  | 5   | 2   | 0   | 125 | 3   |

|      | 157 | 158 | 159 | 160 | 161 | 162 |
|------|-----|-----|-----|-----|-----|-----|
| 2060 | 22  | 5   | 2   | 0   | 125 | 3   |
| 2061 | 22  | 5   | 2   | 0   | 125 | 3   |
| 2062 | 22  | 5   | 2   | 0   | 125 | 3   |
| 2063 | 22  | 5   | 2   | 0   | 125 | 3   |
| 2064 | 22  | 5   | 2   | 0   | 125 | 3   |
| 2065 | 22  | 5   | 2   | 0   | 125 | 3   |
| 2066 | 22  | 5   | 2   | 0   | 125 | 3   |
| 2067 | 22  | 5   | 2   | 0   | 125 | 3   |
| 2068 | 22  | 5   | 2   | 0   | 125 | 3   |
| 2069 | 22  | 5   | 2   | 0   | 125 | 3   |
| 2070 | 22  | 5   | 2   | 0   | 125 | 3   |
| 2071 | 22  | 5   | 2   | 0   | 125 | 3   |
| 2072 | 22  | 5   | 2   | 0   | 125 | 3   |
| 2073 | 22  | 5   | 2   | 0   | 125 | 3   |
| 2074 | 22  | 5   | 2   | 0   | 125 | 3   |
| 2075 | 22  | 5   | 2   | 0   | 125 | 3   |
| 2076 | 22  | 5   | 2   | 0   | 125 | 3   |
| 2077 | 22  | 5   | 2   | 0   | 125 | 3   |
| 2078 | 22  | 5   | 2   | 0   | 125 | 3   |
| 2079 | 22  | 5   | 2   | 0   | 125 | 3   |
| 2080 | 22  | 5   | 2   | 0   | 125 | 3   |
| 2081 | 22  | 5   | 2   | 0   | 125 | 3   |
| 2082 | 22  | 5   | 2   | 0   | 125 | 3   |
| 2083 | 22  | 5   | 2   | 0   | 125 | 3   |
| 2084 | 22  | 5   | 2   | 0   | 125 | 3   |
| 2085 | 22  | 5   | 2   | 0   | 125 | 3   |
| 2086 | 22  | 5   | 2   | 0   | 125 | 3   |
| 2087 | 22  | 5   | 2   | 0   | 125 | 3   |
| 2088 | 22  | 5   | 2   | 0   | 125 | 3   |
| 2089 | 22  | 5   | 2   | 0   | 125 | 3   |
| 2090 | 22  | 5   | 2   | 0   | 125 | 3   |



|      | 1   | 2   | 3  | 4   | 5   | 6   | 7 | 8   | 9   | 10   | 11   | 12   |
|------|-----|-----|----|-----|-----|-----|---|-----|-----|------|------|------|
| 2002 | 0   | 0   | 0  | 0   | 0   | 0   | 0 | 0   | 0   | 0    | 0    | 0    |
| 2003 | 0   | 0   | 0  | 0   | 0   | 0   | 0 | 0   | 0   | 0    | 0    | 0    |
| 2004 | 0   | 0   | 0  | 0   | 0   | 0   | 0 | 0   | 0   | 0    | 0    | 0    |
| 2005 | 0   | 0   | 0  | 0   | 0   | 0   | 0 | 0   | 0   | 0    | 0    | 0    |
| 2006 | 0   | 0   | 0  | 0   | 0   | 0   | 0 | 0   | 0   | 0    | 0    | 0    |
| 2007 | 0   | 0   | 0  | 0   | 0   | 0   | 0 | 0   | 0   | 0    | 0    | 0    |
| 2008 | 0   | 0   | 0  | 0   | 0   | 0   | 0 | 0   | 0   | 0    | 0    | 0    |
| 2009 | 0   | 0   | 0  | 0   | 0   | 0   | 0 | 0   | 0   | 0    | 0    | 0    |
| 2010 | 0   | 0   | 0  | 0   | 0   | 0   | 0 | 0   | 0   | 0    | 0    | 0    |
| 2011 | 0   | 0   | 0  | 0   | 0   | 0   | 0 | 0   | 0   | 0    | 0    | 0    |
| 2012 | 0   | 0   | 0  | 0   | 0   | 0   | 0 | 0   | 0   | 0    | 0    | 0    |
| 2013 | 0   | 0   | 0  | 0   | 0   | 0   | 0 | 0   | 0   | 0    | 0    | 0    |
| 2014 | 0   | 0   | 0  | 0   | 0   | 0   | 0 | 0   | 0   | 0    | 0    | 0    |
| 2015 | 0   | 0   | 0  | 0   | 0   | 0   | 0 | 0   | 0   | 0    | 0    | 0    |
| 2016 | 0   | 0   | 0  | 0   | 0   | 0   | 0 | 0   | 0   | 0    | 0    | 0    |
| 2017 | 0   | 0   | 0  | 0   | 0   | 0   | 0 | 0   | 0   | 0    | 0    | 0    |
| 2018 | 0   | 0   | 0  | 0   | 0   | 0   | 0 | 0   | 0   | 0    | 0    | 0    |
| 2019 | 0   | 0   | 0  | 0   | 0   | 0   | 0 | 0   | 0   | 0    | 0    | 0    |
| 2020 | 0   | 0   | 0  | 0   | 0   | 0   | 0 | 0   | 0   | 0    | 0    | 0    |
| 2021 | 0   | 0   | 0  | 0   | 0   | 0   | 0 | 0   | 0   | 0    | 0    | 0    |
| 2022 | 0   | 0   | 0  | 0   | 0   | 0   | 0 | 0   | 0   | 0    | 0    | 0    |
| 2023 | 0   | 0   | 0  | 0   | 0   | 0   | 0 | 0   | 0   | 0    | 0    | 0    |
| 2024 | 0   | 0   | 0  | 0   | 0   | 0   | 0 | 0   | 0   | 0    | 0    | 0    |
| 2025 | 0   | 0   | 0  | 0   | 0   | 0   | 0 | 0   | 0   | 179  | 179  | 0    |
| 2026 | 0   | 0   | 0  | 0   | 0   | 0   | 0 | 0   | 0   | 340  | 333  | 0    |
| 2027 | 0   | 0   | 0  | 0   | 0   | 0   | 0 | 0   | 0   | 508  | 504  | 0    |
| 2028 | 0   | 0   | 0  | 0   | 0   | 0   | 0 | 0   | 0   | 643  | 634  | 0    |
| 2029 | 0   | 0   | 0  | 0   | 0   | 0   | 0 | 0   | 0   | 778  | 769  | 0    |
| 2030 | 0   | 0   | 0  | 0   | 0   | 0   | 0 | 0   | 0   | 898  | 888  | 184  |
| 2031 | 0   | 0   | 0  | 0   | 0   | 0   | 0 | 0   | 0   | 972  | 962  | 333  |
| 2032 | 0   | 0   | 0  | 1   | 0   | 0   | 0 | 7   | 0   | 1046 | 1037 | 472  |
| 2033 | 0   | 0   | 0  | 8   | 0   | 0   | 0 | 12  | 0   | 1111 | 1108 | 597  |
| 2034 | 0   | 0   | 0  | 28  | 0   | 0   | 0 | 51  | 0   | 1215 | 1213 | 716  |
| 2035 | 0   | 0   | 0  | 33  | 0   | 0   | 0 | 113 | 0   | 1308 | 1301 | 811  |
| 2036 | 0   | 1   | 0  | 80  | 2   | 0   | 0 | 218 | 1   | 1371 | 1363 | 915  |
| 2037 | 2   | 3   | 0  | 114 | 4   | 1   | 0 | 294 | 3   | 1445 | 1438 | 1012 |
| 2038 | 5   | 8   | 0  | 172 | 12  | 3   | 0 | 411 | 8   | 1508 | 1499 | 1101 |
| 2039 | 13  | 24  | 0  | 240 | 29  | 12  | 0 | 514 | 24  | 1595 | 1585 | 1185 |
| 2040 | 22  | 37  | 0  | 280 | 56  | 31  | 0 | 606 | 37  | 1658 | 1650 | 1299 |
| 2041 | 59  | 77  | 0  | 320 | 83  | 77  | 0 | 728 | 77  | 1739 | 1726 | 1406 |
| 2042 | 95  | 108 | 1  | 320 | 140 | 129 | 0 | 847 | 108 | 1787 | 1777 | 1444 |
| 2043 | 101 | 110 | 5  | 320 | 140 | 139 | 0 | 869 | 110 | 1841 | 1822 | 1498 |
| 2044 | 101 | 110 | 35 | 320 | 140 | 139 | 0 | 869 | 110 | 1881 | 1867 | 1555 |
| 2045 | 101 | 110 | 36 | 320 | 140 | 139 | 0 | 869 | 110 | 1934 | 1919 | 1593 |
| 2046 | 101 | 110 | 36 | 320 | 140 | 139 | 0 | 869 | 110 | 1988 | 1970 | 1647 |
| 2047 | 101 | 110 | 36 | 320 | 140 | 139 | 0 | 869 | 110 | 2065 | 2049 | 1726 |
| 2048 | 101 | 110 | 36 | 320 | 140 | 139 | 0 | 869 | 110 | 2137 | 2121 | 1726 |
| 2049 | 101 | 110 | 36 | 320 | 140 | 139 | 0 | 869 | 110 | 2137 | 2121 | 1726 |
| 2050 | 101 | 110 | 36 | 320 | 140 | 139 | 0 | 869 | 110 | 2137 | 2121 | 1726 |
| 2051 | 101 | 110 | 36 | 320 | 140 | 139 | 0 | 869 | 110 | 2137 | 2121 | 1726 |
| 2052 | 101 | 110 | 36 | 320 | 140 | 139 | 0 | 869 | 110 | 2137 | 2121 | 1726 |
| 2053 | 101 | 110 | 36 | 320 | 140 | 139 | 0 | 869 | 110 | 2137 | 2121 | 1726 |
| 2054 | 101 | 110 | 36 | 320 | 140 | 139 | 0 | 869 | 110 | 2137 | 2121 | 1726 |
| 2055 | 101 | 110 | 36 | 320 | 140 | 139 | 0 | 869 | 110 | 2137 | 2121 | 1726 |
| 2056 | 101 | 110 | 36 | 320 | 140 | 139 | 0 | 869 | 110 | 2137 | 2121 | 1726 |
| 2057 | 101 | 110 | 36 | 320 | 140 | 139 | 0 | 869 | 110 | 2137 | 2121 | 1726 |
| 2058 | 101 | 110 | 36 | 320 | 140 | 139 | 0 | 869 | 110 | 2137 | 2121 | 1726 |
| 2059 | 101 | 110 | 36 | 320 | 140 | 139 | 0 | 869 | 110 | 2137 | 2121 | 1726 |

|      | 1   | 2   | 3  | 4   | 5   | 6   | 7 | 8   | 9   | 10   | 11   | 12   |
|------|-----|-----|----|-----|-----|-----|---|-----|-----|------|------|------|
| 2060 | 101 | 110 | 36 | 320 | 140 | 139 | 0 | 869 | 110 | 2137 | 2121 | 1726 |
| 2061 | 101 | 110 | 36 | 320 | 140 | 139 | 0 | 869 | 110 | 2137 | 2121 | 1726 |
| 2062 | 101 | 110 | 36 | 320 | 140 | 139 | 0 | 869 | 110 | 2137 | 2121 | 1726 |
| 2063 | 101 | 110 | 36 | 320 | 140 | 139 | 0 | 869 | 110 | 2137 | 2121 | 1726 |
| 2064 | 101 | 110 | 36 | 320 | 140 | 139 | 0 | 869 | 110 | 2137 | 2121 | 1726 |
| 2065 | 101 | 110 | 36 | 320 | 140 | 139 | 0 | 869 | 110 | 2137 | 2121 | 1726 |
| 2066 | 101 | 110 | 36 | 320 | 140 | 139 | 0 | 869 | 110 | 2137 | 2121 | 1726 |
| 2067 | 101 | 110 | 36 | 320 | 140 | 139 | 0 | 869 | 110 | 2137 | 2121 | 1726 |
| 2068 | 101 | 110 | 36 | 320 | 140 | 139 | 0 | 869 | 110 | 2137 | 2121 | 1726 |
| 2069 | 101 | 110 | 36 | 320 | 140 | 139 | 0 | 869 | 110 | 2137 | 2121 | 1726 |
| 2070 | 101 | 110 | 36 | 320 | 140 | 139 | 0 | 869 | 110 | 2137 | 2121 | 1726 |
| 2071 | 101 | 110 | 36 | 320 | 140 | 139 | 0 | 869 | 110 | 2137 | 2121 | 1726 |
| 2072 | 101 | 110 | 36 | 320 | 140 | 139 | 0 | 869 | 110 | 2137 | 2121 | 1726 |
| 2073 | 101 | 110 | 36 | 320 | 140 | 139 | 0 | 869 | 110 | 2137 | 2121 | 1726 |
| 2074 | 101 | 110 | 36 | 320 | 140 | 139 | 0 | 869 | 110 | 2137 | 2121 | 1726 |
| 2075 | 101 | 110 | 36 | 320 | 140 | 139 | 0 | 869 | 110 | 2137 | 2121 | 1726 |
| 2076 | 101 | 110 | 36 | 320 | 140 | 139 | 0 | 869 | 110 | 2137 | 2121 | 1726 |
| 2077 | 101 | 110 | 36 | 320 | 140 | 139 | 0 | 869 | 110 | 2137 | 2121 | 1726 |
| 2078 | 101 | 110 | 36 | 320 | 140 | 139 | 0 | 869 | 110 | 2137 | 2121 | 1726 |
| 2079 | 101 | 110 | 36 | 320 | 140 | 139 | 0 | 869 | 110 | 2137 | 2121 | 1726 |
| 2080 | 101 | 110 | 36 | 320 | 140 | 139 | 0 | 869 | 110 | 2137 | 2121 | 1726 |
| 2081 | 101 | 110 | 36 | 320 | 140 | 139 | 0 | 869 | 110 | 2137 | 2121 | 1726 |
| 2082 | 101 | 110 | 36 | 320 | 140 | 139 | 0 | 869 | 110 | 2137 | 2121 | 1726 |
| 2083 | 101 | 110 | 36 | 320 | 140 | 139 | 0 | 869 | 110 | 2137 | 2121 | 1726 |
| 2084 | 101 | 110 | 36 | 320 | 140 | 139 | 0 | 869 | 110 | 2137 | 2121 | 1726 |
| 2085 | 101 | 110 | 36 | 320 | 140 | 139 | 0 | 869 | 110 | 2137 | 2121 | 1726 |
| 2086 | 101 | 110 | 36 | 320 | 140 | 139 | 0 | 869 | 110 | 2137 | 2121 | 1726 |
| 2087 | 101 | 110 | 36 | 320 | 140 | 139 | 0 | 869 | 110 | 2137 | 2121 | 1726 |
| 2088 | 101 | 110 | 36 | 320 | 140 | 139 | 0 | 869 | 110 | 2137 | 2121 | 1726 |
| 2089 | 101 | 110 | 36 | 320 | 140 | 139 | 0 | 869 | 110 | 2137 | 2121 | 1726 |
| 2090 | 101 | 110 | 36 | 320 | 140 | 139 | 0 | 869 | 110 | 2137 | 2121 | 1726 |

|      | 13   | 14   | 15   | 16  | 17   | 18   | 19   | 20   | 21   | 22   | 23   | 24   |
|------|------|------|------|-----|------|------|------|------|------|------|------|------|
| 2002 | 0    | 0    | 0    | 0   | 0    | 0    | 0    | 0    | 0    | 0    | 0    | 0    |
| 2003 | 0    | 0    | 0    | 0   | 0    | 0    | 0    | 0    | 0    | 0    | 0    | 0    |
| 2004 | 0    | 0    | 0    | 0   | 0    | 0    | 0    | 0    | 0    | 0    | 0    | 0    |
| 2005 | 0    | 0    | 0    | 0   | 0    | 0    | 0    | 0    | 0    | 0    | 0    | 0    |
| 2006 | 0    | 0    | 0    | 0   | 0    | 0    | 0    | 0    | 0    | 0    | 0    | 0    |
| 2007 | 0    | 0    | 0    | 0   | 0    | 0    | 0    | 0    | 0    | 0    | 0    | 0    |
| 2008 | 0    | 0    | 0    | 0   | 0    | 0    | 0    | 0    | 0    | 0    | 0    | 0    |
| 2009 | 0    | 0    | 0    | 0   | 0    | 0    | 0    | 0    | 0    | 0    | 0    | 0    |
| 2010 | 0    | 0    | 0    | 0   | 0    | 0    | 0    | 0    | 0    | 0    | 0    | 0    |
| 2011 | 0    | 0    | 0    | 0   | 0    | 0    | 0    | 0    | 0    | 0    | 0    | 0    |
| 2012 | 0    | 0    | 0    | 0   | 0    | 0    | 0    | 0    | 0    | 0    | 0    | 0    |
| 2013 | 0    | 0    | 0    | 0   | 0    | 0    | 0    | 0    | 0    | 0    | 0    | 0    |
| 2014 | 0    | 0    | 0    | 0   | 0    | 0    | 0    | 0    | 0    | 0    | 0    | 0    |
| 2015 | 0    | 0    | 0    | 0   | 0    | 0    | 0    | 0    | 0    | 0    | 0    | 0    |
| 2016 | 0    | 0    | 0    | 0   | 0    | 0    | 0    | 0    | 0    | 0    | 0    | 0    |
| 2017 | 0    | 0    | 0    | 0   | 0    | 0    | 0    | 0    | 0    | 0    | 0    | 0    |
| 2018 | 0    | 0    | 0    | 0   | 0    | 0    | 0    | 0    | 0    | 0    | 0    | 0    |
| 2019 | 0    | 0    | 0    | 0   | 0    | 0    | 0    | 0    | 0    | 0    | 0    | 0    |
| 2020 | 160  | 0    | 0    | 0   | 0    | 0    | 0    | 0    | 0    | 240  | 0    | 0    |
| 2021 | 324  | 0    | 0    | 0   | 0    | 0    | 0    | 0    | 0    | 479  | 0    | 0    |
| 2022 | 463  | 0    | 0    | 0   | 0    | 0    | 0    | 0    | 0    | 702  | 0    | 0    |
| 2023 | 602  | 0    | 0    | 0   | 0    | 0    | 0    | 0    | 0    | 910  | 0    | 0    |
| 2024 | 718  | 0    | 0    | 0   | 0    | 0    | 0    | 0    | 0    | 1135 | 0    | 0    |
| 2025 | 834  | 186  | 74   | 6   | 246  | 179  | 233  | 233  | 0    | 1327 | 238  | 187  |
| 2026 | 931  | 349  | 160  | 12  | 473  | 335  | 448  | 446  | 0    | 1522 | 475  | 326  |
| 2027 | 1021 | 507  | 249  | 17  | 723  | 508  | 675  | 674  | 0    | 1719 | 723  | 501  |
| 2028 | 1107 | 621  | 337  | 26  | 946  | 640  | 885  | 875  | 0    | 1928 | 951  | 624  |
| 2029 | 1176 | 743  | 437  | 28  | 1150 | 773  | 1056 | 1051 | 0    | 2118 | 1159 | 732  |
| 2030 | 1237 | 837  | 522  | 31  | 1376 | 887  | 1246 | 1229 | 240  | 2294 | 1367 | 874  |
| 2031 | 1320 | 938  | 611  | 43  | 1582 | 968  | 1430 | 1405 | 454  | 2480 | 1573 | 993  |
| 2032 | 1365 | 1014 | 679  | 49  | 1769 | 1041 | 1609 | 1585 | 652  | 2631 | 1761 | 1104 |
| 2033 | 1449 | 1091 | 769  | 51  | 1932 | 1107 | 1778 | 1757 | 855  | 2778 | 1958 | 1253 |
| 2034 | 1522 | 1183 | 882  | 77  | 2136 | 1223 | 1947 | 1925 | 1033 | 2927 | 2143 | 1390 |
| 2035 | 1601 | 1254 | 1007 | 98  | 2345 | 1314 | 2130 | 2109 | 1214 | 3059 | 2341 | 1529 |
| 2036 | 1670 | 1322 | 1101 | 118 | 2498 | 1384 | 2275 | 2246 | 1394 | 3204 | 2502 | 1648 |
| 2037 | 1757 | 1405 | 1169 | 146 | 2647 | 1458 | 2421 | 2386 | 1549 | 3353 | 2663 | 1751 |
| 2038 | 1806 | 1512 | 1236 | 163 | 2795 | 1514 | 2546 | 2512 | 1725 | 3488 | 2822 | 1866 |
| 2039 | 1871 | 1599 | 1290 | 192 | 2959 | 1592 | 2675 | 2646 | 1877 | 3651 | 2987 | 1987 |
| 2040 | 1959 | 1700 | 1377 | 211 | 3152 | 1655 | 2837 | 2801 | 2023 | 3806 | 3190 | 2091 |
| 2041 | 2032 | 1774 | 1462 | 242 | 3324 | 1738 | 3002 | 2972 | 2186 | 3946 | 3384 | 2199 |
| 2042 | 2100 | 1844 | 1493 | 257 | 3458 | 1786 | 3185 | 3158 | 2337 | 4073 | 3593 | 2260 |
| 2043 | 2173 | 1926 | 1554 | 278 | 3579 | 1835 | 3320 | 3285 | 2484 | 4247 | 3753 | 2372 |
| 2044 | 2256 | 1989 | 1634 | 297 | 3682 | 1872 | 3451 | 3422 | 2624 | 4335 | 3926 | 2452 |
| 2045 | 2352 | 2047 | 1702 | 334 | 3780 | 1935 | 3576 | 3542 | 2758 | 4335 | 4104 | 2549 |
| 2046 | 2423 | 2108 | 1785 | 378 | 3896 | 1997 | 3656 | 3634 | 2881 | 4335 | 4176 | 2621 |
| 2047 | 2503 | 2164 | 1823 | 422 | 4028 | 2073 | 3656 | 3634 | 2942 | 4335 | 4176 | 2621 |
| 2048 | 2503 | 2164 | 1838 | 461 | 4100 | 2134 | 3656 | 3634 | 2942 | 4335 | 4176 | 2621 |
| 2049 | 2503 | 2164 | 1838 | 461 | 4100 | 2134 | 3656 | 3634 | 2942 | 4335 | 4176 | 2621 |
| 2050 | 2503 | 2164 | 1838 | 461 | 4100 | 2134 | 3656 | 3634 | 2942 | 4335 | 4176 | 2621 |
| 2051 | 2503 | 2164 | 1838 | 461 | 4100 | 2134 | 3656 | 3634 | 2942 | 4335 | 4176 | 2621 |
| 2052 | 2503 | 2164 | 1838 | 461 | 4100 | 2134 | 3656 | 3634 | 2942 | 4335 | 4176 | 2621 |
| 2053 | 2503 | 2164 | 1838 | 461 | 4100 | 2134 | 3656 | 3634 | 2942 | 4335 | 4176 | 2621 |
| 2054 | 2503 | 2164 | 1838 | 461 | 4100 | 2134 | 3656 | 3634 | 2942 | 4335 | 4176 | 2621 |
| 2055 | 2503 | 2164 | 1838 | 461 | 4100 | 2134 | 3656 | 3634 | 2942 | 4335 | 4176 | 2621 |
| 2056 | 2503 | 2164 | 1838 | 461 | 4100 | 2134 | 3656 | 3634 | 2942 | 4335 | 4176 | 2621 |
| 2057 | 2503 | 2164 | 1838 | 461 | 4100 | 2134 | 3656 | 3634 | 2942 | 4335 | 4176 | 2621 |
| 2058 | 2503 | 2164 | 1838 | 461 | 4100 | 2134 | 3656 | 3634 | 2942 | 4335 | 4176 | 2621 |
| 2059 | 2503 | 2164 | 1838 | 461 | 4100 | 2134 | 3656 | 3634 | 2942 | 4335 | 4176 | 2621 |

|      | 13   | 14   | 15   | 16  | 17   | 18   | 19   | 20   | 21   | 22   | 23   | 24   |
|------|------|------|------|-----|------|------|------|------|------|------|------|------|
| 2060 | 2503 | 2164 | 1838 | 461 | 4100 | 2134 | 3656 | 3634 | 2942 | 4335 | 4176 | 2621 |
| 2061 | 2503 | 2164 | 1838 | 461 | 4100 | 2134 | 3656 | 3634 | 2942 | 4335 | 4176 | 2621 |
| 2062 | 2503 | 2164 | 1838 | 461 | 4100 | 2134 | 3656 | 3634 | 2942 | 4335 | 4176 | 2621 |
| 2063 | 2503 | 2164 | 1838 | 461 | 4100 | 2134 | 3656 | 3634 | 2942 | 4335 | 4176 | 2621 |
| 2064 | 2503 | 2164 | 1838 | 461 | 4100 | 2134 | 3656 | 3634 | 2942 | 4335 | 4176 | 2621 |
| 2065 | 2503 | 2164 | 1838 | 461 | 4100 | 2134 | 3656 | 3634 | 2942 | 4335 | 4176 | 2621 |
| 2066 | 2503 | 2164 | 1838 | 461 | 4100 | 2134 | 3656 | 3634 | 2942 | 4335 | 4176 | 2621 |
| 2067 | 2503 | 2164 | 1838 | 461 | 4100 | 2134 | 3656 | 3634 | 2942 | 4335 | 4176 | 2621 |
| 2068 | 2503 | 2164 | 1838 | 461 | 4100 | 2134 | 3656 | 3634 | 2942 | 4335 | 4176 | 2621 |
| 2069 | 2503 | 2164 | 1838 | 461 | 4100 | 2134 | 3656 | 3634 | 2942 | 4335 | 4176 | 2621 |
| 2070 | 2503 | 2164 | 1838 | 461 | 4100 | 2134 | 3656 | 3634 | 2942 | 4335 | 4176 | 2621 |
| 2071 | 2503 | 2164 | 1838 | 461 | 4100 | 2134 | 3656 | 3634 | 2942 | 4335 | 4176 | 2621 |
| 2072 | 2503 | 2164 | 1838 | 461 | 4100 | 2134 | 3656 | 3634 | 2942 | 4335 | 4176 | 2621 |
| 2073 | 2503 | 2164 | 1838 | 461 | 4100 | 2134 | 3656 | 3634 | 2942 | 4335 | 4176 | 2621 |
| 2074 | 2503 | 2164 | 1838 | 461 | 4100 | 2134 | 3656 | 3634 | 2942 | 4335 | 4176 | 2621 |
| 2075 | 2503 | 2164 | 1838 | 461 | 4100 | 2134 | 3656 | 3634 | 2942 | 4335 | 4176 | 2621 |
| 2076 | 2503 | 2164 | 1838 | 461 | 4100 | 2134 | 3656 | 3634 | 2942 | 4335 | 4176 | 2621 |
| 2077 | 2503 | 2164 | 1838 | 461 | 4100 | 2134 | 3656 | 3634 | 2942 | 4335 | 4176 | 2621 |
| 2078 | 2503 | 2164 | 1838 | 461 | 4100 | 2134 | 3656 | 3634 | 2942 | 4335 | 4176 | 2621 |
| 2079 | 2503 | 2164 | 1838 | 461 | 4100 | 2134 | 3656 | 3634 | 2942 | 4335 | 4176 | 2621 |
| 2080 | 2503 | 2164 | 1838 | 461 | 4100 | 2134 | 3656 | 3634 | 2942 | 4335 | 4176 | 2621 |
| 2081 | 2503 | 2164 | 1838 | 461 | 4100 | 2134 | 3656 | 3634 | 2942 | 4335 | 4176 | 2621 |
| 2082 | 2503 | 2164 | 1838 | 461 | 4100 | 2134 | 3656 | 3634 | 2942 | 4335 | 4176 | 2621 |
| 2083 | 2503 | 2164 | 1838 | 461 | 4100 | 2134 | 3656 | 3634 | 2942 | 4335 | 4176 | 2621 |
| 2084 | 2503 | 2164 | 1838 | 461 | 4100 | 2134 | 3656 | 3634 | 2942 | 4335 | 4176 | 2621 |
| 2085 | 2503 | 2164 | 1838 | 461 | 4100 | 2134 | 3656 | 3634 | 2942 | 4335 | 4176 | 2621 |
| 2086 | 2503 | 2164 | 1838 | 461 | 4100 | 2134 | 3656 | 3634 | 2942 | 4335 | 4176 | 2621 |
| 2087 | 2503 | 2164 | 1838 | 461 | 4100 | 2134 | 3656 | 3634 | 2942 | 4335 | 4176 | 2621 |
| 2088 | 2503 | 2164 | 1838 | 461 | 4100 | 2134 | 3656 | 3634 | 2942 | 4335 | 4176 | 2621 |
| 2089 | 2503 | 2164 | 1838 | 461 | 4100 | 2134 | 3656 | 3634 | 2942 | 4335 | 4176 | 2621 |
| 2090 | 2503 | 2164 | 1838 | 461 | 4100 | 2134 | 3656 | 3634 | 2942 | 4335 | 4176 | 2621 |

|      | 25   | 26   | 27   | 28 | 29  | 30 | 31  | 32  | 33  | 34 | 35  | 36 |
|------|------|------|------|----|-----|----|-----|-----|-----|----|-----|----|
| 2002 | 0    | 0    | 0    | 0  | 0   | 0  | 0   | 0   | 0   | 0  | 0   | 0  |
| 2003 | 0    | 0    | 0    | 0  | 0   | 0  | 0   | 0   | 0   | 0  | 0   | 0  |
| 2004 | 0    | 0    | 0    | 0  | 0   | 0  | 0   | 0   | 0   | 0  | 0   | 0  |
| 2005 | 0    | 0    | 0    | 0  | 0   | 0  | 0   | 0   | 0   | 0  | 0   | 0  |
| 2006 | 0    | 0    | 0    | 0  | 0   | 0  | 0   | 0   | 0   | 0  | 0   | 0  |
| 2007 | 0    | 0    | 0    | 0  | 0   | 0  | 0   | 0   | 0   | 0  | 0   | 0  |
| 2008 | 0    | 0    | 0    | 0  | 0   | 0  | 0   | 0   | 0   | 0  | 0   | 0  |
| 2009 | 0    | 0    | 0    | 0  | 0   | 0  | 0   | 0   | 0   | 0  | 0   | 0  |
| 2010 | 0    | 0    | 0    | 0  | 0   | 0  | 0   | 0   | 0   | 0  | 0   | 0  |
| 2011 | 0    | 0    | 0    | 0  | 0   | 0  | 0   | 0   | 0   | 0  | 0   | 0  |
| 2012 | 0    | 0    | 0    | 0  | 0   | 0  | 0   | 0   | 0   | 0  | 0   | 0  |
| 2013 | 0    | 0    | 0    | 0  | 0   | 0  | 0   | 0   | 0   | 0  | 0   | 0  |
| 2014 | 0    | 0    | 0    | 0  | 0   | 0  | 0   | 0   | 0   | 0  | 0   | 0  |
| 2015 | 0    | 0    | 0    | 0  | 0   | 0  | 0   | 0   | 0   | 0  | 0   | 0  |
| 2016 | 0    | 0    | 0    | 0  | 0   | 0  | 0   | 0   | 0   | 0  | 0   | 0  |
| 2017 | 0    | 0    | 0    | 0  | 0   | 0  | 0   | 0   | 0   | 0  | 0   | 0  |
| 2018 | 0    | 0    | 0    | 0  | 0   | 0  | 0   | 0   | 0   | 0  | 0   | 0  |
| 2019 | 0    | 0    | 0    | 0  | 0   | 0  | 0   | 0   | 0   | 0  | 0   | 0  |
| 2020 | 0    | 0    | 0    | 0  | 0   | 0  | 0   | 0   | 0   | 0  | 0   | 0  |
| 2021 | 0    | 0    | 0    | 0  | 0   | 0  | 0   | 0   | 0   | 0  | 0   | 0  |
| 2022 | 0    | 0    | 0    | 0  | 0   | 0  | 0   | 0   | 0   | 0  | 0   | 0  |
| 2023 | 0    | 0    | 0    | 0  | 0   | 0  | 0   | 0   | 0   | 0  | 0   | 0  |
| 2024 | 0    | 0    | 0    | 0  | 0   | 0  | 0   | 0   | 0   | 0  | 0   | 0  |
| 2025 | 186  | 249  | 233  | 0  | 0   | 0  | 0   | 0   | 0   | 0  | 0   | 0  |
| 2026 | 342  | 494  | 448  | 0  | 0   | 0  | 0   | 0   | 0   | 0  | 0   | 0  |
| 2027 | 507  | 748  | 677  | 0  | 0   | 0  | 0   | 0   | 0   | 0  | 0   | 0  |
| 2028 | 645  | 986  | 884  | 0  | 0   | 0  | 0   | 0   | 0   | 0  | 0   | 0  |
| 2029 | 770  | 1199 | 1061 | 0  | 0   | 0  | 0   | 0   | 0   | 0  | 0   | 0  |
| 2030 | 884  | 1431 | 1247 | 0  | 0   | 0  | 0   | 0   | 0   | 0  | 0   | 0  |
| 2031 | 983  | 1655 | 1422 | 0  | 0   | 0  | 0   | 0   | 0   | 0  | 0   | 0  |
| 2032 | 1068 | 1872 | 1596 | 0  | 0   | 0  | 0   | 0   | 0   | 0  | 7   | 0  |
| 2033 | 1169 | 2082 | 1764 | 0  | 0   | 0  | 7   | 0   | 0   | 0  | 12  | 0  |
| 2034 | 1281 | 2302 | 1948 | 0  | 0   | 0  | 22  | 0   | 0   | 0  | 51  | 0  |
| 2035 | 1362 | 2519 | 2127 | 0  | 0   | 0  | 36  | 0   | 0   | 0  | 113 | 0  |
| 2036 | 1438 | 2710 | 2272 | 0  | 1   | 0  | 77  | 2   | 0   | 0  | 218 | 1  |
| 2037 | 1504 | 2911 | 2412 | 2  | 3   | 0  | 116 | 4   | 0   | 0  | 287 | 3  |
| 2038 | 1583 | 3092 | 2537 | 5  | 8   | 0  | 167 | 12  | 2   | 0  | 406 | 8  |
| 2039 | 1641 | 3276 | 2670 | 13 | 18  | 0  | 249 | 28  | 9   | 0  | 496 | 18 |
| 2040 | 1739 | 3496 | 2837 | 19 | 30  | 0  | 290 | 52  | 18  | 0  | 589 | 26 |
| 2041 | 1801 | 3687 | 3005 | 56 | 73  | 0  | 318 | 70  | 44  | 0  | 721 | 69 |
| 2042 | 1856 | 3916 | 3190 | 82 | 102 | 1  | 318 | 109 | 72  | 0  | 834 | 96 |
| 2043 | 1909 | 4079 | 3325 | 92 | 105 | 2  | 318 | 111 | 104 | 0  | 865 | 99 |
| 2044 | 1961 | 4237 | 3454 | 92 | 105 | 29 | 318 | 111 | 104 | 0  | 865 | 99 |
| 2045 | 2025 | 4420 | 3574 | 92 | 105 | 31 | 318 | 111 | 104 | 0  | 865 | 99 |
| 2046 | 2050 | 4519 | 3651 | 92 | 105 | 31 | 318 | 111 | 104 | 0  | 865 | 99 |
| 2047 | 2050 | 4519 | 3651 | 92 | 105 | 31 | 318 | 111 | 104 | 0  | 865 | 99 |
| 2048 | 2050 | 4519 | 3651 | 92 | 105 | 31 | 318 | 111 | 104 | 0  | 865 | 99 |
| 2049 | 2050 | 4519 | 3651 | 92 | 105 | 31 | 318 | 111 | 104 | 0  | 865 | 99 |
| 2050 | 2050 | 4519 | 3651 | 92 | 105 | 31 | 318 | 111 | 104 | 0  | 865 | 99 |
| 2051 | 2050 | 4519 | 3651 | 92 | 105 | 31 | 318 | 111 | 104 | 0  | 865 | 99 |
| 2052 | 2050 | 4519 | 3651 | 92 | 105 | 31 | 318 | 111 | 104 | 0  | 865 | 99 |
| 2053 | 2050 | 4519 | 3651 | 92 | 105 | 31 | 318 | 111 | 104 | 0  | 865 | 99 |
| 2054 | 2050 | 4519 | 3651 | 92 | 105 | 31 | 318 | 111 | 104 | 0  | 865 | 99 |
| 2055 | 2050 | 4519 | 3651 | 92 | 105 | 31 | 318 | 111 | 104 | 0  | 865 | 99 |
| 2056 | 2050 | 4519 | 3651 | 92 | 105 | 31 | 318 | 111 | 104 | 0  | 865 | 99 |
| 2057 | 2050 | 4519 | 3651 | 92 | 105 | 31 | 318 | 111 | 104 | 0  | 865 | 99 |
| 2058 | 2050 | 4519 | 3651 | 92 | 105 | 31 | 318 | 111 | 104 | 0  | 865 | 99 |
| 2059 | 2050 | 4519 | 3651 | 92 | 105 | 31 | 318 | 111 | 104 | 0  | 865 | 99 |

|      | 25   | 26   | 27   | 28 | 29  | 30 | 31  | 32  | 33  | 34 | 35  | 36 |
|------|------|------|------|----|-----|----|-----|-----|-----|----|-----|----|
| 2060 | 2050 | 4519 | 3651 | 92 | 105 | 31 | 318 | 111 | 104 | 0  | 865 | 99 |
| 2061 | 2050 | 4519 | 3651 | 92 | 105 | 31 | 318 | 111 | 104 | 0  | 865 | 99 |
| 2062 | 2050 | 4519 | 3651 | 92 | 105 | 31 | 318 | 111 | 104 | 0  | 865 | 99 |
| 2063 | 2050 | 4519 | 3651 | 92 | 105 | 31 | 318 | 111 | 104 | 0  | 865 | 99 |
| 2064 | 2050 | 4519 | 3651 | 92 | 105 | 31 | 318 | 111 | 104 | 0  | 865 | 99 |
| 2065 | 2050 | 4519 | 3651 | 92 | 105 | 31 | 318 | 111 | 104 | 0  | 865 | 99 |
| 2066 | 2050 | 4519 | 3651 | 92 | 105 | 31 | 318 | 111 | 104 | 0  | 865 | 99 |
| 2067 | 2050 | 4519 | 3651 | 92 | 105 | 31 | 318 | 111 | 104 | 0  | 865 | 99 |
| 2068 | 2050 | 4519 | 3651 | 92 | 105 | 31 | 318 | 111 | 104 | 0  | 865 | 99 |
| 2069 | 2050 | 4519 | 3651 | 92 | 105 | 31 | 318 | 111 | 104 | 0  | 865 | 99 |
| 2070 | 2050 | 4519 | 3651 | 92 | 105 | 31 | 318 | 111 | 104 | 0  | 865 | 99 |
| 2071 | 2050 | 4519 | 3651 | 92 | 105 | 31 | 318 | 111 | 104 | 0  | 865 | 99 |
| 2072 | 2050 | 4519 | 3651 | 92 | 105 | 31 | 318 | 111 | 104 | 0  | 865 | 99 |
| 2073 | 2050 | 4519 | 3651 | 92 | 105 | 31 | 318 | 111 | 104 | 0  | 865 | 99 |
| 2074 | 2050 | 4519 | 3651 | 92 | 105 | 31 | 318 | 111 | 104 | 0  | 865 | 99 |
| 2075 | 2050 | 4519 | 3651 | 92 | 105 | 31 | 318 | 111 | 104 | 0  | 865 | 99 |
| 2076 | 2050 | 4519 | 3651 | 92 | 105 | 31 | 318 | 111 | 104 | 0  | 865 | 99 |
| 2077 | 2050 | 4519 | 3651 | 92 | 105 | 31 | 318 | 111 | 104 | 0  | 865 | 99 |
| 2078 | 2050 | 4519 | 3651 | 92 | 105 | 31 | 318 | 111 | 104 | 0  | 865 | 99 |
| 2079 | 2050 | 4519 | 3651 | 92 | 105 | 31 | 318 | 111 | 104 | 0  | 865 | 99 |
| 2080 | 2050 | 4519 | 3651 | 92 | 105 | 31 | 318 | 111 | 104 | 0  | 865 | 99 |
| 2081 | 2050 | 4519 | 3651 | 92 | 105 | 31 | 318 | 111 | 104 | 0  | 865 | 99 |
| 2082 | 2050 | 4519 | 3651 | 92 | 105 | 31 | 318 | 111 | 104 | 0  | 865 | 99 |
| 2083 | 2050 | 4519 | 3651 | 92 | 105 | 31 | 318 | 111 | 104 | 0  | 865 | 99 |
| 2084 | 2050 | 4519 | 3651 | 92 | 105 | 31 | 318 | 111 | 104 | 0  | 865 | 99 |
| 2085 | 2050 | 4519 | 3651 | 92 | 105 | 31 | 318 | 111 | 104 | 0  | 865 | 99 |
| 2086 | 2050 | 4519 | 3651 | 92 | 105 | 31 | 318 | 111 | 104 | 0  | 865 | 99 |
| 2087 | 2050 | 4519 | 3651 | 92 | 105 | 31 | 318 | 111 | 104 | 0  | 865 | 99 |
| 2088 | 2050 | 4519 | 3651 | 92 | 105 | 31 | 318 | 111 | 104 | 0  | 865 | 99 |
| 2089 | 2050 | 4519 | 3651 | 92 | 105 | 31 | 318 | 111 | 104 | 0  | 865 | 99 |
| 2090 | 2050 | 4519 | 3651 | 92 | 105 | 31 | 318 | 111 | 104 | 0  | 865 | 99 |

|      | 37   | 38   | 39   | 40   | 41   | 42   | 43  | 44   | 45   | 46   | 47   | 48   |
|------|------|------|------|------|------|------|-----|------|------|------|------|------|
| 2002 | 0    | 0    | 0    | 0    | 0    | 0    | 0   | 0    | 0    | 0    | 0    | 0    |
| 2003 | 0    | 0    | 0    | 0    | 0    | 0    | 0   | 0    | 0    | 0    | 0    | 0    |
| 2004 | 0    | 0    | 0    | 0    | 0    | 0    | 0   | 0    | 0    | 0    | 0    | 0    |
| 2005 | 0    | 0    | 0    | 0    | 0    | 0    | 0   | 0    | 0    | 0    | 0    | 0    |
| 2006 | 0    | 0    | 0    | 0    | 0    | 0    | 0   | 0    | 0    | 0    | 0    | 0    |
| 2007 | 0    | 0    | 0    | 0    | 0    | 0    | 0   | 0    | 0    | 0    | 0    | 0    |
| 2008 | 0    | 0    | 0    | 0    | 0    | 0    | 0   | 0    | 0    | 0    | 0    | 0    |
| 2009 | 0    | 0    | 0    | 0    | 0    | 0    | 0   | 0    | 0    | 0    | 0    | 0    |
| 2010 | 0    | 0    | 0    | 0    | 0    | 0    | 0   | 0    | 0    | 0    | 0    | 0    |
| 2011 | 0    | 0    | 0    | 0    | 0    | 0    | 0   | 0    | 0    | 0    | 0    | 0    |
| 2012 | 0    | 0    | 0    | 0    | 0    | 0    | 0   | 0    | 0    | 0    | 0    | 0    |
| 2013 | 0    | 0    | 0    | 0    | 0    | 0    | 0   | 0    | 0    | 0    | 0    | 0    |
| 2014 | 0    | 0    | 0    | 0    | 0    | 0    | 0   | 0    | 0    | 0    | 0    | 0    |
| 2015 | 0    | 0    | 0    | 0    | 0    | 0    | 0   | 0    | 0    | 0    | 0    | 0    |
| 2016 | 0    | 0    | 0    | 0    | 0    | 0    | 0   | 0    | 0    | 0    | 0    | 0    |
| 2017 | 0    | 0    | 0    | 0    | 0    | 0    | 0   | 0    | 0    | 0    | 0    | 0    |
| 2018 | 0    | 0    | 0    | 0    | 0    | 0    | 0   | 0    | 0    | 0    | 0    | 0    |
| 2019 | 0    | 0    | 0    | 0    | 0    | 0    | 0   | 0    | 0    | 0    | 0    | 0    |
| 2020 | 0    | 0    | 0    | 160  | 0    | 0    | 0   | 0    | 0    | 0    | 0    | 0    |
| 2021 | 0    | 0    | 0    | 324  | 0    | 0    | 0   | 0    | 0    | 0    | 0    | 0    |
| 2022 | 0    | 0    | 0    | 463  | 0    | 0    | 0   | 0    | 0    | 0    | 0    | 0    |
| 2023 | 0    | 0    | 0    | 597  | 0    | 0    | 0   | 0    | 0    | 0    | 0    | 0    |
| 2024 | 0    | 0    | 0    | 715  | 0    | 0    | 0   | 0    | 0    | 0    | 0    | 0    |
| 2025 | 179  | 179  | 0    | 831  | 186  | 74   | 6   | 246  | 179  | 233  | 233  | 0    |
| 2026 | 339  | 332  | 0    | 929  | 345  | 160  | 11  | 471  | 334  | 446  | 444  | 0    |
| 2027 | 507  | 500  | 0    | 1022 | 499  | 249  | 16  | 721  | 507  | 670  | 666  | 0    |
| 2028 | 642  | 629  | 0    | 1108 | 617  | 332  | 23  | 939  | 638  | 873  | 865  | 0    |
| 2029 | 777  | 766  | 0    | 1171 | 744  | 423  | 23  | 1139 | 769  | 1051 | 1045 | 0    |
| 2030 | 895  | 887  | 184  | 1231 | 830  | 507  | 29  | 1355 | 883  | 1240 | 1219 | 240  |
| 2031 | 969  | 957  | 333  | 1304 | 913  | 608  | 38  | 1544 | 954  | 1421 | 1395 | 449  |
| 2032 | 1044 | 1035 | 470  | 1342 | 995  | 695  | 43  | 1732 | 1031 | 1598 | 1573 | 649  |
| 2033 | 1109 | 1100 | 591  | 1420 | 1066 | 789  | 45  | 1904 | 1099 | 1770 | 1750 | 846  |
| 2034 | 1210 | 1201 | 713  | 1495 | 1159 | 893  | 59  | 2105 | 1208 | 1938 | 1918 | 1027 |
| 2035 | 1290 | 1282 | 812  | 1565 | 1232 | 1022 | 69  | 2313 | 1285 | 2128 | 2105 | 1202 |
| 2036 | 1355 | 1345 | 909  | 1648 | 1304 | 1107 | 83  | 2465 | 1349 | 2271 | 2243 | 1379 |
| 2037 | 1439 | 1426 | 991  | 1712 | 1390 | 1173 | 118 | 2635 | 1436 | 2417 | 2384 | 1527 |
| 2038 | 1505 | 1497 | 1083 | 1756 | 1495 | 1237 | 136 | 2797 | 1497 | 2547 | 2507 | 1696 |
| 2039 | 1584 | 1580 | 1161 | 1825 | 1586 | 1295 | 155 | 2960 | 1556 | 2683 | 2635 | 1847 |
| 2040 | 1645 | 1644 | 1275 | 1921 | 1702 | 1390 | 186 | 3154 | 1631 | 2878 | 2795 | 1989 |
| 2041 | 1725 | 1728 | 1380 | 2012 | 1774 | 1480 | 213 | 3331 | 1726 | 3034 | 2957 | 2154 |
| 2042 | 1771 | 1782 | 1417 | 2085 | 1837 | 1518 | 230 | 3472 | 1781 | 3199 | 3131 | 2315 |
| 2043 | 1825 | 1837 | 1469 | 2162 | 1907 | 1569 | 257 | 3604 | 1836 | 3331 | 3270 | 2450 |
| 2044 | 1862 | 1871 | 1525 | 2259 | 1977 | 1645 | 278 | 3703 | 1874 | 3463 | 3409 | 2587 |
| 2045 | 1916 | 1920 | 1575 | 2357 | 2036 | 1716 | 309 | 3799 | 1926 | 3591 | 3539 | 2720 |
| 2046 | 1970 | 1969 | 1636 | 2430 | 2098 | 1799 | 342 | 3903 | 1987 | 3671 | 3633 | 2837 |
| 2047 | 2062 | 2046 | 1708 | 2464 | 2143 | 1826 | 396 | 4044 | 2070 | 3671 | 3633 | 2916 |
| 2048 | 2132 | 2108 | 1708 | 2464 | 2143 | 1826 | 428 | 4118 | 2125 | 3671 | 3633 | 2916 |
| 2049 | 2132 | 2108 | 1708 | 2464 | 2143 | 1826 | 428 | 4118 | 2125 | 3671 | 3633 | 2916 |
| 2050 | 2132 | 2108 | 1708 | 2464 | 2143 | 1826 | 428 | 4118 | 2125 | 3671 | 3633 | 2916 |
| 2051 | 2132 | 2108 | 1708 | 2464 | 2143 | 1826 | 428 | 4118 | 2125 | 3671 | 3633 | 2916 |
| 2052 | 2132 | 2108 | 1708 | 2464 | 2143 | 1826 | 428 | 4118 | 2125 | 3671 | 3633 | 2916 |
| 2053 | 2132 | 2108 | 1708 | 2464 | 2143 | 1826 | 428 | 4118 | 2125 | 3671 | 3633 | 2916 |
| 2054 | 2132 | 2108 | 1708 | 2464 | 2143 | 1826 | 428 | 4118 | 2125 | 3671 | 3633 | 2916 |
| 2055 | 2132 | 2108 | 1708 | 2464 | 2143 | 1826 | 428 | 4118 | 2125 | 3671 | 3633 | 2916 |
| 2056 | 2132 | 2108 | 1708 | 2464 | 2143 | 1826 | 428 | 4118 | 2125 | 3671 | 3633 | 2916 |
| 2057 | 2132 | 2108 | 1708 | 2464 | 2143 | 1826 | 428 | 4118 | 2125 | 3671 | 3633 | 2916 |
| 2058 | 2132 | 2108 | 1708 | 2464 | 2143 | 1826 | 428 | 4118 | 2125 | 3671 | 3633 | 2916 |
| 2059 | 2132 | 2108 | 1708 | 2464 | 2143 | 1826 | 428 | 4118 | 2125 | 3671 | 3633 | 2916 |

|      | 37   | 38   | 39   | 40   | 41   | 42   | 43  | 44   | 45   | 46   | 47   | 48   |
|------|------|------|------|------|------|------|-----|------|------|------|------|------|
| 2060 | 2132 | 2108 | 1708 | 2464 | 2143 | 1826 | 428 | 4118 | 2125 | 3671 | 3633 | 2916 |
| 2061 | 2132 | 2108 | 1708 | 2464 | 2143 | 1826 | 428 | 4118 | 2125 | 3671 | 3633 | 2916 |
| 2062 | 2132 | 2108 | 1708 | 2464 | 2143 | 1826 | 428 | 4118 | 2125 | 3671 | 3633 | 2916 |
| 2063 | 2132 | 2108 | 1708 | 2464 | 2143 | 1826 | 428 | 4118 | 2125 | 3671 | 3633 | 2916 |
| 2064 | 2132 | 2108 | 1708 | 2464 | 2143 | 1826 | 428 | 4118 | 2125 | 3671 | 3633 | 2916 |
| 2065 | 2132 | 2108 | 1708 | 2464 | 2143 | 1826 | 428 | 4118 | 2125 | 3671 | 3633 | 2916 |
| 2066 | 2132 | 2108 | 1708 | 2464 | 2143 | 1826 | 428 | 4118 | 2125 | 3671 | 3633 | 2916 |
| 2067 | 2132 | 2108 | 1708 | 2464 | 2143 | 1826 | 428 | 4118 | 2125 | 3671 | 3633 | 2916 |
| 2068 | 2132 | 2108 | 1708 | 2464 | 2143 | 1826 | 428 | 4118 | 2125 | 3671 | 3633 | 2916 |
| 2069 | 2132 | 2108 | 1708 | 2464 | 2143 | 1826 | 428 | 4118 | 2125 | 3671 | 3633 | 2916 |
| 2070 | 2132 | 2108 | 1708 | 2464 | 2143 | 1826 | 428 | 4118 | 2125 | 3671 | 3633 | 2916 |
| 2071 | 2132 | 2108 | 1708 | 2464 | 2143 | 1826 | 428 | 4118 | 2125 | 3671 | 3633 | 2916 |
| 2072 | 2132 | 2108 | 1708 | 2464 | 2143 | 1826 | 428 | 4118 | 2125 | 3671 | 3633 | 2916 |
| 2073 | 2132 | 2108 | 1708 | 2464 | 2143 | 1826 | 428 | 4118 | 2125 | 3671 | 3633 | 2916 |
| 2074 | 2132 | 2108 | 1708 | 2464 | 2143 | 1826 | 428 | 4118 | 2125 | 3671 | 3633 | 2916 |
| 2075 | 2132 | 2108 | 1708 | 2464 | 2143 | 1826 | 428 | 4118 | 2125 | 3671 | 3633 | 2916 |
| 2076 | 2132 | 2108 | 1708 | 2464 | 2143 | 1826 | 428 | 4118 | 2125 | 3671 | 3633 | 2916 |
| 2077 | 2132 | 2108 | 1708 | 2464 | 2143 | 1826 | 428 | 4118 | 2125 | 3671 | 3633 | 2916 |
| 2078 | 2132 | 2108 | 1708 | 2464 | 2143 | 1826 | 428 | 4118 | 2125 | 3671 | 3633 | 2916 |
| 2079 | 2132 | 2108 | 1708 | 2464 | 2143 | 1826 | 428 | 4118 | 2125 | 3671 | 3633 | 2916 |
| 2080 | 2132 | 2108 | 1708 | 2464 | 2143 | 1826 | 428 | 4118 | 2125 | 3671 | 3633 | 2916 |
| 2081 | 2132 | 2108 | 1708 | 2464 | 2143 | 1826 | 428 | 4118 | 2125 | 3671 | 3633 | 2916 |
| 2082 | 2132 | 2108 | 1708 | 2464 | 2143 | 1826 | 428 | 4118 | 2125 | 3671 | 3633 | 2916 |
| 2083 | 2132 | 2108 | 1708 | 2464 | 2143 | 1826 | 428 | 4118 | 2125 | 3671 | 3633 | 2916 |
| 2084 | 2132 | 2108 | 1708 | 2464 | 2143 | 1826 | 428 | 4118 | 2125 | 3671 | 3633 | 2916 |
| 2085 | 2132 | 2108 | 1708 | 2464 | 2143 | 1826 | 428 | 4118 | 2125 | 3671 | 3633 | 2916 |
| 2086 | 2132 | 2108 | 1708 | 2464 | 2143 | 1826 | 428 | 4118 | 2125 | 3671 | 3633 | 2916 |
| 2087 | 2132 | 2108 | 1708 | 2464 | 2143 | 1826 | 428 | 4118 | 2125 | 3671 | 3633 | 2916 |
| 2088 | 2132 | 2108 | 1708 | 2464 | 2143 | 1826 | 428 | 4118 | 2125 | 3671 | 3633 | 2916 |
| 2089 | 2132 | 2108 | 1708 | 2464 | 2143 | 1826 | 428 | 4118 | 2125 | 3671 | 3633 | 2916 |
| 2090 | 2132 | 2108 | 1708 | 2464 | 2143 | 1826 | 428 | 4118 | 2125 | 3671 | 3633 | 2916 |



|      | 49   | 50   | 51   | 52   | 53   | 54   | 55 | 56 | 57 | 58  | 59  | 60  |
|------|------|------|------|------|------|------|----|----|----|-----|-----|-----|
| 2002 | 0    | 0    | 0    | 0    | 0    | 0    | 0  | 0  | 0  | 0   | 0   | 0   |
| 2003 | 0    | 0    | 0    | 0    | 0    | 0    | 0  | 0  | 0  | 0   | 0   | 0   |
| 2004 | 0    | 0    | 0    | 0    | 0    | 0    | 0  | 0  | 0  | 0   | 0   | 0   |
| 2005 | 0    | 0    | 0    | 0    | 0    | 0    | 0  | 0  | 0  | 0   | 0   | 0   |
| 2006 | 0    | 0    | 0    | 0    | 0    | 0    | 0  | 0  | 0  | 0   | 0   | 0   |
| 2007 | 0    | 0    | 0    | 0    | 0    | 0    | 0  | 0  | 0  | 0   | 0   | 0   |
| 2008 | 0    | 0    | 0    | 0    | 0    | 0    | 0  | 0  | 0  | 0   | 0   | 0   |
| 2009 | 0    | 0    | 0    | 0    | 0    | 0    | 0  | 0  | 0  | 0   | 0   | 0   |
| 2010 | 0    | 0    | 0    | 0    | 0    | 0    | 0  | 0  | 0  | 0   | 0   | 0   |
| 2011 | 0    | 0    | 0    | 0    | 0    | 0    | 0  | 0  | 0  | 0   | 0   | 0   |
| 2012 | 0    | 0    | 0    | 0    | 0    | 0    | 0  | 0  | 0  | 0   | 0   | 0   |
| 2013 | 0    | 0    | 0    | 0    | 0    | 0    | 0  | 0  | 0  | 0   | 0   | 0   |
| 2014 | 0    | 0    | 0    | 0    | 0    | 0    | 0  | 0  | 0  | 0   | 0   | 0   |
| 2015 | 0    | 0    | 0    | 0    | 0    | 0    | 0  | 0  | 0  | 0   | 0   | 0   |
| 2016 | 0    | 0    | 0    | 0    | 0    | 0    | 0  | 0  | 0  | 0   | 0   | 0   |
| 2017 | 0    | 0    | 0    | 0    | 0    | 0    | 0  | 0  | 0  | 0   | 0   | 0   |
| 2018 | 0    | 0    | 0    | 0    | 0    | 0    | 0  | 0  | 0  | 0   | 0   | 0   |
| 2019 | 0    | 0    | 0    | 0    | 0    | 0    | 0  | 0  | 0  | 0   | 0   | 0   |
| 2020 | 240  | 0    | 0    | 0    | 0    | 0    | 0  | 0  | 0  | 0   | 0   | 0   |
| 2021 | 477  | 0    | 0    | 0    | 0    | 0    | 0  | 0  | 0  | 0   | 0   | 0   |
| 2022 | 699  | 0    | 0    | 0    | 0    | 0    | 0  | 0  | 0  | 0   | 0   | 0   |
| 2023 | 901  | 0    | 0    | 0    | 0    | 0    | 0  | 0  | 0  | 0   | 0   | 0   |
| 2024 | 1127 | 0    | 0    | 0    | 0    | 0    | 0  | 0  | 0  | 0   | 0   | 0   |
| 2025 | 1317 | 238  | 187  | 186  | 249  | 233  | 0  | 0  | 0  | 0   | 0   | 0   |
| 2026 | 1514 | 475  | 326  | 342  | 492  | 446  | 0  | 0  | 0  | 0   | 0   | 0   |
| 2027 | 1708 | 719  | 501  | 502  | 739  | 669  | 0  | 0  | 0  | 0   | 0   | 0   |
| 2028 | 1921 | 945  | 621  | 634  | 966  | 868  | 0  | 0  | 0  | 0   | 0   | 0   |
| 2029 | 2112 | 1155 | 731  | 766  | 1183 | 1047 | 0  | 0  | 0  | 0   | 0   | 0   |
| 2030 | 2289 | 1362 | 870  | 883  | 1412 | 1226 | 0  | 0  | 0  | 0   | 0   | 0   |
| 2031 | 2474 | 1566 | 993  | 984  | 1636 | 1398 | 0  | 0  | 0  | 0   | 0   | 0   |
| 2032 | 2620 | 1747 | 1106 | 1069 | 1850 | 1574 | 0  | 0  | 0  | 0   | 0   | 0   |
| 2033 | 2772 | 1938 | 1256 | 1167 | 2056 | 1739 | 0  | 0  | 0  | 4   | 0   | 0   |
| 2034 | 2920 | 2117 | 1387 | 1273 | 2272 | 1914 | 0  | 0  | 0  | 15  | 0   | 0   |
| 2035 | 3060 | 2317 | 1531 | 1360 | 2495 | 2101 | 0  | 0  | 0  | 24  | 0   | 0   |
| 2036 | 3198 | 2493 | 1651 | 1441 | 2666 | 2236 | 0  | 0  | 0  | 38  | 0   | 0   |
| 2037 | 3346 | 2654 | 1756 | 1505 | 2863 | 2382 | 0  | 0  | 0  | 63  | 1   | 0   |
| 2038 | 3482 | 2810 | 1873 | 1576 | 3056 | 2505 | 0  | 0  | 0  | 129 | 3   | 2   |
| 2039 | 3644 | 2981 | 2004 | 1637 | 3237 | 2634 | 0  | 0  | 0  | 186 | 4   | 5   |
| 2040 | 3799 | 3189 | 2118 | 1740 | 3462 | 2810 | 0  | 0  | 0  | 234 | 7   | 7   |
| 2041 | 3945 | 3378 | 2230 | 1798 | 3650 | 2974 | 6  | 5  | 0  | 284 | 16  | 13  |
| 2042 | 4092 | 3582 | 2301 | 1850 | 3870 | 3147 | 13 | 16 | 0  | 287 | 33  | 41  |
| 2043 | 4262 | 3745 | 2414 | 1911 | 4042 | 3288 | 35 | 28 | 0  | 287 | 66  | 73  |
| 2044 | 4331 | 3936 | 2489 | 1963 | 4220 | 3429 | 45 | 46 | 0  | 287 | 114 | 105 |
| 2045 | 4331 | 4128 | 2584 | 2026 | 4414 | 3558 | 45 | 46 | 0  | 287 | 114 | 105 |
| 2046 | 4331 | 4187 | 2646 | 2055 | 4521 | 3634 | 45 | 46 | 4  | 287 | 114 | 105 |
| 2047 | 4331 | 4187 | 2646 | 2055 | 4521 | 3634 | 45 | 46 | 4  | 287 | 114 | 105 |
| 2048 | 4331 | 4187 | 2646 | 2055 | 4521 | 3634 | 45 | 46 | 4  | 287 | 114 | 105 |
| 2049 | 4331 | 4187 | 2646 | 2055 | 4521 | 3634 | 45 | 46 | 4  | 287 | 114 | 105 |
| 2050 | 4331 | 4187 | 2646 | 2055 | 4521 | 3634 | 45 | 46 | 4  | 287 | 114 | 105 |
| 2051 | 4331 | 4187 | 2646 | 2055 | 4521 | 3634 | 45 | 46 | 4  | 287 | 114 | 105 |
| 2052 | 4331 | 4187 | 2646 | 2055 | 4521 | 3634 | 45 | 46 | 4  | 287 | 114 | 105 |
| 2053 | 4331 | 4187 | 2646 | 2055 | 4521 | 3634 | 45 | 46 | 4  | 287 | 114 | 105 |
| 2054 | 4331 | 4187 | 2646 | 2055 | 4521 | 3634 | 45 | 46 | 4  | 287 | 114 | 105 |
| 2055 | 4331 | 4187 | 2646 | 2055 | 4521 | 3634 | 45 | 46 | 4  | 287 | 114 | 105 |
| 2056 | 4331 | 4187 | 2646 | 2055 | 4521 | 3634 | 45 | 46 | 4  | 287 | 114 | 105 |
| 2057 | 4331 | 4187 | 2646 | 2055 | 4521 | 3634 | 45 | 46 | 4  | 287 | 114 | 105 |
| 2058 | 4331 | 4187 | 2646 | 2055 | 4521 | 3634 | 45 | 46 | 4  | 287 | 114 | 105 |
| 2059 | 4331 | 4187 | 2646 | 2055 | 4521 | 3634 | 45 | 46 | 4  | 287 | 114 | 105 |

|      | 49   | 50   | 51   | 52   | 53   | 54   | 55 | 56 | 57 | 58  | 59  | 60  |
|------|------|------|------|------|------|------|----|----|----|-----|-----|-----|
| 2060 | 4331 | 4187 | 2646 | 2055 | 4521 | 3634 | 45 | 46 | 4  | 287 | 114 | 105 |
| 2061 | 4331 | 4187 | 2646 | 2055 | 4521 | 3634 | 45 | 46 | 4  | 287 | 114 | 105 |
| 2062 | 4331 | 4187 | 2646 | 2055 | 4521 | 3634 | 45 | 46 | 4  | 287 | 114 | 105 |
| 2063 | 4331 | 4187 | 2646 | 2055 | 4521 | 3634 | 45 | 46 | 4  | 287 | 114 | 105 |
| 2064 | 4331 | 4187 | 2646 | 2055 | 4521 | 3634 | 45 | 46 | 4  | 287 | 114 | 105 |
| 2065 | 4331 | 4187 | 2646 | 2055 | 4521 | 3634 | 45 | 46 | 4  | 287 | 114 | 105 |
| 2066 | 4331 | 4187 | 2646 | 2055 | 4521 | 3634 | 45 | 46 | 4  | 287 | 114 | 105 |
| 2067 | 4331 | 4187 | 2646 | 2055 | 4521 | 3634 | 45 | 46 | 4  | 287 | 114 | 105 |
| 2068 | 4331 | 4187 | 2646 | 2055 | 4521 | 3634 | 45 | 46 | 4  | 287 | 114 | 105 |
| 2069 | 4331 | 4187 | 2646 | 2055 | 4521 | 3634 | 45 | 46 | 4  | 287 | 114 | 105 |
| 2070 | 4331 | 4187 | 2646 | 2055 | 4521 | 3634 | 45 | 46 | 4  | 287 | 114 | 105 |
| 2071 | 4331 | 4187 | 2646 | 2055 | 4521 | 3634 | 45 | 46 | 4  | 287 | 114 | 105 |
| 2072 | 4331 | 4187 | 2646 | 2055 | 4521 | 3634 | 45 | 46 | 4  | 287 | 114 | 105 |
| 2073 | 4331 | 4187 | 2646 | 2055 | 4521 | 3634 | 45 | 46 | 4  | 287 | 114 | 105 |
| 2074 | 4331 | 4187 | 2646 | 2055 | 4521 | 3634 | 45 | 46 | 4  | 287 | 114 | 105 |
| 2075 | 4331 | 4187 | 2646 | 2055 | 4521 | 3634 | 45 | 46 | 4  | 287 | 114 | 105 |
| 2076 | 4331 | 4187 | 2646 | 2055 | 4521 | 3634 | 45 | 46 | 4  | 287 | 114 | 105 |
| 2077 | 4331 | 4187 | 2646 | 2055 | 4521 | 3634 | 45 | 46 | 4  | 287 | 114 | 105 |
| 2078 | 4331 | 4187 | 2646 | 2055 | 4521 | 3634 | 45 | 46 | 4  | 287 | 114 | 105 |
| 2079 | 4331 | 4187 | 2646 | 2055 | 4521 | 3634 | 45 | 46 | 4  | 287 | 114 | 105 |
| 2080 | 4331 | 4187 | 2646 | 2055 | 4521 | 3634 | 45 | 46 | 4  | 287 | 114 | 105 |
| 2081 | 4331 | 4187 | 2646 | 2055 | 4521 | 3634 | 45 | 46 | 4  | 287 | 114 | 105 |
| 2082 | 4331 | 4187 | 2646 | 2055 | 4521 | 3634 | 45 | 46 | 4  | 287 | 114 | 105 |
| 2083 | 4331 | 4187 | 2646 | 2055 | 4521 | 3634 | 45 | 46 | 4  | 287 | 114 | 105 |
| 2084 | 4331 | 4187 | 2646 | 2055 | 4521 | 3634 | 45 | 46 | 4  | 287 | 114 | 105 |
| 2085 | 4331 | 4187 | 2646 | 2055 | 4521 | 3634 | 45 | 46 | 4  | 287 | 114 | 105 |
| 2086 | 4331 | 4187 | 2646 | 2055 | 4521 | 3634 | 45 | 46 | 4  | 287 | 114 | 105 |
| 2087 | 4331 | 4187 | 2646 | 2055 | 4521 | 3634 | 45 | 46 | 4  | 287 | 114 | 105 |
| 2088 | 4331 | 4187 | 2646 | 2055 | 4521 | 3634 | 45 | 46 | 4  | 287 | 114 | 105 |
| 2089 | 4331 | 4187 | 2646 | 2055 | 4521 | 3634 | 45 | 46 | 4  | 287 | 114 | 105 |
| 2090 | 4331 | 4187 | 2646 | 2055 | 4521 | 3634 | 45 | 46 | 4  | 287 | 114 | 105 |

|      | 61 | 62  | 63 | 64   | 65   | 66   | 67   | 68   | 69   | 70  | 71   | 72   |
|------|----|-----|----|------|------|------|------|------|------|-----|------|------|
| 2002 | 0  | 0   | 0  | 0    | 0    | 0    | 0    | 0    | 0    | 0   | 0    | 0    |
| 2003 | 0  | 0   | 0  | 0    | 0    | 0    | 0    | 0    | 0    | 0   | 0    | 0    |
| 2004 | 0  | 0   | 0  | 0    | 0    | 0    | 0    | 0    | 0    | 0   | 0    | 0    |
| 2005 | 0  | 0   | 0  | 0    | 0    | 0    | 0    | 0    | 0    | 0   | 0    | 0    |
| 2006 | 0  | 0   | 0  | 0    | 0    | 0    | 0    | 0    | 0    | 0   | 0    | 0    |
| 2007 | 0  | 0   | 0  | 0    | 0    | 0    | 0    | 0    | 0    | 0   | 0    | 0    |
| 2008 | 0  | 0   | 0  | 0    | 0    | 0    | 0    | 0    | 0    | 0   | 0    | 0    |
| 2009 | 0  | 0   | 0  | 0    | 0    | 0    | 0    | 0    | 0    | 0   | 0    | 0    |
| 2010 | 0  | 0   | 0  | 0    | 0    | 0    | 0    | 0    | 0    | 0   | 0    | 0    |
| 2011 | 0  | 0   | 0  | 0    | 0    | 0    | 0    | 0    | 0    | 0   | 0    | 0    |
| 2012 | 0  | 0   | 0  | 0    | 0    | 0    | 0    | 0    | 0    | 0   | 0    | 0    |
| 2013 | 0  | 0   | 0  | 0    | 0    | 0    | 0    | 0    | 0    | 0   | 0    | 0    |
| 2014 | 0  | 0   | 0  | 0    | 0    | 0    | 0    | 0    | 0    | 0   | 0    | 0    |
| 2015 | 0  | 0   | 0  | 0    | 0    | 0    | 0    | 0    | 0    | 0   | 0    | 0    |
| 2016 | 0  | 0   | 0  | 0    | 0    | 0    | 0    | 0    | 0    | 0   | 0    | 0    |
| 2017 | 0  | 0   | 0  | 0    | 0    | 0    | 0    | 0    | 0    | 0   | 0    | 0    |
| 2018 | 0  | 0   | 0  | 0    | 0    | 0    | 0    | 0    | 0    | 0   | 0    | 0    |
| 2019 | 0  | 0   | 0  | 0    | 0    | 0    | 0    | 0    | 0    | 0   | 0    | 0    |
| 2020 | 0  | 0   | 0  | 0    | 0    | 0    | 160  | 0    | 0    | 0   | 0    | 0    |
| 2021 | 0  | 0   | 0  | 0    | 0    | 0    | 320  | 0    | 0    | 0   | 0    | 0    |
| 2022 | 0  | 0   | 0  | 0    | 0    | 0    | 449  | 0    | 0    | 0   | 0    | 0    |
| 2023 | 0  | 0   | 0  | 0    | 0    | 0    | 594  | 0    | 0    | 0   | 0    | 0    |
| 2024 | 0  | 0   | 0  | 0    | 0    | 0    | 726  | 0    | 0    | 0   | 0    | 0    |
| 2025 | 0  | 0   | 0  | 179  | 179  | 0    | 855  | 186  | 74   | 6   | 246  | 179  |
| 2026 | 0  | 0   | 0  | 353  | 306  | 0    | 965  | 352  | 140  | 6   | 575  | 312  |
| 2027 | 0  | 0   | 0  | 518  | 456  | 0    | 1068 | 536  | 217  | 8   | 891  | 475  |
| 2028 | 0  | 0   | 0  | 662  | 602  | 0    | 1160 | 726  | 307  | 21  | 1217 | 627  |
| 2029 | 0  | 0   | 0  | 794  | 748  | 0    | 1233 | 884  | 388  | 24  | 1462 | 761  |
| 2030 | 0  | 0   | 0  | 918  | 877  | 184  | 1293 | 992  | 473  | 26  | 1696 | 887  |
| 2031 | 0  | 0   | 0  | 1012 | 970  | 308  | 1376 | 1081 | 596  | 38  | 1925 | 978  |
| 2032 | 0  | 0   | 0  | 1108 | 1063 | 444  | 1426 | 1179 | 699  | 42  | 2149 | 1072 |
| 2033 | 0  | 1   | 0  | 1177 | 1137 | 596  | 1531 | 1248 | 792  | 44  | 2344 | 1142 |
| 2034 | 0  | 8   | 0  | 1291 | 1251 | 737  | 1613 | 1358 | 912  | 52  | 2575 | 1256 |
| 2035 | 0  | 22  | 0  | 1392 | 1344 | 848  | 1678 | 1439 | 1043 | 62  | 2820 | 1360 |
| 2036 | 0  | 44  | 0  | 1468 | 1421 | 932  | 1737 | 1515 | 1111 | 78  | 2982 | 1434 |
| 2037 | 0  | 71  | 0  | 1528 | 1493 | 1024 | 1788 | 1594 | 1183 | 97  | 3142 | 1494 |
| 2038 | 0  | 147 | 0  | 1593 | 1558 | 1137 | 1847 | 1674 | 1258 | 114 | 3289 | 1564 |
| 2039 | 0  | 232 | 0  | 1667 | 1631 | 1215 | 1926 | 1775 | 1322 | 127 | 3456 | 1634 |
| 2040 | 0  | 343 | 0  | 1761 | 1728 | 1323 | 2030 | 1904 | 1403 | 161 | 3676 | 1725 |
| 2041 | 0  | 439 | 8  | 1861 | 1825 | 1438 | 2112 | 1985 | 1483 | 189 | 3841 | 1823 |
| 2042 | 0  | 518 | 14 | 1956 | 1919 | 1484 | 2197 | 2059 | 1518 | 214 | 4039 | 1921 |
| 2043 | 4  | 607 | 37 | 2015 | 1977 | 1542 | 2300 | 2124 | 1583 | 246 | 4197 | 1977 |
| 2044 | 4  | 651 | 41 | 2080 | 2035 | 1609 | 2403 | 2193 | 1650 | 268 | 4358 | 2042 |
| 2045 | 4  | 651 | 41 | 2155 | 2115 | 1667 | 2403 | 2264 | 1724 | 296 | 4496 | 2125 |
| 2046 | 4  | 651 | 41 | 2215 | 2179 | 1725 | 2403 | 2349 | 1760 | 316 | 4611 | 2182 |
| 2047 | 4  | 651 | 41 | 2239 | 2226 | 1811 | 2403 | 2368 | 1760 | 331 | 4645 | 2207 |
| 2048 | 4  | 651 | 41 | 2239 | 2226 | 1859 | 2403 | 2368 | 1760 | 331 | 4645 | 2207 |
| 2049 | 4  | 651 | 41 | 2239 | 2226 | 1859 | 2403 | 2368 | 1760 | 331 | 4645 | 2207 |
| 2050 | 4  | 651 | 41 | 2239 | 2226 | 1859 | 2403 | 2368 | 1760 | 331 | 4645 | 2207 |
| 2051 | 4  | 651 | 41 | 2239 | 2226 | 1859 | 2403 | 2368 | 1760 | 331 | 4645 | 2207 |
| 2052 | 4  | 651 | 41 | 2239 | 2226 | 1859 | 2403 | 2368 | 1760 | 331 | 4645 | 2207 |
| 2053 | 4  | 651 | 41 | 2239 | 2226 | 1859 | 2403 | 2368 | 1760 | 331 | 4645 | 2207 |
| 2054 | 4  | 651 | 41 | 2239 | 2226 | 1859 | 2403 | 2368 | 1760 | 331 | 4645 | 2207 |
| 2055 | 4  | 651 | 41 | 2239 | 2226 | 1859 | 2403 | 2368 | 1760 | 331 | 4645 | 2207 |
| 2056 | 4  | 651 | 41 | 2239 | 2226 | 1859 | 2403 | 2368 | 1760 | 331 | 4645 | 2207 |
| 2057 | 4  | 651 | 41 | 2239 | 2226 | 1859 | 2403 | 2368 | 1760 | 331 | 4645 | 2207 |
| 2058 | 4  | 651 | 41 | 2239 | 2226 | 1859 | 2403 | 2368 | 1760 | 331 | 4645 | 2207 |
| 2059 | 4  | 651 | 41 | 2239 | 2226 | 1859 | 2403 | 2368 | 1760 | 331 | 4645 | 2207 |

|      | 61 | 62  | 63 | 64   | 65   | 66   | 67   | 68   | 69   | 70  | 71   | 72   |
|------|----|-----|----|------|------|------|------|------|------|-----|------|------|
| 2060 | 4  | 651 | 41 | 2239 | 2226 | 1859 | 2403 | 2368 | 1760 | 331 | 4645 | 2207 |
| 2061 | 4  | 651 | 41 | 2239 | 2226 | 1859 | 2403 | 2368 | 1760 | 331 | 4645 | 2207 |
| 2062 | 4  | 651 | 41 | 2239 | 2226 | 1859 | 2403 | 2368 | 1760 | 331 | 4645 | 2207 |
| 2063 | 4  | 651 | 41 | 2239 | 2226 | 1859 | 2403 | 2368 | 1760 | 331 | 4645 | 2207 |
| 2064 | 4  | 651 | 41 | 2239 | 2226 | 1859 | 2403 | 2368 | 1760 | 331 | 4645 | 2207 |
| 2065 | 4  | 651 | 41 | 2239 | 2226 | 1859 | 2403 | 2368 | 1760 | 331 | 4645 | 2207 |
| 2066 | 4  | 651 | 41 | 2239 | 2226 | 1859 | 2403 | 2368 | 1760 | 331 | 4645 | 2207 |
| 2067 | 4  | 651 | 41 | 2239 | 2226 | 1859 | 2403 | 2368 | 1760 | 331 | 4645 | 2207 |
| 2068 | 4  | 651 | 41 | 2239 | 2226 | 1859 | 2403 | 2368 | 1760 | 331 | 4645 | 2207 |
| 2069 | 4  | 651 | 41 | 2239 | 2226 | 1859 | 2403 | 2368 | 1760 | 331 | 4645 | 2207 |
| 2070 | 4  | 651 | 41 | 2239 | 2226 | 1859 | 2403 | 2368 | 1760 | 331 | 4645 | 2207 |
| 2071 | 4  | 651 | 41 | 2239 | 2226 | 1859 | 2403 | 2368 | 1760 | 331 | 4645 | 2207 |
| 2072 | 4  | 651 | 41 | 2239 | 2226 | 1859 | 2403 | 2368 | 1760 | 331 | 4645 | 2207 |
| 2073 | 4  | 651 | 41 | 2239 | 2226 | 1859 | 2403 | 2368 | 1760 | 331 | 4645 | 2207 |
| 2074 | 4  | 651 | 41 | 2239 | 2226 | 1859 | 2403 | 2368 | 1760 | 331 | 4645 | 2207 |
| 2075 | 4  | 651 | 41 | 2239 | 2226 | 1859 | 2403 | 2368 | 1760 | 331 | 4645 | 2207 |
| 2076 | 4  | 651 | 41 | 2239 | 2226 | 1859 | 2403 | 2368 | 1760 | 331 | 4645 | 2207 |
| 2077 | 4  | 651 | 41 | 2239 | 2226 | 1859 | 2403 | 2368 | 1760 | 331 | 4645 | 2207 |
| 2078 | 4  | 651 | 41 | 2239 | 2226 | 1859 | 2403 | 2368 | 1760 | 331 | 4645 | 2207 |
| 2079 | 4  | 651 | 41 | 2239 | 2226 | 1859 | 2403 | 2368 | 1760 | 331 | 4645 | 2207 |
| 2080 | 4  | 651 | 41 | 2239 | 2226 | 1859 | 2403 | 2368 | 1760 | 331 | 4645 | 2207 |
| 2081 | 4  | 651 | 41 | 2239 | 2226 | 1859 | 2403 | 2368 | 1760 | 331 | 4645 | 2207 |
| 2082 | 4  | 651 | 41 | 2239 | 2226 | 1859 | 2403 | 2368 | 1760 | 331 | 4645 | 2207 |
| 2083 | 4  | 651 | 41 | 2239 | 2226 | 1859 | 2403 | 2368 | 1760 | 331 | 4645 | 2207 |
| 2084 | 4  | 651 | 41 | 2239 | 2226 | 1859 | 2403 | 2368 | 1760 | 331 | 4645 | 2207 |
| 2085 | 4  | 651 | 41 | 2239 | 2226 | 1859 | 2403 | 2368 | 1760 | 331 | 4645 | 2207 |
| 2086 | 4  | 651 | 41 | 2239 | 2226 | 1859 | 2403 | 2368 | 1760 | 331 | 4645 | 2207 |
| 2087 | 4  | 651 | 41 | 2239 | 2226 | 1859 | 2403 | 2368 | 1760 | 331 | 4645 | 2207 |
| 2088 | 4  | 651 | 41 | 2239 | 2226 | 1859 | 2403 | 2368 | 1760 | 331 | 4645 | 2207 |
| 2089 | 4  | 651 | 41 | 2239 | 2226 | 1859 | 2403 | 2368 | 1760 | 331 | 4645 | 2207 |
| 2090 | 4  | 651 | 41 | 2239 | 2226 | 1859 | 2403 | 2368 | 1760 | 331 | 4645 | 2207 |

|      | 73   | 74   | 75   | 76   | 77   | 78   | 79   | 80   | 81   | 82 | 83 | 84 |
|------|------|------|------|------|------|------|------|------|------|----|----|----|
| 2002 | 0    | 0    | 0    | 0    | 0    | 0    | 0    | 0    | 0    | 0  | 0  | 0  |
| 2003 | 0    | 0    | 0    | 0    | 0    | 0    | 0    | 0    | 0    | 0  | 0  | 0  |
| 2004 | 0    | 0    | 0    | 0    | 0    | 0    | 0    | 0    | 0    | 0  | 0  | 0  |
| 2005 | 0    | 0    | 0    | 0    | 0    | 0    | 0    | 0    | 0    | 0  | 0  | 0  |
| 2006 | 0    | 0    | 0    | 0    | 0    | 0    | 0    | 0    | 0    | 0  | 0  | 0  |
| 2007 | 0    | 0    | 0    | 0    | 0    | 0    | 0    | 0    | 0    | 0  | 0  | 0  |
| 2008 | 0    | 0    | 0    | 0    | 0    | 0    | 0    | 0    | 0    | 0  | 0  | 0  |
| 2009 | 0    | 0    | 0    | 0    | 0    | 0    | 0    | 0    | 0    | 0  | 0  | 0  |
| 2010 | 0    | 0    | 0    | 0    | 0    | 0    | 0    | 0    | 0    | 0  | 0  | 0  |
| 2011 | 0    | 0    | 0    | 0    | 0    | 0    | 0    | 0    | 0    | 0  | 0  | 0  |
| 2012 | 0    | 0    | 0    | 0    | 0    | 0    | 0    | 0    | 0    | 0  | 0  | 0  |
| 2013 | 0    | 0    | 0    | 0    | 0    | 0    | 0    | 0    | 0    | 0  | 0  | 0  |
| 2014 | 0    | 0    | 0    | 0    | 0    | 0    | 0    | 0    | 0    | 0  | 0  | 0  |
| 2015 | 0    | 0    | 0    | 0    | 0    | 0    | 0    | 0    | 0    | 0  | 0  | 0  |
| 2016 | 0    | 0    | 0    | 0    | 0    | 0    | 0    | 0    | 0    | 0  | 0  | 0  |
| 2017 | 0    | 0    | 0    | 0    | 0    | 0    | 0    | 0    | 0    | 0  | 0  | 0  |
| 2018 | 0    | 0    | 0    | 0    | 0    | 0    | 0    | 0    | 0    | 0  | 0  | 0  |
| 2019 | 0    | 0    | 0    | 0    | 0    | 0    | 0    | 0    | 0    | 0  | 0  | 0  |
| 2020 | 0    | 0    | 0    | 240  | 0    | 0    | 0    | 0    | 0    | 0  | 0  | 0  |
| 2021 | 0    | 0    | 0    | 540  | 0    | 0    | 0    | 0    | 0    | 0  | 0  | 0  |
| 2022 | 0    | 0    | 0    | 797  | 0    | 0    | 0    | 0    | 0    | 0  | 0  | 0  |
| 2023 | 0    | 0    | 0    | 1009 | 0    | 0    | 0    | 0    | 0    | 0  | 0  | 0  |
| 2024 | 0    | 0    | 0    | 1239 | 0    | 0    | 0    | 0    | 0    | 0  | 0  | 0  |
| 2025 | 233  | 233  | 0    | 1437 | 238  | 187  | 186  | 249  | 233  | 0  | 0  | 0  |
| 2026 | 523  | 426  | 0    | 1631 | 526  | 314  | 317  | 589  | 453  | 0  | 0  | 0  |
| 2027 | 779  | 648  | 0    | 1829 | 808  | 480  | 446  | 922  | 690  | 0  | 0  | 0  |
| 2028 | 1014 | 883  | 0    | 2054 | 1104 | 601  | 578  | 1256 | 959  | 0  | 0  | 0  |
| 2029 | 1183 | 1093 | 0    | 2249 | 1339 | 711  | 700  | 1529 | 1156 | 0  | 0  | 0  |
| 2030 | 1362 | 1282 | 240  | 2426 | 1546 | 856  | 826  | 1776 | 1325 | 0  | 0  | 0  |
| 2031 | 1550 | 1485 | 428  | 2615 | 1755 | 987  | 942  | 2030 | 1519 | 0  | 0  | 0  |
| 2032 | 1727 | 1659 | 619  | 2796 | 1966 | 1131 | 1040 | 2270 | 1691 | 0  | 0  | 0  |
| 2033 | 1904 | 1832 | 843  | 2977 | 2175 | 1280 | 1151 | 2495 | 1868 | 0  | 0  | 0  |
| 2034 | 2098 | 2020 | 1075 | 3151 | 2393 | 1434 | 1271 | 2742 | 2061 | 0  | 0  | 0  |
| 2035 | 2302 | 2217 | 1262 | 3319 | 2606 | 1602 | 1362 | 2979 | 2259 | 0  | 0  | 0  |
| 2036 | 2478 | 2393 | 1410 | 3470 | 2789 | 1726 | 1450 | 3192 | 2431 | 0  | 0  | 0  |
| 2037 | 2652 | 2566 | 1565 | 3641 | 2967 | 1836 | 1517 | 3399 | 2602 | 0  | 0  | 0  |
| 2038 | 2796 | 2713 | 1754 | 3770 | 3147 | 1947 | 1590 | 3584 | 2745 | 0  | 0  | 0  |
| 2039 | 2945 | 2880 | 1921 | 3969 | 3352 | 2090 | 1666 | 3798 | 2908 | 0  | 0  | 0  |
| 2040 | 3118 | 3063 | 2076 | 4140 | 3596 | 2227 | 1764 | 4027 | 3087 | 0  | 0  | 0  |
| 2041 | 3303 | 3251 | 2269 | 4351 | 3809 | 2350 | 1827 | 4229 | 3265 | 8  | 8  | 0  |
| 2042 | 3489 | 3425 | 2424 | 4507 | 4047 | 2426 | 1894 | 4472 | 3448 | 17 | 17 | 0  |
| 2043 | 3640 | 3589 | 2554 | 4530 | 4221 | 2513 | 1950 | 4657 | 3597 | 40 | 40 | 0  |
| 2044 | 3809 | 3755 | 2735 | 4530 | 4412 | 2623 | 2000 | 4854 | 3760 | 64 | 64 | 0  |
| 2045 | 3914 | 3848 | 2911 | 4530 | 4567 | 2712 | 2058 | 5006 | 3873 | 64 | 64 | 0  |
| 2046 | 3914 | 3848 | 3049 | 4530 | 4567 | 2712 | 2058 | 5006 | 3873 | 64 | 64 | 4  |
| 2047 | 3914 | 3848 | 3187 | 4530 | 4567 | 2712 | 2058 | 5006 | 3873 | 64 | 64 | 4  |
| 2048 | 3914 | 3848 | 3187 | 4530 | 4567 | 2712 | 2058 | 5006 | 3873 | 64 | 64 | 4  |
| 2049 | 3914 | 3848 | 3187 | 4530 | 4567 | 2712 | 2058 | 5006 | 3873 | 64 | 64 | 4  |
| 2050 | 3914 | 3848 | 3187 | 4530 | 4567 | 2712 | 2058 | 5006 | 3873 | 64 | 64 | 4  |
| 2051 | 3914 | 3848 | 3187 | 4530 | 4567 | 2712 | 2058 | 5006 | 3873 | 64 | 64 | 4  |
| 2052 | 3914 | 3848 | 3187 | 4530 | 4567 | 2712 | 2058 | 5006 | 3873 | 64 | 64 | 4  |
| 2053 | 3914 | 3848 | 3187 | 4530 | 4567 | 2712 | 2058 | 5006 | 3873 | 64 | 64 | 4  |
| 2054 | 3914 | 3848 | 3187 | 4530 | 4567 | 2712 | 2058 | 5006 | 3873 | 64 | 64 | 4  |
| 2055 | 3914 | 3848 | 3187 | 4530 | 4567 | 2712 | 2058 | 5006 | 3873 | 64 | 64 | 4  |
| 2056 | 3914 | 3848 | 3187 | 4530 | 4567 | 2712 | 2058 | 5006 | 3873 | 64 | 64 | 4  |
| 2057 | 3914 | 3848 | 3187 | 4530 | 4567 | 2712 | 2058 | 5006 | 3873 | 64 | 64 | 4  |
| 2058 | 3914 | 3848 | 3187 | 4530 | 4567 | 2712 | 2058 | 5006 | 3873 | 64 | 64 | 4  |
| 2059 | 3914 | 3848 | 3187 | 4530 | 4567 | 2712 | 2058 | 5006 | 3873 | 64 | 64 | 4  |

|      | 73   | 74   | 75   | 76   | 77   | 78   | 79   | 80   | 81   | 82 | 83 | 84 |
|------|------|------|------|------|------|------|------|------|------|----|----|----|
| 2060 | 3914 | 3848 | 3187 | 4530 | 4567 | 2712 | 2058 | 5006 | 3873 | 64 | 64 | 4  |
| 2061 | 3914 | 3848 | 3187 | 4530 | 4567 | 2712 | 2058 | 5006 | 3873 | 64 | 64 | 4  |
| 2062 | 3914 | 3848 | 3187 | 4530 | 4567 | 2712 | 2058 | 5006 | 3873 | 64 | 64 | 4  |
| 2063 | 3914 | 3848 | 3187 | 4530 | 4567 | 2712 | 2058 | 5006 | 3873 | 64 | 64 | 4  |
| 2064 | 3914 | 3848 | 3187 | 4530 | 4567 | 2712 | 2058 | 5006 | 3873 | 64 | 64 | 4  |
| 2065 | 3914 | 3848 | 3187 | 4530 | 4567 | 2712 | 2058 | 5006 | 3873 | 64 | 64 | 4  |
| 2066 | 3914 | 3848 | 3187 | 4530 | 4567 | 2712 | 2058 | 5006 | 3873 | 64 | 64 | 4  |
| 2067 | 3914 | 3848 | 3187 | 4530 | 4567 | 2712 | 2058 | 5006 | 3873 | 64 | 64 | 4  |
| 2068 | 3914 | 3848 | 3187 | 4530 | 4567 | 2712 | 2058 | 5006 | 3873 | 64 | 64 | 4  |
| 2069 | 3914 | 3848 | 3187 | 4530 | 4567 | 2712 | 2058 | 5006 | 3873 | 64 | 64 | 4  |
| 2070 | 3914 | 3848 | 3187 | 4530 | 4567 | 2712 | 2058 | 5006 | 3873 | 64 | 64 | 4  |
| 2071 | 3914 | 3848 | 3187 | 4530 | 4567 | 2712 | 2058 | 5006 | 3873 | 64 | 64 | 4  |
| 2072 | 3914 | 3848 | 3187 | 4530 | 4567 | 2712 | 2058 | 5006 | 3873 | 64 | 64 | 4  |
| 2073 | 3914 | 3848 | 3187 | 4530 | 4567 | 2712 | 2058 | 5006 | 3873 | 64 | 64 | 4  |
| 2074 | 3914 | 3848 | 3187 | 4530 | 4567 | 2712 | 2058 | 5006 | 3873 | 64 | 64 | 4  |
| 2075 | 3914 | 3848 | 3187 | 4530 | 4567 | 2712 | 2058 | 5006 | 3873 | 64 | 64 | 4  |
| 2076 | 3914 | 3848 | 3187 | 4530 | 4567 | 2712 | 2058 | 5006 | 3873 | 64 | 64 | 4  |
| 2077 | 3914 | 3848 | 3187 | 4530 | 4567 | 2712 | 2058 | 5006 | 3873 | 64 | 64 | 4  |
| 2078 | 3914 | 3848 | 3187 | 4530 | 4567 | 2712 | 2058 | 5006 | 3873 | 64 | 64 | 4  |
| 2079 | 3914 | 3848 | 3187 | 4530 | 4567 | 2712 | 2058 | 5006 | 3873 | 64 | 64 | 4  |
| 2080 | 3914 | 3848 | 3187 | 4530 | 4567 | 2712 | 2058 | 5006 | 3873 | 64 | 64 | 4  |
| 2081 | 3914 | 3848 | 3187 | 4530 | 4567 | 2712 | 2058 | 5006 | 3873 | 64 | 64 | 4  |
| 2082 | 3914 | 3848 | 3187 | 4530 | 4567 | 2712 | 2058 | 5006 | 3873 | 64 | 64 | 4  |
| 2083 | 3914 | 3848 | 3187 | 4530 | 4567 | 2712 | 2058 | 5006 | 3873 | 64 | 64 | 4  |
| 2084 | 3914 | 3848 | 3187 | 4530 | 4567 | 2712 | 2058 | 5006 | 3873 | 64 | 64 | 4  |
| 2085 | 3914 | 3848 | 3187 | 4530 | 4567 | 2712 | 2058 | 5006 | 3873 | 64 | 64 | 4  |
| 2086 | 3914 | 3848 | 3187 | 4530 | 4567 | 2712 | 2058 | 5006 | 3873 | 64 | 64 | 4  |
| 2087 | 3914 | 3848 | 3187 | 4530 | 4567 | 2712 | 2058 | 5006 | 3873 | 64 | 64 | 4  |
| 2088 | 3914 | 3848 | 3187 | 4530 | 4567 | 2712 | 2058 | 5006 | 3873 | 64 | 64 | 4  |
| 2089 | 3914 | 3848 | 3187 | 4530 | 4567 | 2712 | 2058 | 5006 | 3873 | 64 | 64 | 4  |
| 2090 | 3914 | 3848 | 3187 | 4530 | 4567 | 2712 | 2058 | 5006 | 3873 | 64 | 64 | 4  |

|      | 85  | 86  | 87  | 88 | 89  | 90 | 91   | 92   | 93   | 94   | 95   | 96   |
|------|-----|-----|-----|----|-----|----|------|------|------|------|------|------|
| 2002 | 0   | 0   | 0   | 0  | 0   | 0  | 0    | 0    | 0    | 0    | 0    | 0    |
| 2003 | 0   | 0   | 0   | 0  | 0   | 0  | 0    | 0    | 0    | 0    | 0    | 0    |
| 2004 | 0   | 0   | 0   | 0  | 0   | 0  | 0    | 0    | 0    | 0    | 0    | 0    |
| 2005 | 0   | 0   | 0   | 0  | 0   | 0  | 0    | 0    | 0    | 0    | 0    | 0    |
| 2006 | 0   | 0   | 0   | 0  | 0   | 0  | 0    | 0    | 0    | 0    | 0    | 0    |
| 2007 | 0   | 0   | 0   | 0  | 0   | 0  | 0    | 0    | 0    | 0    | 0    | 0    |
| 2008 | 0   | 0   | 0   | 0  | 0   | 0  | 0    | 0    | 0    | 0    | 0    | 0    |
| 2009 | 0   | 0   | 0   | 0  | 0   | 0  | 0    | 0    | 0    | 0    | 0    | 0    |
| 2010 | 0   | 0   | 0   | 0  | 0   | 0  | 0    | 0    | 0    | 0    | 0    | 0    |
| 2011 | 0   | 0   | 0   | 0  | 0   | 0  | 0    | 0    | 0    | 0    | 0    | 0    |
| 2012 | 0   | 0   | 0   | 0  | 0   | 0  | 0    | 0    | 0    | 0    | 0    | 0    |
| 2013 | 0   | 0   | 0   | 0  | 0   | 0  | 0    | 0    | 0    | 0    | 0    | 0    |
| 2014 | 0   | 0   | 0   | 0  | 0   | 0  | 0    | 0    | 0    | 0    | 0    | 0    |
| 2015 | 0   | 0   | 0   | 0  | 0   | 0  | 0    | 0    | 0    | 0    | 0    | 0    |
| 2016 | 0   | 0   | 0   | 0  | 0   | 0  | 0    | 0    | 0    | 0    | 0    | 0    |
| 2017 | 0   | 0   | 0   | 0  | 0   | 0  | 0    | 0    | 0    | 0    | 0    | 0    |
| 2018 | 0   | 0   | 0   | 0  | 0   | 0  | 0    | 0    | 0    | 0    | 0    | 0    |
| 2019 | 0   | 0   | 0   | 0  | 0   | 0  | 0    | 0    | 0    | 0    | 0    | 0    |
| 2020 | 0   | 0   | 0   | 0  | 0   | 0  | 0    | 0    | 0    | 160  | 0    | 0    |
| 2021 | 0   | 0   | 0   | 0  | 0   | 0  | 0    | 0    | 0    | 311  | 0    | 0    |
| 2022 | 0   | 0   | 0   | 0  | 0   | 0  | 0    | 0    | 0    | 436  | 0    | 0    |
| 2023 | 0   | 0   | 0   | 0  | 0   | 0  | 0    | 0    | 0    | 576  | 0    | 0    |
| 2024 | 0   | 0   | 0   | 0  | 0   | 0  | 0    | 0    | 0    | 714  | 0    | 0    |
| 2025 | 0   | 0   | 0   | 0  | 0   | 0  | 179  | 179  | 0    | 842  | 186  | 74   |
| 2026 | 0   | 0   | 0   | 0  | 0   | 0  | 316  | 306  | 0    | 953  | 336  | 136  |
| 2027 | 0   | 0   | 0   | 0  | 0   | 0  | 466  | 453  | 0    | 1057 | 500  | 208  |
| 2028 | 0   | 0   | 0   | 0  | 0   | 0  | 613  | 594  | 0    | 1157 | 666  | 292  |
| 2029 | 0   | 0   | 0   | 0  | 0   | 0  | 754  | 737  | 0    | 1233 | 826  | 377  |
| 2030 | 0   | 0   | 0   | 0  | 0   | 0  | 883  | 867  | 184  | 1295 | 939  | 466  |
| 2031 | 0   | 0   | 0   | 0  | 0   | 0  | 974  | 960  | 308  | 1380 | 1031 | 594  |
| 2032 | 0   | 0   | 0   | 0  | 0   | 0  | 1074 | 1060 | 443  | 1431 | 1133 | 686  |
| 2033 | 0   | 0   | 0   | 0  | 1   | 0  | 1149 | 1135 | 582  | 1534 | 1204 | 780  |
| 2034 | 6   | 0   | 0   | 0  | 6   | 0  | 1260 | 1246 | 708  | 1625 | 1318 | 899  |
| 2035 | 11  | 0   | 0   | 0  | 15  | 0  | 1350 | 1336 | 819  | 1680 | 1396 | 1042 |
| 2036 | 28  | 0   | 0   | 0  | 31  | 0  | 1427 | 1413 | 905  | 1749 | 1470 | 1107 |
| 2037 | 50  | 1   | 0   | 0  | 64  | 0  | 1498 | 1484 | 1008 | 1801 | 1549 | 1176 |
| 2038 | 97  | 3   | 2   | 0  | 115 | 0  | 1568 | 1554 | 1115 | 1849 | 1623 | 1249 |
| 2039 | 170 | 4   | 5   | 0  | 199 | 0  | 1636 | 1622 | 1196 | 1918 | 1720 | 1315 |
| 2040 | 216 | 6   | 7   | 0  | 316 | 0  | 1733 | 1719 | 1306 | 2021 | 1832 | 1402 |
| 2041 | 275 | 11  | 13  | 0  | 434 | 8  | 1831 | 1817 | 1414 | 2096 | 1923 | 1480 |
| 2042 | 280 | 35  | 31  | 0  | 523 | 17 | 1919 | 1905 | 1459 | 2203 | 2001 | 1519 |
| 2043 | 280 | 56  | 60  | 3  | 605 | 40 | 1981 | 1967 | 1524 | 2284 | 2077 | 1580 |
| 2044 | 280 | 104 | 102 | 3  | 693 | 64 | 2027 | 2013 | 1586 | 2395 | 2140 | 1658 |
| 2045 | 280 | 104 | 102 | 3  | 693 | 64 | 2095 | 2081 | 1650 | 2487 | 2204 | 1724 |
| 2046 | 280 | 104 | 102 | 3  | 693 | 64 | 2141 | 2127 | 1704 | 2558 | 2293 | 1777 |
| 2047 | 280 | 104 | 102 | 3  | 693 | 64 | 2227 | 2213 | 1792 | 2558 | 2334 | 1777 |
| 2048 | 280 | 104 | 102 | 3  | 693 | 64 | 2227 | 2213 | 1879 | 2558 | 2334 | 1777 |
| 2049 | 280 | 104 | 102 | 3  | 693 | 64 | 2227 | 2213 | 1879 | 2558 | 2334 | 1777 |
| 2050 | 280 | 104 | 102 | 3  | 693 | 64 | 2227 | 2213 | 1879 | 2558 | 2334 | 1777 |
| 2051 | 280 | 104 | 102 | 3  | 693 | 64 | 2227 | 2213 | 1879 | 2558 | 2334 | 1777 |
| 2052 | 280 | 104 | 102 | 3  | 693 | 64 | 2227 | 2213 | 1879 | 2558 | 2334 | 1777 |
| 2053 | 280 | 104 | 102 | 3  | 693 | 64 | 2227 | 2213 | 1879 | 2558 | 2334 | 1777 |
| 2054 | 280 | 104 | 102 | 3  | 693 | 64 | 2227 | 2213 | 1879 | 2558 | 2334 | 1777 |
| 2055 | 280 | 104 | 102 | 3  | 693 | 64 | 2227 | 2213 | 1879 | 2558 | 2334 | 1777 |
| 2056 | 280 | 104 | 102 | 3  | 693 | 64 | 2227 | 2213 | 1879 | 2558 | 2334 | 1777 |
| 2057 | 280 | 104 | 102 | 3  | 693 | 64 | 2227 | 2213 | 1879 | 2558 | 2334 | 1777 |
| 2058 | 280 | 104 | 102 | 3  | 693 | 64 | 2227 | 2213 | 1879 | 2558 | 2334 | 1777 |
| 2059 | 280 | 104 | 102 | 3  | 693 | 64 | 2227 | 2213 | 1879 | 2558 | 2334 | 1777 |

|      | 85  | 86  | 87  | 88 | 89  | 90 | 91   | 92   | 93   | 94   | 95   | 96   |
|------|-----|-----|-----|----|-----|----|------|------|------|------|------|------|
| 2060 | 280 | 104 | 102 | 3  | 693 | 64 | 2227 | 2213 | 1879 | 2558 | 2334 | 1777 |
| 2061 | 280 | 104 | 102 | 3  | 693 | 64 | 2227 | 2213 | 1879 | 2558 | 2334 | 1777 |
| 2062 | 280 | 104 | 102 | 3  | 693 | 64 | 2227 | 2213 | 1879 | 2558 | 2334 | 1777 |
| 2063 | 280 | 104 | 102 | 3  | 693 | 64 | 2227 | 2213 | 1879 | 2558 | 2334 | 1777 |
| 2064 | 280 | 104 | 102 | 3  | 693 | 64 | 2227 | 2213 | 1879 | 2558 | 2334 | 1777 |
| 2065 | 280 | 104 | 102 | 3  | 693 | 64 | 2227 | 2213 | 1879 | 2558 | 2334 | 1777 |
| 2066 | 280 | 104 | 102 | 3  | 693 | 64 | 2227 | 2213 | 1879 | 2558 | 2334 | 1777 |
| 2067 | 280 | 104 | 102 | 3  | 693 | 64 | 2227 | 2213 | 1879 | 2558 | 2334 | 1777 |
| 2068 | 280 | 104 | 102 | 3  | 693 | 64 | 2227 | 2213 | 1879 | 2558 | 2334 | 1777 |
| 2069 | 280 | 104 | 102 | 3  | 693 | 64 | 2227 | 2213 | 1879 | 2558 | 2334 | 1777 |
| 2070 | 280 | 104 | 102 | 3  | 693 | 64 | 2227 | 2213 | 1879 | 2558 | 2334 | 1777 |
| 2071 | 280 | 104 | 102 | 3  | 693 | 64 | 2227 | 2213 | 1879 | 2558 | 2334 | 1777 |
| 2072 | 280 | 104 | 102 | 3  | 693 | 64 | 2227 | 2213 | 1879 | 2558 | 2334 | 1777 |
| 2073 | 280 | 104 | 102 | 3  | 693 | 64 | 2227 | 2213 | 1879 | 2558 | 2334 | 1777 |
| 2074 | 280 | 104 | 102 | 3  | 693 | 64 | 2227 | 2213 | 1879 | 2558 | 2334 | 1777 |
| 2075 | 280 | 104 | 102 | 3  | 693 | 64 | 2227 | 2213 | 1879 | 2558 | 2334 | 1777 |
| 2076 | 280 | 104 | 102 | 3  | 693 | 64 | 2227 | 2213 | 1879 | 2558 | 2334 | 1777 |
| 2077 | 280 | 104 | 102 | 3  | 693 | 64 | 2227 | 2213 | 1879 | 2558 | 2334 | 1777 |
| 2078 | 280 | 104 | 102 | 3  | 693 | 64 | 2227 | 2213 | 1879 | 2558 | 2334 | 1777 |
| 2079 | 280 | 104 | 102 | 3  | 693 | 64 | 2227 | 2213 | 1879 | 2558 | 2334 | 1777 |
| 2080 | 280 | 104 | 102 | 3  | 693 | 64 | 2227 | 2213 | 1879 | 2558 | 2334 | 1777 |
| 2081 | 280 | 104 | 102 | 3  | 693 | 64 | 2227 | 2213 | 1879 | 2558 | 2334 | 1777 |
| 2082 | 280 | 104 | 102 | 3  | 693 | 64 | 2227 | 2213 | 1879 | 2558 | 2334 | 1777 |
| 2083 | 280 | 104 | 102 | 3  | 693 | 64 | 2227 | 2213 | 1879 | 2558 | 2334 | 1777 |
| 2084 | 280 | 104 | 102 | 3  | 693 | 64 | 2227 | 2213 | 1879 | 2558 | 2334 | 1777 |
| 2085 | 280 | 104 | 102 | 3  | 693 | 64 | 2227 | 2213 | 1879 | 2558 | 2334 | 1777 |
| 2086 | 280 | 104 | 102 | 3  | 693 | 64 | 2227 | 2213 | 1879 | 2558 | 2334 | 1777 |
| 2087 | 280 | 104 | 102 | 3  | 693 | 64 | 2227 | 2213 | 1879 | 2558 | 2334 | 1777 |
| 2088 | 280 | 104 | 102 | 3  | 693 | 64 | 2227 | 2213 | 1879 | 2558 | 2334 | 1777 |
| 2089 | 280 | 104 | 102 | 3  | 693 | 64 | 2227 | 2213 | 1879 | 2558 | 2334 | 1777 |
| 2090 | 280 | 104 | 102 | 3  | 693 | 64 | 2227 | 2213 | 1879 | 2558 | 2334 | 1777 |



|      | 97  | 98   | 99   | 100  | 101  | 102  | 103  | 104  | 105  | 106  | 107  | 108  |
|------|-----|------|------|------|------|------|------|------|------|------|------|------|
| 2002 | 0   | 0    | 0    | 0    | 0    | 0    | 0    | 0    | 0    | 0    | 0    | 0    |
| 2003 | 0   | 0    | 0    | 0    | 0    | 0    | 0    | 0    | 0    | 0    | 0    | 0    |
| 2004 | 0   | 0    | 0    | 0    | 0    | 0    | 0    | 0    | 0    | 0    | 0    | 0    |
| 2005 | 0   | 0    | 0    | 0    | 0    | 0    | 0    | 0    | 0    | 0    | 0    | 0    |
| 2006 | 0   | 0    | 0    | 0    | 0    | 0    | 0    | 0    | 0    | 0    | 0    | 0    |
| 2007 | 0   | 0    | 0    | 0    | 0    | 0    | 0    | 0    | 0    | 0    | 0    | 0    |
| 2008 | 0   | 0    | 0    | 0    | 0    | 0    | 0    | 0    | 0    | 0    | 0    | 0    |
| 2009 | 0   | 0    | 0    | 0    | 0    | 0    | 0    | 0    | 0    | 0    | 0    | 0    |
| 2010 | 0   | 0    | 0    | 0    | 0    | 0    | 0    | 0    | 0    | 0    | 0    | 0    |
| 2011 | 0   | 0    | 0    | 0    | 0    | 0    | 0    | 0    | 0    | 0    | 0    | 0    |
| 2012 | 0   | 0    | 0    | 0    | 0    | 0    | 0    | 0    | 0    | 0    | 0    | 0    |
| 2013 | 0   | 0    | 0    | 0    | 0    | 0    | 0    | 0    | 0    | 0    | 0    | 0    |
| 2014 | 0   | 0    | 0    | 0    | 0    | 0    | 0    | 0    | 0    | 0    | 0    | 0    |
| 2015 | 0   | 0    | 0    | 0    | 0    | 0    | 0    | 0    | 0    | 0    | 0    | 0    |
| 2016 | 0   | 0    | 0    | 0    | 0    | 0    | 0    | 0    | 0    | 0    | 0    | 0    |
| 2017 | 0   | 0    | 0    | 0    | 0    | 0    | 0    | 0    | 0    | 0    | 0    | 0    |
| 2018 | 0   | 0    | 0    | 0    | 0    | 0    | 0    | 0    | 0    | 0    | 0    | 0    |
| 2019 | 0   | 0    | 0    | 0    | 0    | 0    | 0    | 0    | 0    | 0    | 0    | 0    |
| 2020 | 0   | 0    | 0    | 0    | 0    | 0    | 240  | 0    | 0    | 0    | 0    | 0    |
| 2021 | 0   | 0    | 0    | 0    | 0    | 0    | 484  | 0    | 0    | 0    | 0    | 0    |
| 2022 | 0   | 0    | 0    | 0    | 0    | 0    | 715  | 0    | 0    | 0    | 0    | 0    |
| 2023 | 0   | 0    | 0    | 0    | 0    | 0    | 923  | 0    | 0    | 0    | 0    | 0    |
| 2024 | 0   | 0    | 0    | 0    | 0    | 0    | 1151 | 0    | 0    | 0    | 0    | 0    |
| 2025 | 6   | 246  | 179  | 233  | 233  | 0    | 1356 | 238  | 187  | 186  | 249  | 233  |
| 2026 | 6   | 528  | 307  | 449  | 424  | 0    | 1552 | 488  | 305  | 313  | 542  | 432  |
| 2027 | 6   | 808  | 454  | 670  | 639  | 0    | 1747 | 737  | 458  | 443  | 833  | 650  |
| 2028 | 19  | 1095 | 595  | 902  | 866  | 0    | 1974 | 1005 | 569  | 572  | 1134 | 881  |
| 2029 | 22  | 1342 | 739  | 1099 | 1067 | 0    | 2175 | 1240 | 677  | 697  | 1413 | 1085 |
| 2030 | 24  | 1573 | 868  | 1280 | 1246 | 240  | 2347 | 1465 | 815  | 823  | 1667 | 1263 |
| 2031 | 34  | 1799 | 961  | 1482 | 1449 | 428  | 2550 | 1692 | 951  | 940  | 1928 | 1467 |
| 2032 | 40  | 2005 | 1061 | 1655 | 1624 | 612  | 2736 | 1898 | 1073 | 1038 | 2170 | 1642 |
| 2033 | 42  | 2208 | 1136 | 1831 | 1800 | 814  | 2918 | 2100 | 1219 | 1146 | 2398 | 1818 |
| 2034 | 50  | 2451 | 1247 | 2019 | 1988 | 1020 | 3069 | 2313 | 1380 | 1262 | 2656 | 2006 |
| 2035 | 60  | 2677 | 1337 | 2215 | 2184 | 1193 | 3236 | 2527 | 1551 | 1357 | 2901 | 2202 |
| 2036 | 76  | 2843 | 1414 | 2384 | 2353 | 1343 | 3407 | 2715 | 1677 | 1449 | 3125 | 2371 |
| 2037 | 98  | 3015 | 1485 | 2563 | 2532 | 1508 | 3560 | 2894 | 1795 | 1519 | 3336 | 2550 |
| 2038 | 113 | 3169 | 1555 | 2712 | 2681 | 1689 | 3692 | 3073 | 1905 | 1592 | 3532 | 2699 |
| 2039 | 131 | 3336 | 1623 | 2862 | 2831 | 1853 | 3869 | 3275 | 2052 | 1660 | 3737 | 2849 |
| 2040 | 167 | 3547 | 1720 | 3043 | 3012 | 2006 | 4040 | 3512 | 2183 | 1758 | 3972 | 3030 |
| 2041 | 194 | 3721 | 1818 | 3241 | 3210 | 2194 | 4223 | 3731 | 2324 | 1827 | 4195 | 3228 |
| 2042 | 219 | 3910 | 1906 | 3421 | 3390 | 2340 | 4401 | 3968 | 2399 | 1888 | 4439 | 3408 |
| 2043 | 251 | 4076 | 1968 | 3563 | 3532 | 2467 | 4507 | 4137 | 2496 | 1942 | 4617 | 3550 |
| 2044 | 276 | 4214 | 2014 | 3724 | 3693 | 2633 | 4507 | 4322 | 2598 | 1989 | 4826 | 3711 |
| 2045 | 309 | 4328 | 2082 | 3838 | 3807 | 2799 | 4507 | 4489 | 2702 | 2047 | 4981 | 3825 |
| 2046 | 336 | 4437 | 2128 | 3838 | 3807 | 2931 | 4507 | 4489 | 2702 | 2047 | 4981 | 3825 |
| 2047 | 370 | 4567 | 2214 | 3838 | 3807 | 3079 | 4507 | 4489 | 2702 | 2047 | 4981 | 3825 |
| 2048 | 370 | 4567 | 2214 | 3838 | 3807 | 3116 | 4507 | 4489 | 2702 | 2047 | 4981 | 3825 |
| 2049 | 370 | 4567 | 2214 | 3838 | 3807 | 3116 | 4507 | 4489 | 2702 | 2047 | 4981 | 3825 |
| 2050 | 370 | 4567 | 2214 | 3838 | 3807 | 3116 | 4507 | 4489 | 2702 | 2047 | 4981 | 3825 |
| 2051 | 370 | 4567 | 2214 | 3838 | 3807 | 3116 | 4507 | 4489 | 2702 | 2047 | 4981 | 3825 |
| 2052 | 370 | 4567 | 2214 | 3838 | 3807 | 3116 | 4507 | 4489 | 2702 | 2047 | 4981 | 3825 |
| 2053 | 370 | 4567 | 2214 | 3838 | 3807 | 3116 | 4507 | 4489 | 2702 | 2047 | 4981 | 3825 |
| 2054 | 370 | 4567 | 2214 | 3838 | 3807 | 3116 | 4507 | 4489 | 2702 | 2047 | 4981 | 3825 |
| 2055 | 370 | 4567 | 2214 | 3838 | 3807 | 3116 | 4507 | 4489 | 2702 | 2047 | 4981 | 3825 |
| 2056 | 370 | 4567 | 2214 | 3838 | 3807 | 3116 | 4507 | 4489 | 2702 | 2047 | 4981 | 3825 |
| 2057 | 370 | 4567 | 2214 | 3838 | 3807 | 3116 | 4507 | 4489 | 2702 | 2047 | 4981 | 3825 |
| 2058 | 370 | 4567 | 2214 | 3838 | 3807 | 3116 | 4507 | 4489 | 2702 | 2047 | 4981 | 3825 |
| 2059 | 370 | 4567 | 2214 | 3838 | 3807 | 3116 | 4507 | 4489 | 2702 | 2047 | 4981 | 3825 |

|      | 97  | 98   | 99   | 100  | 101  | 102  | 103  | 104  | 105  | 106  | 107  | 108  |
|------|-----|------|------|------|------|------|------|------|------|------|------|------|
| 2060 | 370 | 4567 | 2214 | 3838 | 3807 | 3116 | 4507 | 4489 | 2702 | 2047 | 4981 | 3825 |
| 2061 | 370 | 4567 | 2214 | 3838 | 3807 | 3116 | 4507 | 4489 | 2702 | 2047 | 4981 | 3825 |
| 2062 | 370 | 4567 | 2214 | 3838 | 3807 | 3116 | 4507 | 4489 | 2702 | 2047 | 4981 | 3825 |
| 2063 | 370 | 4567 | 2214 | 3838 | 3807 | 3116 | 4507 | 4489 | 2702 | 2047 | 4981 | 3825 |
| 2064 | 370 | 4567 | 2214 | 3838 | 3807 | 3116 | 4507 | 4489 | 2702 | 2047 | 4981 | 3825 |
| 2065 | 370 | 4567 | 2214 | 3838 | 3807 | 3116 | 4507 | 4489 | 2702 | 2047 | 4981 | 3825 |
| 2066 | 370 | 4567 | 2214 | 3838 | 3807 | 3116 | 4507 | 4489 | 2702 | 2047 | 4981 | 3825 |
| 2067 | 370 | 4567 | 2214 | 3838 | 3807 | 3116 | 4507 | 4489 | 2702 | 2047 | 4981 | 3825 |
| 2068 | 370 | 4567 | 2214 | 3838 | 3807 | 3116 | 4507 | 4489 | 2702 | 2047 | 4981 | 3825 |
| 2069 | 370 | 4567 | 2214 | 3838 | 3807 | 3116 | 4507 | 4489 | 2702 | 2047 | 4981 | 3825 |
| 2070 | 370 | 4567 | 2214 | 3838 | 3807 | 3116 | 4507 | 4489 | 2702 | 2047 | 4981 | 3825 |
| 2071 | 370 | 4567 | 2214 | 3838 | 3807 | 3116 | 4507 | 4489 | 2702 | 2047 | 4981 | 3825 |
| 2072 | 370 | 4567 | 2214 | 3838 | 3807 | 3116 | 4507 | 4489 | 2702 | 2047 | 4981 | 3825 |
| 2073 | 370 | 4567 | 2214 | 3838 | 3807 | 3116 | 4507 | 4489 | 2702 | 2047 | 4981 | 3825 |
| 2074 | 370 | 4567 | 2214 | 3838 | 3807 | 3116 | 4507 | 4489 | 2702 | 2047 | 4981 | 3825 |
| 2075 | 370 | 4567 | 2214 | 3838 | 3807 | 3116 | 4507 | 4489 | 2702 | 2047 | 4981 | 3825 |
| 2076 | 370 | 4567 | 2214 | 3838 | 3807 | 3116 | 4507 | 4489 | 2702 | 2047 | 4981 | 3825 |
| 2077 | 370 | 4567 | 2214 | 3838 | 3807 | 3116 | 4507 | 4489 | 2702 | 2047 | 4981 | 3825 |
| 2078 | 370 | 4567 | 2214 | 3838 | 3807 | 3116 | 4507 | 4489 | 2702 | 2047 | 4981 | 3825 |
| 2079 | 370 | 4567 | 2214 | 3838 | 3807 | 3116 | 4507 | 4489 | 2702 | 2047 | 4981 | 3825 |
| 2080 | 370 | 4567 | 2214 | 3838 | 3807 | 3116 | 4507 | 4489 | 2702 | 2047 | 4981 | 3825 |
| 2081 | 370 | 4567 | 2214 | 3838 | 3807 | 3116 | 4507 | 4489 | 2702 | 2047 | 4981 | 3825 |
| 2082 | 370 | 4567 | 2214 | 3838 | 3807 | 3116 | 4507 | 4489 | 2702 | 2047 | 4981 | 3825 |
| 2083 | 370 | 4567 | 2214 | 3838 | 3807 | 3116 | 4507 | 4489 | 2702 | 2047 | 4981 | 3825 |
| 2084 | 370 | 4567 | 2214 | 3838 | 3807 | 3116 | 4507 | 4489 | 2702 | 2047 | 4981 | 3825 |
| 2085 | 370 | 4567 | 2214 | 3838 | 3807 | 3116 | 4507 | 4489 | 2702 | 2047 | 4981 | 3825 |
| 2086 | 370 | 4567 | 2214 | 3838 | 3807 | 3116 | 4507 | 4489 | 2702 | 2047 | 4981 | 3825 |
| 2087 | 370 | 4567 | 2214 | 3838 | 3807 | 3116 | 4507 | 4489 | 2702 | 2047 | 4981 | 3825 |
| 2088 | 370 | 4567 | 2214 | 3838 | 3807 | 3116 | 4507 | 4489 | 2702 | 2047 | 4981 | 3825 |
| 2089 | 370 | 4567 | 2214 | 3838 | 3807 | 3116 | 4507 | 4489 | 2702 | 2047 | 4981 | 3825 |
| 2090 | 370 | 4567 | 2214 | 3838 | 3807 | 3116 | 4507 | 4489 | 2702 | 2047 | 4981 | 3825 |

|      | 109 | 110 | 111 | 112 | 113 | 114 | 115 | 116 | 117 | 118  | 119  | 120  |
|------|-----|-----|-----|-----|-----|-----|-----|-----|-----|------|------|------|
| 2002 | 0   | 0   | 0   | 0   | 0   | 0   | 0   | 0   | 0   | 0    | 0    | 0    |
| 2003 | 0   | 0   | 0   | 0   | 0   | 0   | 0   | 0   | 0   | 0    | 0    | 0    |
| 2004 | 0   | 0   | 0   | 0   | 0   | 0   | 0   | 0   | 0   | 0    | 0    | 0    |
| 2005 | 0   | 0   | 0   | 0   | 0   | 0   | 0   | 0   | 0   | 0    | 0    | 0    |
| 2006 | 0   | 0   | 0   | 0   | 0   | 0   | 0   | 0   | 0   | 0    | 0    | 0    |
| 2007 | 0   | 0   | 0   | 0   | 0   | 0   | 0   | 0   | 0   | 0    | 0    | 0    |
| 2008 | 0   | 0   | 0   | 0   | 0   | 0   | 0   | 0   | 0   | 0    | 0    | 0    |
| 2009 | 0   | 0   | 0   | 0   | 0   | 0   | 0   | 0   | 0   | 0    | 0    | 0    |
| 2010 | 0   | 0   | 0   | 0   | 0   | 0   | 0   | 0   | 0   | 0    | 0    | 0    |
| 2011 | 0   | 0   | 0   | 0   | 0   | 0   | 0   | 0   | 0   | 0    | 0    | 0    |
| 2012 | 0   | 0   | 0   | 0   | 0   | 0   | 0   | 0   | 0   | 0    | 0    | 0    |
| 2013 | 0   | 0   | 0   | 0   | 0   | 0   | 0   | 0   | 0   | 0    | 0    | 0    |
| 2014 | 0   | 0   | 0   | 0   | 0   | 0   | 0   | 0   | 0   | 0    | 0    | 0    |
| 2015 | 0   | 0   | 0   | 0   | 0   | 0   | 0   | 0   | 0   | 0    | 0    | 0    |
| 2016 | 0   | 0   | 0   | 0   | 0   | 0   | 0   | 0   | 0   | 0    | 0    | 0    |
| 2017 | 0   | 0   | 0   | 0   | 0   | 0   | 0   | 0   | 0   | 0    | 0    | 0    |
| 2018 | 0   | 0   | 0   | 0   | 0   | 0   | 0   | 0   | 0   | 0    | 0    | 0    |
| 2019 | 0   | 0   | 0   | 0   | 0   | 0   | 0   | 0   | 0   | 0    | 0    | 0    |
| 2020 | 0   | 0   | 0   | 0   | 0   | 0   | 0   | 0   | 0   | 0    | 0    | 0    |
| 2021 | 0   | 0   | 0   | 0   | 0   | 0   | 0   | 0   | 0   | 0    | 0    | 0    |
| 2022 | 0   | 0   | 0   | 0   | 0   | 0   | 0   | 0   | 0   | 0    | 0    | 0    |
| 2023 | 0   | 0   | 0   | 0   | 0   | 0   | 0   | 0   | 0   | 0    | 0    | 0    |
| 2024 | 0   | 0   | 0   | 0   | 0   | 0   | 0   | 0   | 0   | 0    | 0    | 0    |
| 2025 | 0   | 0   | 0   | 0   | 0   | 0   | 0   | 0   | 0   | 179  | 179  | 0    |
| 2026 | 0   | 0   | 0   | 0   | 0   | 0   | 0   | 0   | 0   | 333  | 333  | 0    |
| 2027 | 0   | 0   | 0   | 0   | 0   | 0   | 0   | 0   | 0   | 499  | 499  | 0    |
| 2028 | 0   | 0   | 0   | 0   | 0   | 0   | 0   | 0   | 0   | 629  | 629  | 0    |
| 2029 | 0   | 0   | 0   | 0   | 0   | 0   | 0   | 0   | 0   | 766  | 764  | 0    |
| 2030 | 0   | 0   | 0   | 0   | 0   | 0   | 0   | 0   | 0   | 886  | 876  | 184  |
| 2031 | 0   | 0   | 0   | 0   | 0   | 0   | 0   | 0   | 0   | 960  | 951  | 333  |
| 2032 | 0   | 0   | 0   | 1   | 0   | 0   | 0   | 7   | 0   | 1033 | 1033 | 472  |
| 2033 | 0   | 0   | 0   | 8   | 0   | 0   | 0   | 12  | 0   | 1104 | 1106 | 593  |
| 2034 | 0   | 0   | 0   | 28  | 0   | 0   | 0   | 51  | 0   | 1204 | 1209 | 712  |
| 2035 | 0   | 0   | 0   | 33  | 0   | 0   | 0   | 113 | 0   | 1292 | 1297 | 803  |
| 2036 | 3   | 1   | 0   | 84  | 2   | 0   | 0   | 218 | 1   | 1351 | 1368 | 906  |
| 2037 | 5   | 3   | 0   | 119 | 4   | 1   | 0   | 294 | 3   | 1428 | 1445 | 996  |
| 2038 | 10  | 8   | 0   | 177 | 12  | 3   | 0   | 415 | 8   | 1490 | 1515 | 1085 |
| 2039 | 24  | 24  | 0   | 255 | 30  | 13  | 0   | 513 | 18  | 1576 | 1602 | 1169 |
| 2040 | 37  | 37  | 0   | 292 | 57  | 41  | 1   | 615 | 43  | 1640 | 1667 | 1283 |
| 2041 | 73  | 77  | 0   | 322 | 84  | 79  | 1   | 743 | 85  | 1720 | 1747 | 1385 |
| 2042 | 108 | 108 | 1   | 322 | 139 | 135 | 3   | 867 | 119 | 1768 | 1795 | 1421 |
| 2043 | 112 | 110 | 5   | 322 | 139 | 142 | 3   | 879 | 122 | 1809 | 1837 | 1486 |
| 2044 | 112 | 110 | 40  | 322 | 139 | 142 | 3   | 879 | 122 | 1850 | 1883 | 1545 |
| 2045 | 112 | 110 | 41  | 322 | 139 | 142 | 3   | 879 | 122 | 1926 | 1936 | 1585 |
| 2046 | 112 | 110 | 41  | 322 | 139 | 142 | 3   | 879 | 122 | 1994 | 1983 | 1631 |
| 2047 | 112 | 110 | 41  | 322 | 139 | 142 | 3   | 879 | 122 | 2064 | 2076 | 1696 |
| 2048 | 112 | 110 | 41  | 322 | 139 | 142 | 3   | 879 | 122 | 2131 | 2139 | 1696 |
| 2049 | 112 | 110 | 41  | 322 | 139 | 142 | 3   | 879 | 122 | 2131 | 2139 | 1696 |
| 2050 | 112 | 110 | 41  | 322 | 139 | 142 | 3   | 879 | 122 | 2131 | 2139 | 1696 |
| 2051 | 112 | 110 | 41  | 322 | 139 | 142 | 3   | 879 | 122 | 2131 | 2139 | 1696 |
| 2052 | 112 | 110 | 41  | 322 | 139 | 142 | 3   | 879 | 122 | 2131 | 2139 | 1696 |
| 2053 | 112 | 110 | 41  | 322 | 139 | 142 | 3   | 879 | 122 | 2131 | 2139 | 1696 |
| 2054 | 112 | 110 | 41  | 322 | 139 | 142 | 3   | 879 | 122 | 2131 | 2139 | 1696 |
| 2055 | 112 | 110 | 41  | 322 | 139 | 142 | 3   | 879 | 122 | 2131 | 2139 | 1696 |
| 2056 | 112 | 110 | 41  | 322 | 139 | 142 | 3   | 879 | 122 | 2131 | 2139 | 1696 |
| 2057 | 112 | 110 | 41  | 322 | 139 | 142 | 3   | 879 | 122 | 2131 | 2139 | 1696 |
| 2058 | 112 | 110 | 41  | 322 | 139 | 142 | 3   | 879 | 122 | 2131 | 2139 | 1696 |
| 2059 | 112 | 110 | 41  | 322 | 139 | 142 | 3   | 879 | 122 | 2131 | 2139 | 1696 |

|      | 109 | 110 | 111 | 112 | 113 | 114 | 115 | 116 | 117 | 118  | 119  | 120  |
|------|-----|-----|-----|-----|-----|-----|-----|-----|-----|------|------|------|
| 2060 | 112 | 110 | 41  | 322 | 139 | 142 | 3   | 879 | 122 | 2131 | 2139 | 1696 |
| 2061 | 112 | 110 | 41  | 322 | 139 | 142 | 3   | 879 | 122 | 2131 | 2139 | 1696 |
| 2062 | 112 | 110 | 41  | 322 | 139 | 142 | 3   | 879 | 122 | 2131 | 2139 | 1696 |
| 2063 | 112 | 110 | 41  | 322 | 139 | 142 | 3   | 879 | 122 | 2131 | 2139 | 1696 |
| 2064 | 112 | 110 | 41  | 322 | 139 | 142 | 3   | 879 | 122 | 2131 | 2139 | 1696 |
| 2065 | 112 | 110 | 41  | 322 | 139 | 142 | 3   | 879 | 122 | 2131 | 2139 | 1696 |
| 2066 | 112 | 110 | 41  | 322 | 139 | 142 | 3   | 879 | 122 | 2131 | 2139 | 1696 |
| 2067 | 112 | 110 | 41  | 322 | 139 | 142 | 3   | 879 | 122 | 2131 | 2139 | 1696 |
| 2068 | 112 | 110 | 41  | 322 | 139 | 142 | 3   | 879 | 122 | 2131 | 2139 | 1696 |
| 2069 | 112 | 110 | 41  | 322 | 139 | 142 | 3   | 879 | 122 | 2131 | 2139 | 1696 |
| 2070 | 112 | 110 | 41  | 322 | 139 | 142 | 3   | 879 | 122 | 2131 | 2139 | 1696 |
| 2071 | 112 | 110 | 41  | 322 | 139 | 142 | 3   | 879 | 122 | 2131 | 2139 | 1696 |
| 2072 | 112 | 110 | 41  | 322 | 139 | 142 | 3   | 879 | 122 | 2131 | 2139 | 1696 |
| 2073 | 112 | 110 | 41  | 322 | 139 | 142 | 3   | 879 | 122 | 2131 | 2139 | 1696 |
| 2074 | 112 | 110 | 41  | 322 | 139 | 142 | 3   | 879 | 122 | 2131 | 2139 | 1696 |
| 2075 | 112 | 110 | 41  | 322 | 139 | 142 | 3   | 879 | 122 | 2131 | 2139 | 1696 |
| 2076 | 112 | 110 | 41  | 322 | 139 | 142 | 3   | 879 | 122 | 2131 | 2139 | 1696 |
| 2077 | 112 | 110 | 41  | 322 | 139 | 142 | 3   | 879 | 122 | 2131 | 2139 | 1696 |
| 2078 | 112 | 110 | 41  | 322 | 139 | 142 | 3   | 879 | 122 | 2131 | 2139 | 1696 |
| 2079 | 112 | 110 | 41  | 322 | 139 | 142 | 3   | 879 | 122 | 2131 | 2139 | 1696 |
| 2080 | 112 | 110 | 41  | 322 | 139 | 142 | 3   | 879 | 122 | 2131 | 2139 | 1696 |
| 2081 | 112 | 110 | 41  | 322 | 139 | 142 | 3   | 879 | 122 | 2131 | 2139 | 1696 |
| 2082 | 112 | 110 | 41  | 322 | 139 | 142 | 3   | 879 | 122 | 2131 | 2139 | 1696 |
| 2083 | 112 | 110 | 41  | 322 | 139 | 142 | 3   | 879 | 122 | 2131 | 2139 | 1696 |
| 2084 | 112 | 110 | 41  | 322 | 139 | 142 | 3   | 879 | 122 | 2131 | 2139 | 1696 |
| 2085 | 112 | 110 | 41  | 322 | 139 | 142 | 3   | 879 | 122 | 2131 | 2139 | 1696 |
| 2086 | 112 | 110 | 41  | 322 | 139 | 142 | 3   | 879 | 122 | 2131 | 2139 | 1696 |
| 2087 | 112 | 110 | 41  | 322 | 139 | 142 | 3   | 879 | 122 | 2131 | 2139 | 1696 |
| 2088 | 112 | 110 | 41  | 322 | 139 | 142 | 3   | 879 | 122 | 2131 | 2139 | 1696 |
| 2089 | 112 | 110 | 41  | 322 | 139 | 142 | 3   | 879 | 122 | 2131 | 2139 | 1696 |
| 2090 | 112 | 110 | 41  | 322 | 139 | 142 | 3   | 879 | 122 | 2131 | 2139 | 1696 |

|      | 121  | 122  | 123  | 124 | 125  | 126  | 127  | 128  | 129  | 130  | 131  | 132  |
|------|------|------|------|-----|------|------|------|------|------|------|------|------|
| 2002 | 0    | 0    | 0    | 0   | 0    | 0    | 0    | 0    | 0    | 0    | 0    | 0    |
| 2003 | 0    | 0    | 0    | 0   | 0    | 0    | 0    | 0    | 0    | 0    | 0    | 0    |
| 2004 | 0    | 0    | 0    | 0   | 0    | 0    | 0    | 0    | 0    | 0    | 0    | 0    |
| 2005 | 0    | 0    | 0    | 0   | 0    | 0    | 0    | 0    | 0    | 0    | 0    | 0    |
| 2006 | 0    | 0    | 0    | 0   | 0    | 0    | 0    | 0    | 0    | 0    | 0    | 0    |
| 2007 | 0    | 0    | 0    | 0   | 0    | 0    | 0    | 0    | 0    | 0    | 0    | 0    |
| 2008 | 0    | 0    | 0    | 0   | 0    | 0    | 0    | 0    | 0    | 0    | 0    | 0    |
| 2009 | 0    | 0    | 0    | 0   | 0    | 0    | 0    | 0    | 0    | 0    | 0    | 0    |
| 2010 | 0    | 0    | 0    | 0   | 0    | 0    | 0    | 0    | 0    | 0    | 0    | 0    |
| 2011 | 0    | 0    | 0    | 0   | 0    | 0    | 0    | 0    | 0    | 0    | 0    | 0    |
| 2012 | 0    | 0    | 0    | 0   | 0    | 0    | 0    | 0    | 0    | 0    | 0    | 0    |
| 2013 | 0    | 0    | 0    | 0   | 0    | 0    | 0    | 0    | 0    | 0    | 0    | 0    |
| 2014 | 0    | 0    | 0    | 0   | 0    | 0    | 0    | 0    | 0    | 0    | 0    | 0    |
| 2015 | 0    | 0    | 0    | 0   | 0    | 0    | 0    | 0    | 0    | 0    | 0    | 0    |
| 2016 | 0    | 0    | 0    | 0   | 0    | 0    | 0    | 0    | 0    | 0    | 0    | 0    |
| 2017 | 0    | 0    | 0    | 0   | 0    | 0    | 0    | 0    | 0    | 0    | 0    | 0    |
| 2018 | 0    | 0    | 0    | 0   | 0    | 0    | 0    | 0    | 0    | 0    | 0    | 0    |
| 2019 | 0    | 0    | 0    | 0   | 0    | 0    | 0    | 0    | 0    | 0    | 0    | 0    |
| 2020 | 160  | 0    | 0    | 0   | 0    | 0    | 0    | 0    | 0    | 240  | 0    | 0    |
| 2021 | 319  | 0    | 0    | 0   | 0    | 0    | 0    | 0    | 0    | 472  | 0    | 0    |
| 2022 | 458  | 0    | 0    | 0   | 0    | 0    | 0    | 0    | 0    | 692  | 0    | 0    |
| 2023 | 595  | 0    | 0    | 0   | 0    | 0    | 0    | 0    | 0    | 893  | 0    | 0    |
| 2024 | 716  | 0    | 0    | 0   | 0    | 0    | 0    | 0    | 0    | 1121 | 0    | 0    |
| 2025 | 834  | 186  | 74   | 6   | 246  | 179  | 233  | 233  | 0    | 1309 | 238  | 187  |
| 2026 | 929  | 349  | 155  | 12  | 466  | 333  | 443  | 443  | 0    | 1510 | 471  | 321  |
| 2027 | 1022 | 500  | 240  | 15  | 707  | 499  | 663  | 668  | 0    | 1700 | 711  | 486  |
| 2028 | 1106 | 614  | 326  | 24  | 915  | 629  | 864  | 869  | 0    | 1906 | 939  | 601  |
| 2029 | 1171 | 737  | 420  | 26  | 1108 | 761  | 1034 | 1051 | 0    | 2085 | 1155 | 707  |
| 2030 | 1233 | 837  | 511  | 29  | 1318 | 876  | 1220 | 1237 | 240  | 2259 | 1369 | 849  |
| 2031 | 1319 | 937  | 600  | 43  | 1510 | 950  | 1395 | 1413 | 454  | 2445 | 1571 | 962  |
| 2032 | 1387 | 1013 | 667  | 47  | 1699 | 1028 | 1575 | 1588 | 650  | 2599 | 1749 | 1072 |
| 2033 | 1455 | 1084 | 765  | 54  | 1877 | 1104 | 1748 | 1759 | 844  | 2745 | 1946 | 1228 |
| 2034 | 1515 | 1182 | 868  | 77  | 2071 | 1207 | 1915 | 1919 | 1022 | 2861 | 2122 | 1364 |
| 2035 | 1579 | 1253 | 992  | 94  | 2273 | 1295 | 2094 | 2103 | 1202 | 2996 | 2320 | 1509 |
| 2036 | 1646 | 1320 | 1089 | 108 | 2403 | 1357 | 2232 | 2245 | 1383 | 3117 | 2481 | 1628 |
| 2037 | 1698 | 1405 | 1159 | 138 | 2553 | 1434 | 2361 | 2390 | 1536 | 3263 | 2638 | 1731 |
| 2038 | 1739 | 1509 | 1224 | 162 | 2709 | 1507 | 2484 | 2517 | 1711 | 3384 | 2800 | 1850 |
| 2039 | 1820 | 1595 | 1283 | 191 | 2881 | 1594 | 2622 | 2653 | 1863 | 3510 | 2964 | 1963 |
| 2040 | 1907 | 1699 | 1371 | 213 | 3078 | 1659 | 2774 | 2808 | 2009 | 3655 | 3165 | 2063 |
| 2041 | 1993 | 1774 | 1452 | 240 | 3251 | 1739 | 2955 | 2992 | 2172 | 3793 | 3351 | 2173 |
| 2042 | 2049 | 1851 | 1480 | 256 | 3392 | 1788 | 3138 | 3151 | 2322 | 3923 | 3563 | 2221 |
| 2043 | 2123 | 1937 | 1534 | 277 | 3516 | 1840 | 3275 | 3296 | 2464 | 4074 | 3723 | 2317 |
| 2044 | 2187 | 2004 | 1611 | 301 | 3624 | 1879 | 3413 | 3429 | 2618 | 4203 | 3885 | 2423 |
| 2045 | 2273 | 2053 | 1670 | 335 | 3717 | 1939 | 3526 | 3544 | 2761 | 4315 | 4063 | 2508 |
| 2046 | 2339 | 2129 | 1740 | 369 | 3832 | 1999 | 3621 | 3636 | 2887 | 4315 | 4167 | 2585 |
| 2047 | 2424 | 2182 | 1812 | 431 | 3959 | 2079 | 3621 | 3636 | 2928 | 4315 | 4167 | 2622 |
| 2048 | 2568 | 2182 | 1852 | 485 | 4040 | 2144 | 3621 | 3636 | 2928 | 4315 | 4167 | 2622 |
| 2049 | 2568 | 2182 | 1852 | 485 | 4040 | 2144 | 3621 | 3636 | 2930 | 4315 | 4167 | 2622 |
| 2050 | 2568 | 2182 | 1852 | 485 | 4040 | 2144 | 3621 | 3636 | 2930 | 4315 | 4167 | 2622 |
| 2051 | 2568 | 2182 | 1852 | 485 | 4040 | 2144 | 3621 | 3636 | 2930 | 4315 | 4167 | 2622 |
| 2052 | 2568 | 2182 | 1852 | 485 | 4040 | 2144 | 3621 | 3636 | 2930 | 4315 | 4167 | 2622 |
| 2053 | 2568 | 2182 | 1852 | 485 | 4040 | 2144 | 3621 | 3636 | 2930 | 4315 | 4167 | 2622 |
| 2054 | 2568 | 2182 | 1852 | 485 | 4040 | 2144 | 3621 | 3636 | 2930 | 4315 | 4167 | 2622 |
| 2055 | 2568 | 2182 | 1852 | 485 | 4040 | 2144 | 3621 | 3636 | 2930 | 4315 | 4167 | 2622 |
| 2056 | 2568 | 2182 | 1852 | 485 | 4040 | 2144 | 3621 | 3636 | 2930 | 4315 | 4167 | 2622 |
| 2057 | 2568 | 2182 | 1852 | 485 | 4040 | 2144 | 3621 | 3636 | 2930 | 4315 | 4167 | 2622 |
| 2058 | 2568 | 2182 | 1852 | 485 | 4040 | 2144 | 3621 | 3636 | 2930 | 4315 | 4167 | 2622 |
| 2059 | 2568 | 2182 | 1852 | 485 | 4040 | 2144 | 3621 | 3636 | 2930 | 4315 | 4167 | 2622 |

|      | 121  | 122  | 123  | 124 | 125  | 126  | 127  | 128  | 129  | 130  | 131  | 132  |
|------|------|------|------|-----|------|------|------|------|------|------|------|------|
| 2060 | 2568 | 2182 | 1852 | 485 | 4040 | 2144 | 3621 | 3636 | 2930 | 4315 | 4167 | 2622 |
| 2061 | 2568 | 2182 | 1852 | 485 | 4040 | 2144 | 3621 | 3636 | 2930 | 4315 | 4167 | 2622 |
| 2062 | 2568 | 2182 | 1852 | 485 | 4040 | 2144 | 3621 | 3636 | 2930 | 4315 | 4167 | 2622 |
| 2063 | 2568 | 2182 | 1852 | 485 | 4040 | 2144 | 3621 | 3636 | 2930 | 4315 | 4167 | 2622 |
| 2064 | 2568 | 2182 | 1852 | 485 | 4040 | 2144 | 3621 | 3636 | 2930 | 4315 | 4167 | 2622 |
| 2065 | 2568 | 2182 | 1852 | 485 | 4040 | 2144 | 3621 | 3636 | 2930 | 4315 | 4167 | 2622 |
| 2066 | 2568 | 2182 | 1852 | 485 | 4040 | 2144 | 3621 | 3636 | 2930 | 4315 | 4167 | 2622 |
| 2067 | 2568 | 2182 | 1852 | 485 | 4040 | 2144 | 3621 | 3636 | 2930 | 4315 | 4167 | 2622 |
| 2068 | 2568 | 2182 | 1852 | 485 | 4040 | 2144 | 3621 | 3636 | 2930 | 4315 | 4167 | 2622 |
| 2069 | 2568 | 2182 | 1852 | 485 | 4040 | 2144 | 3621 | 3636 | 2930 | 4315 | 4167 | 2622 |
| 2070 | 2568 | 2182 | 1852 | 485 | 4040 | 2144 | 3621 | 3636 | 2930 | 4315 | 4167 | 2622 |
| 2071 | 2568 | 2182 | 1852 | 485 | 4040 | 2144 | 3621 | 3636 | 2930 | 4315 | 4167 | 2622 |
| 2072 | 2568 | 2182 | 1852 | 485 | 4040 | 2144 | 3621 | 3636 | 2930 | 4315 | 4167 | 2622 |
| 2073 | 2568 | 2182 | 1852 | 485 | 4040 | 2144 | 3621 | 3636 | 2930 | 4315 | 4167 | 2622 |
| 2074 | 2568 | 2182 | 1852 | 485 | 4040 | 2144 | 3621 | 3636 | 2930 | 4315 | 4167 | 2622 |
| 2075 | 2568 | 2182 | 1852 | 485 | 4040 | 2144 | 3621 | 3636 | 2930 | 4315 | 4167 | 2622 |
| 2076 | 2568 | 2182 | 1852 | 485 | 4040 | 2144 | 3621 | 3636 | 2930 | 4315 | 4167 | 2622 |
| 2077 | 2568 | 2182 | 1852 | 485 | 4040 | 2144 | 3621 | 3636 | 2930 | 4315 | 4167 | 2622 |
| 2078 | 2568 | 2182 | 1852 | 485 | 4040 | 2144 | 3621 | 3636 | 2930 | 4315 | 4167 | 2622 |
| 2079 | 2568 | 2182 | 1852 | 485 | 4040 | 2144 | 3621 | 3636 | 2930 | 4315 | 4167 | 2622 |
| 2080 | 2568 | 2182 | 1852 | 485 | 4040 | 2144 | 3621 | 3636 | 2930 | 4315 | 4167 | 2622 |
| 2081 | 2568 | 2182 | 1852 | 485 | 4040 | 2144 | 3621 | 3636 | 2930 | 4315 | 4167 | 2622 |
| 2082 | 2568 | 2182 | 1852 | 485 | 4040 | 2144 | 3621 | 3636 | 2930 | 4315 | 4167 | 2622 |
| 2083 | 2568 | 2182 | 1852 | 485 | 4040 | 2144 | 3621 | 3636 | 2930 | 4315 | 4167 | 2622 |
| 2084 | 2568 | 2182 | 1852 | 485 | 4040 | 2144 | 3621 | 3636 | 2930 | 4315 | 4167 | 2622 |
| 2085 | 2568 | 2182 | 1852 | 485 | 4040 | 2144 | 3621 | 3636 | 2930 | 4315 | 4167 | 2622 |
| 2086 | 2568 | 2182 | 1852 | 485 | 4040 | 2144 | 3621 | 3636 | 2930 | 4315 | 4167 | 2622 |
| 2087 | 2568 | 2182 | 1852 | 485 | 4040 | 2144 | 3621 | 3636 | 2930 | 4315 | 4167 | 2622 |
| 2088 | 2568 | 2182 | 1852 | 485 | 4040 | 2144 | 3621 | 3636 | 2930 | 4315 | 4167 | 2622 |
| 2089 | 2568 | 2182 | 1852 | 485 | 4040 | 2144 | 3621 | 3636 | 2930 | 4315 | 4167 | 2622 |
| 2090 | 2568 | 2182 | 1852 | 485 | 4040 | 2144 | 3621 | 3636 | 2930 | 4315 | 4167 | 2622 |

|      | 133  | 134  | 135  | 136 | 137 | 138 | 139 | 140 | 141 | 142 | 143 | 144 |
|------|------|------|------|-----|-----|-----|-----|-----|-----|-----|-----|-----|
| 2002 | 0    | 0    | 0    | 0   | 0   | 0   | 0   | 0   | 0   | 0   | 0   | 0   |
| 2003 | 0    | 0    | 0    | 0   | 0   | 0   | 0   | 0   | 0   | 0   | 0   | 0   |
| 2004 | 0    | 0    | 0    | 0   | 0   | 0   | 0   | 0   | 0   | 0   | 0   | 0   |
| 2005 | 0    | 0    | 0    | 0   | 0   | 0   | 0   | 0   | 0   | 0   | 0   | 0   |
| 2006 | 0    | 0    | 0    | 0   | 0   | 0   | 0   | 0   | 0   | 0   | 0   | 0   |
| 2007 | 0    | 0    | 0    | 0   | 0   | 0   | 0   | 0   | 0   | 0   | 0   | 0   |
| 2008 | 0    | 0    | 0    | 0   | 0   | 0   | 0   | 0   | 0   | 0   | 0   | 0   |
| 2009 | 0    | 0    | 0    | 0   | 0   | 0   | 0   | 0   | 0   | 0   | 0   | 0   |
| 2010 | 0    | 0    | 0    | 0   | 0   | 0   | 0   | 0   | 0   | 0   | 0   | 0   |
| 2011 | 0    | 0    | 0    | 0   | 0   | 0   | 0   | 0   | 0   | 0   | 0   | 0   |
| 2012 | 0    | 0    | 0    | 0   | 0   | 0   | 0   | 0   | 0   | 0   | 0   | 0   |
| 2013 | 0    | 0    | 0    | 0   | 0   | 0   | 0   | 0   | 0   | 0   | 0   | 0   |
| 2014 | 0    | 0    | 0    | 0   | 0   | 0   | 0   | 0   | 0   | 0   | 0   | 0   |
| 2015 | 0    | 0    | 0    | 0   | 0   | 0   | 0   | 0   | 0   | 0   | 0   | 0   |
| 2016 | 0    | 0    | 0    | 0   | 0   | 0   | 0   | 0   | 0   | 0   | 0   | 0   |
| 2017 | 0    | 0    | 0    | 0   | 0   | 0   | 0   | 0   | 0   | 0   | 0   | 0   |
| 2018 | 0    | 0    | 0    | 0   | 0   | 0   | 0   | 0   | 0   | 0   | 0   | 0   |
| 2019 | 0    | 0    | 0    | 0   | 0   | 0   | 0   | 0   | 0   | 0   | 0   | 0   |
| 2020 | 0    | 0    | 0    | 0   | 0   | 0   | 0   | 0   | 0   | 0   | 0   | 0   |
| 2021 | 0    | 0    | 0    | 0   | 0   | 0   | 0   | 0   | 0   | 0   | 0   | 0   |
| 2022 | 0    | 0    | 0    | 0   | 0   | 0   | 0   | 0   | 0   | 0   | 0   | 0   |
| 2023 | 0    | 0    | 0    | 0   | 0   | 0   | 0   | 0   | 0   | 0   | 0   | 0   |
| 2024 | 0    | 0    | 0    | 0   | 0   | 0   | 0   | 0   | 0   | 0   | 0   | 0   |
| 2025 | 186  | 249  | 233  | 0   | 0   | 0   | 0   | 0   | 0   | 0   | 0   | 0   |
| 2026 | 342  | 487  | 443  | 0   | 0   | 0   | 0   | 0   | 0   | 0   | 0   | 0   |
| 2027 | 498  | 728  | 663  | 0   | 0   | 0   | 0   | 0   | 0   | 0   | 0   | 0   |
| 2028 | 631  | 952  | 864  | 0   | 0   | 0   | 0   | 0   | 0   | 0   | 0   | 0   |
| 2029 | 755  | 1166 | 1044 | 0   | 0   | 0   | 0   | 0   | 0   | 0   | 0   | 0   |
| 2030 | 871  | 1383 | 1226 | 0   | 0   | 0   | 0   | 0   | 0   | 0   | 0   | 0   |
| 2031 | 974  | 1606 | 1408 | 0   | 0   | 0   | 0   | 0   | 0   | 0   | 0   | 0   |
| 2032 | 1054 | 1810 | 1582 | 0   | 0   | 0   | 0   | 0   | 0   | 0   | 0   | 0   |
| 2033 | 1156 | 2034 | 1758 | 0   | 0   | 0   | 0   | 0   | 0   | 0   | 1   | 0   |
| 2034 | 1250 | 2242 | 1916 | 0   | 0   | 0   | 8   | 0   | 0   | 0   | 7   | 0   |
| 2035 | 1334 | 2472 | 2099 | 0   | 0   | 0   | 10  | 0   | 0   | 0   | 13  | 0   |
| 2036 | 1409 | 2652 | 2242 | 0   | 0   | 0   | 25  | 0   | 0   | 0   | 26  | 0   |
| 2037 | 1474 | 2831 | 2382 | 0   | 0   | 0   | 54  | 0   | 0   | 0   | 59  | 0   |
| 2038 | 1554 | 3010 | 2508 | 0   | 0   | 0   | 103 | 2   | 2   | 0   | 117 | 0   |
| 2039 | 1614 | 3184 | 2643 | 0   | 0   | 0   | 156 | 3   | 5   | 0   | 187 | 0   |
| 2040 | 1703 | 3389 | 2796 | 0   | 0   | 0   | 202 | 5   | 8   | 0   | 310 | 0   |
| 2041 | 1772 | 3596 | 2975 | 2   | 6   | 0   | 259 | 11  | 14  | 0   | 405 | 3   |
| 2042 | 1826 | 3813 | 3146 | 5   | 9   | 0   | 268 | 27  | 25  | 0   | 496 | 11  |
| 2043 | 1878 | 3986 | 3290 | 15  | 26  | 0   | 268 | 57  | 51  | 2   | 577 | 30  |
| 2044 | 1932 | 4147 | 3421 | 45  | 54  | 0   | 268 | 99  | 89  | 2   | 674 | 53  |
| 2045 | 1985 | 4309 | 3534 | 45  | 54  | 0   | 268 | 99  | 89  | 2   | 674 | 53  |
| 2046 | 2012 | 4437 | 3627 | 45  | 54  | 2   | 268 | 99  | 89  | 2   | 674 | 53  |
| 2047 | 2012 | 4437 | 3627 | 45  | 54  | 7   | 268 | 99  | 89  | 2   | 674 | 53  |
| 2048 | 2012 | 4437 | 3627 | 45  | 54  | 7   | 268 | 99  | 89  | 2   | 674 | 53  |
| 2049 | 2012 | 4437 | 3627 | 45  | 54  | 7   | 268 | 99  | 89  | 2   | 674 | 53  |
| 2050 | 2012 | 4437 | 3627 | 45  | 54  | 7   | 268 | 99  | 89  | 2   | 674 | 53  |
| 2051 | 2012 | 4437 | 3627 | 45  | 54  | 7   | 268 | 99  | 89  | 2   | 674 | 53  |
| 2052 | 2012 | 4437 | 3627 | 45  | 54  | 7   | 268 | 99  | 89  | 2   | 674 | 53  |
| 2053 | 2012 | 4437 | 3627 | 45  | 54  | 7   | 268 | 99  | 89  | 2   | 674 | 53  |
| 2054 | 2012 | 4437 | 3627 | 45  | 54  | 7   | 268 | 99  | 89  | 2   | 674 | 53  |
| 2055 | 2012 | 4437 | 3627 | 45  | 54  | 7   | 268 | 99  | 89  | 2   | 674 | 53  |
| 2056 | 2012 | 4437 | 3627 | 45  | 54  | 7   | 268 | 99  | 89  | 2   | 674 | 53  |
| 2057 | 2012 | 4437 | 3627 | 45  | 54  | 7   | 268 | 99  | 89  | 2   | 674 | 53  |
| 2058 | 2012 | 4437 | 3627 | 45  | 54  | 7   | 268 | 99  | 89  | 2   | 674 | 53  |
| 2059 | 2012 | 4437 | 3627 | 45  | 54  | 7   | 268 | 99  | 89  | 2   | 674 | 53  |

|      | 133  | 134  | 135  | 136 | 137 | 138 | 139 | 140 | 141 | 142 | 143 | 144 |
|------|------|------|------|-----|-----|-----|-----|-----|-----|-----|-----|-----|
| 2060 | 2012 | 4437 | 3627 | 45  | 54  | 7   | 268 | 99  | 89  | 2   | 674 | 53  |
| 2061 | 2012 | 4437 | 3627 | 45  | 54  | 7   | 268 | 99  | 89  | 2   | 674 | 53  |
| 2062 | 2012 | 4437 | 3627 | 45  | 54  | 7   | 268 | 99  | 89  | 2   | 674 | 53  |
| 2063 | 2012 | 4437 | 3627 | 45  | 54  | 7   | 268 | 99  | 89  | 2   | 674 | 53  |
| 2064 | 2012 | 4437 | 3627 | 45  | 54  | 7   | 268 | 99  | 89  | 2   | 674 | 53  |
| 2065 | 2012 | 4437 | 3627 | 45  | 54  | 7   | 268 | 99  | 89  | 2   | 674 | 53  |
| 2066 | 2012 | 4437 | 3627 | 45  | 54  | 7   | 268 | 99  | 89  | 2   | 674 | 53  |
| 2067 | 2012 | 4437 | 3627 | 45  | 54  | 7   | 268 | 99  | 89  | 2   | 674 | 53  |
| 2068 | 2012 | 4437 | 3627 | 45  | 54  | 7   | 268 | 99  | 89  | 2   | 674 | 53  |
| 2069 | 2012 | 4437 | 3627 | 45  | 54  | 7   | 268 | 99  | 89  | 2   | 674 | 53  |
| 2070 | 2012 | 4437 | 3627 | 45  | 54  | 7   | 268 | 99  | 89  | 2   | 674 | 53  |
| 2071 | 2012 | 4437 | 3627 | 45  | 54  | 7   | 268 | 99  | 89  | 2   | 674 | 53  |
| 2072 | 2012 | 4437 | 3627 | 45  | 54  | 7   | 268 | 99  | 89  | 2   | 674 | 53  |
| 2073 | 2012 | 4437 | 3627 | 45  | 54  | 7   | 268 | 99  | 89  | 2   | 674 | 53  |
| 2074 | 2012 | 4437 | 3627 | 45  | 54  | 7   | 268 | 99  | 89  | 2   | 674 | 53  |
| 2075 | 2012 | 4437 | 3627 | 45  | 54  | 7   | 268 | 99  | 89  | 2   | 674 | 53  |
| 2076 | 2012 | 4437 | 3627 | 45  | 54  | 7   | 268 | 99  | 89  | 2   | 674 | 53  |
| 2077 | 2012 | 4437 | 3627 | 45  | 54  | 7   | 268 | 99  | 89  | 2   | 674 | 53  |
| 2078 | 2012 | 4437 | 3627 | 45  | 54  | 7   | 268 | 99  | 89  | 2   | 674 | 53  |
| 2079 | 2012 | 4437 | 3627 | 45  | 54  | 7   | 268 | 99  | 89  | 2   | 674 | 53  |
| 2080 | 2012 | 4437 | 3627 | 45  | 54  | 7   | 268 | 99  | 89  | 2   | 674 | 53  |
| 2081 | 2012 | 4437 | 3627 | 45  | 54  | 7   | 268 | 99  | 89  | 2   | 674 | 53  |
| 2082 | 2012 | 4437 | 3627 | 45  | 54  | 7   | 268 | 99  | 89  | 2   | 674 | 53  |
| 2083 | 2012 | 4437 | 3627 | 45  | 54  | 7   | 268 | 99  | 89  | 2   | 674 | 53  |
| 2084 | 2012 | 4437 | 3627 | 45  | 54  | 7   | 268 | 99  | 89  | 2   | 674 | 53  |
| 2085 | 2012 | 4437 | 3627 | 45  | 54  | 7   | 268 | 99  | 89  | 2   | 674 | 53  |
| 2086 | 2012 | 4437 | 3627 | 45  | 54  | 7   | 268 | 99  | 89  | 2   | 674 | 53  |
| 2087 | 2012 | 4437 | 3627 | 45  | 54  | 7   | 268 | 99  | 89  | 2   | 674 | 53  |
| 2088 | 2012 | 4437 | 3627 | 45  | 54  | 7   | 268 | 99  | 89  | 2   | 674 | 53  |
| 2089 | 2012 | 4437 | 3627 | 45  | 54  | 7   | 268 | 99  | 89  | 2   | 674 | 53  |
| 2090 | 2012 | 4437 | 3627 | 45  | 54  | 7   | 268 | 99  | 89  | 2   | 674 | 53  |



|      | 145  | 146  | 147  | 148  | 149  | 150  | 151 | 152  | 153  | 154  | 155  | 156  |
|------|------|------|------|------|------|------|-----|------|------|------|------|------|
| 2002 | 0    | 0    | 0    | 0    | 0    | 0    | 0   | 0    | 0    | 0    | 0    | 0    |
| 2003 | 0    | 0    | 0    | 0    | 0    | 0    | 0   | 0    | 0    | 0    | 0    | 0    |
| 2004 | 0    | 0    | 0    | 0    | 0    | 0    | 0   | 0    | 0    | 0    | 0    | 0    |
| 2005 | 0    | 0    | 0    | 0    | 0    | 0    | 0   | 0    | 0    | 0    | 0    | 0    |
| 2006 | 0    | 0    | 0    | 0    | 0    | 0    | 0   | 0    | 0    | 0    | 0    | 0    |
| 2007 | 0    | 0    | 0    | 0    | 0    | 0    | 0   | 0    | 0    | 0    | 0    | 0    |
| 2008 | 0    | 0    | 0    | 0    | 0    | 0    | 0   | 0    | 0    | 0    | 0    | 0    |
| 2009 | 0    | 0    | 0    | 0    | 0    | 0    | 0   | 0    | 0    | 0    | 0    | 0    |
| 2010 | 0    | 0    | 0    | 0    | 0    | 0    | 0   | 0    | 0    | 0    | 0    | 0    |
| 2011 | 0    | 0    | 0    | 0    | 0    | 0    | 0   | 0    | 0    | 0    | 0    | 0    |
| 2012 | 0    | 0    | 0    | 0    | 0    | 0    | 0   | 0    | 0    | 0    | 0    | 0    |
| 2013 | 0    | 0    | 0    | 0    | 0    | 0    | 0   | 0    | 0    | 0    | 0    | 0    |
| 2014 | 0    | 0    | 0    | 0    | 0    | 0    | 0   | 0    | 0    | 0    | 0    | 0    |
| 2015 | 0    | 0    | 0    | 0    | 0    | 0    | 0   | 0    | 0    | 0    | 0    | 0    |
| 2016 | 0    | 0    | 0    | 0    | 0    | 0    | 0   | 0    | 0    | 0    | 0    | 0    |
| 2017 | 0    | 0    | 0    | 0    | 0    | 0    | 0   | 0    | 0    | 0    | 0    | 0    |
| 2018 | 0    | 0    | 0    | 0    | 0    | 0    | 0   | 0    | 0    | 0    | 0    | 0    |
| 2019 | 0    | 0    | 0    | 0    | 0    | 0    | 0   | 0    | 0    | 0    | 0    | 0    |
| 2020 | 0    | 0    | 0    | 160  | 0    | 0    | 0   | 0    | 0    | 0    | 0    | 0    |
| 2021 | 0    | 0    | 0    | 300  | 0    | 0    | 0   | 0    | 0    | 0    | 0    | 0    |
| 2022 | 0    | 0    | 0    | 420  | 0    | 0    | 0   | 0    | 0    | 0    | 0    | 0    |
| 2023 | 0    | 0    | 0    | 555  | 0    | 0    | 0   | 0    | 0    | 0    | 0    | 0    |
| 2024 | 0    | 0    | 0    | 700  | 0    | 0    | 0   | 0    | 0    | 0    | 0    | 0    |
| 2025 | 179  | 179  | 0    | 829  | 186  | 74   | 6   | 246  | 179  | 233  | 233  | 0    |
| 2026 | 304  | 313  | 0    | 945  | 337  | 140  | 6   | 455  | 310  | 399  | 422  | 0    |
| 2027 | 440  | 464  | 0    | 1045 | 489  | 205  | 6   | 683  | 449  | 588  | 637  | 0    |
| 2028 | 581  | 586  | 0    | 1142 | 641  | 287  | 19  | 967  | 587  | 801  | 856  | 0    |
| 2029 | 723  | 720  | 0    | 1215 | 791  | 373  | 22  | 1228 | 726  | 990  | 1036 | 0    |
| 2030 | 850  | 836  | 184  | 1283 | 910  | 461  | 24  | 1459 | 854  | 1191 | 1214 | 240  |
| 2031 | 929  | 926  | 313  | 1368 | 1003 | 591  | 34  | 1697 | 943  | 1381 | 1415 | 433  |
| 2032 | 1031 | 1034 | 444  | 1429 | 1104 | 679  | 40  | 1914 | 1049 | 1556 | 1591 | 610  |
| 2033 | 1112 | 1113 | 581  | 1535 | 1178 | 781  | 42  | 2118 | 1129 | 1733 | 1764 | 804  |
| 2034 | 1217 | 1218 | 718  | 1639 | 1283 | 900  | 50  | 2345 | 1233 | 1924 | 1957 | 1011 |
| 2035 | 1304 | 1305 | 816  | 1689 | 1368 | 1030 | 60  | 2572 | 1325 | 2128 | 2148 | 1180 |
| 2036 | 1388 | 1385 | 899  | 1763 | 1449 | 1111 | 78  | 2751 | 1410 | 2289 | 2317 | 1324 |
| 2037 | 1462 | 1457 | 997  | 1809 | 1523 | 1183 | 95  | 2927 | 1485 | 2460 | 2495 | 1482 |
| 2038 | 1536 | 1529 | 1109 | 1860 | 1598 | 1255 | 112 | 3081 | 1554 | 2613 | 2639 | 1668 |
| 2039 | 1592 | 1597 | 1199 | 1942 | 1699 | 1322 | 124 | 3250 | 1616 | 2761 | 2792 | 1828 |
| 2040 | 1680 | 1696 | 1318 | 2043 | 1812 | 1419 | 160 | 3450 | 1704 | 2947 | 2974 | 1988 |
| 2041 | 1781 | 1795 | 1423 | 2119 | 1896 | 1492 | 188 | 3635 | 1805 | 3136 | 3159 | 2164 |
| 2042 | 1867 | 1883 | 1466 | 2227 | 1984 | 1526 | 213 | 3825 | 1892 | 3304 | 3341 | 2314 |
| 2043 | 1928 | 1945 | 1521 | 2324 | 2051 | 1602 | 245 | 3978 | 1959 | 3436 | 3472 | 2435 |
| 2044 | 1977 | 1988 | 1593 | 2419 | 2118 | 1675 | 274 | 4111 | 2004 | 3598 | 3633 | 2579 |
| 2045 | 2056 | 2048 | 1653 | 2473 | 2182 | 1751 | 305 | 4226 | 2063 | 3745 | 3765 | 2752 |
| 2046 | 2113 | 2105 | 1700 | 2473 | 2262 | 1809 | 330 | 4334 | 2118 | 3745 | 3787 | 2892 |
| 2047 | 2198 | 2195 | 1778 | 2473 | 2312 | 1837 | 374 | 4486 | 2214 | 3745 | 3787 | 3046 |
| 2048 | 2198 | 2195 | 1881 | 2473 | 2312 | 1837 | 374 | 4486 | 2214 | 3745 | 3787 | 3123 |
| 2049 | 2198 | 2195 | 1899 | 2473 | 2312 | 1837 | 374 | 4486 | 2214 | 3745 | 3787 | 3123 |
| 2050 | 2198 | 2195 | 1899 | 2473 | 2312 | 1837 | 374 | 4486 | 2214 | 3745 | 3787 | 3123 |
| 2051 | 2198 | 2195 | 1899 | 2473 | 2312 | 1837 | 374 | 4486 | 2214 | 3745 | 3787 | 3123 |
| 2052 | 2198 | 2195 | 1899 | 2473 | 2312 | 1837 | 374 | 4486 | 2214 | 3745 | 3787 | 3123 |
| 2053 | 2198 | 2195 | 1899 | 2473 | 2312 | 1837 | 374 | 4486 | 2214 | 3745 | 3787 | 3123 |
| 2054 | 2198 | 2195 | 1899 | 2473 | 2312 | 1837 | 374 | 4486 | 2214 | 3745 | 3787 | 3123 |
| 2055 | 2198 | 2195 | 1899 | 2473 | 2312 | 1837 | 374 | 4486 | 2214 | 3745 | 3787 | 3123 |
| 2056 | 2198 | 2195 | 1899 | 2473 | 2312 | 1837 | 374 | 4486 | 2214 | 3745 | 3787 | 3123 |
| 2057 | 2198 | 2195 | 1899 | 2473 | 2312 | 1837 | 374 | 4486 | 2214 | 3745 | 3787 | 3123 |
| 2058 | 2198 | 2195 | 1899 | 2473 | 2312 | 1837 | 374 | 4486 | 2214 | 3745 | 3787 | 3123 |
| 2059 | 2198 | 2195 | 1899 | 2473 | 2312 | 1837 | 374 | 4486 | 2214 | 3745 | 3787 | 3123 |

|      | 145  | 146  | 147  | 148  | 149  | 150  | 151 | 152  | 153  | 154  | 155  | 156  |
|------|------|------|------|------|------|------|-----|------|------|------|------|------|
| 2060 | 2198 | 2195 | 1899 | 2473 | 2312 | 1837 | 374 | 4486 | 2214 | 3745 | 3787 | 3123 |
| 2061 | 2198 | 2195 | 1899 | 2473 | 2312 | 1837 | 374 | 4486 | 2214 | 3745 | 3787 | 3123 |
| 2062 | 2198 | 2195 | 1899 | 2473 | 2312 | 1837 | 374 | 4486 | 2214 | 3745 | 3787 | 3123 |
| 2063 | 2198 | 2195 | 1899 | 2473 | 2312 | 1837 | 374 | 4486 | 2214 | 3745 | 3787 | 3123 |
| 2064 | 2198 | 2195 | 1899 | 2473 | 2312 | 1837 | 374 | 4486 | 2214 | 3745 | 3787 | 3123 |
| 2065 | 2198 | 2195 | 1899 | 2473 | 2312 | 1837 | 374 | 4486 | 2214 | 3745 | 3787 | 3123 |
| 2066 | 2198 | 2195 | 1899 | 2473 | 2312 | 1837 | 374 | 4486 | 2214 | 3745 | 3787 | 3123 |
| 2067 | 2198 | 2195 | 1899 | 2473 | 2312 | 1837 | 374 | 4486 | 2214 | 3745 | 3787 | 3123 |
| 2068 | 2198 | 2195 | 1899 | 2473 | 2312 | 1837 | 374 | 4486 | 2214 | 3745 | 3787 | 3123 |
| 2069 | 2198 | 2195 | 1899 | 2473 | 2312 | 1837 | 374 | 4486 | 2214 | 3745 | 3787 | 3123 |
| 2070 | 2198 | 2195 | 1899 | 2473 | 2312 | 1837 | 374 | 4486 | 2214 | 3745 | 3787 | 3123 |
| 2071 | 2198 | 2195 | 1899 | 2473 | 2312 | 1837 | 374 | 4486 | 2214 | 3745 | 3787 | 3123 |
| 2072 | 2198 | 2195 | 1899 | 2473 | 2312 | 1837 | 374 | 4486 | 2214 | 3745 | 3787 | 3123 |
| 2073 | 2198 | 2195 | 1899 | 2473 | 2312 | 1837 | 374 | 4486 | 2214 | 3745 | 3787 | 3123 |
| 2074 | 2198 | 2195 | 1899 | 2473 | 2312 | 1837 | 374 | 4486 | 2214 | 3745 | 3787 | 3123 |
| 2075 | 2198 | 2195 | 1899 | 2473 | 2312 | 1837 | 374 | 4486 | 2214 | 3745 | 3787 | 3123 |
| 2076 | 2198 | 2195 | 1899 | 2473 | 2312 | 1837 | 374 | 4486 | 2214 | 3745 | 3787 | 3123 |
| 2077 | 2198 | 2195 | 1899 | 2473 | 2312 | 1837 | 374 | 4486 | 2214 | 3745 | 3787 | 3123 |
| 2078 | 2198 | 2195 | 1899 | 2473 | 2312 | 1837 | 374 | 4486 | 2214 | 3745 | 3787 | 3123 |
| 2079 | 2198 | 2195 | 1899 | 2473 | 2312 | 1837 | 374 | 4486 | 2214 | 3745 | 3787 | 3123 |
| 2080 | 2198 | 2195 | 1899 | 2473 | 2312 | 1837 | 374 | 4486 | 2214 | 3745 | 3787 | 3123 |
| 2081 | 2198 | 2195 | 1899 | 2473 | 2312 | 1837 | 374 | 4486 | 2214 | 3745 | 3787 | 3123 |
| 2082 | 2198 | 2195 | 1899 | 2473 | 2312 | 1837 | 374 | 4486 | 2214 | 3745 | 3787 | 3123 |
| 2083 | 2198 | 2195 | 1899 | 2473 | 2312 | 1837 | 374 | 4486 | 2214 | 3745 | 3787 | 3123 |
| 2084 | 2198 | 2195 | 1899 | 2473 | 2312 | 1837 | 374 | 4486 | 2214 | 3745 | 3787 | 3123 |
| 2085 | 2198 | 2195 | 1899 | 2473 | 2312 | 1837 | 374 | 4486 | 2214 | 3745 | 3787 | 3123 |
| 2086 | 2198 | 2195 | 1899 | 2473 | 2312 | 1837 | 374 | 4486 | 2214 | 3745 | 3787 | 3123 |
| 2087 | 2198 | 2195 | 1899 | 2473 | 2312 | 1837 | 374 | 4486 | 2214 | 3745 | 3787 | 3123 |
| 2088 | 2198 | 2195 | 1899 | 2473 | 2312 | 1837 | 374 | 4486 | 2214 | 3745 | 3787 | 3123 |
| 2089 | 2198 | 2195 | 1899 | 2473 | 2312 | 1837 | 374 | 4486 | 2214 | 3745 | 3787 | 3123 |
| 2090 | 2198 | 2195 | 1899 | 2473 | 2312 | 1837 | 374 | 4486 | 2214 | 3745 | 3787 | 3123 |

|      | 157  | 158  | 159  | 160  | 161  | 162  |
|------|------|------|------|------|------|------|
| 2002 | 0    | 0    | 0    | 0    | 0    | 0    |
| 2003 | 0    | 0    | 0    | 0    | 0    | 0    |
| 2004 | 0    | 0    | 0    | 0    | 0    | 0    |
| 2005 | 0    | 0    | 0    | 0    | 0    | 0    |
| 2006 | 0    | 0    | 0    | 0    | 0    | 0    |
| 2007 | 0    | 0    | 0    | 0    | 0    | 0    |
| 2008 | 0    | 0    | 0    | 0    | 0    | 0    |
| 2009 | 0    | 0    | 0    | 0    | 0    | 0    |
| 2010 | 0    | 0    | 0    | 0    | 0    | 0    |
| 2011 | 0    | 0    | 0    | 0    | 0    | 0    |
| 2012 | 0    | 0    | 0    | 0    | 0    | 0    |
| 2013 | 0    | 0    | 0    | 0    | 0    | 0    |
| 2014 | 0    | 0    | 0    | 0    | 0    | 0    |
| 2015 | 0    | 0    | 0    | 0    | 0    | 0    |
| 2016 | 0    | 0    | 0    | 0    | 0    | 0    |
| 2017 | 0    | 0    | 0    | 0    | 0    | 0    |
| 2018 | 0    | 0    | 0    | 0    | 0    | 0    |
| 2019 | 0    | 0    | 0    | 0    | 0    | 0    |
| 2020 | 240  | 0    | 0    | 0    | 0    | 0    |
| 2021 | 436  | 0    | 0    | 0    | 0    | 0    |
| 2022 | 645  | 0    | 0    | 0    | 0    | 0    |
| 2023 | 856  | 0    | 0    | 0    | 0    | 0    |
| 2024 | 1094 | 0    | 0    | 0    | 0    | 0    |
| 2025 | 1299 | 238  | 187  | 186  | 249  | 233  |
| 2026 | 1501 | 454  | 301  | 317  | 464  | 421  |
| 2027 | 1692 | 673  | 442  | 439  | 697  | 619  |
| 2028 | 1915 | 927  | 546  | 566  | 987  | 838  |
| 2029 | 2111 | 1160 | 657  | 688  | 1285 | 1034 |
| 2030 | 2285 | 1388 | 796  | 813  | 1542 | 1221 |
| 2031 | 2487 | 1617 | 939  | 928  | 1817 | 1421 |
| 2032 | 2667 | 1825 | 1062 | 1025 | 2064 | 1597 |
| 2033 | 2845 | 2025 | 1214 | 1135 | 2285 | 1771 |
| 2034 | 3006 | 2237 | 1371 | 1252 | 2538 | 1965 |
| 2035 | 3179 | 2454 | 1541 | 1348 | 2782 | 2158 |
| 2036 | 3348 | 2641 | 1665 | 1440 | 3004 | 2325 |
| 2037 | 3502 | 2822 | 1788 | 1512 | 3219 | 2504 |
| 2038 | 3632 | 3006 | 1901 | 1587 | 3417 | 2656 |
| 2039 | 3809 | 3212 | 2051 | 1652 | 3624 | 2805 |
| 2040 | 3977 | 3443 | 2181 | 1748 | 3862 | 2991 |
| 2041 | 4174 | 3654 | 2320 | 1822 | 4081 | 3187 |
| 2042 | 4352 | 3907 | 2395 | 1877 | 4332 | 3364 |
| 2043 | 4460 | 4073 | 2507 | 1925 | 4501 | 3494 |
| 2044 | 4460 | 4254 | 2596 | 1969 | 4693 | 3649 |
| 2045 | 4460 | 4417 | 2730 | 2033 | 4889 | 3790 |
| 2046 | 4460 | 4418 | 2745 | 2033 | 4889 | 3790 |
| 2047 | 4460 | 4418 | 2745 | 2033 | 4889 | 3790 |
| 2048 | 4460 | 4418 | 2745 | 2033 | 4889 | 3790 |
| 2049 | 4460 | 4418 | 2745 | 2033 | 4889 | 3790 |
| 2050 | 4460 | 4418 | 2745 | 2033 | 4889 | 3790 |
| 2051 | 4460 | 4418 | 2745 | 2033 | 4889 | 3790 |
| 2052 | 4460 | 4418 | 2745 | 2033 | 4889 | 3790 |
| 2053 | 4460 | 4418 | 2745 | 2033 | 4889 | 3790 |
| 2054 | 4460 | 4418 | 2745 | 2033 | 4889 | 3790 |
| 2055 | 4460 | 4418 | 2745 | 2033 | 4889 | 3790 |
| 2056 | 4460 | 4418 | 2745 | 2033 | 4889 | 3790 |
| 2057 | 4460 | 4418 | 2745 | 2033 | 4889 | 3790 |
| 2058 | 4460 | 4418 | 2745 | 2033 | 4889 | 3790 |
| 2059 | 4460 | 4418 | 2745 | 2033 | 4889 | 3790 |

|      | 157  | 158  | 159  | 160  | 161  | 162  |
|------|------|------|------|------|------|------|
| 2060 | 4460 | 4418 | 2745 | 2033 | 4889 | 3790 |
| 2061 | 4460 | 4418 | 2745 | 2033 | 4889 | 3790 |
| 2062 | 4460 | 4418 | 2745 | 2033 | 4889 | 3790 |
| 2063 | 4460 | 4418 | 2745 | 2033 | 4889 | 3790 |
| 2064 | 4460 | 4418 | 2745 | 2033 | 4889 | 3790 |
| 2065 | 4460 | 4418 | 2745 | 2033 | 4889 | 3790 |
| 2066 | 4460 | 4418 | 2745 | 2033 | 4889 | 3790 |
| 2067 | 4460 | 4418 | 2745 | 2033 | 4889 | 3790 |
| 2068 | 4460 | 4418 | 2745 | 2033 | 4889 | 3790 |
| 2069 | 4460 | 4418 | 2745 | 2033 | 4889 | 3790 |
| 2070 | 4460 | 4418 | 2745 | 2033 | 4889 | 3790 |
| 2071 | 4460 | 4418 | 2745 | 2033 | 4889 | 3790 |
| 2072 | 4460 | 4418 | 2745 | 2033 | 4889 | 3790 |
| 2073 | 4460 | 4418 | 2745 | 2033 | 4889 | 3790 |
| 2074 | 4460 | 4418 | 2745 | 2033 | 4889 | 3790 |
| 2075 | 4460 | 4418 | 2745 | 2033 | 4889 | 3790 |
| 2076 | 4460 | 4418 | 2745 | 2033 | 4889 | 3790 |
| 2077 | 4460 | 4418 | 2745 | 2033 | 4889 | 3790 |
| 2078 | 4460 | 4418 | 2745 | 2033 | 4889 | 3790 |
| 2079 | 4460 | 4418 | 2745 | 2033 | 4889 | 3790 |
| 2080 | 4460 | 4418 | 2745 | 2033 | 4889 | 3790 |
| 2081 | 4460 | 4418 | 2745 | 2033 | 4889 | 3790 |
| 2082 | 4460 | 4418 | 2745 | 2033 | 4889 | 3790 |
| 2083 | 4460 | 4418 | 2745 | 2033 | 4889 | 3790 |
| 2084 | 4460 | 4418 | 2745 | 2033 | 4889 | 3790 |
| 2085 | 4460 | 4418 | 2745 | 2033 | 4889 | 3790 |
| 2086 | 4460 | 4418 | 2745 | 2033 | 4889 | 3790 |
| 2087 | 4460 | 4418 | 2745 | 2033 | 4889 | 3790 |
| 2088 | 4460 | 4418 | 2745 | 2033 | 4889 | 3790 |
| 2089 | 4460 | 4418 | 2745 | 2033 | 4889 | 3790 |
| 2090 | 4460 | 4418 | 2745 | 2033 | 4889 | 3790 |

|      | 1    | 2    | 3    | 4    | 5    | 6    | 7    | 8    | 9    | 10   | 11   | 12   | 13   |
|------|------|------|------|------|------|------|------|------|------|------|------|------|------|
| 2002 | 0    | 0    | 0    | 0    | 0    | 0    | 0    | 0    | 0    | 0    | 0    | 0    | 0    |
| 2003 | 0    | 0    | 0    | 0    | 0    | 0    | 0    | 0    | 0    | 0    | 0    | 0    | 0    |
| 2004 | 0    | 0    | 0    | 0    | 0    | 0    | 0    | 0    | 0    | 0    | 0    | 0    | 0    |
| 2005 | 0    | 0    | 0    | 0    | 0    | 0    | 0    | 0    | 0    | 0    | 0    | 0    | 0    |
| 2006 | 0    | 0    | 0    | 0    | 0    | 0    | 0    | 0    | 0    | 0    | 0    | 0    | 0    |
| 2007 | 0    | 0    | 0    | 0    | 0    | 0    | 0    | 0    | 0    | 0    | 0    | 0    | 0    |
| 2008 | 0    | 0    | 0    | 0    | 0    | 0    | 0    | 0    | 0    | 0    | 0    | 0    | 0    |
| 2009 | 0    | 0    | 0    | 0    | 0    | 0    | 0    | 0    | 0    | 0    | 0    | 0    | 0    |
| 2010 | 0    | 0    | 0    | 0    | 0    | 0    | 0    | 0    | 0    | 0    | 0    | 0    | 0    |
| 2011 | 0    | 0    | 0    | 0    | 0    | 0    | 0    | 0    | 0    | 0    | 0    | 0    | 0    |
| 2012 | 0    | 0    | 0    | 0    | 0    | 0    | 0    | 0    | 0    | 0    | 0    | 0    | 0    |
| 2013 | 0    | 0    | 0    | 0    | 0    | 0    | 0    | 0    | 0    | 0    | 0    | 0    | 0    |
| 2014 | 0    | 0    | 0    | 0    | 0    | 0    | 0    | 0    | 0    | 0    | 0    | 0    | 0    |
| 2015 | 0    | 0    | 0    | 0    | 0    | 0    | 0    | 0    | 0    | 0    | 0    | 0    | 0    |
| 2016 | 0    | 0    | 0    | 0    | 0    | 0    | 0    | 0    | 0    | 0    | 0    | 0    | 0    |
| 2017 | 0    | 0    | 0    | 0    | 0    | 0    | 0    | 0    | 0    | 0    | 0    | 0    | 0    |
| 2018 | 0    | 0    | 0    | 0    | 0    | 0    | 0    | 0    | 0    | 0    | 0    | 0    | 0    |
| 2019 | 0    | 0    | 0    | 0    | 0    | 0    | 0    | 0    | 0    | 0    | 0    | 0    | 0    |
| 2020 | 0    | 0    | 0    | 254  | 0    | 0    | 0    | 0    | 0    | 0    | 0    | 0    | 250  |
| 2021 | 0    | 0    | 0    | 506  | 0    | 0    | 0    | 0    | 0    | 0    | 0    | 0    | 510  |
| 2022 | 0    | 0    | 0    | 760  | 0    | 0    | 0    | 0    | 0    | 0    | 0    | 0    | 755  |
| 2023 | 0    | 0    | 0    | 1017 | 0    | 0    | 0    | 0    | 0    | 0    | 0    | 0    | 1016 |
| 2024 | 0    | 0    | 0    | 1268 | 0    | 0    | 0    | 0    | 0    | 0    | 0    | 0    | 1296 |
| 2025 | 256  | 256  | 0    | 1537 | 256  | 256  | 256  | 256  | 256  | 250  | 250  | 0    | 1553 |
| 2026 | 506  | 506  | 0    | 1793 | 506  | 506  | 506  | 506  | 506  | 500  | 500  | 0    | 1812 |
| 2027 | 757  | 757  | 0    | 2050 | 757  | 757  | 757  | 757  | 757  | 764  | 762  | 0    | 2084 |
| 2028 | 1011 | 1011 | 0    | 2306 | 1011 | 1011 | 1011 | 1011 | 1011 | 1010 | 1007 | 0    | 2379 |
| 2029 | 1261 | 1261 | 0    | 2592 | 1261 | 1261 | 1261 | 1261 | 1261 | 1273 | 1265 | 0    | 2657 |
| 2030 | 1513 | 1513 | 256  | 2875 | 1513 | 1513 | 1513 | 1513 | 1513 | 1546 | 1536 | 250  | 2921 |
| 2031 | 1771 | 1771 | 509  | 3143 | 1771 | 1775 | 1771 | 1771 | 1771 | 1800 | 1790 | 502  | 3221 |
| 2032 | 2027 | 2027 | 759  | 3444 | 2027 | 2054 | 2027 | 2027 | 2027 | 2081 | 2060 | 757  | 3510 |
| 2033 | 2295 | 2292 | 1016 | 3777 | 2277 | 2333 | 2292 | 2292 | 2292 | 2360 | 2327 | 1022 | 3775 |
| 2034 | 2559 | 2556 | 1271 | 4054 | 2536 | 2606 | 2556 | 2556 | 2556 | 2648 | 2607 | 1286 | 4057 |
| 2035 | 2836 | 2833 | 1523 | 4384 | 2803 | 2880 | 2833 | 2833 | 2833 | 2929 | 2890 | 1561 | 4321 |
| 2036 | 3168 | 3147 | 1790 | 4700 | 3089 | 3148 | 3147 | 3147 | 3147 | 3195 | 3141 | 1830 | 4540 |
| 2037 | 3473 | 3454 | 2052 | 4938 | 3366 | 3454 | 3454 | 3454 | 3454 | 3447 | 3396 | 2108 | 4780 |
| 2038 | 3808 | 3789 | 2314 | 5230 | 3715 | 3778 | 3789 | 3789 | 3789 | 3672 | 3630 | 2408 | 5006 |
| 2039 | 4087 | 4075 | 2577 | 5563 | 4011 | 4053 | 4080 | 4080 | 4080 | 3913 | 3859 | 2682 | 5211 |
| 2040 | 4432 | 4415 | 2858 | 5854 | 4365 | 4388 | 4420 | 4420 | 4420 | 4171 | 4121 | 2966 | 5421 |
| 2041 | 4710 | 4700 | 3141 | 6078 | 4643 | 4671 | 4712 | 4712 | 4712 | 4431 | 4393 | 3251 | 5608 |
| 2042 | 5031 | 5062 | 3465 | 6253 | 5043 | 5045 | 5069 | 5069 | 5069 | 4691 | 4651 | 3511 | 5790 |
| 2043 | 5212 | 5186 | 3785 | 6505 | 5098 | 5202 | 5219 | 5219 | 5219 | 4941 | 4890 | 3795 | 5966 |
| 2044 | 5426 | 5366 | 4076 | 6684 | 5286 | 5380 | 5407 | 5407 | 5407 | 5144 | 5100 | 4060 | 6155 |
| 2045 | 5675 | 5599 | 4195 | 6901 | 5515 | 5624 | 5640 | 5640 | 5640 | 5333 | 5293 | 4307 | 6326 |
| 2046 | 5903 | 5789 | 4398 | 7092 | 5750 | 5836 | 5858 | 5858 | 5858 | 5518 | 5471 | 4525 | 6449 |
| 2047 | 6140 | 5993 | 4636 | 7180 | 5959 | 6054 | 6084 | 6084 | 6084 | 5703 | 5655 | 4709 | 6551 |
| 2048 | 6338 | 6182 | 4874 | 7216 | 6159 | 6263 | 6286 | 6286 | 6286 | 5831 | 5792 | 4883 | 6566 |
| 2049 | 6498 | 6350 | 5098 | 7248 | 6337 | 6430 | 6469 | 6469 | 6469 | 5915 | 5861 | 5116 | 6860 |
| 2050 | 6748 | 6547 | 5318 | 7248 | 6531 | 6607 | 6649 | 6649 | 6649 | 6161 | 6088 | 5365 | 7074 |
| 2051 | 6960 | 6739 | 5540 | 7255 | 6756 | 6854 | 6872 | 6872 | 6872 | 6374 | 6282 | 5548 | 7167 |
| 2052 | 7085 | 6932 | 5773 | 7255 | 6993 | 7028 | 7029 | 7029 | 7029 | 6612 | 6454 | 5742 | 7207 |
| 2053 | 7166 | 7055 | 5928 | 7255 | 7122 | 7134 | 7141 | 7141 | 7141 | 6864 | 6681 | 5972 | 7227 |
| 2054 | 7228 | 7178 | 6172 | 7255 | 7196 | 7201 | 7208 | 7208 | 7208 | 7056 | 6911 | 6158 | 7246 |
| 2055 | 7235 | 7228 | 6376 | 7255 | 7231 | 7225 | 7232 | 7232 | 7232 | 7151 | 7054 | 6396 | 7252 |
| 2056 | 7243 | 7229 | 6608 | 7255 | 7238 | 7233 | 7240 | 7240 | 7240 | 7196 | 7131 | 6633 | 7252 |
| 2057 | 7243 | 7247 | 6833 | 7255 | 7248 | 7242 | 7249 | 7249 | 7249 | 7232 | 7189 | 6830 | 7252 |
| 2058 | 7250 | 7247 | 7000 | 7255 | 7248 | 7243 | 7250 | 7250 | 7250 | 7243 | 7238 | 6980 | 7252 |
| 2059 | 7250 | 7252 | 7103 | 7255 | 7255 | 7250 | 7250 | 7250 | 7250 | 7243 | 7248 | 7063 | 7252 |

|      | 1    | 2    | 3    | 4    | 5    | 6    | 7    | 8    | 9    | 10   | 11   | 12   | 13   |
|------|------|------|------|------|------|------|------|------|------|------|------|------|------|
| 2060 | 7250 | 7252 | 7192 | 7255 | 7255 | 7250 | 7250 | 7250 | 7250 | 7249 | 7249 | 7107 | 7252 |
| 2061 | 7250 | 7252 | 7207 | 7255 | 7255 | 7250 | 7250 | 7250 | 7250 | 7249 | 7249 | 7155 | 7252 |
| 2062 | 7250 | 7252 | 7237 | 7255 | 7255 | 7250 | 7250 | 7250 | 7250 | 7249 | 7249 | 7204 | 7252 |
| 2063 | 7250 | 7252 | 7243 | 7255 | 7255 | 7250 | 7250 | 7250 | 7250 | 7249 | 7249 | 7240 | 7252 |
| 2064 | 7250 | 7252 | 7249 | 7255 | 7255 | 7250 | 7250 | 7250 | 7250 | 7249 | 7249 | 7259 | 7252 |
| 2065 | 7250 | 7252 | 7249 | 7255 | 7255 | 7250 | 7250 | 7250 | 7250 | 7249 | 7249 | 7259 | 7252 |
| 2066 | 7250 | 7252 | 7251 | 7255 | 7255 | 7250 | 7250 | 7250 | 7250 | 7249 | 7249 | 7259 | 7252 |
| 2067 | 7250 | 7252 | 7251 | 7255 | 7255 | 7250 | 7250 | 7250 | 7250 | 7249 | 7249 | 7259 | 7252 |
| 2068 | 7250 | 7252 | 7251 | 7255 | 7255 | 7250 | 7250 | 7250 | 7250 | 7249 | 7249 | 7259 | 7252 |
| 2069 | 7250 | 7252 | 7251 | 7255 | 7255 | 7250 | 7250 | 7250 | 7250 | 7249 | 7249 | 7259 | 7252 |
| 2070 | 7250 | 7252 | 7251 | 7255 | 7255 | 7250 | 7250 | 7250 | 7250 | 7249 | 7249 | 7259 | 7252 |
| 2071 | 7250 | 7252 | 7251 | 7255 | 7255 | 7250 | 7250 | 7250 | 7250 | 7249 | 7249 | 7259 | 7252 |
| 2072 | 7250 | 7252 | 7251 | 7255 | 7255 | 7250 | 7250 | 7250 | 7250 | 7249 | 7249 | 7259 | 7252 |
| 2073 | 7250 | 7252 | 7251 | 7255 | 7255 | 7250 | 7250 | 7250 | 7250 | 7249 | 7249 | 7259 | 7252 |
| 2074 | 7250 | 7252 | 7251 | 7255 | 7255 | 7250 | 7250 | 7250 | 7250 | 7249 | 7249 | 7259 | 7252 |
| 2075 | 7250 | 7252 | 7251 | 7255 | 7255 | 7250 | 7250 | 7250 | 7250 | 7249 | 7249 | 7259 | 7252 |
| 2076 | 7250 | 7252 | 7251 | 7255 | 7255 | 7250 | 7250 | 7250 | 7250 | 7249 | 7249 | 7259 | 7252 |
| 2077 | 7250 | 7252 | 7251 | 7255 | 7255 | 7250 | 7250 | 7250 | 7250 | 7249 | 7249 | 7259 | 7252 |
| 2078 | 7250 | 7252 | 7251 | 7255 | 7255 | 7250 | 7250 | 7250 | 7250 | 7249 | 7249 | 7259 | 7252 |
| 2079 | 7250 | 7252 | 7251 | 7255 | 7255 | 7250 | 7250 | 7250 | 7250 | 7249 | 7249 | 7259 | 7252 |
| 2080 | 7250 | 7252 | 7251 | 7255 | 7255 | 7250 | 7250 | 7250 | 7250 | 7249 | 7249 | 7259 | 7252 |
| 2081 | 7250 | 7252 | 7251 | 7255 | 7255 | 7250 | 7250 | 7250 | 7250 | 7249 | 7249 | 7259 | 7252 |
| 2082 | 7250 | 7252 | 7251 | 7255 | 7255 | 7250 | 7250 | 7250 | 7250 | 7249 | 7249 | 7259 | 7252 |
| 2083 | 7250 | 7252 | 7251 | 7255 | 7255 | 7250 | 7250 | 7250 | 7250 | 7249 | 7249 | 7259 | 7252 |
| 2084 | 7250 | 7252 | 7251 | 7255 | 7255 | 7250 | 7250 | 7250 | 7250 | 7249 | 7249 | 7259 | 7252 |
| 2085 | 7250 | 7252 | 7251 | 7255 | 7255 | 7250 | 7250 | 7250 | 7250 | 7249 | 7249 | 7259 | 7252 |
| 2086 | 7250 | 7252 | 7251 | 7255 | 7255 | 7250 | 7250 | 7250 | 7250 | 7249 | 7249 | 7259 | 7252 |
| 2087 | 7250 | 7252 | 7251 | 7255 | 7255 | 7250 | 7250 | 7250 | 7250 | 7249 | 7249 | 7259 | 7252 |
| 2088 | 7250 | 7252 | 7251 | 7255 | 7255 | 7250 | 7250 | 7250 | 7250 | 7249 | 7249 | 7259 | 7252 |
| 2089 | 7250 | 7252 | 7251 | 7255 | 7255 | 7250 | 7250 | 7250 | 7250 | 7249 | 7249 | 7259 | 7252 |
| 2090 | 7250 | 7252 | 7251 | 7255 | 7255 | 7250 | 7250 | 7250 | 7250 | 7249 | 7249 | 7259 | 7252 |

|      | 14   | 15   | 16   | 17   | 18   | 19   | 20   | 21   | 22   | 23   | 24   | 25   | 26   |
|------|------|------|------|------|------|------|------|------|------|------|------|------|------|
| 2002 | 0    | 0    | 0    | 0    | 0    | 0    | 0    | 0    | 0    | 0    | 0    | 0    | 0    |
| 2003 | 0    | 0    | 0    | 0    | 0    | 0    | 0    | 0    | 0    | 0    | 0    | 0    | 0    |
| 2004 | 0    | 0    | 0    | 0    | 0    | 0    | 0    | 0    | 0    | 0    | 0    | 0    | 0    |
| 2005 | 0    | 0    | 0    | 0    | 0    | 0    | 0    | 0    | 0    | 0    | 0    | 0    | 0    |
| 2006 | 0    | 0    | 0    | 0    | 0    | 0    | 0    | 0    | 0    | 0    | 0    | 0    | 0    |
| 2007 | 0    | 0    | 0    | 0    | 0    | 0    | 0    | 0    | 0    | 0    | 0    | 0    | 0    |
| 2008 | 0    | 0    | 0    | 0    | 0    | 0    | 0    | 0    | 0    | 0    | 0    | 0    | 0    |
| 2009 | 0    | 0    | 0    | 0    | 0    | 0    | 0    | 0    | 0    | 0    | 0    | 0    | 0    |
| 2010 | 0    | 0    | 0    | 0    | 0    | 0    | 0    | 0    | 0    | 0    | 0    | 0    | 0    |
| 2011 | 0    | 0    | 0    | 0    | 0    | 0    | 0    | 0    | 0    | 0    | 0    | 0    | 0    |
| 2012 | 0    | 0    | 0    | 0    | 0    | 0    | 0    | 0    | 0    | 0    | 0    | 0    | 0    |
| 2013 | 0    | 0    | 0    | 0    | 0    | 0    | 0    | 0    | 0    | 0    | 0    | 0    | 0    |
| 2014 | 0    | 0    | 0    | 0    | 0    | 0    | 0    | 0    | 0    | 0    | 0    | 0    | 0    |
| 2015 | 0    | 0    | 0    | 0    | 0    | 0    | 0    | 0    | 0    | 0    | 0    | 0    | 0    |
| 2016 | 0    | 0    | 0    | 0    | 0    | 0    | 0    | 0    | 0    | 0    | 0    | 0    | 0    |
| 2017 | 0    | 0    | 0    | 0    | 0    | 0    | 0    | 0    | 0    | 0    | 0    | 0    | 0    |
| 2018 | 0    | 0    | 0    | 0    | 0    | 0    | 0    | 0    | 0    | 0    | 0    | 0    | 0    |
| 2019 | 0    | 0    | 0    | 0    | 0    | 0    | 0    | 0    | 0    | 0    | 0    | 0    | 0    |
| 2020 | 0    | 0    | 0    | 0    | 0    | 0    | 0    | 0    | 250  | 0    | 0    | 0    | 0    |
| 2021 | 0    | 0    | 0    | 0    | 0    | 0    | 0    | 0    | 510  | 0    | 0    | 0    | 0    |
| 2022 | 0    | 0    | 0    | 0    | 0    | 0    | 0    | 0    | 755  | 0    | 0    | 0    | 0    |
| 2023 | 0    | 0    | 0    | 0    | 0    | 0    | 0    | 0    | 1016 | 0    | 0    | 0    | 0    |
| 2024 | 0    | 0    | 0    | 0    | 0    | 0    | 0    | 0    | 1288 | 0    | 0    | 0    | 0    |
| 2025 | 250  | 248  | 250  | 250  | 250  | 250  | 250  | 0    | 1538 | 250  | 250  | 250  | 250  |
| 2026 | 500  | 505  | 500  | 500  | 500  | 500  | 500  | 0    | 1797 | 500  | 503  | 500  | 500  |
| 2027 | 758  | 775  | 769  | 769  | 769  | 764  | 760  | 0    | 2060 | 758  | 772  | 769  | 769  |
| 2028 | 1002 | 1027 | 1020 | 1020 | 1020 | 1010 | 1003 | 0    | 2344 | 1011 | 1027 | 1020 | 1020 |
| 2029 | 1256 | 1285 | 1278 | 1278 | 1278 | 1262 | 1255 | 0    | 2612 | 1263 | 1285 | 1272 | 1272 |
| 2030 | 1529 | 1562 | 1555 | 1555 | 1555 | 1528 | 1515 | 250  | 2888 | 1521 | 1562 | 1533 | 1533 |
| 2031 | 1780 | 1822 | 1817 | 1817 | 1817 | 1778 | 1765 | 500  | 3175 | 1769 | 1828 | 1783 | 1783 |
| 2032 | 2030 | 2089 | 2085 | 2085 | 2085 | 2033 | 2017 | 751  | 3441 | 2029 | 2090 | 2042 | 2042 |
| 2033 | 2295 | 2343 | 2354 | 2354 | 2354 | 2309 | 2289 | 1015 | 3716 | 2303 | 2355 | 2320 | 2320 |
| 2034 | 2560 | 2646 | 2645 | 2645 | 2645 | 2579 | 2556 | 1271 | 3988 | 2561 | 2639 | 2595 | 2595 |
| 2035 | 2797 | 2933 | 2927 | 2927 | 2927 | 2863 | 2842 | 1543 | 4240 | 2812 | 2943 | 2875 | 2875 |
| 2036 | 3039 | 3207 | 3184 | 3184 | 3184 | 3115 | 3085 | 1798 | 4495 | 3038 | 3213 | 3127 | 3127 |
| 2037 | 3296 | 3470 | 3439 | 3439 | 3439 | 3379 | 3340 | 2061 | 4740 | 3281 | 3496 | 3397 | 3397 |
| 2038 | 3544 | 3725 | 3661 | 3661 | 3661 | 3634 | 3602 | 2335 | 4972 | 3534 | 3746 | 3648 | 3648 |
| 2039 | 3775 | 3990 | 3899 | 3899 | 3899 | 3907 | 3862 | 2611 | 5245 | 3776 | 3998 | 3915 | 3915 |
| 2040 | 4017 | 4255 | 4159 | 4159 | 4159 | 4188 | 4127 | 2889 | 5519 | 4044 | 4279 | 4196 | 4196 |
| 2041 | 4270 | 4523 | 4419 | 4419 | 4419 | 4452 | 4391 | 3175 | 5779 | 4300 | 4555 | 4461 | 4461 |
| 2042 | 4530 | 4784 | 4677 | 4677 | 4677 | 4741 | 4683 | 3437 | 6032 | 4565 | 4840 | 4751 | 4751 |
| 2043 | 4793 | 5016 | 4925 | 4925 | 4925 | 4995 | 4939 | 3707 | 6310 | 4817 | 5097 | 5004 | 5004 |
| 2044 | 5040 | 5227 | 5135 | 5135 | 5135 | 5249 | 5193 | 3971 | 6442 | 5092 | 5362 | 5260 | 5260 |
| 2045 | 5260 | 5448 | 5337 | 5337 | 5337 | 5497 | 5433 | 4229 | 6589 | 5354 | 5618 | 5498 | 5498 |
| 2046 | 5473 | 5667 | 5514 | 5514 | 5514 | 5663 | 5612 | 4484 | 6828 | 5489 | 5858 | 5675 | 5675 |
| 2047 | 5628 | 5895 | 5715 | 5715 | 5715 | 5846 | 5768 | 4594 | 7050 | 5660 | 6011 | 5820 | 5820 |
| 2048 | 5769 | 5964 | 5835 | 5835 | 5835 | 6041 | 5965 | 4750 | 7171 | 5926 | 6243 | 6058 | 6058 |
| 2049 | 6009 | 6102 | 5914 | 5914 | 5914 | 6280 | 6159 | 4979 | 7212 | 6074 | 6445 | 6255 | 6255 |
| 2050 | 6141 | 6335 | 6141 | 6141 | 6141 | 6484 | 6340 | 5254 | 7232 | 6266 | 6697 | 6461 | 6461 |
| 2051 | 6338 | 6571 | 6336 | 6336 | 6336 | 6741 | 6549 | 5410 | 7245 | 6475 | 6937 | 6682 | 6682 |
| 2052 | 6563 | 6816 | 6574 | 6574 | 6574 | 6975 | 6800 | 5635 | 7245 | 6721 | 7076 | 6924 | 6924 |
| 2053 | 6835 | 7026 | 6793 | 6793 | 6793 | 7112 | 6980 | 5845 | 7251 | 6916 | 7160 | 7077 | 7077 |
| 2054 | 7030 | 7151 | 6992 | 6992 | 6992 | 7175 | 7087 | 6047 | 7251 | 7076 | 7203 | 7166 | 7166 |
| 2055 | 7125 | 7206 | 7118 | 7118 | 7118 | 7212 | 7149 | 6263 | 7251 | 7166 | 7232 | 7206 | 7206 |
| 2056 | 7181 | 7239 | 7182 | 7182 | 7182 | 7233 | 7212 | 6507 | 7251 | 7206 | 7247 | 7235 | 7235 |
| 2057 | 7214 | 7267 | 7219 | 7219 | 7219 | 7248 | 7246 | 6741 | 7251 | 7235 | 7253 | 7254 | 7254 |
| 2058 | 7242 | 7267 | 7244 | 7244 | 7244 | 7248 | 7247 | 6950 | 7251 | 7254 | 7253 | 7254 | 7254 |
| 2059 | 7252 | 7267 | 7250 | 7250 | 7250 | 7249 | 7248 | 7050 | 7251 | 7254 | 7253 | 7254 | 7254 |

|      | 14   | 15   | 16   | 17   | 18   | 19   | 20   | 21   | 22   | 23   | 24   | 25   | 26   |
|------|------|------|------|------|------|------|------|------|------|------|------|------|------|
| 2060 | 7252 | 7267 | 7250 | 7250 | 7250 | 7249 | 7248 | 7118 | 7251 | 7254 | 7253 | 7254 | 7254 |
| 2061 | 7252 | 7267 | 7250 | 7250 | 7250 | 7249 | 7249 | 7175 | 7251 | 7254 | 7253 | 7254 | 7254 |
| 2062 | 7252 | 7267 | 7250 | 7250 | 7250 | 7249 | 7249 | 7217 | 7251 | 7254 | 7253 | 7254 | 7254 |
| 2063 | 7252 | 7267 | 7250 | 7250 | 7250 | 7249 | 7249 | 7247 | 7251 | 7254 | 7253 | 7254 | 7254 |
| 2064 | 7252 | 7267 | 7250 | 7250 | 7250 | 7249 | 7249 | 7265 | 7251 | 7254 | 7253 | 7254 | 7254 |
| 2065 | 7252 | 7267 | 7250 | 7250 | 7250 | 7249 | 7249 | 7265 | 7251 | 7254 | 7253 | 7254 | 7254 |
| 2066 | 7252 | 7267 | 7250 | 7250 | 7250 | 7249 | 7249 | 7265 | 7251 | 7254 | 7253 | 7254 | 7254 |
| 2067 | 7252 | 7267 | 7250 | 7250 | 7250 | 7249 | 7249 | 7265 | 7251 | 7254 | 7253 | 7254 | 7254 |
| 2068 | 7252 | 7267 | 7250 | 7250 | 7250 | 7249 | 7249 | 7265 | 7251 | 7254 | 7253 | 7254 | 7254 |
| 2069 | 7252 | 7267 | 7250 | 7250 | 7250 | 7249 | 7249 | 7265 | 7251 | 7254 | 7253 | 7254 | 7254 |
| 2070 | 7252 | 7267 | 7250 | 7250 | 7250 | 7249 | 7249 | 7265 | 7251 | 7254 | 7253 | 7254 | 7254 |
| 2071 | 7252 | 7267 | 7250 | 7250 | 7250 | 7249 | 7249 | 7265 | 7251 | 7254 | 7253 | 7254 | 7254 |
| 2072 | 7252 | 7267 | 7250 | 7250 | 7250 | 7249 | 7249 | 7265 | 7251 | 7254 | 7253 | 7254 | 7254 |
| 2073 | 7252 | 7267 | 7250 | 7250 | 7250 | 7249 | 7249 | 7265 | 7251 | 7254 | 7253 | 7254 | 7254 |
| 2074 | 7252 | 7267 | 7250 | 7250 | 7250 | 7249 | 7249 | 7265 | 7251 | 7254 | 7253 | 7254 | 7254 |
| 2075 | 7252 | 7267 | 7250 | 7250 | 7250 | 7249 | 7249 | 7265 | 7251 | 7254 | 7253 | 7254 | 7254 |
| 2076 | 7252 | 7267 | 7250 | 7250 | 7250 | 7249 | 7249 | 7265 | 7251 | 7254 | 7253 | 7254 | 7254 |
| 2077 | 7252 | 7267 | 7250 | 7250 | 7250 | 7249 | 7249 | 7265 | 7251 | 7254 | 7253 | 7254 | 7254 |
| 2078 | 7252 | 7267 | 7250 | 7250 | 7250 | 7249 | 7249 | 7265 | 7251 | 7254 | 7253 | 7254 | 7254 |
| 2079 | 7252 | 7267 | 7250 | 7250 | 7250 | 7249 | 7249 | 7265 | 7251 | 7254 | 7253 | 7254 | 7254 |
| 2080 | 7252 | 7267 | 7250 | 7250 | 7250 | 7249 | 7249 | 7265 | 7251 | 7254 | 7253 | 7254 | 7254 |
| 2081 | 7252 | 7267 | 7250 | 7250 | 7250 | 7249 | 7249 | 7265 | 7251 | 7254 | 7253 | 7254 | 7254 |
| 2082 | 7252 | 7267 | 7250 | 7250 | 7250 | 7249 | 7249 | 7265 | 7251 | 7254 | 7253 | 7254 | 7254 |
| 2083 | 7252 | 7267 | 7250 | 7250 | 7250 | 7249 | 7249 | 7265 | 7251 | 7254 | 7253 | 7254 | 7254 |
| 2084 | 7252 | 7267 | 7250 | 7250 | 7250 | 7249 | 7249 | 7265 | 7251 | 7254 | 7253 | 7254 | 7254 |
| 2085 | 7252 | 7267 | 7250 | 7250 | 7250 | 7249 | 7249 | 7265 | 7251 | 7254 | 7253 | 7254 | 7254 |
| 2086 | 7252 | 7267 | 7250 | 7250 | 7250 | 7249 | 7249 | 7265 | 7251 | 7254 | 7253 | 7254 | 7254 |
| 2087 | 7252 | 7267 | 7250 | 7250 | 7250 | 7249 | 7249 | 7265 | 7251 | 7254 | 7253 | 7254 | 7254 |
| 2088 | 7252 | 7267 | 7250 | 7250 | 7250 | 7249 | 7249 | 7265 | 7251 | 7254 | 7253 | 7254 | 7254 |
| 2089 | 7252 | 7267 | 7250 | 7250 | 7250 | 7249 | 7249 | 7265 | 7251 | 7254 | 7253 | 7254 | 7254 |
| 2090 | 7252 | 7267 | 7250 | 7250 | 7250 | 7249 | 7249 | 7265 | 7251 | 7254 | 7253 | 7254 | 7254 |



|      | 27   | 28   | 29   | 30   | 31   | 32   | 33   | 34   | 35   | 36   | 37   | 38   | 39   |
|------|------|------|------|------|------|------|------|------|------|------|------|------|------|
| 2002 | 0    | 0    | 0    | 0    | 0    | 0    | 0    | 0    | 0    | 0    | 0    | 0    | 0    |
| 2003 | 0    | 0    | 0    | 0    | 0    | 0    | 0    | 0    | 0    | 0    | 0    | 0    | 0    |
| 2004 | 0    | 0    | 0    | 0    | 0    | 0    | 0    | 0    | 0    | 0    | 0    | 0    | 0    |
| 2005 | 0    | 0    | 0    | 0    | 0    | 0    | 0    | 0    | 0    | 0    | 0    | 0    | 0    |
| 2006 | 0    | 0    | 0    | 0    | 0    | 0    | 0    | 0    | 0    | 0    | 0    | 0    | 0    |
| 2007 | 0    | 0    | 0    | 0    | 0    | 0    | 0    | 0    | 0    | 0    | 0    | 0    | 0    |
| 2008 | 0    | 0    | 0    | 0    | 0    | 0    | 0    | 0    | 0    | 0    | 0    | 0    | 0    |
| 2009 | 0    | 0    | 0    | 0    | 0    | 0    | 0    | 0    | 0    | 0    | 0    | 0    | 0    |
| 2010 | 0    | 0    | 0    | 0    | 0    | 0    | 0    | 0    | 0    | 0    | 0    | 0    | 0    |
| 2011 | 0    | 0    | 0    | 0    | 0    | 0    | 0    | 0    | 0    | 0    | 0    | 0    | 0    |
| 2012 | 0    | 0    | 0    | 0    | 0    | 0    | 0    | 0    | 0    | 0    | 0    | 0    | 0    |
| 2013 | 0    | 0    | 0    | 0    | 0    | 0    | 0    | 0    | 0    | 0    | 0    | 0    | 0    |
| 2014 | 0    | 0    | 0    | 0    | 0    | 0    | 0    | 0    | 0    | 0    | 0    | 0    | 0    |
| 2015 | 0    | 0    | 0    | 0    | 0    | 0    | 0    | 0    | 0    | 0    | 0    | 0    | 0    |
| 2016 | 0    | 0    | 0    | 0    | 0    | 0    | 0    | 0    | 0    | 0    | 0    | 0    | 0    |
| 2017 | 0    | 0    | 0    | 0    | 0    | 0    | 0    | 0    | 0    | 0    | 0    | 0    | 0    |
| 2018 | 0    | 0    | 0    | 0    | 0    | 0    | 0    | 0    | 0    | 0    | 0    | 0    | 0    |
| 2019 | 0    | 0    | 0    | 0    | 0    | 0    | 0    | 0    | 0    | 0    | 0    | 0    | 0    |
| 2020 | 0    | 0    | 0    | 0    | 254  | 0    | 0    | 0    | 0    | 0    | 0    | 0    | 0    |
| 2021 | 0    | 0    | 0    | 0    | 506  | 0    | 0    | 0    | 0    | 0    | 0    | 0    | 0    |
| 2022 | 0    | 0    | 0    | 0    | 760  | 0    | 0    | 0    | 0    | 0    | 0    | 0    | 0    |
| 2023 | 0    | 0    | 0    | 0    | 1017 | 0    | 0    | 0    | 0    | 0    | 0    | 0    | 0    |
| 2024 | 0    | 0    | 0    | 0    | 1268 | 0    | 0    | 0    | 0    | 0    | 0    | 0    | 0    |
| 2025 | 250  | 256  | 256  | 0    | 1537 | 256  | 256  | 256  | 256  | 256  | 250  | 250  | 0    |
| 2026 | 500  | 506  | 506  | 0    | 1793 | 506  | 506  | 506  | 506  | 506  | 504  | 501  | 0    |
| 2027 | 769  | 757  | 757  | 0    | 2050 | 757  | 757  | 757  | 757  | 757  | 767  | 762  | 0    |
| 2028 | 1020 | 1011 | 1011 | 0    | 2308 | 1011 | 1011 | 1011 | 1011 | 1011 | 1021 | 1014 | 0    |
| 2029 | 1272 | 1261 | 1261 | 0    | 2596 | 1261 | 1261 | 1261 | 1261 | 1261 | 1287 | 1277 | 0    |
| 2030 | 1533 | 1513 | 1513 | 256  | 2891 | 1513 | 1513 | 1513 | 1513 | 1513 | 1555 | 1546 | 250  |
| 2031 | 1783 | 1771 | 1771 | 509  | 3163 | 1771 | 1776 | 1771 | 1771 | 1771 | 1815 | 1806 | 504  |
| 2032 | 2042 | 2027 | 2027 | 759  | 3480 | 2027 | 2068 | 2027 | 2027 | 2027 | 2096 | 2082 | 765  |
| 2033 | 2320 | 2301 | 2292 | 1016 | 3826 | 2277 | 2366 | 2293 | 2293 | 2293 | 2371 | 2355 | 1032 |
| 2034 | 2595 | 2566 | 2557 | 1271 | 4136 | 2536 | 2663 | 2558 | 2558 | 2558 | 2679 | 2654 | 1306 |
| 2035 | 2875 | 2849 | 2837 | 1523 | 4476 | 2803 | 2967 | 2841 | 2841 | 2841 | 2958 | 2945 | 1582 |
| 2036 | 3127 | 3189 | 3158 | 1790 | 4784 | 3090 | 3251 | 3182 | 3182 | 3182 | 3227 | 3212 | 1859 |
| 2037 | 3397 | 3520 | 3474 | 2052 | 5022 | 3367 | 3543 | 3507 | 3507 | 3507 | 3494 | 3475 | 2137 |
| 2038 | 3648 | 3854 | 3808 | 2314 | 5322 | 3731 | 3820 | 3841 | 3841 | 3841 | 3719 | 3703 | 2464 |
| 2039 | 3915 | 4161 | 4091 | 2579 | 5645 | 4033 | 4118 | 4146 | 4146 | 4146 | 3959 | 3939 | 2755 |
| 2040 | 4196 | 4510 | 4439 | 2874 | 5938 | 4408 | 4437 | 4496 | 4496 | 4496 | 4221 | 4202 | 3035 |
| 2041 | 4461 | 4793 | 4718 | 3166 | 6140 | 4686 | 4755 | 4776 | 4776 | 4776 | 4482 | 4462 | 3342 |
| 2042 | 4751 | 5105 | 5051 | 3516 | 6289 | 5132 | 5082 | 5137 | 5137 | 5137 | 4733 | 4701 | 3613 |
| 2043 | 5004 | 5319 | 5220 | 3844 | 6491 | 5246 | 5436 | 5291 | 5291 | 5291 | 4971 | 4942 | 3885 |
| 2044 | 5260 | 5493 | 5391 | 4149 | 6667 | 5440 | 5598 | 5462 | 5462 | 5462 | 5187 | 5153 | 4165 |
| 2045 | 5498 | 5700 | 5603 | 4322 | 6844 | 5641 | 5830 | 5673 | 5673 | 5673 | 5378 | 5348 | 4410 |
| 2046 | 5675 | 5906 | 5799 | 4530 | 7032 | 5842 | 6061 | 5871 | 5871 | 5871 | 5558 | 5530 | 4644 |
| 2047 | 5820 | 6110 | 6003 | 4759 | 7147 | 6024 | 6245 | 6083 | 6083 | 6083 | 5754 | 5720 | 4831 |
| 2048 | 6058 | 6288 | 6194 | 4978 | 7187 | 6214 | 6413 | 6271 | 6271 | 6271 | 5886 | 5861 | 4972 |
| 2049 | 6255 | 6455 | 6351 | 5192 | 7227 | 6384 | 6590 | 6443 | 6443 | 6443 | 5942 | 5924 | 5211 |
| 2050 | 6461 | 6646 | 6550 | 5392 | 7238 | 6585 | 6779 | 6623 | 6623 | 6623 | 6176 | 6146 | 5417 |
| 2051 | 6682 | 6840 | 6738 | 5604 | 7242 | 6776 | 6932 | 6812 | 6812 | 6812 | 6373 | 6322 | 5594 |
| 2052 | 6924 | 6989 | 6911 | 5803 | 7248 | 6957 | 7055 | 6966 | 6966 | 6966 | 6582 | 6527 | 5791 |
| 2053 | 7077 | 7104 | 7039 | 5970 | 7252 | 7074 | 7142 | 7082 | 7082 | 7082 | 6783 | 6744 | 5997 |
| 2054 | 7166 | 7178 | 7124 | 6176 | 7252 | 7155 | 7209 | 7166 | 7166 | 7166 | 6986 | 6952 | 6192 |
| 2055 | 7206 | 7230 | 7199 | 6381 | 7252 | 7213 | 7235 | 7231 | 7231 | 7231 | 7102 | 7079 | 6408 |
| 2056 | 7235 | 7237 | 7227 | 6578 | 7252 | 7231 | 7241 | 7240 | 7240 | 7240 | 7170 | 7156 | 6646 |
| 2057 | 7254 | 7247 | 7238 | 6766 | 7252 | 7235 | 7253 | 7252 | 7252 | 7252 | 7214 | 7207 | 6847 |
| 2058 | 7254 | 7248 | 7249 | 6910 | 7252 | 7247 | 7253 | 7252 | 7252 | 7252 | 7236 | 7243 | 6984 |
| 2059 | 7254 | 7253 | 7253 | 7027 | 7252 | 7250 | 7253 | 7252 | 7252 | 7252 | 7245 | 7252 | 7064 |

|      | 27   | 28   | 29   | 30   | 31   | 32   | 33   | 34   | 35   | 36   | 37   | 38   | 39   |
|------|------|------|------|------|------|------|------|------|------|------|------|------|------|
| 2060 | 7254 | 7253 | 7253 | 7124 | 7252 | 7250 | 7253 | 7252 | 7252 | 7252 | 7245 | 7252 | 7116 |
| 2061 | 7254 | 7253 | 7253 | 7193 | 7252 | 7250 | 7253 | 7252 | 7252 | 7252 | 7249 | 7252 | 7156 |
| 2062 | 7254 | 7253 | 7253 | 7231 | 7252 | 7250 | 7253 | 7252 | 7252 | 7252 | 7249 | 7252 | 7196 |
| 2063 | 7254 | 7253 | 7253 | 7239 | 7252 | 7250 | 7253 | 7252 | 7252 | 7252 | 7249 | 7252 | 7236 |
| 2064 | 7254 | 7253 | 7253 | 7242 | 7252 | 7250 | 7253 | 7252 | 7252 | 7252 | 7249 | 7252 | 7251 |
| 2065 | 7254 | 7253 | 7253 | 7247 | 7252 | 7250 | 7253 | 7252 | 7252 | 7252 | 7249 | 7252 | 7251 |
| 2066 | 7254 | 7253 | 7253 | 7250 | 7252 | 7250 | 7253 | 7252 | 7252 | 7252 | 7249 | 7252 | 7251 |
| 2067 | 7254 | 7253 | 7253 | 7250 | 7252 | 7250 | 7253 | 7252 | 7252 | 7252 | 7249 | 7252 | 7251 |
| 2068 | 7254 | 7253 | 7253 | 7250 | 7252 | 7250 | 7253 | 7252 | 7252 | 7252 | 7249 | 7252 | 7251 |
| 2069 | 7254 | 7253 | 7253 | 7250 | 7252 | 7250 | 7253 | 7252 | 7252 | 7252 | 7249 | 7252 | 7251 |
| 2070 | 7254 | 7253 | 7253 | 7250 | 7252 | 7250 | 7253 | 7252 | 7252 | 7252 | 7249 | 7252 | 7251 |
| 2071 | 7254 | 7253 | 7253 | 7250 | 7252 | 7250 | 7253 | 7252 | 7252 | 7252 | 7249 | 7252 | 7251 |
| 2072 | 7254 | 7253 | 7253 | 7250 | 7252 | 7250 | 7253 | 7252 | 7252 | 7252 | 7249 | 7252 | 7251 |
| 2073 | 7254 | 7253 | 7253 | 7250 | 7252 | 7250 | 7253 | 7252 | 7252 | 7252 | 7249 | 7252 | 7251 |
| 2074 | 7254 | 7253 | 7253 | 7250 | 7252 | 7250 | 7253 | 7252 | 7252 | 7252 | 7249 | 7252 | 7251 |
| 2075 | 7254 | 7253 | 7253 | 7250 | 7252 | 7250 | 7253 | 7252 | 7252 | 7252 | 7249 | 7252 | 7251 |
| 2076 | 7254 | 7253 | 7253 | 7250 | 7252 | 7250 | 7253 | 7252 | 7252 | 7252 | 7249 | 7252 | 7251 |
| 2077 | 7254 | 7253 | 7253 | 7250 | 7252 | 7250 | 7253 | 7252 | 7252 | 7252 | 7249 | 7252 | 7251 |
| 2078 | 7254 | 7253 | 7253 | 7250 | 7252 | 7250 | 7253 | 7252 | 7252 | 7252 | 7249 | 7252 | 7251 |
| 2079 | 7254 | 7253 | 7253 | 7250 | 7252 | 7250 | 7253 | 7252 | 7252 | 7252 | 7249 | 7252 | 7251 |
| 2080 | 7254 | 7253 | 7253 | 7250 | 7252 | 7250 | 7253 | 7252 | 7252 | 7252 | 7249 | 7252 | 7251 |
| 2081 | 7254 | 7253 | 7253 | 7250 | 7252 | 7250 | 7253 | 7252 | 7252 | 7252 | 7249 | 7252 | 7251 |
| 2082 | 7254 | 7253 | 7253 | 7250 | 7252 | 7250 | 7253 | 7252 | 7252 | 7252 | 7249 | 7252 | 7251 |
| 2083 | 7254 | 7253 | 7253 | 7250 | 7252 | 7250 | 7253 | 7252 | 7252 | 7252 | 7249 | 7252 | 7251 |
| 2084 | 7254 | 7253 | 7253 | 7250 | 7252 | 7250 | 7253 | 7252 | 7252 | 7252 | 7249 | 7252 | 7251 |
| 2085 | 7254 | 7253 | 7253 | 7250 | 7252 | 7250 | 7253 | 7252 | 7252 | 7252 | 7249 | 7252 | 7251 |
| 2086 | 7254 | 7253 | 7253 | 7250 | 7252 | 7250 | 7253 | 7252 | 7252 | 7252 | 7249 | 7252 | 7251 |
| 2087 | 7254 | 7253 | 7253 | 7250 | 7252 | 7250 | 7253 | 7252 | 7252 | 7252 | 7249 | 7252 | 7251 |
| 2088 | 7254 | 7253 | 7253 | 7250 | 7252 | 7250 | 7253 | 7252 | 7252 | 7252 | 7249 | 7252 | 7251 |
| 2089 | 7254 | 7253 | 7253 | 7250 | 7252 | 7250 | 7253 | 7252 | 7252 | 7252 | 7249 | 7252 | 7251 |
| 2090 | 7254 | 7253 | 7253 | 7250 | 7252 | 7250 | 7253 | 7252 | 7252 | 7252 | 7249 | 7252 | 7251 |

|      | 40   | 41   | 42   | 43   | 44   | 45   | 46   | 47   | 48   | 49   | 50   | 51   | 52   |
|------|------|------|------|------|------|------|------|------|------|------|------|------|------|
| 2002 | 0    | 0    | 0    | 0    | 0    | 0    | 0    | 0    | 0    | 0    | 0    | 0    | 0    |
| 2003 | 0    | 0    | 0    | 0    | 0    | 0    | 0    | 0    | 0    | 0    | 0    | 0    | 0    |
| 2004 | 0    | 0    | 0    | 0    | 0    | 0    | 0    | 0    | 0    | 0    | 0    | 0    | 0    |
| 2005 | 0    | 0    | 0    | 0    | 0    | 0    | 0    | 0    | 0    | 0    | 0    | 0    | 0    |
| 2006 | 0    | 0    | 0    | 0    | 0    | 0    | 0    | 0    | 0    | 0    | 0    | 0    | 0    |
| 2007 | 0    | 0    | 0    | 0    | 0    | 0    | 0    | 0    | 0    | 0    | 0    | 0    | 0    |
| 2008 | 0    | 0    | 0    | 0    | 0    | 0    | 0    | 0    | 0    | 0    | 0    | 0    | 0    |
| 2009 | 0    | 0    | 0    | 0    | 0    | 0    | 0    | 0    | 0    | 0    | 0    | 0    | 0    |
| 2010 | 0    | 0    | 0    | 0    | 0    | 0    | 0    | 0    | 0    | 0    | 0    | 0    | 0    |
| 2011 | 0    | 0    | 0    | 0    | 0    | 0    | 0    | 0    | 0    | 0    | 0    | 0    | 0    |
| 2012 | 0    | 0    | 0    | 0    | 0    | 0    | 0    | 0    | 0    | 0    | 0    | 0    | 0    |
| 2013 | 0    | 0    | 0    | 0    | 0    | 0    | 0    | 0    | 0    | 0    | 0    | 0    | 0    |
| 2014 | 0    | 0    | 0    | 0    | 0    | 0    | 0    | 0    | 0    | 0    | 0    | 0    | 0    |
| 2015 | 0    | 0    | 0    | 0    | 0    | 0    | 0    | 0    | 0    | 0    | 0    | 0    | 0    |
| 2016 | 0    | 0    | 0    | 0    | 0    | 0    | 0    | 0    | 0    | 0    | 0    | 0    | 0    |
| 2017 | 0    | 0    | 0    | 0    | 0    | 0    | 0    | 0    | 0    | 0    | 0    | 0    | 0    |
| 2018 | 0    | 0    | 0    | 0    | 0    | 0    | 0    | 0    | 0    | 0    | 0    | 0    | 0    |
| 2019 | 0    | 0    | 0    | 0    | 0    | 0    | 0    | 0    | 0    | 0    | 0    | 0    | 0    |
| 2020 | 250  | 0    | 0    | 0    | 0    | 0    | 0    | 0    | 0    | 250  | 0    | 0    | 0    |
| 2021 | 510  | 0    | 0    | 0    | 0    | 0    | 0    | 0    | 0    | 510  | 0    | 0    | 0    |
| 2022 | 755  | 0    | 0    | 0    | 0    | 0    | 0    | 0    | 0    | 755  | 0    | 0    | 0    |
| 2023 | 1016 | 0    | 0    | 0    | 0    | 0    | 0    | 0    | 0    | 1016 | 0    | 0    | 0    |
| 2024 | 1296 | 0    | 0    | 0    | 0    | 0    | 0    | 0    | 0    | 1286 | 0    | 0    | 0    |
| 2025 | 1552 | 250  | 248  | 250  | 250  | 250  | 250  | 250  | 0    | 1536 | 250  | 250  | 250  |
| 2026 | 1815 | 500  | 522  | 504  | 504  | 504  | 500  | 500  | 0    | 1795 | 500  | 510  | 500  |
| 2027 | 2087 | 758  | 795  | 769  | 769  | 769  | 759  | 756  | 0    | 2056 | 758  | 775  | 760  |
| 2028 | 2392 | 1006 | 1049 | 1025 | 1025 | 1025 | 1007 | 1003 | 0    | 2340 | 1015 | 1041 | 1008 |
| 2029 | 2680 | 1264 | 1321 | 1291 | 1291 | 1291 | 1259 | 1255 | 0    | 2608 | 1267 | 1305 | 1260 |
| 2030 | 2950 | 1534 | 1584 | 1563 | 1563 | 1563 | 1533 | 1520 | 250  | 2882 | 1527 | 1579 | 1533 |
| 2031 | 3248 | 1790 | 1859 | 1825 | 1825 | 1825 | 1785 | 1772 | 500  | 3181 | 1774 | 1857 | 1785 |
| 2032 | 3529 | 2048 | 2123 | 2109 | 2109 | 2109 | 2040 | 2025 | 751  | 3446 | 2030 | 2127 | 2040 |
| 2033 | 3795 | 2310 | 2389 | 2382 | 2382 | 2382 | 2302 | 2294 | 1019 | 3724 | 2298 | 2388 | 2303 |
| 2034 | 4066 | 2601 | 2679 | 2687 | 2687 | 2687 | 2575 | 2567 | 1284 | 3989 | 2561 | 2681 | 2576 |
| 2035 | 4317 | 2877 | 2973 | 2988 | 2988 | 2988 | 2873 | 2853 | 1559 | 4244 | 2841 | 2985 | 2865 |
| 2036 | 4561 | 3145 | 3272 | 3279 | 3279 | 3279 | 3139 | 3114 | 1817 | 4503 | 3090 | 3290 | 3123 |
| 2037 | 4781 | 3426 | 3546 | 3553 | 3553 | 3553 | 3404 | 3366 | 2099 | 4751 | 3350 | 3548 | 3392 |
| 2038 | 4995 | 3660 | 3792 | 3786 | 3786 | 3786 | 3689 | 3630 | 2395 | 4988 | 3606 | 3811 | 3673 |
| 2039 | 5200 | 3900 | 4045 | 4019 | 4019 | 4019 | 3955 | 3887 | 2681 | 5255 | 3878 | 4061 | 3939 |
| 2040 | 5410 | 4163 | 4329 | 4281 | 4281 | 4281 | 4258 | 4158 | 2963 | 5526 | 4153 | 4349 | 4220 |
| 2041 | 5649 | 4431 | 4584 | 4542 | 4542 | 4542 | 4524 | 4434 | 3249 | 5786 | 4421 | 4613 | 4496 |
| 2042 | 5819 | 4719 | 4843 | 4785 | 4785 | 4785 | 4799 | 4709 | 3512 | 6063 | 4695 | 4891 | 4781 |
| 2043 | 5998 | 4962 | 5074 | 5019 | 5019 | 5019 | 5049 | 4970 | 3784 | 6341 | 4940 | 5151 | 5031 |
| 2044 | 6183 | 5207 | 5280 | 5219 | 5219 | 5219 | 5301 | 5220 | 4051 | 6454 | 5197 | 5401 | 5283 |
| 2045 | 6350 | 5432 | 5495 | 5420 | 5420 | 5420 | 5554 | 5472 | 4299 | 6574 | 5450 | 5653 | 5535 |
| 2046 | 6500 | 5648 | 5709 | 5604 | 5604 | 5604 | 5724 | 5660 | 4553 | 6798 | 5569 | 5868 | 5706 |
| 2047 | 6562 | 5763 | 5934 | 5813 | 5813 | 5813 | 5871 | 5819 | 4685 | 6994 | 5721 | 6015 | 5839 |
| 2048 | 6581 | 5869 | 6049 | 5931 | 5931 | 5931 | 6077 | 6009 | 4839 | 7130 | 5950 | 6229 | 6052 |
| 2049 | 6820 | 6078 | 6282 | 6008 | 6008 | 6008 | 6281 | 6215 | 5056 | 7201 | 6119 | 6440 | 6264 |
| 2050 | 7029 | 6269 | 6495 | 6226 | 6226 | 6226 | 6471 | 6396 | 5275 | 7231 | 6289 | 6648 | 6445 |
| 2051 | 7148 | 6450 | 6714 | 6439 | 6439 | 6439 | 6677 | 6599 | 5459 | 7249 | 6504 | 6848 | 6650 |
| 2052 | 7192 | 6665 | 6919 | 6660 | 6660 | 6660 | 6900 | 6826 | 5648 | 7249 | 6715 | 7029 | 6874 |
| 2053 | 7219 | 6879 | 7077 | 6859 | 6859 | 6859 | 7061 | 7012 | 5862 | 7259 | 6922 | 7123 | 7039 |
| 2054 | 7239 | 7047 | 7158 | 7045 | 7045 | 7045 | 7153 | 7113 | 6066 | 7259 | 7057 | 7185 | 7137 |
| 2055 | 7249 | 7137 | 7204 | 7141 | 7141 | 7141 | 7205 | 7173 | 6278 | 7259 | 7142 | 7221 | 7189 |
| 2056 | 7249 | 7189 | 7234 | 7205 | 7205 | 7205 | 7241 | 7213 | 6497 | 7259 | 7199 | 7235 | 7225 |
| 2057 | 7249 | 7225 | 7245 | 7243 | 7243 | 7243 | 7255 | 7244 | 6723 | 7259 | 7235 | 7248 | 7240 |
| 2058 | 7249 | 7243 | 7253 | 7254 | 7254 | 7254 | 7255 | 7253 | 6918 | 7259 | 7255 | 7248 | 7240 |
| 2059 | 7249 | 7243 | 7253 | 7254 | 7254 | 7254 | 7255 | 7253 | 7028 | 7259 | 7255 | 7250 | 7249 |

|      | 40   | 41   | 42   | 43   | 44   | 45   | 46   | 47   | 48   | 49   | 50   | 51   | 52   |
|------|------|------|------|------|------|------|------|------|------|------|------|------|------|
| 2060 | 7249 | 7250 | 7253 | 7254 | 7254 | 7254 | 7255 | 7253 | 7093 | 7259 | 7255 | 7250 | 7249 |
| 2061 | 7249 | 7250 | 7253 | 7254 | 7254 | 7254 | 7255 | 7253 | 7140 | 7259 | 7255 | 7250 | 7249 |
| 2062 | 7249 | 7250 | 7253 | 7254 | 7254 | 7254 | 7255 | 7253 | 7180 | 7259 | 7255 | 7250 | 7249 |
| 2063 | 7249 | 7250 | 7253 | 7254 | 7254 | 7254 | 7255 | 7253 | 7216 | 7259 | 7255 | 7250 | 7249 |
| 2064 | 7249 | 7250 | 7253 | 7254 | 7254 | 7254 | 7255 | 7253 | 7240 | 7259 | 7255 | 7250 | 7249 |
| 2065 | 7249 | 7250 | 7253 | 7254 | 7254 | 7254 | 7255 | 7253 | 7245 | 7259 | 7255 | 7250 | 7249 |
| 2066 | 7249 | 7250 | 7253 | 7254 | 7254 | 7254 | 7255 | 7253 | 7245 | 7259 | 7255 | 7250 | 7249 |
| 2067 | 7249 | 7250 | 7253 | 7254 | 7254 | 7254 | 7255 | 7253 | 7249 | 7259 | 7255 | 7250 | 7249 |
| 2068 | 7249 | 7250 | 7253 | 7254 | 7254 | 7254 | 7255 | 7253 | 7249 | 7259 | 7255 | 7250 | 7249 |
| 2069 | 7249 | 7250 | 7253 | 7254 | 7254 | 7254 | 7255 | 7253 | 7249 | 7259 | 7255 | 7250 | 7249 |
| 2070 | 7249 | 7250 | 7253 | 7254 | 7254 | 7254 | 7255 | 7253 | 7249 | 7259 | 7255 | 7250 | 7249 |
| 2071 | 7249 | 7250 | 7253 | 7254 | 7254 | 7254 | 7255 | 7253 | 7249 | 7259 | 7255 | 7250 | 7249 |
| 2072 | 7249 | 7250 | 7253 | 7254 | 7254 | 7254 | 7255 | 7253 | 7249 | 7259 | 7255 | 7250 | 7249 |
| 2073 | 7249 | 7250 | 7253 | 7254 | 7254 | 7254 | 7255 | 7253 | 7249 | 7259 | 7255 | 7250 | 7249 |
| 2074 | 7249 | 7250 | 7253 | 7254 | 7254 | 7254 | 7255 | 7253 | 7249 | 7259 | 7255 | 7250 | 7249 |
| 2075 | 7249 | 7250 | 7253 | 7254 | 7254 | 7254 | 7255 | 7253 | 7249 | 7259 | 7255 | 7250 | 7249 |
| 2076 | 7249 | 7250 | 7253 | 7254 | 7254 | 7254 | 7255 | 7253 | 7249 | 7259 | 7255 | 7250 | 7249 |
| 2077 | 7249 | 7250 | 7253 | 7254 | 7254 | 7254 | 7255 | 7253 | 7249 | 7259 | 7255 | 7250 | 7249 |
| 2078 | 7249 | 7250 | 7253 | 7254 | 7254 | 7254 | 7255 | 7253 | 7249 | 7259 | 7255 | 7250 | 7249 |
| 2079 | 7249 | 7250 | 7253 | 7254 | 7254 | 7254 | 7255 | 7253 | 7249 | 7259 | 7255 | 7250 | 7249 |
| 2080 | 7249 | 7250 | 7253 | 7254 | 7254 | 7254 | 7255 | 7253 | 7249 | 7259 | 7255 | 7250 | 7249 |
| 2081 | 7249 | 7250 | 7253 | 7254 | 7254 | 7254 | 7255 | 7253 | 7249 | 7259 | 7255 | 7250 | 7249 |
| 2082 | 7249 | 7250 | 7253 | 7254 | 7254 | 7254 | 7255 | 7253 | 7249 | 7259 | 7255 | 7250 | 7249 |
| 2083 | 7249 | 7250 | 7253 | 7254 | 7254 | 7254 | 7255 | 7253 | 7249 | 7259 | 7255 | 7250 | 7249 |
| 2084 | 7249 | 7250 | 7253 | 7254 | 7254 | 7254 | 7255 | 7253 | 7249 | 7259 | 7255 | 7250 | 7249 |
| 2085 | 7249 | 7250 | 7253 | 7254 | 7254 | 7254 | 7255 | 7253 | 7249 | 7259 | 7255 | 7250 | 7249 |
| 2086 | 7249 | 7250 | 7253 | 7254 | 7254 | 7254 | 7255 | 7253 | 7249 | 7259 | 7255 | 7250 | 7249 |
| 2087 | 7249 | 7250 | 7253 | 7254 | 7254 | 7254 | 7255 | 7253 | 7249 | 7259 | 7255 | 7250 | 7249 |
| 2088 | 7249 | 7250 | 7253 | 7254 | 7254 | 7254 | 7255 | 7253 | 7249 | 7259 | 7255 | 7250 | 7249 |
| 2089 | 7249 | 7250 | 7253 | 7254 | 7254 | 7254 | 7255 | 7253 | 7249 | 7259 | 7255 | 7250 | 7249 |
| 2090 | 7249 | 7250 | 7253 | 7254 | 7254 | 7254 | 7255 | 7253 | 7249 | 7259 | 7255 | 7250 | 7249 |

|      | 53   | 54   | 55   | 56   | 57   | 58   | 59   | 60   | 61   | 62   | 63   | 64   | 65   |
|------|------|------|------|------|------|------|------|------|------|------|------|------|------|
| 2002 | 0    | 0    | 0    | 0    | 0    | 0    | 0    | 0    | 0    | 0    | 0    | 0    | 0    |
| 2003 | 0    | 0    | 0    | 0    | 0    | 0    | 0    | 0    | 0    | 0    | 0    | 0    | 0    |
| 2004 | 0    | 0    | 0    | 0    | 0    | 0    | 0    | 0    | 0    | 0    | 0    | 0    | 0    |
| 2005 | 0    | 0    | 0    | 0    | 0    | 0    | 0    | 0    | 0    | 0    | 0    | 0    | 0    |
| 2006 | 0    | 0    | 0    | 0    | 0    | 0    | 0    | 0    | 0    | 0    | 0    | 0    | 0    |
| 2007 | 0    | 0    | 0    | 0    | 0    | 0    | 0    | 0    | 0    | 0    | 0    | 0    | 0    |
| 2008 | 0    | 0    | 0    | 0    | 0    | 0    | 0    | 0    | 0    | 0    | 0    | 0    | 0    |
| 2009 | 0    | 0    | 0    | 0    | 0    | 0    | 0    | 0    | 0    | 0    | 0    | 0    | 0    |
| 2010 | 0    | 0    | 0    | 0    | 0    | 0    | 0    | 0    | 0    | 0    | 0    | 0    | 0    |
| 2011 | 0    | 0    | 0    | 0    | 0    | 0    | 0    | 0    | 0    | 0    | 0    | 0    | 0    |
| 2012 | 0    | 0    | 0    | 0    | 0    | 0    | 0    | 0    | 0    | 0    | 0    | 0    | 0    |
| 2013 | 0    | 0    | 0    | 0    | 0    | 0    | 0    | 0    | 0    | 0    | 0    | 0    | 0    |
| 2014 | 0    | 0    | 0    | 0    | 0    | 0    | 0    | 0    | 0    | 0    | 0    | 0    | 0    |
| 2015 | 0    | 0    | 0    | 0    | 0    | 0    | 0    | 0    | 0    | 0    | 0    | 0    | 0    |
| 2016 | 0    | 0    | 0    | 0    | 0    | 0    | 0    | 0    | 0    | 0    | 0    | 0    | 0    |
| 2017 | 0    | 0    | 0    | 0    | 0    | 0    | 0    | 0    | 0    | 0    | 0    | 0    | 0    |
| 2018 | 0    | 0    | 0    | 0    | 0    | 0    | 0    | 0    | 0    | 0    | 0    | 0    | 0    |
| 2019 | 0    | 0    | 0    | 0    | 0    | 0    | 0    | 0    | 0    | 0    | 0    | 0    | 0    |
| 2020 | 0    | 0    | 0    | 0    | 0    | 254  | 0    | 0    | 0    | 0    | 0    | 0    | 0    |
| 2021 | 0    | 0    | 0    | 0    | 0    | 557  | 0    | 0    | 0    | 0    | 0    | 0    | 0    |
| 2022 | 0    | 0    | 0    | 0    | 0    | 909  | 0    | 0    | 0    | 0    | 0    | 0    | 0    |
| 2023 | 0    | 0    | 0    | 0    | 0    | 1184 | 0    | 0    | 0    | 0    | 0    | 0    | 0    |
| 2024 | 0    | 0    | 0    | 0    | 0    | 1489 | 0    | 0    | 0    | 0    | 0    | 0    | 0    |
| 2025 | 250  | 250  | 256  | 256  | 0    | 1771 | 256  | 256  | 256  | 256  | 256  | 250  | 250  |
| 2026 | 500  | 500  | 529  | 518  | 0    | 2092 | 518  | 518  | 518  | 518  | 518  | 629  | 590  |
| 2027 | 760  | 760  | 867  | 831  | 0    | 2395 | 836  | 836  | 836  | 836  | 836  | 1012 | 937  |
| 2028 | 1008 | 1008 | 1178 | 1114 | 0    | 2685 | 1119 | 1119 | 1119 | 1119 | 1119 | 1407 | 1294 |
| 2029 | 1260 | 1260 | 1496 | 1420 | 0    | 2957 | 1441 | 1441 | 1441 | 1441 | 1441 | 1729 | 1643 |
| 2030 | 1533 | 1533 | 1803 | 1739 | 256  | 3259 | 1771 | 1771 | 1771 | 1771 | 1771 | 2053 | 1973 |
| 2031 | 1785 | 1785 | 2091 | 2033 | 528  | 3557 | 2061 | 2061 | 2061 | 2061 | 2061 | 2366 | 2288 |
| 2032 | 2040 | 2040 | 2386 | 2329 | 824  | 3872 | 2358 | 2358 | 2358 | 2358 | 2358 | 2651 | 2576 |
| 2033 | 2303 | 2303 | 2705 | 2647 | 1163 | 4192 | 2667 | 2667 | 2667 | 2667 | 2667 | 2937 | 2860 |
| 2034 | 2576 | 2576 | 2992 | 2959 | 1488 | 4515 | 2963 | 2963 | 2963 | 2963 | 2963 | 3252 | 3196 |
| 2035 | 2865 | 2865 | 3279 | 3221 | 1862 | 4820 | 3255 | 3254 | 3255 | 3255 | 3255 | 3564 | 3499 |
| 2036 | 3123 | 3123 | 3588 | 3536 | 2215 | 5227 | 3582 | 3584 | 3582 | 3582 | 3582 | 3832 | 3785 |
| 2037 | 3392 | 3392 | 3911 | 3823 | 2565 | 5497 | 3838 | 3879 | 3838 | 3838 | 3838 | 4081 | 4035 |
| 2038 | 3673 | 3673 | 4187 | 4146 | 2880 | 5780 | 4154 | 4236 | 4154 | 4154 | 4154 | 4307 | 4271 |
| 2039 | 3939 | 3939 | 4517 | 4466 | 3184 | 6130 | 4488 | 4534 | 4486 | 4486 | 4486 | 4537 | 4506 |
| 2040 | 4220 | 4220 | 4891 | 4832 | 3462 | 6417 | 4808 | 4854 | 4859 | 4859 | 4859 | 4828 | 4793 |
| 2041 | 4496 | 4496 | 5280 | 5185 | 3753 | 6709 | 5193 | 5219 | 5237 | 5237 | 5237 | 5091 | 5068 |
| 2042 | 4781 | 4781 | 5584 | 5479 | 4024 | 6782 | 5481 | 5547 | 5544 | 5544 | 5544 | 5366 | 5337 |
| 2043 | 5031 | 5031 | 6027 | 5892 | 4303 | 6838 | 5847 | 5929 | 5990 | 5990 | 5990 | 5599 | 5560 |
| 2044 | 5283 | 5283 | 6257 | 6201 | 4593 | 6981 | 6175 | 6195 | 6227 | 6227 | 6227 | 5810 | 5767 |
| 2045 | 5535 | 5535 | 6294 | 6225 | 4945 | 7097 | 6224 | 6235 | 6264 | 6264 | 6264 | 6002 | 5967 |
| 2046 | 5706 | 5706 | 6572 | 6471 | 5315 | 7177 | 6493 | 6505 | 6517 | 6517 | 6517 | 6169 | 6134 |
| 2047 | 5839 | 5839 | 6793 | 6662 | 5566 | 7244 | 6704 | 6716 | 6738 | 6738 | 6738 | 6205 | 6201 |
| 2048 | 6052 | 6052 | 6980 | 6863 | 5626 | 7244 | 6886 | 6904 | 6925 | 6925 | 6925 | 6216 | 6211 |
| 2049 | 6264 | 6264 | 7097 | 6987 | 5856 | 7250 | 7034 | 7046 | 7067 | 7067 | 7067 | 6487 | 6456 |
| 2050 | 6445 | 6445 | 7179 | 7112 | 6083 | 7250 | 7140 | 7148 | 7165 | 7165 | 7165 | 6751 | 6674 |
| 2051 | 6650 | 6650 | 7227 | 7218 | 6350 | 7250 | 7217 | 7225 | 7222 | 7222 | 7222 | 6991 | 6900 |
| 2052 | 6874 | 6874 | 7248 | 7231 | 6486 | 7250 | 7239 | 7237 | 7244 | 7244 | 7244 | 7114 | 7058 |
| 2053 | 7039 | 7039 | 7251 | 7237 | 6675 | 7250 | 7241 | 7246 | 7246 | 7246 | 7246 | 7166 | 7134 |
| 2054 | 7137 | 7137 | 7251 | 7244 | 6841 | 7250 | 7253 | 7247 | 7249 | 7249 | 7249 | 7202 | 7184 |
| 2055 | 7189 | 7189 | 7251 | 7246 | 6986 | 7250 | 7253 | 7253 | 7249 | 7249 | 7249 | 7229 | 7220 |
| 2056 | 7225 | 7225 | 7251 | 7250 | 7096 | 7250 | 7253 | 7253 | 7251 | 7251 | 7251 | 7240 | 7239 |
| 2057 | 7240 | 7240 | 7251 | 7250 | 7174 | 7250 | 7253 | 7253 | 7251 | 7251 | 7251 | 7249 | 7249 |
| 2058 | 7240 | 7240 | 7251 | 7250 | 7226 | 7250 | 7253 | 7253 | 7251 | 7251 | 7251 | 7249 | 7249 |
| 2059 | 7249 | 7249 | 7251 | 7250 | 7239 | 7250 | 7253 | 7253 | 7251 | 7251 | 7251 | 7249 | 7249 |



|      | 66   | 67   | 68   | 69   | 70   | 71   | 72   | 73   | 74   | 75   | 76   | 77   | 78   |
|------|------|------|------|------|------|------|------|------|------|------|------|------|------|
| 2002 | 0    | 0    | 0    | 0    | 0    | 0    | 0    | 0    | 0    | 0    | 0    | 0    | 0    |
| 2003 | 0    | 0    | 0    | 0    | 0    | 0    | 0    | 0    | 0    | 0    | 0    | 0    | 0    |
| 2004 | 0    | 0    | 0    | 0    | 0    | 0    | 0    | 0    | 0    | 0    | 0    | 0    | 0    |
| 2005 | 0    | 0    | 0    | 0    | 0    | 0    | 0    | 0    | 0    | 0    | 0    | 0    | 0    |
| 2006 | 0    | 0    | 0    | 0    | 0    | 0    | 0    | 0    | 0    | 0    | 0    | 0    | 0    |
| 2007 | 0    | 0    | 0    | 0    | 0    | 0    | 0    | 0    | 0    | 0    | 0    | 0    | 0    |
| 2008 | 0    | 0    | 0    | 0    | 0    | 0    | 0    | 0    | 0    | 0    | 0    | 0    | 0    |
| 2009 | 0    | 0    | 0    | 0    | 0    | 0    | 0    | 0    | 0    | 0    | 0    | 0    | 0    |
| 2010 | 0    | 0    | 0    | 0    | 0    | 0    | 0    | 0    | 0    | 0    | 0    | 0    | 0    |
| 2011 | 0    | 0    | 0    | 0    | 0    | 0    | 0    | 0    | 0    | 0    | 0    | 0    | 0    |
| 2012 | 0    | 0    | 0    | 0    | 0    | 0    | 0    | 0    | 0    | 0    | 0    | 0    | 0    |
| 2013 | 0    | 0    | 0    | 0    | 0    | 0    | 0    | 0    | 0    | 0    | 0    | 0    | 0    |
| 2014 | 0    | 0    | 0    | 0    | 0    | 0    | 0    | 0    | 0    | 0    | 0    | 0    | 0    |
| 2015 | 0    | 0    | 0    | 0    | 0    | 0    | 0    | 0    | 0    | 0    | 0    | 0    | 0    |
| 2016 | 0    | 0    | 0    | 0    | 0    | 0    | 0    | 0    | 0    | 0    | 0    | 0    | 0    |
| 2017 | 0    | 0    | 0    | 0    | 0    | 0    | 0    | 0    | 0    | 0    | 0    | 0    | 0    |
| 2018 | 0    | 0    | 0    | 0    | 0    | 0    | 0    | 0    | 0    | 0    | 0    | 0    | 0    |
| 2019 | 0    | 0    | 0    | 0    | 0    | 0    | 0    | 0    | 0    | 0    | 0    | 0    | 0    |
| 2020 | 0    | 250  | 0    | 0    | 0    | 0    | 0    | 0    | 0    | 0    | 250  | 0    | 0    |
| 2021 | 0    | 650  | 0    | 0    | 0    | 0    | 0    | 0    | 0    | 0    | 650  | 0    | 0    |
| 2022 | 0    | 1016 | 0    | 0    | 0    | 0    | 0    | 0    | 0    | 0    | 1016 | 0    | 0    |
| 2023 | 0    | 1347 | 0    | 0    | 0    | 0    | 0    | 0    | 0    | 0    | 1347 | 0    | 0    |
| 2024 | 0    | 1663 | 0    | 0    | 0    | 0    | 0    | 0    | 0    | 0    | 1663 | 0    | 0    |
| 2025 | 0    | 1931 | 250  | 248  | 250  | 250  | 250  | 250  | 250  | 0    | 1931 | 250  | 250  |
| 2026 | 0    | 2197 | 591  | 589  | 591  | 591  | 591  | 629  | 590  | 0    | 2197 | 600  | 591  |
| 2027 | 0    | 2483 | 955  | 953  | 955  | 955  | 955  | 1012 | 937  | 0    | 2467 | 974  | 955  |
| 2028 | 0    | 2777 | 1346 | 1344 | 1346 | 1346 | 1346 | 1407 | 1294 | 0    | 2758 | 1365 | 1346 |
| 2029 | 0    | 3069 | 1701 | 1702 | 1701 | 1701 | 1701 | 1729 | 1643 | 0    | 3050 | 1724 | 1701 |
| 2030 | 250  | 3339 | 2031 | 2018 | 2029 | 2029 | 2029 | 2053 | 1973 | 250  | 3341 | 2038 | 2020 |
| 2031 | 619  | 3603 | 2326 | 2323 | 2331 | 2331 | 2331 | 2366 | 2288 | 619  | 3614 | 2333 | 2325 |
| 2032 | 992  | 3890 | 2605 | 2619 | 2627 | 2627 | 2627 | 2651 | 2576 | 992  | 3908 | 2622 | 2621 |
| 2033 | 1377 | 4168 | 2905 | 2915 | 2919 | 2919 | 2919 | 2941 | 2864 | 1377 | 4162 | 2935 | 2916 |
| 2034 | 1781 | 4485 | 3220 | 3239 | 3242 | 3242 | 3242 | 3254 | 3189 | 1781 | 4473 | 3234 | 3240 |
| 2035 | 2166 | 4720 | 3510 | 3537 | 3552 | 3552 | 3552 | 3553 | 3495 | 2166 | 4736 | 3528 | 3539 |
| 2036 | 2477 | 4935 | 3791 | 3817 | 3825 | 3825 | 3825 | 3834 | 3795 | 2477 | 4997 | 3803 | 3819 |
| 2037 | 2790 | 5132 | 4041 | 4100 | 4066 | 4066 | 4066 | 4104 | 4064 | 2790 | 5251 | 4058 | 4076 |
| 2038 | 3155 | 5332 | 4276 | 4382 | 4295 | 4295 | 4295 | 4365 | 4332 | 3155 | 5481 | 4311 | 4332 |
| 2039 | 3455 | 5583 | 4512 | 4654 | 4521 | 4521 | 4521 | 4623 | 4596 | 3455 | 5743 | 4570 | 4606 |
| 2040 | 3731 | 5802 | 4801 | 4919 | 4812 | 4812 | 4812 | 4911 | 4891 | 3729 | 5993 | 4877 | 4921 |
| 2041 | 4085 | 6014 | 5077 | 5177 | 5082 | 5082 | 5082 | 5184 | 5184 | 4085 | 6338 | 5152 | 5231 |
| 2042 | 4348 | 6285 | 5370 | 5408 | 5355 | 5355 | 5355 | 5511 | 5498 | 4359 | 6672 | 5488 | 5509 |
| 2043 | 4632 | 6550 | 5597 | 5630 | 5580 | 5580 | 5580 | 5752 | 5739 | 4659 | 6745 | 5749 | 5768 |
| 2044 | 4903 | 6752 | 5798 | 5862 | 5795 | 5795 | 5795 | 5998 | 5999 | 4966 | 6796 | 5999 | 6039 |
| 2045 | 5135 | 6756 | 5975 | 6154 | 5997 | 5997 | 5997 | 6184 | 6179 | 5219 | 7055 | 6194 | 6267 |
| 2046 | 5353 | 7022 | 6158 | 6270 | 6170 | 6170 | 6170 | 6218 | 6200 | 5476 | 7177 | 6212 | 6297 |
| 2047 | 5583 | 7138 | 6195 | 6329 | 6212 | 6212 | 6212 | 6498 | 6450 | 5682 | 7227 | 6457 | 6553 |
| 2048 | 5689 | 7186 | 6195 | 6577 | 6217 | 6217 | 6217 | 6772 | 6686 | 5713 | 7246 | 6697 | 6810 |
| 2049 | 5698 | 7215 | 6445 | 6850 | 6461 | 6461 | 6461 | 7012 | 6912 | 5961 | 7256 | 6958 | 7006 |
| 2050 | 5939 | 7234 | 6687 | 7032 | 6710 | 6710 | 6710 | 7127 | 7054 | 6178 | 7256 | 7092 | 7092 |
| 2051 | 6176 | 7244 | 6945 | 7106 | 6956 | 6956 | 6956 | 7175 | 7137 | 6427 | 7256 | 7159 | 7147 |
| 2052 | 6413 | 7250 | 7070 | 7161 | 7080 | 7080 | 7080 | 7211 | 7187 | 6676 | 7256 | 7199 | 7186 |
| 2053 | 6668 | 7250 | 7145 | 7198 | 7147 | 7147 | 7147 | 7238 | 7223 | 6886 | 7256 | 7228 | 7215 |
| 2054 | 6857 | 7250 | 7188 | 7227 | 7187 | 7187 | 7187 | 7249 | 7242 | 7027 | 7256 | 7247 | 7234 |
| 2055 | 7019 | 7250 | 7217 | 7246 | 7216 | 7216 | 7216 | 7258 | 7252 | 7130 | 7256 | 7257 | 7244 |
| 2056 | 7131 | 7250 | 7236 | 7252 | 7235 | 7235 | 7235 | 7258 | 7252 | 7175 | 7256 | 7257 | 7249 |
| 2057 | 7176 | 7250 | 7246 | 7252 | 7245 | 7245 | 7245 | 7258 | 7252 | 7205 | 7256 | 7257 | 7249 |
| 2058 | 7206 | 7250 | 7251 | 7252 | 7250 | 7250 | 7250 | 7258 | 7252 | 7224 | 7256 | 7257 | 7249 |
| 2059 | 7225 | 7250 | 7251 | 7252 | 7250 | 7250 | 7250 | 7258 | 7252 | 7234 | 7256 | 7257 | 7249 |





|      | 79   | 80   | 81   | 82   | 83   | 84   | 85   | 86   | 87   | 88   | 89   | 90   | 91   |
|------|------|------|------|------|------|------|------|------|------|------|------|------|------|
| 2002 | 0    | 0    | 0    | 0    | 0    | 0    | 0    | 0    | 0    | 0    | 0    | 0    | 0    |
| 2003 | 0    | 0    | 0    | 0    | 0    | 0    | 0    | 0    | 0    | 0    | 0    | 0    | 0    |
| 2004 | 0    | 0    | 0    | 0    | 0    | 0    | 0    | 0    | 0    | 0    | 0    | 0    | 0    |
| 2005 | 0    | 0    | 0    | 0    | 0    | 0    | 0    | 0    | 0    | 0    | 0    | 0    | 0    |
| 2006 | 0    | 0    | 0    | 0    | 0    | 0    | 0    | 0    | 0    | 0    | 0    | 0    | 0    |
| 2007 | 0    | 0    | 0    | 0    | 0    | 0    | 0    | 0    | 0    | 0    | 0    | 0    | 0    |
| 2008 | 0    | 0    | 0    | 0    | 0    | 0    | 0    | 0    | 0    | 0    | 0    | 0    | 0    |
| 2009 | 0    | 0    | 0    | 0    | 0    | 0    | 0    | 0    | 0    | 0    | 0    | 0    | 0    |
| 2010 | 0    | 0    | 0    | 0    | 0    | 0    | 0    | 0    | 0    | 0    | 0    | 0    | 0    |
| 2011 | 0    | 0    | 0    | 0    | 0    | 0    | 0    | 0    | 0    | 0    | 0    | 0    | 0    |
| 2012 | 0    | 0    | 0    | 0    | 0    | 0    | 0    | 0    | 0    | 0    | 0    | 0    | 0    |
| 2013 | 0    | 0    | 0    | 0    | 0    | 0    | 0    | 0    | 0    | 0    | 0    | 0    | 0    |
| 2014 | 0    | 0    | 0    | 0    | 0    | 0    | 0    | 0    | 0    | 0    | 0    | 0    | 0    |
| 2015 | 0    | 0    | 0    | 0    | 0    | 0    | 0    | 0    | 0    | 0    | 0    | 0    | 0    |
| 2016 | 0    | 0    | 0    | 0    | 0    | 0    | 0    | 0    | 0    | 0    | 0    | 0    | 0    |
| 2017 | 0    | 0    | 0    | 0    | 0    | 0    | 0    | 0    | 0    | 0    | 0    | 0    | 0    |
| 2018 | 0    | 0    | 0    | 0    | 0    | 0    | 0    | 0    | 0    | 0    | 0    | 0    | 0    |
| 2019 | 0    | 0    | 0    | 0    | 0    | 0    | 0    | 0    | 0    | 0    | 0    | 0    | 0    |
| 2020 | 0    | 0    | 0    | 0    | 0    | 0    | 254  | 0    | 0    | 0    | 0    | 0    | 0    |
| 2021 | 0    | 0    | 0    | 0    | 0    | 0    | 530  | 0    | 0    | 0    | 0    | 0    | 0    |
| 2022 | 0    | 0    | 0    | 0    | 0    | 0    | 847  | 0    | 0    | 0    | 0    | 0    | 0    |
| 2023 | 0    | 0    | 0    | 0    | 0    | 0    | 1131 | 0    | 0    | 0    | 0    | 0    | 0    |
| 2024 | 0    | 0    | 0    | 0    | 0    | 0    | 1434 | 0    | 0    | 0    | 0    | 0    | 0    |
| 2025 | 250  | 250  | 250  | 256  | 256  | 0    | 1729 | 256  | 256  | 256  | 256  | 256  | 250  |
| 2026 | 591  | 591  | 591  | 518  | 518  | 0    | 2039 | 518  | 518  | 518  | 518  | 518  | 590  |
| 2027 | 955  | 955  | 955  | 831  | 831  | 0    | 2323 | 831  | 831  | 831  | 831  | 831  | 937  |
| 2028 | 1346 | 1346 | 1346 | 1114 | 1114 | 0    | 2611 | 1114 | 1114 | 1114 | 1114 | 1114 | 1294 |
| 2029 | 1701 | 1701 | 1701 | 1420 | 1420 | 0    | 2888 | 1420 | 1420 | 1420 | 1420 | 1420 | 1630 |
| 2030 | 2029 | 2029 | 2029 | 1735 | 1735 | 256  | 3210 | 1735 | 1735 | 1735 | 1735 | 1735 | 1954 |
| 2031 | 2331 | 2331 | 2331 | 2029 | 2029 | 528  | 3504 | 2029 | 2029 | 2029 | 2029 | 2029 | 2271 |
| 2032 | 2617 | 2617 | 2617 | 2320 | 2320 | 824  | 3769 | 2320 | 2320 | 2320 | 2320 | 2320 | 2560 |
| 2033 | 2914 | 2914 | 2914 | 2623 | 2623 | 1159 | 4092 | 2623 | 2623 | 2623 | 2623 | 2623 | 2843 |
| 2034 | 3241 | 3241 | 3241 | 2923 | 2923 | 1476 | 4451 | 2923 | 2923 | 2923 | 2923 | 2923 | 3170 |
| 2035 | 3539 | 3539 | 3539 | 3200 | 3200 | 1850 | 4748 | 3200 | 3200 | 3200 | 3200 | 3200 | 3468 |
| 2036 | 3825 | 3825 | 3825 | 3512 | 3512 | 2195 | 5157 | 3512 | 3536 | 3512 | 3512 | 3512 | 3743 |
| 2037 | 4095 | 4095 | 4095 | 3799 | 3799 | 2526 | 5444 | 3799 | 3822 | 3799 | 3799 | 3799 | 3994 |
| 2038 | 4358 | 4358 | 4358 | 4115 | 4115 | 2820 | 5702 | 4115 | 4161 | 4115 | 4115 | 4115 | 4239 |
| 2039 | 4608 | 4608 | 4608 | 4449 | 4449 | 3128 | 6056 | 4449 | 4453 | 4449 | 4449 | 4449 | 4476 |
| 2040 | 4898 | 4898 | 4898 | 4789 | 4789 | 3410 | 6369 | 4779 | 4791 | 4789 | 4789 | 4789 | 4746 |
| 2041 | 5171 | 5171 | 5171 | 5173 | 5173 | 3702 | 6619 | 5122 | 5107 | 5173 | 5173 | 5173 | 5015 |
| 2042 | 5491 | 5491 | 5491 | 5441 | 5441 | 3970 | 6720 | 5459 | 5467 | 5441 | 5441 | 5441 | 5293 |
| 2043 | 5732 | 5732 | 5732 | 5809 | 5809 | 4263 | 6734 | 5786 | 5833 | 5809 | 5809 | 5809 | 5527 |
| 2044 | 5975 | 5975 | 5975 | 6181 | 6181 | 4550 | 6936 | 6168 | 6184 | 6181 | 6181 | 6181 | 5715 |
| 2045 | 6182 | 6182 | 6182 | 6225 | 6225 | 4927 | 7055 | 6209 | 6212 | 6225 | 6225 | 6225 | 5892 |
| 2046 | 6211 | 6211 | 6211 | 6471 | 6471 | 5239 | 7151 | 6448 | 6457 | 6471 | 6471 | 6471 | 6046 |
| 2047 | 6453 | 6453 | 6453 | 6656 | 6656 | 5560 | 7232 | 6632 | 6645 | 6656 | 6656 | 6656 | 6201 |
| 2048 | 6702 | 6702 | 6702 | 6852 | 6852 | 5617 | 7237 | 6828 | 6835 | 6852 | 6852 | 6852 | 6201 |
| 2049 | 6969 | 6969 | 6969 | 6986 | 6986 | 5840 | 7251 | 6970 | 6976 | 6986 | 6986 | 6986 | 6451 |
| 2050 | 7086 | 7086 | 7086 | 7084 | 7084 | 6062 | 7251 | 7071 | 7077 | 7084 | 7084 | 7084 | 6677 |
| 2051 | 7160 | 7160 | 7160 | 7171 | 7171 | 6274 | 7251 | 7158 | 7164 | 7171 | 7171 | 7171 | 6892 |
| 2052 | 7203 | 7203 | 7203 | 7224 | 7224 | 6450 | 7251 | 7217 | 7218 | 7224 | 7224 | 7224 | 7044 |
| 2053 | 7232 | 7232 | 7232 | 7237 | 7237 | 6636 | 7251 | 7242 | 7234 | 7237 | 7237 | 7237 | 7132 |
| 2054 | 7251 | 7251 | 7251 | 7242 | 7242 | 6799 | 7251 | 7247 | 7239 | 7242 | 7242 | 7242 | 7178 |
| 2055 | 7251 | 7251 | 7251 | 7252 | 7252 | 6937 | 7251 | 7254 | 7250 | 7252 | 7252 | 7252 | 7214 |
| 2056 | 7251 | 7251 | 7251 | 7252 | 7252 | 7052 | 7251 | 7254 | 7250 | 7252 | 7252 | 7252 | 7234 |
| 2057 | 7251 | 7251 | 7251 | 7252 | 7252 | 7141 | 7251 | 7254 | 7250 | 7252 | 7252 | 7252 | 7245 |
| 2058 | 7251 | 7251 | 7251 | 7252 | 7252 | 7198 | 7251 | 7254 | 7250 | 7252 | 7252 | 7252 | 7253 |
| 2059 | 7251 | 7251 | 7251 | 7252 | 7252 | 7242 | 7251 | 7254 | 7250 | 7252 | 7252 | 7252 | 7253 |



|      | 92   | 93   | 94   | 95   | 96   | 97   | 98   | 99   | 100  | 101  | 102  | 103  | 104  |
|------|------|------|------|------|------|------|------|------|------|------|------|------|------|
| 2002 | 0    | 0    | 0    | 0    | 0    | 0    | 0    | 0    | 0    | 0    | 0    | 0    | 0    |
| 2003 | 0    | 0    | 0    | 0    | 0    | 0    | 0    | 0    | 0    | 0    | 0    | 0    | 0    |
| 2004 | 0    | 0    | 0    | 0    | 0    | 0    | 0    | 0    | 0    | 0    | 0    | 0    | 0    |
| 2005 | 0    | 0    | 0    | 0    | 0    | 0    | 0    | 0    | 0    | 0    | 0    | 0    | 0    |
| 2006 | 0    | 0    | 0    | 0    | 0    | 0    | 0    | 0    | 0    | 0    | 0    | 0    | 0    |
| 2007 | 0    | 0    | 0    | 0    | 0    | 0    | 0    | 0    | 0    | 0    | 0    | 0    | 0    |
| 2008 | 0    | 0    | 0    | 0    | 0    | 0    | 0    | 0    | 0    | 0    | 0    | 0    | 0    |
| 2009 | 0    | 0    | 0    | 0    | 0    | 0    | 0    | 0    | 0    | 0    | 0    | 0    | 0    |
| 2010 | 0    | 0    | 0    | 0    | 0    | 0    | 0    | 0    | 0    | 0    | 0    | 0    | 0    |
| 2011 | 0    | 0    | 0    | 0    | 0    | 0    | 0    | 0    | 0    | 0    | 0    | 0    | 0    |
| 2012 | 0    | 0    | 0    | 0    | 0    | 0    | 0    | 0    | 0    | 0    | 0    | 0    | 0    |
| 2013 | 0    | 0    | 0    | 0    | 0    | 0    | 0    | 0    | 0    | 0    | 0    | 0    | 0    |
| 2014 | 0    | 0    | 0    | 0    | 0    | 0    | 0    | 0    | 0    | 0    | 0    | 0    | 0    |
| 2015 | 0    | 0    | 0    | 0    | 0    | 0    | 0    | 0    | 0    | 0    | 0    | 0    | 0    |
| 2016 | 0    | 0    | 0    | 0    | 0    | 0    | 0    | 0    | 0    | 0    | 0    | 0    | 0    |
| 2017 | 0    | 0    | 0    | 0    | 0    | 0    | 0    | 0    | 0    | 0    | 0    | 0    | 0    |
| 2018 | 0    | 0    | 0    | 0    | 0    | 0    | 0    | 0    | 0    | 0    | 0    | 0    | 0    |
| 2019 | 0    | 0    | 0    | 0    | 0    | 0    | 0    | 0    | 0    | 0    | 0    | 0    | 0    |
| 2020 | 0    | 0    | 250  | 0    | 0    | 0    | 0    | 0    | 0    | 0    | 0    | 250  | 0    |
| 2021 | 0    | 0    | 591  | 0    | 0    | 0    | 0    | 0    | 0    | 0    | 0    | 591  | 0    |
| 2022 | 0    | 0    | 917  | 0    | 0    | 0    | 0    | 0    | 0    | 0    | 0    | 917  | 0    |
| 2023 | 0    | 0    | 1255 | 0    | 0    | 0    | 0    | 0    | 0    | 0    | 0    | 1255 | 0    |
| 2024 | 0    | 0    | 1574 | 0    | 0    | 0    | 0    | 0    | 0    | 0    | 0    | 1574 | 0    |
| 2025 | 250  | 0    | 1848 | 250  | 248  | 250  | 250  | 250  | 250  | 250  | 0    | 1848 | 250  |
| 2026 | 590  | 0    | 2122 | 590  | 588  | 590  | 590  | 590  | 590  | 590  | 0    | 2122 | 599  |
| 2027 | 937  | 0    | 2416 | 937  | 935  | 937  | 937  | 937  | 937  | 937  | 0    | 2400 | 956  |
| 2028 | 1294 | 0    | 2715 | 1296 | 1291 | 1294 | 1294 | 1294 | 1294 | 1294 | 0    | 2695 | 1315 |
| 2029 | 1630 | 0    | 3003 | 1632 | 1627 | 1630 | 1630 | 1630 | 1630 | 1630 | 0    | 2983 | 1651 |
| 2030 | 1954 | 250  | 3275 | 1956 | 1950 | 1954 | 1954 | 1954 | 1954 | 1954 | 250  | 3274 | 1966 |
| 2031 | 2271 | 619  | 3542 | 2266 | 2270 | 2271 | 2271 | 2271 | 2271 | 2271 | 619  | 3551 | 2276 |
| 2032 | 2560 | 992  | 3828 | 2548 | 2559 | 2560 | 2560 | 2560 | 2560 | 2560 | 992  | 3841 | 2558 |
| 2033 | 2843 | 1367 | 4112 | 2833 | 2839 | 2843 | 2843 | 2843 | 2847 | 2847 | 1367 | 4106 | 2848 |
| 2034 | 3170 | 1751 | 4445 | 3143 | 3166 | 3170 | 3170 | 3170 | 3170 | 3170 | 1751 | 4384 | 3159 |
| 2035 | 3468 | 2110 | 4680 | 3436 | 3478 | 3468 | 3468 | 3468 | 3468 | 3468 | 2110 | 4647 | 3453 |
| 2036 | 3743 | 2413 | 4895 | 3721 | 3762 | 3743 | 3743 | 3743 | 3756 | 3756 | 2413 | 4937 | 3743 |
| 2037 | 3994 | 2727 | 5089 | 3971 | 4035 | 3994 | 3994 | 3994 | 4026 | 4026 | 2727 | 5191 | 4007 |
| 2038 | 4239 | 3085 | 5282 | 4224 | 4290 | 4239 | 4239 | 4239 | 4295 | 4295 | 3085 | 5412 | 4264 |
| 2039 | 4476 | 3388 | 5464 | 4479 | 4557 | 4476 | 4476 | 4476 | 4562 | 4562 | 3388 | 5650 | 4528 |
| 2040 | 4746 | 3663 | 5655 | 4761 | 4841 | 4746 | 4746 | 4746 | 4863 | 4863 | 3663 | 5890 | 4833 |
| 2041 | 5015 | 4005 | 5837 | 5039 | 5110 | 5015 | 5015 | 5015 | 5146 | 5146 | 4011 | 6168 | 5124 |
| 2042 | 5293 | 4278 | 6060 | 5307 | 5346 | 5293 | 5293 | 5293 | 5464 | 5464 | 4293 | 6499 | 5452 |
| 2043 | 5527 | 4548 | 6212 | 5555 | 5563 | 5527 | 5527 | 5527 | 5705 | 5705 | 4569 | 6680 | 5705 |
| 2044 | 5715 | 4813 | 6377 | 5743 | 5785 | 5715 | 5715 | 5715 | 5956 | 5956 | 4858 | 6722 | 5959 |
| 2045 | 5892 | 5046 | 6554 | 5912 | 6045 | 5892 | 5892 | 5892 | 6166 | 6166 | 5115 | 6931 | 6193 |
| 2046 | 6046 | 5265 | 6663 | 6097 | 6253 | 6046 | 6046 | 6046 | 6203 | 6203 | 5368 | 7091 | 6209 |
| 2047 | 6201 | 5495 | 6668 | 6156 | 6281 | 6201 | 6201 | 6201 | 6441 | 6441 | 5628 | 7171 | 6453 |
| 2048 | 6201 | 5681 | 6901 | 6166 | 6530 | 6201 | 6201 | 6201 | 6668 | 6668 | 5687 | 7207 | 6680 |
| 2049 | 6451 | 5694 | 7079 | 6416 | 6753 | 6451 | 6451 | 6451 | 6890 | 6890 | 5717 | 7234 | 6894 |
| 2050 | 6677 | 5932 | 7168 | 6650 | 6948 | 6677 | 6677 | 6677 | 7039 | 7039 | 5958 | 7245 | 7049 |
| 2051 | 6892 | 6160 | 7204 | 6867 | 7066 | 6892 | 6892 | 6892 | 7129 | 7129 | 6180 | 7255 | 7140 |
| 2052 | 7044 | 6393 | 7231 | 7032 | 7134 | 7044 | 7044 | 7044 | 7176 | 7176 | 6409 | 7255 | 7187 |
| 2053 | 7132 | 6618 | 7251 | 7124 | 7174 | 7132 | 7132 | 7132 | 7212 | 7212 | 6645 | 7255 | 7223 |
| 2054 | 7178 | 6820 | 7251 | 7174 | 7210 | 7178 | 7178 | 7178 | 7232 | 7232 | 6848 | 7255 | 7243 |
| 2055 | 7214 | 6986 | 7251 | 7210 | 7230 | 7214 | 7214 | 7214 | 7243 | 7243 | 7004 | 7255 | 7254 |
| 2056 | 7234 | 7093 | 7251 | 7230 | 7241 | 7234 | 7234 | 7234 | 7251 | 7251 | 7101 | 7255 | 7254 |
| 2057 | 7245 | 7158 | 7251 | 7241 | 7249 | 7245 | 7245 | 7245 | 7251 | 7251 | 7156 | 7255 | 7254 |
| 2058 | 7253 | 7198 | 7251 | 7249 | 7249 | 7253 | 7253 | 7253 | 7251 | 7251 | 7199 | 7255 | 7254 |
| 2059 | 7253 | 7219 | 7251 | 7249 | 7249 | 7253 | 7253 | 7253 | 7251 | 7251 | 7220 | 7255 | 7254 |

|      | 92   | 93   | 94   | 95   | 96   | 97   | 98   | 99   | 100  | 101  | 102  | 103  | 104  |
|------|------|------|------|------|------|------|------|------|------|------|------|------|------|
| 2060 | 7253 | 7233 | 7251 | 7249 | 7249 | 7253 | 7253 | 7253 | 7251 | 7251 | 7234 | 7255 | 7254 |
| 2061 | 7253 | 7243 | 7251 | 7249 | 7249 | 7253 | 7253 | 7253 | 7251 | 7251 | 7244 | 7255 | 7254 |
| 2062 | 7253 | 7249 | 7251 | 7249 | 7249 | 7253 | 7253 | 7253 | 7251 | 7251 | 7250 | 7255 | 7254 |
| 2063 | 7253 | 7249 | 7251 | 7249 | 7249 | 7253 | 7253 | 7253 | 7251 | 7251 | 7250 | 7255 | 7254 |
| 2064 | 7253 | 7249 | 7251 | 7249 | 7249 | 7253 | 7253 | 7253 | 7251 | 7251 | 7250 | 7255 | 7254 |
| 2065 | 7253 | 7249 | 7251 | 7249 | 7249 | 7253 | 7253 | 7253 | 7251 | 7251 | 7250 | 7255 | 7254 |
| 2066 | 7253 | 7249 | 7251 | 7249 | 7249 | 7253 | 7253 | 7253 | 7251 | 7251 | 7250 | 7255 | 7254 |
| 2067 | 7253 | 7249 | 7251 | 7249 | 7249 | 7253 | 7253 | 7253 | 7251 | 7251 | 7250 | 7255 | 7254 |
| 2068 | 7253 | 7249 | 7251 | 7249 | 7249 | 7253 | 7253 | 7253 | 7251 | 7251 | 7250 | 7255 | 7254 |
| 2069 | 7253 | 7249 | 7251 | 7249 | 7249 | 7253 | 7253 | 7253 | 7251 | 7251 | 7250 | 7255 | 7254 |
| 2070 | 7253 | 7249 | 7251 | 7249 | 7249 | 7253 | 7253 | 7253 | 7251 | 7251 | 7250 | 7255 | 7254 |
| 2071 | 7253 | 7249 | 7251 | 7249 | 7249 | 7253 | 7253 | 7253 | 7251 | 7251 | 7250 | 7255 | 7254 |
| 2072 | 7253 | 7249 | 7251 | 7249 | 7249 | 7253 | 7253 | 7253 | 7251 | 7251 | 7250 | 7255 | 7254 |
| 2073 | 7253 | 7249 | 7251 | 7249 | 7249 | 7253 | 7253 | 7253 | 7251 | 7251 | 7250 | 7255 | 7254 |
| 2074 | 7253 | 7249 | 7251 | 7249 | 7249 | 7253 | 7253 | 7253 | 7251 | 7251 | 7250 | 7255 | 7254 |
| 2075 | 7253 | 7249 | 7251 | 7249 | 7249 | 7253 | 7253 | 7253 | 7251 | 7251 | 7250 | 7255 | 7254 |
| 2076 | 7253 | 7249 | 7251 | 7249 | 7249 | 7253 | 7253 | 7253 | 7251 | 7251 | 7250 | 7255 | 7254 |
| 2077 | 7253 | 7249 | 7251 | 7249 | 7249 | 7253 | 7253 | 7253 | 7251 | 7251 | 7250 | 7255 | 7254 |
| 2078 | 7253 | 7249 | 7251 | 7249 | 7249 | 7253 | 7253 | 7253 | 7251 | 7251 | 7250 | 7255 | 7254 |
| 2079 | 7253 | 7249 | 7251 | 7249 | 7249 | 7253 | 7253 | 7253 | 7251 | 7251 | 7250 | 7255 | 7254 |
| 2080 | 7253 | 7249 | 7251 | 7249 | 7249 | 7253 | 7253 | 7253 | 7251 | 7251 | 7250 | 7255 | 7254 |
| 2081 | 7253 | 7249 | 7251 | 7249 | 7249 | 7253 | 7253 | 7253 | 7251 | 7251 | 7250 | 7255 | 7254 |
| 2082 | 7253 | 7249 | 7251 | 7249 | 7249 | 7253 | 7253 | 7253 | 7251 | 7251 | 7250 | 7255 | 7254 |
| 2083 | 7253 | 7249 | 7251 | 7249 | 7249 | 7253 | 7253 | 7253 | 7251 | 7251 | 7250 | 7255 | 7254 |
| 2084 | 7253 | 7249 | 7251 | 7249 | 7249 | 7253 | 7253 | 7253 | 7251 | 7251 | 7250 | 7255 | 7254 |
| 2085 | 7253 | 7249 | 7251 | 7249 | 7249 | 7253 | 7253 | 7253 | 7251 | 7251 | 7250 | 7255 | 7254 |
| 2086 | 7253 | 7249 | 7251 | 7249 | 7249 | 7253 | 7253 | 7253 | 7251 | 7251 | 7250 | 7255 | 7254 |
| 2087 | 7253 | 7249 | 7251 | 7249 | 7249 | 7253 | 7253 | 7253 | 7251 | 7251 | 7250 | 7255 | 7254 |
| 2088 | 7253 | 7249 | 7251 | 7249 | 7249 | 7253 | 7253 | 7253 | 7251 | 7251 | 7250 | 7255 | 7254 |
| 2089 | 7253 | 7249 | 7251 | 7249 | 7249 | 7253 | 7253 | 7253 | 7251 | 7251 | 7250 | 7255 | 7254 |
| 2090 | 7253 | 7249 | 7251 | 7249 | 7249 | 7253 | 7253 | 7253 | 7251 | 7251 | 7250 | 7255 | 7254 |

|      | 105  | 106  | 107  | 108  | 109  | 110  | 111  | 112  | 113  | 114  | 115  | 116  | 117  |
|------|------|------|------|------|------|------|------|------|------|------|------|------|------|
| 2002 | 0    | 0    | 0    | 0    | 0    | 0    | 0    | 0    | 0    | 0    | 0    | 0    | 0    |
| 2003 | 0    | 0    | 0    | 0    | 0    | 0    | 0    | 0    | 0    | 0    | 0    | 0    | 0    |
| 2004 | 0    | 0    | 0    | 0    | 0    | 0    | 0    | 0    | 0    | 0    | 0    | 0    | 0    |
| 2005 | 0    | 0    | 0    | 0    | 0    | 0    | 0    | 0    | 0    | 0    | 0    | 0    | 0    |
| 2006 | 0    | 0    | 0    | 0    | 0    | 0    | 0    | 0    | 0    | 0    | 0    | 0    | 0    |
| 2007 | 0    | 0    | 0    | 0    | 0    | 0    | 0    | 0    | 0    | 0    | 0    | 0    | 0    |
| 2008 | 0    | 0    | 0    | 0    | 0    | 0    | 0    | 0    | 0    | 0    | 0    | 0    | 0    |
| 2009 | 0    | 0    | 0    | 0    | 0    | 0    | 0    | 0    | 0    | 0    | 0    | 0    | 0    |
| 2010 | 0    | 0    | 0    | 0    | 0    | 0    | 0    | 0    | 0    | 0    | 0    | 0    | 0    |
| 2011 | 0    | 0    | 0    | 0    | 0    | 0    | 0    | 0    | 0    | 0    | 0    | 0    | 0    |
| 2012 | 0    | 0    | 0    | 0    | 0    | 0    | 0    | 0    | 0    | 0    | 0    | 0    | 0    |
| 2013 | 0    | 0    | 0    | 0    | 0    | 0    | 0    | 0    | 0    | 0    | 0    | 0    | 0    |
| 2014 | 0    | 0    | 0    | 0    | 0    | 0    | 0    | 0    | 0    | 0    | 0    | 0    | 0    |
| 2015 | 0    | 0    | 0    | 0    | 0    | 0    | 0    | 0    | 0    | 0    | 0    | 0    | 0    |
| 2016 | 0    | 0    | 0    | 0    | 0    | 0    | 0    | 0    | 0    | 0    | 0    | 0    | 0    |
| 2017 | 0    | 0    | 0    | 0    | 0    | 0    | 0    | 0    | 0    | 0    | 0    | 0    | 0    |
| 2018 | 0    | 0    | 0    | 0    | 0    | 0    | 0    | 0    | 0    | 0    | 0    | 0    | 0    |
| 2019 | 0    | 0    | 0    | 0    | 0    | 0    | 0    | 0    | 0    | 0    | 0    | 0    | 0    |
| 2020 | 0    | 0    | 0    | 0    | 0    | 0    | 0    | 254  | 0    | 0    | 0    | 0    | 0    |
| 2021 | 0    | 0    | 0    | 0    | 0    | 0    | 0    | 506  | 0    | 0    | 0    | 0    | 0    |
| 2022 | 0    | 0    | 0    | 0    | 0    | 0    | 0    | 760  | 0    | 0    | 0    | 0    | 0    |
| 2023 | 0    | 0    | 0    | 0    | 0    | 0    | 0    | 1017 | 0    | 0    | 0    | 0    | 0    |
| 2024 | 0    | 0    | 0    | 0    | 0    | 0    | 0    | 1268 | 0    | 0    | 0    | 0    | 0    |
| 2025 | 250  | 250  | 250  | 250  | 256  | 256  | 0    | 1537 | 256  | 256  | 256  | 256  | 256  |
| 2026 | 590  | 590  | 590  | 590  | 506  | 506  | 0    | 1793 | 506  | 506  | 506  | 506  | 506  |
| 2027 | 937  | 937  | 937  | 937  | 757  | 757  | 0    | 2050 | 757  | 757  | 757  | 757  | 757  |
| 2028 | 1293 | 1294 | 1294 | 1294 | 1011 | 1011 | 0    | 2306 | 1011 | 1011 | 1011 | 1011 | 1011 |
| 2029 | 1629 | 1630 | 1630 | 1630 | 1261 | 1261 | 0    | 2592 | 1261 | 1261 | 1261 | 1261 | 1261 |
| 2030 | 1952 | 1954 | 1954 | 1954 | 1513 | 1513 | 256  | 2874 | 1513 | 1513 | 1513 | 1513 | 1513 |
| 2031 | 2272 | 2271 | 2271 | 2271 | 1771 | 1771 | 509  | 3142 | 1771 | 1772 | 1771 | 1771 | 1771 |
| 2032 | 2561 | 2560 | 2560 | 2560 | 2027 | 2027 | 759  | 3443 | 2027 | 2051 | 2027 | 2027 | 2027 |
| 2033 | 2841 | 2847 | 2847 | 2847 | 2289 | 2292 | 1016 | 3763 | 2277 | 2328 | 2287 | 2287 | 2287 |
| 2034 | 3171 | 3170 | 3170 | 3170 | 2553 | 2556 | 1271 | 4040 | 2536 | 2601 | 2551 | 2551 | 2551 |
| 2035 | 3470 | 3468 | 3468 | 3468 | 2830 | 2830 | 1523 | 4370 | 2803 | 2875 | 2828 | 2828 | 2828 |
| 2036 | 3752 | 3756 | 3756 | 3756 | 3144 | 3130 | 1790 | 4686 | 3089 | 3143 | 3141 | 3141 | 3141 |
| 2037 | 4013 | 4026 | 4026 | 4026 | 3449 | 3436 | 2052 | 4924 | 3366 | 3443 | 3448 | 3448 | 3448 |
| 2038 | 4274 | 4295 | 4295 | 4295 | 3782 | 3767 | 2314 | 5221 | 3715 | 3751 | 3783 | 3783 | 3783 |
| 2039 | 4537 | 4562 | 4562 | 4562 | 4070 | 4053 | 2577 | 5547 | 4011 | 4032 | 4061 | 4061 | 4061 |
| 2040 | 4848 | 4863 | 4863 | 4863 | 4405 | 4393 | 2856 | 5829 | 4366 | 4365 | 4403 | 4403 | 4403 |
| 2041 | 5149 | 5146 | 5146 | 5146 | 4689 | 4678 | 3139 | 6013 | 4644 | 4664 | 4700 | 4700 | 4700 |
| 2042 | 5457 | 5464 | 5464 | 5464 | 5046 | 5040 | 3463 | 6175 | 5039 | 5031 | 5075 | 5075 | 5075 |
| 2043 | 5709 | 5705 | 5705 | 5705 | 5176 | 5161 | 3780 | 6373 | 5081 | 5164 | 5142 | 5142 | 5142 |
| 2044 | 5983 | 5956 | 5956 | 5956 | 5343 | 5321 | 4065 | 6527 | 5223 | 5319 | 5294 | 5294 | 5294 |
| 2045 | 6252 | 6166 | 6166 | 6166 | 5561 | 5540 | 4175 | 6687 | 5436 | 5536 | 5503 | 5503 | 5503 |
| 2046 | 6292 | 6203 | 6203 | 6203 | 5731 | 5710 | 4352 | 6822 | 5650 | 5750 | 5695 | 5695 | 5695 |
| 2047 | 6532 | 6441 | 6441 | 6441 | 5926 | 5883 | 4561 | 7020 | 5825 | 5918 | 5881 | 5881 | 5881 |
| 2048 | 6755 | 6668 | 6668 | 6668 | 6092 | 6073 | 4765 | 7143 | 6002 | 6095 | 6055 | 6055 | 6055 |
| 2049 | 6958 | 6890 | 6890 | 6890 | 6235 | 6225 | 4990 | 7197 | 6158 | 6245 | 6210 | 6210 | 6210 |
| 2050 | 7083 | 7039 | 7039 | 7039 | 6412 | 6403 | 5197 | 7225 | 6329 | 6419 | 6392 | 6392 | 6392 |
| 2051 | 7139 | 7129 | 7129 | 7129 | 6581 | 6582 | 5362 | 7243 | 6517 | 6595 | 6559 | 6559 | 6559 |
| 2052 | 7179 | 7176 | 7176 | 7176 | 6777 | 6787 | 5574 | 7243 | 6680 | 6780 | 6724 | 6724 | 6724 |
| 2053 | 7215 | 7212 | 7212 | 7212 | 6949 | 6944 | 5761 | 7253 | 6876 | 6949 | 6923 | 6923 | 6923 |
| 2054 | 7235 | 7232 | 7232 | 7232 | 7080 | 7071 | 5927 | 7253 | 7045 | 7068 | 7061 | 7061 | 7061 |
| 2055 | 7246 | 7243 | 7243 | 7243 | 7144 | 7155 | 6124 | 7253 | 7126 | 7144 | 7138 | 7138 | 7138 |
| 2056 | 7254 | 7251 | 7251 | 7251 | 7191 | 7224 | 6285 | 7253 | 7189 | 7207 | 7201 | 7201 | 7201 |
| 2057 | 7254 | 7251 | 7251 | 7251 | 7240 | 7224 | 6513 | 7253 | 7239 | 7237 | 7229 | 7229 | 7229 |
| 2058 | 7254 | 7251 | 7251 | 7251 | 7241 | 7251 | 6715 | 7253 | 7244 | 7245 | 7237 | 7237 | 7237 |
| 2059 | 7254 | 7251 | 7251 | 7251 | 7254 | 7251 | 6900 | 7253 | 7253 | 7248 | 7242 | 7242 | 7242 |

|      | 105  | 106  | 107  | 108  | 109  | 110  | 111  | 112  | 113  | 114  | 115  | 116  | 117  |
|------|------|------|------|------|------|------|------|------|------|------|------|------|------|
| 2060 | 7254 | 7251 | 7251 | 7251 | 7254 | 7251 | 7025 | 7253 | 7253 | 7256 | 7250 | 7250 | 7250 |
| 2061 | 7254 | 7251 | 7251 | 7251 | 7254 | 7251 | 7121 | 7253 | 7253 | 7256 | 7250 | 7250 | 7250 |
| 2062 | 7254 | 7251 | 7251 | 7251 | 7254 | 7251 | 7186 | 7253 | 7253 | 7256 | 7250 | 7250 | 7250 |
| 2063 | 7254 | 7251 | 7251 | 7251 | 7254 | 7251 | 7235 | 7253 | 7253 | 7256 | 7250 | 7250 | 7250 |
| 2064 | 7254 | 7251 | 7251 | 7251 | 7254 | 7251 | 7245 | 7253 | 7253 | 7256 | 7250 | 7250 | 7250 |
| 2065 | 7254 | 7251 | 7251 | 7251 | 7254 | 7251 | 7250 | 7253 | 7253 | 7256 | 7250 | 7250 | 7250 |
| 2066 | 7254 | 7251 | 7251 | 7251 | 7254 | 7251 | 7250 | 7253 | 7253 | 7256 | 7250 | 7250 | 7250 |
| 2067 | 7254 | 7251 | 7251 | 7251 | 7254 | 7251 | 7250 | 7253 | 7253 | 7256 | 7250 | 7250 | 7250 |
| 2068 | 7254 | 7251 | 7251 | 7251 | 7254 | 7251 | 7250 | 7253 | 7253 | 7256 | 7250 | 7250 | 7250 |
| 2069 | 7254 | 7251 | 7251 | 7251 | 7254 | 7251 | 7250 | 7253 | 7253 | 7256 | 7250 | 7250 | 7250 |
| 2070 | 7254 | 7251 | 7251 | 7251 | 7254 | 7251 | 7250 | 7253 | 7253 | 7256 | 7250 | 7250 | 7250 |
| 2071 | 7254 | 7251 | 7251 | 7251 | 7254 | 7251 | 7250 | 7253 | 7253 | 7256 | 7250 | 7250 | 7250 |
| 2072 | 7254 | 7251 | 7251 | 7251 | 7254 | 7251 | 7250 | 7253 | 7253 | 7256 | 7250 | 7250 | 7250 |
| 2073 | 7254 | 7251 | 7251 | 7251 | 7254 | 7251 | 7250 | 7253 | 7253 | 7256 | 7250 | 7250 | 7250 |
| 2074 | 7254 | 7251 | 7251 | 7251 | 7254 | 7251 | 7250 | 7253 | 7253 | 7256 | 7250 | 7250 | 7250 |
| 2075 | 7254 | 7251 | 7251 | 7251 | 7254 | 7251 | 7250 | 7253 | 7253 | 7256 | 7250 | 7250 | 7250 |
| 2076 | 7254 | 7251 | 7251 | 7251 | 7254 | 7251 | 7250 | 7253 | 7253 | 7256 | 7250 | 7250 | 7250 |
| 2077 | 7254 | 7251 | 7251 | 7251 | 7254 | 7251 | 7250 | 7253 | 7253 | 7256 | 7250 | 7250 | 7250 |
| 2078 | 7254 | 7251 | 7251 | 7251 | 7254 | 7251 | 7250 | 7253 | 7253 | 7256 | 7250 | 7250 | 7250 |
| 2079 | 7254 | 7251 | 7251 | 7251 | 7254 | 7251 | 7250 | 7253 | 7253 | 7256 | 7250 | 7250 | 7250 |
| 2080 | 7254 | 7251 | 7251 | 7251 | 7254 | 7251 | 7250 | 7253 | 7253 | 7256 | 7250 | 7250 | 7250 |
| 2081 | 7254 | 7251 | 7251 | 7251 | 7254 | 7251 | 7250 | 7253 | 7253 | 7256 | 7250 | 7250 | 7250 |
| 2082 | 7254 | 7251 | 7251 | 7251 | 7254 | 7251 | 7250 | 7253 | 7253 | 7256 | 7250 | 7250 | 7250 |
| 2083 | 7254 | 7251 | 7251 | 7251 | 7254 | 7251 | 7250 | 7253 | 7253 | 7256 | 7250 | 7250 | 7250 |
| 2084 | 7254 | 7251 | 7251 | 7251 | 7254 | 7251 | 7250 | 7253 | 7253 | 7256 | 7250 | 7250 | 7250 |
| 2085 | 7254 | 7251 | 7251 | 7251 | 7254 | 7251 | 7250 | 7253 | 7253 | 7256 | 7250 | 7250 | 7250 |
| 2086 | 7254 | 7251 | 7251 | 7251 | 7254 | 7251 | 7250 | 7253 | 7253 | 7256 | 7250 | 7250 | 7250 |
| 2087 | 7254 | 7251 | 7251 | 7251 | 7254 | 7251 | 7250 | 7253 | 7253 | 7256 | 7250 | 7250 | 7250 |
| 2088 | 7254 | 7251 | 7251 | 7251 | 7254 | 7251 | 7250 | 7253 | 7253 | 7256 | 7250 | 7250 | 7250 |
| 2089 | 7254 | 7251 | 7251 | 7251 | 7254 | 7251 | 7250 | 7253 | 7253 | 7256 | 7250 | 7250 | 7250 |
| 2090 | 7254 | 7251 | 7251 | 7251 | 7254 | 7251 | 7250 | 7253 | 7253 | 7256 | 7250 | 7250 | 7250 |

|      | 118  | 119  | 120  | 121  | 122  | 123  | 124  | 125  | 126  | 127  | 128  | 129  | 130  |
|------|------|------|------|------|------|------|------|------|------|------|------|------|------|
| 2002 | 0    | 0    | 0    | 0    | 0    | 0    | 0    | 0    | 0    | 0    | 0    | 0    | 0    |
| 2003 | 0    | 0    | 0    | 0    | 0    | 0    | 0    | 0    | 0    | 0    | 0    | 0    | 0    |
| 2004 | 0    | 0    | 0    | 0    | 0    | 0    | 0    | 0    | 0    | 0    | 0    | 0    | 0    |
| 2005 | 0    | 0    | 0    | 0    | 0    | 0    | 0    | 0    | 0    | 0    | 0    | 0    | 0    |
| 2006 | 0    | 0    | 0    | 0    | 0    | 0    | 0    | 0    | 0    | 0    | 0    | 0    | 0    |
| 2007 | 0    | 0    | 0    | 0    | 0    | 0    | 0    | 0    | 0    | 0    | 0    | 0    | 0    |
| 2008 | 0    | 0    | 0    | 0    | 0    | 0    | 0    | 0    | 0    | 0    | 0    | 0    | 0    |
| 2009 | 0    | 0    | 0    | 0    | 0    | 0    | 0    | 0    | 0    | 0    | 0    | 0    | 0    |
| 2010 | 0    | 0    | 0    | 0    | 0    | 0    | 0    | 0    | 0    | 0    | 0    | 0    | 0    |
| 2011 | 0    | 0    | 0    | 0    | 0    | 0    | 0    | 0    | 0    | 0    | 0    | 0    | 0    |
| 2012 | 0    | 0    | 0    | 0    | 0    | 0    | 0    | 0    | 0    | 0    | 0    | 0    | 0    |
| 2013 | 0    | 0    | 0    | 0    | 0    | 0    | 0    | 0    | 0    | 0    | 0    | 0    | 0    |
| 2014 | 0    | 0    | 0    | 0    | 0    | 0    | 0    | 0    | 0    | 0    | 0    | 0    | 0    |
| 2015 | 0    | 0    | 0    | 0    | 0    | 0    | 0    | 0    | 0    | 0    | 0    | 0    | 0    |
| 2016 | 0    | 0    | 0    | 0    | 0    | 0    | 0    | 0    | 0    | 0    | 0    | 0    | 0    |
| 2017 | 0    | 0    | 0    | 0    | 0    | 0    | 0    | 0    | 0    | 0    | 0    | 0    | 0    |
| 2018 | 0    | 0    | 0    | 0    | 0    | 0    | 0    | 0    | 0    | 0    | 0    | 0    | 0    |
| 2019 | 0    | 0    | 0    | 0    | 0    | 0    | 0    | 0    | 0    | 0    | 0    | 0    | 0    |
| 2020 | 0    | 0    | 0    | 250  | 0    | 0    | 0    | 0    | 0    | 0    | 0    | 0    | 250  |
| 2021 | 0    | 0    | 0    | 505  | 0    | 0    | 0    | 0    | 0    | 0    | 0    | 0    | 505  |
| 2022 | 0    | 0    | 0    | 750  | 0    | 0    | 0    | 0    | 0    | 0    | 0    | 0    | 750  |
| 2023 | 0    | 0    | 0    | 1009 | 0    | 0    | 0    | 0    | 0    | 0    | 0    | 0    | 1009 |
| 2024 | 0    | 0    | 0    | 1289 | 0    | 0    | 0    | 0    | 0    | 0    | 0    | 0    | 1284 |
| 2025 | 250  | 250  | 0    | 1542 | 250  | 248  | 250  | 250  | 250  | 250  | 250  | 0    | 1534 |
| 2026 | 500  | 497  | 0    | 1801 | 500  | 505  | 500  | 500  | 500  | 500  | 499  | 0    | 1789 |
| 2027 | 761  | 759  | 0    | 2063 | 757  | 762  | 756  | 756  | 756  | 760  | 759  | 0    | 2046 |
| 2028 | 1006 | 1004 | 0    | 2347 | 1001 | 1005 | 1001 | 1001 | 1001 | 1003 | 1002 | 0    | 2321 |
| 2029 | 1264 | 1260 | 0    | 2625 | 1255 | 1260 | 1259 | 1259 | 1259 | 1246 | 1254 | 0    | 2584 |
| 2030 | 1536 | 1518 | 250  | 2882 | 1520 | 1526 | 1524 | 1524 | 1524 | 1514 | 1512 | 250  | 2862 |
| 2031 | 1790 | 1771 | 502  | 3181 | 1767 | 1781 | 1778 | 1778 | 1778 | 1763 | 1762 | 500  | 3147 |
| 2032 | 2050 | 2038 | 757  | 3454 | 2015 | 2043 | 2042 | 2042 | 2042 | 2015 | 2013 | 751  | 3409 |
| 2033 | 2323 | 2317 | 1017 | 3708 | 2278 | 2310 | 2317 | 2317 | 2317 | 2286 | 2281 | 1012 | 3663 |
| 2034 | 2601 | 2595 | 1281 | 3952 | 2541 | 2580 | 2591 | 2591 | 2591 | 2545 | 2545 | 1268 | 3889 |
| 2035 | 2878 | 2876 | 1552 | 4174 | 2781 | 2880 | 2875 | 2875 | 2875 | 2829 | 2830 | 1534 | 4118 |
| 2036 | 3136 | 3130 | 1814 | 4418 | 3020 | 3154 | 3121 | 3121 | 3121 | 3070 | 3068 | 1789 | 4364 |
| 2037 | 3386 | 3363 | 2071 | 4596 | 3257 | 3418 | 3374 | 3374 | 3374 | 3322 | 3322 | 2038 | 4606 |
| 2038 | 3598 | 3573 | 2352 | 4783 | 3498 | 3659 | 3587 | 3587 | 3587 | 3575 | 3578 | 2311 | 4810 |
| 2039 | 3824 | 3802 | 2620 | 4989 | 3720 | 3902 | 3816 | 3816 | 3816 | 3821 | 3829 | 2579 | 5027 |
| 2040 | 4087 | 4065 | 2897 | 5189 | 3961 | 4157 | 4076 | 4076 | 4076 | 4092 | 4084 | 2848 | 5273 |
| 2041 | 4347 | 4325 | 3180 | 5402 | 4214 | 4427 | 4324 | 4324 | 4324 | 4356 | 4351 | 3131 | 5504 |
| 2042 | 4593 | 4583 | 3444 | 5559 | 4465 | 4696 | 4582 | 4582 | 4582 | 4645 | 4624 | 3387 | 5787 |
| 2043 | 4830 | 4824 | 3714 | 5735 | 4717 | 4938 | 4808 | 4808 | 4808 | 4894 | 4887 | 3657 | 6021 |
| 2044 | 5048 | 5041 | 3974 | 5892 | 4972 | 5148 | 5023 | 5023 | 5023 | 5140 | 5139 | 3919 | 6246 |
| 2045 | 5234 | 5234 | 4205 | 6056 | 5192 | 5357 | 5212 | 5212 | 5212 | 5371 | 5371 | 4166 | 6444 |
| 2046 | 5409 | 5404 | 4415 | 6182 | 5407 | 5566 | 5386 | 5386 | 5386 | 5581 | 5558 | 4420 | 6530 |
| 2047 | 5569 | 5586 | 4595 | 6334 | 5535 | 5784 | 5550 | 5550 | 5550 | 5736 | 5695 | 4511 | 6735 |
| 2048 | 5692 | 5710 | 4743 | 6512 | 5684 | 5896 | 5667 | 5667 | 5667 | 5887 | 5899 | 4673 | 6906 |
| 2049 | 5807 | 5785 | 4967 | 6531 | 5865 | 6019 | 5777 | 5777 | 5777 | 6086 | 6075 | 4870 | 7078 |
| 2050 | 5970 | 5996 | 5173 | 6747 | 6041 | 6218 | 5977 | 5977 | 5977 | 6231 | 6254 | 5073 | 7162 |
| 2051 | 6153 | 6158 | 5358 | 6931 | 6184 | 6401 | 6149 | 6149 | 6149 | 6422 | 6426 | 5272 | 7207 |
| 2052 | 6301 | 6339 | 5528 | 7082 | 6365 | 6593 | 6316 | 6316 | 6316 | 6616 | 6632 | 5449 | 7228 |
| 2053 | 6503 | 6520 | 5708 | 7173 | 6569 | 6791 | 6501 | 6501 | 6501 | 6804 | 6824 | 5622 | 7243 |
| 2054 | 6680 | 6726 | 5905 | 7206 | 6760 | 6979 | 6681 | 6681 | 6681 | 7005 | 7001 | 5824 | 7247 |
| 2055 | 6887 | 6912 | 6088 | 7228 | 6959 | 7101 | 6902 | 6902 | 6902 | 7107 | 7114 | 6028 | 7250 |
| 2056 | 7046 | 7055 | 6269 | 7242 | 7086 | 7172 | 7043 | 7043 | 7043 | 7178 | 7182 | 6215 | 7250 |
| 2057 | 7136 | 7135 | 6500 | 7246 | 7167 | 7216 | 7130 | 7130 | 7130 | 7210 | 7220 | 6400 | 7250 |
| 2058 | 7177 | 7186 | 6723 | 7246 | 7211 | 7234 | 7175 | 7175 | 7175 | 7240 | 7241 | 6619 | 7250 |
| 2059 | 7215 | 7218 | 6896 | 7250 | 7232 | 7249 | 7214 | 7214 | 7214 | 7257 | 7256 | 6842 | 7250 |

|      | 118  | 119  | 120  | 121  | 122  | 123  | 124  | 125  | 126  | 127  | 128  | 129  | 130  |
|------|------|------|------|------|------|------|------|------|------|------|------|------|------|
| 2060 | 7238 | 7239 | 7020 | 7250 | 7244 | 7251 | 7235 | 7235 | 7235 | 7257 | 7256 | 6979 | 7250 |
| 2061 | 7255 | 7249 | 7086 | 7250 | 7254 | 7251 | 7247 | 7247 | 7247 | 7257 | 7256 | 7062 | 7250 |
| 2062 | 7255 | 7256 | 7130 | 7250 | 7254 | 7251 | 7249 | 7249 | 7249 | 7257 | 7256 | 7121 | 7250 |
| 2063 | 7255 | 7256 | 7170 | 7250 | 7254 | 7251 | 7249 | 7249 | 7249 | 7257 | 7256 | 7165 | 7250 |
| 2064 | 7255 | 7256 | 7210 | 7250 | 7254 | 7251 | 7249 | 7249 | 7249 | 7257 | 7256 | 7205 | 7250 |
| 2065 | 7255 | 7256 | 7241 | 7250 | 7254 | 7251 | 7249 | 7249 | 7249 | 7257 | 7256 | 7244 | 7250 |
| 2066 | 7255 | 7256 | 7256 | 7250 | 7254 | 7251 | 7249 | 7249 | 7249 | 7257 | 7256 | 7250 | 7250 |
| 2067 | 7255 | 7256 | 7256 | 7250 | 7254 | 7251 | 7249 | 7249 | 7249 | 7257 | 7256 | 7250 | 7250 |
| 2068 | 7255 | 7256 | 7256 | 7250 | 7254 | 7251 | 7249 | 7249 | 7249 | 7257 | 7256 | 7250 | 7250 |
| 2069 | 7255 | 7256 | 7256 | 7250 | 7254 | 7251 | 7249 | 7249 | 7249 | 7257 | 7256 | 7250 | 7250 |
| 2070 | 7255 | 7256 | 7256 | 7250 | 7254 | 7251 | 7249 | 7249 | 7249 | 7257 | 7256 | 7250 | 7250 |
| 2071 | 7255 | 7256 | 7256 | 7250 | 7254 | 7251 | 7249 | 7249 | 7249 | 7257 | 7256 | 7250 | 7250 |
| 2072 | 7255 | 7256 | 7256 | 7250 | 7254 | 7251 | 7249 | 7249 | 7249 | 7257 | 7256 | 7250 | 7250 |
| 2073 | 7255 | 7256 | 7256 | 7250 | 7254 | 7251 | 7249 | 7249 | 7249 | 7257 | 7256 | 7250 | 7250 |
| 2074 | 7255 | 7256 | 7256 | 7250 | 7254 | 7251 | 7249 | 7249 | 7249 | 7257 | 7256 | 7250 | 7250 |
| 2075 | 7255 | 7256 | 7256 | 7250 | 7254 | 7251 | 7249 | 7249 | 7249 | 7257 | 7256 | 7250 | 7250 |
| 2076 | 7255 | 7256 | 7256 | 7250 | 7254 | 7251 | 7249 | 7249 | 7249 | 7257 | 7256 | 7250 | 7250 |
| 2077 | 7255 | 7256 | 7256 | 7250 | 7254 | 7251 | 7249 | 7249 | 7249 | 7257 | 7256 | 7250 | 7250 |
| 2078 | 7255 | 7256 | 7256 | 7250 | 7254 | 7251 | 7249 | 7249 | 7249 | 7257 | 7256 | 7250 | 7250 |
| 2079 | 7255 | 7256 | 7256 | 7250 | 7254 | 7251 | 7249 | 7249 | 7249 | 7257 | 7256 | 7250 | 7250 |
| 2080 | 7255 | 7256 | 7256 | 7250 | 7254 | 7251 | 7249 | 7249 | 7249 | 7257 | 7256 | 7250 | 7250 |
| 2081 | 7255 | 7256 | 7256 | 7250 | 7254 | 7251 | 7249 | 7249 | 7249 | 7257 | 7256 | 7250 | 7250 |
| 2082 | 7255 | 7256 | 7256 | 7250 | 7254 | 7251 | 7249 | 7249 | 7249 | 7257 | 7256 | 7250 | 7250 |
| 2083 | 7255 | 7256 | 7256 | 7250 | 7254 | 7251 | 7249 | 7249 | 7249 | 7257 | 7256 | 7250 | 7250 |
| 2084 | 7255 | 7256 | 7256 | 7250 | 7254 | 7251 | 7249 | 7249 | 7249 | 7257 | 7256 | 7250 | 7250 |
| 2085 | 7255 | 7256 | 7256 | 7250 | 7254 | 7251 | 7249 | 7249 | 7249 | 7257 | 7256 | 7250 | 7250 |
| 2086 | 7255 | 7256 | 7256 | 7250 | 7254 | 7251 | 7249 | 7249 | 7249 | 7257 | 7256 | 7250 | 7250 |
| 2087 | 7255 | 7256 | 7256 | 7250 | 7254 | 7251 | 7249 | 7249 | 7249 | 7257 | 7256 | 7250 | 7250 |
| 2088 | 7255 | 7256 | 7256 | 7250 | 7254 | 7251 | 7249 | 7249 | 7249 | 7257 | 7256 | 7250 | 7250 |
| 2089 | 7255 | 7256 | 7256 | 7250 | 7254 | 7251 | 7249 | 7249 | 7249 | 7257 | 7256 | 7250 | 7250 |
| 2090 | 7255 | 7256 | 7256 | 7250 | 7254 | 7251 | 7249 | 7249 | 7249 | 7257 | 7256 | 7250 | 7250 |



|      | 131  | 132  | 133  | 134  | 135  | 136  | 137  | 138  | 139  | 140  | 141  | 142  | 143  |
|------|------|------|------|------|------|------|------|------|------|------|------|------|------|
| 2002 | 0    | 0    | 0    | 0    | 0    | 0    | 0    | 0    | 0    | 0    | 0    | 0    | 0    |
| 2003 | 0    | 0    | 0    | 0    | 0    | 0    | 0    | 0    | 0    | 0    | 0    | 0    | 0    |
| 2004 | 0    | 0    | 0    | 0    | 0    | 0    | 0    | 0    | 0    | 0    | 0    | 0    | 0    |
| 2005 | 0    | 0    | 0    | 0    | 0    | 0    | 0    | 0    | 0    | 0    | 0    | 0    | 0    |
| 2006 | 0    | 0    | 0    | 0    | 0    | 0    | 0    | 0    | 0    | 0    | 0    | 0    | 0    |
| 2007 | 0    | 0    | 0    | 0    | 0    | 0    | 0    | 0    | 0    | 0    | 0    | 0    | 0    |
| 2008 | 0    | 0    | 0    | 0    | 0    | 0    | 0    | 0    | 0    | 0    | 0    | 0    | 0    |
| 2009 | 0    | 0    | 0    | 0    | 0    | 0    | 0    | 0    | 0    | 0    | 0    | 0    | 0    |
| 2010 | 0    | 0    | 0    | 0    | 0    | 0    | 0    | 0    | 0    | 0    | 0    | 0    | 0    |
| 2011 | 0    | 0    | 0    | 0    | 0    | 0    | 0    | 0    | 0    | 0    | 0    | 0    | 0    |
| 2012 | 0    | 0    | 0    | 0    | 0    | 0    | 0    | 0    | 0    | 0    | 0    | 0    | 0    |
| 2013 | 0    | 0    | 0    | 0    | 0    | 0    | 0    | 0    | 0    | 0    | 0    | 0    | 0    |
| 2014 | 0    | 0    | 0    | 0    | 0    | 0    | 0    | 0    | 0    | 0    | 0    | 0    | 0    |
| 2015 | 0    | 0    | 0    | 0    | 0    | 0    | 0    | 0    | 0    | 0    | 0    | 0    | 0    |
| 2016 | 0    | 0    | 0    | 0    | 0    | 0    | 0    | 0    | 0    | 0    | 0    | 0    | 0    |
| 2017 | 0    | 0    | 0    | 0    | 0    | 0    | 0    | 0    | 0    | 0    | 0    | 0    | 0    |
| 2018 | 0    | 0    | 0    | 0    | 0    | 0    | 0    | 0    | 0    | 0    | 0    | 0    | 0    |
| 2019 | 0    | 0    | 0    | 0    | 0    | 0    | 0    | 0    | 0    | 0    | 0    | 0    | 0    |
| 2020 | 0    | 0    | 0    | 0    | 0    | 0    | 0    | 0    | 254  | 0    | 0    | 0    | 0    |
| 2021 | 0    | 0    | 0    | 0    | 0    | 0    | 0    | 0    | 529  | 0    | 0    | 0    | 0    |
| 2022 | 0    | 0    | 0    | 0    | 0    | 0    | 0    | 0    | 838  | 0    | 0    | 0    | 0    |
| 2023 | 0    | 0    | 0    | 0    | 0    | 0    | 0    | 0    | 1121 | 0    | 0    | 0    | 0    |
| 2024 | 0    | 0    | 0    | 0    | 0    | 0    | 0    | 0    | 1420 | 0    | 0    | 0    | 0    |
| 2025 | 250  | 250  | 250  | 250  | 250  | 256  | 256  | 0    | 1701 | 256  | 256  | 256  | 256  |
| 2026 | 500  | 503  | 500  | 500  | 500  | 518  | 516  | 0    | 2022 | 518  | 518  | 518  | 518  |
| 2027 | 757  | 759  | 756  | 756  | 756  | 823  | 816  | 0    | 2305 | 814  | 814  | 814  | 814  |
| 2028 | 1010 | 1005 | 999  | 999  | 999  | 1106 | 1094 | 0    | 2592 | 1096 | 1096 | 1096 | 1096 |
| 2029 | 1262 | 1260 | 1251 | 1251 | 1251 | 1401 | 1396 | 0    | 2867 | 1405 | 1405 | 1405 | 1405 |
| 2030 | 1523 | 1521 | 1515 | 1515 | 1515 | 1710 | 1700 | 256  | 3188 | 1716 | 1716 | 1716 | 1716 |
| 2031 | 1769 | 1786 | 1765 | 1765 | 1765 | 2010 | 1988 | 528  | 3483 | 2013 | 2013 | 2013 | 2013 |
| 2032 | 2012 | 2045 | 2012 | 2012 | 2012 | 2305 | 2278 | 806  | 3763 | 2321 | 2321 | 2321 | 2321 |
| 2033 | 2277 | 2312 | 2281 | 2281 | 2281 | 2605 | 2562 | 1121 | 4043 | 2624 | 2624 | 2624 | 2624 |
| 2034 | 2516 | 2593 | 2543 | 2543 | 2543 | 2890 | 2866 | 1438 | 4412 | 2906 | 2906 | 2906 | 2906 |
| 2035 | 2767 | 2893 | 2834 | 2834 | 2834 | 3190 | 3147 | 1810 | 4690 | 3181 | 3181 | 3181 | 3181 |
| 2036 | 2995 | 3156 | 3083 | 3083 | 3083 | 3458 | 3462 | 2148 | 5093 | 3491 | 3505 | 3491 | 3491 |
| 2037 | 3229 | 3401 | 3334 | 3334 | 3334 | 3786 | 3749 | 2479 | 5380 | 3799 | 3800 | 3799 | 3799 |
| 2038 | 3466 | 3646 | 3582 | 3582 | 3582 | 4064 | 4065 | 2782 | 5632 | 4076 | 4109 | 4076 | 4076 |
| 2039 | 3702 | 3896 | 3823 | 3823 | 3823 | 4398 | 4377 | 3086 | 5981 | 4395 | 4404 | 4400 | 4400 |
| 2040 | 3959 | 4169 | 4084 | 4084 | 4084 | 4714 | 4689 | 3378 | 6297 | 4706 | 4751 | 4723 | 4723 |
| 2041 | 4205 | 4442 | 4358 | 4358 | 4358 | 5071 | 5015 | 3670 | 6549 | 5045 | 5074 | 5076 | 5076 |
| 2042 | 4470 | 4707 | 4632 | 4632 | 4632 | 5384 | 5372 | 3938 | 6696 | 5408 | 5429 | 5396 | 5396 |
| 2043 | 4716 | 4962 | 4886 | 4886 | 4886 | 5793 | 5752 | 4222 | 6711 | 5720 | 5766 | 5759 | 5759 |
| 2044 | 4993 | 5212 | 5135 | 5135 | 5135 | 6162 | 6115 | 4500 | 6917 | 6147 | 6154 | 6148 | 6148 |
| 2045 | 5236 | 5465 | 5374 | 5374 | 5374 | 6189 | 6151 | 4855 | 7043 | 6164 | 6199 | 6184 | 6184 |
| 2046 | 5379 | 5715 | 5574 | 5574 | 5574 | 6413 | 6373 | 5196 | 7141 | 6392 | 6232 | 6403 | 6403 |
| 2047 | 5542 | 5872 | 5718 | 5718 | 5718 | 6588 | 6555 | 5513 | 7199 | 6559 | 6459 | 6580 | 6580 |
| 2048 | 5730 | 6001 | 5909 | 5909 | 5909 | 6758 | 6755 | 5599 | 7234 | 6738 | 6635 | 6759 | 6759 |
| 2049 | 5930 | 6191 | 6102 | 6102 | 6102 | 6917 | 6920 | 5660 | 7239 | 6895 | 6827 | 6906 | 6906 |
| 2050 | 6074 | 6384 | 6244 | 6244 | 6244 | 7046 | 7032 | 5862 | 7255 | 7018 | 6956 | 7029 | 7029 |
| 2051 | 6227 | 6543 | 6416 | 6416 | 6416 | 7123 | 7121 | 6060 | 7255 | 7111 | 7060 | 7123 | 7123 |
| 2052 | 6424 | 6764 | 6617 | 6617 | 6617 | 7185 | 7197 | 6265 | 7255 | 7163 | 7139 | 7183 | 7183 |
| 2053 | 6596 | 6956 | 6837 | 6837 | 6837 | 7229 | 7227 | 6442 | 7255 | 7214 | 7201 | 7229 | 7229 |
| 2054 | 6806 | 7089 | 7022 | 7022 | 7022 | 7235 | 7227 | 6593 | 7255 | 7231 | 7237 | 7231 | 7231 |
| 2055 | 6991 | 7161 | 7119 | 7119 | 7119 | 7247 | 7249 | 6762 | 7255 | 7243 | 7239 | 7245 | 7245 |
| 2056 | 7101 | 7212 | 7181 | 7181 | 7181 | 7247 | 7250 | 6917 | 7255 | 7245 | 7251 | 7250 | 7250 |
| 2057 | 7170 | 7233 | 7225 | 7225 | 7225 | 7253 | 7250 | 7013 | 7255 | 7248 | 7251 | 7250 | 7250 |
| 2058 | 7214 | 7245 | 7246 | 7246 | 7246 | 7253 | 7250 | 7096 | 7255 | 7250 | 7251 | 7250 | 7250 |
| 2059 | 7235 | 7248 | 7258 | 7258 | 7258 | 7253 | 7250 | 7160 | 7255 | 7250 | 7251 | 7250 | 7250 |

|      | 131  | 132  | 133  | 134  | 135  | 136  | 137  | 138  | 139  | 140  | 141  | 142  | 143  |
|------|------|------|------|------|------|------|------|------|------|------|------|------|------|
| 2060 | 7247 | 7249 | 7258 | 7258 | 7258 | 7253 | 7250 | 7208 | 7255 | 7250 | 7251 | 7250 | 7250 |
| 2061 | 7249 | 7252 | 7258 | 7258 | 7258 | 7253 | 7250 | 7241 | 7255 | 7250 | 7251 | 7250 | 7250 |
| 2062 | 7249 | 7252 | 7258 | 7258 | 7258 | 7253 | 7250 | 7251 | 7255 | 7250 | 7251 | 7250 | 7250 |
| 2063 | 7249 | 7252 | 7258 | 7258 | 7258 | 7253 | 7250 | 7251 | 7255 | 7250 | 7251 | 7250 | 7250 |
| 2064 | 7249 | 7252 | 7258 | 7258 | 7258 | 7253 | 7250 | 7251 | 7255 | 7250 | 7251 | 7250 | 7250 |
| 2065 | 7249 | 7252 | 7258 | 7258 | 7258 | 7253 | 7250 | 7251 | 7255 | 7250 | 7251 | 7250 | 7250 |
| 2066 | 7249 | 7252 | 7258 | 7258 | 7258 | 7253 | 7250 | 7251 | 7255 | 7250 | 7251 | 7250 | 7250 |
| 2067 | 7249 | 7252 | 7258 | 7258 | 7258 | 7253 | 7250 | 7251 | 7255 | 7250 | 7251 | 7250 | 7250 |
| 2068 | 7249 | 7252 | 7258 | 7258 | 7258 | 7253 | 7250 | 7251 | 7255 | 7250 | 7251 | 7250 | 7250 |
| 2069 | 7249 | 7252 | 7258 | 7258 | 7258 | 7253 | 7250 | 7251 | 7255 | 7250 | 7251 | 7250 | 7250 |
| 2070 | 7249 | 7252 | 7258 | 7258 | 7258 | 7253 | 7250 | 7251 | 7255 | 7250 | 7251 | 7250 | 7250 |
| 2071 | 7249 | 7252 | 7258 | 7258 | 7258 | 7253 | 7250 | 7251 | 7255 | 7250 | 7251 | 7250 | 7250 |
| 2072 | 7249 | 7252 | 7258 | 7258 | 7258 | 7253 | 7250 | 7251 | 7255 | 7250 | 7251 | 7250 | 7250 |
| 2073 | 7249 | 7252 | 7258 | 7258 | 7258 | 7253 | 7250 | 7251 | 7255 | 7250 | 7251 | 7250 | 7250 |
| 2074 | 7249 | 7252 | 7258 | 7258 | 7258 | 7253 | 7250 | 7251 | 7255 | 7250 | 7251 | 7250 | 7250 |
| 2075 | 7249 | 7252 | 7258 | 7258 | 7258 | 7253 | 7250 | 7251 | 7255 | 7250 | 7251 | 7250 | 7250 |
| 2076 | 7249 | 7252 | 7258 | 7258 | 7258 | 7253 | 7250 | 7251 | 7255 | 7250 | 7251 | 7250 | 7250 |
| 2077 | 7249 | 7252 | 7258 | 7258 | 7258 | 7253 | 7250 | 7251 | 7255 | 7250 | 7251 | 7250 | 7250 |
| 2078 | 7249 | 7252 | 7258 | 7258 | 7258 | 7253 | 7250 | 7251 | 7255 | 7250 | 7251 | 7250 | 7250 |
| 2079 | 7249 | 7252 | 7258 | 7258 | 7258 | 7253 | 7250 | 7251 | 7255 | 7250 | 7251 | 7250 | 7250 |
| 2080 | 7249 | 7252 | 7258 | 7258 | 7258 | 7253 | 7250 | 7251 | 7255 | 7250 | 7251 | 7250 | 7250 |
| 2081 | 7249 | 7252 | 7258 | 7258 | 7258 | 7253 | 7250 | 7251 | 7255 | 7250 | 7251 | 7250 | 7250 |
| 2082 | 7249 | 7252 | 7258 | 7258 | 7258 | 7253 | 7250 | 7251 | 7255 | 7250 | 7251 | 7250 | 7250 |
| 2083 | 7249 | 7252 | 7258 | 7258 | 7258 | 7253 | 7250 | 7251 | 7255 | 7250 | 7251 | 7250 | 7250 |
| 2084 | 7249 | 7252 | 7258 | 7258 | 7258 | 7253 | 7250 | 7251 | 7255 | 7250 | 7251 | 7250 | 7250 |
| 2085 | 7249 | 7252 | 7258 | 7258 | 7258 | 7253 | 7250 | 7251 | 7255 | 7250 | 7251 | 7250 | 7250 |
| 2086 | 7249 | 7252 | 7258 | 7258 | 7258 | 7253 | 7250 | 7251 | 7255 | 7250 | 7251 | 7250 | 7250 |
| 2087 | 7249 | 7252 | 7258 | 7258 | 7258 | 7253 | 7250 | 7251 | 7255 | 7250 | 7251 | 7250 | 7250 |
| 2088 | 7249 | 7252 | 7258 | 7258 | 7258 | 7253 | 7250 | 7251 | 7255 | 7250 | 7251 | 7250 | 7250 |
| 2089 | 7249 | 7252 | 7258 | 7258 | 7258 | 7253 | 7250 | 7251 | 7255 | 7250 | 7251 | 7250 | 7250 |
| 2090 | 7249 | 7252 | 7258 | 7258 | 7258 | 7253 | 7250 | 7251 | 7255 | 7250 | 7251 | 7250 | 7250 |

|      | 144  | 145  | 146  | 147  | 148  | 149  | 150  | 151  | 152  | 153  | 154  | 155  | 156  |
|------|------|------|------|------|------|------|------|------|------|------|------|------|------|
| 2002 | 0    | 0    | 0    | 0    | 0    | 0    | 0    | 0    | 0    | 0    | 0    | 0    | 0    |
| 2003 | 0    | 0    | 0    | 0    | 0    | 0    | 0    | 0    | 0    | 0    | 0    | 0    | 0    |
| 2004 | 0    | 0    | 0    | 0    | 0    | 0    | 0    | 0    | 0    | 0    | 0    | 0    | 0    |
| 2005 | 0    | 0    | 0    | 0    | 0    | 0    | 0    | 0    | 0    | 0    | 0    | 0    | 0    |
| 2006 | 0    | 0    | 0    | 0    | 0    | 0    | 0    | 0    | 0    | 0    | 0    | 0    | 0    |
| 2007 | 0    | 0    | 0    | 0    | 0    | 0    | 0    | 0    | 0    | 0    | 0    | 0    | 0    |
| 2008 | 0    | 0    | 0    | 0    | 0    | 0    | 0    | 0    | 0    | 0    | 0    | 0    | 0    |
| 2009 | 0    | 0    | 0    | 0    | 0    | 0    | 0    | 0    | 0    | 0    | 0    | 0    | 0    |
| 2010 | 0    | 0    | 0    | 0    | 0    | 0    | 0    | 0    | 0    | 0    | 0    | 0    | 0    |
| 2011 | 0    | 0    | 0    | 0    | 0    | 0    | 0    | 0    | 0    | 0    | 0    | 0    | 0    |
| 2012 | 0    | 0    | 0    | 0    | 0    | 0    | 0    | 0    | 0    | 0    | 0    | 0    | 0    |
| 2013 | 0    | 0    | 0    | 0    | 0    | 0    | 0    | 0    | 0    | 0    | 0    | 0    | 0    |
| 2014 | 0    | 0    | 0    | 0    | 0    | 0    | 0    | 0    | 0    | 0    | 0    | 0    | 0    |
| 2015 | 0    | 0    | 0    | 0    | 0    | 0    | 0    | 0    | 0    | 0    | 0    | 0    | 0    |
| 2016 | 0    | 0    | 0    | 0    | 0    | 0    | 0    | 0    | 0    | 0    | 0    | 0    | 0    |
| 2017 | 0    | 0    | 0    | 0    | 0    | 0    | 0    | 0    | 0    | 0    | 0    | 0    | 0    |
| 2018 | 0    | 0    | 0    | 0    | 0    | 0    | 0    | 0    | 0    | 0    | 0    | 0    | 0    |
| 2019 | 0    | 0    | 0    | 0    | 0    | 0    | 0    | 0    | 0    | 0    | 0    | 0    | 0    |
| 2020 | 0    | 0    | 0    | 0    | 250  | 0    | 0    | 0    | 0    | 0    | 0    | 0    | 0    |
| 2021 | 0    | 0    | 0    | 0    | 590  | 0    | 0    | 0    | 0    | 0    | 0    | 0    | 0    |
| 2022 | 0    | 0    | 0    | 0    | 900  | 0    | 0    | 0    | 0    | 0    | 0    | 0    | 0    |
| 2023 | 0    | 0    | 0    | 0    | 1215 | 0    | 0    | 0    | 0    | 0    | 0    | 0    | 0    |
| 2024 | 0    | 0    | 0    | 0    | 1540 | 0    | 0    | 0    | 0    | 0    | 0    | 0    | 0    |
| 2025 | 256  | 250  | 250  | 0    | 1833 | 250  | 248  | 250  | 250  | 250  | 250  | 250  | 0    |
| 2026 | 518  | 574  | 561  | 0    | 2117 | 575  | 573  | 575  | 575  | 575  | 574  | 563  | 0    |
| 2027 | 814  | 907  | 886  | 0    | 2407 | 903  | 901  | 903  | 903  | 903  | 907  | 888  | 0    |
| 2028 | 1096 | 1243 | 1223 | 0    | 2710 | 1252 | 1242 | 1250 | 1250 | 1250 | 1243 | 1223 | 0    |
| 2029 | 1405 | 1568 | 1550 | 0    | 2998 | 1583 | 1574 | 1581 | 1581 | 1581 | 1568 | 1550 | 0    |
| 2030 | 1716 | 1888 | 1869 | 250  | 3271 | 1898 | 1888 | 1896 | 1896 | 1896 | 1888 | 1869 | 250  |
| 2031 | 2013 | 2216 | 2193 | 605  | 3549 | 2209 | 2207 | 2212 | 2212 | 2212 | 2216 | 2193 | 605  |
| 2032 | 2321 | 2519 | 2506 | 960  | 3834 | 2493 | 2498 | 2503 | 2503 | 2503 | 2519 | 2506 | 960  |
| 2033 | 2624 | 2799 | 2798 | 1297 | 4120 | 2769 | 2775 | 2783 | 2783 | 2783 | 2804 | 2801 | 1297 |
| 2034 | 2906 | 3113 | 3128 | 1667 | 4448 | 3084 | 3099 | 3112 | 3112 | 3112 | 3113 | 3128 | 1667 |
| 2035 | 3181 | 3407 | 3430 | 2027 | 4692 | 3377 | 3397 | 3410 | 3410 | 3410 | 3411 | 3430 | 2027 |
| 2036 | 3491 | 3699 | 3715 | 2345 | 4914 | 3667 | 3680 | 3692 | 3692 | 3692 | 3710 | 3728 | 2345 |
| 2037 | 3799 | 3957 | 3965 | 2661 | 5118 | 3927 | 3945 | 3954 | 3954 | 3954 | 3982 | 3992 | 2661 |
| 2038 | 4076 | 4209 | 4216 | 3019 | 5310 | 4180 | 4203 | 4194 | 4194 | 4194 | 4252 | 4265 | 3019 |
| 2039 | 4400 | 4443 | 4452 | 3336 | 5515 | 4441 | 4468 | 4436 | 4436 | 4436 | 4525 | 4528 | 3336 |
| 2040 | 4723 | 4721 | 4716 | 3614 | 5712 | 4724 | 4751 | 4706 | 4706 | 4706 | 4829 | 4817 | 3618 |
| 2041 | 5076 | 4983 | 4981 | 3952 | 5919 | 4999 | 5036 | 4975 | 4975 | 4975 | 5105 | 5090 | 3958 |
| 2042 | 5396 | 5262 | 5243 | 4216 | 6168 | 5290 | 5261 | 5257 | 5257 | 5257 | 5423 | 5393 | 4231 |
| 2043 | 5759 | 5493 | 5477 | 4489 | 6401 | 5523 | 5471 | 5485 | 5485 | 5485 | 5664 | 5634 | 4503 |
| 2044 | 6148 | 5679 | 5665 | 4746 | 6598 | 5723 | 5685 | 5673 | 5673 | 5673 | 5914 | 5884 | 4776 |
| 2045 | 6184 | 5862 | 5847 | 4975 | 6676 | 5906 | 5910 | 5857 | 5857 | 5857 | 6162 | 6143 | 5045 |
| 2046 | 6403 | 6036 | 6001 | 5194 | 6701 | 6094 | 6144 | 6011 | 6011 | 6011 | 6185 | 6206 | 5310 |
| 2047 | 6580 | 6196 | 6195 | 5423 | 6886 | 6174 | 6249 | 6195 | 6195 | 6195 | 6411 | 6220 | 5581 |
| 2048 | 6759 | 6196 | 6199 | 5641 | 7036 | 6174 | 6298 | 6197 | 6197 | 6197 | 6625 | 6431 | 5680 |
| 2049 | 6906 | 6432 | 6409 | 5691 | 7151 | 6397 | 6520 | 6418 | 6418 | 6418 | 6818 | 6649 | 5714 |
| 2050 | 7029 | 6649 | 6620 | 5694 | 7191 | 6611 | 6712 | 6626 | 6626 | 6626 | 6982 | 6856 | 5946 |
| 2051 | 7123 | 6835 | 6819 | 5923 | 7215 | 6806 | 6923 | 6829 | 6829 | 6829 | 7101 | 7020 | 6141 |
| 2052 | 7183 | 6999 | 6986 | 6129 | 7235 | 6994 | 7065 | 7001 | 7001 | 7001 | 7160 | 7126 | 6339 |
| 2053 | 7229 | 7111 | 7102 | 6333 | 7247 | 7100 | 7143 | 7090 | 7090 | 7090 | 7198 | 7182 | 6568 |
| 2054 | 7231 | 7167 | 7158 | 6548 | 7251 | 7170 | 7188 | 7160 | 7160 | 7160 | 7221 | 7220 | 6794 |
| 2055 | 7245 | 7205 | 7196 | 6767 | 7251 | 7214 | 7227 | 7204 | 7204 | 7204 | 7241 | 7241 | 6973 |
| 2056 | 7250 | 7228 | 7217 | 6940 | 7251 | 7235 | 7248 | 7225 | 7225 | 7225 | 7249 | 7261 | 7080 |
| 2057 | 7250 | 7248 | 7237 | 7063 | 7251 | 7247 | 7260 | 7237 | 7237 | 7237 | 7249 | 7261 | 7147 |
| 2058 | 7250 | 7256 | 7247 | 7140 | 7251 | 7257 | 7260 | 7247 | 7247 | 7247 | 7249 | 7261 | 7198 |
| 2059 | 7250 | 7256 | 7254 | 7193 | 7251 | 7257 | 7260 | 7249 | 7249 | 7249 | 7249 | 7261 | 7224 |

|      | 144  | 145  | 146  | 147  | 148  | 149  | 150  | 151  | 152  | 153  | 154  | 155  | 156  |
|------|------|------|------|------|------|------|------|------|------|------|------|------|------|
| 2060 | 7250 | 7256 | 7254 | 7215 | 7251 | 7257 | 7260 | 7249 | 7249 | 7249 | 7249 | 7261 | 7239 |
| 2061 | 7250 | 7256 | 7254 | 7230 | 7251 | 7257 | 7260 | 7249 | 7249 | 7249 | 7249 | 7261 | 7249 |
| 2062 | 7250 | 7256 | 7254 | 7240 | 7251 | 7257 | 7260 | 7249 | 7249 | 7249 | 7249 | 7261 | 7259 |
| 2063 | 7250 | 7256 | 7254 | 7250 | 7251 | 7257 | 7260 | 7249 | 7249 | 7249 | 7249 | 7261 | 7259 |
| 2064 | 7250 | 7256 | 7254 | 7250 | 7251 | 7257 | 7260 | 7249 | 7249 | 7249 | 7249 | 7261 | 7259 |
| 2065 | 7250 | 7256 | 7254 | 7250 | 7251 | 7257 | 7260 | 7249 | 7249 | 7249 | 7249 | 7261 | 7259 |
| 2066 | 7250 | 7256 | 7254 | 7250 | 7251 | 7257 | 7260 | 7249 | 7249 | 7249 | 7249 | 7261 | 7259 |
| 2067 | 7250 | 7256 | 7254 | 7250 | 7251 | 7257 | 7260 | 7249 | 7249 | 7249 | 7249 | 7261 | 7259 |
| 2068 | 7250 | 7256 | 7254 | 7250 | 7251 | 7257 | 7260 | 7249 | 7249 | 7249 | 7249 | 7261 | 7259 |
| 2069 | 7250 | 7256 | 7254 | 7250 | 7251 | 7257 | 7260 | 7249 | 7249 | 7249 | 7249 | 7261 | 7259 |
| 2070 | 7250 | 7256 | 7254 | 7250 | 7251 | 7257 | 7260 | 7249 | 7249 | 7249 | 7249 | 7261 | 7259 |
| 2071 | 7250 | 7256 | 7254 | 7250 | 7251 | 7257 | 7260 | 7249 | 7249 | 7249 | 7249 | 7261 | 7259 |
| 2072 | 7250 | 7256 | 7254 | 7250 | 7251 | 7257 | 7260 | 7249 | 7249 | 7249 | 7249 | 7261 | 7259 |
| 2073 | 7250 | 7256 | 7254 | 7250 | 7251 | 7257 | 7260 | 7249 | 7249 | 7249 | 7249 | 7261 | 7259 |
| 2074 | 7250 | 7256 | 7254 | 7250 | 7251 | 7257 | 7260 | 7249 | 7249 | 7249 | 7249 | 7261 | 7259 |
| 2075 | 7250 | 7256 | 7254 | 7250 | 7251 | 7257 | 7260 | 7249 | 7249 | 7249 | 7249 | 7261 | 7259 |
| 2076 | 7250 | 7256 | 7254 | 7250 | 7251 | 7257 | 7260 | 7249 | 7249 | 7249 | 7249 | 7261 | 7259 |
| 2077 | 7250 | 7256 | 7254 | 7250 | 7251 | 7257 | 7260 | 7249 | 7249 | 7249 | 7249 | 7261 | 7259 |
| 2078 | 7250 | 7256 | 7254 | 7250 | 7251 | 7257 | 7260 | 7249 | 7249 | 7249 | 7249 | 7261 | 7259 |
| 2079 | 7250 | 7256 | 7254 | 7250 | 7251 | 7257 | 7260 | 7249 | 7249 | 7249 | 7249 | 7261 | 7259 |
| 2080 | 7250 | 7256 | 7254 | 7250 | 7251 | 7257 | 7260 | 7249 | 7249 | 7249 | 7249 | 7261 | 7259 |
| 2081 | 7250 | 7256 | 7254 | 7250 | 7251 | 7257 | 7260 | 7249 | 7249 | 7249 | 7249 | 7261 | 7259 |
| 2082 | 7250 | 7256 | 7254 | 7250 | 7251 | 7257 | 7260 | 7249 | 7249 | 7249 | 7249 | 7261 | 7259 |
| 2083 | 7250 | 7256 | 7254 | 7250 | 7251 | 7257 | 7260 | 7249 | 7249 | 7249 | 7249 | 7261 | 7259 |
| 2084 | 7250 | 7256 | 7254 | 7250 | 7251 | 7257 | 7260 | 7249 | 7249 | 7249 | 7249 | 7261 | 7259 |
| 2085 | 7250 | 7256 | 7254 | 7250 | 7251 | 7257 | 7260 | 7249 | 7249 | 7249 | 7249 | 7261 | 7259 |
| 2086 | 7250 | 7256 | 7254 | 7250 | 7251 | 7257 | 7260 | 7249 | 7249 | 7249 | 7249 | 7261 | 7259 |
| 2087 | 7250 | 7256 | 7254 | 7250 | 7251 | 7257 | 7260 | 7249 | 7249 | 7249 | 7249 | 7261 | 7259 |
| 2088 | 7250 | 7256 | 7254 | 7250 | 7251 | 7257 | 7260 | 7249 | 7249 | 7249 | 7249 | 7261 | 7259 |
| 2089 | 7250 | 7256 | 7254 | 7250 | 7251 | 7257 | 7260 | 7249 | 7249 | 7249 | 7249 | 7261 | 7259 |
| 2090 | 7250 | 7256 | 7254 | 7250 | 7251 | 7257 | 7260 | 7249 | 7249 | 7249 | 7249 | 7261 | 7259 |

|      | 157  | 158  | 159  | 160  | 161  | 162  |
|------|------|------|------|------|------|------|
| 2002 | 0    | 0    | 0    | 0    | 0    | 0    |
| 2003 | 0    | 0    | 0    | 0    | 0    | 0    |
| 2004 | 0    | 0    | 0    | 0    | 0    | 0    |
| 2005 | 0    | 0    | 0    | 0    | 0    | 0    |
| 2006 | 0    | 0    | 0    | 0    | 0    | 0    |
| 2007 | 0    | 0    | 0    | 0    | 0    | 0    |
| 2008 | 0    | 0    | 0    | 0    | 0    | 0    |
| 2009 | 0    | 0    | 0    | 0    | 0    | 0    |
| 2010 | 0    | 0    | 0    | 0    | 0    | 0    |
| 2011 | 0    | 0    | 0    | 0    | 0    | 0    |
| 2012 | 0    | 0    | 0    | 0    | 0    | 0    |
| 2013 | 0    | 0    | 0    | 0    | 0    | 0    |
| 2014 | 0    | 0    | 0    | 0    | 0    | 0    |
| 2015 | 0    | 0    | 0    | 0    | 0    | 0    |
| 2016 | 0    | 0    | 0    | 0    | 0    | 0    |
| 2017 | 0    | 0    | 0    | 0    | 0    | 0    |
| 2018 | 0    | 0    | 0    | 0    | 0    | 0    |
| 2019 | 0    | 0    | 0    | 0    | 0    | 0    |
| 2020 | 250  | 0    | 0    | 0    | 0    | 0    |
| 2021 | 590  | 0    | 0    | 0    | 0    | 0    |
| 2022 | 900  | 0    | 0    | 0    | 0    | 0    |
| 2023 | 1215 | 0    | 0    | 0    | 0    | 0    |
| 2024 | 1540 | 0    | 0    | 0    | 0    | 0    |
| 2025 | 1833 | 250  | 250  | 250  | 250  | 250  |
| 2026 | 2117 | 584  | 575  | 575  | 575  | 575  |
| 2027 | 2397 | 922  | 903  | 903  | 903  | 903  |
| 2028 | 2696 | 1271 | 1247 | 1250 | 1250 | 1250 |
| 2029 | 2984 | 1602 | 1578 | 1581 | 1581 | 1581 |
| 2030 | 3266 | 1922 | 1892 | 1896 | 1896 | 1896 |
| 2031 | 3555 | 2233 | 2211 | 2212 | 2212 | 2212 |
| 2032 | 3844 | 2517 | 2502 | 2503 | 2503 | 2503 |
| 2033 | 4107 | 2797 | 2779 | 2787 | 2787 | 2787 |
| 2034 | 4385 | 3111 | 3106 | 3114 | 3114 | 3114 |
| 2035 | 4646 | 3405 | 3405 | 3412 | 3412 | 3412 |
| 2036 | 4937 | 3699 | 3691 | 3701 | 3701 | 3701 |
| 2037 | 5184 | 3973 | 3956 | 3975 | 3975 | 3975 |
| 2038 | 5405 | 4238 | 4217 | 4254 | 4254 | 4254 |
| 2039 | 5643 | 4508 | 4477 | 4521 | 4521 | 4521 |
| 2040 | 5883 | 4808 | 4787 | 4821 | 4821 | 4821 |
| 2041 | 6174 | 5099 | 5070 | 5104 | 5104 | 5104 |
| 2042 | 6490 | 5426 | 5377 | 5422 | 5422 | 5422 |
| 2043 | 6673 | 5690 | 5636 | 5663 | 5663 | 5663 |
| 2044 | 6717 | 5942 | 5887 | 5905 | 5905 | 5905 |
| 2045 | 6906 | 6178 | 6195 | 6156 | 6156 | 6156 |
| 2046 | 7039 | 6199 | 6267 | 6190 | 6190 | 6190 |
| 2047 | 7161 | 6209 | 6310 | 6395 | 6395 | 6395 |
| 2048 | 7204 | 6429 | 6542 | 6603 | 6603 | 6603 |
| 2049 | 7228 | 6626 | 6725 | 6805 | 6805 | 6805 |
| 2050 | 7240 | 6838 | 6928 | 6984 | 6984 | 6984 |
| 2051 | 7250 | 7004 | 7056 | 7092 | 7092 | 7092 |
| 2052 | 7250 | 7100 | 7123 | 7160 | 7160 | 7160 |
| 2053 | 7250 | 7165 | 7168 | 7204 | 7204 | 7204 |
| 2054 | 7250 | 7204 | 7207 | 7225 | 7225 | 7225 |
| 2055 | 7250 | 7225 | 7228 | 7237 | 7237 | 7237 |
| 2056 | 7250 | 7237 | 7240 | 7247 | 7247 | 7247 |
| 2057 | 7250 | 7247 | 7250 | 7249 | 7249 | 7249 |
| 2058 | 7250 | 7249 | 7250 | 7249 | 7249 | 7249 |
| 2059 | 7250 | 7249 | 7250 | 7249 | 7249 | 7249 |

|      | 157  | 158  | 159  | 160  | 161  | 162  |
|------|------|------|------|------|------|------|
| 2060 | 7250 | 7249 | 7250 | 7249 | 7249 | 7249 |
| 2061 | 7250 | 7249 | 7250 | 7249 | 7249 | 7249 |
| 2062 | 7250 | 7249 | 7250 | 7249 | 7249 | 7249 |
| 2063 | 7250 | 7249 | 7250 | 7249 | 7249 | 7249 |
| 2064 | 7250 | 7249 | 7250 | 7249 | 7249 | 7249 |
| 2065 | 7250 | 7249 | 7250 | 7249 | 7249 | 7249 |
| 2066 | 7250 | 7249 | 7250 | 7249 | 7249 | 7249 |
| 2067 | 7250 | 7249 | 7250 | 7249 | 7249 | 7249 |
| 2068 | 7250 | 7249 | 7250 | 7249 | 7249 | 7249 |
| 2069 | 7250 | 7249 | 7250 | 7249 | 7249 | 7249 |
| 2070 | 7250 | 7249 | 7250 | 7249 | 7249 | 7249 |
| 2071 | 7250 | 7249 | 7250 | 7249 | 7249 | 7249 |
| 2072 | 7250 | 7249 | 7250 | 7249 | 7249 | 7249 |
| 2073 | 7250 | 7249 | 7250 | 7249 | 7249 | 7249 |
| 2074 | 7250 | 7249 | 7250 | 7249 | 7249 | 7249 |
| 2075 | 7250 | 7249 | 7250 | 7249 | 7249 | 7249 |
| 2076 | 7250 | 7249 | 7250 | 7249 | 7249 | 7249 |
| 2077 | 7250 | 7249 | 7250 | 7249 | 7249 | 7249 |
| 2078 | 7250 | 7249 | 7250 | 7249 | 7249 | 7249 |
| 2079 | 7250 | 7249 | 7250 | 7249 | 7249 | 7249 |
| 2080 | 7250 | 7249 | 7250 | 7249 | 7249 | 7249 |
| 2081 | 7250 | 7249 | 7250 | 7249 | 7249 | 7249 |
| 2082 | 7250 | 7249 | 7250 | 7249 | 7249 | 7249 |
| 2083 | 7250 | 7249 | 7250 | 7249 | 7249 | 7249 |
| 2084 | 7250 | 7249 | 7250 | 7249 | 7249 | 7249 |
| 2085 | 7250 | 7249 | 7250 | 7249 | 7249 | 7249 |
| 2086 | 7250 | 7249 | 7250 | 7249 | 7249 | 7249 |
| 2087 | 7250 | 7249 | 7250 | 7249 | 7249 | 7249 |
| 2088 | 7250 | 7249 | 7250 | 7249 | 7249 | 7249 |
| 2089 | 7250 | 7249 | 7250 | 7249 | 7249 | 7249 |
| 2090 | 7250 | 7249 | 7250 | 7249 | 7249 | 7249 |

| Year | 1   | 2   | 3   | 4   | 5   | 6   | 7   | 8   | 9   | 10  | 11  | 12  | 13  |
|------|-----|-----|-----|-----|-----|-----|-----|-----|-----|-----|-----|-----|-----|
| 2002 |     |     |     |     |     |     |     |     |     |     |     |     |     |
| 2003 | 0   | 0   | 0   | 0   | 0   | 0   | 0   | 0   | 0   | 0   | 0   | 0   | 0   |
| 2004 | 0   | 0   | 0   | 0   | 0   | 0   | 0   | 0   | 0   | 0   | 0   | 0   | 0   |
| 2005 | 0   | 0   | 0   | 0   | 0   | 0   | 0   | 0   | 0   | 0   | 0   | 0   | 0   |
| 2006 | 0   | 0   | 0   | 0   | 0   | 0   | 0   | 0   | 0   | 0   | 0   | 0   | 0   |
| 2007 | 0   | 0   | 0   | 0   | 0   | 0   | 0   | 0   | 0   | 0   | 0   | 0   | 0   |
| 2008 | 0   | 0   | 0   | 0   | 0   | 0   | 0   | 0   | 0   | 0   | 0   | 0   | 0   |
| 2009 | 0   | 0   | 0   | 0   | 0   | 0   | 0   | 0   | 0   | 0   | 0   | 0   | 0   |
| 2010 | 0   | 0   | 0   | 0   | 0   | 0   | 0   | 0   | 0   | 0   | 0   | 0   | 0   |
| 2011 | 0   | 0   | 0   | 0   | 0   | 0   | 0   | 0   | 0   | 0   | 0   | 0   | 0   |
| 2012 | 0   | 0   | 0   | 0   | 0   | 0   | 0   | 0   | 0   | 0   | 0   | 0   | 0   |
| 2013 | 0   | 0   | 0   | 0   | 0   | 0   | 0   | 0   | 0   | 0   | 0   | 0   | 0   |
| 2014 | 0   | 0   | 0   | 0   | 0   | 0   | 0   | 0   | 0   | 0   | 0   | 0   | 0   |
| 2015 | 0   | 0   | 0   | 0   | 0   | 0   | 0   | 0   | 0   | 0   | 0   | 0   | 0   |
| 2016 | 0   | 0   | 0   | 0   | 0   | 0   | 0   | 0   | 0   | 0   | 0   | 0   | 0   |
| 2017 | 0   | 0   | 0   | 0   | 0   | 0   | 0   | 0   | 0   | 0   | 0   | 0   | 0   |
| 2018 | 0   | 0   | 0   | 0   | 0   | 0   | 0   | 0   | 0   | 0   | 0   | 0   | 0   |
| 2019 | 0   | 0   | 0   | 0   | 0   | 0   | 0   | 0   | 0   | 0   | 0   | 0   | 0   |
| 2020 | 0   | 0   | 0   | 224 | 0   | 0   | 0   | 0   | 0   | 0   | 0   | 0   | 79  |
| 2021 | 0   | 0   | 0   | 222 | 0   | 0   | 0   | 0   | 0   | 0   | 0   | 0   | 87  |
| 2022 | 0   | 0   | 0   | 224 | 0   | 0   | 0   | 0   | 0   | 0   | 0   | 0   | 142 |
| 2023 | 0   | 0   | 0   | 226 | 0   | 0   | 0   | 0   | 0   | 0   | 0   | 0   | 217 |
| 2024 | 0   | 0   | 0   | 221 | 0   | 0   | 0   | 0   | 0   | 0   | 0   | 0   | 288 |
| 2025 | 225 | 225 | 0   | 237 | 225 | 225 | 225 | 225 | 225 | 62  | 62  | 0   | 210 |
| 2026 | 220 | 220 | 0   | 225 | 220 | 220 | 220 | 220 | 220 | 93  | 99  | 0   | 265 |
| 2027 | 221 | 221 | 0   | 226 | 221 | 221 | 221 | 221 | 221 | 106 | 110 | 0   | 234 |
| 2028 | 224 | 224 | 0   | 225 | 224 | 224 | 224 | 224 | 224 | 183 | 186 | 0   | 283 |
| 2029 | 220 | 220 | 0   | 252 | 220 | 220 | 220 | 220 | 220 | 204 | 207 | 0   | 254 |
| 2030 | 222 | 222 | 225 | 249 | 222 | 222 | 222 | 222 | 222 | 239 | 250 | 58  | 258 |
| 2031 | 227 | 227 | 223 | 236 | 227 | 231 | 227 | 227 | 227 | 291 | 302 | 97  | 235 |
| 2032 | 225 | 225 | 220 | 264 | 225 | 246 | 225 | 219 | 225 | 251 | 270 | 124 | 245 |
| 2033 | 231 | 233 | 226 | 280 | 220 | 246 | 233 | 232 | 233 | 269 | 277 | 154 | 184 |
| 2034 | 232 | 232 | 224 | 229 | 228 | 240 | 232 | 202 | 232 | 245 | 247 | 194 | 193 |
| 2035 | 244 | 244 | 222 | 294 | 235 | 241 | 244 | 212 | 244 | 213 | 226 | 248 | 192 |
| 2036 | 275 | 276 | 235 | 240 | 250 | 236 | 276 | 212 | 276 | 245 | 280 | 292 | 146 |
| 2037 | 262 | 268 | 231 | 195 | 242 | 260 | 270 | 229 | 268 | 187 | 231 | 286 | 177 |
| 2038 | 287 | 293 | 231 | 225 | 303 | 272 | 295 | 258 | 293 | 159 | 181 | 282 | 165 |
| 2039 | 219 | 243 | 231 | 240 | 254 | 236 | 247 | 209 | 238 | 173 | 183 | 230 | 171 |
| 2040 | 277 | 294 | 247 | 229 | 296 | 281 | 294 | 250 | 288 | 214 | 231 | 247 | 131 |
| 2041 | 216 | 229 | 249 | 192 | 244 | 226 | 240 | 188 | 218 | 196 | 210 | 249 | 145 |
| 2042 | 241 | 296 | 284 | 114 | 321 | 295 | 302 | 295 | 290 | 218 | 223 | 285 | 129 |
| 2043 | 153 | 126 | 278 | 150 | 70  | 156 | 117 | 173 | 134 | 221 | 237 | 251 | 139 |
| 2044 | 138 | 183 | 235 | 100 | 168 | 163 | 143 | 189 | 168 | 171 | 185 | 251 | 100 |
| 2045 | 139 | 208 | 116 | 83  | 186 | 203 | 174 | 253 | 188 | 123 | 157 | 211 | 92  |
| 2046 | 105 | 175 | 189 | 68  | 166 | 145 | 161 | 186 | 170 | 147 | 168 | 200 | 75  |
| 2047 | 67  | 183 | 217 | 20  | 145 | 149 | 155 | 200 | 158 | 113 | 131 | 167 | 61  |
| 2048 | 40  | 149 | 180 | 9   | 109 | 105 | 96  | 125 | 96  | 82  | 105 | 212 | 71  |
| 2049 | 74  | 121 | 165 | 0   | 89  | 70  | 84  | 108 | 84  | 70  | 84  | 222 | 241 |
| 2050 | 102 | 145 | 156 | 10  | 119 | 127 | 120 | 160 | 120 | 186 | 227 | 193 | 120 |
| 2051 | 32  | 149 | 160 | 0   | 140 | 143 | 130 | 152 | 130 | 125 | 181 | 144 | 48  |
| 2052 | 0   | 135 | 126 | 0   | 101 | 65  | 58  | 80  | 58  | 126 | 191 | 166 | 63  |
| 2053 | 0   | 89  | 99  | 0   | 17  | 15  | 15  | 37  | 15  | 106 | 231 | 206 | 49  |
| 2054 | 0   | 56  | 143 | 0   | 0   | 0   | 0   | 15  | 0   | 71  | 206 | 164 | 54  |
| 2055 | 0   | 11  | 143 | 0   | 0   | 0   | 0   | 19  | 0   | 36  | 133 | 194 | 55  |
| 2056 | 0   | 0   | 175 | 0   | 0   | 0   | 0   | 7   | 0   | 17  | 73  | 159 | 59  |
| 2057 | 0   | 0   | 118 | 0   | 0   | 0   | 0   | 5   | 0   | 27  | 65  | 142 | 50  |
| 2058 | 0   | 0   | 67  | 0   | 0   | 0   | 0   | 2   | 0   | 19  | 35  | 90  | 51  |
| 2059 | 0   | 0   | 40  | 0   | 0   | 0   | 0   | 0   | 0   | 25  | 22  | 62  | 46  |

| Year | 1 | 2 | 3  | 4 | 5 | 6 | 7 | 8 | 9 | 10 | 11 | 12 | 13 |
|------|---|---|----|---|---|---|---|---|---|----|----|----|----|
| 2060 | 0 | 0 | 15 | 0 | 0 | 0 | 0 | 0 | 0 | 26 | 26 | 46 | 37 |
| 2061 | 0 | 0 | 0  | 0 | 0 | 0 | 0 | 0 | 0 | 29 | 26 | 18 | 50 |
| 2062 | 0 | 0 | 0  | 0 | 0 | 0 | 0 | 0 | 0 | 30 | 33 | 23 | 35 |
| 2063 | 0 | 0 | 0  | 0 | 0 | 0 | 0 | 0 | 0 | 31 | 34 | 10 | 26 |
| 2064 | 0 | 0 | 0  | 0 | 0 | 0 | 0 | 0 | 0 | 27 | 26 | 8  | 15 |
| 2065 | 0 | 0 | 0  | 0 | 0 | 0 | 0 | 0 | 0 | 7  | 7  | 0  | 0  |
| 2066 | 0 | 0 | 0  | 0 | 0 | 0 | 0 | 0 | 0 | 0  | 0  | 0  | 0  |
| 2067 | 0 | 0 | 0  | 0 | 0 | 0 | 0 | 0 | 0 | 0  | 0  | 0  | 0  |
| 2068 | 0 | 0 | 0  | 0 | 0 | 0 | 0 | 0 | 0 | 0  | 0  | 0  | 0  |
| 2069 | 0 | 0 | 0  | 0 | 0 | 0 | 0 | 0 | 0 | 0  | 0  | 0  | 0  |
| 2070 | 0 | 0 | 0  | 0 | 0 | 0 | 0 | 0 | 0 | 0  | 0  | 0  | 0  |
| 2071 | 0 | 0 | 0  | 0 | 0 | 0 | 0 | 0 | 0 | 0  | 0  | 0  | 0  |
| 2072 | 0 | 0 | 0  | 0 | 0 | 0 | 0 | 0 | 0 | 0  | 0  | 0  | 0  |
| 2073 | 0 | 0 | 0  | 0 | 0 | 0 | 0 | 0 | 0 | 0  | 0  | 0  | 0  |
| 2074 | 0 | 0 | 0  | 0 | 0 | 0 | 0 | 0 | 0 | 0  | 0  | 0  | 0  |
| 2075 | 0 | 0 | 0  | 0 | 0 | 0 | 0 | 0 | 0 | 0  | 0  | 0  | 0  |
| 2076 | 0 | 0 | 0  | 0 | 0 | 0 | 0 | 0 | 0 | 0  | 0  | 0  | 0  |
| 2077 | 0 | 0 | 0  | 0 | 0 | 0 | 0 | 0 | 0 | 0  | 0  | 0  | 0  |
| 2078 | 0 | 0 | 0  | 0 | 0 | 0 | 0 | 0 | 0 | 0  | 0  | 0  | 0  |
| 2079 | 0 | 0 | 0  | 0 | 0 | 0 | 0 | 0 | 0 | 0  | 0  | 0  | 0  |
| 2080 | 0 | 0 | 0  | 0 | 0 | 0 | 0 | 0 | 0 | 0  | 0  | 0  | 0  |
| 2081 | 0 | 0 | 0  | 0 | 0 | 0 | 0 | 0 | 0 | 0  | 0  | 0  | 0  |
| 2082 | 0 | 0 | 0  | 0 | 0 | 0 | 0 | 0 | 0 | 0  | 0  | 0  | 0  |
| 2083 | 0 | 0 | 0  | 0 | 0 | 0 | 0 | 0 | 0 | 0  | 0  | 0  | 0  |
| 2084 | 0 | 0 | 0  | 0 | 0 | 0 | 0 | 0 | 0 | 0  | 0  | 0  | 0  |
| 2085 | 0 | 0 | 0  | 0 | 0 | 0 | 0 | 0 | 0 | 0  | 0  | 0  | 0  |
| 2086 | 0 | 0 | 0  | 0 | 0 | 0 | 0 | 0 | 0 | 0  | 0  | 0  | 0  |
| 2087 | 0 | 0 | 0  | 0 | 0 | 0 | 0 | 0 | 0 | 0  | 0  | 0  | 0  |
| 2088 | 0 | 0 | 0  | 0 | 0 | 0 | 0 | 0 | 0 | 0  | 0  | 0  | 0  |
| 2089 | 0 | 0 | 0  | 0 | 0 | 0 | 0 | 0 | 0 | 0  | 0  | 0  | 0  |



| Year | 14  | 15  | 16  | 17  | 18  | 19  | 20  | 21  | 22  | 23  | 24  | 25  | 26  |
|------|-----|-----|-----|-----|-----|-----|-----|-----|-----|-----|-----|-----|-----|
| 2002 |     |     |     |     |     |     |     |     |     |     |     |     |     |
| 2003 | 0   | 0   | 0   | 0   | 0   | 0   | 0   | 0   | 0   | 0   | 0   | 0   | 0   |
| 2004 | 0   | 0   | 0   | 0   | 0   | 0   | 0   | 0   | 0   | 0   | 0   | 0   | 0   |
| 2005 | 0   | 0   | 0   | 0   | 0   | 0   | 0   | 0   | 0   | 0   | 0   | 0   | 0   |
| 2006 | 0   | 0   | 0   | 0   | 0   | 0   | 0   | 0   | 0   | 0   | 0   | 0   | 0   |
| 2007 | 0   | 0   | 0   | 0   | 0   | 0   | 0   | 0   | 0   | 0   | 0   | 0   | 0   |
| 2008 | 0   | 0   | 0   | 0   | 0   | 0   | 0   | 0   | 0   | 0   | 0   | 0   | 0   |
| 2009 | 0   | 0   | 0   | 0   | 0   | 0   | 0   | 0   | 0   | 0   | 0   | 0   | 0   |
| 2010 | 0   | 0   | 0   | 0   | 0   | 0   | 0   | 0   | 0   | 0   | 0   | 0   | 0   |
| 2011 | 0   | 0   | 0   | 0   | 0   | 0   | 0   | 0   | 0   | 0   | 0   | 0   | 0   |
| 2012 | 0   | 0   | 0   | 0   | 0   | 0   | 0   | 0   | 0   | 0   | 0   | 0   | 0   |
| 2013 | 0   | 0   | 0   | 0   | 0   | 0   | 0   | 0   | 0   | 0   | 0   | 0   | 0   |
| 2014 | 0   | 0   | 0   | 0   | 0   | 0   | 0   | 0   | 0   | 0   | 0   | 0   | 0   |
| 2015 | 0   | 0   | 0   | 0   | 0   | 0   | 0   | 0   | 0   | 0   | 0   | 0   | 0   |
| 2016 | 0   | 0   | 0   | 0   | 0   | 0   | 0   | 0   | 0   | 0   | 0   | 0   | 0   |
| 2017 | 0   | 0   | 0   | 0   | 0   | 0   | 0   | 0   | 0   | 0   | 0   | 0   | 0   |
| 2018 | 0   | 0   | 0   | 0   | 0   | 0   | 0   | 0   | 0   | 0   | 0   | 0   | 0   |
| 2019 | 0   | 0   | 0   | 0   | 0   | 0   | 0   | 0   | 0   | 0   | 0   | 0   | 0   |
| 2020 | 0   | 0   | 0   | 0   | 0   | 0   | 0   | 0   | 9   | 0   | 0   | 0   | 0   |
| 2021 | 0   | 0   | 0   | 0   | 0   | 0   | 0   | 0   | 17  | 0   | 0   | 0   | 0   |
| 2022 | 0   | 0   | 0   | 0   | 0   | 0   | 0   | 0   | 44  | 0   | 0   | 0   | 0   |
| 2023 | 0   | 0   | 0   | 0   | 0   | 0   | 0   | 0   | 72  | 0   | 0   | 0   | 0   |
| 2024 | 0   | 0   | 0   | 0   | 0   | 0   | 0   | 0   | 98  | 0   | 0   | 0   | 0   |
| 2025 | 56  | 153 | 215 | 4   | 62  | 15  | 15  | 0   | 122 | 11  | 55  | 56  | 1   |
| 2026 | 90  | 156 | 215 | 22  | 98  | 32  | 34  | 0   | 203 | 11  | 115 | 123 | 5   |
| 2027 | 109 | 216 | 225 | 12  | 106 | 46  | 51  | 0   | 223 | 17  | 122 | 183 | 7   |
| 2028 | 135 | 213 | 219 | 36  | 190 | 46  | 53  | 0   | 283 | 38  | 192 | 240 | 14  |
| 2029 | 160 | 207 | 231 | 69  | 211 | 98  | 102 | 0   | 243 | 57  | 240 | 271 | 45  |
| 2030 | 194 | 221 | 235 | 67  | 252 | 141 | 150 | 9   | 292 | 88  | 213 | 240 | 33  |
| 2031 | 271 | 224 | 215 | 96  | 300 | 162 | 170 | 40  | 254 | 131 | 260 | 304 | 31  |
| 2032 | 243 | 219 | 225 | 100 | 258 | 189 | 193 | 66  | 292 | 148 | 225 | 260 | 42  |
| 2033 | 319 | 226 | 216 | 180 | 269 | 223 | 227 | 82  | 252 | 164 | 209 | 230 | 66  |
| 2034 | 310 | 237 | 234 | 150 | 246 | 295 | 301 | 147 | 294 | 176 | 277 | 214 | 80  |
| 2035 | 271 | 201 | 236 | 151 | 231 | 302 | 309 | 142 | 267 | 184 | 222 | 264 | 87  |
| 2036 | 234 | 217 | 205 | 168 | 279 | 309 | 312 | 150 | 248 | 271 | 215 | 264 | 105 |
| 2037 | 181 | 236 | 181 | 208 | 210 | 279 | 297 | 201 | 250 | 365 | 231 | 261 | 100 |
| 2038 | 162 | 232 | 170 | 186 | 167 | 278 | 304 | 228 | 250 | 312 | 201 | 199 | 129 |
| 2039 | 175 | 203 | 178 | 214 | 184 | 242 | 282 | 303 | 246 | 339 | 231 | 232 | 173 |
| 2040 | 196 | 214 | 206 | 226 | 206 | 224 | 247 | 338 | 207 | 288 | 260 | 217 | 160 |
| 2041 | 195 | 205 | 216 | 258 | 202 | 234 | 246 | 319 | 258 | 288 | 244 | 235 | 197 |
| 2042 | 198 | 260 | 206 | 291 | 222 | 253 | 265 | 263 | 253 | 239 | 326 | 267 | 196 |
| 2043 | 172 | 211 | 200 | 312 | 225 | 254 | 285 | 268 | 254 | 270 | 249 | 214 | 255 |
| 2044 | 170 | 163 | 165 | 281 | 174 | 223 | 232 | 275 | 206 | 257 | 248 | 227 | 267 |
| 2045 | 180 | 192 | 157 | 288 | 148 | 270 | 276 | 280 | 226 | 265 | 251 | 185 | 271 |
| 2046 | 170 | 154 | 135 | 205 | 153 | 196 | 219 | 236 | 244 | 230 | 194 | 162 | 323 |
| 2047 | 121 | 224 | 139 | 193 | 136 | 226 | 251 | 201 | 190 | 341 | 221 | 147 | 404 |
| 2048 | 173 | 111 | 97  | 163 | 95  | 247 | 300 | 305 | 109 | 320 | 226 | 196 | 373 |
| 2049 | 160 | 150 | 66  | 229 | 74  | 185 | 242 | 302 | 37  | 173 | 210 | 155 | 342 |
| 2050 | 142 | 227 | 201 | 280 | 211 | 148 | 216 | 256 | 30  | 198 | 221 | 164 | 402 |
| 2051 | 220 | 210 | 179 | 248 | 178 | 150 | 254 | 168 | 35  | 215 | 157 | 157 | 330 |
| 2052 | 217 | 167 | 186 | 233 | 198 | 85  | 229 | 213 | 14  | 229 | 95  | 142 | 279 |
| 2053 | 182 | 137 | 157 | 240 | 172 | 54  | 171 | 208 | 17  | 183 | 43  | 84  | 294 |
| 2054 | 135 | 64  | 146 | 205 | 147 | 37  | 112 | 211 | 25  | 121 | 17  | 23  | 177 |
| 2055 | 70  | 23  | 55  | 125 | 72  | 13  | 63  | 192 | 19  | 74  | 15  | 0   | 158 |
| 2056 | 51  | 20  | 13  | 41  | 31  | 14  | 47  | 193 | 19  | 9   | 0   | 0   | 121 |
| 2057 | 41  | 10  | 0   | 39  | 30  | 17  | 25  | 170 | 30  | 55  | 0   | 0   | 119 |
| 2058 | 14  | 0   | 0   | 49  | 15  | 10  | 11  | 131 | 17  | 22  | 0   | 0   | 76  |
| 2059 | 39  | 0   | 0   | 41  | 31  | 14  | 14  | 63  | 26  | 17  | 0   | 0   | 67  |

| Year | 14 | 15 | 16 | 17 | 18 | 19 | 20 | 21 | 22 | 23 | 24 | 25 | 26 |
|------|----|----|----|----|----|----|----|----|----|----|----|----|----|
| 2060 | 20 | 0  | 0  | 41 | 25 | 8  | 9  | 36 | 7  | 10 | 0  | 0  | 98 |
| 2061 | 18 | 0  | 0  | 41 | 29 | 9  | 9  | 21 | 5  | 5  | 0  | 0  | 62 |
| 2062 | 20 | 0  | 0  | 32 | 27 | 15 | 16 | 8  | 0  | 11 | 0  | 0  | 60 |
| 2063 | 21 | 0  | 0  | 39 | 29 | 2  | 2  | 2  | 0  | 3  | 0  | 0  | 48 |
| 2064 | 29 | 0  | 0  | 18 | 24 | 0  | 0  | 6  | 0  | 11 | 0  | 0  | 39 |
| 2065 | 21 | 0  | 0  | 53 | 7  | 0  | 0  | 0  | 0  | 10 | 0  | 0  | 44 |
| 2066 | 19 | 0  | 0  | 28 | 0  | 0  | 0  | 0  | 0  | 7  | 0  | 0  | 22 |
| 2067 | 17 | 0  | 0  | 36 | 0  | 0  | 0  | 0  | 0  | 11 | 0  | 0  | 14 |
| 2068 | 8  | 0  | 0  | 29 | 0  | 0  | 0  | 0  | 0  | 0  | 0  | 0  | 18 |
| 2069 | 0  | 0  | 0  | 20 | 0  | 0  | 0  | 0  | 0  | 0  | 0  | 0  | 11 |
| 2070 | 0  | 0  | 0  | 25 | 0  | 0  | 0  | 0  | 0  | 0  | 0  | 0  | 10 |
| 2071 | 0  | 0  | 0  | 16 | 0  | 0  | 0  | 0  | 0  | 0  | 0  | 0  | 9  |
| 2072 | 0  | 0  | 0  | 33 | 0  | 0  | 0  | 0  | 0  | 0  | 0  | 0  | 14 |
| 2073 | 0  | 0  | 0  | 22 | 0  | 0  | 0  | 0  | 0  | 0  | 0  | 0  | 10 |
| 2074 | 0  | 0  | 0  | 27 | 0  | 0  | 0  | 0  | 0  | 0  | 0  | 0  | 9  |
| 2075 | 0  | 0  | 0  | 31 | 0  | 0  | 0  | 0  | 0  | 0  | 0  | 0  | 14 |
| 2076 | 0  | 0  | 0  | 22 | 0  | 0  | 0  | 0  | 0  | 0  | 0  | 0  | 3  |
| 2077 | 0  | 0  | 0  | 26 | 0  | 0  | 0  | 0  | 0  | 0  | 0  | 0  | 0  |
| 2078 | 0  | 0  | 0  | 10 | 0  | 0  | 0  | 0  | 0  | 0  | 0  | 0  | 0  |
| 2079 | 0  | 0  | 0  | 0  | 0  | 0  | 0  | 0  | 0  | 0  | 0  | 0  | 0  |
| 2080 | 0  | 0  | 0  | 0  | 0  | 0  | 0  | 0  | 0  | 0  | 0  | 0  | 0  |
| 2081 | 0  | 0  | 0  | 0  | 0  | 0  | 0  | 0  | 0  | 0  | 0  | 0  | 0  |
| 2082 | 0  | 0  | 0  | 0  | 0  | 0  | 0  | 0  | 0  | 0  | 0  | 0  | 0  |
| 2083 | 0  | 0  | 0  | 0  | 0  | 0  | 0  | 0  | 0  | 0  | 0  | 0  | 0  |
| 2084 | 0  | 0  | 0  | 0  | 0  | 0  | 0  | 0  | 0  | 0  | 0  | 0  | 0  |
| 2085 | 0  | 0  | 0  | 0  | 0  | 0  | 0  | 0  | 0  | 0  | 0  | 0  | 0  |
| 2086 | 0  | 0  | 0  | 0  | 0  | 0  | 0  | 0  | 0  | 0  | 0  | 0  | 0  |
| 2087 | 0  | 0  | 0  | 0  | 0  | 0  | 0  | 0  | 0  | 0  | 0  | 0  | 0  |
| 2088 | 0  | 0  | 0  | 0  | 0  | 0  | 0  | 0  | 0  | 0  | 0  | 0  | 0  |
| 2089 | 0  | 0  | 0  | 0  | 0  | 0  | 0  | 0  | 0  | 0  | 0  | 0  | 0  |

| Year | 27  | 28  | 29  | 30  | 31  | 32  | 33  | 34  | 35  | 36  | 37  | 38  | 39  |
|------|-----|-----|-----|-----|-----|-----|-----|-----|-----|-----|-----|-----|-----|
| 2002 |     |     |     |     |     |     |     |     |     |     |     |     |     |
| 2003 | 0   | 0   | 0   | 0   | 0   | 0   | 0   | 0   | 0   | 0   | 0   | 0   | 0   |
| 2004 | 0   | 0   | 0   | 0   | 0   | 0   | 0   | 0   | 0   | 0   | 0   | 0   | 0   |
| 2005 | 0   | 0   | 0   | 0   | 0   | 0   | 0   | 0   | 0   | 0   | 0   | 0   | 0   |
| 2006 | 0   | 0   | 0   | 0   | 0   | 0   | 0   | 0   | 0   | 0   | 0   | 0   | 0   |
| 2007 | 0   | 0   | 0   | 0   | 0   | 0   | 0   | 0   | 0   | 0   | 0   | 0   | 0   |
| 2008 | 0   | 0   | 0   | 0   | 0   | 0   | 0   | 0   | 0   | 0   | 0   | 0   | 0   |
| 2009 | 0   | 0   | 0   | 0   | 0   | 0   | 0   | 0   | 0   | 0   | 0   | 0   | 0   |
| 2010 | 0   | 0   | 0   | 0   | 0   | 0   | 0   | 0   | 0   | 0   | 0   | 0   | 0   |
| 2011 | 0   | 0   | 0   | 0   | 0   | 0   | 0   | 0   | 0   | 0   | 0   | 0   | 0   |
| 2012 | 0   | 0   | 0   | 0   | 0   | 0   | 0   | 0   | 0   | 0   | 0   | 0   | 0   |
| 2013 | 0   | 0   | 0   | 0   | 0   | 0   | 0   | 0   | 0   | 0   | 0   | 0   | 0   |
| 2014 | 0   | 0   | 0   | 0   | 0   | 0   | 0   | 0   | 0   | 0   | 0   | 0   | 0   |
| 2015 | 0   | 0   | 0   | 0   | 0   | 0   | 0   | 0   | 0   | 0   | 0   | 0   | 0   |
| 2016 | 0   | 0   | 0   | 0   | 0   | 0   | 0   | 0   | 0   | 0   | 0   | 0   | 0   |
| 2017 | 0   | 0   | 0   | 0   | 0   | 0   | 0   | 0   | 0   | 0   | 0   | 0   | 0   |
| 2018 | 0   | 0   | 0   | 0   | 0   | 0   | 0   | 0   | 0   | 0   | 0   | 0   | 0   |
| 2019 | 0   | 0   | 0   | 0   | 0   | 0   | 0   | 0   | 0   | 0   | 0   | 0   | 0   |
| 2020 | 0   | 0   | 0   | 0   | 224 | 0   | 0   | 0   | 0   | 0   | 0   | 0   | 0   |
| 2021 | 0   | 0   | 0   | 0   | 222 | 0   | 0   | 0   | 0   | 0   | 0   | 0   | 0   |
| 2022 | 0   | 0   | 0   | 0   | 224 | 0   | 0   | 0   | 0   | 0   | 0   | 0   | 0   |
| 2023 | 0   | 0   | 0   | 0   | 226 | 0   | 0   | 0   | 0   | 0   | 0   | 0   | 0   |
| 2024 | 0   | 0   | 0   | 0   | 221 | 0   | 0   | 0   | 0   | 0   | 0   | 0   | 0   |
| 2025 | 15  | 225 | 225 | 0   | 237 | 225 | 225 | 225 | 225 | 225 | 62  | 62  | 0   |
| 2026 | 32  | 220 | 220 | 0   | 225 | 220 | 220 | 220 | 220 | 220 | 92  | 98  | 0   |
| 2027 | 48  | 221 | 221 | 0   | 226 | 221 | 221 | 221 | 221 | 221 | 106 | 110 | 0   |
| 2028 | 53  | 224 | 224 | 0   | 225 | 224 | 224 | 224 | 224 | 224 | 182 | 185 | 0   |
| 2029 | 105 | 220 | 220 | 0   | 252 | 220 | 220 | 220 | 220 | 220 | 200 | 198 | 0   |
| 2030 | 146 | 222 | 222 | 225 | 247 | 222 | 222 | 222 | 222 | 222 | 239 | 240 | 58  |
| 2031 | 168 | 227 | 227 | 223 | 233 | 227 | 231 | 227 | 227 | 227 | 297 | 301 | 97  |
| 2032 | 194 | 225 | 225 | 220 | 263 | 225 | 245 | 225 | 219 | 225 | 244 | 263 | 119 |
| 2033 | 223 | 231 | 233 | 226 | 278 | 220 | 241 | 233 | 232 | 233 | 264 | 279 | 148 |
| 2034 | 297 | 232 | 232 | 224 | 241 | 228 | 232 | 232 | 202 | 232 | 244 | 254 | 188 |
| 2035 | 305 | 244 | 244 | 222 | 290 | 235 | 240 | 244 | 212 | 244 | 213 | 229 | 236 |
| 2036 | 319 | 275 | 276 | 235 | 240 | 250 | 225 | 276 | 212 | 276 | 250 | 271 | 281 |
| 2037 | 296 | 256 | 266 | 231 | 196 | 242 | 253 | 264 | 229 | 262 | 204 | 228 | 278 |
| 2038 | 273 | 288 | 289 | 231 | 233 | 303 | 239 | 290 | 251 | 287 | 171 | 184 | 280 |
| 2039 | 265 | 224 | 238 | 231 | 235 | 254 | 253 | 244 | 217 | 240 | 179 | 202 | 224 |
| 2040 | 245 | 278 | 301 | 247 | 228 | 296 | 271 | 296 | 251 | 294 | 213 | 235 | 235 |
| 2041 | 248 | 214 | 216 | 249 | 183 | 237 | 255 | 239 | 177 | 211 | 190 | 210 | 247 |
| 2042 | 257 | 235 | 276 | 278 | 94  | 331 | 263 | 306 | 304 | 296 | 205 | 222 | 278 |
| 2043 | 277 | 180 | 164 | 282 | 108 | 90  | 289 | 130 | 177 | 145 | 210 | 242 | 253 |
| 2044 | 234 | 72  | 162 | 219 | 108 | 143 | 131 | 114 | 162 | 133 | 161 | 200 | 282 |
| 2045 | 287 | 87  | 189 | 148 | 87  | 150 | 166 | 145 | 225 | 159 | 137 | 167 | 227 |
| 2046 | 215 | 96  | 173 | 170 | 75  | 148 | 171 | 137 | 162 | 145 | 153 | 176 | 216 |
| 2047 | 239 | 86  | 169 | 175 | 40  | 124 | 126 | 140 | 185 | 144 | 113 | 132 | 165 |
| 2048 | 291 | 64  | 153 | 157 | 19  | 114 | 107 | 107 | 138 | 107 | 91  | 112 | 203 |
| 2049 | 227 | 55  | 124 | 156 | 11  | 97  | 92  | 99  | 123 | 99  | 58  | 79  | 219 |
| 2050 | 211 | 61  | 146 | 138 | 11  | 104 | 98  | 88  | 124 | 88  | 127 | 223 | 186 |
| 2051 | 213 | 56  | 140 | 149 | 1   | 103 | 79  | 99  | 122 | 99  | 103 | 167 | 152 |
| 2052 | 162 | 40  | 123 | 133 | 2   | 96  | 59  | 76  | 98  | 76  | 109 | 205 | 167 |
| 2053 | 104 | 29  | 89  | 106 | 1   | 55  | 39  | 55  | 75  | 55  | 112 | 209 | 181 |
| 2054 | 61  | 16  | 55  | 128 | 0   | 34  | 27  | 35  | 50  | 35  | 105 | 194 | 158 |
| 2055 | 11  | 12  | 49  | 132 | 0   | 25  | 11  | 28  | 43  | 28  | 63  | 129 | 166 |
| 2056 | 13  | 2   | 17  | 128 | 0   | 8   | 4   | 4   | 11  | 4   | 37  | 73  | 162 |
| 2057 | 17  | 2   | 6   | 121 | 0   | 2   | 4   | 5   | 10  | 5   | 45  | 65  | 152 |
| 2058 | 9   | 0   | 6   | 88  | 0   | 5   | 0   | 0   | 3   | 0   | 27  | 42  | 97  |
| 2059 | 14  | 1   | 3   | 71  | 0   | 1   | 0   | 0   | 0   | 0   | 29  | 31  | 66  |

| Year | 27 | 28 | 29 | 30 | 31 | 32 | 33 | 34 | 35 | 36 | 37 | 38 | 39 |
|------|----|----|----|----|----|----|----|----|----|----|----|----|----|
| 2060 | 9  | 0  | 0  | 56 | 0  | 0  | 0  | 0  | 0  | 0  | 20 | 22 | 40 |
| 2061 | 9  | 0  | 0  | 40 | 0  | 0  | 0  | 0  | 0  | 0  | 26 | 29 | 29 |
| 2062 | 17 | 0  | 0  | 19 | 0  | 0  | 0  | 0  | 0  | 0  | 27 | 29 | 39 |
| 2063 | 2  | 0  | 0  | 4  | 0  | 0  | 0  | 0  | 0  | 0  | 29 | 32 | 32 |
| 2064 | 0  | 0  | 0  | 2  | 0  | 0  | 0  | 0  | 0  | 0  | 22 | 24 | 15 |
| 2065 | 0  | 0  | 0  | 3  | 0  | 0  | 0  | 0  | 0  | 0  | 5  | 7  | 0  |
| 2066 | 0  | 0  | 0  | 1  | 0  | 0  | 0  | 0  | 0  | 0  | 0  | 0  | 0  |
| 2067 | 0  | 0  | 0  | 0  | 0  | 0  | 0  | 0  | 0  | 0  | 0  | 0  | 0  |
| 2068 | 0  | 0  | 0  | 0  | 0  | 0  | 0  | 0  | 0  | 0  | 0  | 0  | 0  |
| 2069 | 0  | 0  | 0  | 0  | 0  | 0  | 0  | 0  | 0  | 0  | 0  | 0  | 0  |
| 2070 | 0  | 0  | 0  | 0  | 0  | 0  | 0  | 0  | 0  | 0  | 0  | 0  | 0  |
| 2071 | 0  | 0  | 0  | 0  | 0  | 0  | 0  | 0  | 0  | 0  | 0  | 0  | 0  |
| 2072 | 0  | 0  | 0  | 0  | 0  | 0  | 0  | 0  | 0  | 0  | 0  | 0  | 0  |
| 2073 | 0  | 0  | 0  | 0  | 0  | 0  | 0  | 0  | 0  | 0  | 0  | 0  | 0  |
| 2074 | 0  | 0  | 0  | 0  | 0  | 0  | 0  | 0  | 0  | 0  | 0  | 0  | 0  |
| 2075 | 0  | 0  | 0  | 0  | 0  | 0  | 0  | 0  | 0  | 0  | 0  | 0  | 0  |
| 2076 | 0  | 0  | 0  | 0  | 0  | 0  | 0  | 0  | 0  | 0  | 0  | 0  | 0  |
| 2077 | 0  | 0  | 0  | 0  | 0  | 0  | 0  | 0  | 0  | 0  | 0  | 0  | 0  |
| 2078 | 0  | 0  | 0  | 0  | 0  | 0  | 0  | 0  | 0  | 0  | 0  | 0  | 0  |
| 2079 | 0  | 0  | 0  | 0  | 0  | 0  | 0  | 0  | 0  | 0  | 0  | 0  | 0  |
| 2080 | 0  | 0  | 0  | 0  | 0  | 0  | 0  | 0  | 0  | 0  | 0  | 0  | 0  |
| 2081 | 0  | 0  | 0  | 0  | 0  | 0  | 0  | 0  | 0  | 0  | 0  | 0  | 0  |
| 2082 | 0  | 0  | 0  | 0  | 0  | 0  | 0  | 0  | 0  | 0  | 0  | 0  | 0  |
| 2083 | 0  | 0  | 0  | 0  | 0  | 0  | 0  | 0  | 0  | 0  | 0  | 0  | 0  |
| 2084 | 0  | 0  | 0  | 0  | 0  | 0  | 0  | 0  | 0  | 0  | 0  | 0  | 0  |
| 2085 | 0  | 0  | 0  | 0  | 0  | 0  | 0  | 0  | 0  | 0  | 0  | 0  | 0  |
| 2086 | 0  | 0  | 0  | 0  | 0  | 0  | 0  | 0  | 0  | 0  | 0  | 0  | 0  |
| 2087 | 0  | 0  | 0  | 0  | 0  | 0  | 0  | 0  | 0  | 0  | 0  | 0  | 0  |
| 2088 | 0  | 0  | 0  | 0  | 0  | 0  | 0  | 0  | 0  | 0  | 0  | 0  | 0  |
| 2089 | 0  | 0  | 0  | 0  | 0  | 0  | 0  | 0  | 0  | 0  | 0  | 0  | 0  |

| Year | 40  | 41  | 42  | 43  | 44  | 45  | 46  | 47  | 48  | 49  | 50  | 51  | 52  |
|------|-----|-----|-----|-----|-----|-----|-----|-----|-----|-----|-----|-----|-----|
| 2002 |     |     |     |     |     |     |     |     |     |     |     |     |     |
| 2003 | 0   | 0   | 0   | 0   | 0   | 0   | 0   | 0   | 0   | 0   | 0   | 0   | 0   |
| 2004 | 0   | 0   | 0   | 0   | 0   | 0   | 0   | 0   | 0   | 0   | 0   | 0   | 0   |
| 2005 | 0   | 0   | 0   | 0   | 0   | 0   | 0   | 0   | 0   | 0   | 0   | 0   | 0   |
| 2006 | 0   | 0   | 0   | 0   | 0   | 0   | 0   | 0   | 0   | 0   | 0   | 0   | 0   |
| 2007 | 0   | 0   | 0   | 0   | 0   | 0   | 0   | 0   | 0   | 0   | 0   | 0   | 0   |
| 2008 | 0   | 0   | 0   | 0   | 0   | 0   | 0   | 0   | 0   | 0   | 0   | 0   | 0   |
| 2009 | 0   | 0   | 0   | 0   | 0   | 0   | 0   | 0   | 0   | 0   | 0   | 0   | 0   |
| 2010 | 0   | 0   | 0   | 0   | 0   | 0   | 0   | 0   | 0   | 0   | 0   | 0   | 0   |
| 2011 | 0   | 0   | 0   | 0   | 0   | 0   | 0   | 0   | 0   | 0   | 0   | 0   | 0   |
| 2012 | 0   | 0   | 0   | 0   | 0   | 0   | 0   | 0   | 0   | 0   | 0   | 0   | 0   |
| 2013 | 0   | 0   | 0   | 0   | 0   | 0   | 0   | 0   | 0   | 0   | 0   | 0   | 0   |
| 2014 | 0   | 0   | 0   | 0   | 0   | 0   | 0   | 0   | 0   | 0   | 0   | 0   | 0   |
| 2015 | 0   | 0   | 0   | 0   | 0   | 0   | 0   | 0   | 0   | 0   | 0   | 0   | 0   |
| 2016 | 0   | 0   | 0   | 0   | 0   | 0   | 0   | 0   | 0   | 0   | 0   | 0   | 0   |
| 2017 | 0   | 0   | 0   | 0   | 0   | 0   | 0   | 0   | 0   | 0   | 0   | 0   | 0   |
| 2018 | 0   | 0   | 0   | 0   | 0   | 0   | 0   | 0   | 0   | 0   | 0   | 0   | 0   |
| 2019 | 0   | 0   | 0   | 0   | 0   | 0   | 0   | 0   | 0   | 0   | 0   | 0   | 0   |
| 2020 | 79  | 0   | 0   | 0   | 0   | 0   | 0   | 0   | 0   | 9   | 0   | 0   | 0   |
| 2021 | 87  | 0   | 0   | 0   | 0   | 0   | 0   | 0   | 0   | 17  | 0   | 0   | 0   |
| 2022 | 142 | 0   | 0   | 0   | 0   | 0   | 0   | 0   | 0   | 44  | 0   | 0   | 0   |
| 2023 | 217 | 0   | 0   | 0   | 0   | 0   | 0   | 0   | 0   | 72  | 0   | 0   | 0   |
| 2024 | 280 | 0   | 0   | 0   | 0   | 0   | 0   | 0   | 0   | 96  | 0   | 0   | 0   |
| 2025 | 210 | 56  | 153 | 215 | 4   | 62  | 15  | 15  | 0   | 122 | 11  | 55  | 56  |
| 2026 | 268 | 90  | 151 | 213 | 21  | 96  | 27  | 30  | 0   | 195 | 8   | 109 | 117 |
| 2027 | 234 | 105 | 209 | 225 | 12  | 106 | 46  | 50  | 0   | 223 | 17  | 117 | 181 |
| 2028 | 282 | 131 | 205 | 217 | 37  | 187 | 48  | 53  | 0   | 282 | 41  | 190 | 239 |
| 2029 | 256 | 152 | 204 | 223 | 60  | 203 | 93  | 97  | 0   | 241 | 56  | 232 | 260 |
| 2030 | 253 | 193 | 209 | 223 | 66  | 242 | 141 | 147 | 9   | 292 | 87  | 213 | 233 |
| 2031 | 236 | 277 | 225 | 211 | 99  | 300 | 159 | 163 | 40  | 255 | 127 | 258 | 303 |
| 2032 | 250 | 236 | 220 | 224 | 96  | 253 | 186 | 190 | 59  | 292 | 146 | 231 | 262 |
| 2033 | 191 | 312 | 227 | 218 | 172 | 268 | 217 | 226 | 78  | 243 | 162 | 201 | 229 |
| 2034 | 196 | 318 | 235 | 241 | 149 | 247 | 298 | 312 | 143 | 295 | 176 | 276 | 212 |
| 2035 | 197 | 289 | 206 | 242 | 147 | 240 | 294 | 302 | 146 | 266 | 188 | 210 | 265 |
| 2036 | 158 | 227 | 235 | 211 | 175 | 285 | 306 | 303 | 148 | 256 | 261 | 208 | 241 |
| 2037 | 176 | 198 | 233 | 188 | 210 | 219 | 272 | 281 | 199 | 260 | 360 | 228 | 254 |
| 2038 | 177 | 157 | 241 | 185 | 194 | 192 | 282 | 300 | 230 | 246 | 314 | 220 | 216 |
| 2039 | 150 | 180 | 196 | 190 | 230 | 203 | 242 | 280 | 297 | 243 | 332 | 234 | 227 |
| 2040 | 137 | 204 | 224 | 196 | 244 | 199 | 231 | 246 | 321 | 216 | 300 | 270 | 216 |
| 2041 | 195 | 206 | 211 | 218 | 253 | 189 | 246 | 252 | 302 | 266 | 299 | 247 | 244 |
| 2042 | 131 | 205 | 274 | 200 | 281 | 217 | 259 | 268 | 243 | 258 | 244 | 326 | 267 |
| 2043 | 138 | 171 | 228 | 199 | 323 | 221 | 266 | 286 | 259 | 261 | 264 | 257 | 202 |
| 2044 | 79  | 176 | 176 | 162 | 275 | 172 | 222 | 251 | 266 | 193 | 249 | 275 | 238 |
| 2045 | 105 | 192 | 181 | 159 | 282 | 164 | 277 | 291 | 283 | 197 | 265 | 222 | 206 |
| 2046 | 103 | 173 | 140 | 141 | 226 | 161 | 207 | 219 | 264 | 197 | 226 | 209 | 169 |
| 2047 | 69  | 104 | 243 | 148 | 202 | 136 | 187 | 270 | 228 | 210 | 310 | 203 | 130 |
| 2048 | 89  | 160 | 147 | 99  | 184 | 96  | 218 | 302 | 298 | 139 | 326 | 188 | 181 |
| 2049 | 157 | 174 | 202 | 78  | 221 | 85  | 171 | 252 | 288 | 59  | 192 | 173 | 157 |
| 2050 | 125 | 183 | 157 | 179 | 257 | 186 | 121 | 217 | 252 | 35  | 176 | 182 | 125 |
| 2051 | 83  | 155 | 157 | 154 | 220 | 158 | 140 | 232 | 193 | 39  | 193 | 153 | 129 |
| 2052 | 70  | 174 | 152 | 161 | 211 | 179 | 101 | 208 | 191 | 16  | 216 | 135 | 143 |
| 2053 | 55  | 170 | 107 | 139 | 222 | 160 | 87  | 183 | 205 | 20  | 197 | 66  | 103 |
| 2054 | 50  | 134 | 59  | 141 | 201 | 136 | 62  | 114 | 201 | 25  | 121 | 47  | 48  |
| 2055 | 51  | 71  | 36  | 61  | 130 | 74  | 31  | 61  | 167 | 18  | 91  | 33  | 27  |
| 2056 | 46  | 74  | 27  | 37  | 67  | 54  | 29  | 47  | 170 | 20  | 36  | 7   | 18  |
| 2057 | 42  | 57  | 9   | 18  | 64  | 50  | 19  | 39  | 171 | 27  | 70  | 6   | 7   |
| 2058 | 45  | 23  | 4   | 5   | 52  | 25  | 14  | 16  | 142 | 15  | 33  | 0   | 0   |
| 2059 | 36  | 39  | 0   | 0   | 48  | 29  | 12  | 12  | 75  | 25  | 15  | 1   | 4   |

| Year | 40 | 41 | 42 | 43 | 44 | 45 | 46 | 47 | 48 | 49 | 50 | 51 | 52 |
|------|----|----|----|----|----|----|----|----|----|----|----|----|----|
| 2060 | 31 | 22 | 0  | 0  | 35 | 24 | 6  | 5  | 40 | 4  | 19 | 0  | 0  |
| 2061 | 35 | 20 | 0  | 0  | 42 | 24 | 9  | 9  | 28 | 5  | 4  | 0  | 0  |
| 2062 | 32 | 18 | 0  | 0  | 33 | 26 | 14 | 13 | 28 | 0  | 10 | 0  | 0  |
| 2063 | 14 | 23 | 0  | 0  | 31 | 27 | 1  | 2  | 25 | 0  | 2  | 0  | 0  |
| 2064 | 3  | 20 | 0  | 0  | 28 | 22 | 0  | 0  | 20 | 0  | 9  | 0  | 0  |
| 2065 | 0  | 19 | 0  | 0  | 54 | 7  | 0  | 0  | 3  | 0  | 8  | 0  | 0  |
| 2066 | 0  | 17 | 0  | 0  | 25 | 0  | 0  | 0  | 0  | 0  | 7  | 0  | 0  |
| 2067 | 0  | 14 | 0  | 0  | 30 | 0  | 0  | 0  | 2  | 0  | 8  | 0  | 0  |
| 2068 | 0  | 4  | 0  | 0  | 26 | 0  | 0  | 0  | 0  | 0  | 0  | 0  | 0  |
| 2069 | 0  | 0  | 0  | 0  | 20 | 0  | 0  | 0  | 0  | 0  | 0  | 0  | 0  |
| 2070 | 0  | 0  | 0  | 0  | 27 | 0  | 0  | 0  | 0  | 0  | 0  | 0  | 0  |
| 2071 | 0  | 0  | 0  | 0  | 21 | 0  | 0  | 0  | 0  | 0  | 0  | 0  | 0  |
| 2072 | 0  | 0  | 0  | 0  | 28 | 0  | 0  | 0  | 0  | 0  | 0  | 0  | 0  |
| 2073 | 0  | 0  | 0  | 0  | 24 | 0  | 0  | 0  | 0  | 0  | 0  | 0  | 0  |
| 2074 | 0  | 0  | 0  | 0  | 22 | 0  | 0  | 0  | 0  | 0  | 0  | 0  | 0  |
| 2075 | 0  | 0  | 0  | 0  | 27 | 0  | 0  | 0  | 0  | 0  | 0  | 0  | 0  |
| 2076 | 0  | 0  | 0  | 0  | 22 | 0  | 0  | 0  | 0  | 0  | 0  | 0  | 0  |
| 2077 | 0  | 0  | 0  | 0  | 24 | 0  | 0  | 0  | 0  | 0  | 0  | 0  | 0  |
| 2078 | 0  | 0  | 0  | 0  | 10 | 0  | 0  | 0  | 0  | 0  | 0  | 0  | 0  |
| 2079 | 0  | 0  | 0  | 0  | 0  | 0  | 0  | 0  | 0  | 0  | 0  | 0  | 0  |
| 2080 | 0  | 0  | 0  | 0  | 0  | 0  | 0  | 0  | 0  | 0  | 0  | 0  | 0  |
| 2081 | 0  | 0  | 0  | 0  | 0  | 0  | 0  | 0  | 0  | 0  | 0  | 0  | 0  |
| 2082 | 0  | 0  | 0  | 0  | 0  | 0  | 0  | 0  | 0  | 0  | 0  | 0  | 0  |
| 2083 | 0  | 0  | 0  | 0  | 0  | 0  | 0  | 0  | 0  | 0  | 0  | 0  | 0  |
| 2084 | 0  | 0  | 0  | 0  | 0  | 0  | 0  | 0  | 0  | 0  | 0  | 0  | 0  |
| 2085 | 0  | 0  | 0  | 0  | 0  | 0  | 0  | 0  | 0  | 0  | 0  | 0  | 0  |
| 2086 | 0  | 0  | 0  | 0  | 0  | 0  | 0  | 0  | 0  | 0  | 0  | 0  | 0  |
| 2087 | 0  | 0  | 0  | 0  | 0  | 0  | 0  | 0  | 0  | 0  | 0  | 0  | 0  |
| 2088 | 0  | 0  | 0  | 0  | 0  | 0  | 0  | 0  | 0  | 0  | 0  | 0  | 0  |
| 2089 | 0  | 0  | 0  | 0  | 0  | 0  | 0  | 0  | 0  | 0  | 0  | 0  | 0  |

| Year | 53  | 54  | 55  | 56  | 57  | 58  | 59  | 60  | 61  | 62  | 63  | 64  | 65  |
|------|-----|-----|-----|-----|-----|-----|-----|-----|-----|-----|-----|-----|-----|
| 2002 |     |     |     |     |     |     |     |     |     |     |     |     |     |
| 2003 | 0   | 0   | 0   | 0   | 0   | 0   | 0   | 0   | 0   | 0   | 0   | 0   | 0   |
| 2004 | 0   | 0   | 0   | 0   | 0   | 0   | 0   | 0   | 0   | 0   | 0   | 0   | 0   |
| 2005 | 0   | 0   | 0   | 0   | 0   | 0   | 0   | 0   | 0   | 0   | 0   | 0   | 0   |
| 2006 | 0   | 0   | 0   | 0   | 0   | 0   | 0   | 0   | 0   | 0   | 0   | 0   | 0   |
| 2007 | 0   | 0   | 0   | 0   | 0   | 0   | 0   | 0   | 0   | 0   | 0   | 0   | 0   |
| 2008 | 0   | 0   | 0   | 0   | 0   | 0   | 0   | 0   | 0   | 0   | 0   | 0   | 0   |
| 2009 | 0   | 0   | 0   | 0   | 0   | 0   | 0   | 0   | 0   | 0   | 0   | 0   | 0   |
| 2010 | 0   | 0   | 0   | 0   | 0   | 0   | 0   | 0   | 0   | 0   | 0   | 0   | 0   |
| 2011 | 0   | 0   | 0   | 0   | 0   | 0   | 0   | 0   | 0   | 0   | 0   | 0   | 0   |
| 2012 | 0   | 0   | 0   | 0   | 0   | 0   | 0   | 0   | 0   | 0   | 0   | 0   | 0   |
| 2013 | 0   | 0   | 0   | 0   | 0   | 0   | 0   | 0   | 0   | 0   | 0   | 0   | 0   |
| 2014 | 0   | 0   | 0   | 0   | 0   | 0   | 0   | 0   | 0   | 0   | 0   | 0   | 0   |
| 2015 | 0   | 0   | 0   | 0   | 0   | 0   | 0   | 0   | 0   | 0   | 0   | 0   | 0   |
| 2016 | 0   | 0   | 0   | 0   | 0   | 0   | 0   | 0   | 0   | 0   | 0   | 0   | 0   |
| 2017 | 0   | 0   | 0   | 0   | 0   | 0   | 0   | 0   | 0   | 0   | 0   | 0   | 0   |
| 2018 | 0   | 0   | 0   | 0   | 0   | 0   | 0   | 0   | 0   | 0   | 0   | 0   | 0   |
| 2019 | 0   | 0   | 0   | 0   | 0   | 0   | 0   | 0   | 0   | 0   | 0   | 0   | 0   |
| 2020 | 0   | 0   | 0   | 0   | 0   | 224 | 0   | 0   | 0   | 0   | 0   | 0   | 0   |
| 2021 | 0   | 0   | 0   | 0   | 0   | 240 | 0   | 0   | 0   | 0   | 0   | 0   | 0   |
| 2022 | 0   | 0   | 0   | 0   | 0   | 262 | 0   | 0   | 0   | 0   | 0   | 0   | 0   |
| 2023 | 0   | 0   | 0   | 0   | 0   | 213 | 0   | 0   | 0   | 0   | 0   | 0   | 0   |
| 2024 | 0   | 0   | 0   | 0   | 0   | 226 | 0   | 0   | 0   | 0   | 0   | 0   | 0   |
| 2025 | 1   | 15  | 225 | 225 | 0   | 231 | 225 | 225 | 225 | 225 | 225 | 62  | 62  |
| 2026 | 1   | 27  | 222 | 231 | 0   | 260 | 231 | 231 | 231 | 231 | 231 | 148 | 202 |
| 2027 | 7   | 48  | 260 | 275 | 0   | 233 | 271 | 271 | 271 | 271 | 271 | 161 | 203 |
| 2028 | 18  | 52  | 220 | 244 | 0   | 205 | 246 | 246 | 246 | 246 | 246 | 223 | 268 |
| 2029 | 38  | 97  | 210 | 269 | 0   | 224 | 253 | 253 | 253 | 253 | 253 | 193 | 242 |
| 2030 | 34  | 147 | 199 | 270 | 225 | 248 | 253 | 253 | 253 | 253 | 253 | 230 | 271 |
| 2031 | 31  | 163 | 202 | 259 | 239 | 248 | 234 | 234 | 234 | 234 | 234 | 281 | 314 |
| 2032 | 43  | 187 | 194 | 244 | 260 | 268 | 219 | 219 | 219 | 219 | 219 | 224 | 259 |
| 2033 | 64  | 218 | 212 | 266 | 290 | 269 | 223 | 223 | 223 | 222 | 223 | 248 | 281 |
| 2034 | 73  | 296 | 209 | 248 | 275 | 259 | 227 | 227 | 227 | 222 | 227 | 277 | 305 |
| 2035 | 83  | 301 | 222 | 230 | 323 | 260 | 238 | 238 | 238 | 229 | 238 | 268 | 275 |
| 2036 | 105 | 310 | 256 | 269 | 302 | 323 | 269 | 262 | 269 | 258 | 269 | 263 | 285 |
| 2037 | 96  | 276 | 262 | 253 | 264 | 225 | 216 | 251 | 217 | 201 | 217 | 236 | 232 |
| 2038 | 128 | 291 | 229 | 275 | 224 | 209 | 268 | 302 | 268 | 226 | 268 | 192 | 205 |
| 2039 | 168 | 274 | 264 | 273 | 227 | 258 | 276 | 249 | 273 | 229 | 273 | 180 | 202 |
| 2040 | 151 | 235 | 305 | 320 | 209 | 218 | 271 | 275 | 320 | 257 | 320 | 217 | 226 |
| 2041 | 196 | 255 | 323 | 305 | 231 | 250 | 334 | 319 | 333 | 301 | 326 | 195 | 216 |
| 2042 | 189 | 254 | 251 | 251 | 230 | 81  | 244 | 261 | 261 | 266 | 259 | 209 | 235 |
| 2043 | 252 | 273 | 374 | 359 | 235 | 59  | 304 | 318 | 389 | 374 | 378 | 213 | 218 |
| 2044 | 261 | 239 | 182 | 262 | 246 | 104 | 268 | 220 | 204 | 200 | 203 | 168 | 183 |
| 2045 | 283 | 284 | 26  | 33  | 292 | 37  | 55  | 61  | 24  | 99  | 36  | 133 | 139 |
| 2046 | 329 | 226 | 164 | 222 | 304 | 23  | 212 | 212 | 188 | 210 | 190 | 186 | 183 |
| 2047 | 393 | 221 | 70  | 164 | 219 | 23  | 137 | 140 | 143 | 186 | 149 | 62  | 59  |
| 2048 | 359 | 283 | 27  | 158 | 49  | 8   | 124 | 120 | 104 | 134 | 106 | 79  | 88  |
| 2049 | 342 | 230 | 8   | 103 | 194 | 6   | 66  | 57  | 44  | 63  | 48  | 238 | 252 |
| 2050 | 365 | 162 | 0   | 70  | 191 | 6   | 17  | 13  | 9   | 43  | 9   | 165 | 260 |
| 2051 | 302 | 200 | 0   | 33  | 149 | 0   | 1   | 0   | 0   | 25  | 0   | 74  | 227 |
| 2052 | 282 | 167 | 0   | 0   | 105 | 0   | 0   | 0   | 0   | 20  | 0   | 40  | 144 |
| 2053 | 312 | 125 | 0   | 0   | 149 | 0   | 0   | 0   | 0   | 16  | 0   | 29  | 82  |
| 2054 | 195 | 82  | 0   | 0   | 128 | 0   | 0   | 0   | 0   | 9   | 0   | 19  | 55  |
| 2055 | 183 | 46  | 0   | 0   | 72  | 0   | 0   | 0   | 0   | 5   | 0   | 17  | 39  |
| 2056 | 138 | 38  | 0   | 0   | 34  | 0   | 0   | 0   | 0   | 5   | 0   | 15  | 20  |
| 2057 | 124 | 25  | 0   | 0   | 4   | 0   | 0   | 0   | 0   | 7   | 0   | 29  | 31  |
| 2058 | 80  | 11  | 0   | 0   | 0   | 0   | 0   | 0   | 0   | 2   | 0   | 18  | 16  |
| 2059 | 84  | 13  | 0   | 0   | 0   | 0   | 0   | 0   | 0   | 2   | 0   | 21  | 20  |

| Year | 53 | 54 | 55 | 56 | 57 | 58 | 59 | 60 | 61 | 62 | 63 | 64 | 65 |
|------|----|----|----|----|----|----|----|----|----|----|----|----|----|
| 2060 | 99 | 6  | 0  | 0  | 0  | 0  | 0  | 0  | 0  | 2  | 0  | 14 | 15 |
| 2061 | 62 | 10 | 0  | 0  | 0  | 0  | 0  | 0  | 0  | 0  | 0  | 18 | 16 |
| 2062 | 53 | 13 | 0  | 0  | 0  | 0  | 0  | 0  | 0  | 0  | 0  | 20 | 23 |
| 2063 | 59 | 2  | 0  | 0  | 0  | 0  | 0  | 0  | 0  | 0  | 0  | 6  | 8  |
| 2064 | 38 | 0  | 0  | 0  | 0  | 0  | 0  | 0  | 0  | 0  | 0  | 3  | 10 |
| 2065 | 47 | 0  | 0  | 0  | 0  | 0  | 0  | 0  | 0  | 0  | 0  | 0  | 0  |
| 2066 | 20 | 0  | 0  | 0  | 0  | 0  | 0  | 0  | 0  | 0  | 0  | 0  | 0  |
| 2067 | 12 | 0  | 0  | 0  | 0  | 0  | 0  | 0  | 0  | 0  | 0  | 0  | 0  |
| 2068 | 28 | 0  | 0  | 0  | 0  | 0  | 0  | 0  | 0  | 0  | 0  | 0  | 0  |
| 2069 | 15 | 0  | 0  | 0  | 0  | 0  | 0  | 0  | 0  | 0  | 0  | 0  | 0  |
| 2070 | 12 | 0  | 0  | 0  | 0  | 0  | 0  | 0  | 0  | 0  | 0  | 0  | 0  |
| 2071 | 11 | 0  | 0  | 0  | 0  | 0  | 0  | 0  | 0  | 0  | 0  | 0  | 0  |
| 2072 | 10 | 0  | 0  | 0  | 0  | 0  | 0  | 0  | 0  | 0  | 0  | 0  | 0  |
| 2073 | 6  | 0  | 0  | 0  | 0  | 0  | 0  | 0  | 0  | 0  | 0  | 0  | 0  |
| 2074 | 8  | 0  | 0  | 0  | 0  | 0  | 0  | 0  | 0  | 0  | 0  | 0  | 0  |
| 2075 | 12 | 0  | 0  | 0  | 0  | 0  | 0  | 0  | 0  | 0  | 0  | 0  | 0  |
| 2076 | 3  | 0  | 0  | 0  | 0  | 0  | 0  | 0  | 0  | 0  | 0  | 0  | 0  |
| 2077 | 0  | 0  | 0  | 0  | 0  | 0  | 0  | 0  | 0  | 0  | 0  | 0  | 0  |
| 2078 | 0  | 0  | 0  | 0  | 0  | 0  | 0  | 0  | 0  | 0  | 0  | 0  | 0  |
| 2079 | 0  | 0  | 0  | 0  | 0  | 0  | 0  | 0  | 0  | 0  | 0  | 0  | 0  |
| 2080 | 0  | 0  | 0  | 0  | 0  | 0  | 0  | 0  | 0  | 0  | 0  | 0  | 0  |
| 2081 | 0  | 0  | 0  | 0  | 0  | 0  | 0  | 0  | 0  | 0  | 0  | 0  | 0  |
| 2082 | 0  | 0  | 0  | 0  | 0  | 0  | 0  | 0  | 0  | 0  | 0  | 0  | 0  |
| 2083 | 0  | 0  | 0  | 0  | 0  | 0  | 0  | 0  | 0  | 0  | 0  | 0  | 0  |
| 2084 | 0  | 0  | 0  | 0  | 0  | 0  | 0  | 0  | 0  | 0  | 0  | 0  | 0  |
| 2085 | 0  | 0  | 0  | 0  | 0  | 0  | 0  | 0  | 0  | 0  | 0  | 0  | 0  |
| 2086 | 0  | 0  | 0  | 0  | 0  | 0  | 0  | 0  | 0  | 0  | 0  | 0  | 0  |
| 2087 | 0  | 0  | 0  | 0  | 0  | 0  | 0  | 0  | 0  | 0  | 0  | 0  | 0  |
| 2088 | 0  | 0  | 0  | 0  | 0  | 0  | 0  | 0  | 0  | 0  | 0  | 0  | 0  |
| 2089 | 0  | 0  | 0  | 0  | 0  | 0  | 0  | 0  | 0  | 0  | 0  | 0  | 0  |



| Year | 66  | 67  | 68  | 69  | 70  | 71  | 72  | 73  | 74  | 75  | 76  | 77  | 78  |
|------|-----|-----|-----|-----|-----|-----|-----|-----|-----|-----|-----|-----|-----|
| 2002 |     |     |     |     |     |     |     |     |     |     |     |     |     |
| 2003 | 0   | 0   | 0   | 0   | 0   | 0   | 0   | 0   | 0   | 0   | 0   | 0   | 0   |
| 2004 | 0   | 0   | 0   | 0   | 0   | 0   | 0   | 0   | 0   | 0   | 0   | 0   | 0   |
| 2005 | 0   | 0   | 0   | 0   | 0   | 0   | 0   | 0   | 0   | 0   | 0   | 0   | 0   |
| 2006 | 0   | 0   | 0   | 0   | 0   | 0   | 0   | 0   | 0   | 0   | 0   | 0   | 0   |
| 2007 | 0   | 0   | 0   | 0   | 0   | 0   | 0   | 0   | 0   | 0   | 0   | 0   | 0   |
| 2008 | 0   | 0   | 0   | 0   | 0   | 0   | 0   | 0   | 0   | 0   | 0   | 0   | 0   |
| 2009 | 0   | 0   | 0   | 0   | 0   | 0   | 0   | 0   | 0   | 0   | 0   | 0   | 0   |
| 2010 | 0   | 0   | 0   | 0   | 0   | 0   | 0   | 0   | 0   | 0   | 0   | 0   | 0   |
| 2011 | 0   | 0   | 0   | 0   | 0   | 0   | 0   | 0   | 0   | 0   | 0   | 0   | 0   |
| 2012 | 0   | 0   | 0   | 0   | 0   | 0   | 0   | 0   | 0   | 0   | 0   | 0   | 0   |
| 2013 | 0   | 0   | 0   | 0   | 0   | 0   | 0   | 0   | 0   | 0   | 0   | 0   | 0   |
| 2014 | 0   | 0   | 0   | 0   | 0   | 0   | 0   | 0   | 0   | 0   | 0   | 0   | 0   |
| 2015 | 0   | 0   | 0   | 0   | 0   | 0   | 0   | 0   | 0   | 0   | 0   | 0   | 0   |
| 2016 | 0   | 0   | 0   | 0   | 0   | 0   | 0   | 0   | 0   | 0   | 0   | 0   | 0   |
| 2017 | 0   | 0   | 0   | 0   | 0   | 0   | 0   | 0   | 0   | 0   | 0   | 0   | 0   |
| 2018 | 0   | 0   | 0   | 0   | 0   | 0   | 0   | 0   | 0   | 0   | 0   | 0   | 0   |
| 2019 | 0   | 0   | 0   | 0   | 0   | 0   | 0   | 0   | 0   | 0   | 0   | 0   | 0   |
| 2020 | 0   | 79  | 0   | 0   | 0   | 0   | 0   | 0   | 0   | 0   | 9   | 0   | 0   |
| 2021 | 0   | 140 | 0   | 0   | 0   | 0   | 0   | 0   | 0   | 0   | 13  | 0   | 0   |
| 2022 | 0   | 212 | 0   | 0   | 0   | 0   | 0   | 0   | 0   | 0   | 69  | 0   | 0   |
| 2023 | 0   | 240 | 0   | 0   | 0   | 0   | 0   | 0   | 0   | 0   | 122 | 0   | 0   |
| 2024 | 0   | 257 | 0   | 0   | 0   | 0   | 0   | 0   | 0   | 0   | 141 | 0   | 0   |
| 2025 | 0   | 187 | 56  | 153 | 215 | 4   | 62  | 15  | 15  | 0   | 177 | 11  | 55  |
| 2026 | 0   | 263 | 166 | 247 | 299 | 12  | 197 | 32  | 130 | 0   | 175 | 54  | 202 |
| 2027 | 0   | 241 | 161 | 291 | 293 | 30  | 181 | 59  | 131 | 0   | 220 | 94  | 192 |
| 2028 | 0   | 289 | 178 | 295 | 303 | 43  | 262 | 95  | 148 | 0   | 274 | 85  | 291 |
| 2029 | 0   | 257 | 192 | 227 | 257 | 95  | 231 | 137 | 157 | 0   | 230 | 83  | 264 |
| 2030 | 58  | 281 | 222 | 215 | 237 | 93  | 240 | 169 | 187 | 9   | 283 | 154 | 217 |
| 2031 | 222 | 243 | 302 | 217 | 236 | 128 | 303 | 183 | 193 | 167 | 244 | 154 | 255 |
| 2032 | 225 | 262 | 255 | 222 | 247 | 113 | 249 | 232 | 261 | 191 | 285 | 130 | 188 |
| 2033 | 232 | 196 | 326 | 244 | 221 | 158 | 261 | 205 | 231 | 160 | 268 | 210 | 214 |
| 2034 | 279 | 239 | 328 | 250 | 254 | 193 | 281 | 301 | 340 | 210 | 336 | 239 | 266 |
| 2035 | 266 | 200 | 313 | 240 | 262 | 158 | 275 | 263 | 264 | 188 | 290 | 194 | 245 |
| 2036 | 301 | 176 | 234 | 249 | 201 | 218 | 266 | 251 | 283 | 200 | 280 | 244 | 214 |
| 2037 | 295 | 197 | 201 | 246 | 182 | 215 | 238 | 265 | 264 | 215 | 254 | 346 | 249 |
| 2038 | 300 | 175 | 192 | 276 | 189 | 269 | 197 | 323 | 332 | 276 | 259 | 265 | 249 |
| 2039 | 244 | 195 | 196 | 225 | 189 | 247 | 194 | 292 | 300 | 269 | 236 | 300 | 260 |
| 2040 | 237 | 149 | 213 | 228 | 228 | 280 | 223 | 272 | 279 | 310 | 255 | 307 | 292 |
| 2041 | 288 | 167 | 224 | 229 | 233 | 277 | 203 | 264 | 287 | 332 | 316 | 336 | 280 |
| 2042 | 293 | 214 | 245 | 239 | 222 | 268 | 217 | 287 | 307 | 247 | 359 | 303 | 316 |
| 2043 | 239 | 213 | 195 | 181 | 187 | 252 | 221 | 298 | 276 | 252 | 215 | 290 | 298 |
| 2044 | 251 | 112 | 145 | 189 | 169 | 191 | 168 | 227 | 258 | 252 | 149 | 279 | 269 |
| 2045 | 198 | 53  | 148 | 258 | 161 | 225 | 133 | 256 | 274 | 300 | 242 | 292 | 200 |
| 2046 | 222 | 190 | 152 | 122 | 144 | 234 | 192 | 176 | 190 | 262 | 157 | 242 | 108 |
| 2047 | 189 | 61  | 61  | 117 | 42  | 188 | 73  | 311 | 334 | 260 | 112 | 420 | 315 |
| 2048 | 138 | 57  | 92  | 251 | 28  | 203 | 80  | 240 | 351 | 229 | 65  | 342 | 213 |
| 2049 | 41  | 37  | 273 | 224 | 236 | 423 | 250 | 124 | 264 | 388 | 28  | 241 | 147 |
| 2050 | 264 | 39  | 252 | 99  | 207 | 329 | 250 | 86  | 182 | 301 | 24  | 136 | 98  |
| 2051 | 236 | 40  | 171 | 64  | 136 | 214 | 163 | 64  | 112 | 296 | 30  | 104 | 46  |
| 2052 | 252 | 42  | 96  | 38  | 75  | 158 | 88  | 28  | 62  | 248 | 16  | 91  | 24  |
| 2053 | 206 | 35  | 49  | 12  | 38  | 131 | 51  | 31  | 51  | 165 | 12  | 76  | 7   |
| 2054 | 141 | 33  | 29  | 15  | 12  | 92  | 25  | 30  | 35  | 137 | 14  | 58  | 11  |
| 2055 | 124 | 46  | 23  | 11  | 1   | 74  | 16  | 12  | 12  | 79  | 15  | 59  | 3   |
| 2056 | 52  | 30  | 47  | 0   | 0   | 54  | 13  | 24  | 24  | 49  | 13  | 8   | 0   |
| 2057 | 31  | 40  | 39  | 0   | 0   | 55  | 28  | 14  | 16  | 23  | 15  | 24  | 0   |
| 2058 | 4   | 26  | 16  | 0   | 0   | 88  | 17  | 5   | 4   | 21  | 9   | 14  | 0   |
| 2059 | 12  | 21  | 29  | 0   | 0   | 82  | 19  | 5   | 7   | 5   | 7   | 7   | 0   |

| Year | 66 | 67 | 68 | 69 | 70 | 71 | 72 | 73 | 74 | 75 | 76 | 77 | 78 |
|------|----|----|----|----|----|----|----|----|----|----|----|----|----|
| 2060 | 4  | 15 | 21 | 0  | 0  | 32 | 15 | 1  | 2  | 1  | 1  | 14 | 0  |
| 2061 | 4  | 5  | 14 | 0  | 0  | 48 | 17 | 4  | 3  | 2  | 0  | 5  | 0  |
| 2062 | 17 | 0  | 20 | 0  | 0  | 54 | 20 | 3  | 3  | 1  | 0  | 5  | 0  |
| 2063 | 12 | 0  | 14 | 0  | 0  | 56 | 6  | 0  | 0  | 1  | 0  | 2  | 0  |
| 2064 | 10 | 0  | 24 | 0  | 0  | 23 | 4  | 0  | 0  | 0  | 0  | 4  | 0  |
| 2065 | 1  | 0  | 13 | 0  | 0  | 31 | 0  | 0  | 0  | 0  | 0  | 1  | 0  |
| 2066 | 0  | 0  | 13 | 0  | 0  | 18 | 0  | 0  | 0  | 0  | 0  | 2  | 0  |
| 2067 | 0  | 0  | 11 | 0  | 0  | 16 | 0  | 0  | 0  | 0  | 0  | 0  | 0  |
| 2068 | 0  | 0  | 1  | 0  | 0  | 14 | 0  | 0  | 0  | 0  | 0  | 0  | 0  |
| 2069 | 0  | 0  | 0  | 0  | 0  | 16 | 0  | 0  | 0  | 0  | 0  | 0  | 0  |
| 2070 | 0  | 0  | 0  | 0  | 0  | 25 | 0  | 0  | 0  | 0  | 0  | 0  | 0  |
| 2071 | 0  | 0  | 0  | 0  | 0  | 18 | 0  | 0  | 0  | 0  | 0  | 0  | 0  |
| 2072 | 0  | 0  | 0  | 0  | 0  | 17 | 0  | 0  | 0  | 0  | 0  | 0  | 0  |
| 2073 | 0  | 0  | 0  | 0  | 0  | 17 | 0  | 0  | 0  | 0  | 0  | 0  | 0  |
| 2074 | 0  | 0  | 0  | 0  | 0  | 16 | 0  | 0  | 0  | 0  | 0  | 0  | 0  |
| 2075 | 0  | 0  | 0  | 0  | 0  | 18 | 0  | 0  | 0  | 0  | 0  | 0  | 0  |
| 2076 | 0  | 0  | 0  | 0  | 0  | 7  | 0  | 0  | 0  | 0  | 0  | 0  | 0  |
| 2077 | 0  | 0  | 0  | 0  | 0  | 4  | 0  | 0  | 0  | 0  | 0  | 0  | 0  |
| 2078 | 0  | 0  | 0  | 0  | 0  | 0  | 0  | 0  | 0  | 0  | 0  | 0  | 0  |
| 2079 | 0  | 0  | 0  | 0  | 0  | 0  | 0  | 0  | 0  | 0  | 0  | 0  | 0  |
| 2080 | 0  | 0  | 0  | 0  | 0  | 0  | 0  | 0  | 0  | 0  | 0  | 0  | 0  |
| 2081 | 0  | 0  | 0  | 0  | 0  | 0  | 0  | 0  | 0  | 0  | 0  | 0  | 0  |
| 2082 | 0  | 0  | 0  | 0  | 0  | 0  | 0  | 0  | 0  | 0  | 0  | 0  | 0  |
| 2083 | 0  | 0  | 0  | 0  | 0  | 0  | 0  | 0  | 0  | 0  | 0  | 0  | 0  |
| 2084 | 0  | 0  | 0  | 0  | 0  | 0  | 0  | 0  | 0  | 0  | 0  | 0  | 0  |
| 2085 | 0  | 0  | 0  | 0  | 0  | 0  | 0  | 0  | 0  | 0  | 0  | 0  | 0  |
| 2086 | 0  | 0  | 0  | 0  | 0  | 0  | 0  | 0  | 0  | 0  | 0  | 0  | 0  |
| 2087 | 0  | 0  | 0  | 0  | 0  | 0  | 0  | 0  | 0  | 0  | 0  | 0  | 0  |
| 2088 | 0  | 0  | 0  | 0  | 0  | 0  | 0  | 0  | 0  | 0  | 0  | 0  | 0  |
| 2089 | 0  | 0  | 0  | 0  | 0  | 0  | 0  | 0  | 0  | 0  | 0  | 0  | 0  |

| Year | 79  | 80  | 81  | 82  | 83  | 84  | 85  | 86  | 87  | 88  | 89  | 90  | 91  |
|------|-----|-----|-----|-----|-----|-----|-----|-----|-----|-----|-----|-----|-----|
| 2002 |     |     |     |     |     |     |     |     |     |     |     |     |     |
| 2003 | 0   | 0   | 0   | 0   | 0   | 0   | 0   | 0   | 0   | 0   | 0   | 0   | 0   |
| 2004 | 0   | 0   | 0   | 0   | 0   | 0   | 0   | 0   | 0   | 0   | 0   | 0   | 0   |
| 2005 | 0   | 0   | 0   | 0   | 0   | 0   | 0   | 0   | 0   | 0   | 0   | 0   | 0   |
| 2006 | 0   | 0   | 0   | 0   | 0   | 0   | 0   | 0   | 0   | 0   | 0   | 0   | 0   |
| 2007 | 0   | 0   | 0   | 0   | 0   | 0   | 0   | 0   | 0   | 0   | 0   | 0   | 0   |
| 2008 | 0   | 0   | 0   | 0   | 0   | 0   | 0   | 0   | 0   | 0   | 0   | 0   | 0   |
| 2009 | 0   | 0   | 0   | 0   | 0   | 0   | 0   | 0   | 0   | 0   | 0   | 0   | 0   |
| 2010 | 0   | 0   | 0   | 0   | 0   | 0   | 0   | 0   | 0   | 0   | 0   | 0   | 0   |
| 2011 | 0   | 0   | 0   | 0   | 0   | 0   | 0   | 0   | 0   | 0   | 0   | 0   | 0   |
| 2012 | 0   | 0   | 0   | 0   | 0   | 0   | 0   | 0   | 0   | 0   | 0   | 0   | 0   |
| 2013 | 0   | 0   | 0   | 0   | 0   | 0   | 0   | 0   | 0   | 0   | 0   | 0   | 0   |
| 2014 | 0   | 0   | 0   | 0   | 0   | 0   | 0   | 0   | 0   | 0   | 0   | 0   | 0   |
| 2015 | 0   | 0   | 0   | 0   | 0   | 0   | 0   | 0   | 0   | 0   | 0   | 0   | 0   |
| 2016 | 0   | 0   | 0   | 0   | 0   | 0   | 0   | 0   | 0   | 0   | 0   | 0   | 0   |
| 2017 | 0   | 0   | 0   | 0   | 0   | 0   | 0   | 0   | 0   | 0   | 0   | 0   | 0   |
| 2018 | 0   | 0   | 0   | 0   | 0   | 0   | 0   | 0   | 0   | 0   | 0   | 0   | 0   |
| 2019 | 0   | 0   | 0   | 0   | 0   | 0   | 0   | 0   | 0   | 0   | 0   | 0   | 0   |
| 2020 | 0   | 0   | 0   | 0   | 0   | 0   | 224 | 0   | 0   | 0   | 0   | 0   | 0   |
| 2021 | 0   | 0   | 0   | 0   | 0   | 0   | 209 | 0   | 0   | 0   | 0   | 0   | 0   |
| 2022 | 0   | 0   | 0   | 0   | 0   | 0   | 233 | 0   | 0   | 0   | 0   | 0   | 0   |
| 2023 | 0   | 0   | 0   | 0   | 0   | 0   | 224 | 0   | 0   | 0   | 0   | 0   | 0   |
| 2024 | 0   | 0   | 0   | 0   | 0   | 0   | 223 | 0   | 0   | 0   | 0   | 0   | 0   |
| 2025 | 56  | 1   | 15  | 225 | 225 | 0   | 229 | 225 | 225 | 225 | 225 | 225 | 62  |
| 2026 | 224 | 1   | 107 | 194 | 226 | 0   | 248 | 216 | 216 | 216 | 216 | 216 | 107 |
| 2027 | 276 | 3   | 109 | 216 | 268 | 0   | 226 | 252 | 252 | 252 | 252 | 252 | 126 |
| 2028 | 319 | 20  | 123 | 195 | 241 | 0   | 223 | 222 | 222 | 222 | 222 | 222 | 203 |
| 2029 | 273 | 14  | 148 | 203 | 260 | 0   | 225 | 238 | 238 | 238 | 238 | 238 | 191 |
| 2030 | 226 | 29  | 181 | 217 | 268 | 225 | 268 | 245 | 245 | 245 | 245 | 245 | 223 |
| 2031 | 316 | 38  | 190 | 218 | 252 | 231 | 249 | 238 | 238 | 238 | 238 | 238 | 290 |
| 2032 | 281 | 77  | 256 | 196 | 243 | 241 | 224 | 216 | 216 | 216 | 216 | 216 | 227 |
| 2033 | 242 | 110 | 214 | 207 | 253 | 274 | 275 | 229 | 229 | 229 | 228 | 229 | 255 |
| 2034 | 262 | 108 | 314 | 219 | 254 | 256 | 295 | 238 | 238 | 238 | 235 | 238 | 282 |
| 2035 | 271 | 111 | 266 | 218 | 236 | 297 | 251 | 226 | 226 | 226 | 219 | 226 | 261 |
| 2036 | 262 | 132 | 259 | 255 | 271 | 270 | 331 | 268 | 283 | 268 | 259 | 268 | 267 |
| 2037 | 276 | 162 | 262 | 234 | 249 | 257 | 241 | 240 | 247 | 241 | 218 | 241 | 236 |
| 2038 | 229 | 145 | 330 | 263 | 276 | 231 | 195 | 273 | 290 | 274 | 252 | 274 | 193 |
| 2039 | 210 | 178 | 283 | 276 | 290 | 241 | 255 | 286 | 243 | 283 | 237 | 283 | 192 |
| 2040 | 244 | 177 | 271 | 276 | 296 | 231 | 246 | 280 | 283 | 287 | 218 | 287 | 201 |
| 2041 | 254 | 230 | 286 | 311 | 331 | 243 | 215 | 291 | 272 | 329 | 275 | 322 | 197 |
| 2042 | 288 | 234 | 299 | 227 | 231 | 231 | 95  | 275 | 302 | 236 | 234 | 231 | 231 |
| 2043 | 220 | 257 | 294 | 299 | 312 | 248 | 34  | 280 | 298 | 319 | 310 | 310 | 220 |
| 2044 | 250 | 248 | 239 | 290 | 311 | 244 | 92  | 304 | 282 | 317 | 276 | 300 | 161 |
| 2045 | 171 | 331 | 266 | 29  | 48  | 325 | 53  | 52  | 44  | 28  | 105 | 40  | 129 |
| 2046 | 84  | 301 | 182 | 104 | 204 | 259 | 47  | 166 | 168 | 149 | 171 | 162 | 174 |
| 2047 | 231 | 493 | 328 | 74  | 154 | 275 | 44  | 120 | 124 | 106 | 150 | 117 | 92  |
| 2048 | 209 | 365 | 319 | 66  | 149 | 45  | 13  | 105 | 103 | 103 | 134 | 109 | 63  |
| 2049 | 146 | 343 | 201 | 40  | 97  | 165 | 10  | 73  | 73  | 65  | 87  | 69  | 131 |
| 2050 | 68  | 297 | 141 | 24  | 64  | 157 | 8   | 45  | 44  | 42  | 77  | 42  | 131 |
| 2051 | 30  | 235 | 88  | 22  | 55  | 147 | 0   | 37  | 38  | 39  | 68  | 39  | 114 |
| 2052 | 8   | 188 | 30  | 11  | 33  | 113 | 0   | 26  | 24  | 23  | 48  | 23  | 91  |
| 2053 | 0   | 241 | 35  | 3   | 8   | 114 | 0   | 10  | 7   | 5   | 25  | 5   | 64  |
| 2054 | 0   | 151 | 31  | 1   | 3   | 100 | 0   | 3   | 2   | 2   | 18  | 2   | 42  |
| 2055 | 0   | 156 | 16  | 3   | 6   | 80  | 0   | 3   | 4   | 4   | 14  | 4   | 39  |
| 2056 | 0   | 115 | 25  | 0   | 0   | 67  | 0   | 0   | 0   | 0   | 9   | 0   | 15  |
| 2057 | 0   | 145 | 15  | 0   | 0   | 46  | 0   | 0   | 0   | 0   | 14  | 0   | 36  |
| 2058 | 0   | 83  | 5   | 0   | 0   | 31  | 0   | 0   | 0   | 0   | 7   | 0   | 19  |
| 2059 | 0   | 87  | 7   | 0   | 0   | 20  | 0   | 0   | 0   | 0   | 7   | 0   | 20  |

| Year | 79 | 80 | 81 | 82 | 83 | 84 | 85 | 86 | 87 | 88 | 89 | 90 | 91 |
|------|----|----|----|----|----|----|----|----|----|----|----|----|----|
| 2060 | 0  | 90 | 3  | 0  | 0  | 4  | 0  | 0  | 0  | 0  | 1  | 0  | 19 |
| 2061 | 0  | 82 | 3  | 0  | 0  | 3  | 0  | 0  | 0  | 0  | 0  | 0  | 21 |
| 2062 | 0  | 62 | 3  | 0  | 0  | 0  | 0  | 0  | 0  | 0  | 0  | 0  | 26 |
| 2063 | 0  | 59 | 0  | 0  | 0  | 0  | 0  | 0  | 0  | 0  | 0  | 0  | 12 |
| 2064 | 0  | 30 | 0  | 0  | 0  | 0  | 0  | 0  | 0  | 0  | 0  | 0  | 13 |
| 2065 | 0  | 40 | 0  | 0  | 0  | 0  | 0  | 0  | 0  | 0  | 0  | 0  | 0  |
| 2066 | 0  | 23 | 0  | 0  | 0  | 0  | 0  | 0  | 0  | 0  | 0  | 0  | 0  |
| 2067 | 0  | 13 | 0  | 0  | 0  | 0  | 0  | 0  | 0  | 0  | 0  | 0  | 0  |
| 2068 | 0  | 33 | 0  | 0  | 0  | 0  | 0  | 0  | 0  | 0  | 0  | 0  | 0  |
| 2069 | 0  | 10 | 0  | 0  | 0  | 0  | 0  | 0  | 0  | 0  | 0  | 0  | 0  |
| 2070 | 0  | 10 | 0  | 0  | 0  | 0  | 0  | 0  | 0  | 0  | 0  | 0  | 0  |
| 2071 | 0  | 6  | 0  | 0  | 0  | 0  | 0  | 0  | 0  | 0  | 0  | 0  | 0  |
| 2072 | 0  | 6  | 0  | 0  | 0  | 0  | 0  | 0  | 0  | 0  | 0  | 0  | 0  |
| 2073 | 0  | 3  | 0  | 0  | 0  | 0  | 0  | 0  | 0  | 0  | 0  | 0  | 0  |
| 2074 | 0  | 2  | 0  | 0  | 0  | 0  | 0  | 0  | 0  | 0  | 0  | 0  | 0  |
| 2075 | 0  | 4  | 0  | 0  | 0  | 0  | 0  | 0  | 0  | 0  | 0  | 0  | 0  |
| 2076 | 0  | 0  | 0  | 0  | 0  | 0  | 0  | 0  | 0  | 0  | 0  | 0  | 0  |
| 2077 | 0  | 0  | 0  | 0  | 0  | 0  | 0  | 0  | 0  | 0  | 0  | 0  | 0  |
| 2078 | 0  | 0  | 0  | 0  | 0  | 0  | 0  | 0  | 0  | 0  | 0  | 0  | 0  |
| 2079 | 0  | 0  | 0  | 0  | 0  | 0  | 0  | 0  | 0  | 0  | 0  | 0  | 0  |
| 2080 | 0  | 0  | 0  | 0  | 0  | 0  | 0  | 0  | 0  | 0  | 0  | 0  | 0  |
| 2081 | 0  | 0  | 0  | 0  | 0  | 0  | 0  | 0  | 0  | 0  | 0  | 0  | 0  |
| 2082 | 0  | 0  | 0  | 0  | 0  | 0  | 0  | 0  | 0  | 0  | 0  | 0  | 0  |
| 2083 | 0  | 0  | 0  | 0  | 0  | 0  | 0  | 0  | 0  | 0  | 0  | 0  | 0  |
| 2084 | 0  | 0  | 0  | 0  | 0  | 0  | 0  | 0  | 0  | 0  | 0  | 0  | 0  |
| 2085 | 0  | 0  | 0  | 0  | 0  | 0  | 0  | 0  | 0  | 0  | 0  | 0  | 0  |
| 2086 | 0  | 0  | 0  | 0  | 0  | 0  | 0  | 0  | 0  | 0  | 0  | 0  | 0  |
| 2087 | 0  | 0  | 0  | 0  | 0  | 0  | 0  | 0  | 0  | 0  | 0  | 0  | 0  |
| 2088 | 0  | 0  | 0  | 0  | 0  | 0  | 0  | 0  | 0  | 0  | 0  | 0  | 0  |
| 2089 | 0  | 0  | 0  | 0  | 0  | 0  | 0  | 0  | 0  | 0  | 0  | 0  | 0  |

| Year | 92  | 93  | 94  | 95  | 96  | 97  | 98  | 99  | 100 | 101 | 102 | 103 | 104 |
|------|-----|-----|-----|-----|-----|-----|-----|-----|-----|-----|-----|-----|-----|
| 2002 |     |     |     |     |     |     |     |     |     |     |     |     |     |
| 2003 | 0   | 0   | 0   | 0   | 0   | 0   | 0   | 0   | 0   | 0   | 0   | 0   | 0   |
| 2004 | 0   | 0   | 0   | 0   | 0   | 0   | 0   | 0   | 0   | 0   | 0   | 0   | 0   |
| 2005 | 0   | 0   | 0   | 0   | 0   | 0   | 0   | 0   | 0   | 0   | 0   | 0   | 0   |
| 2006 | 0   | 0   | 0   | 0   | 0   | 0   | 0   | 0   | 0   | 0   | 0   | 0   | 0   |
| 2007 | 0   | 0   | 0   | 0   | 0   | 0   | 0   | 0   | 0   | 0   | 0   | 0   | 0   |
| 2008 | 0   | 0   | 0   | 0   | 0   | 0   | 0   | 0   | 0   | 0   | 0   | 0   | 0   |
| 2009 | 0   | 0   | 0   | 0   | 0   | 0   | 0   | 0   | 0   | 0   | 0   | 0   | 0   |
| 2010 | 0   | 0   | 0   | 0   | 0   | 0   | 0   | 0   | 0   | 0   | 0   | 0   | 0   |
| 2011 | 0   | 0   | 0   | 0   | 0   | 0   | 0   | 0   | 0   | 0   | 0   | 0   | 0   |
| 2012 | 0   | 0   | 0   | 0   | 0   | 0   | 0   | 0   | 0   | 0   | 0   | 0   | 0   |
| 2013 | 0   | 0   | 0   | 0   | 0   | 0   | 0   | 0   | 0   | 0   | 0   | 0   | 0   |
| 2014 | 0   | 0   | 0   | 0   | 0   | 0   | 0   | 0   | 0   | 0   | 0   | 0   | 0   |
| 2015 | 0   | 0   | 0   | 0   | 0   | 0   | 0   | 0   | 0   | 0   | 0   | 0   | 0   |
| 2016 | 0   | 0   | 0   | 0   | 0   | 0   | 0   | 0   | 0   | 0   | 0   | 0   | 0   |
| 2017 | 0   | 0   | 0   | 0   | 0   | 0   | 0   | 0   | 0   | 0   | 0   | 0   | 0   |
| 2018 | 0   | 0   | 0   | 0   | 0   | 0   | 0   | 0   | 0   | 0   | 0   | 0   | 0   |
| 2019 | 0   | 0   | 0   | 0   | 0   | 0   | 0   | 0   | 0   | 0   | 0   | 0   | 0   |
| 2020 | 0   | 0   | 79  | 0   | 0   | 0   | 0   | 0   | 0   | 0   | 0   | 9   | 0   |
| 2021 | 0   | 0   | 99  | 0   | 0   | 0   | 0   | 0   | 0   | 0   | 0   | 13  | 0   |
| 2022 | 0   | 0   | 190 | 0   | 0   | 0   | 0   | 0   | 0   | 0   | 0   | 68  | 0   |
| 2023 | 0   | 0   | 233 | 0   | 0   | 0   | 0   | 0   | 0   | 0   | 0   | 100 | 0   |
| 2024 | 0   | 0   | 249 | 0   | 0   | 0   | 0   | 0   | 0   | 0   | 0   | 131 | 0   |
| 2025 | 62  | 0   | 187 | 56  | 153 | 215 | 4   | 62  | 15  | 15  | 0   | 146 | 11  |
| 2026 | 187 | 0   | 276 | 139 | 209 | 258 | 12  | 160 | 24  | 117 | 0   | 180 | 46  |
| 2027 | 185 | 0   | 240 | 134 | 259 | 258 | 21  | 158 | 51  | 116 | 0   | 227 | 74  |
| 2028 | 258 | 0   | 289 | 167 | 266 | 271 | 42  | 238 | 79  | 137 | 0   | 267 | 72  |
| 2029 | 241 | 0   | 259 | 183 | 227 | 259 | 85  | 216 | 118 | 162 | 0   | 229 | 80  |
| 2030 | 265 | 58  | 283 | 210 | 219 | 243 | 91  | 242 | 152 | 186 | 9   | 283 | 138 |
| 2031 | 322 | 192 | 239 | 293 | 220 | 242 | 123 | 305 | 165 | 190 | 137 | 219 | 132 |
| 2032 | 252 | 189 | 264 | 248 | 230 | 240 | 105 | 242 | 238 | 259 | 161 | 286 | 134 |
| 2033 | 281 | 201 | 198 | 319 | 245 | 230 | 139 | 267 | 201 | 227 | 135 | 278 | 203 |
| 2034 | 303 | 261 | 252 | 328 | 264 | 268 | 189 | 294 | 305 | 324 | 197 | 341 | 224 |
| 2035 | 274 | 272 | 212 | 321 | 235 | 252 | 158 | 269 | 261 | 274 | 194 | 284 | 208 |
| 2036 | 283 | 303 | 163 | 259 | 275 | 216 | 206 | 276 | 267 | 287 | 197 | 285 | 259 |
| 2037 | 247 | 292 | 201 | 209 | 239 | 189 | 216 | 242 | 251 | 258 | 211 | 269 | 349 |
| 2038 | 207 | 303 | 174 | 211 | 245 | 201 | 257 | 200 | 335 | 352 | 271 | 253 | 276 |
| 2039 | 205 | 255 | 129 | 204 | 209 | 184 | 248 | 198 | 293 | 306 | 275 | 230 | 294 |
| 2040 | 210 | 230 | 121 | 222 | 243 | 210 | 275 | 205 | 265 | 275 | 304 | 247 | 304 |
| 2041 | 210 | 277 | 146 | 221 | 243 | 240 | 277 | 204 | 268 | 277 | 328 | 283 | 342 |
| 2042 | 249 | 297 | 143 | 220 | 245 | 223 | 270 | 239 | 286 | 305 | 252 | 311 | 293 |
| 2043 | 231 | 243 | 128 | 187 | 201 | 190 | 263 | 227 | 292 | 296 | 261 | 242 | 301 |
| 2044 | 168 | 258 | 77  | 149 | 172 | 155 | 200 | 164 | 246 | 250 | 258 | 143 | 273 |
| 2045 | 136 | 204 | 110 | 155 | 231 | 138 | 235 | 133 | 276 | 283 | 300 | 219 | 323 |
| 2046 | 178 | 223 | 74  | 149 | 174 | 122 | 214 | 176 | 175 | 192 | 247 | 183 | 232 |
| 2047 | 92  | 190 | 50  | 73  | 86  | 122 | 206 | 92  | 213 | 317 | 285 | 165 | 370 |
| 2048 | 63  | 181 | 178 | 97  | 216 | 33  | 187 | 63  | 220 | 326 | 233 | 91  | 310 |
| 2049 | 240 | 42  | 117 | 203 | 190 | 182 | 360 | 198 | 158 | 257 | 215 | 41  | 246 |
| 2050 | 235 | 221 | 77  | 215 | 132 | 160 | 266 | 193 | 134 | 200 | 286 | 33  | 159 |
| 2051 | 211 | 206 | 54  | 172 | 92  | 150 | 254 | 169 | 92  | 133 | 236 | 34  | 136 |
| 2052 | 158 | 219 | 66  | 131 | 61  | 104 | 191 | 125 | 40  | 61  | 239 | 15  | 104 |
| 2053 | 104 | 188 | 50  | 76  | 34  | 69  | 155 | 87  | 41  | 57  | 216 | 13  | 99  |
| 2054 | 62  | 169 | 48  | 55  | 32  | 48  | 133 | 53  | 33  | 41  | 198 | 18  | 68  |
| 2055 | 55  | 150 | 53  | 39  | 21  | 20  | 102 | 47  | 17  | 21  | 133 | 15  | 59  |
| 2056 | 23  | 80  | 42  | 51  | 5   | 10  | 52  | 20  | 29  | 32  | 107 | 16  | 16  |
| 2057 | 40  | 66  | 51  | 41  | 4   | 5   | 52  | 38  | 16  | 16  | 61  | 17  | 24  |
| 2058 | 22  | 27  | 43  | 20  | 0   | 4   | 71  | 21  | 2   | 2   | 46  | 13  | 14  |
| 2059 | 20  | 24  | 34  | 31  | 0   | 0   | 62  | 20  | 4   | 4   | 17  | 13  | 6   |

| Year | 92 | 93 | 94 | 95 | 96 | 97 | 98 | 99 | 100 | 101 | 102 | 103 | 104 |
|------|----|----|----|----|----|----|----|----|-----|-----|-----|-----|-----|
| 2060 | 19 | 15 | 35 | 27 | 0  | 0  | 34 | 19 | 2   | 2   | 12  | 1   | 13  |
| 2061 | 21 | 12 | 32 | 21 | 0  | 0  | 50 | 21 | 2   | 2   | 7   | 0   | 6   |
| 2062 | 26 | 21 | 28 | 20 | 0  | 0  | 48 | 26 | 2   | 2   | 5   | 0   | 4   |
| 2063 | 12 | 10 | 4  | 22 | 0  | 0  | 52 | 12 | 0   | 0   | 2   | 0   | 3   |
| 2064 | 13 | 9  | 0  | 24 | 0  | 0  | 28 | 13 | 0   | 0   | 0   | 0   | 2   |
| 2065 | 0  | 1  | 0  | 16 | 0  | 0  | 43 | 0  | 0   | 0   | 1   | 0   | 1   |
| 2066 | 0  | 0  | 0  | 16 | 0  | 0  | 25 | 0  | 0   | 0   | 0   | 0   | 2   |
| 2067 | 0  | 0  | 0  | 9  | 0  | 0  | 25 | 0  | 0   | 0   | 0   | 0   | 0   |
| 2068 | 0  | 0  | 0  | 2  | 0  | 0  | 19 | 0  | 0   | 0   | 0   | 0   | 0   |
| 2069 | 0  | 0  | 0  | 0  | 0  | 0  | 14 | 0  | 0   | 0   | 0   | 0   | 0   |
| 2070 | 0  | 0  | 0  | 0  | 0  | 0  | 29 | 0  | 0   | 0   | 0   | 0   | 0   |
| 2071 | 0  | 0  | 0  | 0  | 0  | 0  | 17 | 0  | 0   | 0   | 0   | 0   | 0   |
| 2072 | 0  | 0  | 0  | 0  | 0  | 0  | 21 | 0  | 0   | 0   | 0   | 0   | 0   |
| 2073 | 0  | 0  | 0  | 0  | 0  | 0  | 17 | 0  | 0   | 0   | 0   | 0   | 0   |
| 2074 | 0  | 0  | 0  | 0  | 0  | 0  | 21 | 0  | 0   | 0   | 0   | 0   | 0   |
| 2075 | 0  | 0  | 0  | 0  | 0  | 0  | 25 | 0  | 0   | 0   | 0   | 0   | 0   |
| 2076 | 0  | 0  | 0  | 0  | 0  | 0  | 12 | 0  | 0   | 0   | 0   | 0   | 0   |
| 2077 | 0  | 0  | 0  | 0  | 0  | 0  | 14 | 0  | 0   | 0   | 0   | 0   | 0   |
| 2078 | 0  | 0  | 0  | 0  | 0  | 0  | 0  | 0  | 0   | 0   | 0   | 0   | 0   |
| 2079 | 0  | 0  | 0  | 0  | 0  | 0  | 0  | 0  | 0   | 0   | 0   | 0   | 0   |
| 2080 | 0  | 0  | 0  | 0  | 0  | 0  | 0  | 0  | 0   | 0   | 0   | 0   | 0   |
| 2081 | 0  | 0  | 0  | 0  | 0  | 0  | 0  | 0  | 0   | 0   | 0   | 0   | 0   |
| 2082 | 0  | 0  | 0  | 0  | 0  | 0  | 0  | 0  | 0   | 0   | 0   | 0   | 0   |
| 2083 | 0  | 0  | 0  | 0  | 0  | 0  | 0  | 0  | 0   | 0   | 0   | 0   | 0   |
| 2084 | 0  | 0  | 0  | 0  | 0  | 0  | 0  | 0  | 0   | 0   | 0   | 0   | 0   |
| 2085 | 0  | 0  | 0  | 0  | 0  | 0  | 0  | 0  | 0   | 0   | 0   | 0   | 0   |
| 2086 | 0  | 0  | 0  | 0  | 0  | 0  | 0  | 0  | 0   | 0   | 0   | 0   | 0   |
| 2087 | 0  | 0  | 0  | 0  | 0  | 0  | 0  | 0  | 0   | 0   | 0   | 0   | 0   |
| 2088 | 0  | 0  | 0  | 0  | 0  | 0  | 0  | 0  | 0   | 0   | 0   | 0   | 0   |
| 2089 | 0  | 0  | 0  | 0  | 0  | 0  | 0  | 0  | 0   | 0   | 0   | 0   | 0   |

| Year | 105 | 106 | 107 | 108 | 109 | 110 | 111 | 112 | 113 | 114 | 115 | 116 | 117 |
|------|-----|-----|-----|-----|-----|-----|-----|-----|-----|-----|-----|-----|-----|
| 2002 |     |     |     |     |     |     |     |     |     |     |     |     |     |
| 2003 | 0   | 0   | 0   | 0   | 0   | 0   | 0   | 0   | 0   | 0   | 0   | 0   | 0   |
| 2004 | 0   | 0   | 0   | 0   | 0   | 0   | 0   | 0   | 0   | 0   | 0   | 0   | 0   |
| 2005 | 0   | 0   | 0   | 0   | 0   | 0   | 0   | 0   | 0   | 0   | 0   | 0   | 0   |
| 2006 | 0   | 0   | 0   | 0   | 0   | 0   | 0   | 0   | 0   | 0   | 0   | 0   | 0   |
| 2007 | 0   | 0   | 0   | 0   | 0   | 0   | 0   | 0   | 0   | 0   | 0   | 0   | 0   |
| 2008 | 0   | 0   | 0   | 0   | 0   | 0   | 0   | 0   | 0   | 0   | 0   | 0   | 0   |
| 2009 | 0   | 0   | 0   | 0   | 0   | 0   | 0   | 0   | 0   | 0   | 0   | 0   | 0   |
| 2010 | 0   | 0   | 0   | 0   | 0   | 0   | 0   | 0   | 0   | 0   | 0   | 0   | 0   |
| 2011 | 0   | 0   | 0   | 0   | 0   | 0   | 0   | 0   | 0   | 0   | 0   | 0   | 0   |
| 2012 | 0   | 0   | 0   | 0   | 0   | 0   | 0   | 0   | 0   | 0   | 0   | 0   | 0   |
| 2013 | 0   | 0   | 0   | 0   | 0   | 0   | 0   | 0   | 0   | 0   | 0   | 0   | 0   |
| 2014 | 0   | 0   | 0   | 0   | 0   | 0   | 0   | 0   | 0   | 0   | 0   | 0   | 0   |
| 2015 | 0   | 0   | 0   | 0   | 0   | 0   | 0   | 0   | 0   | 0   | 0   | 0   | 0   |
| 2016 | 0   | 0   | 0   | 0   | 0   | 0   | 0   | 0   | 0   | 0   | 0   | 0   | 0   |
| 2017 | 0   | 0   | 0   | 0   | 0   | 0   | 0   | 0   | 0   | 0   | 0   | 0   | 0   |
| 2018 | 0   | 0   | 0   | 0   | 0   | 0   | 0   | 0   | 0   | 0   | 0   | 0   | 0   |
| 2019 | 0   | 0   | 0   | 0   | 0   | 0   | 0   | 0   | 0   | 0   | 0   | 0   | 0   |
| 2020 | 0   | 0   | 0   | 0   | 0   | 0   | 0   | 224 | 0   | 0   | 0   | 0   | 0   |
| 2021 | 0   | 0   | 0   | 0   | 0   | 0   | 0   | 222 | 0   | 0   | 0   | 0   | 0   |
| 2022 | 0   | 0   | 0   | 0   | 0   | 0   | 0   | 224 | 0   | 0   | 0   | 0   | 0   |
| 2023 | 0   | 0   | 0   | 0   | 0   | 0   | 0   | 226 | 0   | 0   | 0   | 0   | 0   |
| 2024 | 0   | 0   | 0   | 0   | 0   | 0   | 0   | 221 | 0   | 0   | 0   | 0   | 0   |
| 2025 | 55  | 56  | 1   | 15  | 225 | 225 | 0   | 237 | 225 | 225 | 225 | 225 | 225 |
| 2026 | 169 | 186 | 1   | 84  | 220 | 220 | 0   | 225 | 220 | 220 | 220 | 220 | 220 |
| 2027 | 166 | 239 | 3   | 87  | 221 | 221 | 0   | 226 | 221 | 221 | 221 | 221 | 221 |
| 2028 | 261 | 291 | 19  | 120 | 224 | 224 | 0   | 224 | 224 | 224 | 224 | 224 | 224 |
| 2029 | 263 | 271 | 11  | 136 | 220 | 220 | 0   | 250 | 220 | 220 | 220 | 220 | 220 |
| 2030 | 232 | 231 | 29  | 167 | 222 | 222 | 225 | 235 | 222 | 222 | 222 | 222 | 222 |
| 2031 | 248 | 322 | 35  | 175 | 227 | 227 | 223 | 227 | 227 | 227 | 227 | 227 | 227 |
| 2032 | 203 | 275 | 67  | 251 | 225 | 225 | 220 | 248 | 225 | 233 | 225 | 219 | 225 |
| 2033 | 203 | 244 | 108 | 214 | 220 | 233 | 226 | 256 | 220 | 223 | 228 | 227 | 228 |
| 2034 | 277 | 272 | 105 | 315 | 231 | 231 | 224 | 214 | 228 | 211 | 231 | 201 | 231 |
| 2035 | 234 | 274 | 106 | 269 | 238 | 238 | 222 | 294 | 235 | 229 | 238 | 207 | 238 |
| 2036 | 226 | 269 | 134 | 278 | 249 | 257 | 235 | 240 | 249 | 231 | 252 | 187 | 251 |
| 2037 | 240 | 274 | 154 | 254 | 236 | 257 | 231 | 195 | 242 | 263 | 248 | 207 | 246 |
| 2038 | 248 | 240 | 139 | 344 | 281 | 286 | 231 | 227 | 290 | 267 | 288 | 247 | 285 |
| 2039 | 243 | 221 | 189 | 299 | 214 | 236 | 230 | 235 | 247 | 237 | 223 | 189 | 219 |
| 2040 | 295 | 249 | 183 | 270 | 268 | 294 | 233 | 222 | 276 | 264 | 286 | 234 | 270 |
| 2041 | 269 | 261 | 220 | 273 | 214 | 225 | 241 | 170 | 236 | 232 | 251 | 192 | 229 |
| 2042 | 355 | 301 | 222 | 295 | 279 | 301 | 255 | 75  | 280 | 270 | 322 | 313 | 312 |
| 2043 | 287 | 227 | 250 | 295 | 110 | 120 | 269 | 96  | 43  | 128 | 44  | 106 | 62  |
| 2044 | 282 | 253 | 246 | 249 | 29  | 127 | 195 | 94  | 59  | 66  | 76  | 120 | 99  |
| 2045 | 230 | 175 | 339 | 281 | 64  | 170 | 101 | 84  | 130 | 146 | 106 | 183 | 121 |
| 2046 | 106 | 82  | 301 | 185 | 73  | 147 | 87  | 55  | 143 | 156 | 109 | 134 | 117 |
| 2047 | 255 | 178 | 440 | 275 | 84  | 149 | 112 | 117 | 133 | 123 | 116 | 160 | 119 |
| 2048 | 188 | 168 | 327 | 281 | 75  | 161 | 124 | 77  | 121 | 139 | 130 | 160 | 132 |
| 2049 | 173 | 151 | 348 | 216 | 70  | 127 | 165 | 12  | 106 | 95  | 103 | 127 | 105 |
| 2050 | 125 | 86  | 308 | 169 | 74  | 118 | 162 | 28  | 98  | 92  | 100 | 138 | 100 |
| 2051 | 53  | 49  | 248 | 114 | 51  | 135 | 128 | 16  | 84  | 86  | 68  | 98  | 68  |
| 2052 | 46  | 30  | 212 | 52  | 48  | 140 | 158 | 0   | 67  | 92  | 76  | 99  | 76  |
| 2053 | 25  | 18  | 258 | 49  | 62  | 113 | 150 | 9   | 121 | 108 | 131 | 153 | 131 |
| 2054 | 21  | 10  | 163 | 38  | 61  | 112 | 121 | 0   | 121 | 77  | 93  | 111 | 93  |
| 2055 | 8   | 5   | 161 | 19  | 19  | 74  | 101 | 0   | 61  | 62  | 63  | 80  | 63  |
| 2056 | 4   | 4   | 131 | 31  | 33  | 61  | 67  | 0   | 55  | 55  | 55  | 64  | 55  |
| 2057 | 0   | 0   | 150 | 16  | 43  | 0   | 146 | 0   | 44  | 26  | 25  | 30  | 25  |
| 2058 | 0   | 0   | 87  | 2   | 1   | 24  | 141 | 0   | 4   | 7   | 7   | 10  | 7   |
| 2059 | 0   | 0   | 86  | 4   | 11  | 0   | 138 | 0   | 8   | 3   | 4   | 7   | 4   |

| Year | 105 | 106 | 107 | 108 | 109 | 110 | 111 | 112 | 113 | 114 | 115 | 116 | 117 |
|------|-----|-----|-----|-----|-----|-----|-----|-----|-----|-----|-----|-----|-----|
| 2060 | 0   | 0   | 97  | 2   | 0   | 0   | 108 | 0   | 0   | 7   | 7   | 7   | 7   |
| 2061 | 0   | 0   | 84  | 2   | 0   | 0   | 84  | 0   | 0   | 0   | 0   | 0   | 0   |
| 2062 | 0   | 0   | 71  | 2   | 0   | 0   | 57  | 0   | 0   | 0   | 0   | 0   | 0   |
| 2063 | 0   | 0   | 66  | 0   | 0   | 0   | 43  | 0   | 0   | 0   | 0   | 0   | 0   |
| 2064 | 0   | 0   | 30  | 0   | 0   | 0   | 9   | 0   | 0   | 0   | 0   | 0   | 0   |
| 2065 | 0   | 0   | 36  | 0   | 0   | 0   | 4   | 0   | 0   | 0   | 0   | 0   | 0   |
| 2066 | 0   | 0   | 18  | 0   | 0   | 0   | 0   | 0   | 0   | 0   | 0   | 0   | 0   |
| 2067 | 0   | 0   | 14  | 0   | 0   | 0   | 0   | 0   | 0   | 0   | 0   | 0   | 0   |
| 2068 | 0   | 0   | 30  | 0   | 0   | 0   | 0   | 0   | 0   | 0   | 0   | 0   | 0   |
| 2069 | 0   | 0   | 13  | 0   | 0   | 0   | 0   | 0   | 0   | 0   | 0   | 0   | 0   |
| 2070 | 0   | 0   | 11  | 0   | 0   | 0   | 0   | 0   | 0   | 0   | 0   | 0   | 0   |
| 2071 | 0   | 0   | 2   | 0   | 0   | 0   | 0   | 0   | 0   | 0   | 0   | 0   | 0   |
| 2072 | 0   | 0   | 5   | 0   | 0   | 0   | 0   | 0   | 0   | 0   | 0   | 0   | 0   |
| 2073 | 0   | 0   | 1   | 0   | 0   | 0   | 0   | 0   | 0   | 0   | 0   | 0   | 0   |
| 2074 | 0   | 0   | 1   | 0   | 0   | 0   | 0   | 0   | 0   | 0   | 0   | 0   | 0   |
| 2075 | 0   | 0   | 3   | 0   | 0   | 0   | 0   | 0   | 0   | 0   | 0   | 0   | 0   |
| 2076 | 0   | 0   | 0   | 0   | 0   | 0   | 0   | 0   | 0   | 0   | 0   | 0   | 0   |
| 2077 | 0   | 0   | 0   | 0   | 0   | 0   | 0   | 0   | 0   | 0   | 0   | 0   | 0   |
| 2078 | 0   | 0   | 0   | 0   | 0   | 0   | 0   | 0   | 0   | 0   | 0   | 0   | 0   |
| 2079 | 0   | 0   | 0   | 0   | 0   | 0   | 0   | 0   | 0   | 0   | 0   | 0   | 0   |
| 2080 | 0   | 0   | 0   | 0   | 0   | 0   | 0   | 0   | 0   | 0   | 0   | 0   | 0   |
| 2081 | 0   | 0   | 0   | 0   | 0   | 0   | 0   | 0   | 0   | 0   | 0   | 0   | 0   |
| 2082 | 0   | 0   | 0   | 0   | 0   | 0   | 0   | 0   | 0   | 0   | 0   | 0   | 0   |
| 2083 | 0   | 0   | 0   | 0   | 0   | 0   | 0   | 0   | 0   | 0   | 0   | 0   | 0   |
| 2084 | 0   | 0   | 0   | 0   | 0   | 0   | 0   | 0   | 0   | 0   | 0   | 0   | 0   |
| 2085 | 0   | 0   | 0   | 0   | 0   | 0   | 0   | 0   | 0   | 0   | 0   | 0   | 0   |
| 2086 | 0   | 0   | 0   | 0   | 0   | 0   | 0   | 0   | 0   | 0   | 0   | 0   | 0   |
| 2087 | 0   | 0   | 0   | 0   | 0   | 0   | 0   | 0   | 0   | 0   | 0   | 0   | 0   |
| 2088 | 0   | 0   | 0   | 0   | 0   | 0   | 0   | 0   | 0   | 0   | 0   | 0   | 0   |
| 2089 | 0   | 0   | 0   | 0   | 0   | 0   | 0   | 0   | 0   | 0   | 0   | 0   | 0   |



| Year | 118 | 119 | 120 | 121 | 122 | 123 | 124 | 125 | 126 | 127 | 128 | 129 | 130 |
|------|-----|-----|-----|-----|-----|-----|-----|-----|-----|-----|-----|-----|-----|
| 2002 |     |     |     |     |     |     |     |     |     |     |     |     |     |
| 2003 | 0   | 0   | 0   | 0   | 0   | 0   | 0   | 0   | 0   | 0   | 0   | 0   | 0   |
| 2004 | 0   | 0   | 0   | 0   | 0   | 0   | 0   | 0   | 0   | 0   | 0   | 0   | 0   |
| 2005 | 0   | 0   | 0   | 0   | 0   | 0   | 0   | 0   | 0   | 0   | 0   | 0   | 0   |
| 2006 | 0   | 0   | 0   | 0   | 0   | 0   | 0   | 0   | 0   | 0   | 0   | 0   | 0   |
| 2007 | 0   | 0   | 0   | 0   | 0   | 0   | 0   | 0   | 0   | 0   | 0   | 0   | 0   |
| 2008 | 0   | 0   | 0   | 0   | 0   | 0   | 0   | 0   | 0   | 0   | 0   | 0   | 0   |
| 2009 | 0   | 0   | 0   | 0   | 0   | 0   | 0   | 0   | 0   | 0   | 0   | 0   | 0   |
| 2010 | 0   | 0   | 0   | 0   | 0   | 0   | 0   | 0   | 0   | 0   | 0   | 0   | 0   |
| 2011 | 0   | 0   | 0   | 0   | 0   | 0   | 0   | 0   | 0   | 0   | 0   | 0   | 0   |
| 2012 | 0   | 0   | 0   | 0   | 0   | 0   | 0   | 0   | 0   | 0   | 0   | 0   | 0   |
| 2013 | 0   | 0   | 0   | 0   | 0   | 0   | 0   | 0   | 0   | 0   | 0   | 0   | 0   |
| 2014 | 0   | 0   | 0   | 0   | 0   | 0   | 0   | 0   | 0   | 0   | 0   | 0   | 0   |
| 2015 | 0   | 0   | 0   | 0   | 0   | 0   | 0   | 0   | 0   | 0   | 0   | 0   | 0   |
| 2016 | 0   | 0   | 0   | 0   | 0   | 0   | 0   | 0   | 0   | 0   | 0   | 0   | 0   |
| 2017 | 0   | 0   | 0   | 0   | 0   | 0   | 0   | 0   | 0   | 0   | 0   | 0   | 0   |
| 2018 | 0   | 0   | 0   | 0   | 0   | 0   | 0   | 0   | 0   | 0   | 0   | 0   | 0   |
| 2019 | 0   | 0   | 0   | 0   | 0   | 0   | 0   | 0   | 0   | 0   | 0   | 0   | 0   |
| 2020 | 0   | 0   | 0   | 79  | 0   | 0   | 0   | 0   | 0   | 0   | 0   | 0   | 9   |
| 2021 | 0   | 0   | 0   | 87  | 0   | 0   | 0   | 0   | 0   | 0   | 0   | 0   | 17  |
| 2022 | 0   | 0   | 0   | 142 | 0   | 0   | 0   | 0   | 0   | 0   | 0   | 0   | 44  |
| 2023 | 0   | 0   | 0   | 213 | 0   | 0   | 0   | 0   | 0   | 0   | 0   | 0   | 67  |
| 2024 | 0   | 0   | 0   | 272 | 0   | 0   | 0   | 0   | 0   | 0   | 0   | 0   | 94  |
| 2025 | 62  | 62  | 0   | 200 | 56  | 153 | 215 | 4   | 62  | 15  | 15  | 0   | 120 |
| 2026 | 93  | 93  | 0   | 259 | 86  | 141 | 209 | 22  | 93  | 30  | 30  | 0   | 193 |
| 2027 | 104 | 113 | 0   | 233 | 104 | 195 | 218 | 12  | 104 | 45  | 49  | 0   | 218 |
| 2028 | 176 | 176 | 0   | 276 | 126 | 185 | 204 | 36  | 176 | 46  | 48  | 0   | 287 |
| 2029 | 187 | 190 | 0   | 247 | 151 | 188 | 211 | 52  | 192 | 95  | 95  | 0   | 249 |
| 2030 | 229 | 236 | 58  | 241 | 179 | 212 | 213 | 55  | 229 | 134 | 135 | 9   | 296 |
| 2031 | 284 | 295 | 95  | 231 | 265 | 213 | 195 | 82  | 283 | 154 | 164 | 35  | 240 |
| 2032 | 226 | 244 | 112 | 219 | 225 | 236 | 217 | 83  | 241 | 175 | 196 | 60  | 273 |
| 2033 | 256 | 276 | 138 | 198 | 305 | 232 | 215 | 169 | 262 | 212 | 231 | 72  | 227 |
| 2034 | 226 | 237 | 177 | 177 | 287 | 214 | 211 | 132 | 227 | 291 | 303 | 138 | 281 |
| 2035 | 195 | 215 | 234 | 167 | 261 | 207 | 217 | 134 | 211 | 295 | 302 | 140 | 236 |
| 2036 | 225 | 260 | 258 | 163 | 199 | 179 | 158 | 125 | 226 | 276 | 285 | 138 | 252 |
| 2037 | 183 | 206 | 254 | 154 | 156 | 226 | 175 | 193 | 205 | 270 | 287 | 176 | 252 |
| 2038 | 159 | 169 | 240 | 142 | 152 | 241 | 174 | 182 | 165 | 257 | 286 | 210 | 224 |
| 2039 | 180 | 191 | 198 | 119 | 162 | 184 | 181 | 214 | 182 | 223 | 258 | 280 | 224 |
| 2040 | 219 | 238 | 228 | 114 | 189 | 212 | 210 | 221 | 222 | 240 | 243 | 308 | 190 |
| 2041 | 191 | 215 | 230 | 159 | 178 | 229 | 219 | 247 | 197 | 212 | 230 | 297 | 240 |
| 2042 | 205 | 244 | 279 | 122 | 185 | 276 | 217 | 293 | 233 | 253 | 278 | 247 | 234 |
| 2043 | 219 | 257 | 249 | 154 | 164 | 232 | 197 | 298 | 224 | 242 | 281 | 256 | 260 |
| 2044 | 173 | 192 | 259 | 104 | 185 | 175 | 179 | 282 | 192 | 231 | 257 | 253 | 205 |
| 2045 | 106 | 156 | 224 | 106 | 193 | 196 | 148 | 274 | 138 | 278 | 299 | 283 | 190 |
| 2046 | 136 | 162 | 205 | 104 | 172 | 144 | 133 | 198 | 152 | 221 | 222 | 260 | 120 |
| 2047 | 109 | 117 | 169 | 85  | 112 | 166 | 100 | 186 | 105 | 183 | 239 | 219 | 151 |
| 2048 | 88  | 103 | 154 | 84  | 168 | 131 | 96  | 169 | 97  | 168 | 297 | 249 | 162 |
| 2049 | 104 | 84  | 207 | 52  | 178 | 122 | 89  | 242 | 104 | 211 | 215 | 244 | 142 |
| 2050 | 98  | 207 | 203 | 111 | 185 | 116 | 161 | 252 | 178 | 122 | 206 | 248 | 108 |
| 2051 | 140 | 169 | 185 | 118 | 139 | 104 | 147 | 223 | 157 | 101 | 191 | 224 | 75  |
| 2052 | 81  | 173 | 141 | 156 | 132 | 150 | 110 | 159 | 124 | 63  | 190 | 193 | 41  |
| 2053 | 63  | 161 | 152 | 117 | 122 | 162 | 103 | 147 | 104 | 98  | 199 | 162 | 31  |
| 2054 | 49  | 197 | 144 | 79  | 159 | 154 | 140 | 197 | 115 | 155 | 185 | 202 | 32  |
| 2055 | 128 | 194 | 118 | 70  | 177 | 130 | 165 | 245 | 177 | 61  | 113 | 141 | 34  |
| 2056 | 104 | 140 | 103 | 60  | 142 | 89  | 116 | 146 | 134 | 50  | 75  | 137 | 31  |
| 2057 | 71  | 99  | 170 | 62  | 115 | 62  | 77  | 117 | 104 | 43  | 49  | 143 | 33  |
| 2058 | 31  | 58  | 161 | 44  | 53  | 17  | 40  | 92  | 54  | 33  | 27  | 161 | 24  |
| 2059 | 59  | 49  | 157 | 54  | 56  | 13  | 34  | 86  | 66  | 29  | 23  | 173 | 28  |

| Year | 118 | 119 | 120 | 121 | 122 | 123 | 124 | 125 | 126 | 127 | 128 | 129 | 130 |
|------|-----|-----|-----|-----|-----|-----|-----|-----|-----|-----|-----|-----|-----|
| 2060 | 46  | 46  | 119 | 38  | 29  | 2   | 18  | 58  | 40  | 6   | 13  | 106 | 20  |
| 2061 | 49  | 35  | 63  | 43  | 28  | 0   | 11  | 57  | 43  | 8   | 8   | 73  | 14  |
| 2062 | 35  | 38  | 59  | 43  | 24  | 0   | 2   | 35  | 33  | 18  | 16  | 56  | 14  |
| 2063 | 37  | 39  | 48  | 37  | 26  | 0   | 0   | 42  | 38  | 2   | 2   | 41  | 0   |
| 2064 | 29  | 25  | 43  | 33  | 28  | 0   | 0   | 26  | 27  | 0   | 0   | 42  | 0   |
| 2065 | 7   | 7   | 27  | 7   | 29  | 0   | 0   | 43  | 7   | 0   | 0   | 34  | 0   |
| 2066 | 0   | 0   | 13  | 0   | 20  | 0   | 0   | 25  | 0   | 0   | 0   | 5   | 0   |
| 2067 | 0   | 0   | 0   | 0   | 17  | 0   | 0   | 25  | 0   | 0   | 0   | 0   | 0   |
| 2068 | 0   | 0   | 0   | 0   | 8   | 0   | 0   | 29  | 0   | 0   | 0   | 0   | 0   |
| 2069 | 0   | 0   | 0   | 0   | 0   | 0   | 0   | 18  | 0   | 0   | 0   | 0   | 0   |
| 2070 | 0   | 0   | 0   | 0   | 0   | 0   | 0   | 26  | 0   | 0   | 0   | 0   | 0   |
| 2071 | 0   | 0   | 0   | 0   | 0   | 0   | 0   | 12  | 0   | 0   | 0   | 0   | 0   |
| 2072 | 0   | 0   | 0   | 0   | 0   | 0   | 0   | 32  | 0   | 0   | 0   | 0   | 0   |
| 2073 | 0   | 0   | 0   | 0   | 0   | 0   | 0   | 24  | 0   | 0   | 0   | 0   | 0   |
| 2074 | 0   | 0   | 0   | 0   | 0   | 0   | 0   | 27  | 0   | 0   | 0   | 0   | 0   |
| 2075 | 0   | 0   | 0   | 0   | 0   | 0   | 0   | 38  | 0   | 0   | 0   | 0   | 0   |
| 2076 | 0   | 0   | 0   | 0   | 0   | 0   | 0   | 27  | 0   | 0   | 0   | 0   | 0   |
| 2077 | 0   | 0   | 0   | 0   | 0   | 0   | 0   | 28  | 0   | 0   | 0   | 0   | 0   |
| 2078 | 0   | 0   | 0   | 0   | 0   | 0   | 0   | 11  | 0   | 0   | 0   | 0   | 0   |
| 2079 | 0   | 0   | 0   | 0   | 0   | 0   | 0   | 0   | 0   | 0   | 0   | 0   | 0   |
| 2080 | 0   | 0   | 0   | 0   | 0   | 0   | 0   | 0   | 0   | 0   | 0   | 0   | 0   |
| 2081 | 0   | 0   | 0   | 0   | 0   | 0   | 0   | 0   | 0   | 0   | 0   | 0   | 0   |
| 2082 | 0   | 0   | 0   | 0   | 0   | 0   | 0   | 0   | 0   | 0   | 0   | 0   | 0   |
| 2083 | 0   | 0   | 0   | 0   | 0   | 0   | 0   | 0   | 0   | 0   | 0   | 0   | 0   |
| 2084 | 0   | 0   | 0   | 0   | 0   | 0   | 0   | 0   | 0   | 0   | 0   | 0   | 0   |
| 2085 | 0   | 0   | 0   | 0   | 0   | 0   | 0   | 0   | 0   | 0   | 0   | 0   | 0   |
| 2086 | 0   | 0   | 0   | 0   | 0   | 0   | 0   | 0   | 0   | 0   | 0   | 0   | 0   |
| 2087 | 0   | 0   | 0   | 0   | 0   | 0   | 0   | 0   | 0   | 0   | 0   | 0   | 0   |
| 2088 | 0   | 0   | 0   | 0   | 0   | 0   | 0   | 0   | 0   | 0   | 0   | 0   | 0   |
| 2089 | 0   | 0   | 0   | 0   | 0   | 0   | 0   | 0   | 0   | 0   | 0   | 0   | 0   |

| Year | 131 | 132 | 133 | 134 | 135 | 136 | 137 | 138 | 139 | 140 | 141 | 142 | 143 |
|------|-----|-----|-----|-----|-----|-----|-----|-----|-----|-----|-----|-----|-----|
| 2002 |     |     |     |     |     |     |     |     |     |     |     |     |     |
| 2003 | 0   | 0   | 0   | 0   | 0   | 0   | 0   | 0   | 0   | 0   | 0   | 0   | 0   |
| 2004 | 0   | 0   | 0   | 0   | 0   | 0   | 0   | 0   | 0   | 0   | 0   | 0   | 0   |
| 2005 | 0   | 0   | 0   | 0   | 0   | 0   | 0   | 0   | 0   | 0   | 0   | 0   | 0   |
| 2006 | 0   | 0   | 0   | 0   | 0   | 0   | 0   | 0   | 0   | 0   | 0   | 0   | 0   |
| 2007 | 0   | 0   | 0   | 0   | 0   | 0   | 0   | 0   | 0   | 0   | 0   | 0   | 0   |
| 2008 | 0   | 0   | 0   | 0   | 0   | 0   | 0   | 0   | 0   | 0   | 0   | 0   | 0   |
| 2009 | 0   | 0   | 0   | 0   | 0   | 0   | 0   | 0   | 0   | 0   | 0   | 0   | 0   |
| 2010 | 0   | 0   | 0   | 0   | 0   | 0   | 0   | 0   | 0   | 0   | 0   | 0   | 0   |
| 2011 | 0   | 0   | 0   | 0   | 0   | 0   | 0   | 0   | 0   | 0   | 0   | 0   | 0   |
| 2012 | 0   | 0   | 0   | 0   | 0   | 0   | 0   | 0   | 0   | 0   | 0   | 0   | 0   |
| 2013 | 0   | 0   | 0   | 0   | 0   | 0   | 0   | 0   | 0   | 0   | 0   | 0   | 0   |
| 2014 | 0   | 0   | 0   | 0   | 0   | 0   | 0   | 0   | 0   | 0   | 0   | 0   | 0   |
| 2015 | 0   | 0   | 0   | 0   | 0   | 0   | 0   | 0   | 0   | 0   | 0   | 0   | 0   |
| 2016 | 0   | 0   | 0   | 0   | 0   | 0   | 0   | 0   | 0   | 0   | 0   | 0   | 0   |
| 2017 | 0   | 0   | 0   | 0   | 0   | 0   | 0   | 0   | 0   | 0   | 0   | 0   | 0   |
| 2018 | 0   | 0   | 0   | 0   | 0   | 0   | 0   | 0   | 0   | 0   | 0   | 0   | 0   |
| 2019 | 0   | 0   | 0   | 0   | 0   | 0   | 0   | 0   | 0   | 0   | 0   | 0   | 0   |
| 2020 | 0   | 0   | 0   | 0   | 0   | 0   | 0   | 0   | 224 | 0   | 0   | 0   | 0   |
| 2021 | 0   | 0   | 0   | 0   | 0   | 0   | 0   | 0   | 183 | 0   | 0   | 0   | 0   |
| 2022 | 0   | 0   | 0   | 0   | 0   | 0   | 0   | 0   | 209 | 0   | 0   | 0   | 0   |
| 2023 | 0   | 0   | 0   | 0   | 0   | 0   | 0   | 0   | 220 | 0   | 0   | 0   | 0   |
| 2024 | 0   | 0   | 0   | 0   | 0   | 0   | 0   | 0   | 229 | 0   | 0   | 0   | 0   |
| 2025 | 11  | 55  | 56  | 1   | 15  | 225 | 225 | 0   | 221 | 225 | 225 | 225 | 225 |
| 2026 | 11  | 107 | 117 | 5   | 30  | 172 | 209 | 0   | 248 | 195 | 195 | 195 | 195 |
| 2027 | 17  | 115 | 179 | 7   | 45  | 187 | 248 | 0   | 226 | 206 | 206 | 206 | 206 |
| 2028 | 35  | 169 | 231 | 14  | 46  | 178 | 231 | 0   | 224 | 211 | 211 | 211 | 211 |
| 2029 | 51  | 224 | 263 | 38  | 95  | 187 | 243 | 0   | 232 | 229 | 229 | 229 | 229 |
| 2030 | 80  | 203 | 223 | 34  | 134 | 218 | 266 | 225 | 281 | 248 | 248 | 248 | 248 |
| 2031 | 127 | 258 | 294 | 31  | 156 | 229 | 245 | 210 | 253 | 239 | 239 | 239 | 239 |
| 2032 | 137 | 218 | 256 | 43  | 182 | 200 | 238 | 189 | 244 | 238 | 238 | 238 | 238 |
| 2033 | 156 | 196 | 240 | 56  | 223 | 208 | 246 | 236 | 243 | 235 | 235 | 235 | 234 |
| 2034 | 158 | 261 | 219 | 72  | 303 | 220 | 268 | 241 | 291 | 232 | 232 | 232 | 228 |
| 2035 | 174 | 205 | 260 | 76  | 304 | 243 | 247 | 276 | 238 | 237 | 237 | 237 | 233 |
| 2036 | 254 | 179 | 220 | 86  | 281 | 224 | 277 | 260 | 321 | 273 | 284 | 273 | 266 |
| 2037 | 337 | 213 | 228 | 92  | 269 | 261 | 253 | 272 | 236 | 270 | 260 | 270 | 243 |
| 2038 | 287 | 201 | 184 | 115 | 264 | 235 | 278 | 249 | 194 | 241 | 269 | 243 | 212 |
| 2039 | 309 | 244 | 208 | 144 | 242 | 285 | 272 | 253 | 246 | 273 | 247 | 275 | 238 |
| 2040 | 282 | 274 | 204 | 145 | 241 | 263 | 273 | 257 | 246 | 262 | 287 | 272 | 198 |
| 2041 | 257 | 255 | 221 | 176 | 230 | 290 | 279 | 257 | 218 | 277 | 273 | 296 | 265 |
| 2042 | 239 | 326 | 262 | 192 | 257 | 258 | 314 | 236 | 124 | 304 | 305 | 277 | 268 |
| 2043 | 262 | 248 | 222 | 245 | 260 | 320 | 326 | 249 | 34  | 257 | 274 | 314 | 306 |
| 2044 | 281 | 217 | 250 | 277 | 245 | 283 | 294 | 235 | 89  | 333 | 297 | 318 | 269 |
| 2045 | 262 | 255 | 199 | 273 | 293 | 18  | 38  | 312 | 44  | 22  | 48  | 9   | 86  |
| 2046 | 233 | 204 | 185 | 332 | 225 | 49  | 125 | 286 | 53  | 118 | 26  | 94  | 116 |
| 2047 | 281 | 174 | 110 | 361 | 215 | 74  | 156 | 277 | 66  | 104 | 98  | 101 | 144 |
| 2048 | 283 | 153 | 171 | 354 | 267 | 61  | 162 | 65  | 38  | 100 | 111 | 97  | 129 |
| 2049 | 246 | 129 | 144 | 321 | 210 | 50  | 117 | 19  | 6   | 96  | 108 | 81  | 99  |
| 2050 | 178 | 133 | 95  | 341 | 146 | 54  | 92  | 97  | 20  | 74  | 65  | 73  | 109 |
| 2051 | 150 | 103 | 72  | 260 | 142 | 29  | 78  | 143 | 0   | 57  | 65  | 66  | 95  |
| 2052 | 151 | 186 | 101 | 231 | 132 | 33  | 67  | 154 | 0   | 41  | 65  | 50  | 77  |
| 2053 | 140 | 172 | 156 | 356 | 181 | 39  | 26  | 110 | 0   | 45  | 55  | 40  | 58  |
| 2054 | 181 | 134 | 140 | 295 | 178 | 5   | 0   | 70  | 0   | 15  | 32  | 2   | 20  |
| 2055 | 189 | 77  | 81  | 231 | 93  | 11  | 19  | 105 | 0   | 11  | 2   | 12  | 22  |
| 2056 | 104 | 54  | 55  | 189 | 69  | 0   | 1   | 101 | 0   | 2   | 11  | 4   | 11  |
| 2057 | 119 | 23  | 39  | 160 | 56  | 5   | 0   | 70  | 0   | 3   | 0   | 0   | 15  |
| 2058 | 58  | 11  | 18  | 97  | 25  | 0   | 0   | 73  | 0   | 2   | 0   | 0   | 7   |
| 2059 | 36  | 3   | 11  | 71  | 22  | 0   | 0   | 56  | 0   | 0   | 0   | 0   | 4   |

| Year | 131 | 132 | 133 | 134 | 135 | 136 | 137 | 138 | 139 | 140 | 141 | 142 | 143 |
|------|-----|-----|-----|-----|-----|-----|-----|-----|-----|-----|-----|-----|-----|
| 2060 | 23  | 1   | 0   | 84  | 7   | 0   | 0   | 42  | 0   | 0   | 0   | 0   | 0   |
| 2061 | 7   | 3   | 0   | 66  | 6   | 0   | 0   | 29  | 0   | 0   | 0   | 0   | 0   |
| 2062 | 9   | 0   | 0   | 58  | 15  | 0   | 0   | 9   | 0   | 0   | 0   | 0   | 0   |
| 2063 | 8   | 0   | 0   | 57  | 2   | 0   | 0   | 0   | 0   | 0   | 0   | 0   | 0   |
| 2064 | 11  | 0   | 0   | 47  | 0   | 0   | 0   | 0   | 0   | 0   | 0   | 0   | 0   |
| 2065 | 11  | 0   | 0   | 47  | 0   | 0   | 0   | 0   | 0   | 0   | 0   | 0   | 0   |
| 2066 | 9   | 0   | 0   | 19  | 0   | 0   | 0   | 0   | 0   | 0   | 0   | 0   | 0   |
| 2067 | 11  | 0   | 0   | 19  | 0   | 0   | 0   | 0   | 0   | 0   | 0   | 0   | 0   |
| 2068 | 0   | 0   | 0   | 19  | 0   | 0   | 0   | 0   | 0   | 0   | 0   | 0   | 0   |
| 2069 | 0   | 0   | 0   | 11  | 0   | 0   | 0   | 0   | 0   | 0   | 0   | 0   | 0   |
| 2070 | 0   | 0   | 0   | 10  | 0   | 0   | 0   | 0   | 0   | 0   | 0   | 0   | 0   |
| 2071 | 0   | 0   | 0   | 6   | 0   | 0   | 0   | 0   | 0   | 0   | 0   | 0   | 0   |
| 2072 | 0   | 0   | 0   | 12  | 0   | 0   | 0   | 0   | 0   | 0   | 0   | 0   | 0   |
| 2073 | 0   | 0   | 0   | 7   | 0   | 0   | 0   | 0   | 0   | 0   | 0   | 0   | 0   |
| 2074 | 0   | 0   | 0   | 6   | 0   | 0   | 0   | 0   | 0   | 0   | 0   | 0   | 0   |
| 2075 | 0   | 0   | 0   | 13  | 0   | 0   | 0   | 0   | 0   | 0   | 0   | 0   | 0   |
| 2076 | 0   | 0   | 0   | 3   | 0   | 0   | 0   | 0   | 0   | 0   | 0   | 0   | 0   |
| 2077 | 0   | 0   | 0   | 0   | 0   | 0   | 0   | 0   | 0   | 0   | 0   | 0   | 0   |
| 2078 | 0   | 0   | 0   | 0   | 0   | 0   | 0   | 0   | 0   | 0   | 0   | 0   | 0   |
| 2079 | 0   | 0   | 0   | 0   | 0   | 0   | 0   | 0   | 0   | 0   | 0   | 0   | 0   |
| 2080 | 0   | 0   | 0   | 0   | 0   | 0   | 0   | 0   | 0   | 0   | 0   | 0   | 0   |
| 2081 | 0   | 0   | 0   | 0   | 0   | 0   | 0   | 0   | 0   | 0   | 0   | 0   | 0   |
| 2082 | 0   | 0   | 0   | 0   | 0   | 0   | 0   | 0   | 0   | 0   | 0   | 0   | 0   |
| 2083 | 0   | 0   | 0   | 0   | 0   | 0   | 0   | 0   | 0   | 0   | 0   | 0   | 0   |
| 2084 | 0   | 0   | 0   | 0   | 0   | 0   | 0   | 0   | 0   | 0   | 0   | 0   | 0   |
| 2085 | 0   | 0   | 0   | 0   | 0   | 0   | 0   | 0   | 0   | 0   | 0   | 0   | 0   |
| 2086 | 0   | 0   | 0   | 0   | 0   | 0   | 0   | 0   | 0   | 0   | 0   | 0   | 0   |
| 2087 | 0   | 0   | 0   | 0   | 0   | 0   | 0   | 0   | 0   | 0   | 0   | 0   | 0   |
| 2088 | 0   | 0   | 0   | 0   | 0   | 0   | 0   | 0   | 0   | 0   | 0   | 0   | 0   |
| 2089 | 0   | 0   | 0   | 0   | 0   | 0   | 0   | 0   | 0   | 0   | 0   | 0   | 0   |

| Year | 144 | 145 | 146 | 147 | 148 | 149 | 150 | 151 | 152 | 153 | 154 | 155 | 156 |
|------|-----|-----|-----|-----|-----|-----|-----|-----|-----|-----|-----|-----|-----|
| 2002 |     |     |     |     |     |     |     |     |     |     |     |     |     |
| 2003 | 0   | 0   | 0   | 0   | 0   | 0   | 0   | 0   | 0   | 0   | 0   | 0   | 0   |
| 2004 | 0   | 0   | 0   | 0   | 0   | 0   | 0   | 0   | 0   | 0   | 0   | 0   | 0   |
| 2005 | 0   | 0   | 0   | 0   | 0   | 0   | 0   | 0   | 0   | 0   | 0   | 0   | 0   |
| 2006 | 0   | 0   | 0   | 0   | 0   | 0   | 0   | 0   | 0   | 0   | 0   | 0   | 0   |
| 2007 | 0   | 0   | 0   | 0   | 0   | 0   | 0   | 0   | 0   | 0   | 0   | 0   | 0   |
| 2008 | 0   | 0   | 0   | 0   | 0   | 0   | 0   | 0   | 0   | 0   | 0   | 0   | 0   |
| 2009 | 0   | 0   | 0   | 0   | 0   | 0   | 0   | 0   | 0   | 0   | 0   | 0   | 0   |
| 2010 | 0   | 0   | 0   | 0   | 0   | 0   | 0   | 0   | 0   | 0   | 0   | 0   | 0   |
| 2011 | 0   | 0   | 0   | 0   | 0   | 0   | 0   | 0   | 0   | 0   | 0   | 0   | 0   |
| 2012 | 0   | 0   | 0   | 0   | 0   | 0   | 0   | 0   | 0   | 0   | 0   | 0   | 0   |
| 2013 | 0   | 0   | 0   | 0   | 0   | 0   | 0   | 0   | 0   | 0   | 0   | 0   | 0   |
| 2014 | 0   | 0   | 0   | 0   | 0   | 0   | 0   | 0   | 0   | 0   | 0   | 0   | 0   |
| 2015 | 0   | 0   | 0   | 0   | 0   | 0   | 0   | 0   | 0   | 0   | 0   | 0   | 0   |
| 2016 | 0   | 0   | 0   | 0   | 0   | 0   | 0   | 0   | 0   | 0   | 0   | 0   | 0   |
| 2017 | 0   | 0   | 0   | 0   | 0   | 0   | 0   | 0   | 0   | 0   | 0   | 0   | 0   |
| 2018 | 0   | 0   | 0   | 0   | 0   | 0   | 0   | 0   | 0   | 0   | 0   | 0   | 0   |
| 2019 | 0   | 0   | 0   | 0   | 0   | 0   | 0   | 0   | 0   | 0   | 0   | 0   | 0   |
| 2020 | 0   | 0   | 0   | 0   | 79  | 0   | 0   | 0   | 0   | 0   | 0   | 0   | 0   |
| 2021 | 0   | 0   | 0   | 0   | 65  | 0   | 0   | 0   | 0   | 0   | 0   | 0   | 0   |
| 2022 | 0   | 0   | 0   | 0   | 154 | 0   | 0   | 0   | 0   | 0   | 0   | 0   | 0   |
| 2023 | 0   | 0   | 0   | 0   | 228 | 0   | 0   | 0   | 0   | 0   | 0   | 0   | 0   |
| 2024 | 0   | 0   | 0   | 0   | 257 | 0   | 0   | 0   | 0   | 0   | 0   | 0   | 0   |
| 2025 | 225 | 62  | 62  | 0   | 209 | 56  | 153 | 215 | 4   | 62  | 15  | 15  | 0   |
| 2026 | 195 | 54  | 123 | 0   | 282 | 69  | 137 | 189 | 7   | 89  | 4   | 63  | 0   |
| 2027 | 206 | 93  | 135 | 0   | 249 | 91  | 214 | 207 | 9   | 113 | 36  | 68  | 0   |
| 2028 | 211 | 166 | 257 | 0   | 283 | 156 | 242 | 251 | 14  | 218 | 34  | 114 | 0   |
| 2029 | 229 | 191 | 247 | 0   | 268 | 203 | 247 | 277 | 56  | 240 | 114 | 179 | 0   |
| 2030 | 248 | 222 | 271 | 58  | 284 | 203 | 226 | 246 | 87  | 243 | 125 | 189 | 9   |
| 2031 | 239 | 320 | 329 | 125 | 246 | 304 | 226 | 252 | 119 | 315 | 189 | 196 | 70  |
| 2032 | 238 | 237 | 271 | 111 | 258 | 249 | 231 | 243 | 98  | 236 | 242 | 280 | 86  |
| 2033 | 235 | 242 | 285 | 156 | 210 | 308 | 234 | 231 | 129 | 266 | 204 | 240 | 92  |
| 2034 | 232 | 287 | 306 | 240 | 237 | 333 | 270 | 270 | 199 | 300 | 296 | 317 | 184 |
| 2035 | 237 | 256 | 288 | 307 | 225 | 314 | 246 | 262 | 167 | 271 | 262 | 292 | 219 |
| 2036 | 273 | 288 | 295 | 329 | 173 | 264 | 258 | 230 | 209 | 288 | 272 | 298 | 227 |
| 2037 | 270 | 238 | 243 | 309 | 214 | 229 | 238 | 207 | 229 | 252 | 268 | 255 | 220 |
| 2038 | 243 | 210 | 213 | 292 | 177 | 217 | 261 | 197 | 253 | 209 | 325 | 352 | 259 |
| 2039 | 275 | 218 | 213 | 257 | 136 | 235 | 218 | 209 | 250 | 220 | 308 | 306 | 292 |
| 2040 | 272 | 212 | 201 | 231 | 135 | 226 | 231 | 207 | 285 | 210 | 263 | 267 | 305 |
| 2041 | 293 | 187 | 200 | 291 | 163 | 227 | 246 | 237 | 269 | 206 | 266 | 277 | 340 |
| 2042 | 271 | 236 | 234 | 304 | 157 | 222 | 260 | 221 | 263 | 239 | 307 | 290 | 253 |
| 2043 | 303 | 209 | 246 | 269 | 196 | 183 | 194 | 184 | 262 | 226 | 295 | 295 | 294 |
| 2044 | 304 | 161 | 177 | 250 | 126 | 160 | 176 | 159 | 220 | 173 | 235 | 243 | 283 |
| 2045 | 21  | 129 | 150 | 214 | 68  | 170 | 191 | 153 | 238 | 153 | 287 | 311 | 297 |
| 2046 | 105 | 186 | 168 | 231 | 59  | 163 | 211 | 132 | 238 | 163 | 175 | 205 | 243 |
| 2047 | 113 | 100 | 123 | 212 | 80  | 82  | 139 | 139 | 219 | 109 | 141 | 144 | 292 |
| 2048 | 100 | 67  | 60  | 182 | 110 | 92  | 53  | 38  | 178 | 55  | 172 | 261 | 225 |
| 2049 | 83  | 61  | 149 | 71  | 115 | 106 | 125 | 71  | 261 | 85  | 146 | 257 | 224 |
| 2050 | 73  | 84  | 216 | 53  | 55  | 152 | 124 | 112 | 223 | 137 | 168 | 267 | 193 |
| 2051 | 66  | 96  | 211 | 118 | 58  | 178 | 180 | 170 | 252 | 187 | 137 | 208 | 193 |
| 2052 | 50  | 130 | 189 | 149 | 67  | 178 | 137 | 146 | 230 | 168 | 67  | 122 | 207 |
| 2053 | 40  | 96  | 142 | 178 | 54  | 112 | 84  | 91  | 181 | 111 | 58  | 81  | 232 |
| 2054 | 2   | 59  | 78  | 201 | 41  | 91  | 53  | 85  | 174 | 98  | 48  | 63  | 258 |
| 2055 | 12  | 49  | 62  | 204 | 48  | 74  | 46  | 41  | 134 | 69  | 33  | 36  | 187 |
| 2056 | 4   | 36  | 32  | 159 | 37  | 47  | 27  | 18  | 61  | 33  | 31  | 45  | 133 |
| 2057 | 0   | 48  | 51  | 138 | 49  | 48  | 15  | 11  | 56  | 44  | 16  | 17  | 91  |
| 2058 | 0   | 23  | 26  | 75  | 30  | 21  | 0   | 9   | 65  | 28  | 2   | 3   | 69  |
| 2059 | 0   | 22  | 26  | 61  | 32  | 30  | 0   | 2   | 59  | 23  | 5   | 4   | 29  |

| Year | 144 | 145 | 146 | 147 | 148 | 149 | 150 | 151 | 152 | 153 | 154 | 155 | 156 |
|------|-----|-----|-----|-----|-----|-----|-----|-----|-----|-----|-----|-----|-----|
| 2060 | 0   | 20  | 18  | 27  | 24  | 27  | 0   | 0   | 31  | 19  | 1   | 1   | 18  |
| 2061 | 0   | 26  | 21  | 20  | 18  | 15  | 0   | 0   | 51  | 21  | 6   | 4   | 11  |
| 2062 | 0   | 28  | 26  | 27  | 6   | 22  | 0   | 0   | 43  | 26  | 2   | 4   | 10  |
| 2063 | 0   | 14  | 12  | 24  | 0   | 21  | 0   | 0   | 47  | 12  | 0   | 0   | 1   |
| 2064 | 0   | 11  | 13  | 11  | 0   | 21  | 0   | 0   | 30  | 13  | 0   | 0   | 0   |
| 2065 | 0   | 0   | 0   | 6   | 0   | 17  | 0   | 0   | 45  | 0   | 0   | 0   | 1   |
| 2066 | 0   | 0   | 0   | 2   | 0   | 14  | 0   | 0   | 28  | 0   | 0   | 0   | 0   |
| 2067 | 0   | 0   | 0   | 0   | 0   | 11  | 0   | 0   | 30  | 0   | 0   | 0   | 0   |
| 2068 | 0   | 0   | 0   | 0   | 0   | 6   | 0   | 0   | 24  | 0   | 0   | 0   | 0   |
| 2069 | 0   | 0   | 0   | 0   | 0   | 0   | 0   | 0   | 15  | 0   | 0   | 0   | 0   |
| 2070 | 0   | 0   | 0   | 0   | 0   | 0   | 0   | 0   | 29  | 0   | 0   | 0   | 0   |
| 2071 | 0   | 0   | 0   | 0   | 0   | 0   | 0   | 0   | 19  | 0   | 0   | 0   | 0   |
| 2072 | 0   | 0   | 0   | 0   | 0   | 0   | 0   | 0   | 22  | 0   | 0   | 0   | 0   |
| 2073 | 0   | 0   | 0   | 0   | 0   | 0   | 0   | 0   | 17  | 0   | 0   | 0   | 0   |
| 2074 | 0   | 0   | 0   | 0   | 0   | 0   | 0   | 0   | 21  | 0   | 0   | 0   | 0   |
| 2075 | 0   | 0   | 0   | 0   | 0   | 0   | 0   | 0   | 25  | 0   | 0   | 0   | 0   |
| 2076 | 0   | 0   | 0   | 0   | 0   | 0   | 0   | 0   | 12  | 0   | 0   | 0   | 0   |
| 2077 | 0   | 0   | 0   | 0   | 0   | 0   | 0   | 0   | 14  | 0   | 0   | 0   | 0   |
| 2078 | 0   | 0   | 0   | 0   | 0   | 0   | 0   | 0   | 0   | 0   | 0   | 0   | 0   |
| 2079 | 0   | 0   | 0   | 0   | 0   | 0   | 0   | 0   | 0   | 0   | 0   | 0   | 0   |
| 2080 | 0   | 0   | 0   | 0   | 0   | 0   | 0   | 0   | 0   | 0   | 0   | 0   | 0   |
| 2081 | 0   | 0   | 0   | 0   | 0   | 0   | 0   | 0   | 0   | 0   | 0   | 0   | 0   |
| 2082 | 0   | 0   | 0   | 0   | 0   | 0   | 0   | 0   | 0   | 0   | 0   | 0   | 0   |
| 2083 | 0   | 0   | 0   | 0   | 0   | 0   | 0   | 0   | 0   | 0   | 0   | 0   | 0   |
| 2084 | 0   | 0   | 0   | 0   | 0   | 0   | 0   | 0   | 0   | 0   | 0   | 0   | 0   |
| 2085 | 0   | 0   | 0   | 0   | 0   | 0   | 0   | 0   | 0   | 0   | 0   | 0   | 0   |
| 2086 | 0   | 0   | 0   | 0   | 0   | 0   | 0   | 0   | 0   | 0   | 0   | 0   | 0   |
| 2087 | 0   | 0   | 0   | 0   | 0   | 0   | 0   | 0   | 0   | 0   | 0   | 0   | 0   |
| 2088 | 0   | 0   | 0   | 0   | 0   | 0   | 0   | 0   | 0   | 0   | 0   | 0   | 0   |
| 2089 | 0   | 0   | 0   | 0   | 0   | 0   | 0   | 0   | 0   | 0   | 0   | 0   | 0   |

| Year | 157 | 158 | 159 | 160 | 161 | 162 |
|------|-----|-----|-----|-----|-----|-----|
| 2002 |     |     |     |     |     |     |
| 2003 | 0   | 0   | 0   | 0   | 0   | 0   |
| 2004 | 0   | 0   | 0   | 0   | 0   | 0   |
| 2005 | 0   | 0   | 0   | 0   | 0   | 0   |
| 2006 | 0   | 0   | 0   | 0   | 0   | 0   |
| 2007 | 0   | 0   | 0   | 0   | 0   | 0   |
| 2008 | 0   | 0   | 0   | 0   | 0   | 0   |
| 2009 | 0   | 0   | 0   | 0   | 0   | 0   |
| 2010 | 0   | 0   | 0   | 0   | 0   | 0   |
| 2011 | 0   | 0   | 0   | 0   | 0   | 0   |
| 2012 | 0   | 0   | 0   | 0   | 0   | 0   |
| 2013 | 0   | 0   | 0   | 0   | 0   | 0   |
| 2014 | 0   | 0   | 0   | 0   | 0   | 0   |
| 2015 | 0   | 0   | 0   | 0   | 0   | 0   |
| 2016 | 0   | 0   | 0   | 0   | 0   | 0   |
| 2017 | 0   | 0   | 0   | 0   | 0   | 0   |
| 2018 | 0   | 0   | 0   | 0   | 0   | 0   |
| 2019 | 0   | 0   | 0   | 0   | 0   | 0   |
| 2020 | 9   | 0   | 0   | 0   | 0   | 0   |
| 2021 | 12  | 0   | 0   | 0   | 0   | 0   |
| 2022 | 42  | 0   | 0   | 0   | 0   | 0   |
| 2023 | 70  | 0   | 0   | 0   | 0   | 0   |
| 2024 | 122 | 0   | 0   | 0   | 0   | 0   |
| 2025 | 158 | 11  | 55  | 56  | 1   | 15  |
| 2026 | 189 | 7   | 104 | 114 | 1   | 25  |
| 2027 | 236 | 33  | 124 | 195 | 3   | 50  |
| 2028 | 278 | 51  | 243 | 271 | 6   | 97  |
| 2029 | 227 | 98  | 277 | 296 | 13  | 155 |
| 2030 | 274 | 135 | 233 | 231 | 29  | 155 |
| 2031 | 230 | 135 | 259 | 324 | 25  | 184 |
| 2032 | 299 | 133 | 202 | 277 | 51  | 246 |
| 2033 | 271 | 191 | 191 | 244 | 99  | 215 |
| 2034 | 330 | 220 | 277 | 271 | 97  | 317 |
| 2035 | 287 | 205 | 243 | 284 | 103 | 281 |
| 2036 | 292 | 284 | 244 | 285 | 132 | 290 |
| 2037 | 270 | 360 | 244 | 279 | 141 | 256 |
| 2038 | 260 | 275 | 254 | 249 | 151 | 341 |
| 2039 | 234 | 314 | 246 | 239 | 188 | 315 |
| 2040 | 238 | 308 | 290 | 252 | 178 | 274 |
| 2041 | 275 | 348 | 255 | 256 | 235 | 271 |
| 2042 | 281 | 272 | 353 | 304 | 224 | 308 |
| 2043 | 237 | 314 | 286 | 227 | 263 | 298 |
| 2044 | 154 | 274 | 280 | 251 | 251 | 249 |
| 2045 | 157 | 324 | 251 | 214 | 319 | 296 |
| 2046 | 180 | 260 | 108 | 73  | 293 | 181 |
| 2047 | 223 | 221 | 132 | 70  | 342 | 177 |
| 2048 | 107 | 216 | 137 | 123 | 282 | 243 |
| 2049 | 50  | 191 | 156 | 157 | 354 | 226 |
| 2050 | 41  | 224 | 203 | 134 | 360 | 216 |
| 2051 | 42  | 210 | 122 | 88  | 286 | 151 |
| 2052 | 21  | 163 | 84  | 66  | 256 | 91  |
| 2053 | 11  | 135 | 51  | 39  | 276 | 68  |
| 2054 | 13  | 87  | 45  | 18  | 168 | 38  |
| 2055 | 15  | 78  | 24  | 11  | 162 | 28  |
| 2056 | 16  | 24  | 11  | 9   | 150 | 34  |
| 2057 | 20  | 36  | 9   | 2   | 147 | 19  |
| 2058 | 13  | 20  | 0   | 0   | 91  | 1   |
| 2059 | 14  | 7   | 0   | 0   | 90  | 4   |

| Year | 157 | 158 | 159 | 160 | 161 | 162 |
|------|-----|-----|-----|-----|-----|-----|
| 2060 | 1   | 12  | 0   | 0   | 102 | 0   |
| 2061 | 0   | 6   | 0   | 0   | 88  | 3   |
| 2062 | 0   | 4   | 0   | 0   | 75  | 4   |
| 2063 | 0   | 3   | 0   | 0   | 59  | 0   |
| 2064 | 0   | 2   | 0   | 0   | 35  | 0   |
| 2065 | 0   | 1   | 0   | 0   | 35  | 0   |
| 2066 | 0   | 2   | 0   | 0   | 10  | 0   |
| 2067 | 0   | 0   | 0   | 0   | 17  | 0   |
| 2068 | 0   | 0   | 0   | 0   | 30  | 0   |
| 2069 | 0   | 0   | 0   | 0   | 12  | 0   |
| 2070 | 0   | 0   | 0   | 0   | 11  | 0   |
| 2071 | 0   | 0   | 0   | 0   | 1   | 0   |
| 2072 | 0   | 0   | 0   | 0   | 4   | 0   |
| 2073 | 0   | 0   | 0   | 0   | 0   | 0   |
| 2074 | 0   | 0   | 0   | 0   | 2   | 0   |
| 2075 | 0   | 0   | 0   | 0   | 5   | 0   |
| 2076 | 0   | 0   | 0   | 0   | 0   | 0   |
| 2077 | 0   | 0   | 0   | 0   | 0   | 0   |
| 2078 | 0   | 0   | 0   | 0   | 0   | 0   |
| 2079 | 0   | 0   | 0   | 0   | 0   | 0   |
| 2080 | 0   | 0   | 0   | 0   | 0   | 0   |
| 2081 | 0   | 0   | 0   | 0   | 0   | 0   |
| 2082 | 0   | 0   | 0   | 0   | 0   | 0   |
| 2083 | 0   | 0   | 0   | 0   | 0   | 0   |
| 2084 | 0   | 0   | 0   | 0   | 0   | 0   |
| 2085 | 0   | 0   | 0   | 0   | 0   | 0   |
| 2086 | 0   | 0   | 0   | 0   | 0   | 0   |
| 2087 | 0   | 0   | 0   | 0   | 0   | 0   |
| 2088 | 0   | 0   | 0   | 0   | 0   | 0   |
| 2089 | 0   | 0   | 0   | 0   | 0   | 0   |



| Year | 1  | 2  | 3  | 4  | 5  | 6  | 7 | 8   | 9  | 10  | 11  | 12  | 13  |
|------|----|----|----|----|----|----|---|-----|----|-----|-----|-----|-----|
| 2002 |    |    |    |    |    |    |   |     |    |     |     |     |     |
| 2003 | 0  | 0  | 0  | 0  | 0  | 0  | 0 | 0   | 0  | 0   | 0   | 0   | 0   |
| 2004 | 0  | 0  | 0  | 0  | 0  | 0  | 0 | 0   | 0  | 0   | 0   | 0   | 0   |
| 2005 | 0  | 0  | 0  | 0  | 0  | 0  | 0 | 0   | 0  | 0   | 0   | 0   | 0   |
| 2006 | 0  | 0  | 0  | 0  | 0  | 0  | 0 | 0   | 0  | 0   | 0   | 0   | 0   |
| 2007 | 0  | 0  | 0  | 0  | 0  | 0  | 0 | 0   | 0  | 0   | 0   | 0   | 0   |
| 2008 | 0  | 0  | 0  | 0  | 0  | 0  | 0 | 0   | 0  | 0   | 0   | 0   | 0   |
| 2009 | 0  | 0  | 0  | 0  | 0  | 0  | 0 | 0   | 0  | 0   | 0   | 0   | 0   |
| 2010 | 0  | 0  | 0  | 0  | 0  | 0  | 0 | 0   | 0  | 0   | 0   | 0   | 0   |
| 2011 | 0  | 0  | 0  | 0  | 0  | 0  | 0 | 0   | 0  | 0   | 0   | 0   | 0   |
| 2012 | 0  | 0  | 0  | 0  | 0  | 0  | 0 | 0   | 0  | 0   | 0   | 0   | 0   |
| 2013 | 0  | 0  | 0  | 0  | 0  | 0  | 0 | 0   | 0  | 0   | 0   | 0   | 0   |
| 2014 | 0  | 0  | 0  | 0  | 0  | 0  | 0 | 0   | 0  | 0   | 0   | 0   | 0   |
| 2015 | 0  | 0  | 0  | 0  | 0  | 0  | 0 | 0   | 0  | 0   | 0   | 0   | 0   |
| 2016 | 0  | 0  | 0  | 0  | 0  | 0  | 0 | 0   | 0  | 0   | 0   | 0   | 0   |
| 2017 | 0  | 0  | 0  | 0  | 0  | 0  | 0 | 0   | 0  | 0   | 0   | 0   | 0   |
| 2018 | 0  | 0  | 0  | 0  | 0  | 0  | 0 | 0   | 0  | 0   | 0   | 0   | 0   |
| 2019 | 0  | 0  | 0  | 0  | 0  | 0  | 0 | 0   | 0  | 0   | 0   | 0   | 0   |
| 2020 | 0  | 0  | 0  | 0  | 0  | 0  | 0 | 0   | 0  | 0   | 0   | 0   | 141 |
| 2021 | 0  | 0  | 0  | 0  | 0  | 0  | 0 | 0   | 0  | 0   | 0   | 0   | 144 |
| 2022 | 0  | 0  | 0  | 0  | 0  | 0  | 0 | 0   | 0  | 0   | 0   | 0   | 122 |
| 2023 | 0  | 0  | 0  | 0  | 0  | 0  | 0 | 0   | 0  | 0   | 0   | 0   | 122 |
| 2024 | 0  | 0  | 0  | 0  | 0  | 0  | 0 | 0   | 0  | 0   | 0   | 0   | 102 |
| 2025 | 0  | 0  | 0  | 0  | 0  | 0  | 0 | 0   | 0  | 158 | 158 | 0   | 102 |
| 2026 | 0  | 0  | 0  | 0  | 0  | 0  | 0 | 0   | 0  | 142 | 136 | 0   | 85  |
| 2027 | 0  | 0  | 0  | 0  | 0  | 0  | 0 | 0   | 0  | 148 | 150 | 0   | 79  |
| 2028 | 0  | 0  | 0  | 0  | 0  | 0  | 0 | 0   | 0  | 119 | 114 | 0   | 76  |
| 2029 | 0  | 0  | 0  | 0  | 0  | 0  | 0 | 0   | 0  | 119 | 119 | 0   | 61  |
| 2030 | 0  | 0  | 0  | 0  | 0  | 0  | 0 | 0   | 0  | 106 | 105 | 162 | 54  |
| 2031 | 0  | 0  | 0  | 0  | 0  | 0  | 0 | 0   | 0  | 65  | 65  | 131 | 73  |
| 2032 | 0  | 0  | 0  | 1  | 0  | 0  | 0 | 6   | 0  | 65  | 66  | 122 | 40  |
| 2033 | 0  | 0  | 0  | 6  | 0  | 0  | 0 | 4   | 0  | 57  | 62  | 110 | 74  |
| 2034 | 0  | 0  | 0  | 18 | 0  | 0  | 0 | 34  | 0  | 92  | 92  | 105 | 64  |
| 2035 | 0  | 0  | 0  | 4  | 0  | 0  | 0 | 55  | 0  | 82  | 77  | 84  | 70  |
| 2036 | 0  | 1  | 0  | 41 | 2  | 0  | 0 | 92  | 1  | 55  | 55  | 92  | 61  |
| 2037 | 2  | 2  | 0  | 30 | 2  | 1  | 0 | 67  | 2  | 65  | 66  | 85  | 77  |
| 2038 | 3  | 4  | 0  | 51 | 7  | 2  | 0 | 103 | 4  | 55  | 54  | 78  | 43  |
| 2039 | 7  | 14 | 0  | 60 | 15 | 8  | 0 | 91  | 14 | 77  | 76  | 74  | 57  |
| 2040 | 8  | 11 | 0  | 35 | 24 | 17 | 0 | 81  | 11 | 55  | 57  | 100 | 77  |
| 2041 | 33 | 35 | 0  | 35 | 24 | 40 | 0 | 107 | 35 | 71  | 67  | 94  | 64  |
| 2042 | 32 | 27 | 1  | 0  | 50 | 46 | 0 | 105 | 27 | 42  | 45  | 33  | 60  |
| 2043 | 5  | 2  | 4  | 0  | 0  | 9  | 0 | 19  | 2  | 48  | 40  | 48  | 64  |
| 2044 | 0  | 0  | 26 | 0  | 0  | 0  | 0 | 0   | 0  | 35  | 40  | 50  | 73  |
| 2045 | 0  | 0  | 1  | 0  | 0  | 0  | 0 | 0   | 0  | 47  | 46  | 33  | 84  |
| 2046 | 0  | 0  | 0  | 0  | 0  | 0  | 0 | 0   | 0  | 48  | 45  | 48  | 62  |
| 2047 | 0  | 0  | 0  | 0  | 0  | 0  | 0 | 0   | 0  | 68  | 70  | 70  | 70  |
| 2048 | 0  | 0  | 0  | 0  | 0  | 0  | 0 | 0   | 0  | 63  | 63  | 0   | 0   |
| 2049 | 0  | 0  | 0  | 0  | 0  | 0  | 0 | 0   | 0  | 0   | 0   | 0   | 0   |
| 2050 | 0  | 0  | 0  | 0  | 0  | 0  | 0 | 0   | 0  | 0   | 0   | 0   | 0   |
| 2051 | 0  | 0  | 0  | 0  | 0  | 0  | 0 | 0   | 0  | 0   | 0   | 0   | 0   |
| 2052 | 0  | 0  | 0  | 0  | 0  | 0  | 0 | 0   | 0  | 0   | 0   | 0   | 0   |
| 2053 | 0  | 0  | 0  | 0  | 0  | 0  | 0 | 0   | 0  | 0   | 0   | 0   | 0   |
| 2054 | 0  | 0  | 0  | 0  | 0  | 0  | 0 | 0   | 0  | 0   | 0   | 0   | 0   |
| 2055 | 0  | 0  | 0  | 0  | 0  | 0  | 0 | 0   | 0  | 0   | 0   | 0   | 0   |
| 2056 | 0  | 0  | 0  | 0  | 0  | 0  | 0 | 0   | 0  | 0   | 0   | 0   | 0   |
| 2057 | 0  | 0  | 0  | 0  | 0  | 0  | 0 | 0   | 0  | 0   | 0   | 0   | 0   |
| 2058 | 0  | 0  | 0  | 0  | 0  | 0  | 0 | 0   | 0  | 0   | 0   | 0   | 0   |
| 2059 | 0  | 0  | 0  | 0  | 0  | 0  | 0 | 0   | 0  | 0   | 0   | 0   | 0   |

| Year | 1 | 2 | 3 | 4 | 5 | 6 | 7 | 8 | 9 | 10 | 11 | 12 | 13 |
|------|---|---|---|---|---|---|---|---|---|----|----|----|----|
| 2060 | 0 | 0 | 0 | 0 | 0 | 0 | 0 | 0 | 0 | 0  | 0  | 0  | 0  |
| 2061 | 0 | 0 | 0 | 0 | 0 | 0 | 0 | 0 | 0 | 0  | 0  | 0  | 0  |
| 2062 | 0 | 0 | 0 | 0 | 0 | 0 | 0 | 0 | 0 | 0  | 0  | 0  | 0  |
| 2063 | 0 | 0 | 0 | 0 | 0 | 0 | 0 | 0 | 0 | 0  | 0  | 0  | 0  |
| 2064 | 0 | 0 | 0 | 0 | 0 | 0 | 0 | 0 | 0 | 0  | 0  | 0  | 0  |
| 2065 | 0 | 0 | 0 | 0 | 0 | 0 | 0 | 0 | 0 | 0  | 0  | 0  | 0  |
| 2066 | 0 | 0 | 0 | 0 | 0 | 0 | 0 | 0 | 0 | 0  | 0  | 0  | 0  |
| 2067 | 0 | 0 | 0 | 0 | 0 | 0 | 0 | 0 | 0 | 0  | 0  | 0  | 0  |
| 2068 | 0 | 0 | 0 | 0 | 0 | 0 | 0 | 0 | 0 | 0  | 0  | 0  | 0  |
| 2069 | 0 | 0 | 0 | 0 | 0 | 0 | 0 | 0 | 0 | 0  | 0  | 0  | 0  |
| 2070 | 0 | 0 | 0 | 0 | 0 | 0 | 0 | 0 | 0 | 0  | 0  | 0  | 0  |
| 2071 | 0 | 0 | 0 | 0 | 0 | 0 | 0 | 0 | 0 | 0  | 0  | 0  | 0  |
| 2072 | 0 | 0 | 0 | 0 | 0 | 0 | 0 | 0 | 0 | 0  | 0  | 0  | 0  |
| 2073 | 0 | 0 | 0 | 0 | 0 | 0 | 0 | 0 | 0 | 0  | 0  | 0  | 0  |
| 2074 | 0 | 0 | 0 | 0 | 0 | 0 | 0 | 0 | 0 | 0  | 0  | 0  | 0  |
| 2075 | 0 | 0 | 0 | 0 | 0 | 0 | 0 | 0 | 0 | 0  | 0  | 0  | 0  |
| 2076 | 0 | 0 | 0 | 0 | 0 | 0 | 0 | 0 | 0 | 0  | 0  | 0  | 0  |
| 2077 | 0 | 0 | 0 | 0 | 0 | 0 | 0 | 0 | 0 | 0  | 0  | 0  | 0  |
| 2078 | 0 | 0 | 0 | 0 | 0 | 0 | 0 | 0 | 0 | 0  | 0  | 0  | 0  |
| 2079 | 0 | 0 | 0 | 0 | 0 | 0 | 0 | 0 | 0 | 0  | 0  | 0  | 0  |
| 2080 | 0 | 0 | 0 | 0 | 0 | 0 | 0 | 0 | 0 | 0  | 0  | 0  | 0  |
| 2081 | 0 | 0 | 0 | 0 | 0 | 0 | 0 | 0 | 0 | 0  | 0  | 0  | 0  |
| 2082 | 0 | 0 | 0 | 0 | 0 | 0 | 0 | 0 | 0 | 0  | 0  | 0  | 0  |
| 2083 | 0 | 0 | 0 | 0 | 0 | 0 | 0 | 0 | 0 | 0  | 0  | 0  | 0  |
| 2084 | 0 | 0 | 0 | 0 | 0 | 0 | 0 | 0 | 0 | 0  | 0  | 0  | 0  |
| 2085 | 0 | 0 | 0 | 0 | 0 | 0 | 0 | 0 | 0 | 0  | 0  | 0  | 0  |
| 2086 | 0 | 0 | 0 | 0 | 0 | 0 | 0 | 0 | 0 | 0  | 0  | 0  | 0  |
| 2087 | 0 | 0 | 0 | 0 | 0 | 0 | 0 | 0 | 0 | 0  | 0  | 0  | 0  |
| 2088 | 0 | 0 | 0 | 0 | 0 | 0 | 0 | 0 | 0 | 0  | 0  | 0  | 0  |
| 2089 | 0 | 0 | 0 | 0 | 0 | 0 | 0 | 0 | 0 | 0  | 0  | 0  | 0  |

| Year | 14  | 15  | 16 | 17  | 18  | 19  | 20  | 21  | 22  | 23  | 24  | 25  | 26  |
|------|-----|-----|----|-----|-----|-----|-----|-----|-----|-----|-----|-----|-----|
| 2002 |     |     |    |     |     |     |     |     |     |     |     |     |     |
| 2003 | 0   | 0   | 0  | 0   | 0   | 0   | 0   | 0   | 0   | 0   | 0   | 0   | 0   |
| 2004 | 0   | 0   | 0  | 0   | 0   | 0   | 0   | 0   | 0   | 0   | 0   | 0   | 0   |
| 2005 | 0   | 0   | 0  | 0   | 0   | 0   | 0   | 0   | 0   | 0   | 0   | 0   | 0   |
| 2006 | 0   | 0   | 0  | 0   | 0   | 0   | 0   | 0   | 0   | 0   | 0   | 0   | 0   |
| 2007 | 0   | 0   | 0  | 0   | 0   | 0   | 0   | 0   | 0   | 0   | 0   | 0   | 0   |
| 2008 | 0   | 0   | 0  | 0   | 0   | 0   | 0   | 0   | 0   | 0   | 0   | 0   | 0   |
| 2009 | 0   | 0   | 0  | 0   | 0   | 0   | 0   | 0   | 0   | 0   | 0   | 0   | 0   |
| 2010 | 0   | 0   | 0  | 0   | 0   | 0   | 0   | 0   | 0   | 0   | 0   | 0   | 0   |
| 2011 | 0   | 0   | 0  | 0   | 0   | 0   | 0   | 0   | 0   | 0   | 0   | 0   | 0   |
| 2012 | 0   | 0   | 0  | 0   | 0   | 0   | 0   | 0   | 0   | 0   | 0   | 0   | 0   |
| 2013 | 0   | 0   | 0  | 0   | 0   | 0   | 0   | 0   | 0   | 0   | 0   | 0   | 0   |
| 2014 | 0   | 0   | 0  | 0   | 0   | 0   | 0   | 0   | 0   | 0   | 0   | 0   | 0   |
| 2015 | 0   | 0   | 0  | 0   | 0   | 0   | 0   | 0   | 0   | 0   | 0   | 0   | 0   |
| 2016 | 0   | 0   | 0  | 0   | 0   | 0   | 0   | 0   | 0   | 0   | 0   | 0   | 0   |
| 2017 | 0   | 0   | 0  | 0   | 0   | 0   | 0   | 0   | 0   | 0   | 0   | 0   | 0   |
| 2018 | 0   | 0   | 0  | 0   | 0   | 0   | 0   | 0   | 0   | 0   | 0   | 0   | 0   |
| 2019 | 0   | 0   | 0  | 0   | 0   | 0   | 0   | 0   | 0   | 0   | 0   | 0   | 0   |
| 2020 | 0   | 0   | 0  | 0   | 0   | 0   | 0   | 0   | 211 | 0   | 0   | 0   | 0   |
| 2021 | 0   | 0   | 0  | 0   | 0   | 0   | 0   | 0   | 213 | 0   | 0   | 0   | 0   |
| 2022 | 0   | 0   | 0  | 0   | 0   | 0   | 0   | 0   | 196 | 0   | 0   | 0   | 0   |
| 2023 | 0   | 0   | 0  | 0   | 0   | 0   | 0   | 0   | 186 | 0   | 0   | 0   | 0   |
| 2024 | 0   | 0   | 0  | 0   | 0   | 0   | 0   | 0   | 198 | 0   | 0   | 0   | 0   |
| 2025 | 164 | 65  | 5  | 216 | 158 | 205 | 205 | 0   | 169 | 209 | 165 | 164 | 219 |
| 2026 | 143 | 76  | 5  | 200 | 137 | 189 | 187 | 0   | 172 | 209 | 122 | 137 | 216 |
| 2027 | 139 | 78  | 4  | 224 | 152 | 201 | 201 | 0   | 173 | 218 | 155 | 145 | 229 |
| 2028 | 100 | 77  | 8  | 196 | 116 | 185 | 177 | 0   | 184 | 201 | 108 | 121 | 209 |
| 2029 | 107 | 88  | 2  | 180 | 117 | 153 | 155 | 0   | 167 | 183 | 95  | 110 | 188 |
| 2030 | 83  | 75  | 3  | 199 | 100 | 167 | 157 | 211 | 155 | 183 | 125 | 100 | 204 |
| 2031 | 89  | 78  | 11 | 181 | 71  | 162 | 155 | 188 | 164 | 181 | 105 | 87  | 197 |
| 2032 | 67  | 60  | 5  | 165 | 64  | 158 | 158 | 174 | 133 | 165 | 98  | 75  | 191 |
| 2033 | 68  | 79  | 2  | 143 | 58  | 149 | 151 | 179 | 129 | 173 | 131 | 89  | 185 |
| 2034 | 81  | 99  | 23 | 180 | 102 | 149 | 148 | 157 | 131 | 163 | 121 | 99  | 194 |
| 2035 | 62  | 110 | 18 | 184 | 80  | 161 | 162 | 159 | 116 | 174 | 122 | 71  | 191 |
| 2036 | 60  | 83  | 18 | 135 | 62  | 128 | 121 | 158 | 128 | 142 | 105 | 67  | 168 |
| 2037 | 73  | 60  | 25 | 131 | 65  | 128 | 123 | 136 | 131 | 142 | 91  | 58  | 177 |
| 2038 | 94  | 59  | 15 | 130 | 49  | 110 | 111 | 155 | 119 | 140 | 101 | 70  | 159 |
| 2039 | 77  | 48  | 26 | 144 | 69  | 114 | 118 | 134 | 143 | 145 | 106 | 51  | 162 |
| 2040 | 89  | 77  | 17 | 170 | 55  | 143 | 136 | 128 | 136 | 179 | 92  | 86  | 194 |
| 2041 | 65  | 75  | 27 | 151 | 73  | 145 | 150 | 143 | 123 | 171 | 95  | 55  | 168 |
| 2042 | 62  | 27  | 13 | 118 | 42  | 161 | 164 | 133 | 112 | 184 | 54  | 48  | 202 |
| 2043 | 72  | 54  | 18 | 106 | 43  | 119 | 112 | 129 | 153 | 141 | 99  | 47  | 143 |
| 2044 | 55  | 70  | 17 | 91  | 33  | 115 | 121 | 123 | 77  | 152 | 70  | 46  | 139 |
| 2045 | 51  | 60  | 33 | 86  | 55  | 110 | 106 | 118 | 0   | 157 | 85  | 56  | 161 |
| 2046 | 54  | 73  | 39 | 102 | 55  | 70  | 81  | 108 | 0   | 63  | 63  | 22  | 87  |
| 2047 | 49  | 33  | 39 | 116 | 67  | 0   | 0   | 54  | 0   | 0   | 0   | 0   | 0   |
| 2048 | 0   | 13  | 34 | 63  | 54  | 0   | 0   | 0   | 0   | 0   | 0   | 0   | 0   |
| 2049 | 0   | 0   | 0  | 0   | 0   | 0   | 0   | 0   | 0   | 0   | 0   | 0   | 0   |
| 2050 | 0   | 0   | 0  | 0   | 0   | 0   | 0   | 0   | 0   | 0   | 0   | 0   | 0   |
| 2051 | 0   | 0   | 0  | 0   | 0   | 0   | 0   | 0   | 0   | 0   | 0   | 0   | 0   |
| 2052 | 0   | 0   | 0  | 0   | 0   | 0   | 0   | 0   | 0   | 0   | 0   | 0   | 0   |
| 2053 | 0   | 0   | 0  | 0   | 0   | 0   | 0   | 0   | 0   | 0   | 0   | 0   | 0   |
| 2054 | 0   | 0   | 0  | 0   | 0   | 0   | 0   | 0   | 0   | 0   | 0   | 0   | 0   |
| 2055 | 0   | 0   | 0  | 0   | 0   | 0   | 0   | 0   | 0   | 0   | 0   | 0   | 0   |
| 2056 | 0   | 0   | 0  | 0   | 0   | 0   | 0   | 0   | 0   | 0   | 0   | 0   | 0   |
| 2057 | 0   | 0   | 0  | 0   | 0   | 0   | 0   | 0   | 0   | 0   | 0   | 0   | 0   |
| 2058 | 0   | 0   | 0  | 0   | 0   | 0   | 0   | 0   | 0   | 0   | 0   | 0   | 0   |
| 2059 | 0   | 0   | 0  | 0   | 0   | 0   | 0   | 0   | 0   | 0   | 0   | 0   | 0   |

| Year | 14 | 15 | 16 | 17 | 18 | 19 | 20 | 21 | 22 | 23 | 24 | 25 | 26 |
|------|----|----|----|----|----|----|----|----|----|----|----|----|----|
| 2060 | 0  | 0  | 0  | 0  | 0  | 0  | 0  | 0  | 0  | 0  | 0  | 0  | 0  |
| 2061 | 0  | 0  | 0  | 0  | 0  | 0  | 0  | 0  | 0  | 0  | 0  | 0  | 0  |
| 2062 | 0  | 0  | 0  | 0  | 0  | 0  | 0  | 0  | 0  | 0  | 0  | 0  | 0  |
| 2063 | 0  | 0  | 0  | 0  | 0  | 0  | 0  | 0  | 0  | 0  | 0  | 0  | 0  |
| 2064 | 0  | 0  | 0  | 0  | 0  | 0  | 0  | 0  | 0  | 0  | 0  | 0  | 0  |
| 2065 | 0  | 0  | 0  | 0  | 0  | 0  | 0  | 0  | 0  | 0  | 0  | 0  | 0  |
| 2066 | 0  | 0  | 0  | 0  | 0  | 0  | 0  | 0  | 0  | 0  | 0  | 0  | 0  |
| 2067 | 0  | 0  | 0  | 0  | 0  | 0  | 0  | 0  | 0  | 0  | 0  | 0  | 0  |
| 2068 | 0  | 0  | 0  | 0  | 0  | 0  | 0  | 0  | 0  | 0  | 0  | 0  | 0  |
| 2069 | 0  | 0  | 0  | 0  | 0  | 0  | 0  | 0  | 0  | 0  | 0  | 0  | 0  |
| 2070 | 0  | 0  | 0  | 0  | 0  | 0  | 0  | 0  | 0  | 0  | 0  | 0  | 0  |
| 2071 | 0  | 0  | 0  | 0  | 0  | 0  | 0  | 0  | 0  | 0  | 0  | 0  | 0  |
| 2072 | 0  | 0  | 0  | 0  | 0  | 0  | 0  | 0  | 0  | 0  | 0  | 0  | 0  |
| 2073 | 0  | 0  | 0  | 0  | 0  | 0  | 0  | 0  | 0  | 0  | 0  | 0  | 0  |
| 2074 | 0  | 0  | 0  | 0  | 0  | 0  | 0  | 0  | 0  | 0  | 0  | 0  | 0  |
| 2075 | 0  | 0  | 0  | 0  | 0  | 0  | 0  | 0  | 0  | 0  | 0  | 0  | 0  |
| 2076 | 0  | 0  | 0  | 0  | 0  | 0  | 0  | 0  | 0  | 0  | 0  | 0  | 0  |
| 2077 | 0  | 0  | 0  | 0  | 0  | 0  | 0  | 0  | 0  | 0  | 0  | 0  | 0  |
| 2078 | 0  | 0  | 0  | 0  | 0  | 0  | 0  | 0  | 0  | 0  | 0  | 0  | 0  |
| 2079 | 0  | 0  | 0  | 0  | 0  | 0  | 0  | 0  | 0  | 0  | 0  | 0  | 0  |
| 2080 | 0  | 0  | 0  | 0  | 0  | 0  | 0  | 0  | 0  | 0  | 0  | 0  | 0  |
| 2081 | 0  | 0  | 0  | 0  | 0  | 0  | 0  | 0  | 0  | 0  | 0  | 0  | 0  |
| 2082 | 0  | 0  | 0  | 0  | 0  | 0  | 0  | 0  | 0  | 0  | 0  | 0  | 0  |
| 2083 | 0  | 0  | 0  | 0  | 0  | 0  | 0  | 0  | 0  | 0  | 0  | 0  | 0  |
| 2084 | 0  | 0  | 0  | 0  | 0  | 0  | 0  | 0  | 0  | 0  | 0  | 0  | 0  |
| 2085 | 0  | 0  | 0  | 0  | 0  | 0  | 0  | 0  | 0  | 0  | 0  | 0  | 0  |
| 2086 | 0  | 0  | 0  | 0  | 0  | 0  | 0  | 0  | 0  | 0  | 0  | 0  | 0  |
| 2087 | 0  | 0  | 0  | 0  | 0  | 0  | 0  | 0  | 0  | 0  | 0  | 0  | 0  |
| 2088 | 0  | 0  | 0  | 0  | 0  | 0  | 0  | 0  | 0  | 0  | 0  | 0  | 0  |
| 2089 | 0  | 0  | 0  | 0  | 0  | 0  | 0  | 0  | 0  | 0  | 0  | 0  | 0  |

| Year | 27  | 28 | 29 | 30 | 31 | 32 | 33 | 34 | 35  | 36 | 37  | 38  | 39  |
|------|-----|----|----|----|----|----|----|----|-----|----|-----|-----|-----|
| 2002 |     |    |    |    |    |    |    |    |     |    |     |     |     |
| 2003 | 0   | 0  | 0  | 0  | 0  | 0  | 0  | 0  | 0   | 0  | 0   | 0   | 0   |
| 2004 | 0   | 0  | 0  | 0  | 0  | 0  | 0  | 0  | 0   | 0  | 0   | 0   | 0   |
| 2005 | 0   | 0  | 0  | 0  | 0  | 0  | 0  | 0  | 0   | 0  | 0   | 0   | 0   |
| 2006 | 0   | 0  | 0  | 0  | 0  | 0  | 0  | 0  | 0   | 0  | 0   | 0   | 0   |
| 2007 | 0   | 0  | 0  | 0  | 0  | 0  | 0  | 0  | 0   | 0  | 0   | 0   | 0   |
| 2008 | 0   | 0  | 0  | 0  | 0  | 0  | 0  | 0  | 0   | 0  | 0   | 0   | 0   |
| 2009 | 0   | 0  | 0  | 0  | 0  | 0  | 0  | 0  | 0   | 0  | 0   | 0   | 0   |
| 2010 | 0   | 0  | 0  | 0  | 0  | 0  | 0  | 0  | 0   | 0  | 0   | 0   | 0   |
| 2011 | 0   | 0  | 0  | 0  | 0  | 0  | 0  | 0  | 0   | 0  | 0   | 0   | 0   |
| 2012 | 0   | 0  | 0  | 0  | 0  | 0  | 0  | 0  | 0   | 0  | 0   | 0   | 0   |
| 2013 | 0   | 0  | 0  | 0  | 0  | 0  | 0  | 0  | 0   | 0  | 0   | 0   | 0   |
| 2014 | 0   | 0  | 0  | 0  | 0  | 0  | 0  | 0  | 0   | 0  | 0   | 0   | 0   |
| 2015 | 0   | 0  | 0  | 0  | 0  | 0  | 0  | 0  | 0   | 0  | 0   | 0   | 0   |
| 2016 | 0   | 0  | 0  | 0  | 0  | 0  | 0  | 0  | 0   | 0  | 0   | 0   | 0   |
| 2017 | 0   | 0  | 0  | 0  | 0  | 0  | 0  | 0  | 0   | 0  | 0   | 0   | 0   |
| 2018 | 0   | 0  | 0  | 0  | 0  | 0  | 0  | 0  | 0   | 0  | 0   | 0   | 0   |
| 2019 | 0   | 0  | 0  | 0  | 0  | 0  | 0  | 0  | 0   | 0  | 0   | 0   | 0   |
| 2020 | 0   | 0  | 0  | 0  | 0  | 0  | 0  | 0  | 0   | 0  | 0   | 0   | 0   |
| 2021 | 0   | 0  | 0  | 0  | 0  | 0  | 0  | 0  | 0   | 0  | 0   | 0   | 0   |
| 2022 | 0   | 0  | 0  | 0  | 0  | 0  | 0  | 0  | 0   | 0  | 0   | 0   | 0   |
| 2023 | 0   | 0  | 0  | 0  | 0  | 0  | 0  | 0  | 0   | 0  | 0   | 0   | 0   |
| 2024 | 0   | 0  | 0  | 0  | 0  | 0  | 0  | 0  | 0   | 0  | 0   | 0   | 0   |
| 2025 | 205 | 0  | 0  | 0  | 0  | 0  | 0  | 0  | 0   | 0  | 158 | 158 | 0   |
| 2026 | 189 | 0  | 0  | 0  | 0  | 0  | 0  | 0  | 0   | 0  | 141 | 135 | 0   |
| 2027 | 203 | 0  | 0  | 0  | 0  | 0  | 0  | 0  | 0   | 0  | 148 | 148 | 0   |
| 2028 | 182 | 0  | 0  | 0  | 0  | 0  | 0  | 0  | 0   | 0  | 119 | 114 | 0   |
| 2029 | 156 | 0  | 0  | 0  | 0  | 0  | 0  | 0  | 0   | 0  | 119 | 121 | 0   |
| 2030 | 164 | 0  | 0  | 0  | 0  | 0  | 0  | 0  | 0   | 0  | 104 | 106 | 162 |
| 2031 | 154 | 0  | 0  | 0  | 0  | 0  | 0  | 0  | 0   | 0  | 65  | 62  | 131 |
| 2032 | 153 | 0  | 0  | 0  | 0  | 0  | 0  | 0  | 6   | 0  | 66  | 69  | 121 |
| 2033 | 148 | 0  | 0  | 0  | 6  | 0  | 0  | 0  | 4   | 0  | 57  | 57  | 106 |
| 2034 | 162 | 0  | 0  | 0  | 13 | 0  | 0  | 0  | 34  | 0  | 89  | 89  | 107 |
| 2035 | 158 | 0  | 0  | 0  | 12 | 0  | 0  | 0  | 55  | 0  | 70  | 71  | 87  |
| 2036 | 128 | 0  | 1  | 0  | 36 | 2  | 0  | 0  | 92  | 1  | 57  | 55  | 85  |
| 2037 | 123 | 2  | 2  | 0  | 34 | 2  | 0  | 0  | 61  | 2  | 74  | 71  | 72  |
| 2038 | 110 | 3  | 4  | 0  | 45 | 7  | 2  | 0  | 105 | 4  | 58  | 62  | 81  |
| 2039 | 117 | 7  | 9  | 0  | 72 | 14 | 6  | 0  | 79  | 9  | 70  | 73  | 69  |
| 2040 | 147 | 5  | 11 | 0  | 36 | 21 | 8  | 0  | 82  | 7  | 54  | 56  | 100 |
| 2041 | 148 | 33 | 38 | 0  | 25 | 16 | 23 | 0  | 116 | 38 | 70  | 74  | 92  |
| 2042 | 163 | 23 | 26 | 1  | 0  | 34 | 25 | 0  | 99  | 24 | 40  | 48  | 33  |
| 2043 | 119 | 9  | 3  | 1  | 0  | 2  | 28 | 0  | 27  | 3  | 48  | 48  | 46  |
| 2044 | 114 | 0  | 0  | 24 | 0  | 0  | 0  | 0  | 0   | 0  | 33  | 30  | 49  |
| 2045 | 106 | 0  | 0  | 2  | 0  | 0  | 0  | 0  | 0   | 0  | 48  | 43  | 44  |
| 2046 | 68  | 0  | 0  | 0  | 0  | 0  | 0  | 0  | 0   | 0  | 48  | 43  | 54  |
| 2047 | 0   | 0  | 0  | 0  | 0  | 0  | 0  | 0  | 0   | 0  | 81  | 68  | 63  |
| 2048 | 0   | 0  | 0  | 0  | 0  | 0  | 0  | 0  | 0   | 0  | 62  | 55  | 0   |
| 2049 | 0   | 0  | 0  | 0  | 0  | 0  | 0  | 0  | 0   | 0  | 0   | 0   | 0   |
| 2050 | 0   | 0  | 0  | 0  | 0  | 0  | 0  | 0  | 0   | 0  | 0   | 0   | 0   |
| 2051 | 0   | 0  | 0  | 0  | 0  | 0  | 0  | 0  | 0   | 0  | 0   | 0   | 0   |
| 2052 | 0   | 0  | 0  | 0  | 0  | 0  | 0  | 0  | 0   | 0  | 0   | 0   | 0   |
| 2053 | 0   | 0  | 0  | 0  | 0  | 0  | 0  | 0  | 0   | 0  | 0   | 0   | 0   |
| 2054 | 0   | 0  | 0  | 0  | 0  | 0  | 0  | 0  | 0   | 0  | 0   | 0   | 0   |
| 2055 | 0   | 0  | 0  | 0  | 0  | 0  | 0  | 0  | 0   | 0  | 0   | 0   | 0   |
| 2056 | 0   | 0  | 0  | 0  | 0  | 0  | 0  | 0  | 0   | 0  | 0   | 0   | 0   |
| 2057 | 0   | 0  | 0  | 0  | 0  | 0  | 0  | 0  | 0   | 0  | 0   | 0   | 0   |
| 2058 | 0   | 0  | 0  | 0  | 0  | 0  | 0  | 0  | 0   | 0  | 0   | 0   | 0   |
| 2059 | 0   | 0  | 0  | 0  | 0  | 0  | 0  | 0  | 0   | 0  | 0   | 0   | 0   |

| Year | 27 | 28 | 29 | 30 | 31 | 32 | 33 | 34 | 35 | 36 | 37 | 38 | 39 |
|------|----|----|----|----|----|----|----|----|----|----|----|----|----|
| 2060 | 0  | 0  | 0  | 0  | 0  | 0  | 0  | 0  | 0  | 0  | 0  | 0  | 0  |
| 2061 | 0  | 0  | 0  | 0  | 0  | 0  | 0  | 0  | 0  | 0  | 0  | 0  | 0  |
| 2062 | 0  | 0  | 0  | 0  | 0  | 0  | 0  | 0  | 0  | 0  | 0  | 0  | 0  |
| 2063 | 0  | 0  | 0  | 0  | 0  | 0  | 0  | 0  | 0  | 0  | 0  | 0  | 0  |
| 2064 | 0  | 0  | 0  | 0  | 0  | 0  | 0  | 0  | 0  | 0  | 0  | 0  | 0  |
| 2065 | 0  | 0  | 0  | 0  | 0  | 0  | 0  | 0  | 0  | 0  | 0  | 0  | 0  |
| 2066 | 0  | 0  | 0  | 0  | 0  | 0  | 0  | 0  | 0  | 0  | 0  | 0  | 0  |
| 2067 | 0  | 0  | 0  | 0  | 0  | 0  | 0  | 0  | 0  | 0  | 0  | 0  | 0  |
| 2068 | 0  | 0  | 0  | 0  | 0  | 0  | 0  | 0  | 0  | 0  | 0  | 0  | 0  |
| 2069 | 0  | 0  | 0  | 0  | 0  | 0  | 0  | 0  | 0  | 0  | 0  | 0  | 0  |
| 2070 | 0  | 0  | 0  | 0  | 0  | 0  | 0  | 0  | 0  | 0  | 0  | 0  | 0  |
| 2071 | 0  | 0  | 0  | 0  | 0  | 0  | 0  | 0  | 0  | 0  | 0  | 0  | 0  |
| 2072 | 0  | 0  | 0  | 0  | 0  | 0  | 0  | 0  | 0  | 0  | 0  | 0  | 0  |
| 2073 | 0  | 0  | 0  | 0  | 0  | 0  | 0  | 0  | 0  | 0  | 0  | 0  | 0  |
| 2074 | 0  | 0  | 0  | 0  | 0  | 0  | 0  | 0  | 0  | 0  | 0  | 0  | 0  |
| 2075 | 0  | 0  | 0  | 0  | 0  | 0  | 0  | 0  | 0  | 0  | 0  | 0  | 0  |
| 2076 | 0  | 0  | 0  | 0  | 0  | 0  | 0  | 0  | 0  | 0  | 0  | 0  | 0  |
| 2077 | 0  | 0  | 0  | 0  | 0  | 0  | 0  | 0  | 0  | 0  | 0  | 0  | 0  |
| 2078 | 0  | 0  | 0  | 0  | 0  | 0  | 0  | 0  | 0  | 0  | 0  | 0  | 0  |
| 2079 | 0  | 0  | 0  | 0  | 0  | 0  | 0  | 0  | 0  | 0  | 0  | 0  | 0  |
| 2080 | 0  | 0  | 0  | 0  | 0  | 0  | 0  | 0  | 0  | 0  | 0  | 0  | 0  |
| 2081 | 0  | 0  | 0  | 0  | 0  | 0  | 0  | 0  | 0  | 0  | 0  | 0  | 0  |
| 2082 | 0  | 0  | 0  | 0  | 0  | 0  | 0  | 0  | 0  | 0  | 0  | 0  | 0  |
| 2083 | 0  | 0  | 0  | 0  | 0  | 0  | 0  | 0  | 0  | 0  | 0  | 0  | 0  |
| 2084 | 0  | 0  | 0  | 0  | 0  | 0  | 0  | 0  | 0  | 0  | 0  | 0  | 0  |
| 2085 | 0  | 0  | 0  | 0  | 0  | 0  | 0  | 0  | 0  | 0  | 0  | 0  | 0  |
| 2086 | 0  | 0  | 0  | 0  | 0  | 0  | 0  | 0  | 0  | 0  | 0  | 0  | 0  |
| 2087 | 0  | 0  | 0  | 0  | 0  | 0  | 0  | 0  | 0  | 0  | 0  | 0  | 0  |
| 2088 | 0  | 0  | 0  | 0  | 0  | 0  | 0  | 0  | 0  | 0  | 0  | 0  | 0  |
| 2089 | 0  | 0  | 0  | 0  | 0  | 0  | 0  | 0  | 0  | 0  | 0  | 0  | 0  |

| Year | 40  | 41  | 42  | 43 | 44  | 45  | 46  | 47  | 48  | 49  | 50  | 51  | 52  |
|------|-----|-----|-----|----|-----|-----|-----|-----|-----|-----|-----|-----|-----|
| 2002 |     |     |     |    |     |     |     |     |     |     |     |     |     |
| 2003 | 0   | 0   | 0   | 0  | 0   | 0   | 0   | 0   | 0   | 0   | 0   | 0   | 0   |
| 2004 | 0   | 0   | 0   | 0  | 0   | 0   | 0   | 0   | 0   | 0   | 0   | 0   | 0   |
| 2005 | 0   | 0   | 0   | 0  | 0   | 0   | 0   | 0   | 0   | 0   | 0   | 0   | 0   |
| 2006 | 0   | 0   | 0   | 0  | 0   | 0   | 0   | 0   | 0   | 0   | 0   | 0   | 0   |
| 2007 | 0   | 0   | 0   | 0  | 0   | 0   | 0   | 0   | 0   | 0   | 0   | 0   | 0   |
| 2008 | 0   | 0   | 0   | 0  | 0   | 0   | 0   | 0   | 0   | 0   | 0   | 0   | 0   |
| 2009 | 0   | 0   | 0   | 0  | 0   | 0   | 0   | 0   | 0   | 0   | 0   | 0   | 0   |
| 2010 | 0   | 0   | 0   | 0  | 0   | 0   | 0   | 0   | 0   | 0   | 0   | 0   | 0   |
| 2011 | 0   | 0   | 0   | 0  | 0   | 0   | 0   | 0   | 0   | 0   | 0   | 0   | 0   |
| 2012 | 0   | 0   | 0   | 0  | 0   | 0   | 0   | 0   | 0   | 0   | 0   | 0   | 0   |
| 2013 | 0   | 0   | 0   | 0  | 0   | 0   | 0   | 0   | 0   | 0   | 0   | 0   | 0   |
| 2014 | 0   | 0   | 0   | 0  | 0   | 0   | 0   | 0   | 0   | 0   | 0   | 0   | 0   |
| 2015 | 0   | 0   | 0   | 0  | 0   | 0   | 0   | 0   | 0   | 0   | 0   | 0   | 0   |
| 2016 | 0   | 0   | 0   | 0  | 0   | 0   | 0   | 0   | 0   | 0   | 0   | 0   | 0   |
| 2017 | 0   | 0   | 0   | 0  | 0   | 0   | 0   | 0   | 0   | 0   | 0   | 0   | 0   |
| 2018 | 0   | 0   | 0   | 0  | 0   | 0   | 0   | 0   | 0   | 0   | 0   | 0   | 0   |
| 2019 | 0   | 0   | 0   | 0  | 0   | 0   | 0   | 0   | 0   | 0   | 0   | 0   | 0   |
| 2020 | 141 | 0   | 0   | 0  | 0   | 0   | 0   | 0   | 0   | 211 | 0   | 0   | 0   |
| 2021 | 144 | 0   | 0   | 0  | 0   | 0   | 0   | 0   | 0   | 211 | 0   | 0   | 0   |
| 2022 | 122 | 0   | 0   | 0  | 0   | 0   | 0   | 0   | 0   | 195 | 0   | 0   | 0   |
| 2023 | 118 | 0   | 0   | 0  | 0   | 0   | 0   | 0   | 0   | 181 | 0   | 0   | 0   |
| 2024 | 104 | 0   | 0   | 0  | 0   | 0   | 0   | 0   | 0   | 199 | 0   | 0   | 0   |
| 2025 | 102 | 164 | 65  | 5  | 216 | 158 | 205 | 205 | 0   | 167 | 209 | 165 | 164 |
| 2026 | 86  | 140 | 76  | 4  | 202 | 136 | 187 | 186 | 0   | 173 | 209 | 122 | 137 |
| 2027 | 82  | 136 | 78  | 4  | 222 | 152 | 198 | 195 | 0   | 171 | 216 | 155 | 141 |
| 2028 | 76  | 104 | 73  | 6  | 192 | 115 | 179 | 175 | 0   | 187 | 199 | 106 | 116 |
| 2029 | 55  | 112 | 80  | 0  | 176 | 115 | 160 | 158 | 0   | 168 | 185 | 97  | 116 |
| 2030 | 53  | 76  | 74  | 5  | 190 | 100 | 166 | 153 | 211 | 156 | 182 | 122 | 103 |
| 2031 | 64  | 73  | 89  | 8  | 166 | 62  | 159 | 155 | 184 | 163 | 180 | 108 | 89  |
| 2032 | 33  | 72  | 77  | 4  | 165 | 68  | 156 | 157 | 176 | 128 | 159 | 99  | 75  |
| 2033 | 69  | 62  | 83  | 2  | 151 | 60  | 151 | 156 | 173 | 134 | 168 | 132 | 86  |
| 2034 | 66  | 82  | 92  | 12 | 177 | 96  | 148 | 148 | 159 | 130 | 158 | 115 | 93  |
| 2035 | 62  | 64  | 114 | 9  | 183 | 68  | 167 | 165 | 154 | 123 | 176 | 127 | 77  |
| 2036 | 73  | 63  | 75  | 12 | 134 | 56  | 126 | 121 | 156 | 121 | 155 | 106 | 71  |
| 2037 | 56  | 76  | 58  | 31 | 150 | 77  | 128 | 124 | 130 | 130 | 142 | 92  | 56  |
| 2038 | 39  | 92  | 56  | 16 | 143 | 54  | 114 | 108 | 149 | 120 | 137 | 103 | 62  |
| 2039 | 61  | 80  | 51  | 17 | 143 | 52  | 120 | 113 | 133 | 143 | 150 | 115 | 54  |
| 2040 | 84  | 102 | 84  | 27 | 171 | 66  | 172 | 141 | 125 | 136 | 183 | 100 | 91  |
| 2041 | 80  | 63  | 79  | 24 | 156 | 84  | 137 | 143 | 145 | 128 | 166 | 99  | 51  |
| 2042 | 64  | 55  | 33  | 15 | 124 | 48  | 145 | 153 | 142 | 129 | 180 | 62  | 46  |
| 2043 | 68  | 62  | 45  | 24 | 116 | 48  | 116 | 122 | 119 | 150 | 143 | 99  | 54  |
| 2044 | 85  | 62  | 67  | 18 | 87  | 33  | 116 | 122 | 121 | 61  | 168 | 66  | 46  |
| 2045 | 86  | 52  | 62  | 27 | 84  | 46  | 113 | 114 | 117 | 0   | 169 | 84  | 55  |
| 2046 | 64  | 55  | 73  | 29 | 92  | 54  | 70  | 83  | 103 | 0   | 52  | 55  | 26  |
| 2047 | 30  | 40  | 24  | 48 | 124 | 73  | 0   | 0   | 70  | 0   | 0   | 0   | 0   |
| 2048 | 0   | 0   | 0   | 28 | 65  | 48  | 0   | 0   | 0   | 0   | 0   | 0   | 0   |
| 2049 | 0   | 0   | 0   | 0  | 0   | 0   | 0   | 0   | 0   | 0   | 0   | 0   | 0   |
| 2050 | 0   | 0   | 0   | 0  | 0   | 0   | 0   | 0   | 0   | 0   | 0   | 0   | 0   |
| 2051 | 0   | 0   | 0   | 0  | 0   | 0   | 0   | 0   | 0   | 0   | 0   | 0   | 0   |
| 2052 | 0   | 0   | 0   | 0  | 0   | 0   | 0   | 0   | 0   | 0   | 0   | 0   | 0   |
| 2053 | 0   | 0   | 0   | 0  | 0   | 0   | 0   | 0   | 0   | 0   | 0   | 0   | 0   |
| 2054 | 0   | 0   | 0   | 0  | 0   | 0   | 0   | 0   | 0   | 0   | 0   | 0   | 0   |
| 2055 | 0   | 0   | 0   | 0  | 0   | 0   | 0   | 0   | 0   | 0   | 0   | 0   | 0   |
| 2056 | 0   | 0   | 0   | 0  | 0   | 0   | 0   | 0   | 0   | 0   | 0   | 0   | 0   |
| 2057 | 0   | 0   | 0   | 0  | 0   | 0   | 0   | 0   | 0   | 0   | 0   | 0   | 0   |
| 2058 | 0   | 0   | 0   | 0  | 0   | 0   | 0   | 0   | 0   | 0   | 0   | 0   | 0   |
| 2059 | 0   | 0   | 0   | 0  | 0   | 0   | 0   | 0   | 0   | 0   | 0   | 0   | 0   |

| Year | 40 | 41 | 42 | 43 | 44 | 45 | 46 | 47 | 48 | 49 | 50 | 51 | 52 |
|------|----|----|----|----|----|----|----|----|----|----|----|----|----|
| 2060 | 0  | 0  | 0  | 0  | 0  | 0  | 0  | 0  | 0  | 0  | 0  | 0  | 0  |
| 2061 | 0  | 0  | 0  | 0  | 0  | 0  | 0  | 0  | 0  | 0  | 0  | 0  | 0  |
| 2062 | 0  | 0  | 0  | 0  | 0  | 0  | 0  | 0  | 0  | 0  | 0  | 0  | 0  |
| 2063 | 0  | 0  | 0  | 0  | 0  | 0  | 0  | 0  | 0  | 0  | 0  | 0  | 0  |
| 2064 | 0  | 0  | 0  | 0  | 0  | 0  | 0  | 0  | 0  | 0  | 0  | 0  | 0  |
| 2065 | 0  | 0  | 0  | 0  | 0  | 0  | 0  | 0  | 0  | 0  | 0  | 0  | 0  |
| 2066 | 0  | 0  | 0  | 0  | 0  | 0  | 0  | 0  | 0  | 0  | 0  | 0  | 0  |
| 2067 | 0  | 0  | 0  | 0  | 0  | 0  | 0  | 0  | 0  | 0  | 0  | 0  | 0  |
| 2068 | 0  | 0  | 0  | 0  | 0  | 0  | 0  | 0  | 0  | 0  | 0  | 0  | 0  |
| 2069 | 0  | 0  | 0  | 0  | 0  | 0  | 0  | 0  | 0  | 0  | 0  | 0  | 0  |
| 2070 | 0  | 0  | 0  | 0  | 0  | 0  | 0  | 0  | 0  | 0  | 0  | 0  | 0  |
| 2071 | 0  | 0  | 0  | 0  | 0  | 0  | 0  | 0  | 0  | 0  | 0  | 0  | 0  |
| 2072 | 0  | 0  | 0  | 0  | 0  | 0  | 0  | 0  | 0  | 0  | 0  | 0  | 0  |
| 2073 | 0  | 0  | 0  | 0  | 0  | 0  | 0  | 0  | 0  | 0  | 0  | 0  | 0  |
| 2074 | 0  | 0  | 0  | 0  | 0  | 0  | 0  | 0  | 0  | 0  | 0  | 0  | 0  |
| 2075 | 0  | 0  | 0  | 0  | 0  | 0  | 0  | 0  | 0  | 0  | 0  | 0  | 0  |
| 2076 | 0  | 0  | 0  | 0  | 0  | 0  | 0  | 0  | 0  | 0  | 0  | 0  | 0  |
| 2077 | 0  | 0  | 0  | 0  | 0  | 0  | 0  | 0  | 0  | 0  | 0  | 0  | 0  |
| 2078 | 0  | 0  | 0  | 0  | 0  | 0  | 0  | 0  | 0  | 0  | 0  | 0  | 0  |
| 2079 | 0  | 0  | 0  | 0  | 0  | 0  | 0  | 0  | 0  | 0  | 0  | 0  | 0  |
| 2080 | 0  | 0  | 0  | 0  | 0  | 0  | 0  | 0  | 0  | 0  | 0  | 0  | 0  |
| 2081 | 0  | 0  | 0  | 0  | 0  | 0  | 0  | 0  | 0  | 0  | 0  | 0  | 0  |
| 2082 | 0  | 0  | 0  | 0  | 0  | 0  | 0  | 0  | 0  | 0  | 0  | 0  | 0  |
| 2083 | 0  | 0  | 0  | 0  | 0  | 0  | 0  | 0  | 0  | 0  | 0  | 0  | 0  |
| 2084 | 0  | 0  | 0  | 0  | 0  | 0  | 0  | 0  | 0  | 0  | 0  | 0  | 0  |
| 2085 | 0  | 0  | 0  | 0  | 0  | 0  | 0  | 0  | 0  | 0  | 0  | 0  | 0  |
| 2086 | 0  | 0  | 0  | 0  | 0  | 0  | 0  | 0  | 0  | 0  | 0  | 0  | 0  |
| 2087 | 0  | 0  | 0  | 0  | 0  | 0  | 0  | 0  | 0  | 0  | 0  | 0  | 0  |
| 2088 | 0  | 0  | 0  | 0  | 0  | 0  | 0  | 0  | 0  | 0  | 0  | 0  | 0  |
| 2089 | 0  | 0  | 0  | 0  | 0  | 0  | 0  | 0  | 0  | 0  | 0  | 0  | 0  |



| Year | 53  | 54  | 55 | 56 | 57 | 58 | 59 | 60 | 61 | 62 | 63 | 64  | 65  |
|------|-----|-----|----|----|----|----|----|----|----|----|----|-----|-----|
| 2002 |     |     |    |    |    |    |    |    |    |    |    |     |     |
| 2003 | 0   | 0   | 0  | 0  | 0  | 0  | 0  | 0  | 0  | 0  | 0  | 0   | 0   |
| 2004 | 0   | 0   | 0  | 0  | 0  | 0  | 0  | 0  | 0  | 0  | 0  | 0   | 0   |
| 2005 | 0   | 0   | 0  | 0  | 0  | 0  | 0  | 0  | 0  | 0  | 0  | 0   | 0   |
| 2006 | 0   | 0   | 0  | 0  | 0  | 0  | 0  | 0  | 0  | 0  | 0  | 0   | 0   |
| 2007 | 0   | 0   | 0  | 0  | 0  | 0  | 0  | 0  | 0  | 0  | 0  | 0   | 0   |
| 2008 | 0   | 0   | 0  | 0  | 0  | 0  | 0  | 0  | 0  | 0  | 0  | 0   | 0   |
| 2009 | 0   | 0   | 0  | 0  | 0  | 0  | 0  | 0  | 0  | 0  | 0  | 0   | 0   |
| 2010 | 0   | 0   | 0  | 0  | 0  | 0  | 0  | 0  | 0  | 0  | 0  | 0   | 0   |
| 2011 | 0   | 0   | 0  | 0  | 0  | 0  | 0  | 0  | 0  | 0  | 0  | 0   | 0   |
| 2012 | 0   | 0   | 0  | 0  | 0  | 0  | 0  | 0  | 0  | 0  | 0  | 0   | 0   |
| 2013 | 0   | 0   | 0  | 0  | 0  | 0  | 0  | 0  | 0  | 0  | 0  | 0   | 0   |
| 2014 | 0   | 0   | 0  | 0  | 0  | 0  | 0  | 0  | 0  | 0  | 0  | 0   | 0   |
| 2015 | 0   | 0   | 0  | 0  | 0  | 0  | 0  | 0  | 0  | 0  | 0  | 0   | 0   |
| 2016 | 0   | 0   | 0  | 0  | 0  | 0  | 0  | 0  | 0  | 0  | 0  | 0   | 0   |
| 2017 | 0   | 0   | 0  | 0  | 0  | 0  | 0  | 0  | 0  | 0  | 0  | 0   | 0   |
| 2018 | 0   | 0   | 0  | 0  | 0  | 0  | 0  | 0  | 0  | 0  | 0  | 0   | 0   |
| 2019 | 0   | 0   | 0  | 0  | 0  | 0  | 0  | 0  | 0  | 0  | 0  | 0   | 0   |
| 2020 | 0   | 0   | 0  | 0  | 0  | 0  | 0  | 0  | 0  | 0  | 0  | 0   | 0   |
| 2021 | 0   | 0   | 0  | 0  | 0  | 0  | 0  | 0  | 0  | 0  | 0  | 0   | 0   |
| 2022 | 0   | 0   | 0  | 0  | 0  | 0  | 0  | 0  | 0  | 0  | 0  | 0   | 0   |
| 2023 | 0   | 0   | 0  | 0  | 0  | 0  | 0  | 0  | 0  | 0  | 0  | 0   | 0   |
| 2024 | 0   | 0   | 0  | 0  | 0  | 0  | 0  | 0  | 0  | 0  | 0  | 0   | 0   |
| 2025 | 219 | 205 | 0  | 0  | 0  | 0  | 0  | 0  | 0  | 0  | 0  | 158 | 158 |
| 2026 | 217 | 187 | 0  | 0  | 0  | 0  | 0  | 0  | 0  | 0  | 0  | 153 | 112 |
| 2027 | 220 | 197 | 0  | 0  | 0  | 0  | 0  | 0  | 0  | 0  | 0  | 145 | 132 |
| 2028 | 200 | 175 | 0  | 0  | 0  | 0  | 0  | 0  | 0  | 0  | 0  | 127 | 128 |
| 2029 | 192 | 158 | 0  | 0  | 0  | 0  | 0  | 0  | 0  | 0  | 0  | 116 | 128 |
| 2030 | 202 | 158 | 0  | 0  | 0  | 0  | 0  | 0  | 0  | 0  | 0  | 109 | 114 |
| 2031 | 197 | 151 | 0  | 0  | 0  | 0  | 0  | 0  | 0  | 0  | 0  | 83  | 82  |
| 2032 | 189 | 155 | 0  | 0  | 0  | 0  | 0  | 0  | 0  | 0  | 0  | 84  | 82  |
| 2033 | 182 | 145 | 0  | 0  | 0  | 4  | 0  | 0  | 0  | 1  | 0  | 61  | 65  |
| 2034 | 190 | 154 | 0  | 0  | 0  | 10 | 0  | 0  | 0  | 6  | 0  | 100 | 100 |
| 2035 | 196 | 165 | 0  | 0  | 0  | 8  | 0  | 0  | 0  | 12 | 0  | 89  | 82  |
| 2036 | 150 | 119 | 0  | 0  | 0  | 12 | 0  | 0  | 0  | 19 | 0  | 67  | 68  |
| 2037 | 173 | 128 | 0  | 0  | 0  | 22 | 1  | 0  | 0  | 24 | 0  | 53  | 63  |
| 2038 | 170 | 108 | 0  | 0  | 0  | 58 | 2  | 2  | 0  | 67 | 0  | 57  | 57  |
| 2039 | 159 | 114 | 0  | 0  | 0  | 50 | 1  | 3  | 0  | 75 | 0  | 65  | 64  |
| 2040 | 198 | 155 | 0  | 0  | 0  | 42 | 3  | 2  | 0  | 98 | 0  | 83  | 85  |
| 2041 | 165 | 144 | 5  | 4  | 0  | 44 | 8  | 5  | 0  | 84 | 7  | 88  | 85  |
| 2042 | 194 | 152 | 6  | 10 | 0  | 3  | 15 | 25 | 0  | 70 | 5  | 84  | 83  |
| 2043 | 151 | 124 | 19 | 11 | 0  | 0  | 29 | 28 | 4  | 78 | 20 | 52  | 51  |
| 2044 | 157 | 124 | 9  | 16 | 0  | 0  | 42 | 28 | 0  | 39 | 4  | 57  | 51  |
| 2045 | 171 | 114 | 0  | 0  | 0  | 0  | 0  | 0  | 0  | 0  | 0  | 66  | 70  |
| 2046 | 94  | 67  | 0  | 0  | 4  | 0  | 0  | 0  | 0  | 0  | 0  | 53  | 56  |
| 2047 | 0   | 0   | 0  | 0  | 0  | 0  | 0  | 0  | 0  | 0  | 0  | 21  | 41  |
| 2048 | 0   | 0   | 0  | 0  | 0  | 0  | 0  | 0  | 0  | 0  | 0  | 0   | 0   |
| 2049 | 0   | 0   | 0  | 0  | 0  | 0  | 0  | 0  | 0  | 0  | 0  | 0   | 0   |
| 2050 | 0   | 0   | 0  | 0  | 0  | 0  | 0  | 0  | 0  | 0  | 0  | 0   | 0   |
| 2051 | 0   | 0   | 0  | 0  | 0  | 0  | 0  | 0  | 0  | 0  | 0  | 0   | 0   |
| 2052 | 0   | 0   | 0  | 0  | 0  | 0  | 0  | 0  | 0  | 0  | 0  | 0   | 0   |
| 2053 | 0   | 0   | 0  | 0  | 0  | 0  | 0  | 0  | 0  | 0  | 0  | 0   | 0   |
| 2054 | 0   | 0   | 0  | 0  | 0  | 0  | 0  | 0  | 0  | 0  | 0  | 0   | 0   |
| 2055 | 0   | 0   | 0  | 0  | 0  | 0  | 0  | 0  | 0  | 0  | 0  | 0   | 0   |
| 2056 | 0   | 0   | 0  | 0  | 0  | 0  | 0  | 0  | 0  | 0  | 0  | 0   | 0   |
| 2057 | 0   | 0   | 0  | 0  | 0  | 0  | 0  | 0  | 0  | 0  | 0  | 0   | 0   |
| 2058 | 0   | 0   | 0  | 0  | 0  | 0  | 0  | 0  | 0  | 0  | 0  | 0   | 0   |
| 2059 | 0   | 0   | 0  | 0  | 0  | 0  | 0  | 0  | 0  | 0  | 0  | 0   | 0   |

| Year | 53 | 54 | 55 | 56 | 57 | 58 | 59 | 60 | 61 | 62 | 63 | 64 | 65 |
|------|----|----|----|----|----|----|----|----|----|----|----|----|----|
| 2060 | 0  | 0  | 0  | 0  | 0  | 0  | 0  | 0  | 0  | 0  | 0  | 0  | 0  |
| 2061 | 0  | 0  | 0  | 0  | 0  | 0  | 0  | 0  | 0  | 0  | 0  | 0  | 0  |
| 2062 | 0  | 0  | 0  | 0  | 0  | 0  | 0  | 0  | 0  | 0  | 0  | 0  | 0  |
| 2063 | 0  | 0  | 0  | 0  | 0  | 0  | 0  | 0  | 0  | 0  | 0  | 0  | 0  |
| 2064 | 0  | 0  | 0  | 0  | 0  | 0  | 0  | 0  | 0  | 0  | 0  | 0  | 0  |
| 2065 | 0  | 0  | 0  | 0  | 0  | 0  | 0  | 0  | 0  | 0  | 0  | 0  | 0  |
| 2066 | 0  | 0  | 0  | 0  | 0  | 0  | 0  | 0  | 0  | 0  | 0  | 0  | 0  |
| 2067 | 0  | 0  | 0  | 0  | 0  | 0  | 0  | 0  | 0  | 0  | 0  | 0  | 0  |
| 2068 | 0  | 0  | 0  | 0  | 0  | 0  | 0  | 0  | 0  | 0  | 0  | 0  | 0  |
| 2069 | 0  | 0  | 0  | 0  | 0  | 0  | 0  | 0  | 0  | 0  | 0  | 0  | 0  |
| 2070 | 0  | 0  | 0  | 0  | 0  | 0  | 0  | 0  | 0  | 0  | 0  | 0  | 0  |
| 2071 | 0  | 0  | 0  | 0  | 0  | 0  | 0  | 0  | 0  | 0  | 0  | 0  | 0  |
| 2072 | 0  | 0  | 0  | 0  | 0  | 0  | 0  | 0  | 0  | 0  | 0  | 0  | 0  |
| 2073 | 0  | 0  | 0  | 0  | 0  | 0  | 0  | 0  | 0  | 0  | 0  | 0  | 0  |
| 2074 | 0  | 0  | 0  | 0  | 0  | 0  | 0  | 0  | 0  | 0  | 0  | 0  | 0  |
| 2075 | 0  | 0  | 0  | 0  | 0  | 0  | 0  | 0  | 0  | 0  | 0  | 0  | 0  |
| 2076 | 0  | 0  | 0  | 0  | 0  | 0  | 0  | 0  | 0  | 0  | 0  | 0  | 0  |
| 2077 | 0  | 0  | 0  | 0  | 0  | 0  | 0  | 0  | 0  | 0  | 0  | 0  | 0  |
| 2078 | 0  | 0  | 0  | 0  | 0  | 0  | 0  | 0  | 0  | 0  | 0  | 0  | 0  |
| 2079 | 0  | 0  | 0  | 0  | 0  | 0  | 0  | 0  | 0  | 0  | 0  | 0  | 0  |
| 2080 | 0  | 0  | 0  | 0  | 0  | 0  | 0  | 0  | 0  | 0  | 0  | 0  | 0  |
| 2081 | 0  | 0  | 0  | 0  | 0  | 0  | 0  | 0  | 0  | 0  | 0  | 0  | 0  |
| 2082 | 0  | 0  | 0  | 0  | 0  | 0  | 0  | 0  | 0  | 0  | 0  | 0  | 0  |
| 2083 | 0  | 0  | 0  | 0  | 0  | 0  | 0  | 0  | 0  | 0  | 0  | 0  | 0  |
| 2084 | 0  | 0  | 0  | 0  | 0  | 0  | 0  | 0  | 0  | 0  | 0  | 0  | 0  |
| 2085 | 0  | 0  | 0  | 0  | 0  | 0  | 0  | 0  | 0  | 0  | 0  | 0  | 0  |
| 2086 | 0  | 0  | 0  | 0  | 0  | 0  | 0  | 0  | 0  | 0  | 0  | 0  | 0  |
| 2087 | 0  | 0  | 0  | 0  | 0  | 0  | 0  | 0  | 0  | 0  | 0  | 0  | 0  |
| 2088 | 0  | 0  | 0  | 0  | 0  | 0  | 0  | 0  | 0  | 0  | 0  | 0  | 0  |
| 2089 | 0  | 0  | 0  | 0  | 0  | 0  | 0  | 0  | 0  | 0  | 0  | 0  | 0  |

| Year | 66  | 67  | 68  | 69  | 70 | 71  | 72  | 73  | 74  | 75  | 76  | 77  | 78  |
|------|-----|-----|-----|-----|----|-----|-----|-----|-----|-----|-----|-----|-----|
| 2002 |     |     |     |     |    |     |     |     |     |     |     |     |     |
| 2003 | 0   | 0   | 0   | 0   | 0  | 0   | 0   | 0   | 0   | 0   | 0   | 0   | 0   |
| 2004 | 0   | 0   | 0   | 0   | 0  | 0   | 0   | 0   | 0   | 0   | 0   | 0   | 0   |
| 2005 | 0   | 0   | 0   | 0   | 0  | 0   | 0   | 0   | 0   | 0   | 0   | 0   | 0   |
| 2006 | 0   | 0   | 0   | 0   | 0  | 0   | 0   | 0   | 0   | 0   | 0   | 0   | 0   |
| 2007 | 0   | 0   | 0   | 0   | 0  | 0   | 0   | 0   | 0   | 0   | 0   | 0   | 0   |
| 2008 | 0   | 0   | 0   | 0   | 0  | 0   | 0   | 0   | 0   | 0   | 0   | 0   | 0   |
| 2009 | 0   | 0   | 0   | 0   | 0  | 0   | 0   | 0   | 0   | 0   | 0   | 0   | 0   |
| 2010 | 0   | 0   | 0   | 0   | 0  | 0   | 0   | 0   | 0   | 0   | 0   | 0   | 0   |
| 2011 | 0   | 0   | 0   | 0   | 0  | 0   | 0   | 0   | 0   | 0   | 0   | 0   | 0   |
| 2012 | 0   | 0   | 0   | 0   | 0  | 0   | 0   | 0   | 0   | 0   | 0   | 0   | 0   |
| 2013 | 0   | 0   | 0   | 0   | 0  | 0   | 0   | 0   | 0   | 0   | 0   | 0   | 0   |
| 2014 | 0   | 0   | 0   | 0   | 0  | 0   | 0   | 0   | 0   | 0   | 0   | 0   | 0   |
| 2015 | 0   | 0   | 0   | 0   | 0  | 0   | 0   | 0   | 0   | 0   | 0   | 0   | 0   |
| 2016 | 0   | 0   | 0   | 0   | 0  | 0   | 0   | 0   | 0   | 0   | 0   | 0   | 0   |
| 2017 | 0   | 0   | 0   | 0   | 0  | 0   | 0   | 0   | 0   | 0   | 0   | 0   | 0   |
| 2018 | 0   | 0   | 0   | 0   | 0  | 0   | 0   | 0   | 0   | 0   | 0   | 0   | 0   |
| 2019 | 0   | 0   | 0   | 0   | 0  | 0   | 0   | 0   | 0   | 0   | 0   | 0   | 0   |
| 2020 | 0   | 141 | 0   | 0   | 0  | 0   | 0   | 0   | 0   | 0   | 211 | 0   | 0   |
| 2021 | 0   | 143 | 0   | 0   | 0  | 0   | 0   | 0   | 0   | 0   | 273 | 0   | 0   |
| 2022 | 0   | 114 | 0   | 0   | 0  | 0   | 0   | 0   | 0   | 0   | 226 | 0   | 0   |
| 2023 | 0   | 128 | 0   | 0   | 0  | 0   | 0   | 0   | 0   | 0   | 187 | 0   | 0   |
| 2024 | 0   | 116 | 0   | 0   | 0  | 0   | 0   | 0   | 0   | 0   | 202 | 0   | 0   |
| 2025 | 0   | 114 | 164 | 65  | 5  | 216 | 158 | 205 | 205 | 0   | 174 | 209 | 165 |
| 2026 | 0   | 97  | 146 | 58  | 0  | 290 | 117 | 259 | 170 | 0   | 171 | 253 | 112 |
| 2027 | 0   | 91  | 162 | 68  | 2  | 283 | 143 | 228 | 195 | 0   | 174 | 249 | 147 |
| 2028 | 0   | 81  | 167 | 79  | 11 | 289 | 134 | 207 | 207 | 0   | 198 | 260 | 106 |
| 2029 | 0   | 64  | 139 | 71  | 3  | 221 | 118 | 149 | 185 | 0   | 172 | 207 | 97  |
| 2030 | 162 | 53  | 95  | 75  | 2  | 206 | 111 | 158 | 166 | 211 | 156 | 182 | 128 |
| 2031 | 109 | 73  | 78  | 108 | 11 | 202 | 80  | 165 | 179 | 165 | 166 | 184 | 115 |
| 2032 | 120 | 44  | 86  | 91  | 4  | 197 | 83  | 156 | 153 | 168 | 159 | 186 | 127 |
| 2033 | 134 | 92  | 61  | 82  | 2  | 172 | 62  | 156 | 152 | 197 | 159 | 184 | 131 |
| 2034 | 124 | 72  | 97  | 106 | 7  | 203 | 100 | 171 | 165 | 204 | 153 | 192 | 136 |
| 2035 | 98  | 57  | 71  | 115 | 9  | 216 | 92  | 180 | 173 | 165 | 148 | 187 | 148 |
| 2036 | 74  | 52  | 67  | 60  | 14 | 143 | 65  | 155 | 155 | 130 | 133 | 161 | 109 |
| 2037 | 81  | 45  | 70  | 63  | 17 | 141 | 53  | 153 | 152 | 136 | 150 | 157 | 97  |
| 2038 | 99  | 52  | 70  | 66  | 15 | 129 | 62  | 127 | 129 | 166 | 114 | 158 | 98  |
| 2039 | 69  | 70  | 89  | 56  | 11 | 147 | 62  | 131 | 147 | 147 | 175 | 180 | 126 |
| 2040 | 95  | 92  | 114 | 71  | 30 | 194 | 80  | 152 | 161 | 136 | 150 | 215 | 121 |
| 2041 | 101 | 72  | 71  | 70  | 25 | 145 | 86  | 163 | 165 | 170 | 186 | 187 | 108 |
| 2042 | 40  | 75  | 65  | 31  | 22 | 174 | 86  | 164 | 153 | 136 | 137 | 209 | 67  |
| 2043 | 51  | 91  | 57  | 57  | 28 | 139 | 49  | 133 | 144 | 114 | 20  | 153 | 77  |
| 2044 | 59  | 91  | 61  | 59  | 19 | 142 | 57  | 149 | 146 | 159 | 0   | 168 | 97  |
| 2045 | 51  | 0   | 62  | 65  | 25 | 121 | 73  | 92  | 82  | 155 | 0   | 136 | 78  |
| 2046 | 51  | 0   | 75  | 32  | 18 | 101 | 50  | 0   | 0   | 121 | 0   | 0   | 0   |
| 2047 | 76  | 0   | 17  | 0   | 13 | 30  | 22  | 0   | 0   | 121 | 0   | 0   | 0   |
| 2048 | 42  | 0   | 0   | 0   | 0  | 0   | 0   | 0   | 0   | 0   | 0   | 0   | 0   |
| 2049 | 0   | 0   | 0   | 0   | 0  | 0   | 0   | 0   | 0   | 0   | 0   | 0   | 0   |
| 2050 | 0   | 0   | 0   | 0   | 0  | 0   | 0   | 0   | 0   | 0   | 0   | 0   | 0   |
| 2051 | 0   | 0   | 0   | 0   | 0  | 0   | 0   | 0   | 0   | 0   | 0   | 0   | 0   |
| 2052 | 0   | 0   | 0   | 0   | 0  | 0   | 0   | 0   | 0   | 0   | 0   | 0   | 0   |
| 2053 | 0   | 0   | 0   | 0   | 0  | 0   | 0   | 0   | 0   | 0   | 0   | 0   | 0   |
| 2054 | 0   | 0   | 0   | 0   | 0  | 0   | 0   | 0   | 0   | 0   | 0   | 0   | 0   |
| 2055 | 0   | 0   | 0   | 0   | 0  | 0   | 0   | 0   | 0   | 0   | 0   | 0   | 0   |
| 2056 | 0   | 0   | 0   | 0   | 0  | 0   | 0   | 0   | 0   | 0   | 0   | 0   | 0   |
| 2057 | 0   | 0   | 0   | 0   | 0  | 0   | 0   | 0   | 0   | 0   | 0   | 0   | 0   |
| 2058 | 0   | 0   | 0   | 0   | 0  | 0   | 0   | 0   | 0   | 0   | 0   | 0   | 0   |
| 2059 | 0   | 0   | 0   | 0   | 0  | 0   | 0   | 0   | 0   | 0   | 0   | 0   | 0   |

| Year | 66 | 67 | 68 | 69 | 70 | 71 | 72 | 73 | 74 | 75 | 76 | 77 | 78 |
|------|----|----|----|----|----|----|----|----|----|----|----|----|----|
| 2060 | 0  | 0  | 0  | 0  | 0  | 0  | 0  | 0  | 0  | 0  | 0  | 0  | 0  |
| 2061 | 0  | 0  | 0  | 0  | 0  | 0  | 0  | 0  | 0  | 0  | 0  | 0  | 0  |
| 2062 | 0  | 0  | 0  | 0  | 0  | 0  | 0  | 0  | 0  | 0  | 0  | 0  | 0  |
| 2063 | 0  | 0  | 0  | 0  | 0  | 0  | 0  | 0  | 0  | 0  | 0  | 0  | 0  |
| 2064 | 0  | 0  | 0  | 0  | 0  | 0  | 0  | 0  | 0  | 0  | 0  | 0  | 0  |
| 2065 | 0  | 0  | 0  | 0  | 0  | 0  | 0  | 0  | 0  | 0  | 0  | 0  | 0  |
| 2066 | 0  | 0  | 0  | 0  | 0  | 0  | 0  | 0  | 0  | 0  | 0  | 0  | 0  |
| 2067 | 0  | 0  | 0  | 0  | 0  | 0  | 0  | 0  | 0  | 0  | 0  | 0  | 0  |
| 2068 | 0  | 0  | 0  | 0  | 0  | 0  | 0  | 0  | 0  | 0  | 0  | 0  | 0  |
| 2069 | 0  | 0  | 0  | 0  | 0  | 0  | 0  | 0  | 0  | 0  | 0  | 0  | 0  |
| 2070 | 0  | 0  | 0  | 0  | 0  | 0  | 0  | 0  | 0  | 0  | 0  | 0  | 0  |
| 2071 | 0  | 0  | 0  | 0  | 0  | 0  | 0  | 0  | 0  | 0  | 0  | 0  | 0  |
| 2072 | 0  | 0  | 0  | 0  | 0  | 0  | 0  | 0  | 0  | 0  | 0  | 0  | 0  |
| 2073 | 0  | 0  | 0  | 0  | 0  | 0  | 0  | 0  | 0  | 0  | 0  | 0  | 0  |
| 2074 | 0  | 0  | 0  | 0  | 0  | 0  | 0  | 0  | 0  | 0  | 0  | 0  | 0  |
| 2075 | 0  | 0  | 0  | 0  | 0  | 0  | 0  | 0  | 0  | 0  | 0  | 0  | 0  |
| 2076 | 0  | 0  | 0  | 0  | 0  | 0  | 0  | 0  | 0  | 0  | 0  | 0  | 0  |
| 2077 | 0  | 0  | 0  | 0  | 0  | 0  | 0  | 0  | 0  | 0  | 0  | 0  | 0  |
| 2078 | 0  | 0  | 0  | 0  | 0  | 0  | 0  | 0  | 0  | 0  | 0  | 0  | 0  |
| 2079 | 0  | 0  | 0  | 0  | 0  | 0  | 0  | 0  | 0  | 0  | 0  | 0  | 0  |
| 2080 | 0  | 0  | 0  | 0  | 0  | 0  | 0  | 0  | 0  | 0  | 0  | 0  | 0  |
| 2081 | 0  | 0  | 0  | 0  | 0  | 0  | 0  | 0  | 0  | 0  | 0  | 0  | 0  |
| 2082 | 0  | 0  | 0  | 0  | 0  | 0  | 0  | 0  | 0  | 0  | 0  | 0  | 0  |
| 2083 | 0  | 0  | 0  | 0  | 0  | 0  | 0  | 0  | 0  | 0  | 0  | 0  | 0  |
| 2084 | 0  | 0  | 0  | 0  | 0  | 0  | 0  | 0  | 0  | 0  | 0  | 0  | 0  |
| 2085 | 0  | 0  | 0  | 0  | 0  | 0  | 0  | 0  | 0  | 0  | 0  | 0  | 0  |
| 2086 | 0  | 0  | 0  | 0  | 0  | 0  | 0  | 0  | 0  | 0  | 0  | 0  | 0  |
| 2087 | 0  | 0  | 0  | 0  | 0  | 0  | 0  | 0  | 0  | 0  | 0  | 0  | 0  |
| 2088 | 0  | 0  | 0  | 0  | 0  | 0  | 0  | 0  | 0  | 0  | 0  | 0  | 0  |
| 2089 | 0  | 0  | 0  | 0  | 0  | 0  | 0  | 0  | 0  | 0  | 0  | 0  | 0  |

| Year | 79  | 80  | 81  | 82 | 83 | 84 | 85 | 86 | 87 | 88 | 89  | 90 | 91  |
|------|-----|-----|-----|----|----|----|----|----|----|----|-----|----|-----|
| 2002 |     |     |     |    |    |    |    |    |    |    |     |    |     |
| 2003 | 0   | 0   | 0   | 0  | 0  | 0  | 0  | 0  | 0  | 0  | 0   | 0  | 0   |
| 2004 | 0   | 0   | 0   | 0  | 0  | 0  | 0  | 0  | 0  | 0  | 0   | 0  | 0   |
| 2005 | 0   | 0   | 0   | 0  | 0  | 0  | 0  | 0  | 0  | 0  | 0   | 0  | 0   |
| 2006 | 0   | 0   | 0   | 0  | 0  | 0  | 0  | 0  | 0  | 0  | 0   | 0  | 0   |
| 2007 | 0   | 0   | 0   | 0  | 0  | 0  | 0  | 0  | 0  | 0  | 0   | 0  | 0   |
| 2008 | 0   | 0   | 0   | 0  | 0  | 0  | 0  | 0  | 0  | 0  | 0   | 0  | 0   |
| 2009 | 0   | 0   | 0   | 0  | 0  | 0  | 0  | 0  | 0  | 0  | 0   | 0  | 0   |
| 2010 | 0   | 0   | 0   | 0  | 0  | 0  | 0  | 0  | 0  | 0  | 0   | 0  | 0   |
| 2011 | 0   | 0   | 0   | 0  | 0  | 0  | 0  | 0  | 0  | 0  | 0   | 0  | 0   |
| 2012 | 0   | 0   | 0   | 0  | 0  | 0  | 0  | 0  | 0  | 0  | 0   | 0  | 0   |
| 2013 | 0   | 0   | 0   | 0  | 0  | 0  | 0  | 0  | 0  | 0  | 0   | 0  | 0   |
| 2014 | 0   | 0   | 0   | 0  | 0  | 0  | 0  | 0  | 0  | 0  | 0   | 0  | 0   |
| 2015 | 0   | 0   | 0   | 0  | 0  | 0  | 0  | 0  | 0  | 0  | 0   | 0  | 0   |
| 2016 | 0   | 0   | 0   | 0  | 0  | 0  | 0  | 0  | 0  | 0  | 0   | 0  | 0   |
| 2017 | 0   | 0   | 0   | 0  | 0  | 0  | 0  | 0  | 0  | 0  | 0   | 0  | 0   |
| 2018 | 0   | 0   | 0   | 0  | 0  | 0  | 0  | 0  | 0  | 0  | 0   | 0  | 0   |
| 2019 | 0   | 0   | 0   | 0  | 0  | 0  | 0  | 0  | 0  | 0  | 0   | 0  | 0   |
| 2020 | 0   | 0   | 0   | 0  | 0  | 0  | 0  | 0  | 0  | 0  | 0   | 0  | 0   |
| 2021 | 0   | 0   | 0   | 0  | 0  | 0  | 0  | 0  | 0  | 0  | 0   | 0  | 0   |
| 2022 | 0   | 0   | 0   | 0  | 0  | 0  | 0  | 0  | 0  | 0  | 0   | 0  | 0   |
| 2023 | 0   | 0   | 0   | 0  | 0  | 0  | 0  | 0  | 0  | 0  | 0   | 0  | 0   |
| 2024 | 0   | 0   | 0   | 0  | 0  | 0  | 0  | 0  | 0  | 0  | 0   | 0  | 0   |
| 2025 | 164 | 219 | 205 | 0  | 0  | 0  | 0  | 0  | 0  | 0  | 0   | 0  | 158 |
| 2026 | 115 | 300 | 194 | 0  | 0  | 0  | 0  | 0  | 0  | 0  | 0   | 0  | 121 |
| 2027 | 114 | 304 | 210 | 0  | 0  | 0  | 0  | 0  | 0  | 0  | 0   | 0  | 132 |
| 2028 | 116 | 303 | 237 | 0  | 0  | 0  | 0  | 0  | 0  | 0  | 0   | 0  | 129 |
| 2029 | 107 | 253 | 173 | 0  | 0  | 0  | 0  | 0  | 0  | 0  | 0   | 0  | 124 |
| 2030 | 111 | 227 | 149 | 0  | 0  | 0  | 0  | 0  | 0  | 0  | 0   | 0  | 114 |
| 2031 | 102 | 225 | 171 | 0  | 0  | 0  | 0  | 0  | 0  | 0  | 0   | 0  | 80  |
| 2032 | 86  | 211 | 151 | 0  | 0  | 0  | 0  | 0  | 0  | 0  | 0   | 0  | 88  |
| 2033 | 98  | 198 | 156 | 0  | 0  | 0  | 0  | 0  | 0  | 0  | 1   | 0  | 66  |
| 2034 | 106 | 217 | 170 | 0  | 0  | 0  | 5  | 0  | 0  | 0  | 4   | 0  | 98  |
| 2035 | 80  | 209 | 174 | 0  | 0  | 0  | 4  | 0  | 0  | 0  | 8   | 0  | 79  |
| 2036 | 77  | 187 | 151 | 0  | 0  | 0  | 15 | 0  | 0  | 0  | 14  | 0  | 68  |
| 2037 | 59  | 182 | 150 | 0  | 0  | 0  | 19 | 1  | 0  | 0  | 29  | 0  | 62  |
| 2038 | 64  | 163 | 126 | 0  | 0  | 0  | 41 | 2  | 2  | 0  | 45  | 0  | 62  |
| 2039 | 67  | 188 | 143 | 0  | 0  | 0  | 64 | 1  | 3  | 0  | 74  | 0  | 60  |
| 2040 | 86  | 202 | 158 | 0  | 0  | 0  | 40 | 2  | 2  | 0  | 103 | 0  | 85  |
| 2041 | 55  | 178 | 157 | 7  | 7  | 0  | 52 | 4  | 5  | 0  | 104 | 7  | 86  |
| 2042 | 59  | 214 | 161 | 8  | 8  | 0  | 4  | 21 | 16 | 0  | 78  | 8  | 77  |
| 2043 | 49  | 163 | 131 | 20 | 20 | 0  | 0  | 18 | 26 | 3  | 72  | 20 | 55  |
| 2044 | 44  | 173 | 143 | 21 | 21 | 0  | 0  | 42 | 37 | 0  | 77  | 21 | 40  |
| 2045 | 51  | 134 | 99  | 0  | 0  | 0  | 0  | 0  | 0  | 0  | 0   | 0  | 60  |
| 2046 | 0   | 0   | 0   | 0  | 0  | 4  | 0  | 0  | 0  | 0  | 0   | 0  | 40  |
| 2047 | 0   | 0   | 0   | 0  | 0  | 0  | 0  | 0  | 0  | 0  | 0   | 0  | 76  |
| 2048 | 0   | 0   | 0   | 0  | 0  | 0  | 0  | 0  | 0  | 0  | 0   | 0  | 0   |
| 2049 | 0   | 0   | 0   | 0  | 0  | 0  | 0  | 0  | 0  | 0  | 0   | 0  | 0   |
| 2050 | 0   | 0   | 0   | 0  | 0  | 0  | 0  | 0  | 0  | 0  | 0   | 0  | 0   |
| 2051 | 0   | 0   | 0   | 0  | 0  | 0  | 0  | 0  | 0  | 0  | 0   | 0  | 0   |
| 2052 | 0   | 0   | 0   | 0  | 0  | 0  | 0  | 0  | 0  | 0  | 0   | 0  | 0   |
| 2053 | 0   | 0   | 0   | 0  | 0  | 0  | 0  | 0  | 0  | 0  | 0   | 0  | 0   |
| 2054 | 0   | 0   | 0   | 0  | 0  | 0  | 0  | 0  | 0  | 0  | 0   | 0  | 0   |
| 2055 | 0   | 0   | 0   | 0  | 0  | 0  | 0  | 0  | 0  | 0  | 0   | 0  | 0   |
| 2056 | 0   | 0   | 0   | 0  | 0  | 0  | 0  | 0  | 0  | 0  | 0   | 0  | 0   |
| 2057 | 0   | 0   | 0   | 0  | 0  | 0  | 0  | 0  | 0  | 0  | 0   | 0  | 0   |
| 2058 | 0   | 0   | 0   | 0  | 0  | 0  | 0  | 0  | 0  | 0  | 0   | 0  | 0   |
| 2059 | 0   | 0   | 0   | 0  | 0  | 0  | 0  | 0  | 0  | 0  | 0   | 0  | 0   |

| Year | 79 | 80 | 81 | 82 | 83 | 84 | 85 | 86 | 87 | 88 | 89 | 90 | 91 |
|------|----|----|----|----|----|----|----|----|----|----|----|----|----|
| 2060 | 0  | 0  | 0  | 0  | 0  | 0  | 0  | 0  | 0  | 0  | 0  | 0  | 0  |
| 2061 | 0  | 0  | 0  | 0  | 0  | 0  | 0  | 0  | 0  | 0  | 0  | 0  | 0  |
| 2062 | 0  | 0  | 0  | 0  | 0  | 0  | 0  | 0  | 0  | 0  | 0  | 0  | 0  |
| 2063 | 0  | 0  | 0  | 0  | 0  | 0  | 0  | 0  | 0  | 0  | 0  | 0  | 0  |
| 2064 | 0  | 0  | 0  | 0  | 0  | 0  | 0  | 0  | 0  | 0  | 0  | 0  | 0  |
| 2065 | 0  | 0  | 0  | 0  | 0  | 0  | 0  | 0  | 0  | 0  | 0  | 0  | 0  |
| 2066 | 0  | 0  | 0  | 0  | 0  | 0  | 0  | 0  | 0  | 0  | 0  | 0  | 0  |
| 2067 | 0  | 0  | 0  | 0  | 0  | 0  | 0  | 0  | 0  | 0  | 0  | 0  | 0  |
| 2068 | 0  | 0  | 0  | 0  | 0  | 0  | 0  | 0  | 0  | 0  | 0  | 0  | 0  |
| 2069 | 0  | 0  | 0  | 0  | 0  | 0  | 0  | 0  | 0  | 0  | 0  | 0  | 0  |
| 2070 | 0  | 0  | 0  | 0  | 0  | 0  | 0  | 0  | 0  | 0  | 0  | 0  | 0  |
| 2071 | 0  | 0  | 0  | 0  | 0  | 0  | 0  | 0  | 0  | 0  | 0  | 0  | 0  |
| 2072 | 0  | 0  | 0  | 0  | 0  | 0  | 0  | 0  | 0  | 0  | 0  | 0  | 0  |
| 2073 | 0  | 0  | 0  | 0  | 0  | 0  | 0  | 0  | 0  | 0  | 0  | 0  | 0  |
| 2074 | 0  | 0  | 0  | 0  | 0  | 0  | 0  | 0  | 0  | 0  | 0  | 0  | 0  |
| 2075 | 0  | 0  | 0  | 0  | 0  | 0  | 0  | 0  | 0  | 0  | 0  | 0  | 0  |
| 2076 | 0  | 0  | 0  | 0  | 0  | 0  | 0  | 0  | 0  | 0  | 0  | 0  | 0  |
| 2077 | 0  | 0  | 0  | 0  | 0  | 0  | 0  | 0  | 0  | 0  | 0  | 0  | 0  |
| 2078 | 0  | 0  | 0  | 0  | 0  | 0  | 0  | 0  | 0  | 0  | 0  | 0  | 0  |
| 2079 | 0  | 0  | 0  | 0  | 0  | 0  | 0  | 0  | 0  | 0  | 0  | 0  | 0  |
| 2080 | 0  | 0  | 0  | 0  | 0  | 0  | 0  | 0  | 0  | 0  | 0  | 0  | 0  |
| 2081 | 0  | 0  | 0  | 0  | 0  | 0  | 0  | 0  | 0  | 0  | 0  | 0  | 0  |
| 2082 | 0  | 0  | 0  | 0  | 0  | 0  | 0  | 0  | 0  | 0  | 0  | 0  | 0  |
| 2083 | 0  | 0  | 0  | 0  | 0  | 0  | 0  | 0  | 0  | 0  | 0  | 0  | 0  |
| 2084 | 0  | 0  | 0  | 0  | 0  | 0  | 0  | 0  | 0  | 0  | 0  | 0  | 0  |
| 2085 | 0  | 0  | 0  | 0  | 0  | 0  | 0  | 0  | 0  | 0  | 0  | 0  | 0  |
| 2086 | 0  | 0  | 0  | 0  | 0  | 0  | 0  | 0  | 0  | 0  | 0  | 0  | 0  |
| 2087 | 0  | 0  | 0  | 0  | 0  | 0  | 0  | 0  | 0  | 0  | 0  | 0  | 0  |
| 2088 | 0  | 0  | 0  | 0  | 0  | 0  | 0  | 0  | 0  | 0  | 0  | 0  | 0  |
| 2089 | 0  | 0  | 0  | 0  | 0  | 0  | 0  | 0  | 0  | 0  | 0  | 0  | 0  |

| Year | 92  | 93  | 94  | 95  | 96  | 97 | 98  | 99  | 100 | 101 | 102 | 103 | 104 |
|------|-----|-----|-----|-----|-----|----|-----|-----|-----|-----|-----|-----|-----|
| 2002 |     |     |     |     |     |    |     |     |     |     |     |     |     |
| 2003 | 0   | 0   | 0   | 0   | 0   | 0  | 0   | 0   | 0   | 0   | 0   | 0   | 0   |
| 2004 | 0   | 0   | 0   | 0   | 0   | 0  | 0   | 0   | 0   | 0   | 0   | 0   | 0   |
| 2005 | 0   | 0   | 0   | 0   | 0   | 0  | 0   | 0   | 0   | 0   | 0   | 0   | 0   |
| 2006 | 0   | 0   | 0   | 0   | 0   | 0  | 0   | 0   | 0   | 0   | 0   | 0   | 0   |
| 2007 | 0   | 0   | 0   | 0   | 0   | 0  | 0   | 0   | 0   | 0   | 0   | 0   | 0   |
| 2008 | 0   | 0   | 0   | 0   | 0   | 0  | 0   | 0   | 0   | 0   | 0   | 0   | 0   |
| 2009 | 0   | 0   | 0   | 0   | 0   | 0  | 0   | 0   | 0   | 0   | 0   | 0   | 0   |
| 2010 | 0   | 0   | 0   | 0   | 0   | 0  | 0   | 0   | 0   | 0   | 0   | 0   | 0   |
| 2011 | 0   | 0   | 0   | 0   | 0   | 0  | 0   | 0   | 0   | 0   | 0   | 0   | 0   |
| 2012 | 0   | 0   | 0   | 0   | 0   | 0  | 0   | 0   | 0   | 0   | 0   | 0   | 0   |
| 2013 | 0   | 0   | 0   | 0   | 0   | 0  | 0   | 0   | 0   | 0   | 0   | 0   | 0   |
| 2014 | 0   | 0   | 0   | 0   | 0   | 0  | 0   | 0   | 0   | 0   | 0   | 0   | 0   |
| 2015 | 0   | 0   | 0   | 0   | 0   | 0  | 0   | 0   | 0   | 0   | 0   | 0   | 0   |
| 2016 | 0   | 0   | 0   | 0   | 0   | 0  | 0   | 0   | 0   | 0   | 0   | 0   | 0   |
| 2017 | 0   | 0   | 0   | 0   | 0   | 0  | 0   | 0   | 0   | 0   | 0   | 0   | 0   |
| 2018 | 0   | 0   | 0   | 0   | 0   | 0  | 0   | 0   | 0   | 0   | 0   | 0   | 0   |
| 2019 | 0   | 0   | 0   | 0   | 0   | 0  | 0   | 0   | 0   | 0   | 0   | 0   | 0   |
| 2020 | 0   | 0   | 141 | 0   | 0   | 0  | 0   | 0   | 0   | 0   | 0   | 211 | 0   |
| 2021 | 0   | 0   | 133 | 0   | 0   | 0  | 0   | 0   | 0   | 0   | 0   | 219 | 0   |
| 2022 | 0   | 0   | 112 | 0   | 0   | 0  | 0   | 0   | 0   | 0   | 0   | 205 | 0   |
| 2023 | 0   | 0   | 123 | 0   | 0   | 0  | 0   | 0   | 0   | 0   | 0   | 185 | 0   |
| 2024 | 0   | 0   | 121 | 0   | 0   | 0  | 0   | 0   | 0   | 0   | 0   | 201 | 0   |
| 2025 | 158 | 0   | 113 | 164 | 65  | 5  | 216 | 158 | 205 | 205 | 0   | 180 | 209 |
| 2026 | 112 | 0   | 98  | 132 | 55  | 0  | 251 | 113 | 191 | 168 | 0   | 172 | 220 |
| 2027 | 129 | 0   | 92  | 144 | 63  | 0  | 250 | 129 | 197 | 189 | 0   | 172 | 220 |
| 2028 | 124 | 0   | 88  | 146 | 74  | 11 | 255 | 124 | 204 | 200 | 0   | 200 | 236 |
| 2029 | 126 | 0   | 67  | 141 | 75  | 3  | 221 | 127 | 175 | 177 | 0   | 177 | 207 |
| 2030 | 114 | 162 | 55  | 99  | 78  | 2  | 203 | 114 | 159 | 158 | 211 | 151 | 198 |
| 2031 | 82  | 109 | 75  | 81  | 113 | 9  | 201 | 82  | 178 | 179 | 165 | 179 | 200 |
| 2032 | 88  | 119 | 45  | 90  | 81  | 5  | 181 | 88  | 152 | 154 | 162 | 164 | 181 |
| 2033 | 66  | 122 | 91  | 62  | 83  | 2  | 179 | 66  | 155 | 155 | 178 | 160 | 178 |
| 2034 | 98  | 111 | 80  | 100 | 105 | 7  | 214 | 98  | 165 | 165 | 181 | 133 | 187 |
| 2035 | 79  | 98  | 48  | 69  | 126 | 9  | 199 | 79  | 172 | 172 | 152 | 147 | 188 |
| 2036 | 68  | 76  | 61  | 65  | 57  | 14 | 146 | 68  | 149 | 149 | 132 | 150 | 165 |
| 2037 | 62  | 91  | 46  | 70  | 61  | 19 | 151 | 62  | 158 | 158 | 145 | 135 | 158 |
| 2038 | 62  | 94  | 42  | 65  | 64  | 13 | 136 | 62  | 131 | 131 | 159 | 116 | 158 |
| 2039 | 60  | 71  | 61  | 85  | 58  | 16 | 147 | 60  | 132 | 132 | 144 | 156 | 178 |
| 2040 | 85  | 97  | 91  | 99  | 77  | 32 | 186 | 85  | 159 | 159 | 135 | 150 | 209 |
| 2041 | 86  | 95  | 66  | 80  | 69  | 24 | 153 | 86  | 174 | 174 | 165 | 161 | 193 |
| 2042 | 77  | 40  | 94  | 69  | 34  | 22 | 166 | 77  | 158 | 158 | 128 | 157 | 209 |
| 2043 | 55  | 57  | 71  | 67  | 54  | 28 | 146 | 55  | 125 | 125 | 112 | 93  | 149 |
| 2044 | 40  | 55  | 98  | 55  | 69  | 22 | 121 | 40  | 142 | 142 | 146 | 0   | 163 |
| 2045 | 60  | 56  | 81  | 56  | 58  | 29 | 100 | 60  | 100 | 100 | 146 | 0   | 147 |
| 2046 | 40  | 48  | 62  | 78  | 47  | 24 | 96  | 40  | 0   | 0   | 116 | 0   | 0   |
| 2047 | 76  | 77  | 0   | 36  | 0   | 30 | 114 | 76  | 0   | 0   | 130 | 0   | 0   |
| 2048 | 0   | 77  | 0   | 0   | 0   | 0  | 0   | 0   | 0   | 0   | 33  | 0   | 0   |
| 2049 | 0   | 0   | 0   | 0   | 0   | 0  | 0   | 0   | 0   | 0   | 0   | 0   | 0   |
| 2050 | 0   | 0   | 0   | 0   | 0   | 0  | 0   | 0   | 0   | 0   | 0   | 0   | 0   |
| 2051 | 0   | 0   | 0   | 0   | 0   | 0  | 0   | 0   | 0   | 0   | 0   | 0   | 0   |
| 2052 | 0   | 0   | 0   | 0   | 0   | 0  | 0   | 0   | 0   | 0   | 0   | 0   | 0   |
| 2053 | 0   | 0   | 0   | 0   | 0   | 0  | 0   | 0   | 0   | 0   | 0   | 0   | 0   |
| 2054 | 0   | 0   | 0   | 0   | 0   | 0  | 0   | 0   | 0   | 0   | 0   | 0   | 0   |
| 2055 | 0   | 0   | 0   | 0   | 0   | 0  | 0   | 0   | 0   | 0   | 0   | 0   | 0   |
| 2056 | 0   | 0   | 0   | 0   | 0   | 0  | 0   | 0   | 0   | 0   | 0   | 0   | 0   |
| 2057 | 0   | 0   | 0   | 0   | 0   | 0  | 0   | 0   | 0   | 0   | 0   | 0   | 0   |
| 2058 | 0   | 0   | 0   | 0   | 0   | 0  | 0   | 0   | 0   | 0   | 0   | 0   | 0   |
| 2059 | 0   | 0   | 0   | 0   | 0   | 0  | 0   | 0   | 0   | 0   | 0   | 0   | 0   |

| Year | 92 | 93 | 94 | 95 | 96 | 97 | 98 | 99 | 100 | 101 | 102 | 103 | 104 |
|------|----|----|----|----|----|----|----|----|-----|-----|-----|-----|-----|
| 2060 | 0  | 0  | 0  | 0  | 0  | 0  | 0  | 0  | 0   | 0   | 0   | 0   | 0   |
| 2061 | 0  | 0  | 0  | 0  | 0  | 0  | 0  | 0  | 0   | 0   | 0   | 0   | 0   |
| 2062 | 0  | 0  | 0  | 0  | 0  | 0  | 0  | 0  | 0   | 0   | 0   | 0   | 0   |
| 2063 | 0  | 0  | 0  | 0  | 0  | 0  | 0  | 0  | 0   | 0   | 0   | 0   | 0   |
| 2064 | 0  | 0  | 0  | 0  | 0  | 0  | 0  | 0  | 0   | 0   | 0   | 0   | 0   |
| 2065 | 0  | 0  | 0  | 0  | 0  | 0  | 0  | 0  | 0   | 0   | 0   | 0   | 0   |
| 2066 | 0  | 0  | 0  | 0  | 0  | 0  | 0  | 0  | 0   | 0   | 0   | 0   | 0   |
| 2067 | 0  | 0  | 0  | 0  | 0  | 0  | 0  | 0  | 0   | 0   | 0   | 0   | 0   |
| 2068 | 0  | 0  | 0  | 0  | 0  | 0  | 0  | 0  | 0   | 0   | 0   | 0   | 0   |
| 2069 | 0  | 0  | 0  | 0  | 0  | 0  | 0  | 0  | 0   | 0   | 0   | 0   | 0   |
| 2070 | 0  | 0  | 0  | 0  | 0  | 0  | 0  | 0  | 0   | 0   | 0   | 0   | 0   |
| 2071 | 0  | 0  | 0  | 0  | 0  | 0  | 0  | 0  | 0   | 0   | 0   | 0   | 0   |
| 2072 | 0  | 0  | 0  | 0  | 0  | 0  | 0  | 0  | 0   | 0   | 0   | 0   | 0   |
| 2073 | 0  | 0  | 0  | 0  | 0  | 0  | 0  | 0  | 0   | 0   | 0   | 0   | 0   |
| 2074 | 0  | 0  | 0  | 0  | 0  | 0  | 0  | 0  | 0   | 0   | 0   | 0   | 0   |
| 2075 | 0  | 0  | 0  | 0  | 0  | 0  | 0  | 0  | 0   | 0   | 0   | 0   | 0   |
| 2076 | 0  | 0  | 0  | 0  | 0  | 0  | 0  | 0  | 0   | 0   | 0   | 0   | 0   |
| 2077 | 0  | 0  | 0  | 0  | 0  | 0  | 0  | 0  | 0   | 0   | 0   | 0   | 0   |
| 2078 | 0  | 0  | 0  | 0  | 0  | 0  | 0  | 0  | 0   | 0   | 0   | 0   | 0   |
| 2079 | 0  | 0  | 0  | 0  | 0  | 0  | 0  | 0  | 0   | 0   | 0   | 0   | 0   |
| 2080 | 0  | 0  | 0  | 0  | 0  | 0  | 0  | 0  | 0   | 0   | 0   | 0   | 0   |
| 2081 | 0  | 0  | 0  | 0  | 0  | 0  | 0  | 0  | 0   | 0   | 0   | 0   | 0   |
| 2082 | 0  | 0  | 0  | 0  | 0  | 0  | 0  | 0  | 0   | 0   | 0   | 0   | 0   |
| 2083 | 0  | 0  | 0  | 0  | 0  | 0  | 0  | 0  | 0   | 0   | 0   | 0   | 0   |
| 2084 | 0  | 0  | 0  | 0  | 0  | 0  | 0  | 0  | 0   | 0   | 0   | 0   | 0   |
| 2085 | 0  | 0  | 0  | 0  | 0  | 0  | 0  | 0  | 0   | 0   | 0   | 0   | 0   |
| 2086 | 0  | 0  | 0  | 0  | 0  | 0  | 0  | 0  | 0   | 0   | 0   | 0   | 0   |
| 2087 | 0  | 0  | 0  | 0  | 0  | 0  | 0  | 0  | 0   | 0   | 0   | 0   | 0   |
| 2088 | 0  | 0  | 0  | 0  | 0  | 0  | 0  | 0  | 0   | 0   | 0   | 0   | 0   |
| 2089 | 0  | 0  | 0  | 0  | 0  | 0  | 0  | 0  | 0   | 0   | 0   | 0   | 0   |



| Year | 105 | 106 | 107 | 108 | 109 | 110 | 111 | 112 | 113 | 114 | 115 | 116 | 117 |
|------|-----|-----|-----|-----|-----|-----|-----|-----|-----|-----|-----|-----|-----|
| 2002 |     |     |     |     |     |     |     |     |     |     |     |     |     |
| 2003 | 0   | 0   | 0   | 0   | 0   | 0   | 0   | 0   | 0   | 0   | 0   | 0   | 0   |
| 2004 | 0   | 0   | 0   | 0   | 0   | 0   | 0   | 0   | 0   | 0   | 0   | 0   | 0   |
| 2005 | 0   | 0   | 0   | 0   | 0   | 0   | 0   | 0   | 0   | 0   | 0   | 0   | 0   |
| 2006 | 0   | 0   | 0   | 0   | 0   | 0   | 0   | 0   | 0   | 0   | 0   | 0   | 0   |
| 2007 | 0   | 0   | 0   | 0   | 0   | 0   | 0   | 0   | 0   | 0   | 0   | 0   | 0   |
| 2008 | 0   | 0   | 0   | 0   | 0   | 0   | 0   | 0   | 0   | 0   | 0   | 0   | 0   |
| 2009 | 0   | 0   | 0   | 0   | 0   | 0   | 0   | 0   | 0   | 0   | 0   | 0   | 0   |
| 2010 | 0   | 0   | 0   | 0   | 0   | 0   | 0   | 0   | 0   | 0   | 0   | 0   | 0   |
| 2011 | 0   | 0   | 0   | 0   | 0   | 0   | 0   | 0   | 0   | 0   | 0   | 0   | 0   |
| 2012 | 0   | 0   | 0   | 0   | 0   | 0   | 0   | 0   | 0   | 0   | 0   | 0   | 0   |
| 2013 | 0   | 0   | 0   | 0   | 0   | 0   | 0   | 0   | 0   | 0   | 0   | 0   | 0   |
| 2014 | 0   | 0   | 0   | 0   | 0   | 0   | 0   | 0   | 0   | 0   | 0   | 0   | 0   |
| 2015 | 0   | 0   | 0   | 0   | 0   | 0   | 0   | 0   | 0   | 0   | 0   | 0   | 0   |
| 2016 | 0   | 0   | 0   | 0   | 0   | 0   | 0   | 0   | 0   | 0   | 0   | 0   | 0   |
| 2017 | 0   | 0   | 0   | 0   | 0   | 0   | 0   | 0   | 0   | 0   | 0   | 0   | 0   |
| 2018 | 0   | 0   | 0   | 0   | 0   | 0   | 0   | 0   | 0   | 0   | 0   | 0   | 0   |
| 2019 | 0   | 0   | 0   | 0   | 0   | 0   | 0   | 0   | 0   | 0   | 0   | 0   | 0   |
| 2020 | 0   | 0   | 0   | 0   | 0   | 0   | 0   | 0   | 0   | 0   | 0   | 0   | 0   |
| 2021 | 0   | 0   | 0   | 0   | 0   | 0   | 0   | 0   | 0   | 0   | 0   | 0   | 0   |
| 2022 | 0   | 0   | 0   | 0   | 0   | 0   | 0   | 0   | 0   | 0   | 0   | 0   | 0   |
| 2023 | 0   | 0   | 0   | 0   | 0   | 0   | 0   | 0   | 0   | 0   | 0   | 0   | 0   |
| 2024 | 0   | 0   | 0   | 0   | 0   | 0   | 0   | 0   | 0   | 0   | 0   | 0   | 0   |
| 2025 | 165 | 164 | 219 | 205 | 0   | 0   | 0   | 0   | 0   | 0   | 0   | 0   | 0   |
| 2026 | 104 | 112 | 267 | 175 | 0   | 0   | 0   | 0   | 0   | 0   | 0   | 0   | 0   |
| 2027 | 135 | 114 | 267 | 193 | 0   | 0   | 0   | 0   | 0   | 0   | 0   | 0   | 0   |
| 2028 | 98  | 114 | 273 | 203 | 0   | 0   | 0   | 0   | 0   | 0   | 0   | 0   | 0   |
| 2029 | 95  | 110 | 256 | 180 | 0   | 0   | 0   | 0   | 0   | 0   | 0   | 0   | 0   |
| 2030 | 121 | 111 | 229 | 157 | 0   | 0   | 0   | 0   | 0   | 0   | 0   | 0   | 0   |
| 2031 | 120 | 103 | 234 | 180 | 0   | 0   | 0   | 0   | 0   | 0   | 0   | 0   | 0   |
| 2032 | 107 | 86  | 213 | 154 | 0   | 0   | 0   | 1   | 0   | 0   | 0   | 6   | 0   |
| 2033 | 128 | 95  | 201 | 155 | 0   | 0   | 0   | 6   | 0   | 0   | 0   | 4   | 0   |
| 2034 | 142 | 102 | 227 | 165 | 0   | 0   | 0   | 18  | 0   | 0   | 0   | 34  | 0   |
| 2035 | 150 | 84  | 216 | 172 | 0   | 0   | 0   | 4   | 0   | 0   | 0   | 55  | 0   |
| 2036 | 111 | 81  | 197 | 149 | 3   | 1   | 0   | 45  | 2   | 0   | 0   | 92  | 1   |
| 2037 | 104 | 62  | 186 | 158 | 2   | 2   | 0   | 31  | 2   | 1   | 0   | 67  | 2   |
| 2038 | 97  | 64  | 172 | 131 | 4   | 4   | 0   | 51  | 7   | 2   | 0   | 106 | 4   |
| 2039 | 129 | 60  | 180 | 132 | 12  | 14  | 0   | 69  | 16  | 9   | 0   | 86  | 9   |
| 2040 | 115 | 86  | 207 | 159 | 11  | 11  | 0   | 33  | 24  | 25  | 1   | 90  | 22  |
| 2041 | 124 | 61  | 196 | 174 | 32  | 35  | 0   | 26  | 24  | 33  | 0   | 113 | 37  |
| 2042 | 66  | 54  | 215 | 158 | 31  | 27  | 1   | 0   | 48  | 49  | 2   | 109 | 30  |
| 2043 | 85  | 48  | 157 | 125 | 4   | 2   | 4   | 0   | 0   | 6   | 0   | 11  | 3   |
| 2044 | 90  | 41  | 184 | 142 | 0   | 0   | 31  | 0   | 0   | 0   | 0   | 0   | 0   |
| 2045 | 92  | 51  | 136 | 100 | 0   | 0   | 1   | 0   | 0   | 0   | 0   | 0   | 0   |
| 2046 | 0   | 0   | 0   | 0   | 0   | 0   | 0   | 0   | 0   | 0   | 0   | 0   | 0   |
| 2047 | 0   | 0   | 0   | 0   | 0   | 0   | 0   | 0   | 0   | 0   | 0   | 0   | 0   |
| 2048 | 0   | 0   | 0   | 0   | 0   | 0   | 0   | 0   | 0   | 0   | 0   | 0   | 0   |
| 2049 | 0   | 0   | 0   | 0   | 0   | 0   | 0   | 0   | 0   | 0   | 0   | 0   | 0   |
| 2050 | 0   | 0   | 0   | 0   | 0   | 0   | 0   | 0   | 0   | 0   | 0   | 0   | 0   |
| 2051 | 0   | 0   | 0   | 0   | 0   | 0   | 0   | 0   | 0   | 0   | 0   | 0   | 0   |
| 2052 | 0   | 0   | 0   | 0   | 0   | 0   | 0   | 0   | 0   | 0   | 0   | 0   | 0   |
| 2053 | 0   | 0   | 0   | 0   | 0   | 0   | 0   | 0   | 0   | 0   | 0   | 0   | 0   |
| 2054 | 0   | 0   | 0   | 0   | 0   | 0   | 0   | 0   | 0   | 0   | 0   | 0   | 0   |
| 2055 | 0   | 0   | 0   | 0   | 0   | 0   | 0   | 0   | 0   | 0   | 0   | 0   | 0   |
| 2056 | 0   | 0   | 0   | 0   | 0   | 0   | 0   | 0   | 0   | 0   | 0   | 0   | 0   |
| 2057 | 0   | 0   | 0   | 0   | 0   | 0   | 0   | 0   | 0   | 0   | 0   | 0   | 0   |
| 2058 | 0   | 0   | 0   | 0   | 0   | 0   | 0   | 0   | 0   | 0   | 0   | 0   | 0   |
| 2059 | 0   | 0   | 0   | 0   | 0   | 0   | 0   | 0   | 0   | 0   | 0   | 0   | 0   |

| Year | 105 | 106 | 107 | 108 | 109 | 110 | 111 | 112 | 113 | 114 | 115 | 116 | 117 |
|------|-----|-----|-----|-----|-----|-----|-----|-----|-----|-----|-----|-----|-----|
| 2060 | 0   | 0   | 0   | 0   | 0   | 0   | 0   | 0   | 0   | 0   | 0   | 0   | 0   |
| 2061 | 0   | 0   | 0   | 0   | 0   | 0   | 0   | 0   | 0   | 0   | 0   | 0   | 0   |
| 2062 | 0   | 0   | 0   | 0   | 0   | 0   | 0   | 0   | 0   | 0   | 0   | 0   | 0   |
| 2063 | 0   | 0   | 0   | 0   | 0   | 0   | 0   | 0   | 0   | 0   | 0   | 0   | 0   |
| 2064 | 0   | 0   | 0   | 0   | 0   | 0   | 0   | 0   | 0   | 0   | 0   | 0   | 0   |
| 2065 | 0   | 0   | 0   | 0   | 0   | 0   | 0   | 0   | 0   | 0   | 0   | 0   | 0   |
| 2066 | 0   | 0   | 0   | 0   | 0   | 0   | 0   | 0   | 0   | 0   | 0   | 0   | 0   |
| 2067 | 0   | 0   | 0   | 0   | 0   | 0   | 0   | 0   | 0   | 0   | 0   | 0   | 0   |
| 2068 | 0   | 0   | 0   | 0   | 0   | 0   | 0   | 0   | 0   | 0   | 0   | 0   | 0   |
| 2069 | 0   | 0   | 0   | 0   | 0   | 0   | 0   | 0   | 0   | 0   | 0   | 0   | 0   |
| 2070 | 0   | 0   | 0   | 0   | 0   | 0   | 0   | 0   | 0   | 0   | 0   | 0   | 0   |
| 2071 | 0   | 0   | 0   | 0   | 0   | 0   | 0   | 0   | 0   | 0   | 0   | 0   | 0   |
| 2072 | 0   | 0   | 0   | 0   | 0   | 0   | 0   | 0   | 0   | 0   | 0   | 0   | 0   |
| 2073 | 0   | 0   | 0   | 0   | 0   | 0   | 0   | 0   | 0   | 0   | 0   | 0   | 0   |
| 2074 | 0   | 0   | 0   | 0   | 0   | 0   | 0   | 0   | 0   | 0   | 0   | 0   | 0   |
| 2075 | 0   | 0   | 0   | 0   | 0   | 0   | 0   | 0   | 0   | 0   | 0   | 0   | 0   |
| 2076 | 0   | 0   | 0   | 0   | 0   | 0   | 0   | 0   | 0   | 0   | 0   | 0   | 0   |
| 2077 | 0   | 0   | 0   | 0   | 0   | 0   | 0   | 0   | 0   | 0   | 0   | 0   | 0   |
| 2078 | 0   | 0   | 0   | 0   | 0   | 0   | 0   | 0   | 0   | 0   | 0   | 0   | 0   |
| 2079 | 0   | 0   | 0   | 0   | 0   | 0   | 0   | 0   | 0   | 0   | 0   | 0   | 0   |
| 2080 | 0   | 0   | 0   | 0   | 0   | 0   | 0   | 0   | 0   | 0   | 0   | 0   | 0   |
| 2081 | 0   | 0   | 0   | 0   | 0   | 0   | 0   | 0   | 0   | 0   | 0   | 0   | 0   |
| 2082 | 0   | 0   | 0   | 0   | 0   | 0   | 0   | 0   | 0   | 0   | 0   | 0   | 0   |
| 2083 | 0   | 0   | 0   | 0   | 0   | 0   | 0   | 0   | 0   | 0   | 0   | 0   | 0   |
| 2084 | 0   | 0   | 0   | 0   | 0   | 0   | 0   | 0   | 0   | 0   | 0   | 0   | 0   |
| 2085 | 0   | 0   | 0   | 0   | 0   | 0   | 0   | 0   | 0   | 0   | 0   | 0   | 0   |
| 2086 | 0   | 0   | 0   | 0   | 0   | 0   | 0   | 0   | 0   | 0   | 0   | 0   | 0   |
| 2087 | 0   | 0   | 0   | 0   | 0   | 0   | 0   | 0   | 0   | 0   | 0   | 0   | 0   |
| 2088 | 0   | 0   | 0   | 0   | 0   | 0   | 0   | 0   | 0   | 0   | 0   | 0   | 0   |
| 2089 | 0   | 0   | 0   | 0   | 0   | 0   | 0   | 0   | 0   | 0   | 0   | 0   | 0   |

| Year | 118 | 119 | 120 | 121 | 122 | 123 | 124 | 125 | 126 | 127 | 128 | 129 | 130 |
|------|-----|-----|-----|-----|-----|-----|-----|-----|-----|-----|-----|-----|-----|
| 2002 |     |     |     |     |     |     |     |     |     |     |     |     |     |
| 2003 | 0   | 0   | 0   | 0   | 0   | 0   | 0   | 0   | 0   | 0   | 0   | 0   | 0   |
| 2004 | 0   | 0   | 0   | 0   | 0   | 0   | 0   | 0   | 0   | 0   | 0   | 0   | 0   |
| 2005 | 0   | 0   | 0   | 0   | 0   | 0   | 0   | 0   | 0   | 0   | 0   | 0   | 0   |
| 2006 | 0   | 0   | 0   | 0   | 0   | 0   | 0   | 0   | 0   | 0   | 0   | 0   | 0   |
| 2007 | 0   | 0   | 0   | 0   | 0   | 0   | 0   | 0   | 0   | 0   | 0   | 0   | 0   |
| 2008 | 0   | 0   | 0   | 0   | 0   | 0   | 0   | 0   | 0   | 0   | 0   | 0   | 0   |
| 2009 | 0   | 0   | 0   | 0   | 0   | 0   | 0   | 0   | 0   | 0   | 0   | 0   | 0   |
| 2010 | 0   | 0   | 0   | 0   | 0   | 0   | 0   | 0   | 0   | 0   | 0   | 0   | 0   |
| 2011 | 0   | 0   | 0   | 0   | 0   | 0   | 0   | 0   | 0   | 0   | 0   | 0   | 0   |
| 2012 | 0   | 0   | 0   | 0   | 0   | 0   | 0   | 0   | 0   | 0   | 0   | 0   | 0   |
| 2013 | 0   | 0   | 0   | 0   | 0   | 0   | 0   | 0   | 0   | 0   | 0   | 0   | 0   |
| 2014 | 0   | 0   | 0   | 0   | 0   | 0   | 0   | 0   | 0   | 0   | 0   | 0   | 0   |
| 2015 | 0   | 0   | 0   | 0   | 0   | 0   | 0   | 0   | 0   | 0   | 0   | 0   | 0   |
| 2016 | 0   | 0   | 0   | 0   | 0   | 0   | 0   | 0   | 0   | 0   | 0   | 0   | 0   |
| 2017 | 0   | 0   | 0   | 0   | 0   | 0   | 0   | 0   | 0   | 0   | 0   | 0   | 0   |
| 2018 | 0   | 0   | 0   | 0   | 0   | 0   | 0   | 0   | 0   | 0   | 0   | 0   | 0   |
| 2019 | 0   | 0   | 0   | 0   | 0   | 0   | 0   | 0   | 0   | 0   | 0   | 0   | 0   |
| 2020 | 0   | 0   | 0   | 141 | 0   | 0   | 0   | 0   | 0   | 0   | 0   | 0   | 211 |
| 2021 | 0   | 0   | 0   | 140 | 0   | 0   | 0   | 0   | 0   | 0   | 0   | 0   | 207 |
| 2022 | 0   | 0   | 0   | 122 | 0   | 0   | 0   | 0   | 0   | 0   | 0   | 0   | 194 |
| 2023 | 0   | 0   | 0   | 121 | 0   | 0   | 0   | 0   | 0   | 0   | 0   | 0   | 180 |
| 2024 | 0   | 0   | 0   | 106 | 0   | 0   | 0   | 0   | 0   | 0   | 0   | 0   | 201 |
| 2025 | 158 | 158 | 0   | 104 | 164 | 65  | 5   | 216 | 158 | 205 | 205 | 0   | 165 |
| 2026 | 136 | 136 | 0   | 84  | 143 | 71  | 5   | 197 | 136 | 185 | 185 | 0   | 177 |
| 2027 | 146 | 146 | 0   | 82  | 133 | 75  | 3   | 214 | 146 | 197 | 198 | 0   | 167 |
| 2028 | 114 | 114 | 0   | 74  | 100 | 76  | 8   | 183 | 114 | 177 | 177 | 0   | 181 |
| 2029 | 121 | 119 | 0   | 57  | 108 | 83  | 2   | 170 | 116 | 150 | 160 | 0   | 158 |
| 2030 | 106 | 99  | 162 | 55  | 88  | 80  | 3   | 185 | 101 | 164 | 164 | 211 | 153 |
| 2031 | 65  | 66  | 131 | 76  | 88  | 78  | 12  | 169 | 65  | 154 | 155 | 188 | 164 |
| 2032 | 64  | 72  | 122 | 60  | 67  | 59  | 4   | 166 | 69  | 158 | 154 | 172 | 136 |
| 2033 | 62  | 64  | 106 | 60  | 62  | 86  | 6   | 157 | 67  | 152 | 150 | 171 | 128 |
| 2034 | 88  | 91  | 105 | 53  | 86  | 91  | 20  | 171 | 91  | 147 | 141 | 157 | 102 |
| 2035 | 77  | 77  | 80  | 56  | 62  | 109 | 15  | 178 | 77  | 158 | 162 | 158 | 119 |
| 2036 | 52  | 62  | 91  | 59  | 59  | 85  | 12  | 114 | 55  | 121 | 125 | 159 | 106 |
| 2037 | 68  | 68  | 79  | 46  | 75  | 62  | 26  | 132 | 68  | 114 | 128 | 135 | 128 |
| 2038 | 55  | 62  | 78  | 36  | 92  | 57  | 21  | 137 | 64  | 108 | 112 | 154 | 106 |
| 2039 | 76  | 77  | 74  | 71  | 76  | 52  | 26  | 151 | 77  | 121 | 120 | 134 | 111 |
| 2040 | 56  | 57  | 100 | 77  | 92  | 77  | 19  | 173 | 57  | 134 | 136 | 128 | 128 |
| 2041 | 70  | 70  | 90  | 76  | 66  | 71  | 24  | 152 | 70  | 159 | 162 | 143 | 121 |
| 2042 | 42  | 42  | 32  | 49  | 68  | 25  | 14  | 124 | 43  | 161 | 140 | 132 | 114 |
| 2043 | 36  | 37  | 57  | 65  | 76  | 48  | 18  | 109 | 46  | 121 | 128 | 125 | 133 |
| 2044 | 36  | 40  | 52  | 56  | 59  | 68  | 21  | 95  | 34  | 121 | 117 | 136 | 114 |
| 2045 | 67  | 47  | 35  | 76  | 43  | 52  | 30  | 82  | 53  | 99  | 101 | 126 | 99  |
| 2046 | 60  | 41  | 40  | 58  | 67  | 62  | 30  | 101 | 53  | 84  | 81  | 111 | 0   |
| 2047 | 62  | 82  | 57  | 75  | 47  | 63  | 55  | 112 | 70  | 0   | 0   | 36  | 0   |
| 2048 | 59  | 55  | 0   | 127 | 0   | 35  | 48  | 71  | 57  | 0   | 0   | 0   | 0   |
| 2049 | 0   | 0   | 0   | 0   | 0   | 0   | 0   | 0   | 0   | 0   | 0   | 2   | 0   |
| 2050 | 0   | 0   | 0   | 0   | 0   | 0   | 0   | 0   | 0   | 0   | 0   | 0   | 0   |
| 2051 | 0   | 0   | 0   | 0   | 0   | 0   | 0   | 0   | 0   | 0   | 0   | 0   | 0   |
| 2052 | 0   | 0   | 0   | 0   | 0   | 0   | 0   | 0   | 0   | 0   | 0   | 0   | 0   |
| 2053 | 0   | 0   | 0   | 0   | 0   | 0   | 0   | 0   | 0   | 0   | 0   | 0   | 0   |
| 2054 | 0   | 0   | 0   | 0   | 0   | 0   | 0   | 0   | 0   | 0   | 0   | 0   | 0   |
| 2055 | 0   | 0   | 0   | 0   | 0   | 0   | 0   | 0   | 0   | 0   | 0   | 0   | 0   |
| 2056 | 0   | 0   | 0   | 0   | 0   | 0   | 0   | 0   | 0   | 0   | 0   | 0   | 0   |
| 2057 | 0   | 0   | 0   | 0   | 0   | 0   | 0   | 0   | 0   | 0   | 0   | 0   | 0   |
| 2058 | 0   | 0   | 0   | 0   | 0   | 0   | 0   | 0   | 0   | 0   | 0   | 0   | 0   |
| 2059 | 0   | 0   | 0   | 0   | 0   | 0   | 0   | 0   | 0   | 0   | 0   | 0   | 0   |

| Year | 118 | 119 | 120 | 121 | 122 | 123 | 124 | 125 | 126 | 127 | 128 | 129 | 130 |
|------|-----|-----|-----|-----|-----|-----|-----|-----|-----|-----|-----|-----|-----|
| 2060 | 0   | 0   | 0   | 0   | 0   | 0   | 0   | 0   | 0   | 0   | 0   | 0   | 0   |
| 2061 | 0   | 0   | 0   | 0   | 0   | 0   | 0   | 0   | 0   | 0   | 0   | 0   | 0   |
| 2062 | 0   | 0   | 0   | 0   | 0   | 0   | 0   | 0   | 0   | 0   | 0   | 0   | 0   |
| 2063 | 0   | 0   | 0   | 0   | 0   | 0   | 0   | 0   | 0   | 0   | 0   | 0   | 0   |
| 2064 | 0   | 0   | 0   | 0   | 0   | 0   | 0   | 0   | 0   | 0   | 0   | 0   | 0   |
| 2065 | 0   | 0   | 0   | 0   | 0   | 0   | 0   | 0   | 0   | 0   | 0   | 0   | 0   |
| 2066 | 0   | 0   | 0   | 0   | 0   | 0   | 0   | 0   | 0   | 0   | 0   | 0   | 0   |
| 2067 | 0   | 0   | 0   | 0   | 0   | 0   | 0   | 0   | 0   | 0   | 0   | 0   | 0   |
| 2068 | 0   | 0   | 0   | 0   | 0   | 0   | 0   | 0   | 0   | 0   | 0   | 0   | 0   |
| 2069 | 0   | 0   | 0   | 0   | 0   | 0   | 0   | 0   | 0   | 0   | 0   | 0   | 0   |
| 2070 | 0   | 0   | 0   | 0   | 0   | 0   | 0   | 0   | 0   | 0   | 0   | 0   | 0   |
| 2071 | 0   | 0   | 0   | 0   | 0   | 0   | 0   | 0   | 0   | 0   | 0   | 0   | 0   |
| 2072 | 0   | 0   | 0   | 0   | 0   | 0   | 0   | 0   | 0   | 0   | 0   | 0   | 0   |
| 2073 | 0   | 0   | 0   | 0   | 0   | 0   | 0   | 0   | 0   | 0   | 0   | 0   | 0   |
| 2074 | 0   | 0   | 0   | 0   | 0   | 0   | 0   | 0   | 0   | 0   | 0   | 0   | 0   |
| 2075 | 0   | 0   | 0   | 0   | 0   | 0   | 0   | 0   | 0   | 0   | 0   | 0   | 0   |
| 2076 | 0   | 0   | 0   | 0   | 0   | 0   | 0   | 0   | 0   | 0   | 0   | 0   | 0   |
| 2077 | 0   | 0   | 0   | 0   | 0   | 0   | 0   | 0   | 0   | 0   | 0   | 0   | 0   |
| 2078 | 0   | 0   | 0   | 0   | 0   | 0   | 0   | 0   | 0   | 0   | 0   | 0   | 0   |
| 2079 | 0   | 0   | 0   | 0   | 0   | 0   | 0   | 0   | 0   | 0   | 0   | 0   | 0   |
| 2080 | 0   | 0   | 0   | 0   | 0   | 0   | 0   | 0   | 0   | 0   | 0   | 0   | 0   |
| 2081 | 0   | 0   | 0   | 0   | 0   | 0   | 0   | 0   | 0   | 0   | 0   | 0   | 0   |
| 2082 | 0   | 0   | 0   | 0   | 0   | 0   | 0   | 0   | 0   | 0   | 0   | 0   | 0   |
| 2083 | 0   | 0   | 0   | 0   | 0   | 0   | 0   | 0   | 0   | 0   | 0   | 0   | 0   |
| 2084 | 0   | 0   | 0   | 0   | 0   | 0   | 0   | 0   | 0   | 0   | 0   | 0   | 0   |
| 2085 | 0   | 0   | 0   | 0   | 0   | 0   | 0   | 0   | 0   | 0   | 0   | 0   | 0   |
| 2086 | 0   | 0   | 0   | 0   | 0   | 0   | 0   | 0   | 0   | 0   | 0   | 0   | 0   |
| 2087 | 0   | 0   | 0   | 0   | 0   | 0   | 0   | 0   | 0   | 0   | 0   | 0   | 0   |
| 2088 | 0   | 0   | 0   | 0   | 0   | 0   | 0   | 0   | 0   | 0   | 0   | 0   | 0   |
| 2089 | 0   | 0   | 0   | 0   | 0   | 0   | 0   | 0   | 0   | 0   | 0   | 0   | 0   |

| Year | 131 | 132 | 133 | 134 | 135 | 136 | 137 | 138 | 139 | 140 | 141 | 142 | 143 |
|------|-----|-----|-----|-----|-----|-----|-----|-----|-----|-----|-----|-----|-----|
| 2002 |     |     |     |     |     |     |     |     |     |     |     |     |     |
| 2003 | 0   | 0   | 0   | 0   | 0   | 0   | 0   | 0   | 0   | 0   | 0   | 0   | 0   |
| 2004 | 0   | 0   | 0   | 0   | 0   | 0   | 0   | 0   | 0   | 0   | 0   | 0   | 0   |
| 2005 | 0   | 0   | 0   | 0   | 0   | 0   | 0   | 0   | 0   | 0   | 0   | 0   | 0   |
| 2006 | 0   | 0   | 0   | 0   | 0   | 0   | 0   | 0   | 0   | 0   | 0   | 0   | 0   |
| 2007 | 0   | 0   | 0   | 0   | 0   | 0   | 0   | 0   | 0   | 0   | 0   | 0   | 0   |
| 2008 | 0   | 0   | 0   | 0   | 0   | 0   | 0   | 0   | 0   | 0   | 0   | 0   | 0   |
| 2009 | 0   | 0   | 0   | 0   | 0   | 0   | 0   | 0   | 0   | 0   | 0   | 0   | 0   |
| 2010 | 0   | 0   | 0   | 0   | 0   | 0   | 0   | 0   | 0   | 0   | 0   | 0   | 0   |
| 2011 | 0   | 0   | 0   | 0   | 0   | 0   | 0   | 0   | 0   | 0   | 0   | 0   | 0   |
| 2012 | 0   | 0   | 0   | 0   | 0   | 0   | 0   | 0   | 0   | 0   | 0   | 0   | 0   |
| 2013 | 0   | 0   | 0   | 0   | 0   | 0   | 0   | 0   | 0   | 0   | 0   | 0   | 0   |
| 2014 | 0   | 0   | 0   | 0   | 0   | 0   | 0   | 0   | 0   | 0   | 0   | 0   | 0   |
| 2015 | 0   | 0   | 0   | 0   | 0   | 0   | 0   | 0   | 0   | 0   | 0   | 0   | 0   |
| 2016 | 0   | 0   | 0   | 0   | 0   | 0   | 0   | 0   | 0   | 0   | 0   | 0   | 0   |
| 2017 | 0   | 0   | 0   | 0   | 0   | 0   | 0   | 0   | 0   | 0   | 0   | 0   | 0   |
| 2018 | 0   | 0   | 0   | 0   | 0   | 0   | 0   | 0   | 0   | 0   | 0   | 0   | 0   |
| 2019 | 0   | 0   | 0   | 0   | 0   | 0   | 0   | 0   | 0   | 0   | 0   | 0   | 0   |
| 2020 | 0   | 0   | 0   | 0   | 0   | 0   | 0   | 0   | 0   | 0   | 0   | 0   | 0   |
| 2021 | 0   | 0   | 0   | 0   | 0   | 0   | 0   | 0   | 0   | 0   | 0   | 0   | 0   |
| 2022 | 0   | 0   | 0   | 0   | 0   | 0   | 0   | 0   | 0   | 0   | 0   | 0   | 0   |
| 2023 | 0   | 0   | 0   | 0   | 0   | 0   | 0   | 0   | 0   | 0   | 0   | 0   | 0   |
| 2024 | 0   | 0   | 0   | 0   | 0   | 0   | 0   | 0   | 0   | 0   | 0   | 0   | 0   |
| 2025 | 209 | 165 | 164 | 219 | 205 | 0   | 0   | 0   | 0   | 0   | 0   | 0   | 0   |
| 2026 | 205 | 118 | 137 | 212 | 185 | 0   | 0   | 0   | 0   | 0   | 0   | 0   | 0   |
| 2027 | 212 | 146 | 137 | 216 | 195 | 0   | 0   | 0   | 0   | 0   | 0   | 0   | 0   |
| 2028 | 201 | 101 | 117 | 197 | 177 | 0   | 0   | 0   | 0   | 0   | 0   | 0   | 0   |
| 2029 | 190 | 93  | 109 | 188 | 158 | 0   | 0   | 0   | 0   | 0   | 0   | 0   | 0   |
| 2030 | 188 | 125 | 102 | 191 | 160 | 0   | 0   | 0   | 0   | 0   | 0   | 0   | 0   |
| 2031 | 178 | 99  | 91  | 197 | 160 | 0   | 0   | 0   | 0   | 0   | 0   | 0   | 0   |
| 2032 | 157 | 97  | 70  | 182 | 153 | 0   | 0   | 0   | 0   | 0   | 0   | 0   | 0   |
| 2033 | 173 | 137 | 90  | 197 | 155 | 0   | 0   | 0   | 0   | 0   | 0   | 0   | 1   |
| 2034 | 155 | 120 | 83  | 183 | 139 | 0   | 0   | 0   | 7   | 0   | 0   | 0   | 5   |
| 2035 | 174 | 128 | 74  | 202 | 161 | 0   | 0   | 0   | 2   | 0   | 0   | 0   | 5   |
| 2036 | 142 | 105 | 66  | 158 | 126 | 0   | 0   | 0   | 13  | 0   | 0   | 0   | 11  |
| 2037 | 138 | 91  | 57  | 158 | 123 | 0   | 0   | 0   | 26  | 0   | 0   | 0   | 29  |
| 2038 | 143 | 105 | 70  | 158 | 111 | 0   | 0   | 0   | 43  | 2   | 2   | 0   | 51  |
| 2039 | 144 | 99  | 53  | 153 | 119 | 0   | 0   | 0   | 47  | 1   | 3   | 0   | 62  |
| 2040 | 177 | 88  | 78  | 180 | 135 | 0   | 0   | 0   | 40  | 2   | 3   | 0   | 108 |
| 2041 | 164 | 97  | 61  | 182 | 158 | 2   | 5   | 0   | 50  | 5   | 5   | 0   | 84  |
| 2042 | 187 | 42  | 48  | 191 | 150 | 3   | 3   | 0   | 8   | 14  | 10  | 0   | 80  |
| 2043 | 141 | 84  | 46  | 152 | 127 | 9   | 15  | 0   | 0   | 26  | 23  | 2   | 71  |
| 2044 | 143 | 93  | 48  | 142 | 115 | 26  | 25  | 0   | 0   | 37  | 33  | 0   | 85  |
| 2045 | 157 | 75  | 47  | 143 | 99  | 0   | 0   | 0   | 0   | 0   | 0   | 0   | 0   |
| 2046 | 92  | 68  | 24  | 113 | 82  | 0   | 0   | 2   | 0   | 0   | 0   | 0   | 0   |
| 2047 | 0   | 33  | 0   | 0   | 0   | 0   | 0   | 4   | 0   | 0   | 0   | 0   | 0   |
| 2048 | 0   | 0   | 0   | 0   | 0   | 0   | 0   | 0   | 0   | 0   | 0   | 0   | 0   |
| 2049 | 0   | 0   | 0   | 0   | 0   | 0   | 0   | 0   | 0   | 0   | 0   | 0   | 0   |
| 2050 | 0   | 0   | 0   | 0   | 0   | 0   | 0   | 0   | 0   | 0   | 0   | 0   | 0   |
| 2051 | 0   | 0   | 0   | 0   | 0   | 0   | 0   | 0   | 0   | 0   | 0   | 0   | 0   |
| 2052 | 0   | 0   | 0   | 0   | 0   | 0   | 0   | 0   | 0   | 0   | 0   | 0   | 0   |
| 2053 | 0   | 0   | 0   | 0   | 0   | 0   | 0   | 0   | 0   | 0   | 0   | 0   | 0   |
| 2054 | 0   | 0   | 0   | 0   | 0   | 0   | 0   | 0   | 0   | 0   | 0   | 0   | 0   |
| 2055 | 0   | 0   | 0   | 0   | 0   | 0   | 0   | 0   | 0   | 0   | 0   | 0   | 0   |
| 2056 | 0   | 0   | 0   | 0   | 0   | 0   | 0   | 0   | 0   | 0   | 0   | 0   | 0   |
| 2057 | 0   | 0   | 0   | 0   | 0   | 0   | 0   | 0   | 0   | 0   | 0   | 0   | 0   |
| 2058 | 0   | 0   | 0   | 0   | 0   | 0   | 0   | 0   | 0   | 0   | 0   | 0   | 0   |
| 2059 | 0   | 0   | 0   | 0   | 0   | 0   | 0   | 0   | 0   | 0   | 0   | 0   | 0   |

| Year | 131 | 132 | 133 | 134 | 135 | 136 | 137 | 138 | 139 | 140 | 141 | 142 | 143 |
|------|-----|-----|-----|-----|-----|-----|-----|-----|-----|-----|-----|-----|-----|
| 2060 | 0   | 0   | 0   | 0   | 0   | 0   | 0   | 0   | 0   | 0   | 0   | 0   | 0   |
| 2061 | 0   | 0   | 0   | 0   | 0   | 0   | 0   | 0   | 0   | 0   | 0   | 0   | 0   |
| 2062 | 0   | 0   | 0   | 0   | 0   | 0   | 0   | 0   | 0   | 0   | 0   | 0   | 0   |
| 2063 | 0   | 0   | 0   | 0   | 0   | 0   | 0   | 0   | 0   | 0   | 0   | 0   | 0   |
| 2064 | 0   | 0   | 0   | 0   | 0   | 0   | 0   | 0   | 0   | 0   | 0   | 0   | 0   |
| 2065 | 0   | 0   | 0   | 0   | 0   | 0   | 0   | 0   | 0   | 0   | 0   | 0   | 0   |
| 2066 | 0   | 0   | 0   | 0   | 0   | 0   | 0   | 0   | 0   | 0   | 0   | 0   | 0   |
| 2067 | 0   | 0   | 0   | 0   | 0   | 0   | 0   | 0   | 0   | 0   | 0   | 0   | 0   |
| 2068 | 0   | 0   | 0   | 0   | 0   | 0   | 0   | 0   | 0   | 0   | 0   | 0   | 0   |
| 2069 | 0   | 0   | 0   | 0   | 0   | 0   | 0   | 0   | 0   | 0   | 0   | 0   | 0   |
| 2070 | 0   | 0   | 0   | 0   | 0   | 0   | 0   | 0   | 0   | 0   | 0   | 0   | 0   |
| 2071 | 0   | 0   | 0   | 0   | 0   | 0   | 0   | 0   | 0   | 0   | 0   | 0   | 0   |
| 2072 | 0   | 0   | 0   | 0   | 0   | 0   | 0   | 0   | 0   | 0   | 0   | 0   | 0   |
| 2073 | 0   | 0   | 0   | 0   | 0   | 0   | 0   | 0   | 0   | 0   | 0   | 0   | 0   |
| 2074 | 0   | 0   | 0   | 0   | 0   | 0   | 0   | 0   | 0   | 0   | 0   | 0   | 0   |
| 2075 | 0   | 0   | 0   | 0   | 0   | 0   | 0   | 0   | 0   | 0   | 0   | 0   | 0   |
| 2076 | 0   | 0   | 0   | 0   | 0   | 0   | 0   | 0   | 0   | 0   | 0   | 0   | 0   |
| 2077 | 0   | 0   | 0   | 0   | 0   | 0   | 0   | 0   | 0   | 0   | 0   | 0   | 0   |
| 2078 | 0   | 0   | 0   | 0   | 0   | 0   | 0   | 0   | 0   | 0   | 0   | 0   | 0   |
| 2079 | 0   | 0   | 0   | 0   | 0   | 0   | 0   | 0   | 0   | 0   | 0   | 0   | 0   |
| 2080 | 0   | 0   | 0   | 0   | 0   | 0   | 0   | 0   | 0   | 0   | 0   | 0   | 0   |
| 2081 | 0   | 0   | 0   | 0   | 0   | 0   | 0   | 0   | 0   | 0   | 0   | 0   | 0   |
| 2082 | 0   | 0   | 0   | 0   | 0   | 0   | 0   | 0   | 0   | 0   | 0   | 0   | 0   |
| 2083 | 0   | 0   | 0   | 0   | 0   | 0   | 0   | 0   | 0   | 0   | 0   | 0   | 0   |
| 2084 | 0   | 0   | 0   | 0   | 0   | 0   | 0   | 0   | 0   | 0   | 0   | 0   | 0   |
| 2085 | 0   | 0   | 0   | 0   | 0   | 0   | 0   | 0   | 0   | 0   | 0   | 0   | 0   |
| 2086 | 0   | 0   | 0   | 0   | 0   | 0   | 0   | 0   | 0   | 0   | 0   | 0   | 0   |
| 2087 | 0   | 0   | 0   | 0   | 0   | 0   | 0   | 0   | 0   | 0   | 0   | 0   | 0   |
| 2088 | 0   | 0   | 0   | 0   | 0   | 0   | 0   | 0   | 0   | 0   | 0   | 0   | 0   |
| 2089 | 0   | 0   | 0   | 0   | 0   | 0   | 0   | 0   | 0   | 0   | 0   | 0   | 0   |

| Year | 144 | 145 | 146 | 147 | 148 | 149 | 150 | 151 | 152 | 153 | 154 | 155 | 156 |
|------|-----|-----|-----|-----|-----|-----|-----|-----|-----|-----|-----|-----|-----|
| 2002 |     |     |     |     |     |     |     |     |     |     |     |     |     |
| 2003 | 0   | 0   | 0   | 0   | 0   | 0   | 0   | 0   | 0   | 0   | 0   | 0   | 0   |
| 2004 | 0   | 0   | 0   | 0   | 0   | 0   | 0   | 0   | 0   | 0   | 0   | 0   | 0   |
| 2005 | 0   | 0   | 0   | 0   | 0   | 0   | 0   | 0   | 0   | 0   | 0   | 0   | 0   |
| 2006 | 0   | 0   | 0   | 0   | 0   | 0   | 0   | 0   | 0   | 0   | 0   | 0   | 0   |
| 2007 | 0   | 0   | 0   | 0   | 0   | 0   | 0   | 0   | 0   | 0   | 0   | 0   | 0   |
| 2008 | 0   | 0   | 0   | 0   | 0   | 0   | 0   | 0   | 0   | 0   | 0   | 0   | 0   |
| 2009 | 0   | 0   | 0   | 0   | 0   | 0   | 0   | 0   | 0   | 0   | 0   | 0   | 0   |
| 2010 | 0   | 0   | 0   | 0   | 0   | 0   | 0   | 0   | 0   | 0   | 0   | 0   | 0   |
| 2011 | 0   | 0   | 0   | 0   | 0   | 0   | 0   | 0   | 0   | 0   | 0   | 0   | 0   |
| 2012 | 0   | 0   | 0   | 0   | 0   | 0   | 0   | 0   | 0   | 0   | 0   | 0   | 0   |
| 2013 | 0   | 0   | 0   | 0   | 0   | 0   | 0   | 0   | 0   | 0   | 0   | 0   | 0   |
| 2014 | 0   | 0   | 0   | 0   | 0   | 0   | 0   | 0   | 0   | 0   | 0   | 0   | 0   |
| 2015 | 0   | 0   | 0   | 0   | 0   | 0   | 0   | 0   | 0   | 0   | 0   | 0   | 0   |
| 2016 | 0   | 0   | 0   | 0   | 0   | 0   | 0   | 0   | 0   | 0   | 0   | 0   | 0   |
| 2017 | 0   | 0   | 0   | 0   | 0   | 0   | 0   | 0   | 0   | 0   | 0   | 0   | 0   |
| 2018 | 0   | 0   | 0   | 0   | 0   | 0   | 0   | 0   | 0   | 0   | 0   | 0   | 0   |
| 2019 | 0   | 0   | 0   | 0   | 0   | 0   | 0   | 0   | 0   | 0   | 0   | 0   | 0   |
| 2020 | 0   | 0   | 0   | 0   | 141 | 0   | 0   | 0   | 0   | 0   | 0   | 0   | 0   |
| 2021 | 0   | 0   | 0   | 0   | 126 | 0   | 0   | 0   | 0   | 0   | 0   | 0   | 0   |
| 2022 | 0   | 0   | 0   | 0   | 106 | 0   | 0   | 0   | 0   | 0   | 0   | 0   | 0   |
| 2023 | 0   | 0   | 0   | 0   | 119 | 0   | 0   | 0   | 0   | 0   | 0   | 0   | 0   |
| 2024 | 0   | 0   | 0   | 0   | 128 | 0   | 0   | 0   | 0   | 0   | 0   | 0   | 0   |
| 2025 | 0   | 158 | 158 | 0   | 114 | 164 | 65  | 5   | 216 | 158 | 205 | 205 | 0   |
| 2026 | 0   | 110 | 118 | 0   | 102 | 133 | 58  | 0   | 201 | 115 | 151 | 166 | 0   |
| 2027 | 0   | 120 | 133 | 0   | 88  | 134 | 57  | 0   | 207 | 122 | 172 | 189 | 0   |
| 2028 | 0   | 124 | 107 | 0   | 85  | 134 | 72  | 11  | 252 | 121 | 187 | 193 | 0   |
| 2029 | 0   | 125 | 118 | 0   | 64  | 132 | 76  | 3   | 230 | 122 | 166 | 158 | 0   |
| 2030 | 0   | 112 | 102 | 162 | 60  | 105 | 77  | 2   | 203 | 113 | 177 | 157 | 211 |
| 2031 | 0   | 70  | 79  | 114 | 75  | 82  | 114 | 9   | 209 | 78  | 167 | 177 | 170 |
| 2032 | 0   | 90  | 95  | 115 | 54  | 89  | 77  | 5   | 191 | 93  | 154 | 155 | 156 |
| 2033 | 0   | 71  | 70  | 121 | 93  | 65  | 90  | 2   | 180 | 70  | 156 | 152 | 171 |
| 2034 | 0   | 92  | 92  | 121 | 92  | 92  | 105 | 7   | 200 | 92  | 168 | 170 | 182 |
| 2035 | 0   | 77  | 77  | 86  | 44  | 75  | 114 | 9   | 200 | 81  | 180 | 168 | 149 |
| 2036 | 0   | 74  | 70  | 73  | 65  | 71  | 71  | 16  | 158 | 75  | 142 | 149 | 127 |
| 2037 | 0   | 65  | 63  | 86  | 40  | 65  | 63  | 15  | 155 | 66  | 150 | 157 | 139 |
| 2038 | 0   | 65  | 63  | 99  | 45  | 66  | 63  | 15  | 136 | 61  | 135 | 127 | 164 |
| 2039 | 0   | 49  | 60  | 79  | 72  | 89  | 59  | 11  | 149 | 55  | 130 | 135 | 141 |
| 2040 | 0   | 77  | 87  | 105 | 89  | 99  | 85  | 32  | 176 | 77  | 164 | 160 | 141 |
| 2041 | 3   | 89  | 87  | 92  | 67  | 74  | 64  | 25  | 163 | 89  | 166 | 163 | 155 |
| 2042 | 7   | 76  | 77  | 38  | 95  | 77  | 30  | 22  | 167 | 77  | 148 | 160 | 132 |
| 2043 | 17  | 54  | 55  | 48  | 85  | 59  | 67  | 28  | 135 | 59  | 116 | 115 | 106 |
| 2044 | 20  | 43  | 38  | 63  | 84  | 59  | 64  | 26  | 117 | 40  | 143 | 142 | 127 |
| 2045 | 0   | 70  | 53  | 53  | 48  | 56  | 67  | 27  | 101 | 52  | 129 | 116 | 152 |
| 2046 | 0   | 50  | 50  | 41  | 0   | 70  | 51  | 22  | 95  | 48  | 0   | 19  | 123 |
| 2047 | 0   | 75  | 79  | 69  | 0   | 44  | 25  | 39  | 134 | 84  | 0   | 0   | 136 |
| 2048 | 0   | 0   | 0   | 91  | 0   | 0   | 0   | 0   | 0   | 0   | 0   | 0   | 68  |
| 2049 | 0   | 0   | 0   | 16  | 0   | 0   | 0   | 0   | 0   | 0   | 0   | 0   | 0   |
| 2050 | 0   | 0   | 0   | 0   | 0   | 0   | 0   | 0   | 0   | 0   | 0   | 0   | 0   |
| 2051 | 0   | 0   | 0   | 0   | 0   | 0   | 0   | 0   | 0   | 0   | 0   | 0   | 0   |
| 2052 | 0   | 0   | 0   | 0   | 0   | 0   | 0   | 0   | 0   | 0   | 0   | 0   | 0   |
| 2053 | 0   | 0   | 0   | 0   | 0   | 0   | 0   | 0   | 0   | 0   | 0   | 0   | 0   |
| 2054 | 0   | 0   | 0   | 0   | 0   | 0   | 0   | 0   | 0   | 0   | 0   | 0   | 0   |
| 2055 | 0   | 0   | 0   | 0   | 0   | 0   | 0   | 0   | 0   | 0   | 0   | 0   | 0   |
| 2056 | 0   | 0   | 0   | 0   | 0   | 0   | 0   | 0   | 0   | 0   | 0   | 0   | 0   |
| 2057 | 0   | 0   | 0   | 0   | 0   | 0   | 0   | 0   | 0   | 0   | 0   | 0   | 0   |
| 2058 | 0   | 0   | 0   | 0   | 0   | 0   | 0   | 0   | 0   | 0   | 0   | 0   | 0   |
| 2059 | 0   | 0   | 0   | 0   | 0   | 0   | 0   | 0   | 0   | 0   | 0   | 0   | 0   |

| Year | 144 | 145 | 146 | 147 | 148 | 149 | 150 | 151 | 152 | 153 | 154 | 155 | 156 |
|------|-----|-----|-----|-----|-----|-----|-----|-----|-----|-----|-----|-----|-----|
| 2060 | 0   | 0   | 0   | 0   | 0   | 0   | 0   | 0   | 0   | 0   | 0   | 0   | 0   |
| 2061 | 0   | 0   | 0   | 0   | 0   | 0   | 0   | 0   | 0   | 0   | 0   | 0   | 0   |
| 2062 | 0   | 0   | 0   | 0   | 0   | 0   | 0   | 0   | 0   | 0   | 0   | 0   | 0   |
| 2063 | 0   | 0   | 0   | 0   | 0   | 0   | 0   | 0   | 0   | 0   | 0   | 0   | 0   |
| 2064 | 0   | 0   | 0   | 0   | 0   | 0   | 0   | 0   | 0   | 0   | 0   | 0   | 0   |
| 2065 | 0   | 0   | 0   | 0   | 0   | 0   | 0   | 0   | 0   | 0   | 0   | 0   | 0   |
| 2066 | 0   | 0   | 0   | 0   | 0   | 0   | 0   | 0   | 0   | 0   | 0   | 0   | 0   |
| 2067 | 0   | 0   | 0   | 0   | 0   | 0   | 0   | 0   | 0   | 0   | 0   | 0   | 0   |
| 2068 | 0   | 0   | 0   | 0   | 0   | 0   | 0   | 0   | 0   | 0   | 0   | 0   | 0   |
| 2069 | 0   | 0   | 0   | 0   | 0   | 0   | 0   | 0   | 0   | 0   | 0   | 0   | 0   |
| 2070 | 0   | 0   | 0   | 0   | 0   | 0   | 0   | 0   | 0   | 0   | 0   | 0   | 0   |
| 2071 | 0   | 0   | 0   | 0   | 0   | 0   | 0   | 0   | 0   | 0   | 0   | 0   | 0   |
| 2072 | 0   | 0   | 0   | 0   | 0   | 0   | 0   | 0   | 0   | 0   | 0   | 0   | 0   |
| 2073 | 0   | 0   | 0   | 0   | 0   | 0   | 0   | 0   | 0   | 0   | 0   | 0   | 0   |
| 2074 | 0   | 0   | 0   | 0   | 0   | 0   | 0   | 0   | 0   | 0   | 0   | 0   | 0   |
| 2075 | 0   | 0   | 0   | 0   | 0   | 0   | 0   | 0   | 0   | 0   | 0   | 0   | 0   |
| 2076 | 0   | 0   | 0   | 0   | 0   | 0   | 0   | 0   | 0   | 0   | 0   | 0   | 0   |
| 2077 | 0   | 0   | 0   | 0   | 0   | 0   | 0   | 0   | 0   | 0   | 0   | 0   | 0   |
| 2078 | 0   | 0   | 0   | 0   | 0   | 0   | 0   | 0   | 0   | 0   | 0   | 0   | 0   |
| 2079 | 0   | 0   | 0   | 0   | 0   | 0   | 0   | 0   | 0   | 0   | 0   | 0   | 0   |
| 2080 | 0   | 0   | 0   | 0   | 0   | 0   | 0   | 0   | 0   | 0   | 0   | 0   | 0   |
| 2081 | 0   | 0   | 0   | 0   | 0   | 0   | 0   | 0   | 0   | 0   | 0   | 0   | 0   |
| 2082 | 0   | 0   | 0   | 0   | 0   | 0   | 0   | 0   | 0   | 0   | 0   | 0   | 0   |
| 2083 | 0   | 0   | 0   | 0   | 0   | 0   | 0   | 0   | 0   | 0   | 0   | 0   | 0   |
| 2084 | 0   | 0   | 0   | 0   | 0   | 0   | 0   | 0   | 0   | 0   | 0   | 0   | 0   |
| 2085 | 0   | 0   | 0   | 0   | 0   | 0   | 0   | 0   | 0   | 0   | 0   | 0   | 0   |
| 2086 | 0   | 0   | 0   | 0   | 0   | 0   | 0   | 0   | 0   | 0   | 0   | 0   | 0   |
| 2087 | 0   | 0   | 0   | 0   | 0   | 0   | 0   | 0   | 0   | 0   | 0   | 0   | 0   |
| 2088 | 0   | 0   | 0   | 0   | 0   | 0   | 0   | 0   | 0   | 0   | 0   | 0   | 0   |
| 2089 | 0   | 0   | 0   | 0   | 0   | 0   | 0   | 0   | 0   | 0   | 0   | 0   | 0   |



| Year | 157 | 158 | 159 | 160 | 161 | 162 |
|------|-----|-----|-----|-----|-----|-----|
| 2002 |     |     |     |     |     |     |
| 2003 | 0   | 0   | 0   | 0   | 0   | 0   |
| 2004 | 0   | 0   | 0   | 0   | 0   | 0   |
| 2005 | 0   | 0   | 0   | 0   | 0   | 0   |
| 2006 | 0   | 0   | 0   | 0   | 0   | 0   |
| 2007 | 0   | 0   | 0   | 0   | 0   | 0   |
| 2008 | 0   | 0   | 0   | 0   | 0   | 0   |
| 2009 | 0   | 0   | 0   | 0   | 0   | 0   |
| 2010 | 0   | 0   | 0   | 0   | 0   | 0   |
| 2011 | 0   | 0   | 0   | 0   | 0   | 0   |
| 2012 | 0   | 0   | 0   | 0   | 0   | 0   |
| 2013 | 0   | 0   | 0   | 0   | 0   | 0   |
| 2014 | 0   | 0   | 0   | 0   | 0   | 0   |
| 2015 | 0   | 0   | 0   | 0   | 0   | 0   |
| 2016 | 0   | 0   | 0   | 0   | 0   | 0   |
| 2017 | 0   | 0   | 0   | 0   | 0   | 0   |
| 2018 | 0   | 0   | 0   | 0   | 0   | 0   |
| 2019 | 0   | 0   | 0   | 0   | 0   | 0   |
| 2020 | 211 | 0   | 0   | 0   | 0   | 0   |
| 2021 | 185 | 0   | 0   | 0   | 0   | 0   |
| 2022 | 184 | 0   | 0   | 0   | 0   | 0   |
| 2023 | 186 | 0   | 0   | 0   | 0   | 0   |
| 2024 | 209 | 0   | 0   | 0   | 0   | 0   |
| 2025 | 180 | 209 | 165 | 164 | 219 | 205 |
| 2026 | 178 | 192 | 101 | 115 | 223 | 167 |
| 2027 | 168 | 194 | 125 | 107 | 227 | 174 |
| 2028 | 196 | 224 | 92  | 112 | 270 | 193 |
| 2029 | 172 | 205 | 98  | 107 | 263 | 172 |
| 2030 | 153 | 201 | 122 | 110 | 229 | 165 |
| 2031 | 178 | 202 | 126 | 101 | 242 | 176 |
| 2032 | 158 | 183 | 108 | 85  | 217 | 155 |
| 2033 | 157 | 176 | 134 | 97  | 194 | 153 |
| 2034 | 142 | 187 | 138 | 103 | 223 | 171 |
| 2035 | 152 | 191 | 150 | 84  | 215 | 170 |
| 2036 | 149 | 165 | 109 | 81  | 195 | 147 |
| 2037 | 136 | 159 | 108 | 63  | 189 | 158 |
| 2038 | 114 | 162 | 99  | 66  | 174 | 134 |
| 2039 | 156 | 181 | 132 | 57  | 182 | 131 |
| 2040 | 148 | 203 | 114 | 84  | 209 | 164 |
| 2041 | 173 | 186 | 122 | 65  | 193 | 172 |
| 2042 | 157 | 223 | 66  | 48  | 221 | 156 |
| 2043 | 95  | 146 | 99  | 42  | 149 | 114 |
| 2044 | 0   | 159 | 78  | 39  | 169 | 136 |
| 2045 | 0   | 143 | 118 | 56  | 172 | 124 |
| 2046 | 0   | 1   | 13  | 0   | 0   | 0   |
| 2047 | 0   | 0   | 0   | 0   | 0   | 0   |
| 2048 | 0   | 0   | 0   | 0   | 0   | 0   |
| 2049 | 0   | 0   | 0   | 0   | 0   | 0   |
| 2050 | 0   | 0   | 0   | 0   | 0   | 0   |
| 2051 | 0   | 0   | 0   | 0   | 0   | 0   |
| 2052 | 0   | 0   | 0   | 0   | 0   | 0   |
| 2053 | 0   | 0   | 0   | 0   | 0   | 0   |
| 2054 | 0   | 0   | 0   | 0   | 0   | 0   |
| 2055 | 0   | 0   | 0   | 0   | 0   | 0   |
| 2056 | 0   | 0   | 0   | 0   | 0   | 0   |
| 2057 | 0   | 0   | 0   | 0   | 0   | 0   |
| 2058 | 0   | 0   | 0   | 0   | 0   | 0   |
| 2059 | 0   | 0   | 0   | 0   | 0   | 0   |

| Year | 157 | 158 | 159 | 160 | 161 | 162 |
|------|-----|-----|-----|-----|-----|-----|
| 2060 | 0   | 0   | 0   | 0   | 0   | 0   |
| 2061 | 0   | 0   | 0   | 0   | 0   | 0   |
| 2062 | 0   | 0   | 0   | 0   | 0   | 0   |
| 2063 | 0   | 0   | 0   | 0   | 0   | 0   |
| 2064 | 0   | 0   | 0   | 0   | 0   | 0   |
| 2065 | 0   | 0   | 0   | 0   | 0   | 0   |
| 2066 | 0   | 0   | 0   | 0   | 0   | 0   |
| 2067 | 0   | 0   | 0   | 0   | 0   | 0   |
| 2068 | 0   | 0   | 0   | 0   | 0   | 0   |
| 2069 | 0   | 0   | 0   | 0   | 0   | 0   |
| 2070 | 0   | 0   | 0   | 0   | 0   | 0   |
| 2071 | 0   | 0   | 0   | 0   | 0   | 0   |
| 2072 | 0   | 0   | 0   | 0   | 0   | 0   |
| 2073 | 0   | 0   | 0   | 0   | 0   | 0   |
| 2074 | 0   | 0   | 0   | 0   | 0   | 0   |
| 2075 | 0   | 0   | 0   | 0   | 0   | 0   |
| 2076 | 0   | 0   | 0   | 0   | 0   | 0   |
| 2077 | 0   | 0   | 0   | 0   | 0   | 0   |
| 2078 | 0   | 0   | 0   | 0   | 0   | 0   |
| 2079 | 0   | 0   | 0   | 0   | 0   | 0   |
| 2080 | 0   | 0   | 0   | 0   | 0   | 0   |
| 2081 | 0   | 0   | 0   | 0   | 0   | 0   |
| 2082 | 0   | 0   | 0   | 0   | 0   | 0   |
| 2083 | 0   | 0   | 0   | 0   | 0   | 0   |
| 2084 | 0   | 0   | 0   | 0   | 0   | 0   |
| 2085 | 0   | 0   | 0   | 0   | 0   | 0   |
| 2086 | 0   | 0   | 0   | 0   | 0   | 0   |
| 2087 | 0   | 0   | 0   | 0   | 0   | 0   |
| 2088 | 0   | 0   | 0   | 0   | 0   | 0   |
| 2089 | 0   | 0   | 0   | 0   | 0   | 0   |

| 12%  | 1   | 2  | 3  | 4  | 5  | 6  | 7  | 8  | 9  | 10  | 11 | 12 | 13 |
|------|-----|----|----|----|----|----|----|----|----|-----|----|----|----|
| 2002 |     |    |    |    |    |    |    |    |    |     |    |    |    |
| 2003 | 0   | 0  | 0  | 0  | 0  | 0  | 0  | 0  | 0  | 0   | 0  | 0  | 0  |
| 2004 | 0   | 0  | 0  | 0  | 0  | 0  | 0  | 0  | 0  | 0   | 0  | 0  | 0  |
| 2005 | 0   | 0  | 0  | 0  | 0  | 0  | 0  | 0  | 0  | 0   | 0  | 0  | 0  |
| 2006 | 0   | 0  | 0  | 0  | 0  | 0  | 0  | 0  | 0  | 0   | 0  | 0  | 0  |
| 2007 | 0   | 0  | 0  | 0  | 0  | 0  | 0  | 0  | 0  | 0   | 0  | 0  | 0  |
| 2008 | 0   | 0  | 0  | 0  | 0  | 0  | 0  | 0  | 0  | 0   | 0  | 0  | 0  |
| 2009 | 0   | 0  | 0  | 0  | 0  | 0  | 0  | 0  | 0  | 0   | 0  | 0  | 0  |
| 2010 | 0   | 0  | 0  | 0  | 0  | 0  | 0  | 0  | 0  | 0   | 0  | 0  | 0  |
| 2011 | 0   | 0  | 0  | 0  | 0  | 0  | 0  | 0  | 0  | 0   | 0  | 0  | 0  |
| 2012 | 0   | 0  | 0  | 0  | 0  | 0  | 0  | 0  | 0  | 0   | 0  | 0  | 0  |
| 2013 | 0   | 0  | 0  | 0  | 0  | 0  | 0  | 0  | 0  | 0   | 0  | 0  | 0  |
| 2014 | 0   | 0  | 0  | 0  | 0  | 0  | 0  | 0  | 0  | 0   | 0  | 0  | 0  |
| 2015 | 0   | 0  | 0  | 0  | 0  | 0  | 0  | 0  | 0  | 0   | 0  | 0  | 0  |
| 2016 | 0   | 0  | 0  | 0  | 0  | 0  | 0  | 0  | 0  | 0   | 0  | 0  | 0  |
| 2017 | 0   | 0  | 0  | 0  | 0  | 0  | 0  | 0  | 0  | 0   | 0  | 0  | 0  |
| 2018 | 0   | 0  | 0  | 0  | 0  | 0  | 0  | 0  | 0  | 0   | 0  | 0  | 0  |
| 2019 | 0   | 0  | 0  | 0  | 0  | 0  | 0  | 0  | 0  | 0   | 0  | 0  | 0  |
| 2020 | 0   | 0  | 0  | 0  | 0  | 0  | 0  | 0  | 0  | 0   | 0  | 0  | 0  |
| 2021 | 0   | 0  | 0  | 0  | 0  | 0  | 0  | 0  | 0  | 0   | 0  | 0  | 3  |
| 2022 | 0   | 0  | 0  | 0  | 0  | 0  | 0  | 0  | 0  | 0   | 0  | 0  | 0  |
| 2023 | 0   | 0  | 0  | 0  | 0  | 0  | 0  | 0  | 0  | 0   | 0  | 0  | 4  |
| 2024 | 0   | 0  | 0  | 0  | 0  | 0  | 0  | 0  | 0  | 0   | 0  | 0  | 3  |
| 2025 | 0   | 0  | 0  | 0  | 0  | 0  | 0  | 0  | 0  | 0   | 0  | 0  | 9  |
| 2026 | 0   | 0  | 0  | 0  | 0  | 0  | 0  | 0  | 0  | 0   | 0  | 0  | 13 |
| 2027 | 0   | 0  | 0  | 0  | 0  | 0  | 0  | 0  | 0  | 6   | 0  | 0  | 12 |
| 2028 | 0   | 0  | 0  | 0  | 0  | 0  | 0  | 0  | 0  | 0   | 0  | 0  | 9  |
| 2029 | 0   | 0  | 0  | 0  | 0  | 0  | 0  | 0  | 0  | 9   | 3  | 0  | 5  |
| 2030 | 0   | 0  | 0  | 0  | 0  | 0  | 0  | 0  | 0  | 9   | 0  | 0  | 16 |
| 2031 | 0   | 0  | 0  | 0  | 0  | 0  | 0  | 0  | 0  | 10  | 0  | 0  | 24 |
| 2032 | 0   | 0  | 0  | 0  | 0  | 0  | 0  | 0  | 0  | 24  | 3  | 0  | 23 |
| 2033 | 4   | 0  | 0  | 6  | 0  | 0  | 0  | 0  | 0  | 22  | 5  | 0  | 20 |
| 2034 | 0   | 0  | 0  | 0  | 0  | 0  | 0  | 0  | 0  | 10  | 3  | 0  | 29 |
| 2035 | 0   | 0  | 0  | 3  | 0  | 0  | 0  | 0  | 0  | 11  | 3  | 6  | 16 |
| 2036 | 12  | 0  | 0  | 6  | 0  | 0  | 0  | 0  | 0  | 32  | 0  | 1  | 12 |
| 2037 | 3   | 0  | 0  | 5  | 0  | 6  | 0  | 0  | 0  | 29  | 0  | 6  | 4  |
| 2038 | 5   | 0  | 0  | 4  | 0  | 9  | 0  | 0  | 0  | 19  | 12 | 6  | 17 |
| 2039 | 16  | 0  | 0  | 13 | 0  | 0  | 6  | 6  | 6  | 21  | 7  | 2  | 2  |
| 2040 | 15  | 0  | 0  | 6  | 0  | 1  | 4  | 4  | 4  | 12  | 2  | 6  | 7  |
| 2041 | 4   | 0  | 0  | 17 | 0  | 0  | 12 | 12 | 12 | 14  | 14 | 5  | 0  |
| 2042 | 17  | 8  | 0  | 45 | 0  | 6  | 9  | 9  | 9  | 19  | 13 | 6  | 3  |
| 2043 | 13  | 0  | 0  | 69 | 7  | 0  | 11 | 11 | 11 | 21  | 9  | 19 | 8  |
| 2044 | 49  | 0  | 0  | 56 | 12 | 11 | 16 | 16 | 16 | 12  | 2  | 14 | 9  |
| 2045 | 64  | 8  | 1  | 87 | 22 | 22 | 21 | 21 | 21 | 21  | 0  | 18 | 12 |
| 2046 | 72  | 1  | 0  | 78 | 30 | 36 | 21 | 21 | 21 | 18  | 1  | 5  | 8  |
| 2047 | 98  | 0  | 0  | 47 | 32 | 36 | 30 | 30 | 30 | 14  | 0  | 0  | 1  |
| 2048 | 90  | 12 | 21 | 22 | 45 | 55 | 55 | 55 | 55 | 12  | 2  | 16 | 3  |
| 2049 | 45  | 18 | 22 | 19 | 46 | 52 | 52 | 52 | 52 | 22  | 5  | 18 | 40 |
| 2050 | 79  | 19 | 26 | 0  | 35 | 20 | 26 | 26 | 26 | 49  | 10 | 39 | 80 |
| 2051 | 104 | 14 | 24 | 5  | 39 | 51 | 45 | 45 | 45 | 60  | 12 | 34 | 51 |
| 2052 | 74  | 24 | 54 | 0  | 72 | 59 | 54 | 54 | 54 | 83  | 2  | 19 | 24 |
| 2053 | 48  | 13 | 25 | 0  | 65 | 53 | 56 | 56 | 56 | 106 | 6  | 22 | 12 |
| 2054 | 37  | 35 | 49 | 0  | 44 | 40 | 40 | 40 | 40 | 89  | 21 | 17 | 12 |
| 2055 | 5   | 23 | 25 | 0  | 21 | 15 | 15 | 15 | 15 | 56  | 16 | 30 | 4  |
| 2056 | 5   | 1  | 20 | 0  | 5  | 5  | 5  | 5  | 5  | 27  | 9  | 38 | 0  |
| 2057 | 0   | 11 | 54 | 0  | 6  | 6  | 6  | 6  | 6  | 22  | 10 | 35 | 0  |
| 2058 | 5   | 0  | 54 | 0  | 0  | 1  | 1  | 1  | 1  | 7   | 18 | 32 | 0  |
| 2059 | 0   | 3  | 34 | 0  | 5  | 5  | 0  | 0  | 0  | 0   | 6  | 16 | 0  |

| 12%  | 1 | 2 | 3  | 4 | 5 | 6 | 7 | 8 | 9 | 10 | 11 | 12 | 13 |
|------|---|---|----|---|---|---|---|---|---|----|----|----|----|
| 2060 | 0 | 0 | 43 | 0 | 0 | 0 | 0 | 0 | 0 | 4  | 1  | 2  | 0  |
| 2061 | 0 | 0 | 9  | 0 | 0 | 0 | 0 | 0 | 0 | 0  | 0  | 18 | 0  |
| 2062 | 0 | 0 | 18 | 0 | 0 | 0 | 0 | 0 | 0 | 0  | 0  | 24 | 0  |
| 2063 | 0 | 0 | 4  | 0 | 0 | 0 | 0 | 0 | 0 | 0  | 0  | 22 | 0  |
| 2064 | 0 | 0 | 4  | 0 | 0 | 0 | 0 | 0 | 0 | 0  | 0  | 12 | 0  |
| 2065 | 0 | 0 | 0  | 0 | 0 | 0 | 0 | 0 | 0 | 0  | 0  | 0  | 0  |
| 2066 | 0 | 0 | 2  | 0 | 0 | 0 | 0 | 0 | 0 | 0  | 0  | 0  | 0  |
| 2067 | 0 | 0 | 0  | 0 | 0 | 0 | 0 | 0 | 0 | 0  | 0  | 0  | 0  |
| 2068 | 0 | 0 | 0  | 0 | 0 | 0 | 0 | 0 | 0 | 0  | 0  | 0  | 0  |
| 2069 | 0 | 0 | 0  | 0 | 0 | 0 | 0 | 0 | 0 | 0  | 0  | 0  | 0  |
| 2070 | 0 | 0 | 0  | 0 | 0 | 0 | 0 | 0 | 0 | 0  | 0  | 0  | 0  |
| 2071 | 0 | 0 | 0  | 0 | 0 | 0 | 0 | 0 | 0 | 0  | 0  | 0  | 0  |
| 2072 | 0 | 0 | 0  | 0 | 0 | 0 | 0 | 0 | 0 | 0  | 0  | 0  | 0  |
| 2073 | 0 | 0 | 0  | 0 | 0 | 0 | 0 | 0 | 0 | 0  | 0  | 0  | 0  |
| 2074 | 0 | 0 | 0  | 0 | 0 | 0 | 0 | 0 | 0 | 0  | 0  | 0  | 0  |
| 2075 | 0 | 0 | 0  | 0 | 0 | 0 | 0 | 0 | 0 | 0  | 0  | 0  | 0  |
| 2076 | 0 | 0 | 0  | 0 | 0 | 0 | 0 | 0 | 0 | 0  | 0  | 0  | 0  |
| 2077 | 0 | 0 | 0  | 0 | 0 | 0 | 0 | 0 | 0 | 0  | 0  | 0  | 0  |
| 2078 | 0 | 0 | 0  | 0 | 0 | 0 | 0 | 0 | 0 | 0  | 0  | 0  | 0  |
| 2079 | 0 | 0 | 0  | 0 | 0 | 0 | 0 | 0 | 0 | 0  | 0  | 0  | 0  |
| 2080 | 0 | 0 | 0  | 0 | 0 | 0 | 0 | 0 | 0 | 0  | 0  | 0  | 0  |
| 2081 | 0 | 0 | 0  | 0 | 0 | 0 | 0 | 0 | 0 | 0  | 0  | 0  | 0  |
| 2082 | 0 | 0 | 0  | 0 | 0 | 0 | 0 | 0 | 0 | 0  | 0  | 0  | 0  |
| 2083 | 0 | 0 | 0  | 0 | 0 | 0 | 0 | 0 | 0 | 0  | 0  | 0  | 0  |
| 2084 | 0 | 0 | 0  | 0 | 0 | 0 | 0 | 0 | 0 | 0  | 0  | 0  | 0  |
| 2085 | 0 | 0 | 0  | 0 | 0 | 0 | 0 | 0 | 0 | 0  | 0  | 0  | 0  |
| 2086 | 0 | 0 | 0  | 0 | 0 | 0 | 0 | 0 | 0 | 0  | 0  | 0  | 0  |
| 2087 | 0 | 0 | 0  | 0 | 0 | 0 | 0 | 0 | 0 | 0  | 0  | 0  | 0  |
| 2088 | 0 | 0 | 0  | 0 | 0 | 0 | 0 | 0 | 0 | 0  | 0  | 0  | 0  |
| 2089 | 0 | 0 | 0  | 0 | 0 | 0 | 0 | 0 | 0 | 0  | 0  | 0  | 0  |
| 2090 | 0 | 0 | 0  | 0 | 0 | 0 | 0 | 0 | 0 | 0  | 0  | 0  | 0  |

| 12%  | 14 | 15 | 16 | 17 | 18 | 19  | 20 | 21 | 22 | 23 | 24 | 25 | 26 |
|------|----|----|----|----|----|-----|----|----|----|----|----|----|----|
| 2002 |    |    |    |    |    |     |    |    |    |    |    |    |    |
| 2003 | 0  | 0  | 0  | 0  | 0  | 0   | 0  | 0  | 0  | 0  | 0  | 0  | 0  |
| 2004 | 0  | 0  | 0  | 0  | 0  | 0   | 0  | 0  | 0  | 0  | 0  | 0  | 0  |
| 2005 | 0  | 0  | 0  | 0  | 0  | 0   | 0  | 0  | 0  | 0  | 0  | 0  | 0  |
| 2006 | 0  | 0  | 0  | 0  | 0  | 0   | 0  | 0  | 0  | 0  | 0  | 0  | 0  |
| 2007 | 0  | 0  | 0  | 0  | 0  | 0   | 0  | 0  | 0  | 0  | 0  | 0  | 0  |
| 2008 | 0  | 0  | 0  | 0  | 0  | 0   | 0  | 0  | 0  | 0  | 0  | 0  | 0  |
| 2009 | 0  | 0  | 0  | 0  | 0  | 0   | 0  | 0  | 0  | 0  | 0  | 0  | 0  |
| 2010 | 0  | 0  | 0  | 0  | 0  | 0   | 0  | 0  | 0  | 0  | 0  | 0  | 0  |
| 2011 | 0  | 0  | 0  | 0  | 0  | 0   | 0  | 0  | 0  | 0  | 0  | 0  | 0  |
| 2012 | 0  | 0  | 0  | 0  | 0  | 0   | 0  | 0  | 0  | 0  | 0  | 0  | 0  |
| 2013 | 0  | 0  | 0  | 0  | 0  | 0   | 0  | 0  | 0  | 0  | 0  | 0  | 0  |
| 2014 | 0  | 0  | 0  | 0  | 0  | 0   | 0  | 0  | 0  | 0  | 0  | 0  | 0  |
| 2015 | 0  | 0  | 0  | 0  | 0  | 0   | 0  | 0  | 0  | 0  | 0  | 0  | 0  |
| 2016 | 0  | 0  | 0  | 0  | 0  | 0   | 0  | 0  | 0  | 0  | 0  | 0  | 0  |
| 2017 | 0  | 0  | 0  | 0  | 0  | 0   | 0  | 0  | 0  | 0  | 0  | 0  | 0  |
| 2018 | 0  | 0  | 0  | 0  | 0  | 0   | 0  | 0  | 0  | 0  | 0  | 0  | 0  |
| 2019 | 0  | 0  | 0  | 0  | 0  | 0   | 0  | 0  | 0  | 0  | 0  | 0  | 0  |
| 2020 | 0  | 0  | 0  | 0  | 0  | 0   | 0  | 0  | 0  | 0  | 0  | 0  | 0  |
| 2021 | 0  | 0  | 0  | 0  | 0  | 0   | 0  | 0  | 1  | 0  | 0  | 0  | 0  |
| 2022 | 0  | 0  | 0  | 0  | 0  | 0   | 0  | 0  | 0  | 0  | 0  | 0  | 0  |
| 2023 | 0  | 0  | 0  | 0  | 0  | 0   | 0  | 0  | 2  | 0  | 0  | 0  | 0  |
| 2024 | 0  | 0  | 0  | 0  | 0  | 0   | 0  | 0  | 6  | 0  | 0  | 0  | 0  |
| 2025 | 0  | 0  | 0  | 0  | 0  | 0   | 0  | 0  | 5  | 0  | 0  | 0  | 0  |
| 2026 | 0  | 0  | 0  | 0  | 0  | 0   | 0  | 0  | 11 | 0  | 0  | 0  | 0  |
| 2027 | 0  | 6  | 6  | 3  | 6  | 5   | 0  | 0  | 10 | 0  | 6  | 6  | 0  |
| 2028 | 0  | 0  | 0  | 0  | 0  | 2   | 0  | 0  | 14 | 0  | 1  | 0  | 0  |
| 2029 | 5  | 0  | 1  | 2  | 1  | 6   | 3  | 0  | 3  | 5  | 5  | 1  | 1  |
| 2030 | 8  | 13 | 6  | 6  | 6  | 4   | 0  | 0  | 6  | 2  | 14 | 0  | 0  |
| 2031 | 0  | 8  | 5  | 5  | 5  | 6   | 0  | 0  | 6  | 0  | 6  | 6  | 6  |
| 2032 | 5  | 19 | 11 | 11 | 11 | 12  | 0  | 0  | 6  | 11 | 12 | 9  | 9  |
| 2033 | 3  | 11 | 15 | 16 | 15 | 21  | 8  | 0  | 24 | 11 | 9  | 18 | 18 |
| 2034 | 0  | 11 | 5  | 5  | 5  | 10  | 4  | 0  | 16 | 6  | 0  | 5  | 5  |
| 2035 | 0  | 5  | 1  | 2  | 1  | 8   | 3  | 6  | 22 | 0  | 6  | 5  | 6  |
| 2036 | 1  | 11 | 6  | 6  | 6  | 9   | 0  | 1  | 12 | 1  | 6  | 1  | 2  |
| 2037 | 16 | 11 | 15 | 15 | 15 | 16  | 0  | 0  | 11 | 0  | 29 | 12 | 12 |
| 2038 | 6  | 22 | 18 | 18 | 18 | 15  | 0  | 0  | 16 | 8  | 21 | 12 | 15 |
| 2039 | 8  | 22 | 17 | 17 | 17 | 38  | 6  | 6  | 19 | 1  | 18 | 17 | 18 |
| 2040 | 3  | 16 | 11 | 11 | 11 | 29  | 9  | 2  | 23 | 8  | 23 | 12 | 13 |
| 2041 | 5  | 16 | 12 | 12 | 12 | 18  | 2  | 6  | 14 | 1  | 17 | 7  | 7  |
| 2042 | 13 | 13 | 15 | 15 | 15 | 14  | 5  | 5  | 4  | 6  | 12 | 11 | 11 |
| 2043 | 15 | 8  | 19 | 19 | 19 | 21  | 10 | 0  | 0  | 14 | 0  | 16 | 16 |
| 2044 | 17 | 6  | 13 | 13 | 13 | 26  | 15 | 7  | 0  | 23 | 16 | 24 | 24 |
| 2045 | 8  | 10 | 6  | 6  | 6  | 13  | 6  | 16 | 24 | 18 | 2  | 6  | 6  |
| 2046 | 11 | 3  | 0  | 0  | 0  | 12  | 0  | 16 | 42 | 14 | 12 | 12 | 12 |
| 2047 | 9  | 11 | 13 | 13 | 13 | 41  | 9  | 15 | 81 | 13 | 15 | 6  | 6  |
| 2048 | 22 | 6  | 6  | 6  | 6  | 48  | 9  | 6  | 65 | 53 | 19 | 35 | 35 |
| 2049 | 64 | 15 | 16 | 16 | 16 | 74  | 11 | 9  | 25 | 32 | 8  | 23 | 23 |
| 2050 | 22 | 8  | 22 | 22 | 22 | 65  | 8  | 55 | 12 | 21 | 39 | 23 | 23 |
| 2051 | 8  | 24 | 13 | 13 | 13 | 97  | 0  | 32 | 8  | 20 | 63 | 33 | 33 |
| 2052 | 21 | 56 | 34 | 34 | 34 | 104 | 18 | 29 | 0  | 48 | 42 | 54 | 54 |
| 2053 | 62 | 50 | 41 | 41 | 41 | 72  | 16 | 20 | 4  | 40 | 34 | 43 | 43 |
| 2054 | 55 | 44 | 44 | 44 | 44 | 38  | 14 | 21 | 0  | 38 | 25 | 38 | 38 |
| 2055 | 29 | 29 | 49 | 49 | 49 | 22  | 3  | 13 | 0  | 42 | 18 | 24 | 24 |
| 2056 | 28 | 20 | 32 | 32 | 32 | 13  | 16 | 33 | 0  | 24 | 9  | 18 | 18 |
| 2057 | 20 | 17 | 22 | 22 | 22 | 9   | 16 | 38 | 0  | 18 | 4  | 12 | 12 |
| 2058 | 17 | 0  | 15 | 15 | 15 | 0   | 1  | 43 | 0  | 12 | 0  | 0  | 0  |
| 2059 | 6  | 0  | 4  | 4  | 4  | 1   | 1  | 20 | 0  | 0  | 0  | 0  | 0  |

| 12%  | 14 | 15 | 16 | 17 | 18 | 19 | 20 | 21 | 22 | 23 | 24 | 25 | 26 |
|------|----|----|----|----|----|----|----|----|----|----|----|----|----|
| 2060 | 0  | 0  | 0  | 0  | 0  | 0  | 0  | 16 | 0  | 0  | 0  | 0  | 0  |
| 2061 | 0  | 0  | 0  | 0  | 0  | 0  | 1  | 20 | 0  | 0  | 0  | 0  | 0  |
| 2062 | 0  | 0  | 0  | 0  | 0  | 0  | 0  | 22 | 0  | 0  | 0  | 0  | 0  |
| 2063 | 0  | 0  | 0  | 0  | 0  | 0  | 0  | 18 | 0  | 0  | 0  | 0  | 0  |
| 2064 | 0  | 0  | 0  | 0  | 0  | 0  | 0  | 11 | 0  | 0  | 0  | 0  | 0  |
| 2065 | 0  | 0  | 0  | 0  | 0  | 0  | 0  | 0  | 0  | 0  | 0  | 0  | 0  |
| 2066 | 0  | 0  | 0  | 0  | 0  | 0  | 0  | 0  | 0  | 0  | 0  | 0  | 0  |
| 2067 | 0  | 0  | 0  | 0  | 0  | 0  | 0  | 0  | 0  | 0  | 0  | 0  | 0  |
| 2068 | 0  | 0  | 0  | 0  | 0  | 0  | 0  | 0  | 0  | 0  | 0  | 0  | 0  |
| 2069 | 0  | 0  | 0  | 0  | 0  | 0  | 0  | 0  | 0  | 0  | 0  | 0  | 0  |
| 2070 | 0  | 0  | 0  | 0  | 0  | 0  | 0  | 0  | 0  | 0  | 0  | 0  | 0  |
| 2071 | 0  | 0  | 0  | 0  | 0  | 0  | 0  | 0  | 0  | 0  | 0  | 0  | 0  |
| 2072 | 0  | 0  | 0  | 0  | 0  | 0  | 0  | 0  | 0  | 0  | 0  | 0  | 0  |
| 2073 | 0  | 0  | 0  | 0  | 0  | 0  | 0  | 0  | 0  | 0  | 0  | 0  | 0  |
| 2074 | 0  | 0  | 0  | 0  | 0  | 0  | 0  | 0  | 0  | 0  | 0  | 0  | 0  |
| 2075 | 0  | 0  | 0  | 0  | 0  | 0  | 0  | 0  | 0  | 0  | 0  | 0  | 0  |
| 2076 | 0  | 0  | 0  | 0  | 0  | 0  | 0  | 0  | 0  | 0  | 0  | 0  | 0  |
| 2077 | 0  | 0  | 0  | 0  | 0  | 0  | 0  | 0  | 0  | 0  | 0  | 0  | 0  |
| 2078 | 0  | 0  | 0  | 0  | 0  | 0  | 0  | 0  | 0  | 0  | 0  | 0  | 0  |
| 2079 | 0  | 0  | 0  | 0  | 0  | 0  | 0  | 0  | 0  | 0  | 0  | 0  | 0  |
| 2080 | 0  | 0  | 0  | 0  | 0  | 0  | 0  | 0  | 0  | 0  | 0  | 0  | 0  |
| 2081 | 0  | 0  | 0  | 0  | 0  | 0  | 0  | 0  | 0  | 0  | 0  | 0  | 0  |
| 2082 | 0  | 0  | 0  | 0  | 0  | 0  | 0  | 0  | 0  | 0  | 0  | 0  | 0  |
| 2083 | 0  | 0  | 0  | 0  | 0  | 0  | 0  | 0  | 0  | 0  | 0  | 0  | 0  |
| 2084 | 0  | 0  | 0  | 0  | 0  | 0  | 0  | 0  | 0  | 0  | 0  | 0  | 0  |
| 2085 | 0  | 0  | 0  | 0  | 0  | 0  | 0  | 0  | 0  | 0  | 0  | 0  | 0  |
| 2086 | 0  | 0  | 0  | 0  | 0  | 0  | 0  | 0  | 0  | 0  | 0  | 0  | 0  |
| 2087 | 0  | 0  | 0  | 0  | 0  | 0  | 0  | 0  | 0  | 0  | 0  | 0  | 0  |
| 2088 | 0  | 0  | 0  | 0  | 0  | 0  | 0  | 0  | 0  | 0  | 0  | 0  | 0  |
| 2089 | 0  | 0  | 0  | 0  | 0  | 0  | 0  | 0  | 0  | 0  | 0  | 0  | 0  |
| 2090 | 0  | 0  | 0  | 0  | 0  | 0  | 0  | 0  | 0  | 0  | 0  | 0  | 0  |

| 12%  | 27 | 28 | 29 | 30 | 31 | 32 | 33 | 34 | 35 | 36 | 37 | 38 | 39 |
|------|----|----|----|----|----|----|----|----|----|----|----|----|----|
| 2002 |    |    |    |    |    |    |    |    |    |    |    |    |    |
| 2003 | 0  | 0  | 0  | 0  | 0  | 0  | 0  | 0  | 0  | 0  | 0  | 0  | 0  |
| 2004 | 0  | 0  | 0  | 0  | 0  | 0  | 0  | 0  | 0  | 0  | 0  | 0  | 0  |
| 2005 | 0  | 0  | 0  | 0  | 0  | 0  | 0  | 0  | 0  | 0  | 0  | 0  | 0  |
| 2006 | 0  | 0  | 0  | 0  | 0  | 0  | 0  | 0  | 0  | 0  | 0  | 0  | 0  |
| 2007 | 0  | 0  | 0  | 0  | 0  | 0  | 0  | 0  | 0  | 0  | 0  | 0  | 0  |
| 2008 | 0  | 0  | 0  | 0  | 0  | 0  | 0  | 0  | 0  | 0  | 0  | 0  | 0  |
| 2009 | 0  | 0  | 0  | 0  | 0  | 0  | 0  | 0  | 0  | 0  | 0  | 0  | 0  |
| 2010 | 0  | 0  | 0  | 0  | 0  | 0  | 0  | 0  | 0  | 0  | 0  | 0  | 0  |
| 2011 | 0  | 0  | 0  | 0  | 0  | 0  | 0  | 0  | 0  | 0  | 0  | 0  | 0  |
| 2012 | 0  | 0  | 0  | 0  | 0  | 0  | 0  | 0  | 0  | 0  | 0  | 0  | 0  |
| 2013 | 0  | 0  | 0  | 0  | 0  | 0  | 0  | 0  | 0  | 0  | 0  | 0  | 0  |
| 2014 | 0  | 0  | 0  | 0  | 0  | 0  | 0  | 0  | 0  | 0  | 0  | 0  | 0  |
| 2015 | 0  | 0  | 0  | 0  | 0  | 0  | 0  | 0  | 0  | 0  | 0  | 0  | 0  |
| 2016 | 0  | 0  | 0  | 0  | 0  | 0  | 0  | 0  | 0  | 0  | 0  | 0  | 0  |
| 2017 | 0  | 0  | 0  | 0  | 0  | 0  | 0  | 0  | 0  | 0  | 0  | 0  | 0  |
| 2018 | 0  | 0  | 0  | 0  | 0  | 0  | 0  | 0  | 0  | 0  | 0  | 0  | 0  |
| 2019 | 0  | 0  | 0  | 0  | 0  | 0  | 0  | 0  | 0  | 0  | 0  | 0  | 0  |
| 2020 | 0  | 0  | 0  | 0  | 0  | 0  | 0  | 0  | 0  | 0  | 0  | 0  | 0  |
| 2021 | 0  | 0  | 0  | 0  | 0  | 0  | 0  | 0  | 0  | 0  | 0  | 0  | 0  |
| 2022 | 0  | 0  | 0  | 0  | 0  | 0  | 0  | 0  | 0  | 0  | 0  | 0  | 0  |
| 2023 | 0  | 0  | 0  | 0  | 0  | 0  | 0  | 0  | 0  | 0  | 0  | 0  | 0  |
| 2024 | 0  | 0  | 0  | 0  | 0  | 0  | 0  | 0  | 0  | 0  | 0  | 0  | 0  |
| 2025 | 0  | 0  | 0  | 0  | 0  | 0  | 0  | 0  | 0  | 0  | 0  | 0  | 0  |
| 2026 | 0  | 0  | 0  | 0  | 0  | 0  | 0  | 0  | 0  | 0  | 5  | 3  | 0  |
| 2027 | 5  | 0  | 0  | 0  | 0  | 0  | 0  | 0  | 0  | 0  | 6  | 2  | 0  |
| 2028 | 2  | 0  | 0  | 0  | 2  | 0  | 0  | 0  | 0  | 0  | 6  | 6  | 0  |
| 2029 | 1  | 0  | 0  | 0  | 2  | 0  | 0  | 0  | 0  | 0  | 13 | 11 | 0  |
| 2030 | 0  | 0  | 0  | 0  | 9  | 0  | 0  | 0  | 0  | 0  | 8  | 5  | 0  |
| 2031 | 6  | 0  | 0  | 0  | 5  | 0  | 1  | 0  | 0  | 0  | 11 | 8  | 2  |
| 2032 | 9  | 0  | 0  | 0  | 11 | 0  | 9  | 0  | 0  | 0  | 26 | 11 | 9  |
| 2033 | 18 | 8  | 0  | 0  | 14 | 0  | 15 | 1  | 1  | 1  | 22 | 10 | 8  |
| 2034 | 5  | 1  | 1  | 0  | 15 | 0  | 20 | 1  | 1  | 1  | 24 | 11 | 8  |
| 2035 | 5  | 4  | 2  | 0  | 3  | 0  | 19 | 4  | 4  | 4  | 17 | 11 | 12 |
| 2036 | 1  | 17 | 5  | 0  | 5  | 1  | 18 | 16 | 16 | 16 | 31 | 15 | 18 |
| 2037 | 12 | 23 | 8  | 0  | 3  | 0  | 3  | 15 | 15 | 15 | 21 | 4  | 21 |
| 2038 | 12 | 3  | 2  | 0  | 6  | 9  | 3  | 3  | 3  | 3  | 11 | 0  | 20 |
| 2039 | 17 | 29 | 5  | 2  | 5  | 5  | 4  | 17 | 17 | 17 | 20 | 0  | 17 |
| 2040 | 12 | 18 | 0  | 9  | 8  | 15 | 3  | 9  | 9  | 9  | 18 | 0  | 9  |
| 2041 | 7  | 6  | 3  | 6  | 18 | 8  | 8  | 6  | 6  | 6  | 19 | 2  | 19 |
| 2042 | 11 | 21 | 6  | 20 | 43 | 29 | 7  | 8  | 8  | 8  | 23 | 1  | 16 |
| 2043 | 16 | 14 | 0  | 5  | 69 | 22 | 12 | 5  | 5  | 5  | 22 | 3  | 11 |
| 2044 | 24 | 68 | 6  | 19 | 51 | 32 | 22 | 25 | 25 | 25 | 25 | 0  | 3  |
| 2045 | 6  | 74 | 8  | 11 | 61 | 27 | 36 | 28 | 28 | 28 | 16 | 2  | 0  |
| 2046 | 12 | 64 | 7  | 15 | 70 | 21 | 31 | 25 | 25 | 25 | 11 | 2  | 2  |
| 2047 | 6  | 64 | 10 | 23 | 48 | 25 | 27 | 32 | 32 | 32 | 9  | 1  | 6  |
| 2048 | 35 | 62 | 11 | 25 | 18 | 36 | 31 | 39 | 39 | 39 | 10 | 4  | 11 |
| 2049 | 23 | 62 | 10 | 22 | 16 | 36 | 44 | 36 | 36 | 36 | 16 | 2  | 19 |
| 2050 | 23 | 72 | 20 | 26 | 6  | 49 | 46 | 48 | 48 | 48 | 79 | 8  | 19 |
| 2051 | 33 | 77 | 18 | 26 | 2  | 44 | 38 | 45 | 45 | 45 | 67 | 9  | 21 |
| 2052 | 54 | 62 | 20 | 29 | 3  | 43 | 33 | 41 | 41 | 41 | 76 | 11 | 21 |
| 2053 | 43 | 49 | 16 | 28 | 2  | 33 | 26 | 32 | 32 | 32 | 75 | 13 | 24 |
| 2054 | 38 | 33 | 14 | 36 | 0  | 25 | 22 | 26 | 26 | 26 | 75 | 14 | 29 |
| 2055 | 24 | 23 | 12 | 33 | 0  | 18 | 8  | 20 | 20 | 20 | 47 | 12 | 31 |
| 2056 | 18 | 3  | 6  | 31 | 0  | 6  | 2  | 3  | 3  | 3  | 29 | 9  | 36 |
| 2057 | 12 | 5  | 3  | 31 | 0  | 2  | 5  | 4  | 4  | 4  | 18 | 5  | 30 |
| 2058 | 0  | 1  | 3  | 26 | 0  | 4  | 0  | 0  | 0  | 0  | 9  | 5  | 21 |
| 2059 | 0  | 3  | 1  | 22 | 0  | 2  | 0  | 0  | 0  | 0  | 5  | 2  | 13 |

| 12%  | 27 | 28 | 29 | 30 | 31 | 32 | 33 | 34 | 35 | 36 | 37 | 38 | 39 |
|------|----|----|----|----|----|----|----|----|----|----|----|----|----|
| 2060 | 0  | 0  | 0  | 20 | 0  | 0  | 0  | 0  | 0  | 0  | 0  | 0  | 10 |
| 2061 | 0  | 0  | 0  | 15 | 0  | 0  | 0  | 0  | 0  | 0  | 2  | 0  | 8  |
| 2062 | 0  | 0  | 0  | 10 | 0  | 0  | 0  | 0  | 0  | 0  | 0  | 0  | 8  |
| 2063 | 0  | 0  | 0  | 2  | 0  | 0  | 0  | 0  | 0  | 0  | 0  | 0  | 8  |
| 2064 | 0  | 0  | 0  | 1  | 0  | 0  | 0  | 0  | 0  | 0  | 0  | 0  | 3  |
| 2065 | 0  | 0  | 0  | 2  | 0  | 0  | 0  | 0  | 0  | 0  | 0  | 0  | 0  |
| 2066 | 0  | 0  | 0  | 2  | 0  | 0  | 0  | 0  | 0  | 0  | 0  | 0  | 0  |
| 2067 | 0  | 0  | 0  | 0  | 0  | 0  | 0  | 0  | 0  | 0  | 0  | 0  | 0  |
| 2068 | 0  | 0  | 0  | 0  | 0  | 0  | 0  | 0  | 0  | 0  | 0  | 0  | 0  |
| 2069 | 0  | 0  | 0  | 0  | 0  | 0  | 0  | 0  | 0  | 0  | 0  | 0  | 0  |
| 2070 | 0  | 0  | 0  | 0  | 0  | 0  | 0  | 0  | 0  | 0  | 0  | 0  | 0  |
| 2071 | 0  | 0  | 0  | 0  | 0  | 0  | 0  | 0  | 0  | 0  | 0  | 0  | 0  |
| 2072 | 0  | 0  | 0  | 0  | 0  | 0  | 0  | 0  | 0  | 0  | 0  | 0  | 0  |
| 2073 | 0  | 0  | 0  | 0  | 0  | 0  | 0  | 0  | 0  | 0  | 0  | 0  | 0  |
| 2074 | 0  | 0  | 0  | 0  | 0  | 0  | 0  | 0  | 0  | 0  | 0  | 0  | 0  |
| 2075 | 0  | 0  | 0  | 0  | 0  | 0  | 0  | 0  | 0  | 0  | 0  | 0  | 0  |
| 2076 | 0  | 0  | 0  | 0  | 0  | 0  | 0  | 0  | 0  | 0  | 0  | 0  | 0  |
| 2077 | 0  | 0  | 0  | 0  | 0  | 0  | 0  | 0  | 0  | 0  | 0  | 0  | 0  |
| 2078 | 0  | 0  | 0  | 0  | 0  | 0  | 0  | 0  | 0  | 0  | 0  | 0  | 0  |
| 2079 | 0  | 0  | 0  | 0  | 0  | 0  | 0  | 0  | 0  | 0  | 0  | 0  | 0  |
| 2080 | 0  | 0  | 0  | 0  | 0  | 0  | 0  | 0  | 0  | 0  | 0  | 0  | 0  |
| 2081 | 0  | 0  | 0  | 0  | 0  | 0  | 0  | 0  | 0  | 0  | 0  | 0  | 0  |
| 2082 | 0  | 0  | 0  | 0  | 0  | 0  | 0  | 0  | 0  | 0  | 0  | 0  | 0  |
| 2083 | 0  | 0  | 0  | 0  | 0  | 0  | 0  | 0  | 0  | 0  | 0  | 0  | 0  |
| 2084 | 0  | 0  | 0  | 0  | 0  | 0  | 0  | 0  | 0  | 0  | 0  | 0  | 0  |
| 2085 | 0  | 0  | 0  | 0  | 0  | 0  | 0  | 0  | 0  | 0  | 0  | 0  | 0  |
| 2086 | 0  | 0  | 0  | 0  | 0  | 0  | 0  | 0  | 0  | 0  | 0  | 0  | 0  |
| 2087 | 0  | 0  | 0  | 0  | 0  | 0  | 0  | 0  | 0  | 0  | 0  | 0  | 0  |
| 2088 | 0  | 0  | 0  | 0  | 0  | 0  | 0  | 0  | 0  | 0  | 0  | 0  | 0  |
| 2089 | 0  | 0  | 0  | 0  | 0  | 0  | 0  | 0  | 0  | 0  | 0  | 0  | 0  |
| 2090 | 0  | 0  | 0  | 0  | 0  | 0  | 0  | 0  | 0  | 0  | 0  | 0  | 0  |



| 12%  | 40 | 41 | 42 | 43 | 44 | 45 | 46 | 47 | 48 | 49 | 50 | 51 | 52 |
|------|----|----|----|----|----|----|----|----|----|----|----|----|----|
| 2002 |    |    |    |    |    |    |    |    |    |    |    |    |    |
| 2003 | 0  | 0  | 0  | 0  | 0  | 0  | 0  | 0  | 0  | 0  | 0  | 0  | 0  |
| 2004 | 0  | 0  | 0  | 0  | 0  | 0  | 0  | 0  | 0  | 0  | 0  | 0  | 0  |
| 2005 | 0  | 0  | 0  | 0  | 0  | 0  | 0  | 0  | 0  | 0  | 0  | 0  | 0  |
| 2006 | 0  | 0  | 0  | 0  | 0  | 0  | 0  | 0  | 0  | 0  | 0  | 0  | 0  |
| 2007 | 0  | 0  | 0  | 0  | 0  | 0  | 0  | 0  | 0  | 0  | 0  | 0  | 0  |
| 2008 | 0  | 0  | 0  | 0  | 0  | 0  | 0  | 0  | 0  | 0  | 0  | 0  | 0  |
| 2009 | 0  | 0  | 0  | 0  | 0  | 0  | 0  | 0  | 0  | 0  | 0  | 0  | 0  |
| 2010 | 0  | 0  | 0  | 0  | 0  | 0  | 0  | 0  | 0  | 0  | 0  | 0  | 0  |
| 2011 | 0  | 0  | 0  | 0  | 0  | 0  | 0  | 0  | 0  | 0  | 0  | 0  | 0  |
| 2012 | 0  | 0  | 0  | 0  | 0  | 0  | 0  | 0  | 0  | 0  | 0  | 0  | 0  |
| 2013 | 0  | 0  | 0  | 0  | 0  | 0  | 0  | 0  | 0  | 0  | 0  | 0  | 0  |
| 2014 | 0  | 0  | 0  | 0  | 0  | 0  | 0  | 0  | 0  | 0  | 0  | 0  | 0  |
| 2015 | 0  | 0  | 0  | 0  | 0  | 0  | 0  | 0  | 0  | 0  | 0  | 0  | 0  |
| 2016 | 0  | 0  | 0  | 0  | 0  | 0  | 0  | 0  | 0  | 0  | 0  | 0  | 0  |
| 2017 | 0  | 0  | 0  | 0  | 0  | 0  | 0  | 0  | 0  | 0  | 0  | 0  | 0  |
| 2018 | 0  | 0  | 0  | 0  | 0  | 0  | 0  | 0  | 0  | 0  | 0  | 0  | 0  |
| 2019 | 0  | 0  | 0  | 0  | 0  | 0  | 0  | 0  | 0  | 0  | 0  | 0  | 0  |
| 2020 | 0  | 0  | 0  | 0  | 0  | 0  | 0  | 0  | 0  | 0  | 0  | 0  | 0  |
| 2021 | 3  | 0  | 0  | 0  | 0  | 0  | 0  | 0  | 0  | 2  | 0  | 0  | 0  |
| 2022 | 0  | 0  | 0  | 0  | 0  | 0  | 0  | 0  | 0  | 1  | 0  | 0  | 0  |
| 2023 | 7  | 0  | 0  | 0  | 0  | 0  | 0  | 0  | 0  | 4  | 0  | 0  | 0  |
| 2024 | 8  | 0  | 0  | 0  | 0  | 0  | 0  | 0  | 0  | 5  | 0  | 0  | 0  |
| 2025 | 8  | 0  | 0  | 0  | 0  | 0  | 0  | 0  | 0  | 5  | 0  | 0  | 0  |
| 2026 | 13 | 3  | 14 | 5  | 1  | 5  | 5  | 4  | 0  | 12 | 3  | 9  | 5  |
| 2027 | 10 | 6  | 13 | 4  | 3  | 4  | 4  | 2  | 0  | 11 | 2  | 6  | 5  |
| 2028 | 15 | 3  | 10 | 6  | 6  | 6  | 4  | 3  | 0  | 11 | 3  | 12 | 3  |
| 2029 | 13 | 10 | 15 | 12 | 13 | 12 | 3  | 3  | 0  | 5  | 5  | 13 | 3  |
| 2030 | 24 | 11 | 9  | 9  | 9  | 9  | 9  | 8  | 0  | 5  | 5  | 13 | 9  |
| 2031 | 27 | 10 | 11 | 10 | 10 | 10 | 9  | 5  | 3  | 13 | 2  | 12 | 7  |
| 2032 | 19 | 13 | 5  | 21 | 21 | 21 | 13 | 2  | 3  | 9  | 12 | 11 | 7  |
| 2033 | 19 | 9  | 15 | 15 | 16 | 15 | 14 | 3  | 8  | 29 | 9  | 10 | 12 |
| 2034 | 19 | 12 | 9  | 15 | 15 | 15 | 13 | 4  | 5  | 13 | 11 | 9  | 6  |
| 2035 | 9  | 10 | 13 | 15 | 16 | 15 | 17 | 6  | 9  | 18 | 12 | 13 | 9  |
| 2036 | 11 | 20 | 25 | 25 | 25 | 25 | 18 | 15 | 8  | 16 | 9  | 29 | 18 |
| 2037 | 7  | 18 | 19 | 15 | 15 | 15 | 18 | 6  | 16 | 12 | 13 | 15 | 15 |
| 2038 | 13 | 8  | 13 | 10 | 10 | 10 | 29 | 9  | 12 | 16 | 13 | 14 | 23 |
| 2039 | 5  | 8  | 17 | 9  | 9  | 9  | 32 | 8  | 15 | 16 | 18 | 11 | 17 |
| 2040 | 0  | 3  | 15 | 12 | 12 | 12 | 18 | 8  | 13 | 20 | 6  | 16 | 11 |
| 2041 | 0  | 13 | 6  | 11 | 11 | 11 | 18 | 12 | 14 | 6  | 13 | 6  | 13 |
| 2042 | 8  | 21 | 7  | 8  | 8  | 8  | 15 | 2  | 6  | 3  | 11 | 5  | 12 |
| 2043 | 13 | 13 | 3  | 6  | 6  | 6  | 22 | 0  | 13 | 0  | 11 | 9  | 13 |
| 2044 | 8  | 11 | 1  | 9  | 9  | 9  | 28 | 1  | 15 | 2  | 10 | 2  | 12 |
| 2045 | 5  | 6  | 3  | 6  | 6  | 6  | 13 | 0  | 8  | 34 | 3  | 9  | 4  |
| 2046 | 3  | 6  | 8  | 5  | 5  | 5  | 16 | 3  | 3  | 64 | 12 | 6  | 7  |
| 2047 | 7  | 6  | 10 | 6  | 6  | 6  | 43 | 3  | 1  | 65 | 21 | 14 | 15 |
| 2048 | 4  | 8  | 15 | 8  | 8  | 8  | 69 | 7  | 14 | 48 | 34 | 33 | 31 |
| 2049 | 67 | 29 | 36 | 10 | 10 | 10 | 66 | 10 | 19 | 26 | 30 | 39 | 33 |
| 2050 | 68 | 29 | 38 | 32 | 32 | 32 | 68 | 9  | 25 | 12 | 26 | 40 | 33 |
| 2051 | 42 | 35 | 45 | 38 | 38 | 38 | 76 | 12 | 25 | 8  | 39 | 41 | 41 |
| 2052 | 16 | 41 | 39 | 41 | 41 | 41 | 85 | 14 | 21 | 0  | 39 | 39 | 42 |
| 2053 | 12 | 43 | 34 | 39 | 39 | 39 | 60 | 14 | 25 | 4  | 40 | 24 | 36 |
| 2054 | 8  | 39 | 21 | 39 | 39 | 39 | 38 | 10 | 29 | 0  | 29 | 16 | 26 |
| 2055 | 5  | 23 | 12 | 25 | 25 | 25 | 22 | 8  | 28 | 0  | 21 | 9  | 13 |
| 2056 | 0  | 13 | 9  | 16 | 16 | 16 | 14 | 3  | 35 | 0  | 15 | 4  | 9  |
| 2057 | 0  | 9  | 3  | 11 | 11 | 11 | 7  | 5  | 33 | 0  | 9  | 4  | 5  |
| 2058 | 0  | 5  | 3  | 3  | 3  | 3  | 0  | 2  | 28 | 0  | 6  | 0  | 0  |
| 2059 | 0  | 0  | 0  | 0  | 0  | 0  | 0  | 0  | 19 | 0  | 0  | 1  | 3  |

| 12%  | 40 | 41 | 42 | 43 | 44 | 45 | 46 | 47 | 48 | 49 | 50 | 51 | 52 |
|------|----|----|----|----|----|----|----|----|----|----|----|----|----|
| 2060 | 0  | 2  | 0  | 0  | 0  | 0  | 0  | 0  | 12 | 0  | 0  | 0  | 0  |
| 2061 | 0  | 0  | 0  | 0  | 0  | 0  | 0  | 0  | 9  | 0  | 0  | 0  | 0  |
| 2062 | 0  | 0  | 0  | 0  | 0  | 0  | 0  | 0  | 7  | 0  | 0  | 0  | 0  |
| 2063 | 0  | 0  | 0  | 0  | 0  | 0  | 0  | 0  | 8  | 0  | 0  | 0  | 0  |
| 2064 | 0  | 0  | 0  | 0  | 0  | 0  | 0  | 0  | 5  | 0  | 0  | 0  | 0  |
| 2065 | 0  | 0  | 0  | 0  | 0  | 0  | 0  | 0  | 2  | 0  | 0  | 0  | 0  |
| 2066 | 0  | 0  | 0  | 0  | 0  | 0  | 0  | 0  | 0  | 0  | 0  | 0  | 0  |
| 2067 | 0  | 0  | 0  | 0  | 0  | 0  | 0  | 0  | 2  | 0  | 0  | 0  | 0  |
| 2068 | 0  | 0  | 0  | 0  | 0  | 0  | 0  | 0  | 0  | 0  | 0  | 0  | 0  |
| 2069 | 0  | 0  | 0  | 0  | 0  | 0  | 0  | 0  | 0  | 0  | 0  | 0  | 0  |
| 2070 | 0  | 0  | 0  | 0  | 0  | 0  | 0  | 0  | 0  | 0  | 0  | 0  | 0  |
| 2071 | 0  | 0  | 0  | 0  | 0  | 0  | 0  | 0  | 0  | 0  | 0  | 0  | 0  |
| 2072 | 0  | 0  | 0  | 0  | 0  | 0  | 0  | 0  | 0  | 0  | 0  | 0  | 0  |
| 2073 | 0  | 0  | 0  | 0  | 0  | 0  | 0  | 0  | 0  | 0  | 0  | 0  | 0  |
| 2074 | 0  | 0  | 0  | 0  | 0  | 0  | 0  | 0  | 0  | 0  | 0  | 0  | 0  |
| 2075 | 0  | 0  | 0  | 0  | 0  | 0  | 0  | 0  | 0  | 0  | 0  | 0  | 0  |
| 2076 | 0  | 0  | 0  | 0  | 0  | 0  | 0  | 0  | 0  | 0  | 0  | 0  | 0  |
| 2077 | 0  | 0  | 0  | 0  | 0  | 0  | 0  | 0  | 0  | 0  | 0  | 0  | 0  |
| 2078 | 0  | 0  | 0  | 0  | 0  | 0  | 0  | 0  | 0  | 0  | 0  | 0  | 0  |
| 2079 | 0  | 0  | 0  | 0  | 0  | 0  | 0  | 0  | 0  | 0  | 0  | 0  | 0  |
| 2080 | 0  | 0  | 0  | 0  | 0  | 0  | 0  | 0  | 0  | 0  | 0  | 0  | 0  |
| 2081 | 0  | 0  | 0  | 0  | 0  | 0  | 0  | 0  | 0  | 0  | 0  | 0  | 0  |
| 2082 | 0  | 0  | 0  | 0  | 0  | 0  | 0  | 0  | 0  | 0  | 0  | 0  | 0  |
| 2083 | 0  | 0  | 0  | 0  | 0  | 0  | 0  | 0  | 0  | 0  | 0  | 0  | 0  |
| 2084 | 0  | 0  | 0  | 0  | 0  | 0  | 0  | 0  | 0  | 0  | 0  | 0  | 0  |
| 2085 | 0  | 0  | 0  | 0  | 0  | 0  | 0  | 0  | 0  | 0  | 0  | 0  | 0  |
| 2086 | 0  | 0  | 0  | 0  | 0  | 0  | 0  | 0  | 0  | 0  | 0  | 0  | 0  |
| 2087 | 0  | 0  | 0  | 0  | 0  | 0  | 0  | 0  | 0  | 0  | 0  | 0  | 0  |
| 2088 | 0  | 0  | 0  | 0  | 0  | 0  | 0  | 0  | 0  | 0  | 0  | 0  | 0  |
| 2089 | 0  | 0  | 0  | 0  | 0  | 0  | 0  | 0  | 0  | 0  | 0  | 0  | 0  |
| 2090 | 0  | 0  | 0  | 0  | 0  | 0  | 0  | 0  | 0  | 0  | 0  | 0  | 0  |

| 12%  | 53 | 54 | 55 | 56 | 57 | 58 | 59 | 60 | 61 | 62 | 63 | 64  | 65 |
|------|----|----|----|----|----|----|----|----|----|----|----|-----|----|
| 2002 |    |    |    |    |    |    |    |    |    |    |    |     |    |
| 2003 | 0  | 0  | 0  | 0  | 0  | 0  | 0  | 0  | 0  | 0  | 0  | 0   | 0  |
| 2004 | 0  | 0  | 0  | 0  | 0  | 0  | 0  | 0  | 0  | 0  | 0  | 0   | 0  |
| 2005 | 0  | 0  | 0  | 0  | 0  | 0  | 0  | 0  | 0  | 0  | 0  | 0   | 0  |
| 2006 | 0  | 0  | 0  | 0  | 0  | 0  | 0  | 0  | 0  | 0  | 0  | 0   | 0  |
| 2007 | 0  | 0  | 0  | 0  | 0  | 0  | 0  | 0  | 0  | 0  | 0  | 0   | 0  |
| 2008 | 0  | 0  | 0  | 0  | 0  | 0  | 0  | 0  | 0  | 0  | 0  | 0   | 0  |
| 2009 | 0  | 0  | 0  | 0  | 0  | 0  | 0  | 0  | 0  | 0  | 0  | 0   | 0  |
| 2010 | 0  | 0  | 0  | 0  | 0  | 0  | 0  | 0  | 0  | 0  | 0  | 0   | 0  |
| 2011 | 0  | 0  | 0  | 0  | 0  | 0  | 0  | 0  | 0  | 0  | 0  | 0   | 0  |
| 2012 | 0  | 0  | 0  | 0  | 0  | 0  | 0  | 0  | 0  | 0  | 0  | 0   | 0  |
| 2013 | 0  | 0  | 0  | 0  | 0  | 0  | 0  | 0  | 0  | 0  | 0  | 0   | 0  |
| 2014 | 0  | 0  | 0  | 0  | 0  | 0  | 0  | 0  | 0  | 0  | 0  | 0   | 0  |
| 2015 | 0  | 0  | 0  | 0  | 0  | 0  | 0  | 0  | 0  | 0  | 0  | 0   | 0  |
| 2016 | 0  | 0  | 0  | 0  | 0  | 0  | 0  | 0  | 0  | 0  | 0  | 0   | 0  |
| 2017 | 0  | 0  | 0  | 0  | 0  | 0  | 0  | 0  | 0  | 0  | 0  | 0   | 0  |
| 2018 | 0  | 0  | 0  | 0  | 0  | 0  | 0  | 0  | 0  | 0  | 0  | 0   | 0  |
| 2019 | 0  | 0  | 0  | 0  | 0  | 0  | 0  | 0  | 0  | 0  | 0  | 0   | 0  |
| 2020 | 0  | 0  | 0  | 0  | 0  | 0  | 0  | 0  | 0  | 0  | 0  | 0   | 0  |
| 2021 | 0  | 0  | 0  | 0  | 0  | 18 | 0  | 0  | 0  | 0  | 0  | 0   | 0  |
| 2022 | 0  | 0  | 0  | 0  | 0  | 32 | 0  | 0  | 0  | 0  | 0  | 0   | 0  |
| 2023 | 0  | 0  | 0  | 0  | 0  | 20 | 0  | 0  | 0  | 0  | 0  | 0   | 0  |
| 2024 | 0  | 0  | 0  | 0  | 0  | 29 | 0  | 0  | 0  | 0  | 0  | 0   | 0  |
| 2025 | 0  | 0  | 0  | 0  | 0  | 12 | 0  | 0  | 0  | 0  | 0  | 0   | 0  |
| 2026 | 2  | 5  | 13 | 0  | 0  | 15 | 0  | 0  | 0  | 0  | 0  | 32  | 0  |
| 2027 | 2  | 4  | 25 | 0  | 0  | 23 | 6  | 6  | 6  | 6  | 6  | 51  | 0  |
| 2028 | 3  | 4  | 36 | 4  | 0  | 34 | 2  | 2  | 2  | 2  | 2  | 64  | 0  |
| 2029 | 3  | 3  | 47 | 0  | 0  | 11 | 21 | 21 | 21 | 21 | 21 | 53  | 18 |
| 2030 | 9  | 9  | 48 | 8  | 0  | 12 | 25 | 25 | 25 | 25 | 25 | 39  | 12 |
| 2031 | 7  | 7  | 35 | 0  | 0  | 10 | 15 | 15 | 15 | 15 | 15 | 34  | 13 |
| 2032 | 6  | 7  | 45 | 12 | 0  | 7  | 29 | 29 | 29 | 29 | 29 | 24  | 4  |
| 2033 | 11 | 12 | 46 | 10 | 6  | 6  | 33 | 33 | 33 | 33 | 33 | 32  | 5  |
| 2034 | 9  | 6  | 29 | 18 | 8  | 12 | 23 | 23 | 23 | 23 | 23 | 18  | 9  |
| 2035 | 10 | 9  | 21 | 1  | 5  | 6  | 13 | 13 | 13 | 13 | 13 | 11  | 6  |
| 2036 | 18 | 18 | 11 | 6  | 6  | 18 | 13 | 19 | 13 | 13 | 13 | 19  | 12 |
| 2037 | 15 | 15 | 15 | 0  | 30 | 3  | 6  | 6  | 6  | 6  | 6  | 15  | 12 |
| 2038 | 25 | 23 | 10 | 6  | 36 | 0  | 7  | 8  | 7  | 7  | 7  | 14  | 8  |
| 2039 | 18 | 17 | 18 | 6  | 28 | 18 | 13 | 9  | 13 | 13 | 13 | 11  | 2  |
| 2040 | 12 | 11 | 16 | 2  | 25 | 2  | 6  | 4  | 6  | 6  | 6  | 6   | 0  |
| 2041 | 13 | 13 | 10 | 2  | 18 | 6  | 0  | 0  | 0  | 0  | 0  | 12  | 6  |
| 2042 | 12 | 12 | 9  | 0  | 6  | 5  | 0  | 6  | 6  | 6  | 6  | 13  | 5  |
| 2043 | 13 | 13 | 2  | 0  | 8  | 12 | 0  | 0  | 0  | 0  | 0  | 12  | 0  |
| 2044 | 12 | 12 | 12 | 0  | 6  | 33 | 0  | 0  | 6  | 6  | 6  | 12  | 3  |
| 2045 | 4  | 4  | 15 | 0  | 12 | 56 | 6  | 0  | 6  | 6  | 6  | 6   | 6  |
| 2046 | 7  | 7  | 57 | 3  | 13 | 48 | 29 | 28 | 23 | 23 | 23 | 2   | 1  |
| 2047 | 15 | 15 | 88 | 6  | 5  | 40 | 41 | 43 | 35 | 35 | 35 | 0   | 0  |
| 2048 | 31 | 31 | 94 | 16 | 3  | 0  | 30 | 36 | 41 | 41 | 41 | 5   | 0  |
| 2049 | 33 | 33 | 67 | 6  | 6  | 4  | 48 | 48 | 55 | 55 | 55 | 26  | 0  |
| 2050 | 33 | 33 | 49 | 28 | 6  | 0  | 54 | 52 | 52 | 52 | 52 | 88  | 0  |
| 2051 | 41 | 41 | 29 | 41 | 58 | 0  | 46 | 46 | 34 | 34 | 34 | 114 | 8  |
| 2052 | 42 | 42 | 13 | 8  | 11 | 0  | 13 | 8  | 13 | 13 | 13 | 73  | 21 |
| 2053 | 36 | 36 | 2  | 4  | 12 | 0  | 2  | 6  | 2  | 2  | 2  | 31  | 12 |
| 2054 | 26 | 26 | 0  | 5  | 13 | 0  | 8  | 1  | 2  | 2  | 2  | 22  | 6  |
| 2055 | 13 | 13 | 0  | 2  | 38 | 0  | 0  | 4  | 0  | 0  | 0  | 16  | 12 |
| 2056 | 9  | 9  | 0  | 3  | 42 | 0  | 0  | 0  | 2  | 2  | 2  | 7   | 7  |
| 2057 | 5  | 5  | 0  | 0  | 44 | 0  | 0  | 0  | 0  | 0  | 0  | 6   | 6  |
| 2058 | 0  | 0  | 0  | 0  | 31 | 0  | 0  | 0  | 0  | 0  | 0  | 0   | 0  |
| 2059 | 3  | 3  | 0  | 0  | 8  | 0  | 0  | 0  | 0  | 0  | 0  | 0   | 0  |

| 12%  | 53 | 54 | 55 | 56 | 57 | 58 | 59 | 60 | 61 | 62 | 63 | 64 | 65 |
|------|----|----|----|----|----|----|----|----|----|----|----|----|----|
| 2060 | 0  | 0  | 0  | 0  | 2  | 0  | 0  | 0  | 0  | 0  | 0  | 0  | 0  |
| 2061 | 0  | 0  | 0  | 0  | 6  | 0  | 0  | 0  | 0  | 0  | 0  | 0  | 0  |
| 2062 | 0  | 0  | 0  | 0  | 0  | 0  | 0  | 0  | 0  | 0  | 0  | 0  | 0  |
| 2063 | 0  | 0  | 0  | 0  | 0  | 0  | 0  | 0  | 0  | 0  | 0  | 0  | 0  |
| 2064 | 0  | 0  | 0  | 0  | 0  | 0  | 0  | 0  | 0  | 0  | 0  | 0  | 0  |
| 2065 | 0  | 0  | 0  | 0  | 0  | 0  | 0  | 0  | 0  | 0  | 0  | 0  | 0  |
| 2066 | 0  | 0  | 0  | 0  | 0  | 0  | 0  | 0  | 0  | 0  | 0  | 0  | 0  |
| 2067 | 0  | 0  | 0  | 0  | 0  | 0  | 0  | 0  | 0  | 0  | 0  | 0  | 0  |
| 2068 | 0  | 0  | 0  | 0  | 0  | 0  | 0  | 0  | 0  | 0  | 0  | 0  | 0  |
| 2069 | 0  | 0  | 0  | 0  | 0  | 0  | 0  | 0  | 0  | 0  | 0  | 0  | 0  |
| 2070 | 0  | 0  | 0  | 0  | 0  | 0  | 0  | 0  | 0  | 0  | 0  | 0  | 0  |
| 2071 | 0  | 0  | 0  | 0  | 0  | 0  | 0  | 0  | 0  | 0  | 0  | 0  | 0  |
| 2072 | 0  | 0  | 0  | 0  | 0  | 0  | 0  | 0  | 0  | 0  | 0  | 0  | 0  |
| 2073 | 0  | 0  | 0  | 0  | 0  | 0  | 0  | 0  | 0  | 0  | 0  | 0  | 0  |
| 2074 | 0  | 0  | 0  | 0  | 0  | 0  | 0  | 0  | 0  | 0  | 0  | 0  | 0  |
| 2075 | 0  | 0  | 0  | 0  | 0  | 0  | 0  | 0  | 0  | 0  | 0  | 0  | 0  |
| 2076 | 0  | 0  | 0  | 0  | 0  | 0  | 0  | 0  | 0  | 0  | 0  | 0  | 0  |
| 2077 | 0  | 0  | 0  | 0  | 0  | 0  | 0  | 0  | 0  | 0  | 0  | 0  | 0  |
| 2078 | 0  | 0  | 0  | 0  | 0  | 0  | 0  | 0  | 0  | 0  | 0  | 0  | 0  |
| 2079 | 0  | 0  | 0  | 0  | 0  | 0  | 0  | 0  | 0  | 0  | 0  | 0  | 0  |
| 2080 | 0  | 0  | 0  | 0  | 0  | 0  | 0  | 0  | 0  | 0  | 0  | 0  | 0  |
| 2081 | 0  | 0  | 0  | 0  | 0  | 0  | 0  | 0  | 0  | 0  | 0  | 0  | 0  |
| 2082 | 0  | 0  | 0  | 0  | 0  | 0  | 0  | 0  | 0  | 0  | 0  | 0  | 0  |
| 2083 | 0  | 0  | 0  | 0  | 0  | 0  | 0  | 0  | 0  | 0  | 0  | 0  | 0  |
| 2084 | 0  | 0  | 0  | 0  | 0  | 0  | 0  | 0  | 0  | 0  | 0  | 0  | 0  |
| 2085 | 0  | 0  | 0  | 0  | 0  | 0  | 0  | 0  | 0  | 0  | 0  | 0  | 0  |
| 2086 | 0  | 0  | 0  | 0  | 0  | 0  | 0  | 0  | 0  | 0  | 0  | 0  | 0  |
| 2087 | 0  | 0  | 0  | 0  | 0  | 0  | 0  | 0  | 0  | 0  | 0  | 0  | 0  |
| 2088 | 0  | 0  | 0  | 0  | 0  | 0  | 0  | 0  | 0  | 0  | 0  | 0  | 0  |
| 2089 | 0  | 0  | 0  | 0  | 0  | 0  | 0  | 0  | 0  | 0  | 0  | 0  | 0  |
| 2090 | 0  | 0  | 0  | 0  | 0  | 0  | 0  | 0  | 0  | 0  | 0  | 0  | 0  |

| 12%  | 66 | 67 | 68 | 69 | 70 | 71 | 72 | 73  | 74 | 75 | 76 | 77 | 78 |
|------|----|----|----|----|----|----|----|-----|----|----|----|----|----|
| 2002 |    |    |    |    |    |    |    |     |    |    |    |    |    |
| 2003 | 0  | 0  | 0  | 0  | 0  | 0  | 0  | 0   | 0  | 0  | 0  | 0  | 0  |
| 2004 | 0  | 0  | 0  | 0  | 0  | 0  | 0  | 0   | 0  | 0  | 0  | 0  | 0  |
| 2005 | 0  | 0  | 0  | 0  | 0  | 0  | 0  | 0   | 0  | 0  | 0  | 0  | 0  |
| 2006 | 0  | 0  | 0  | 0  | 0  | 0  | 0  | 0   | 0  | 0  | 0  | 0  | 0  |
| 2007 | 0  | 0  | 0  | 0  | 0  | 0  | 0  | 0   | 0  | 0  | 0  | 0  | 0  |
| 2008 | 0  | 0  | 0  | 0  | 0  | 0  | 0  | 0   | 0  | 0  | 0  | 0  | 0  |
| 2009 | 0  | 0  | 0  | 0  | 0  | 0  | 0  | 0   | 0  | 0  | 0  | 0  | 0  |
| 2010 | 0  | 0  | 0  | 0  | 0  | 0  | 0  | 0   | 0  | 0  | 0  | 0  | 0  |
| 2011 | 0  | 0  | 0  | 0  | 0  | 0  | 0  | 0   | 0  | 0  | 0  | 0  | 0  |
| 2012 | 0  | 0  | 0  | 0  | 0  | 0  | 0  | 0   | 0  | 0  | 0  | 0  | 0  |
| 2013 | 0  | 0  | 0  | 0  | 0  | 0  | 0  | 0   | 0  | 0  | 0  | 0  | 0  |
| 2014 | 0  | 0  | 0  | 0  | 0  | 0  | 0  | 0   | 0  | 0  | 0  | 0  | 0  |
| 2015 | 0  | 0  | 0  | 0  | 0  | 0  | 0  | 0   | 0  | 0  | 0  | 0  | 0  |
| 2016 | 0  | 0  | 0  | 0  | 0  | 0  | 0  | 0   | 0  | 0  | 0  | 0  | 0  |
| 2017 | 0  | 0  | 0  | 0  | 0  | 0  | 0  | 0   | 0  | 0  | 0  | 0  | 0  |
| 2018 | 0  | 0  | 0  | 0  | 0  | 0  | 0  | 0   | 0  | 0  | 0  | 0  | 0  |
| 2019 | 0  | 0  | 0  | 0  | 0  | 0  | 0  | 0   | 0  | 0  | 0  | 0  | 0  |
| 2020 | 0  | 0  | 0  | 0  | 0  | 0  | 0  | 0   | 0  | 0  | 0  | 0  | 0  |
| 2021 | 0  | 51 | 0  | 0  | 0  | 0  | 0  | 0   | 0  | 0  | 43 | 0  | 0  |
| 2022 | 0  | 43 | 0  | 0  | 0  | 0  | 0  | 0   | 0  | 0  | 45 | 0  | 0  |
| 2023 | 0  | 33 | 0  | 0  | 0  | 0  | 0  | 0   | 0  | 0  | 32 | 0  | 0  |
| 2024 | 0  | 28 | 0  | 0  | 0  | 0  | 0  | 0   | 0  | 0  | 30 | 0  | 0  |
| 2025 | 0  | 10 | 0  | 0  | 0  | 0  | 0  | 0   | 0  | 0  | 10 | 0  | 0  |
| 2026 | 0  | 12 | 1  | 1  | 1  | 0  | 1  | 29  | 0  | 0  | 15 | 1  | 1  |
| 2027 | 0  | 16 | 18 | 18 | 18 | 14 | 18 | 48  | 0  | 0  | 14 | 17 | 18 |
| 2028 | 0  | 6  | 23 | 23 | 23 | 23 | 23 | 67  | 0  | 0  | 8  | 25 | 24 |
| 2029 | 0  | 16 | 41 | 46 | 41 | 37 | 41 | 53  | 18 | 0  | 16 | 47 | 45 |
| 2030 | 0  | 15 | 34 | 29 | 34 | 36 | 34 | 39  | 12 | 0  | 17 | 29 | 31 |
| 2031 | 0  | 2  | 14 | 14 | 14 | 16 | 14 | 35  | 13 | 0  | 2  | 14 | 14 |
| 2032 | 0  | 14 | 8  | 13 | 14 | 15 | 14 | 23  | 4  | 0  | 9  | 13 | 13 |
| 2033 | 6  | 7  | 21 | 26 | 25 | 26 | 25 | 28  | 5  | 6  | 3  | 21 | 26 |
| 2034 | 14 | 18 | 16 | 19 | 19 | 19 | 19 | 16  | 3  | 14 | 12 | 11 | 19 |
| 2035 | 48 | 8  | 12 | 6  | 6  | 9  | 6  | 14  | 12 | 48 | 6  | 12 | 6  |
| 2036 | 31 | 5  | 23 | 19 | 19 | 19 | 19 | 19  | 12 | 31 | 11 | 16 | 19 |
| 2037 | 25 | 0  | 12 | 8  | 9  | 9  | 9  | 6   | 6  | 25 | 7  | 6  | 8  |
| 2038 | 16 | 0  | 6  | 6  | 6  | 6  | 6  | 18  | 13 | 16 | 5  | 12 | 6  |
| 2039 | 18 | 6  | 4  | 9  | 3  | 3  | 3  | 12  | 2  | 18 | 0  | 9  | 3  |
| 2040 | 8  | 0  | 6  | 7  | 6  | 6  | 6  | 8   | 0  | 6  | 0  | 6  | 6  |
| 2041 | 13 | 0  | 12 | 6  | 12 | 12 | 12 | 11  | 6  | 13 | 6  | 7  | 12 |
| 2042 | 12 | 6  | 7  | 12 | 7  | 7  | 7  | 18  | 5  | 13 | 6  | 12 | 7  |
| 2043 | 30 | 6  | 2  | 13 | 2  | 2  | 2  | 3   | 0  | 30 | 8  | 8  | 13 |
| 2044 | 15 | 8  | 12 | 6  | 12 | 12 | 12 | 6   | 0  | 15 | 12 | 2  | 8  |
| 2045 | 12 | 3  | 5  | 0  | 8  | 8  | 8  | 6   | 3  | 12 | 66 | 0  | 5  |
| 2046 | 2  | 62 | 0  | 0  | 5  | 5  | 5  | 11  | 0  | 6  | 58 | 6  | 0  |
| 2047 | 0  | 52 | 5  | 0  | 0  | 0  | 0  | 43  | 0  | 0  | 30 | 6  | 12 |
| 2048 | 6  | 26 | 0  | 6  | 0  | 0  | 0  | 94  | 6  | 6  | 12 | 21 | 40 |
| 2049 | 6  | 18 | 3  | 49 | 0  | 0  | 0  | 111 | 14 | 8  | 6  | 68 | 54 |
| 2050 | 0  | 12 | 16 | 55 | 22 | 22 | 22 | 68  | 15 | 0  | 0  | 39 | 21 |
| 2051 | 6  | 6  | 68 | 18 | 64 | 64 | 64 | 29  | 12 | 10 | 0  | 23 | 20 |
| 2052 | 6  | 4  | 33 | 24 | 36 | 36 | 36 | 22  | 6  | 36 | 0  | 22 | 22 |
| 2053 | 39 | 0  | 28 | 22 | 23 | 23 | 23 | 16  | 12 | 48 | 0  | 18 | 18 |
| 2054 | 42 | 0  | 24 | 18 | 22 | 22 | 22 | 7   | 7  | 35 | 0  | 12 | 12 |
| 2055 | 35 | 0  | 18 | 12 | 18 | 18 | 18 | 6   | 6  | 32 | 0  | 6  | 6  |
| 2056 | 37 | 0  | 12 | 4  | 12 | 12 | 12 | 0   | 0  | 19 | 0  | 0  | 3  |
| 2057 | 19 | 0  | 6  | 0  | 6  | 6  | 6  | 0   | 0  | 18 | 0  | 0  | 0  |
| 2058 | 18 | 0  | 3  | 0  | 3  | 3  | 3  | 0   | 0  | 12 | 0  | 0  | 0  |
| 2059 | 12 | 0  | 0  | 0  | 0  | 0  | 0  | 0   | 0  | 6  | 0  | 0  | 0  |

| 12%  | 66 | 67 | 68 | 69 | 70 | 71 | 72 | 73 | 74 | 75 | 76 | 77 | 78 |
|------|----|----|----|----|----|----|----|----|----|----|----|----|----|
| 2060 | 6  | 0  | 0  | 0  | 0  | 0  | 0  | 0  | 0  | 6  | 0  | 0  | 0  |
| 2061 | 6  | 0  | 0  | 0  | 0  | 0  | 0  | 0  | 0  | 3  | 0  | 0  | 0  |
| 2062 | 3  | 0  | 0  | 0  | 0  | 0  | 0  | 0  | 0  | 0  | 0  | 0  | 0  |
| 2063 | 0  | 0  | 0  | 0  | 0  | 0  | 0  | 0  | 0  | 0  | 0  | 0  | 0  |
| 2064 | 0  | 0  | 0  | 0  | 0  | 0  | 0  | 0  | 0  | 0  | 0  | 0  | 0  |
| 2065 | 0  | 0  | 0  | 0  | 0  | 0  | 0  | 0  | 0  | 0  | 0  | 0  | 0  |
| 2066 | 0  | 0  | 0  | 0  | 0  | 0  | 0  | 0  | 0  | 0  | 0  | 0  | 0  |
| 2067 | 0  | 0  | 0  | 0  | 0  | 0  | 0  | 0  | 0  | 0  | 0  | 0  | 0  |
| 2068 | 0  | 0  | 0  | 0  | 0  | 0  | 0  | 0  | 0  | 0  | 0  | 0  | 0  |
| 2069 | 0  | 0  | 0  | 0  | 0  | 0  | 0  | 0  | 0  | 0  | 0  | 0  | 0  |
| 2070 | 0  | 0  | 0  | 0  | 0  | 0  | 0  | 0  | 0  | 0  | 0  | 0  | 0  |
| 2071 | 0  | 0  | 0  | 0  | 0  | 0  | 0  | 0  | 0  | 0  | 0  | 0  | 0  |
| 2072 | 0  | 0  | 0  | 0  | 0  | 0  | 0  | 0  | 0  | 0  | 0  | 0  | 0  |
| 2073 | 0  | 0  | 0  | 0  | 0  | 0  | 0  | 0  | 0  | 0  | 0  | 0  | 0  |
| 2074 | 0  | 0  | 0  | 0  | 0  | 0  | 0  | 0  | 0  | 0  | 0  | 0  | 0  |
| 2075 | 0  | 0  | 0  | 0  | 0  | 0  | 0  | 0  | 0  | 0  | 0  | 0  | 0  |
| 2076 | 0  | 0  | 0  | 0  | 0  | 0  | 0  | 0  | 0  | 0  | 0  | 0  | 0  |
| 2077 | 0  | 0  | 0  | 0  | 0  | 0  | 0  | 0  | 0  | 0  | 0  | 0  | 0  |
| 2078 | 0  | 0  | 0  | 0  | 0  | 0  | 0  | 0  | 0  | 0  | 0  | 0  | 0  |
| 2079 | 0  | 0  | 0  | 0  | 0  | 0  | 0  | 0  | 0  | 0  | 0  | 0  | 0  |
| 2080 | 0  | 0  | 0  | 0  | 0  | 0  | 0  | 0  | 0  | 0  | 0  | 0  | 0  |
| 2081 | 0  | 0  | 0  | 0  | 0  | 0  | 0  | 0  | 0  | 0  | 0  | 0  | 0  |
| 2082 | 0  | 0  | 0  | 0  | 0  | 0  | 0  | 0  | 0  | 0  | 0  | 0  | 0  |
| 2083 | 0  | 0  | 0  | 0  | 0  | 0  | 0  | 0  | 0  | 0  | 0  | 0  | 0  |
| 2084 | 0  | 0  | 0  | 0  | 0  | 0  | 0  | 0  | 0  | 0  | 0  | 0  | 0  |
| 2085 | 0  | 0  | 0  | 0  | 0  | 0  | 0  | 0  | 0  | 0  | 0  | 0  | 0  |
| 2086 | 0  | 0  | 0  | 0  | 0  | 0  | 0  | 0  | 0  | 0  | 0  | 0  | 0  |
| 2087 | 0  | 0  | 0  | 0  | 0  | 0  | 0  | 0  | 0  | 0  | 0  | 0  | 0  |
| 2088 | 0  | 0  | 0  | 0  | 0  | 0  | 0  | 0  | 0  | 0  | 0  | 0  | 0  |
| 2089 | 0  | 0  | 0  | 0  | 0  | 0  | 0  | 0  | 0  | 0  | 0  | 0  | 0  |
| 2090 | 0  | 0  | 0  | 0  | 0  | 0  | 0  | 0  | 0  | 0  | 0  | 0  | 0  |

| 12%  | 79 | 80 | 81 | 82 | 83 | 84 | 85 | 86 | 87 | 88 | 89 | 90 | 91 |
|------|----|----|----|----|----|----|----|----|----|----|----|----|----|
| 2002 |    |    |    |    |    |    |    |    |    |    |    |    |    |
| 2003 | 0  | 0  | 0  | 0  | 0  | 0  | 0  | 0  | 0  | 0  | 0  | 0  | 0  |
| 2004 | 0  | 0  | 0  | 0  | 0  | 0  | 0  | 0  | 0  | 0  | 0  | 0  | 0  |
| 2005 | 0  | 0  | 0  | 0  | 0  | 0  | 0  | 0  | 0  | 0  | 0  | 0  | 0  |
| 2006 | 0  | 0  | 0  | 0  | 0  | 0  | 0  | 0  | 0  | 0  | 0  | 0  | 0  |
| 2007 | 0  | 0  | 0  | 0  | 0  | 0  | 0  | 0  | 0  | 0  | 0  | 0  | 0  |
| 2008 | 0  | 0  | 0  | 0  | 0  | 0  | 0  | 0  | 0  | 0  | 0  | 0  | 0  |
| 2009 | 0  | 0  | 0  | 0  | 0  | 0  | 0  | 0  | 0  | 0  | 0  | 0  | 0  |
| 2010 | 0  | 0  | 0  | 0  | 0  | 0  | 0  | 0  | 0  | 0  | 0  | 0  | 0  |
| 2011 | 0  | 0  | 0  | 0  | 0  | 0  | 0  | 0  | 0  | 0  | 0  | 0  | 0  |
| 2012 | 0  | 0  | 0  | 0  | 0  | 0  | 0  | 0  | 0  | 0  | 0  | 0  | 0  |
| 2013 | 0  | 0  | 0  | 0  | 0  | 0  | 0  | 0  | 0  | 0  | 0  | 0  | 0  |
| 2014 | 0  | 0  | 0  | 0  | 0  | 0  | 0  | 0  | 0  | 0  | 0  | 0  | 0  |
| 2015 | 0  | 0  | 0  | 0  | 0  | 0  | 0  | 0  | 0  | 0  | 0  | 0  | 0  |
| 2016 | 0  | 0  | 0  | 0  | 0  | 0  | 0  | 0  | 0  | 0  | 0  | 0  | 0  |
| 2017 | 0  | 0  | 0  | 0  | 0  | 0  | 0  | 0  | 0  | 0  | 0  | 0  | 0  |
| 2018 | 0  | 0  | 0  | 0  | 0  | 0  | 0  | 0  | 0  | 0  | 0  | 0  | 0  |
| 2019 | 0  | 0  | 0  | 0  | 0  | 0  | 0  | 0  | 0  | 0  | 0  | 0  | 0  |
| 2020 | 0  | 0  | 0  | 0  | 0  | 0  | 0  | 0  | 0  | 0  | 0  | 0  | 0  |
| 2021 | 0  | 0  | 0  | 0  | 0  | 0  | 23 | 0  | 0  | 0  | 0  | 0  | 0  |
| 2022 | 0  | 0  | 0  | 0  | 0  | 0  | 31 | 0  | 0  | 0  | 0  | 0  | 0  |
| 2023 | 0  | 0  | 0  | 0  | 0  | 0  | 18 | 0  | 0  | 0  | 0  | 0  | 0  |
| 2024 | 0  | 0  | 0  | 0  | 0  | 0  | 30 | 0  | 0  | 0  | 0  | 0  | 0  |
| 2025 | 0  | 0  | 0  | 0  | 0  | 0  | 21 | 0  | 0  | 0  | 0  | 0  | 0  |
| 2026 | 1  | 0  | 1  | 25 | 3  | 0  | 17 | 10 | 10 | 10 | 10 | 10 | 58 |
| 2027 | 18 | 8  | 17 | 41 | 5  | 0  | 16 | 16 | 16 | 16 | 16 | 16 | 54 |
| 2028 | 23 | 15 | 25 | 36 | 6  | 0  | 21 | 19 | 19 | 19 | 19 | 19 | 46 |
| 2029 | 41 | 30 | 41 | 45 | 6  | 0  | 13 | 21 | 21 | 21 | 21 | 21 | 50 |
| 2030 | 34 | 29 | 34 | 41 | 7  | 0  | 11 | 22 | 22 | 22 | 22 | 22 | 41 |
| 2031 | 14 | 31 | 14 | 28 | 5  | 6  | 7  | 14 | 14 | 14 | 14 | 14 | 31 |
| 2032 | 8  | 12 | 8  | 41 | 9  | 13 | 7  | 27 | 27 | 27 | 27 | 27 | 22 |
| 2033 | 21 | 23 | 21 | 41 | 10 | 15 | 6  | 26 | 26 | 26 | 26 | 26 | 21 |
| 2034 | 19 | 23 | 19 | 31 | 7  | 16 | 11 | 18 | 18 | 18 | 18 | 18 | 21 |
| 2035 | 12 | 15 | 12 | 18 | 6  | 22 | 7  | 12 | 12 | 12 | 12 | 12 | 13 |
| 2036 | 20 | 21 | 20 | 13 | 3  | 23 | 11 | 5  | 9  | 5  | 5  | 5  | 16 |
| 2037 | 6  | 6  | 6  | 13 | 3  | 23 | 3  | 8  | 4  | 8  | 8  | 8  | 13 |
| 2038 | 12 | 15 | 12 | 11 | 2  | 19 | 1  | 3  | 5  | 3  | 3  | 3  | 14 |
| 2039 | 4  | 5  | 4  | 12 | 3  | 21 | 11 | 6  | 9  | 8  | 8  | 8  | 13 |
| 2040 | 6  | 8  | 6  | 16 | 3  | 12 | 3  | 7  | 9  | 9  | 9  | 9  | 8  |
| 2041 | 6  | 6  | 6  | 14 | 0  | 10 | 0  | 6  | 3  | 6  | 6  | 6  | 12 |
| 2042 | 12 | 12 | 12 | 3  | 0  | 3  | 11 | 2  | 4  | 0  | 0  | 0  | 16 |
| 2043 | 2  | 2  | 2  | 9  | 0  | 7  | 5  | 0  | 5  | 2  | 2  | 2  | 10 |
| 2044 | 0  | 0  | 0  | 16 | 2  | 6  | 75 | 8  | 5  | 9  | 9  | 9  | 8  |
| 2045 | 6  | 6  | 6  | 15 | 2  | 5  | 50 | 7  | 5  | 8  | 8  | 8  | 6  |
| 2046 | 2  | 2  | 2  | 85 | 18 | 9  | 38 | 42 | 45 | 46 | 46 | 46 | 5  |
| 2047 | 6  | 6  | 6  | 67 | 13 | 8  | 33 | 38 | 38 | 39 | 39 | 39 | 0  |
| 2048 | 28 | 28 | 28 | 76 | 21 | 5  | 2  | 46 | 46 | 47 | 47 | 47 | 0  |
| 2049 | 72 | 72 | 72 | 55 | 17 | 22 | 6  | 38 | 38 | 36 | 36 | 36 | 85 |
| 2050 | 28 | 28 | 28 | 42 | 15 | 26 | 0  | 30 | 31 | 30 | 30 | 30 | 82 |
| 2051 | 26 | 26 | 26 | 37 | 15 | 27 | 0  | 27 | 26 | 26 | 26 | 26 | 78 |
| 2052 | 24 | 24 | 24 | 25 | 9  | 29 | 0  | 18 | 16 | 16 | 16 | 16 | 56 |
| 2053 | 18 | 18 | 18 | 6  | 3  | 34 | 0  | 9  | 5  | 5  | 5  | 5  | 36 |
| 2054 | 12 | 12 | 12 | 3  | 2  | 29 | 0  | 2  | 2  | 2  | 2  | 2  | 18 |
| 2055 | 0  | 0  | 0  | 5  | 2  | 28 | 0  | 3  | 4  | 3  | 3  | 3  | 15 |
| 2056 | 0  | 0  | 0  | 0  | 0  | 23 | 0  | 0  | 0  | 0  | 0  | 0  | 9  |
| 2057 | 0  | 0  | 0  | 0  | 0  | 22 | 0  | 0  | 0  | 0  | 0  | 0  | 5  |
| 2058 | 0  | 0  | 0  | 0  | 0  | 13 | 0  | 0  | 0  | 0  | 0  | 0  | 4  |
| 2059 | 0  | 0  | 0  | 0  | 0  | 13 | 0  | 0  | 0  | 0  | 0  | 0  | 0  |

| 12%  | 79 | 80 | 81 | 82 | 83 | 84 | 85 | 86 | 87 | 88 | 89 | 90 | 91 |
|------|----|----|----|----|----|----|----|----|----|----|----|----|----|
| 2060 | 0  | 0  | 0  | 0  | 0  | 2  | 0  | 0  | 0  | 0  | 0  | 0  | 0  |
| 2061 | 0  | 0  | 0  | 0  | 0  | 2  | 0  | 0  | 0  | 0  | 0  | 0  | 0  |
| 2062 | 0  | 0  | 0  | 0  | 0  | 0  | 0  | 0  | 0  | 0  | 0  | 0  | 0  |
| 2063 | 0  | 0  | 0  | 0  | 0  | 0  | 0  | 0  | 0  | 0  | 0  | 0  | 0  |
| 2064 | 0  | 0  | 0  | 0  | 0  | 0  | 0  | 0  | 0  | 0  | 0  | 0  | 0  |
| 2065 | 0  | 0  | 0  | 0  | 0  | 0  | 0  | 0  | 0  | 0  | 0  | 0  | 0  |
| 2066 | 0  | 0  | 0  | 0  | 0  | 0  | 0  | 0  | 0  | 0  | 0  | 0  | 0  |
| 2067 | 0  | 0  | 0  | 0  | 0  | 0  | 0  | 0  | 0  | 0  | 0  | 0  | 0  |
| 2068 | 0  | 0  | 0  | 0  | 0  | 0  | 0  | 0  | 0  | 0  | 0  | 0  | 0  |
| 2069 | 0  | 0  | 0  | 0  | 0  | 0  | 0  | 0  | 0  | 0  | 0  | 0  | 0  |
| 2070 | 0  | 0  | 0  | 0  | 0  | 0  | 0  | 0  | 0  | 0  | 0  | 0  | 0  |
| 2071 | 0  | 0  | 0  | 0  | 0  | 0  | 0  | 0  | 0  | 0  | 0  | 0  | 0  |
| 2072 | 0  | 0  | 0  | 0  | 0  | 0  | 0  | 0  | 0  | 0  | 0  | 0  | 0  |
| 2073 | 0  | 0  | 0  | 0  | 0  | 0  | 0  | 0  | 0  | 0  | 0  | 0  | 0  |
| 2074 | 0  | 0  | 0  | 0  | 0  | 0  | 0  | 0  | 0  | 0  | 0  | 0  | 0  |
| 2075 | 0  | 0  | 0  | 0  | 0  | 0  | 0  | 0  | 0  | 0  | 0  | 0  | 0  |
| 2076 | 0  | 0  | 0  | 0  | 0  | 0  | 0  | 0  | 0  | 0  | 0  | 0  | 0  |
| 2077 | 0  | 0  | 0  | 0  | 0  | 0  | 0  | 0  | 0  | 0  | 0  | 0  | 0  |
| 2078 | 0  | 0  | 0  | 0  | 0  | 0  | 0  | 0  | 0  | 0  | 0  | 0  | 0  |
| 2079 | 0  | 0  | 0  | 0  | 0  | 0  | 0  | 0  | 0  | 0  | 0  | 0  | 0  |
| 2080 | 0  | 0  | 0  | 0  | 0  | 0  | 0  | 0  | 0  | 0  | 0  | 0  | 0  |
| 2081 | 0  | 0  | 0  | 0  | 0  | 0  | 0  | 0  | 0  | 0  | 0  | 0  | 0  |
| 2082 | 0  | 0  | 0  | 0  | 0  | 0  | 0  | 0  | 0  | 0  | 0  | 0  | 0  |
| 2083 | 0  | 0  | 0  | 0  | 0  | 0  | 0  | 0  | 0  | 0  | 0  | 0  | 0  |
| 2084 | 0  | 0  | 0  | 0  | 0  | 0  | 0  | 0  | 0  | 0  | 0  | 0  | 0  |
| 2085 | 0  | 0  | 0  | 0  | 0  | 0  | 0  | 0  | 0  | 0  | 0  | 0  | 0  |
| 2086 | 0  | 0  | 0  | 0  | 0  | 0  | 0  | 0  | 0  | 0  | 0  | 0  | 0  |
| 2087 | 0  | 0  | 0  | 0  | 0  | 0  | 0  | 0  | 0  | 0  | 0  | 0  | 0  |
| 2088 | 0  | 0  | 0  | 0  | 0  | 0  | 0  | 0  | 0  | 0  | 0  | 0  | 0  |
| 2089 | 0  | 0  | 0  | 0  | 0  | 0  | 0  | 0  | 0  | 0  | 0  | 0  | 0  |
| 2090 | 0  | 0  | 0  | 0  | 0  | 0  | 0  | 0  | 0  | 0  | 0  | 0  | 0  |



| 12%  | 92 | 93 | 94 | 95 | 96 | 97 | 98 | 99 | 100 | 101 | 102 | 103 | 104 |
|------|----|----|----|----|----|----|----|----|-----|-----|-----|-----|-----|
| 2002 |    |    |    |    |    |    |    |    |     |     |     |     |     |
| 2003 | 0  | 0  | 0  | 0  | 0  | 0  | 0  | 0  | 0   | 0   | 0   | 0   | 0   |
| 2004 | 0  | 0  | 0  | 0  | 0  | 0  | 0  | 0  | 0   | 0   | 0   | 0   | 0   |
| 2005 | 0  | 0  | 0  | 0  | 0  | 0  | 0  | 0  | 0   | 0   | 0   | 0   | 0   |
| 2006 | 0  | 0  | 0  | 0  | 0  | 0  | 0  | 0  | 0   | 0   | 0   | 0   | 0   |
| 2007 | 0  | 0  | 0  | 0  | 0  | 0  | 0  | 0  | 0   | 0   | 0   | 0   | 0   |
| 2008 | 0  | 0  | 0  | 0  | 0  | 0  | 0  | 0  | 0   | 0   | 0   | 0   | 0   |
| 2009 | 0  | 0  | 0  | 0  | 0  | 0  | 0  | 0  | 0   | 0   | 0   | 0   | 0   |
| 2010 | 0  | 0  | 0  | 0  | 0  | 0  | 0  | 0  | 0   | 0   | 0   | 0   | 0   |
| 2011 | 0  | 0  | 0  | 0  | 0  | 0  | 0  | 0  | 0   | 0   | 0   | 0   | 0   |
| 2012 | 0  | 0  | 0  | 0  | 0  | 0  | 0  | 0  | 0   | 0   | 0   | 0   | 0   |
| 2013 | 0  | 0  | 0  | 0  | 0  | 0  | 0  | 0  | 0   | 0   | 0   | 0   | 0   |
| 2014 | 0  | 0  | 0  | 0  | 0  | 0  | 0  | 0  | 0   | 0   | 0   | 0   | 0   |
| 2015 | 0  | 0  | 0  | 0  | 0  | 0  | 0  | 0  | 0   | 0   | 0   | 0   | 0   |
| 2016 | 0  | 0  | 0  | 0  | 0  | 0  | 0  | 0  | 0   | 0   | 0   | 0   | 0   |
| 2017 | 0  | 0  | 0  | 0  | 0  | 0  | 0  | 0  | 0   | 0   | 0   | 0   | 0   |
| 2018 | 0  | 0  | 0  | 0  | 0  | 0  | 0  | 0  | 0   | 0   | 0   | 0   | 0   |
| 2019 | 0  | 0  | 0  | 0  | 0  | 0  | 0  | 0  | 0   | 0   | 0   | 0   | 0   |
| 2020 | 0  | 0  | 0  | 0  | 0  | 0  | 0  | 0  | 0   | 0   | 0   | 0   | 0   |
| 2021 | 0  | 0  | 51 | 0  | 0  | 0  | 0  | 0  | 0   | 0   | 0   | 46  | 0   |
| 2022 | 0  | 0  | 33 | 0  | 0  | 0  | 0  | 0  | 0   | 0   | 0   | 35  | 0   |
| 2023 | 0  | 0  | 41 | 0  | 0  | 0  | 0  | 0  | 0   | 0   | 0   | 38  | 0   |
| 2024 | 0  | 0  | 28 | 0  | 0  | 0  | 0  | 0  | 0   | 0   | 0   | 30  | 0   |
| 2025 | 0  | 0  | 12 | 0  | 0  | 0  | 0  | 0  | 0   | 0   | 0   | 12  | 0   |
| 2026 | 11 | 0  | 12 | 28 | 28 | 28 | 25 | 28 | 57  | 11  | 0   | 14  | 28  |
| 2027 | 15 | 0  | 16 | 33 | 33 | 33 | 32 | 33 | 51  | 15  | 0   | 15  | 34  |
| 2028 | 10 | 0  | 10 | 23 | 23 | 23 | 21 | 23 | 49  | 10  | 0   | 10  | 25  |
| 2029 | 12 | 0  | 13 | 29 | 30 | 29 | 26 | 29 | 48  | 12  | 0   | 10  | 32  |
| 2030 | 11 | 0  | 13 | 28 | 28 | 28 | 32 | 28 | 41  | 11  | 0   | 18  | 26  |
| 2031 | 9  | 21 | 6  | 20 | 20 | 20 | 19 | 20 | 32  | 9   | 21  | 6   | 20  |
| 2032 | 5  | 25 | 12 | 10 | 11 | 12 | 13 | 12 | 22  | 5   | 25  | 6   | 8   |
| 2033 | 4  | 28 | 11 | 13 | 16 | 13 | 15 | 13 | 22  | 5   | 28  | 7   | 15  |
| 2034 | 6  | 21 | 13 | 11 | 13 | 12 | 12 | 12 | 19  | 6   | 21  | 9   | 11  |
| 2035 | 4  | 27 | 6  | 7  | 6  | 7  | 10 | 7  | 12  | 4   | 27  | 9   | 6   |
| 2036 | 6  | 21 | 7  | 12 | 11 | 11 | 11 | 11 | 19  | 6   | 21  | 8   | 12  |
| 2037 | 5  | 18 | 1  | 8  | 9  | 9  | 9  | 9  | 9   | 4   | 18  | 8   | 8   |
| 2038 | 5  | 15 | 0  | 11 | 10 | 9  | 9  | 9  | 16  | 5   | 15  | 5   | 11  |
| 2039 | 5  | 11 | 0  | 10 | 11 | 10 | 10 | 10 | 14  | 5   | 11  | 1   | 9   |
| 2040 | 2  | 11 | 0  | 7  | 8  | 5  | 5  | 5  | 11  | 3   | 11  | 0   | 7   |
| 2041 | 3  | 15 | 0  | 7  | 9  | 8  | 8  | 8  | 10  | 3   | 15  | 0   | 8   |
| 2042 | 4  | 15 | 6  | 8  | 8  | 11 | 11 | 11 | 16  | 3   | 15  | 9   | 9   |
| 2043 | 3  | 13 | 0  | 6  | 5  | 6  | 6  | 6  | 5   | 2   | 12  | 7   | 4   |
| 2044 | 3  | 11 | 0  | 3  | 4  | 6  | 6  | 6  | 4   | 1   | 9   | 13  | 5   |
| 2045 | 1  | 6  | 0  | 1  | 4  | 3  | 3  | 3  | 6   | 2   | 6   | 63  | 1   |
| 2046 | 2  | 3  | 8  | 0  | 7  | 3  | 3  | 3  | 14  | 3   | 5   | 55  | 3   |
| 2047 | 0  | 2  | 0  | 0  | 3  | 0  | 0  | 0  | 82  | 12  | 5   | 29  | 41  |
| 2048 | 0  | 2  | 65 | 3  | 42 | 0  | 0  | 0  | 84  | 13  | 2   | 13  | 43  |
| 2049 | 12 | 3  | 59 | 41 | 40 | 41 | 41 | 41 | 81  | 14  | 4   | 11  | 40  |
| 2050 | 12 | 29 | 33 | 43 | 41 | 41 | 41 | 41 | 56  | 12  | 28  | 5   | 35  |
| 2051 | 13 | 31 | 13 | 42 | 28 | 41 | 41 | 41 | 36  | 9   | 31  | 5   | 22  |
| 2052 | 12 | 30 | 12 | 35 | 16 | 33 | 33 | 33 | 19  | 5   | 32  | 0   | 11  |
| 2053 | 9  | 34 | 8  | 22 | 9  | 21 | 21 | 21 | 15  | 4   | 36  | 0   | 10  |
| 2054 | 5  | 31 | 0  | 12 | 10 | 11 | 11 | 11 | 9   | 3   | 28  | 0   | 6   |
| 2055 | 4  | 26 | 0  | 10 | 6  | 10 | 10 | 10 | 5   | 2   | 26  | 0   | 3   |
| 2056 | 3  | 16 | 0  | 6  | 3  | 6  | 6  | 6  | 4   | 2   | 15  | 0   | 0   |
| 2057 | 2  | 13 | 0  | 3  | 3  | 3  | 3  | 3  | 0   | 0   | 11  | 0   | 0   |
| 2058 | 2  | 8  | 0  | 3  | 0  | 3  | 3  | 3  | 0   | 0   | 8   | 0   | 0   |
| 2059 | 0  | 5  | 0  | 0  | 0  | 0  | 0  | 0  | 0   | 0   | 5   | 0   | 0   |

| 12%  | 92 | 93 | 94 | 95 | 96 | 97 | 98 | 99 | 100 | 101 | 102 | 103 | 104 |
|------|----|----|----|----|----|----|----|----|-----|-----|-----|-----|-----|
| 2060 | 0  | 3  | 0  | 0  | 0  | 0  | 0  | 0  | 0   | 0   | 3   | 0   | 0   |
| 2061 | 0  | 3  | 0  | 0  | 0  | 0  | 0  | 0  | 0   | 0   | 3   | 0   | 0   |
| 2062 | 0  | 2  | 0  | 0  | 0  | 0  | 0  | 0  | 0   | 0   | 2   | 0   | 0   |
| 2063 | 0  | 0  | 0  | 0  | 0  | 0  | 0  | 0  | 0   | 0   | 0   | 0   | 0   |
| 2064 | 0  | 0  | 0  | 0  | 0  | 0  | 0  | 0  | 0   | 0   | 0   | 0   | 0   |
| 2065 | 0  | 0  | 0  | 0  | 0  | 0  | 0  | 0  | 0   | 0   | 0   | 0   | 0   |
| 2066 | 0  | 0  | 0  | 0  | 0  | 0  | 0  | 0  | 0   | 0   | 0   | 0   | 0   |
| 2067 | 0  | 0  | 0  | 0  | 0  | 0  | 0  | 0  | 0   | 0   | 0   | 0   | 0   |
| 2068 | 0  | 0  | 0  | 0  | 0  | 0  | 0  | 0  | 0   | 0   | 0   | 0   | 0   |
| 2069 | 0  | 0  | 0  | 0  | 0  | 0  | 0  | 0  | 0   | 0   | 0   | 0   | 0   |
| 2070 | 0  | 0  | 0  | 0  | 0  | 0  | 0  | 0  | 0   | 0   | 0   | 0   | 0   |
| 2071 | 0  | 0  | 0  | 0  | 0  | 0  | 0  | 0  | 0   | 0   | 0   | 0   | 0   |
| 2072 | 0  | 0  | 0  | 0  | 0  | 0  | 0  | 0  | 0   | 0   | 0   | 0   | 0   |
| 2073 | 0  | 0  | 0  | 0  | 0  | 0  | 0  | 0  | 0   | 0   | 0   | 0   | 0   |
| 2074 | 0  | 0  | 0  | 0  | 0  | 0  | 0  | 0  | 0   | 0   | 0   | 0   | 0   |
| 2075 | 0  | 0  | 0  | 0  | 0  | 0  | 0  | 0  | 0   | 0   | 0   | 0   | 0   |
| 2076 | 0  | 0  | 0  | 0  | 0  | 0  | 0  | 0  | 0   | 0   | 0   | 0   | 0   |
| 2077 | 0  | 0  | 0  | 0  | 0  | 0  | 0  | 0  | 0   | 0   | 0   | 0   | 0   |
| 2078 | 0  | 0  | 0  | 0  | 0  | 0  | 0  | 0  | 0   | 0   | 0   | 0   | 0   |
| 2079 | 0  | 0  | 0  | 0  | 0  | 0  | 0  | 0  | 0   | 0   | 0   | 0   | 0   |
| 2080 | 0  | 0  | 0  | 0  | 0  | 0  | 0  | 0  | 0   | 0   | 0   | 0   | 0   |
| 2081 | 0  | 0  | 0  | 0  | 0  | 0  | 0  | 0  | 0   | 0   | 0   | 0   | 0   |
| 2082 | 0  | 0  | 0  | 0  | 0  | 0  | 0  | 0  | 0   | 0   | 0   | 0   | 0   |
| 2083 | 0  | 0  | 0  | 0  | 0  | 0  | 0  | 0  | 0   | 0   | 0   | 0   | 0   |
| 2084 | 0  | 0  | 0  | 0  | 0  | 0  | 0  | 0  | 0   | 0   | 0   | 0   | 0   |
| 2085 | 0  | 0  | 0  | 0  | 0  | 0  | 0  | 0  | 0   | 0   | 0   | 0   | 0   |
| 2086 | 0  | 0  | 0  | 0  | 0  | 0  | 0  | 0  | 0   | 0   | 0   | 0   | 0   |
| 2087 | 0  | 0  | 0  | 0  | 0  | 0  | 0  | 0  | 0   | 0   | 0   | 0   | 0   |
| 2088 | 0  | 0  | 0  | 0  | 0  | 0  | 0  | 0  | 0   | 0   | 0   | 0   | 0   |
| 2089 | 0  | 0  | 0  | 0  | 0  | 0  | 0  | 0  | 0   | 0   | 0   | 0   | 0   |
| 2090 | 0  | 0  | 0  | 0  | 0  | 0  | 0  | 0  | 0   | 0   | 0   | 0   | 0   |

| 12%  | 105 | 106 | 107 | 108 | 109 | 110 | 111 | 112 | 113 | 114 | 115 | 116 | 117 |
|------|-----|-----|-----|-----|-----|-----|-----|-----|-----|-----|-----|-----|-----|
| 2002 |     |     |     |     |     |     |     |     |     |     |     |     |     |
| 2003 | 0   | 0   | 0   | 0   | 0   | 0   | 0   | 0   | 0   | 0   | 0   | 0   | 0   |
| 2004 | 0   | 0   | 0   | 0   | 0   | 0   | 0   | 0   | 0   | 0   | 0   | 0   | 0   |
| 2005 | 0   | 0   | 0   | 0   | 0   | 0   | 0   | 0   | 0   | 0   | 0   | 0   | 0   |
| 2006 | 0   | 0   | 0   | 0   | 0   | 0   | 0   | 0   | 0   | 0   | 0   | 0   | 0   |
| 2007 | 0   | 0   | 0   | 0   | 0   | 0   | 0   | 0   | 0   | 0   | 0   | 0   | 0   |
| 2008 | 0   | 0   | 0   | 0   | 0   | 0   | 0   | 0   | 0   | 0   | 0   | 0   | 0   |
| 2009 | 0   | 0   | 0   | 0   | 0   | 0   | 0   | 0   | 0   | 0   | 0   | 0   | 0   |
| 2010 | 0   | 0   | 0   | 0   | 0   | 0   | 0   | 0   | 0   | 0   | 0   | 0   | 0   |
| 2011 | 0   | 0   | 0   | 0   | 0   | 0   | 0   | 0   | 0   | 0   | 0   | 0   | 0   |
| 2012 | 0   | 0   | 0   | 0   | 0   | 0   | 0   | 0   | 0   | 0   | 0   | 0   | 0   |
| 2013 | 0   | 0   | 0   | 0   | 0   | 0   | 0   | 0   | 0   | 0   | 0   | 0   | 0   |
| 2014 | 0   | 0   | 0   | 0   | 0   | 0   | 0   | 0   | 0   | 0   | 0   | 0   | 0   |
| 2015 | 0   | 0   | 0   | 0   | 0   | 0   | 0   | 0   | 0   | 0   | 0   | 0   | 0   |
| 2016 | 0   | 0   | 0   | 0   | 0   | 0   | 0   | 0   | 0   | 0   | 0   | 0   | 0   |
| 2017 | 0   | 0   | 0   | 0   | 0   | 0   | 0   | 0   | 0   | 0   | 0   | 0   | 0   |
| 2018 | 0   | 0   | 0   | 0   | 0   | 0   | 0   | 0   | 0   | 0   | 0   | 0   | 0   |
| 2019 | 0   | 0   | 0   | 0   | 0   | 0   | 0   | 0   | 0   | 0   | 0   | 0   | 0   |
| 2020 | 0   | 0   | 0   | 0   | 0   | 0   | 0   | 0   | 0   | 0   | 0   | 0   | 0   |
| 2021 | 0   | 0   | 0   | 0   | 0   | 0   | 0   | 0   | 0   | 0   | 0   | 0   | 0   |
| 2022 | 0   | 0   | 0   | 0   | 0   | 0   | 0   | 0   | 0   | 0   | 0   | 0   | 0   |
| 2023 | 0   | 0   | 0   | 0   | 0   | 0   | 0   | 0   | 0   | 0   | 0   | 0   | 0   |
| 2024 | 0   | 0   | 0   | 0   | 0   | 0   | 0   | 0   | 0   | 0   | 0   | 0   | 0   |
| 2025 | 0   | 0   | 0   | 0   | 0   | 0   | 0   | 0   | 0   | 0   | 0   | 0   | 0   |
| 2026 | 28  | 28  | 19  | 28  | 0   | 0   | 0   | 0   | 0   | 0   | 0   | 0   | 0   |
| 2027 | 33  | 33  | 22  | 32  | 0   | 0   | 0   | 0   | 0   | 0   | 0   | 0   | 0   |
| 2028 | 23  | 23  | 18  | 25  | 0   | 0   | 0   | 2   | 0   | 0   | 0   | 0   | 0   |
| 2029 | 29  | 29  | 21  | 29  | 0   | 0   | 0   | 2   | 0   | 0   | 0   | 0   | 0   |
| 2030 | 28  | 28  | 31  | 28  | 0   | 0   | 0   | 9   | 0   | 0   | 0   | 0   | 0   |
| 2031 | 20  | 20  | 33  | 20  | 0   | 0   | 0   | 6   | 0   | 1   | 0   | 0   | 0   |
| 2032 | 12  | 12  | 14  | 12  | 0   | 0   | 0   | 11  | 0   | 9   | 0   | 0   | 0   |
| 2033 | 16  | 13  | 16  | 13  | 8   | 0   | 0   | 14  | 0   | 15  | 1   | 1   | 1   |
| 2034 | 13  | 12  | 15  | 12  | 1   | 1   | 0   | 11  | 0   | 20  | 1   | 1   | 1   |
| 2035 | 6   | 7   | 10  | 7   | 4   | 2   | 0   | 3   | 0   | 9   | 4   | 4   | 4   |
| 2036 | 11  | 12  | 12  | 12  | 17  | 5   | 0   | 3   | 1   | 4   | 16  | 16  | 16  |
| 2037 | 8   | 6   | 6   | 6   | 21  | 8   | 0   | 4   | 0   | 0   | 15  | 15  | 15  |
| 2038 | 9   | 11  | 13  | 11  | 8   | 2   | 0   | 5   | 9   | 3   | 5   | 5   | 5   |
| 2039 | 8   | 10  | 11  | 10  | 22  | 5   | 2   | 9   | 5   | 3   | 15  | 15  | 15  |
| 2040 | 5   | 7   | 8   | 7   | 13  | 0   | 9   | 8   | 15  | 7   | 10  | 10  | 10  |
| 2041 | 8   | 6   | 6   | 6   | 12  | 3   | 6   | 15  | 6   | 12  | 8   | 8   | 8   |
| 2042 | 11  | 11  | 11  | 11  | 13  | 4   | 20  | 64  | 26  | 16  | 5   | 5   | 5   |
| 2043 | 6   | 3   | 3   | 3   | 15  | 2   | 5   | 74  | 18  | 9   | 12  | 12  | 12  |
| 2044 | 5   | 2   | 2   | 2   | 97  | 26  | 21  | 47  | 58  | 62  | 39  | 39  | 39  |
| 2045 | 8   | 3   | 3   | 3   | 95  | 25  | 8   | 51  | 51  | 45  | 53  | 53  | 53  |
| 2046 | 11  | 8   | 8   | 8   | 58  | 8   | 52  | 52  | 33  | 29  | 41  | 41  | 41  |
| 2047 | 41  | 41  | 41  | 41  | 61  | 5   | 54  | 45  | 20  | 22  | 32  | 32  | 32  |
| 2048 | 39  | 43  | 43  | 43  | 48  | 5   | 40  | 28  | 23  | 14  | 16  | 16  | 16  |
| 2049 | 41  | 42  | 42  | 42  | 38  | 5   | 22  | 24  | 21  | 25  | 23  | 23  | 23  |
| 2050 | 29  | 33  | 33  | 33  | 55  | 26  | 14  | 3   | 36  | 42  | 41  | 41  | 41  |
| 2051 | 15  | 22  | 22  | 22  | 66  | 16  | 12  | 0   | 55  | 46  | 54  | 54  | 54  |
| 2052 | 9   | 11  | 11  | 11  | 84  | 28  | 19  | 0   | 52  | 48  | 47  | 47  | 47  |
| 2053 | 10  | 10  | 10  | 10  | 60  | 18  | 10  | 0   | 35  | 28  | 30  | 30  | 30  |
| 2054 | 6   | 6   | 6   | 6   | 37  | 0   | 17  | 0   | 19  | 19  | 19  | 19  | 19  |
| 2055 | 3   | 3   | 3   | 3   | 25  | 0   | 49  | 0   | 8   | 3   | 3   | 3   | 3   |
| 2056 | 3   | 3   | 3   | 3   | 6   | 0   | 51  | 0   | 0   | 0   | 0   | 0   | 0   |
| 2057 | 0   | 0   | 0   | 0   | 0   | 0   | 37  | 0   | 0   | 0   | 0   | 0   | 0   |
| 2058 | 0   | 0   | 0   | 0   | 0   | 0   | 25  | 0   | 0   | 0   | 0   | 0   | 0   |
| 2059 | 0   | 0   | 0   | 0   | 0   | 0   | 17  | 0   | 0   | 0   | 0   | 0   | 0   |

| 12%  | 105 | 106 | 107 | 108 | 109 | 110 | 111 | 112 | 113 | 114 | 115 | 116 | 117 |
|------|-----|-----|-----|-----|-----|-----|-----|-----|-----|-----|-----|-----|-----|
| 2060 | 0   | 0   | 0   | 0   | 0   | 0   | 2   | 0   | 0   | 0   | 0   | 0   | 0   |
| 2061 | 0   | 0   | 0   | 0   | 0   | 0   | 0   | 0   | 0   | 0   | 0   | 0   | 0   |
| 2062 | 0   | 0   | 0   | 0   | 0   | 0   | 0   | 0   | 0   | 0   | 0   | 0   | 0   |
| 2063 | 0   | 0   | 0   | 0   | 0   | 0   | 0   | 0   | 0   | 0   | 0   | 0   | 0   |
| 2064 | 0   | 0   | 0   | 0   | 0   | 0   | 0   | 0   | 0   | 0   | 0   | 0   | 0   |
| 2065 | 0   | 0   | 0   | 0   | 0   | 0   | 0   | 0   | 0   | 0   | 0   | 0   | 0   |
| 2066 | 0   | 0   | 0   | 0   | 0   | 0   | 0   | 0   | 0   | 0   | 0   | 0   | 0   |
| 2067 | 0   | 0   | 0   | 0   | 0   | 0   | 0   | 0   | 0   | 0   | 0   | 0   | 0   |
| 2068 | 0   | 0   | 0   | 0   | 0   | 0   | 0   | 0   | 0   | 0   | 0   | 0   | 0   |
| 2069 | 0   | 0   | 0   | 0   | 0   | 0   | 0   | 0   | 0   | 0   | 0   | 0   | 0   |
| 2070 | 0   | 0   | 0   | 0   | 0   | 0   | 0   | 0   | 0   | 0   | 0   | 0   | 0   |
| 2071 | 0   | 0   | 0   | 0   | 0   | 0   | 0   | 0   | 0   | 0   | 0   | 0   | 0   |
| 2072 | 0   | 0   | 0   | 0   | 0   | 0   | 0   | 0   | 0   | 0   | 0   | 0   | 0   |
| 2073 | 0   | 0   | 0   | 0   | 0   | 0   | 0   | 0   | 0   | 0   | 0   | 0   | 0   |
| 2074 | 0   | 0   | 0   | 0   | 0   | 0   | 0   | 0   | 0   | 0   | 0   | 0   | 0   |
| 2075 | 0   | 0   | 0   | 0   | 0   | 0   | 0   | 0   | 0   | 0   | 0   | 0   | 0   |
| 2076 | 0   | 0   | 0   | 0   | 0   | 0   | 0   | 0   | 0   | 0   | 0   | 0   | 0   |
| 2077 | 0   | 0   | 0   | 0   | 0   | 0   | 0   | 0   | 0   | 0   | 0   | 0   | 0   |
| 2078 | 0   | 0   | 0   | 0   | 0   | 0   | 0   | 0   | 0   | 0   | 0   | 0   | 0   |
| 2079 | 0   | 0   | 0   | 0   | 0   | 0   | 0   | 0   | 0   | 0   | 0   | 0   | 0   |
| 2080 | 0   | 0   | 0   | 0   | 0   | 0   | 0   | 0   | 0   | 0   | 0   | 0   | 0   |
| 2081 | 0   | 0   | 0   | 0   | 0   | 0   | 0   | 0   | 0   | 0   | 0   | 0   | 0   |
| 2082 | 0   | 0   | 0   | 0   | 0   | 0   | 0   | 0   | 0   | 0   | 0   | 0   | 0   |
| 2083 | 0   | 0   | 0   | 0   | 0   | 0   | 0   | 0   | 0   | 0   | 0   | 0   | 0   |
| 2084 | 0   | 0   | 0   | 0   | 0   | 0   | 0   | 0   | 0   | 0   | 0   | 0   | 0   |
| 2085 | 0   | 0   | 0   | 0   | 0   | 0   | 0   | 0   | 0   | 0   | 0   | 0   | 0   |
| 2086 | 0   | 0   | 0   | 0   | 0   | 0   | 0   | 0   | 0   | 0   | 0   | 0   | 0   |
| 2087 | 0   | 0   | 0   | 0   | 0   | 0   | 0   | 0   | 0   | 0   | 0   | 0   | 0   |
| 2088 | 0   | 0   | 0   | 0   | 0   | 0   | 0   | 0   | 0   | 0   | 0   | 0   | 0   |
| 2089 | 0   | 0   | 0   | 0   | 0   | 0   | 0   | 0   | 0   | 0   | 0   | 0   | 0   |
| 2090 | 0   | 0   | 0   | 0   | 0   | 0   | 0   | 0   | 0   | 0   | 0   | 0   | 0   |

| 12%  | 118 | 119 | 120 | 121 | 122 | 123 | 124 | 125 | 126 | 127 | 128 | 129 | 130 |
|------|-----|-----|-----|-----|-----|-----|-----|-----|-----|-----|-----|-----|-----|
| 2002 |     |     |     |     |     |     |     |     |     |     |     |     |     |
| 2003 | 0   | 0   | 0   | 0   | 0   | 0   | 0   | 0   | 0   | 0   | 0   | 0   | 0   |
| 2004 | 0   | 0   | 0   | 0   | 0   | 0   | 0   | 0   | 0   | 0   | 0   | 0   | 0   |
| 2005 | 0   | 0   | 0   | 0   | 0   | 0   | 0   | 0   | 0   | 0   | 0   | 0   | 0   |
| 2006 | 0   | 0   | 0   | 0   | 0   | 0   | 0   | 0   | 0   | 0   | 0   | 0   | 0   |
| 2007 | 0   | 0   | 0   | 0   | 0   | 0   | 0   | 0   | 0   | 0   | 0   | 0   | 0   |
| 2008 | 0   | 0   | 0   | 0   | 0   | 0   | 0   | 0   | 0   | 0   | 0   | 0   | 0   |
| 2009 | 0   | 0   | 0   | 0   | 0   | 0   | 0   | 0   | 0   | 0   | 0   | 0   | 0   |
| 2010 | 0   | 0   | 0   | 0   | 0   | 0   | 0   | 0   | 0   | 0   | 0   | 0   | 0   |
| 2011 | 0   | 0   | 0   | 0   | 0   | 0   | 0   | 0   | 0   | 0   | 0   | 0   | 0   |
| 2012 | 0   | 0   | 0   | 0   | 0   | 0   | 0   | 0   | 0   | 0   | 0   | 0   | 0   |
| 2013 | 0   | 0   | 0   | 0   | 0   | 0   | 0   | 0   | 0   | 0   | 0   | 0   | 0   |
| 2014 | 0   | 0   | 0   | 0   | 0   | 0   | 0   | 0   | 0   | 0   | 0   | 0   | 0   |
| 2015 | 0   | 0   | 0   | 0   | 0   | 0   | 0   | 0   | 0   | 0   | 0   | 0   | 0   |
| 2016 | 0   | 0   | 0   | 0   | 0   | 0   | 0   | 0   | 0   | 0   | 0   | 0   | 0   |
| 2017 | 0   | 0   | 0   | 0   | 0   | 0   | 0   | 0   | 0   | 0   | 0   | 0   | 0   |
| 2018 | 0   | 0   | 0   | 0   | 0   | 0   | 0   | 0   | 0   | 0   | 0   | 0   | 0   |
| 2019 | 0   | 0   | 0   | 0   | 0   | 0   | 0   | 0   | 0   | 0   | 0   | 0   | 0   |
| 2020 | 0   | 0   | 0   | 0   | 0   | 0   | 0   | 0   | 0   | 0   | 0   | 0   | 0   |
| 2021 | 0   | 0   | 0   | 3   | 0   | 0   | 0   | 0   | 0   | 0   | 0   | 0   | 2   |
| 2022 | 0   | 0   | 0   | 0   | 0   | 0   | 0   | 0   | 0   | 0   | 0   | 0   | 2   |
| 2023 | 0   | 0   | 0   | 7   | 0   | 0   | 0   | 0   | 0   | 0   | 0   | 0   | 5   |
| 2024 | 0   | 0   | 0   | 11  | 0   | 0   | 0   | 0   | 0   | 0   | 0   | 0   | 6   |
| 2025 | 0   | 0   | 0   | 11  | 0   | 0   | 0   | 0   | 0   | 0   | 0   | 0   | 7   |
| 2026 | 5   | 3   | 0   | 18  | 3   | 14  | 5   | 1   | 5   | 5   | 4   | 0   | 9   |
| 2027 | 7   | 2   | 0   | 5   | 8   | 15  | 4   | 3   | 4   | 5   | 3   | 0   | 13  |
| 2028 | 6   | 6   | 0   | 9   | 5   | 14  | 6   | 6   | 6   | 5   | 4   | 0   | 8   |
| 2029 | 15  | 13  | 0   | 12  | 11  | 13  | 15  | 16  | 15  | 5   | 4   | 0   | 2   |
| 2030 | 15  | 6   | 0   | 23  | 9   | 9   | 13  | 13  | 13  | 11  | 5   | 0   | 6   |
| 2031 | 13  | 3   | 2   | 23  | 3   | 11  | 13  | 13  | 13  | 11  | 5   | 3   | 13  |
| 2032 | 27  | 12  | 9   | 18  | 16  | 6   | 15  | 15  | 15  | 13  | 2   | 5   | 11  |
| 2033 | 22  | 12  | 11  | 14  | 15  | 9   | 16  | 18  | 16  | 16  | 3   | 9   | 29  |
| 2034 | 18  | 8   | 12  | 24  | 9   | 12  | 12  | 12  | 12  | 6   | 5   | 6   | 17  |
| 2035 | 21  | 13  | 16  | 9   | 8   | 13  | 18  | 19  | 18  | 15  | 8   | 5   | 23  |
| 2036 | 42  | 13  | 19  | 15  | 23  | 29  | 35  | 35  | 35  | 22  | 13  | 9   | 13  |
| 2037 | 29  | 4   | 20  | 1   | 21  | 20  | 16  | 16  | 16  | 25  | 5   | 9   | 8   |
| 2038 | 12  | 0   | 21  | 12  | 10  | 10  | 3   | 3   | 3   | 29  | 9   | 11  | 14  |
| 2039 | 9   | 0   | 18  | 9   | 12  | 18  | 6   | 6   | 6   | 32  | 11  | 18  | 15  |
| 2040 | 11  | 0   | 13  | 6   | 5   | 12  | 8   | 8   | 8   | 16  | 9   | 16  | 13  |
| 2041 | 18  | 2   | 19  | 0   | 16  | 2   | 7   | 7   | 7   | 15  | 7   | 20  | 5   |
| 2042 | 20  | 1   | 9   | 0   | 14  | 8   | 8   | 8   | 8   | 13  | 2   | 11  | 5   |
| 2043 | 22  | 3   | 7   | 5   | 12  | 7   | 10  | 10  | 10  | 21  | 0   | 12  | 3   |
| 2044 | 17  | 0   | 4   | 8   | 10  | 2   | 4   | 4   | 4   | 16  | 1   | 11  | 1   |
| 2045 | 16  | 2   | 0   | 10  | 5   | 4   | 6   | 6   | 6   | 17  | 0   | 3   | 4   |
| 2046 | 11  | 2   | 2   | 8   | 3   | 8   | 5   | 5   | 5   | 16  | 3   | 0   | 45  |
| 2047 | 5   | 1   | 7   | 10  | 5   | 9   | 5   | 5   | 5   | 60  | 13  | 1   | 92  |
| 2048 | 6   | 2   | 38  | 2   | 24  | 3   | 2   | 2   | 2   | 68  | 10  | 44  | 64  |
| 2049 | 21  | 9   | 19  | 0   | 16  | 21  | 19  | 19  | 19  | 33  | 13  | 28  | 39  |
| 2050 | 59  | 15  | 6   | 95  | 21  | 65  | 29  | 29  | 29  | 45  | 9   | 19  | 14  |
| 2051 | 36  | 7   | 11  | 71  | 28  | 62  | 24  | 24  | 24  | 96  | 24  | 20  | 4   |
| 2052 | 62  | 19  | 21  | 38  | 54  | 44  | 45  | 45  | 45  | 95  | 18  | 14  | 0   |
| 2053 | 106 | 25  | 22  | 12  | 64  | 29  | 63  | 63  | 63  | 70  | 4   | 26  | 2   |
| 2054 | 91  | 10  | 33  | 4   | 38  | 24  | 46  | 46  | 46  | 40  | 4   | 32  | 0   |
| 2055 | 54  | 1   | 45  | 2   | 20  | 2   | 29  | 29  | 29  | 28  | 0   | 41  | 0   |
| 2056 | 37  | 4   | 41  | 0   | 8   | 0   | 9   | 9   | 9   | 18  | 0   | 37  | 0   |
| 2057 | 22  | 0   | 36  | 0   | 0   | 0   | 0   | 0   | 0   | 2   | 0   | 27  | 0   |
| 2058 | 13  | 0   | 28  | 0   | 0   | 0   | 0   | 0   | 0   | 0   | 0   | 28  | 0   |
| 2059 | 1   | 0   | 6   | 0   | 0   | 0   | 0   | 0   | 0   | 0   | 0   | 18  | 0   |

| 12%  | 118 | 119 | 120 | 121 | 122 | 123 | 124 | 125 | 126 | 127 | 128 | 129 | 130 |
|------|-----|-----|-----|-----|-----|-----|-----|-----|-----|-----|-----|-----|-----|
| 2060 | 0   | 0   | 0   | 0   | 0   | 0   | 0   | 0   | 0   | 0   | 0   | 11  | 0   |
| 2061 | 0   | 0   | 0   | 0   | 0   | 0   | 0   | 0   | 0   | 0   | 0   | 0   | 0   |
| 2062 | 0   | 0   | 0   | 0   | 0   | 0   | 0   | 0   | 0   | 0   | 0   | 0   | 0   |
| 2063 | 0   | 0   | 0   | 0   | 0   | 0   | 0   | 0   | 0   | 0   | 0   | 0   | 0   |
| 2064 | 0   | 0   | 0   | 0   | 0   | 0   | 0   | 0   | 0   | 0   | 0   | 0   | 0   |
| 2065 | 0   | 0   | 0   | 0   | 0   | 0   | 0   | 0   | 0   | 0   | 0   | 0   | 0   |
| 2066 | 0   | 0   | 0   | 0   | 0   | 0   | 0   | 0   | 0   | 0   | 0   | 0   | 0   |
| 2067 | 0   | 0   | 0   | 0   | 0   | 0   | 0   | 0   | 0   | 0   | 0   | 0   | 0   |
| 2068 | 0   | 0   | 0   | 0   | 0   | 0   | 0   | 0   | 0   | 0   | 0   | 0   | 0   |
| 2069 | 0   | 0   | 0   | 0   | 0   | 0   | 0   | 0   | 0   | 0   | 0   | 0   | 0   |
| 2070 | 0   | 0   | 0   | 0   | 0   | 0   | 0   | 0   | 0   | 0   | 0   | 0   | 0   |
| 2071 | 0   | 0   | 0   | 0   | 0   | 0   | 0   | 0   | 0   | 0   | 0   | 0   | 0   |
| 2072 | 0   | 0   | 0   | 0   | 0   | 0   | 0   | 0   | 0   | 0   | 0   | 0   | 0   |
| 2073 | 0   | 0   | 0   | 0   | 0   | 0   | 0   | 0   | 0   | 0   | 0   | 0   | 0   |
| 2074 | 0   | 0   | 0   | 0   | 0   | 0   | 0   | 0   | 0   | 0   | 0   | 0   | 0   |
| 2075 | 0   | 0   | 0   | 0   | 0   | 0   | 0   | 0   | 0   | 0   | 0   | 0   | 0   |
| 2076 | 0   | 0   | 0   | 0   | 0   | 0   | 0   | 0   | 0   | 0   | 0   | 0   | 0   |
| 2077 | 0   | 0   | 0   | 0   | 0   | 0   | 0   | 0   | 0   | 0   | 0   | 0   | 0   |
| 2078 | 0   | 0   | 0   | 0   | 0   | 0   | 0   | 0   | 0   | 0   | 0   | 0   | 0   |
| 2079 | 0   | 0   | 0   | 0   | 0   | 0   | 0   | 0   | 0   | 0   | 0   | 0   | 0   |
| 2080 | 0   | 0   | 0   | 0   | 0   | 0   | 0   | 0   | 0   | 0   | 0   | 0   | 0   |
| 2081 | 0   | 0   | 0   | 0   | 0   | 0   | 0   | 0   | 0   | 0   | 0   | 0   | 0   |
| 2082 | 0   | 0   | 0   | 0   | 0   | 0   | 0   | 0   | 0   | 0   | 0   | 0   | 0   |
| 2083 | 0   | 0   | 0   | 0   | 0   | 0   | 0   | 0   | 0   | 0   | 0   | 0   | 0   |
| 2084 | 0   | 0   | 0   | 0   | 0   | 0   | 0   | 0   | 0   | 0   | 0   | 0   | 0   |
| 2085 | 0   | 0   | 0   | 0   | 0   | 0   | 0   | 0   | 0   | 0   | 0   | 0   | 0   |
| 2086 | 0   | 0   | 0   | 0   | 0   | 0   | 0   | 0   | 0   | 0   | 0   | 0   | 0   |
| 2087 | 0   | 0   | 0   | 0   | 0   | 0   | 0   | 0   | 0   | 0   | 0   | 0   | 0   |
| 2088 | 0   | 0   | 0   | 0   | 0   | 0   | 0   | 0   | 0   | 0   | 0   | 0   | 0   |
| 2089 | 0   | 0   | 0   | 0   | 0   | 0   | 0   | 0   | 0   | 0   | 0   | 0   | 0   |
| 2090 | 0   | 0   | 0   | 0   | 0   | 0   | 0   | 0   | 0   | 0   | 0   | 0   | 0   |

| 12%  | 131 | 132 | 133 | 134 | 135 | 136 | 137 | 138 | 139 | 140 | 141 | 142 | 143 |
|------|-----|-----|-----|-----|-----|-----|-----|-----|-----|-----|-----|-----|-----|
| 2002 |     |     |     |     |     |     |     |     |     |     |     |     |     |
| 2003 | 0   | 0   | 0   | 0   | 0   | 0   | 0   | 0   | 0   | 0   | 0   | 0   | 0   |
| 2004 | 0   | 0   | 0   | 0   | 0   | 0   | 0   | 0   | 0   | 0   | 0   | 0   | 0   |
| 2005 | 0   | 0   | 0   | 0   | 0   | 0   | 0   | 0   | 0   | 0   | 0   | 0   | 0   |
| 2006 | 0   | 0   | 0   | 0   | 0   | 0   | 0   | 0   | 0   | 0   | 0   | 0   | 0   |
| 2007 | 0   | 0   | 0   | 0   | 0   | 0   | 0   | 0   | 0   | 0   | 0   | 0   | 0   |
| 2008 | 0   | 0   | 0   | 0   | 0   | 0   | 0   | 0   | 0   | 0   | 0   | 0   | 0   |
| 2009 | 0   | 0   | 0   | 0   | 0   | 0   | 0   | 0   | 0   | 0   | 0   | 0   | 0   |
| 2010 | 0   | 0   | 0   | 0   | 0   | 0   | 0   | 0   | 0   | 0   | 0   | 0   | 0   |
| 2011 | 0   | 0   | 0   | 0   | 0   | 0   | 0   | 0   | 0   | 0   | 0   | 0   | 0   |
| 2012 | 0   | 0   | 0   | 0   | 0   | 0   | 0   | 0   | 0   | 0   | 0   | 0   | 0   |
| 2013 | 0   | 0   | 0   | 0   | 0   | 0   | 0   | 0   | 0   | 0   | 0   | 0   | 0   |
| 2014 | 0   | 0   | 0   | 0   | 0   | 0   | 0   | 0   | 0   | 0   | 0   | 0   | 0   |
| 2015 | 0   | 0   | 0   | 0   | 0   | 0   | 0   | 0   | 0   | 0   | 0   | 0   | 0   |
| 2016 | 0   | 0   | 0   | 0   | 0   | 0   | 0   | 0   | 0   | 0   | 0   | 0   | 0   |
| 2017 | 0   | 0   | 0   | 0   | 0   | 0   | 0   | 0   | 0   | 0   | 0   | 0   | 0   |
| 2018 | 0   | 0   | 0   | 0   | 0   | 0   | 0   | 0   | 0   | 0   | 0   | 0   | 0   |
| 2019 | 0   | 0   | 0   | 0   | 0   | 0   | 0   | 0   | 0   | 0   | 0   | 0   | 0   |
| 2020 | 0   | 0   | 0   | 0   | 0   | 0   | 0   | 0   | 0   | 0   | 0   | 0   | 0   |
| 2021 | 0   | 0   | 0   | 0   | 0   | 0   | 0   | 0   | 40  | 0   | 0   | 0   | 0   |
| 2022 | 0   | 0   | 0   | 0   | 0   | 0   | 0   | 0   | 42  | 0   | 0   | 0   | 0   |
| 2023 | 0   | 0   | 0   | 0   | 0   | 0   | 0   | 0   | 20  | 0   | 0   | 0   | 0   |
| 2024 | 0   | 0   | 0   | 0   | 0   | 0   | 0   | 0   | 23  | 0   | 0   | 0   | 0   |
| 2025 | 0   | 0   | 0   | 0   | 0   | 0   | 0   | 0   | 18  | 0   | 0   | 0   | 0   |
| 2026 | 3   | 9   | 5   | 2   | 5   | 39  | 14  | 0   | 23  | 24  | 24  | 24  | 24  |
| 2027 | 3   | 8   | 6   | 3   | 5   | 55  | 11  | 0   | 16  | 37  | 37  | 37  | 37  |
| 2028 | 3   | 15  | 4   | 4   | 5   | 48  | 9   | 0   | 19  | 25  | 25  | 25  | 25  |
| 2029 | 4   | 14  | 5   | 6   | 5   | 49  | 16  | 0   | 7   | 29  | 29  | 29  | 29  |
| 2030 | 6   | 11  | 11  | 11  | 11  | 36  | 2   | 0   | 2   | 18  | 18  | 18  | 18  |
| 2031 | 5   | 10  | 6   | 5   | 6   | 24  | 6   | 20  | 5   | 15  | 15  | 15  | 15  |
| 2032 | 14  | 12  | 9   | 8   | 9   | 41  | 12  | 38  | 2   | 23  | 23  | 23  | 23  |
| 2033 | 7   | 13  | 6   | 6   | 6   | 38  | 3   | 28  | 3   | 22  | 22  | 22  | 22  |
| 2034 | 9   | 8   | 6   | 8   | 6   | 21  | 0   | 26  | 18  | 11  | 11  | 11  | 11  |
| 2035 | 8   | 15  | 11  | 12  | 11  | 15  | 0   | 35  | 6   | 4   | 4   | 4   | 4   |
| 2036 | 12  | 25  | 21  | 22  | 21  | 9   | 0   | 26  | 15  | 0   | 1   | 0   | 0   |
| 2037 | 16  | 17  | 19  | 19  | 19  | 19  | 0   | 13  | 3   | 1   | 0   | 1   | 1   |
| 2038 | 12  | 10  | 19  | 22  | 19  | 7   | 0   | 12  | 0   | 1   | 1   | 1   | 1   |
| 2039 | 17  | 15  | 18  | 19  | 18  | 6   | 2   | 10  | 25  | 6   | 9   | 7   | 7   |
| 2040 | 7   | 11  | 13  | 14  | 13  | 11  | 2   | 0   | 2   | 8   | 11  | 9   | 9   |
| 2041 | 14  | 9   | 13  | 13  | 13  | 15  | 2   | 0   | 0   | 12  | 6   | 11  | 11  |
| 2042 | 9   | 3   | 9   | 9   | 9   | 11  | 0   | 0   | 16  | 3   | 3   | 3   | 3   |
| 2043 | 9   | 10  | 9   | 9   | 9   | 23  | 0   | 1   | 4   | 0   | 3   | 3   | 3   |
| 2044 | 13  | 5   | 8   | 8   | 8   | 16  | 5   | 7   | 79  | 21  | 18  | 18  | 18  |
| 2045 | 9   | 6   | 8   | 8   | 8   | 12  | 5   | 0   | 57  | 10  | 10  | 16  | 16  |
| 2046 | 5   | 7   | 8   | 8   | 8   | 107 | 52  | 9   | 39  | 66  | 13  | 66  | 66  |
| 2047 | 49  | 9   | 32  | 32  | 32  | 60  | 9   | 0   | 5   | 37  | 76  | 37  | 37  |
| 2048 | 35  | 22  | 23  | 23  | 23  | 62  | 15  | 9   | 0   | 41  | 33  | 41  | 41  |
| 2049 | 13  | 59  | 28  | 28  | 28  | 61  | 23  | 24  | 0   | 33  | 44  | 33  | 33  |
| 2050 | 6   | 62  | 30  | 30  | 30  | 41  | 5   | 55  | 0   | 24  | 33  | 24  | 24  |
| 2051 | 29  | 48  | 58  | 58  | 58  | 26  | 0   | 21  | 0   | 17  | 18  | 12  | 12  |
| 2052 | 68  | 36  | 56  | 56  | 56  | 15  | 0   | 18  | 0   | 3   | 3   | 2   | 2   |
| 2053 | 49  | 17  | 33  | 33  | 33  | 0   | 0   | 31  | 0   | 0   | 0   | 0   | 0   |
| 2054 | 34  | 6   | 16  | 16  | 16  | 0   | 0   | 42  | 0   | 0   | 0   | 0   | 0   |
| 2055 | 21  | 2   | 3   | 3   | 3   | 0   | 0   | 30  | 0   | 0   | 0   | 0   | 0   |
| 2056 | 2   | 0   | 0   | 0   | 0   | 0   | 0   | 24  | 0   | 0   | 0   | 0   | 0   |
| 2057 | 0   | 0   | 0   | 0   | 0   | 0   | 0   | 11  | 0   | 0   | 0   | 0   | 0   |
| 2058 | 0   | 0   | 0   | 0   | 0   | 0   | 0   | 0   | 0   | 0   | 0   | 0   | 0   |
| 2059 | 0   | 0   | 0   | 0   | 0   | 0   | 0   | 0   | 0   | 0   | 0   | 0   | 0   |

| 12%  | 131 | 132 | 133 | 134 | 135 | 136 | 137 | 138 | 139 | 140 | 141 | 142 | 143 |
|------|-----|-----|-----|-----|-----|-----|-----|-----|-----|-----|-----|-----|-----|
| 2060 | 0   | 0   | 0   | 0   | 0   | 0   | 0   | 0   | 0   | 0   | 0   | 0   | 0   |
| 2061 | 0   | 0   | 0   | 0   | 0   | 0   | 0   | 0   | 0   | 0   | 0   | 0   | 0   |
| 2062 | 0   | 0   | 0   | 0   | 0   | 0   | 0   | 0   | 0   | 0   | 0   | 0   | 0   |
| 2063 | 0   | 0   | 0   | 0   | 0   | 0   | 0   | 0   | 0   | 0   | 0   | 0   | 0   |
| 2064 | 0   | 0   | 0   | 0   | 0   | 0   | 0   | 0   | 0   | 0   | 0   | 0   | 0   |
| 2065 | 0   | 0   | 0   | 0   | 0   | 0   | 0   | 0   | 0   | 0   | 0   | 0   | 0   |
| 2066 | 0   | 0   | 0   | 0   | 0   | 0   | 0   | 0   | 0   | 0   | 0   | 0   | 0   |
| 2067 | 0   | 0   | 0   | 0   | 0   | 0   | 0   | 0   | 0   | 0   | 0   | 0   | 0   |
| 2068 | 0   | 0   | 0   | 0   | 0   | 0   | 0   | 0   | 0   | 0   | 0   | 0   | 0   |
| 2069 | 0   | 0   | 0   | 0   | 0   | 0   | 0   | 0   | 0   | 0   | 0   | 0   | 0   |
| 2070 | 0   | 0   | 0   | 0   | 0   | 0   | 0   | 0   | 0   | 0   | 0   | 0   | 0   |
| 2071 | 0   | 0   | 0   | 0   | 0   | 0   | 0   | 0   | 0   | 0   | 0   | 0   | 0   |
| 2072 | 0   | 0   | 0   | 0   | 0   | 0   | 0   | 0   | 0   | 0   | 0   | 0   | 0   |
| 2073 | 0   | 0   | 0   | 0   | 0   | 0   | 0   | 0   | 0   | 0   | 0   | 0   | 0   |
| 2074 | 0   | 0   | 0   | 0   | 0   | 0   | 0   | 0   | 0   | 0   | 0   | 0   | 0   |
| 2075 | 0   | 0   | 0   | 0   | 0   | 0   | 0   | 0   | 0   | 0   | 0   | 0   | 0   |
| 2076 | 0   | 0   | 0   | 0   | 0   | 0   | 0   | 0   | 0   | 0   | 0   | 0   | 0   |
| 2077 | 0   | 0   | 0   | 0   | 0   | 0   | 0   | 0   | 0   | 0   | 0   | 0   | 0   |
| 2078 | 0   | 0   | 0   | 0   | 0   | 0   | 0   | 0   | 0   | 0   | 0   | 0   | 0   |
| 2079 | 0   | 0   | 0   | 0   | 0   | 0   | 0   | 0   | 0   | 0   | 0   | 0   | 0   |
| 2080 | 0   | 0   | 0   | 0   | 0   | 0   | 0   | 0   | 0   | 0   | 0   | 0   | 0   |
| 2081 | 0   | 0   | 0   | 0   | 0   | 0   | 0   | 0   | 0   | 0   | 0   | 0   | 0   |
| 2082 | 0   | 0   | 0   | 0   | 0   | 0   | 0   | 0   | 0   | 0   | 0   | 0   | 0   |
| 2083 | 0   | 0   | 0   | 0   | 0   | 0   | 0   | 0   | 0   | 0   | 0   | 0   | 0   |
| 2084 | 0   | 0   | 0   | 0   | 0   | 0   | 0   | 0   | 0   | 0   | 0   | 0   | 0   |
| 2085 | 0   | 0   | 0   | 0   | 0   | 0   | 0   | 0   | 0   | 0   | 0   | 0   | 0   |
| 2086 | 0   | 0   | 0   | 0   | 0   | 0   | 0   | 0   | 0   | 0   | 0   | 0   | 0   |
| 2087 | 0   | 0   | 0   | 0   | 0   | 0   | 0   | 0   | 0   | 0   | 0   | 0   | 0   |
| 2088 | 0   | 0   | 0   | 0   | 0   | 0   | 0   | 0   | 0   | 0   | 0   | 0   | 0   |
| 2089 | 0   | 0   | 0   | 0   | 0   | 0   | 0   | 0   | 0   | 0   | 0   | 0   | 0   |
| 2090 | 0   | 0   | 0   | 0   | 0   | 0   | 0   | 0   | 0   | 0   | 0   | 0   | 0   |



| 12%  | 144 | 145 | 146 | 147 | 148 | 149 | 150 | 151 | 152 | 153 | 154 | 155 | 156 |
|------|-----|-----|-----|-----|-----|-----|-----|-----|-----|-----|-----|-----|-----|
| 2002 |     |     |     |     |     |     |     |     |     |     |     |     |     |
| 2003 | 0   | 0   | 0   | 0   | 0   | 0   | 0   | 0   | 0   | 0   | 0   | 0   | 0   |
| 2004 | 0   | 0   | 0   | 0   | 0   | 0   | 0   | 0   | 0   | 0   | 0   | 0   | 0   |
| 2005 | 0   | 0   | 0   | 0   | 0   | 0   | 0   | 0   | 0   | 0   | 0   | 0   | 0   |
| 2006 | 0   | 0   | 0   | 0   | 0   | 0   | 0   | 0   | 0   | 0   | 0   | 0   | 0   |
| 2007 | 0   | 0   | 0   | 0   | 0   | 0   | 0   | 0   | 0   | 0   | 0   | 0   | 0   |
| 2008 | 0   | 0   | 0   | 0   | 0   | 0   | 0   | 0   | 0   | 0   | 0   | 0   | 0   |
| 2009 | 0   | 0   | 0   | 0   | 0   | 0   | 0   | 0   | 0   | 0   | 0   | 0   | 0   |
| 2010 | 0   | 0   | 0   | 0   | 0   | 0   | 0   | 0   | 0   | 0   | 0   | 0   | 0   |
| 2011 | 0   | 0   | 0   | 0   | 0   | 0   | 0   | 0   | 0   | 0   | 0   | 0   | 0   |
| 2012 | 0   | 0   | 0   | 0   | 0   | 0   | 0   | 0   | 0   | 0   | 0   | 0   | 0   |
| 2013 | 0   | 0   | 0   | 0   | 0   | 0   | 0   | 0   | 0   | 0   | 0   | 0   | 0   |
| 2014 | 0   | 0   | 0   | 0   | 0   | 0   | 0   | 0   | 0   | 0   | 0   | 0   | 0   |
| 2015 | 0   | 0   | 0   | 0   | 0   | 0   | 0   | 0   | 0   | 0   | 0   | 0   | 0   |
| 2016 | 0   | 0   | 0   | 0   | 0   | 0   | 0   | 0   | 0   | 0   | 0   | 0   | 0   |
| 2017 | 0   | 0   | 0   | 0   | 0   | 0   | 0   | 0   | 0   | 0   | 0   | 0   | 0   |
| 2018 | 0   | 0   | 0   | 0   | 0   | 0   | 0   | 0   | 0   | 0   | 0   | 0   | 0   |
| 2019 | 0   | 0   | 0   | 0   | 0   | 0   | 0   | 0   | 0   | 0   | 0   | 0   | 0   |
| 2020 | 0   | 0   | 0   | 0   | 0   | 0   | 0   | 0   | 0   | 0   | 0   | 0   | 0   |
| 2021 | 0   | 0   | 0   | 0   | 77  | 0   | 0   | 0   | 0   | 0   | 0   | 0   | 0   |
| 2022 | 0   | 0   | 0   | 0   | 46  | 0   | 0   | 0   | 0   | 0   | 0   | 0   | 0   |
| 2023 | 0   | 0   | 0   | 0   | 33  | 0   | 0   | 0   | 0   | 0   | 0   | 0   | 0   |
| 2024 | 0   | 0   | 0   | 0   | 22  | 0   | 0   | 0   | 0   | 0   | 0   | 0   | 0   |
| 2025 | 0   | 0   | 0   | 0   | 10  | 0   | 0   | 0   | 0   | 0   | 0   | 0   | 0   |
| 2026 | 24  | 92  | 32  | 0   | 8   | 65  | 65  | 65  | 48  | 65  | 86  | 32  | 0   |
| 2027 | 37  | 74  | 33  | 0   | 13  | 56  | 56  | 56  | 55  | 56  | 69  | 33  | 0   |
| 2028 | 25  | 57  | 11  | 0   | 12  | 31  | 31  | 31  | 31  | 31  | 64  | 11  | 0   |
| 2029 | 29  | 39  | 8   | 0   | 12  | 13  | 13  | 13  | 16  | 13  | 39  | 8   | 0   |
| 2030 | 18  | 35  | 9   | 0   | 10  | 21  | 21  | 21  | 29  | 21  | 35  | 9   | 0   |
| 2031 | 15  | 19  | 6   | 54  | 6   | 13  | 13  | 13  | 15  | 13  | 20  | 6   | 54  |
| 2032 | 23  | 18  | 0   | 69  | 8   | 9   | 12  | 12  | 12  | 12  | 18  | 0   | 69  |
| 2033 | 22  | 25  | 0   | 38  | 8   | 13  | 17  | 11  | 12  | 11  | 26  | 0   | 38  |
| 2034 | 11  | 13  | 6   | 20  | 12  | 12  | 8   | 12  | 12  | 12  | 14  | 6   | 20  |
| 2035 | 4   | 10  | 0   | 12  | 5   | 0   | 0   | 0   | 3   | 0   | 10  | 0   | 12  |
| 2036 | 0   | 15  | 0   | 11  | 1   | 4   | 3   | 4   | 4   | 4   | 15  | 0   | 11  |
| 2037 | 1   | 11  | 3   | 12  | 0   | 6   | 6   | 6   | 6   | 6   | 9   | 3   | 12  |
| 2038 | 1   | 8   | 0   | 18  | 0   | 6   | 6   | 6   | 6   | 6   | 10  | 0   | 18  |
| 2039 | 7   | 6   | 0   | 13  | 2   | 2   | 8   | 2   | 2   | 2   | 6   | 0   | 13  |
| 2040 | 9   | 12  | 3   | 8   | 0   | 6   | 6   | 6   | 6   | 6   | 12  | 3   | 8   |
| 2041 | 11  | 13  | 6   | 8   | 0   | 7   | 12  | 7   | 7   | 7   | 8   | 6   | 8   |
| 2042 | 3   | 12  | 3   | 2   | 13  | 8   | 7   | 12  | 12  | 12  | 17  | 3   | 2   |
| 2043 | 3   | 12  | 0   | 0   | 9   | 8   | 0   | 6   | 6   | 6   | 0   | 0   | 0   |
| 2044 | 18  | 6   | 0   | 3   | 3   | 0   | 0   | 0   | 0   | 0   | 6   | 0   | 0   |
| 2045 | 16  | 2   | 0   | 0   | 2   | 1   | 0   | 0   | 0   | 0   | 5   | 0   | 3   |
| 2046 | 66  | 0   | 0   | 5   | 15  | 0   | 3   | 0   | 0   | 0   | 6   | 0   | 5   |
| 2047 | 37  | 0   | 0   | 0   | 86  | 2   | 4   | 0   | 0   | 0   | 125 | 0   | 0   |
| 2048 | 41  | 0   | 0   | 0   | 45  | 0   | 29  | 0   | 0   | 0   | 113 | 52  | 0   |
| 2049 | 33  | 127 | 50  | 0   | 18  | 95  | 91  | 99  | 99  | 99  | 74  | 13  | 0   |
| 2050 | 24  | 112 | 15  | 0   | 12  | 65  | 44  | 64  | 64  | 64  | 36  | 3   | 90  |
| 2051 | 12  | 72  | 4   | 90  | 4   | 23  | 23  | 20  | 20  | 20  | 22  | 2   | 58  |
| 2052 | 2   | 35  | 2   | 59  | 0   | 18  | 13  | 18  | 18  | 18  | 13  | 0   | 37  |
| 2053 | 0   | 22  | 0   | 31  | 0   | 6   | 0   | 6   | 6   | 6   | 7   | 0   | 19  |
| 2054 | 0   | 13  | 0   | 16  | 0   | 0   | 0   | 0   | 0   | 0   | 0   | 0   | 4   |
| 2055 | 0   | 7   | 0   | 16  | 0   | 0   | 0   | 0   | 0   | 0   | 0   | 0   | 6   |
| 2056 | 0   | 0   | 0   | 6   | 0   | 0   | 0   | 0   | 0   | 0   | 0   | 0   | 2   |
| 2057 | 0   | 0   | 0   | 0   | 0   | 0   | 0   | 0   | 0   | 0   | 0   | 0   | 0   |
| 2058 | 0   | 0   | 0   | 0   | 0   | 0   | 0   | 0   | 0   | 0   | 0   | 0   | 0   |
| 2059 | 0   | 0   | 0   | 0   | 0   | 0   | 0   | 0   | 0   | 0   | 0   | 0   | 0   |

| 12%  | 144 | 145 | 146 | 147 | 148 | 149 | 150 | 151 | 152 | 153 | 154 | 155 | 156 |
|------|-----|-----|-----|-----|-----|-----|-----|-----|-----|-----|-----|-----|-----|
| 2060 | 0   | 0   | 0   | 0   | 0   | 0   | 0   | 0   | 0   | 0   | 0   | 0   | 0   |
| 2061 | 0   | 0   | 0   | 0   | 0   | 0   | 0   | 0   | 0   | 0   | 0   | 0   | 0   |
| 2062 | 0   | 0   | 0   | 0   | 0   | 0   | 0   | 0   | 0   | 0   | 0   | 0   | 0   |
| 2063 | 0   | 0   | 0   | 0   | 0   | 0   | 0   | 0   | 0   | 0   | 0   | 0   | 0   |
| 2064 | 0   | 0   | 0   | 0   | 0   | 0   | 0   | 0   | 0   | 0   | 0   | 0   | 0   |
| 2065 | 0   | 0   | 0   | 0   | 0   | 0   | 0   | 0   | 0   | 0   | 0   | 0   | 0   |
| 2066 | 0   | 0   | 0   | 0   | 0   | 0   | 0   | 0   | 0   | 0   | 0   | 0   | 0   |
| 2067 | 0   | 0   | 0   | 0   | 0   | 0   | 0   | 0   | 0   | 0   | 0   | 0   | 0   |
| 2068 | 0   | 0   | 0   | 0   | 0   | 0   | 0   | 0   | 0   | 0   | 0   | 0   | 0   |
| 2069 | 0   | 0   | 0   | 0   | 0   | 0   | 0   | 0   | 0   | 0   | 0   | 0   | 0   |
| 2070 | 0   | 0   | 0   | 0   | 0   | 0   | 0   | 0   | 0   | 0   | 0   | 0   | 0   |
| 2071 | 0   | 0   | 0   | 0   | 0   | 0   | 0   | 0   | 0   | 0   | 0   | 0   | 0   |
| 2072 | 0   | 0   | 0   | 0   | 0   | 0   | 0   | 0   | 0   | 0   | 0   | 0   | 0   |
| 2073 | 0   | 0   | 0   | 0   | 0   | 0   | 0   | 0   | 0   | 0   | 0   | 0   | 0   |
| 2074 | 0   | 0   | 0   | 0   | 0   | 0   | 0   | 0   | 0   | 0   | 0   | 0   | 0   |
| 2075 | 0   | 0   | 0   | 0   | 0   | 0   | 0   | 0   | 0   | 0   | 0   | 0   | 0   |
| 2076 | 0   | 0   | 0   | 0   | 0   | 0   | 0   | 0   | 0   | 0   | 0   | 0   | 0   |
| 2077 | 0   | 0   | 0   | 0   | 0   | 0   | 0   | 0   | 0   | 0   | 0   | 0   | 0   |
| 2078 | 0   | 0   | 0   | 0   | 0   | 0   | 0   | 0   | 0   | 0   | 0   | 0   | 0   |
| 2079 | 0   | 0   | 0   | 0   | 0   | 0   | 0   | 0   | 0   | 0   | 0   | 0   | 0   |
| 2080 | 0   | 0   | 0   | 0   | 0   | 0   | 0   | 0   | 0   | 0   | 0   | 0   | 0   |
| 2081 | 0   | 0   | 0   | 0   | 0   | 0   | 0   | 0   | 0   | 0   | 0   | 0   | 0   |
| 2082 | 0   | 0   | 0   | 0   | 0   | 0   | 0   | 0   | 0   | 0   | 0   | 0   | 0   |
| 2083 | 0   | 0   | 0   | 0   | 0   | 0   | 0   | 0   | 0   | 0   | 0   | 0   | 0   |
| 2084 | 0   | 0   | 0   | 0   | 0   | 0   | 0   | 0   | 0   | 0   | 0   | 0   | 0   |
| 2085 | 0   | 0   | 0   | 0   | 0   | 0   | 0   | 0   | 0   | 0   | 0   | 0   | 0   |
| 2086 | 0   | 0   | 0   | 0   | 0   | 0   | 0   | 0   | 0   | 0   | 0   | 0   | 0   |
| 2087 | 0   | 0   | 0   | 0   | 0   | 0   | 0   | 0   | 0   | 0   | 0   | 0   | 0   |
| 2088 | 0   | 0   | 0   | 0   | 0   | 0   | 0   | 0   | 0   | 0   | 0   | 0   | 0   |
| 2089 | 0   | 0   | 0   | 0   | 0   | 0   | 0   | 0   | 0   | 0   | 0   | 0   | 0   |
| 2090 | 0   | 0   | 0   | 0   | 0   | 0   | 0   | 0   | 0   | 0   | 0   | 0   | 0   |

| 12%  | 157 | 158 | 159 | 160 | 161 | 162 |
|------|-----|-----|-----|-----|-----|-----|
| 2002 |     |     |     |     |     |     |
| 2003 | 0   | 0   | 0   | 0   | 0   | 0   |
| 2004 | 0   | 0   | 0   | 0   | 0   | 0   |
| 2005 | 0   | 0   | 0   | 0   | 0   | 0   |
| 2006 | 0   | 0   | 0   | 0   | 0   | 0   |
| 2007 | 0   | 0   | 0   | 0   | 0   | 0   |
| 2008 | 0   | 0   | 0   | 0   | 0   | 0   |
| 2009 | 0   | 0   | 0   | 0   | 0   | 0   |
| 2010 | 0   | 0   | 0   | 0   | 0   | 0   |
| 2011 | 0   | 0   | 0   | 0   | 0   | 0   |
| 2012 | 0   | 0   | 0   | 0   | 0   | 0   |
| 2013 | 0   | 0   | 0   | 0   | 0   | 0   |
| 2014 | 0   | 0   | 0   | 0   | 0   | 0   |
| 2015 | 0   | 0   | 0   | 0   | 0   | 0   |
| 2016 | 0   | 0   | 0   | 0   | 0   | 0   |
| 2017 | 0   | 0   | 0   | 0   | 0   | 0   |
| 2018 | 0   | 0   | 0   | 0   | 0   | 0   |
| 2019 | 0   | 0   | 0   | 0   | 0   | 0   |
| 2020 | 0   | 0   | 0   | 0   | 0   | 0   |
| 2021 | 67  | 0   | 0   | 0   | 0   | 0   |
| 2022 | 51  | 0   | 0   | 0   | 0   | 0   |
| 2023 | 32  | 0   | 0   | 0   | 0   | 0   |
| 2024 | 24  | 0   | 0   | 0   | 0   | 0   |
| 2025 | 10  | 0   | 0   | 0   | 0   | 0   |
| 2026 | 10  | 64  | 65  | 65  | 32  | 64  |
| 2027 | 11  | 61  | 55  | 56  | 35  | 56  |
| 2028 | 11  | 33  | 32  | 31  | 24  | 32  |
| 2029 | 12  | 14  | 13  | 13  | 24  | 13  |
| 2030 | 12  | 20  | 21  | 21  | 32  | 21  |
| 2031 | 6   | 13  | 13  | 13  | 32  | 13  |
| 2032 | 2   | 8   | 12  | 12  | 16  | 12  |
| 2033 | 3   | 18  | 15  | 11  | 14  | 11  |
| 2034 | 12  | 11  | 9   | 12  | 17  | 12  |
| 2035 | 8   | 0   | 0   | 0   | 3   | 0   |
| 2036 | 6   | 3   | 3   | 4   | 5   | 4   |
| 2037 | 5   | 6   | 6   | 6   | 6   | 6   |
| 2038 | 0   | 6   | 6   | 6   | 9   | 6   |
| 2039 | 0   | 2   | 2   | 2   | 2   | 2   |
| 2040 | 0   | 6   | 6   | 6   | 8   | 6   |
| 2041 | 0   | 8   | 7   | 6   | 6   | 6   |
| 2042 | 13  | 7   | 12  | 13  | 13  | 13  |
| 2043 | 12  | 0   | 6   | 0   | 0   | 0   |
| 2044 | 18  | 5   | 0   | 2   | 2   | 2   |
| 2045 | 91  | 0   | 8   | 0   | 0   | 0   |
| 2046 | 46  | 0   | 18  | 9   | 9   | 9   |
| 2047 | 17  | 0   | 12  | 89  | 89  | 89  |
| 2048 | 6   | 101 | 86  | 63  | 63  | 63  |
| 2049 | 4   | 62  | 46  | 26  | 26  | 26  |
| 2050 | 0   | 25  | 23  | 18  | 18  | 18  |
| 2051 | 0   | 15  | 13  | 6   | 6   | 6   |
| 2052 | 0   | 4   | 1   | 0   | 0   | 0   |
| 2053 | 0   | 0   | 0   | 0   | 0   | 0   |
| 2054 | 0   | 0   | 0   | 0   | 0   | 0   |
| 2055 | 0   | 0   | 0   | 0   | 0   | 0   |
| 2056 | 0   | 0   | 0   | 0   | 0   | 0   |
| 2057 | 0   | 0   | 0   | 0   | 0   | 0   |
| 2058 | 0   | 0   | 0   | 0   | 0   | 0   |
| 2059 | 0   | 0   | 0   | 0   | 0   | 0   |

| 12%  | 157 | 158 | 159 | 160 | 161 | 162 |
|------|-----|-----|-----|-----|-----|-----|
| 2060 | 0   | 0   | 0   | 0   | 0   | 0   |
| 2061 | 0   | 0   | 0   | 0   | 0   | 0   |
| 2062 | 0   | 0   | 0   | 0   | 0   | 0   |
| 2063 | 0   | 0   | 0   | 0   | 0   | 0   |
| 2064 | 0   | 0   | 0   | 0   | 0   | 0   |
| 2065 | 0   | 0   | 0   | 0   | 0   | 0   |
| 2066 | 0   | 0   | 0   | 0   | 0   | 0   |
| 2067 | 0   | 0   | 0   | 0   | 0   | 0   |
| 2068 | 0   | 0   | 0   | 0   | 0   | 0   |
| 2069 | 0   | 0   | 0   | 0   | 0   | 0   |
| 2070 | 0   | 0   | 0   | 0   | 0   | 0   |
| 2071 | 0   | 0   | 0   | 0   | 0   | 0   |
| 2072 | 0   | 0   | 0   | 0   | 0   | 0   |
| 2073 | 0   | 0   | 0   | 0   | 0   | 0   |
| 2074 | 0   | 0   | 0   | 0   | 0   | 0   |
| 2075 | 0   | 0   | 0   | 0   | 0   | 0   |
| 2076 | 0   | 0   | 0   | 0   | 0   | 0   |
| 2077 | 0   | 0   | 0   | 0   | 0   | 0   |
| 2078 | 0   | 0   | 0   | 0   | 0   | 0   |
| 2079 | 0   | 0   | 0   | 0   | 0   | 0   |
| 2080 | 0   | 0   | 0   | 0   | 0   | 0   |
| 2081 | 0   | 0   | 0   | 0   | 0   | 0   |
| 2082 | 0   | 0   | 0   | 0   | 0   | 0   |
| 2083 | 0   | 0   | 0   | 0   | 0   | 0   |
| 2084 | 0   | 0   | 0   | 0   | 0   | 0   |
| 2085 | 0   | 0   | 0   | 0   | 0   | 0   |
| 2086 | 0   | 0   | 0   | 0   | 0   | 0   |
| 2087 | 0   | 0   | 0   | 0   | 0   | 0   |
| 2088 | 0   | 0   | 0   | 0   | 0   | 0   |
| 2089 | 0   | 0   | 0   | 0   | 0   | 0   |
| 2090 | 0   | 0   | 0   | 0   | 0   | 0   |

| 12%  | 1    | 2    | 3    | 4    | 5    | 6    | 7    | 8    | 9    | 10   | 11   | 12   | 13   |
|------|------|------|------|------|------|------|------|------|------|------|------|------|------|
| 2002 |      | 0    | 0    | 0    | 0    | 0    | 0    | 0    | 0    | 0    | 0    | 0    | 0    |
| 2003 | 0    | 0    | 0    | 0    | 0    | 0    | 0    | 0    | 0    | 0    | 0    | 0    | 0    |
| 2004 | 0    | 0    | 0    | 0    | 0    | 0    | 0    | 0    | 0    | 0    | 0    | 0    | 0    |
| 2005 | 0    | 0    | 0    | 0    | 0    | 0    | 0    | 0    | 0    | 0    | 0    | 0    | 0    |
| 2006 | 0    | 0    | 0    | 0    | 0    | 0    | 0    | 0    | 0    | 0    | 0    | 0    | 0    |
| 2007 | 0    | 0    | 0    | 0    | 0    | 0    | 0    | 0    | 0    | 0    | 0    | 0    | 0    |
| 2008 | 0    | 0    | 0    | 0    | 0    | 0    | 0    | 0    | 0    | 0    | 0    | 0    | 0    |
| 2009 | 0    | 0    | 0    | 0    | 0    | 0    | 0    | 0    | 0    | 0    | 0    | 0    | 0    |
| 2010 | 0    | 0    | 0    | 0    | 0    | 0    | 0    | 0    | 0    | 0    | 0    | 0    | 0    |
| 2011 | 0    | 0    | 0    | 0    | 0    | 0    | 0    | 0    | 0    | 0    | 0    | 0    | 0    |
| 2012 | 0    | 0    | 0    | 0    | 0    | 0    | 0    | 0    | 0    | 0    | 0    | 0    | 0    |
| 2013 | 0    | 0    | 0    | 0    | 0    | 0    | 0    | 0    | 0    | 0    | 0    | 0    | 0    |
| 2014 | 0    | 0    | 0    | 0    | 0    | 0    | 0    | 0    | 0    | 0    | 0    | 0    | 0    |
| 2015 | 0    | 0    | 0    | 0    | 0    | 0    | 0    | 0    | 0    | 0    | 0    | 0    | 0    |
| 2016 | 0    | 0    | 0    | 0    | 0    | 0    | 0    | 0    | 0    | 0    | 0    | 0    | 0    |
| 2017 | 0    | 0    | 0    | 0    | 0    | 0    | 0    | 0    | 0    | 0    | 0    | 0    | 0    |
| 2018 | 0    | 0    | 0    | 0    | 0    | 0    | 0    | 0    | 0    | 0    | 0    | 0    | 0    |
| 2019 | 0    | 0    | 0    | 0    | 0    | 0    | 0    | 0    | 0    | 0    | 0    | 0    | 0    |
| 2020 | 0    | 0    | 0    | 991  | 0    | 0    | 0    | 0    | 0    | 0    | 0    | 0    | 351  |
| 2021 | 0    | 0    | 0    | 983  | 0    | 0    | 0    | 0    | 0    | 0    | 0    | 0    | 520  |
| 2022 | 0    | 0    | 0    | 991  | 0    | 0    | 0    | 0    | 0    | 0    | 0    | 0    | 413  |
| 2023 | 0    | 0    | 0    | 1002 | 0    | 0    | 0    | 0    | 0    | 0    | 0    | 0    | 672  |
| 2024 | 0    | 0    | 0    | 979  | 0    | 0    | 0    | 0    | 0    | 0    | 0    | 0    | 785  |
| 2025 | 998  | 998  | 0    | 1049 | 998  | 998  | 998  | 998  | 998  | 277  | 277  | 0    | 990  |
| 2026 | 975  | 975  | 0    | 998  | 975  | 975  | 975  | 975  | 975  | 347  | 374  | 0    | 1265 |
| 2027 | 979  | 979  | 0    | 1002 | 979  | 979  | 979  | 979  | 979  | 665  | 355  | 0    | 1292 |
| 2028 | 991  | 991  | 0    | 998  | 991  | 991  | 991  | 991  | 991  | 433  | 449  | 0    | 1256 |
| 2029 | 975  | 975  | 0    | 1115 | 975  | 975  | 975  | 975  | 975  | 940  | 629  | 0    | 1059 |
| 2030 | 983  | 983  | 998  | 1100 | 983  | 983  | 983  | 983  | 983  | 1037 | 593  | 257  | 1566 |
| 2031 | 1006 | 1006 | 987  | 1045 | 1006 | 1022 | 1006 | 1006 | 1006 | 1190 | 702  | 402  | 2010 |
| 2032 | 998  | 998  | 975  | 1170 | 998  | 1088 | 998  | 971  | 998  | 1971 | 906  | 452  | 2068 |
| 2033 | 1242 | 1034 | 1002 | 1566 | 975  | 1088 | 1034 | 1014 | 1034 | 1904 | 1008 | 546  | 1677 |
| 2034 | 1030 | 1030 | 994  | 1002 | 1010 | 1065 | 1030 | 878  | 1030 | 1205 | 828  | 566  | 2223 |
| 2035 | 1080 | 1080 | 983  | 1413 | 1041 | 1069 | 1080 | 839  | 1080 | 1268 | 902  | 993  | 1496 |
| 2036 | 1873 | 1217 | 1041 | 1328 | 1104 | 1041 | 1221 | 811  | 1217 | 2345 | 737  | 695  | 1163 |
| 2037 | 1327 | 1190 | 1022 | 1039 | 1073 | 1481 | 1197 | 901  | 1190 | 2098 | 702  | 997  | 793  |
| 2038 | 1539 | 1283 | 1022 | 1109 | 1326 | 1692 | 1303 | 846  | 1283 | 1552 | 1257 | 1114 | 1512 |
| 2039 | 1832 | 1049 | 1026 | 1659 | 1084 | 1037 | 1422 | 1020 | 1360 | 1623 | 900  | 839  | 644  |
| 2040 | 2038 | 1275 | 1096 | 1262 | 1275 | 1280 | 1523 | 1164 | 1472 | 1346 | 867  | 954  | 818  |
| 2041 | 1133 | 952  | 1104 | 1540 | 975  | 920  | 1721 | 1245 | 1565 | 1378 | 1445 | 938  | 445  |
| 2042 | 1937 | 1684 | 1260 | 2861 | 1338 | 1551 | 1833 | 1369 | 1712 | 1743 | 1437 | 1153 | 594  |
| 2043 | 1308 | 468  | 1232 | 4322 | 541  | 569  | 1116 | 1030 | 1108 | 1783 | 1189 | 1817 | 791  |
| 2044 | 3210 | 702  | 1014 | 3412 | 1315 | 1229 | 1512 | 1512 | 1512 | 1222 | 746  | 1492 | 854  |
| 2045 | 4074 | 1302 | 511  | 5058 | 1959 | 2017 | 1927 | 1927 | 1927 | 1549 | 550  | 1688 | 878  |
| 2046 | 4373 | 792  | 792  | 4520 | 2372 | 2569 | 1869 | 1869 | 1869 | 1388 | 546  | 883  | 596  |
| 2047 | 5671 | 796  | 928  | 2620 | 2368 | 2596 | 2336 | 2336 | 2336 | 1102 | 409  | 410  | 137  |
| 2048 | 5129 | 1319 | 1951 | 1210 | 2959 | 3477 | 3450 | 3450 | 3450 | 800  | 352  | 1457 | 204  |
| 2049 | 2803 | 1528 | 1939 | 1045 | 2924 | 3168 | 3231 | 3231 | 3231 | 1393 | 517  | 1782 | 3085 |
| 2050 | 4797 | 1689 | 2120 | 0    | 2452 | 1662 | 1960 | 1960 | 1960 | 3335 | 1373 | 2863 | 4708 |
| 2051 | 5860 | 1429 | 2030 | 275  | 2765 | 3437 | 3052 | 3052 | 3052 | 3737 | 1339 | 2361 | 2832 |
| 2052 | 4070 | 1917 | 3528 | 0    | 4409 | 3534 | 3227 | 3227 | 3227 | 4947 | 773  | 1677 | 1320 |
| 2053 | 2640 | 1109 | 1816 | 0    | 3649 | 2981 | 3146 | 3146 | 3146 | 6115 | 1176 | 1963 | 660  |
| 2054 | 2035 | 2175 | 3327 | 0    | 2420 | 2200 | 2200 | 2200 | 2200 | 5055 | 1919 | 1551 | 660  |
| 2055 | 275  | 1312 | 2007 | 0    | 1155 | 825  | 825  | 825  | 825  | 3080 | 1332 | 2383 | 220  |
| 2056 | 275  | 55   | 1876 | 0    | 275  | 275  | 275  | 275  | 275  | 1485 | 741  | 2769 | 0    |
| 2057 | 0    | 605  | 3493 | 0    | 330  | 330  | 330  | 330  | 330  | 1210 | 714  | 2467 | 0    |
| 2058 | 275  | 0    | 3266 | 0    | 0    | 55   | 55   | 55   | 55   | 385  | 1068 | 2138 | 0    |
| 2059 | 0    | 165  | 2049 | 0    | 275  | 275  | 0    | 0    | 0    | 0    | 330  | 1098 | 0    |

| 12%  | 1 | 2 | 3    | 4 | 5 | 6 | 7 | 8 | 9 | 10  | 11 | 12   | 13 |
|------|---|---|------|---|---|---|---|---|---|-----|----|------|----|
| 2060 | 0 | 0 | 2431 | 0 | 0 | 0 | 0 | 0 | 0 | 220 | 55 | 270  | 0  |
| 2061 | 0 | 0 | 495  | 0 | 0 | 0 | 0 | 0 | 0 | 0   | 0  | 1060 | 0  |
| 2062 | 0 | 0 | 990  | 0 | 0 | 0 | 0 | 0 | 0 | 0   | 0  | 1355 | 0  |
| 2063 | 0 | 0 | 220  | 0 | 0 | 0 | 0 | 0 | 0 | 0   | 0  | 1210 | 0  |
| 2064 | 0 | 0 | 220  | 0 | 0 | 0 | 0 | 0 | 0 | 0   | 0  | 660  | 0  |
| 2065 | 0 | 0 | 0    | 0 | 0 | 0 | 0 | 0 | 0 | 0   | 0  | 0    | 0  |
| 2066 | 0 | 0 | 110  | 0 | 0 | 0 | 0 | 0 | 0 | 0   | 0  | 0    | 0  |
| 2067 | 0 | 0 | 0    | 0 | 0 | 0 | 0 | 0 | 0 | 0   | 0  | 0    | 0  |
| 2068 | 0 | 0 | 0    | 0 | 0 | 0 | 0 | 0 | 0 | 0   | 0  | 0    | 0  |
| 2069 | 0 | 0 | 0    | 0 | 0 | 0 | 0 | 0 | 0 | 0   | 0  | 0    | 0  |
| 2070 | 0 | 0 | 0    | 0 | 0 | 0 | 0 | 0 | 0 | 0   | 0  | 0    | 0  |
| 2071 | 0 | 0 | 0    | 0 | 0 | 0 | 0 | 0 | 0 | 0   | 0  | 0    | 0  |
| 2072 | 0 | 0 | 0    | 0 | 0 | 0 | 0 | 0 | 0 | 0   | 0  | 0    | 0  |
| 2073 | 0 | 0 | 0    | 0 | 0 | 0 | 0 | 0 | 0 | 0   | 0  | 0    | 0  |
| 2074 | 0 | 0 | 0    | 0 | 0 | 0 | 0 | 0 | 0 | 0   | 0  | 0    | 0  |
| 2075 | 0 | 0 | 0    | 0 | 0 | 0 | 0 | 0 | 0 | 0   | 0  | 0    | 0  |
| 2076 | 0 | 0 | 0    | 0 | 0 | 0 | 0 | 0 | 0 | 0   | 0  | 0    | 0  |
| 2077 | 0 | 0 | 0    | 0 | 0 | 0 | 0 | 0 | 0 | 0   | 0  | 0    | 0  |
| 2078 | 0 | 0 | 0    | 0 | 0 | 0 | 0 | 0 | 0 | 0   | 0  | 0    | 0  |
| 2079 | 0 | 0 | 0    | 0 | 0 | 0 | 0 | 0 | 0 | 0   | 0  | 0    | 0  |
| 2080 | 0 | 0 | 0    | 0 | 0 | 0 | 0 | 0 | 0 | 0   | 0  | 0    | 0  |
| 2081 | 0 | 0 | 0    | 0 | 0 | 0 | 0 | 0 | 0 | 0   | 0  | 0    | 0  |
| 2082 | 0 | 0 | 0    | 0 | 0 | 0 | 0 | 0 | 0 | 0   | 0  | 0    | 0  |
| 2083 | 0 | 0 | 0    | 0 | 0 | 0 | 0 | 0 | 0 | 0   | 0  | 0    | 0  |
| 2084 | 0 | 0 | 0    | 0 | 0 | 0 | 0 | 0 | 0 | 0   | 0  | 0    | 0  |
| 2085 | 0 | 0 | 0    | 0 | 0 | 0 | 0 | 0 | 0 | 0   | 0  | 0    | 0  |
| 2086 | 0 | 0 | 0    | 0 | 0 | 0 | 0 | 0 | 0 | 0   | 0  | 0    | 0  |
| 2087 | 0 | 0 | 0    | 0 | 0 | 0 | 0 | 0 | 0 | 0   | 0  | 0    | 0  |
| 2088 | 0 | 0 | 0    | 0 | 0 | 0 | 0 | 0 | 0 | 0   | 0  | 0    | 0  |
| 2089 | 0 | 0 | 0    | 0 | 0 | 0 | 0 | 0 | 0 | 0   | 0  | 0    | 0  |
| 2090 | 0 | 0 | 0    | 0 | 0 | 0 | 0 | 0 | 0 | 0   | 0  | 0    | 0  |

| 12%  | 14   | 15   | 16   | 17   | 18   | 19   | 20   | 21   | 22   | 23   | 24   | 25   | 26   |
|------|------|------|------|------|------|------|------|------|------|------|------|------|------|
| 2002 | 0    | 0    | 0    | 0    | 0    | 0    | 0    | 0    | 0    | 0    | 0    | 0    | 0    |
| 2003 | 0    | 0    | 0    | 0    | 0    | 0    | 0    | 0    | 0    | 0    | 0    | 0    | 0    |
| 2004 | 0    | 0    | 0    | 0    | 0    | 0    | 0    | 0    | 0    | 0    | 0    | 0    | 0    |
| 2005 | 0    | 0    | 0    | 0    | 0    | 0    | 0    | 0    | 0    | 0    | 0    | 0    | 0    |
| 2006 | 0    | 0    | 0    | 0    | 0    | 0    | 0    | 0    | 0    | 0    | 0    | 0    | 0    |
| 2007 | 0    | 0    | 0    | 0    | 0    | 0    | 0    | 0    | 0    | 0    | 0    | 0    | 0    |
| 2008 | 0    | 0    | 0    | 0    | 0    | 0    | 0    | 0    | 0    | 0    | 0    | 0    | 0    |
| 2009 | 0    | 0    | 0    | 0    | 0    | 0    | 0    | 0    | 0    | 0    | 0    | 0    | 0    |
| 2010 | 0    | 0    | 0    | 0    | 0    | 0    | 0    | 0    | 0    | 0    | 0    | 0    | 0    |
| 2011 | 0    | 0    | 0    | 0    | 0    | 0    | 0    | 0    | 0    | 0    | 0    | 0    | 0    |
| 2012 | 0    | 0    | 0    | 0    | 0    | 0    | 0    | 0    | 0    | 0    | 0    | 0    | 0    |
| 2013 | 0    | 0    | 0    | 0    | 0    | 0    | 0    | 0    | 0    | 0    | 0    | 0    | 0    |
| 2014 | 0    | 0    | 0    | 0    | 0    | 0    | 0    | 0    | 0    | 0    | 0    | 0    | 0    |
| 2015 | 0    | 0    | 0    | 0    | 0    | 0    | 0    | 0    | 0    | 0    | 0    | 0    | 0    |
| 2016 | 0    | 0    | 0    | 0    | 0    | 0    | 0    | 0    | 0    | 0    | 0    | 0    | 0    |
| 2017 | 0    | 0    | 0    | 0    | 0    | 0    | 0    | 0    | 0    | 0    | 0    | 0    | 0    |
| 2018 | 0    | 0    | 0    | 0    | 0    | 0    | 0    | 0    | 0    | 0    | 0    | 0    | 0    |
| 2019 | 0    | 0    | 0    | 0    | 0    | 0    | 0    | 0    | 0    | 0    | 0    | 0    | 0    |
| 2020 | 0    | 0    | 0    | 0    | 0    | 0    | 0    | 0    | 39   | 0    | 0    | 0    | 0    |
| 2021 | 0    | 0    | 0    | 0    | 0    | 0    | 0    | 0    | 117  | 0    | 0    | 0    | 0    |
| 2022 | 0    | 0    | 0    | 0    | 0    | 0    | 0    | 0    | 86   | 0    | 0    | 0    | 0    |
| 2023 | 0    | 0    | 0    | 0    | 0    | 0    | 0    | 0    | 293  | 0    | 0    | 0    | 0    |
| 2024 | 0    | 0    | 0    | 0    | 0    | 0    | 0    | 0    | 482  | 0    | 0    | 0    | 0    |
| 2025 | 250  | 679  | 952  | 16   | 277  | 66   | 66   | 0    | 474  | 47   | 246  | 250  | 4    |
| 2026 | 339  | 667  | 952  | 90   | 367  | 137  | 144  | 0    | 800  | 51   | 445  | 367  | 20   |
| 2027 | 390  | 997  | 1321 | 200  | 665  | 380  | 125  | 0    | 749  | 39   | 658  | 697  | 20   |
| 2028 | 507  | 640  | 944  | 109  | 464  | 250  | 164  | 0    | 981  | 98   | 570  | 441  | 51   |
| 2029 | 759  | 616  | 1050 | 317  | 539  | 591  | 446  | 0    | 446  | 415  | 829  | 546  | 203  |
| 2030 | 1091 | 1382 | 1364 | 494  | 931  | 493  | 320  | 39   | 685  | 293  | 1207 | 573  | 113  |
| 2031 | 585  | 1060 | 1219 | 462  | 950  | 556  | 289  | 140  | 685  | 164  | 864  | 884  | 396  |
| 2032 | 922  | 1700 | 1561 | 855  | 1299 | 886  | 281  | 207  | 743  | 816  | 1175 | 1115 | 600  |
| 2033 | 883  | 1178 | 1769 | 1196 | 1519 | 1448 | 783  | 238  | 1663 | 835  | 893  | 1563 | 1138 |
| 2034 | 675  | 1276 | 1281 | 587  | 930  | 882  | 583  | 304  | 1254 | 576  | 573  | 883  | 462  |
| 2035 | 644  | 876  | 1065 | 387  | 792  | 779  | 539  | 646  | 1534 | 207  | 935  | 1016 | 541  |
| 2036 | 730  | 1237 | 1215 | 697  | 1020 | 858  | 413  | 344  | 1011 | 305  | 880  | 738  | 344  |
| 2037 | 1453 | 1295 | 1613 | 1141 | 1433 | 1235 | 449  | 421  | 909  | 320  | 2106 | 1382 | 855  |
| 2038 | 845  | 1803 | 1676 | 1166 | 1524 | 1238 | 530  | 382  | 1153 | 756  | 1545 | 1253 | 1020 |
| 2039 | 951  | 1889 | 1641 | 1114 | 1450 | 2402 | 786  | 775  | 1353 | 351  | 1384 | 1641 | 1205 |
| 2040 | 699  | 1469 | 1479 | 800  | 1307 | 1868 | 865  | 617  | 1573 | 647  | 1803 | 1296 | 875  |
| 2041 | 942  | 1492 | 1479 | 929  | 1276 | 1259 | 461  | 771  | 1144 | 293  | 1481 | 1134 | 631  |
| 2042 | 1366 | 1522 | 1671 | 1207 | 1543 | 1090 | 657  | 673  | 688  | 509  | 1456 | 1451 | 773  |
| 2043 | 1433 | 1056 | 1806 | 1416 | 1696 | 1475 | 983  | 480  | 406  | 1035 | 562  | 1551 | 1122 |
| 2044 | 1543 | 806  | 1378 | 1050 | 1308 | 1742 | 1184 | 826  | 168  | 1511 | 1500 | 1960 | 1546 |
| 2045 | 1021 | 1084 | 938  | 701  | 837  | 1109 | 759  | 1262 | 1737 | 1205 | 722  | 970  | 506  |
| 2046 | 1128 | 676  | 519  | 238  | 449  | 917  | 339  | 1290 | 2965 | 926  | 1237 | 1175 | 886  |
| 2047 | 823  | 1280 | 1245 | 902  | 1121 | 2700 | 1045 | 915  | 4787 | 1300 | 1328 | 857  | 857  |
| 2048 | 1616 | 505  | 611  | 482  | 525  | 3089 | 1209 | 899  | 3618 | 3605 | 1829 | 2627 | 2627 |
| 2049 | 4035 | 1270 | 1083 | 1083 | 1083 | 4515 | 1291 | 1330 | 1375 | 2131 | 1177 | 1881 | 1881 |
| 2050 | 1581 | 1298 | 1955 | 1955 | 1955 | 3942 | 1099 | 3739 | 660  | 1767 | 2874 | 1916 | 1916 |
| 2051 | 1158 | 2084 | 1390 | 1390 | 1390 | 5702 | 815  | 2158 | 440  | 1786 | 3988 | 2462 | 2462 |
| 2052 | 1896 | 3665 | 2576 | 2576 | 2576 | 5950 | 1852 | 2285 | 0    | 3284 | 2575 | 3559 | 3559 |
| 2053 | 4061 | 3241 | 2840 | 2840 | 2840 | 4022 | 1477 | 1790 | 220  | 2699 | 1975 | 2681 | 2681 |
| 2054 | 3423 | 2619 | 2908 | 2908 | 2908 | 2090 | 1098 | 1806 | 0    | 2468 | 1379 | 2191 | 2191 |
| 2055 | 1778 | 1618 | 2867 | 2867 | 2867 | 1210 | 387  | 1472 | 0    | 2388 | 990  | 1320 | 1320 |
| 2056 | 1575 | 1100 | 1799 | 1799 | 1799 | 715  | 1024 | 2552 | 0    | 1320 | 495  | 990  | 990  |
| 2057 | 1100 | 935  | 1210 | 1210 | 1210 | 495  | 907  | 2757 | 0    | 990  | 220  | 660  | 660  |
| 2058 | 935  | 0    | 825  | 825  | 825  | 0    | 55   | 2895 | 0    | 660  | 0    | 0    | 0    |
| 2059 | 330  | 0    | 220  | 220  | 220  | 55   | 55   | 1361 | 0    | 0    | 0    | 0    | 0    |

| 12%  | 14 | 15 | 16 | 17 | 18 | 19 | 20 | 21   | 22 | 23 | 24 | 25 | 26 |
|------|----|----|----|----|----|----|----|------|----|----|----|----|----|
| 2060 | 0  | 0  | 0  | 0  | 0  | 0  | 0  | 1040 | 0  | 0  | 0  | 0  | 0  |
| 2061 | 0  | 0  | 0  | 0  | 0  | 0  | 55 | 1194 | 0  | 0  | 0  | 0  | 0  |
| 2062 | 0  | 0  | 0  | 0  | 0  | 0  | 0  | 1230 | 0  | 0  | 0  | 0  | 0  |
| 2063 | 0  | 0  | 0  | 0  | 0  | 0  | 0  | 990  | 0  | 0  | 0  | 0  | 0  |
| 2064 | 0  | 0  | 0  | 0  | 0  | 0  | 0  | 605  | 0  | 0  | 0  | 0  | 0  |
| 2065 | 0  | 0  | 0  | 0  | 0  | 0  | 0  | 0    | 0  | 0  | 0  | 0  | 0  |
| 2066 | 0  | 0  | 0  | 0  | 0  | 0  | 0  | 0    | 0  | 0  | 0  | 0  | 0  |
| 2067 | 0  | 0  | 0  | 0  | 0  | 0  | 0  | 0    | 0  | 0  | 0  | 0  | 0  |
| 2068 | 0  | 0  | 0  | 0  | 0  | 0  | 0  | 0    | 0  | 0  | 0  | 0  | 0  |
| 2069 | 0  | 0  | 0  | 0  | 0  | 0  | 0  | 0    | 0  | 0  | 0  | 0  | 0  |
| 2070 | 0  | 0  | 0  | 0  | 0  | 0  | 0  | 0    | 0  | 0  | 0  | 0  | 0  |
| 2071 | 0  | 0  | 0  | 0  | 0  | 0  | 0  | 0    | 0  | 0  | 0  | 0  | 0  |
| 2072 | 0  | 0  | 0  | 0  | 0  | 0  | 0  | 0    | 0  | 0  | 0  | 0  | 0  |
| 2073 | 0  | 0  | 0  | 0  | 0  | 0  | 0  | 0    | 0  | 0  | 0  | 0  | 0  |
| 2074 | 0  | 0  | 0  | 0  | 0  | 0  | 0  | 0    | 0  | 0  | 0  | 0  | 0  |
| 2075 | 0  | 0  | 0  | 0  | 0  | 0  | 0  | 0    | 0  | 0  | 0  | 0  | 0  |
| 2076 | 0  | 0  | 0  | 0  | 0  | 0  | 0  | 0    | 0  | 0  | 0  | 0  | 0  |
| 2077 | 0  | 0  | 0  | 0  | 0  | 0  | 0  | 0    | 0  | 0  | 0  | 0  | 0  |
| 2078 | 0  | 0  | 0  | 0  | 0  | 0  | 0  | 0    | 0  | 0  | 0  | 0  | 0  |
| 2079 | 0  | 0  | 0  | 0  | 0  | 0  | 0  | 0    | 0  | 0  | 0  | 0  | 0  |
| 2080 | 0  | 0  | 0  | 0  | 0  | 0  | 0  | 0    | 0  | 0  | 0  | 0  | 0  |
| 2081 | 0  | 0  | 0  | 0  | 0  | 0  | 0  | 0    | 0  | 0  | 0  | 0  | 0  |
| 2082 | 0  | 0  | 0  | 0  | 0  | 0  | 0  | 0    | 0  | 0  | 0  | 0  | 0  |
| 2083 | 0  | 0  | 0  | 0  | 0  | 0  | 0  | 0    | 0  | 0  | 0  | 0  | 0  |
| 2084 | 0  | 0  | 0  | 0  | 0  | 0  | 0  | 0    | 0  | 0  | 0  | 0  | 0  |
| 2085 | 0  | 0  | 0  | 0  | 0  | 0  | 0  | 0    | 0  | 0  | 0  | 0  | 0  |
| 2086 | 0  | 0  | 0  | 0  | 0  | 0  | 0  | 0    | 0  | 0  | 0  | 0  | 0  |
| 2087 | 0  | 0  | 0  | 0  | 0  | 0  | 0  | 0    | 0  | 0  | 0  | 0  | 0  |
| 2088 | 0  | 0  | 0  | 0  | 0  | 0  | 0  | 0    | 0  | 0  | 0  | 0  | 0  |
| 2089 | 0  | 0  | 0  | 0  | 0  | 0  | 0  | 0    | 0  | 0  | 0  | 0  | 0  |
| 2090 | 0  | 0  | 0  | 0  | 0  | 0  | 0  | 0    | 0  | 0  | 0  | 0  | 0  |



| 12%  | 27   | 28   | 29   | 30   | 31   | 32   | 33   | 34   | 35   | 36   | 37   | 38   | 39   |
|------|------|------|------|------|------|------|------|------|------|------|------|------|------|
| 2002 | 0    | 0    | 0    | 0    | 0    | 0    | 0    | 0    | 0    | 0    | 0    | 0    | 0    |
| 2003 | 0    | 0    | 0    | 0    | 0    | 0    | 0    | 0    | 0    | 0    | 0    | 0    | 0    |
| 2004 | 0    | 0    | 0    | 0    | 0    | 0    | 0    | 0    | 0    | 0    | 0    | 0    | 0    |
| 2005 | 0    | 0    | 0    | 0    | 0    | 0    | 0    | 0    | 0    | 0    | 0    | 0    | 0    |
| 2006 | 0    | 0    | 0    | 0    | 0    | 0    | 0    | 0    | 0    | 0    | 0    | 0    | 0    |
| 2007 | 0    | 0    | 0    | 0    | 0    | 0    | 0    | 0    | 0    | 0    | 0    | 0    | 0    |
| 2008 | 0    | 0    | 0    | 0    | 0    | 0    | 0    | 0    | 0    | 0    | 0    | 0    | 0    |
| 2009 | 0    | 0    | 0    | 0    | 0    | 0    | 0    | 0    | 0    | 0    | 0    | 0    | 0    |
| 2010 | 0    | 0    | 0    | 0    | 0    | 0    | 0    | 0    | 0    | 0    | 0    | 0    | 0    |
| 2011 | 0    | 0    | 0    | 0    | 0    | 0    | 0    | 0    | 0    | 0    | 0    | 0    | 0    |
| 2012 | 0    | 0    | 0    | 0    | 0    | 0    | 0    | 0    | 0    | 0    | 0    | 0    | 0    |
| 2013 | 0    | 0    | 0    | 0    | 0    | 0    | 0    | 0    | 0    | 0    | 0    | 0    | 0    |
| 2014 | 0    | 0    | 0    | 0    | 0    | 0    | 0    | 0    | 0    | 0    | 0    | 0    | 0    |
| 2015 | 0    | 0    | 0    | 0    | 0    | 0    | 0    | 0    | 0    | 0    | 0    | 0    | 0    |
| 2016 | 0    | 0    | 0    | 0    | 0    | 0    | 0    | 0    | 0    | 0    | 0    | 0    | 0    |
| 2017 | 0    | 0    | 0    | 0    | 0    | 0    | 0    | 0    | 0    | 0    | 0    | 0    | 0    |
| 2018 | 0    | 0    | 0    | 0    | 0    | 0    | 0    | 0    | 0    | 0    | 0    | 0    | 0    |
| 2019 | 0    | 0    | 0    | 0    | 0    | 0    | 0    | 0    | 0    | 0    | 0    | 0    | 0    |
| 2020 | 0    | 0    | 0    | 0    | 991  | 0    | 0    | 0    | 0    | 0    | 0    | 0    | 0    |
| 2021 | 0    | 0    | 0    | 0    | 983  | 0    | 0    | 0    | 0    | 0    | 0    | 0    | 0    |
| 2022 | 0    | 0    | 0    | 0    | 991  | 0    | 0    | 0    | 0    | 0    | 0    | 0    | 0    |
| 2023 | 0    | 0    | 0    | 0    | 1002 | 0    | 0    | 0    | 0    | 0    | 0    | 0    | 0    |
| 2024 | 0    | 0    | 0    | 0    | 979  | 0    | 0    | 0    | 0    | 0    | 0    | 0    | 0    |
| 2025 | 66   | 998  | 998  | 0    | 1049 | 998  | 998  | 998  | 998  | 998  | 277  | 277  | 0    |
| 2026 | 137  | 975  | 975  | 0    | 998  | 975  | 975  | 975  | 975  | 975  | 614  | 532  | 0    |
| 2027 | 392  | 979  | 979  | 0    | 1002 | 979  | 979  | 979  | 979  | 979  | 665  | 465  | 0    |
| 2028 | 282  | 991  | 991  | 0    | 1108 | 991  | 991  | 991  | 991  | 991  | 759  | 775  | 0    |
| 2029 | 344  | 975  | 975  | 0    | 1225 | 975  | 975  | 975  | 975  | 975  | 1140 | 1030 | 0    |
| 2030 | 293  | 983  | 983  | 998  | 1583 | 983  | 983  | 983  | 983  | 983  | 974  | 825  | 257  |
| 2031 | 587  | 1006 | 1006 | 987  | 1309 | 1006 | 1077 | 1006 | 1006 | 1006 | 1264 | 1134 | 512  |
| 2032 | 768  | 998  | 998  | 975  | 1771 | 998  | 1579 | 998  | 971  | 998  | 2062 | 1311 | 924  |
| 2033 | 1302 | 1462 | 1034 | 1002 | 2002 | 975  | 1894 | 1089 | 1069 | 1089 | 1889 | 1299 | 959  |
| 2034 | 603  | 1085 | 1085 | 994  | 1882 | 1010 | 2130 | 1085 | 933  | 1085 | 1971 | 1307 | 982  |
| 2035 | 634  | 1300 | 1190 | 983  | 1417 | 1041 | 2110 | 1300 | 1059 | 1300 | 1598 | 1350 | 1272 |
| 2036 | 468  | 2148 | 1492 | 1041 | 1273 | 1159 | 1981 | 2101 | 1691 | 2097 | 2302 | 1523 | 1579 |
| 2037 | 1093 | 2400 | 1618 | 1022 | 918  | 1073 | 1288 | 1995 | 1726 | 1987 | 1736 | 906  | 1783 |
| 2038 | 1073 | 1433 | 1378 | 1022 | 1262 | 1821 | 1218 | 1444 | 980  | 1425 | 1155 | 612  | 1888 |
| 2039 | 1348 | 2570 | 1305 | 1136 | 1180 | 1359 | 1332 | 2011 | 1660 | 1972 | 1599 | 597  | 1657 |
| 2040 | 1027 | 2211 | 1310 | 1591 | 1368 | 2100 | 1355 | 1805 | 1443 | 1774 | 1661 | 776  | 1088 |
| 2041 | 720  | 1247 | 1066 | 1434 | 1552 | 1403 | 1524 | 1383 | 868  | 1215 | 1630 | 789  | 1708 |
| 2042 | 944  | 2138 | 1481 | 2332 | 2661 | 2995 | 1508 | 1797 | 1357 | 1692 | 1912 | 769  | 1683 |
| 2043 | 1231 | 1476 | 644  | 1523 | 4130 | 1491 | 1842 | 840  | 720  | 829  | 1779 | 871  | 1393 |
| 2044 | 1659 | 3974 | 962  | 2004 | 3160 | 2310 | 1701 | 1878 | 1878 | 1878 | 1909 | 690  | 1019 |
| 2045 | 751  | 4390 | 1216 | 1206 | 3648 | 2093 | 2647 | 2184 | 2184 | 2184 | 1313 | 668  | 757  |
| 2046 | 972  | 3906 | 1107 | 1539 | 4123 | 1802 | 2403 | 1983 | 1983 | 1983 | 1030 | 617  | 773  |
| 2047 | 857  | 3894 | 1283 | 2006 | 2777 | 1921 | 2027 | 2380 | 2380 | 2380 | 842  | 492  | 740  |
| 2048 | 2627 | 3695 | 1284 | 2069 | 1033 | 2487 | 2161 | 2621 | 2621 | 2621 | 729  | 505  | 1085 |
| 2049 | 1881 | 3656 | 1100 | 1900 | 931  | 2409 | 2822 | 2417 | 2417 | 2417 | 993  | 348  | 1852 |
| 2050 | 1916 | 4229 | 1747 | 2042 | 338  | 3155 | 2963 | 3030 | 3030 | 3030 | 4735 | 1259 | 1728 |
| 2051 | 2462 | 4485 | 1610 | 2089 | 114  | 2876 | 2441 | 2916 | 2916 | 2916 | 4013 | 1123 | 1713 |
| 2052 | 3559 | 3586 | 1646 | 2184 | 173  | 2790 | 2076 | 2590 | 2590 | 2590 | 4496 | 1334 | 1787 |
| 2053 | 2681 | 2824 | 1274 | 2012 | 114  | 2057 | 1602 | 2006 | 2006 | 2006 | 4414 | 1479 | 1967 |
| 2054 | 2191 | 1885 | 1012 | 2549 | 0    | 1527 | 1331 | 1586 | 1586 | 1586 | 4421 | 1492 | 2168 |
| 2055 | 1320 | 1320 | 878  | 2400 | 0    | 1099 | 491  | 1225 | 1225 | 1225 | 2729 | 1081 | 2345 |
| 2056 | 990  | 173  | 404  | 2271 | 0    | 365  | 126  | 185  | 185  | 185  | 1673 | 741  | 2670 |
| 2057 | 660  | 283  | 192  | 2239 | 0    | 118  | 294  | 243  | 243  | 243  | 1049 | 443  | 2239 |
| 2058 | 0    | 55   | 192  | 1820 | 0    | 243  | 0    | 0    | 0    | 0    | 526  | 384  | 1557 |
| 2059 | 0    | 169  | 67   | 1526 | 0    | 114  | 0    | 0    | 0    | 0    | 283  | 137  | 945  |

| 12%  | 27 | 28 | 29 | 30   | 31 | 32 | 33 | 34 | 35 | 36 | 37  | 38 | 39  |
|------|----|----|----|------|----|----|----|----|----|----|-----|----|-----|
| 2060 | 0  | 0  | 0  | 1350 | 0  | 0  | 0  | 0  | 0  | 0  | 0   | 0  | 690 |
| 2061 | 0  | 0  | 0  | 1001 | 0  | 0  | 0  | 0  | 0  | 0  | 114 | 0  | 545 |
| 2062 | 0  | 0  | 0  | 636  | 0  | 0  | 0  | 0  | 0  | 0  | 0   | 0  | 549 |
| 2063 | 0  | 0  | 0  | 130  | 0  | 0  | 0  | 0  | 0  | 0  | 0   | 0  | 545 |
| 2064 | 0  | 0  | 0  | 63   | 0  | 0  | 0  | 0  | 0  | 0  | 0   | 0  | 204 |
| 2065 | 0  | 0  | 0  | 122  | 0  | 0  | 0  | 0  | 0  | 0  | 0   | 0  | 0   |
| 2066 | 0  | 0  | 0  | 114  | 0  | 0  | 0  | 0  | 0  | 0  | 0   | 0  | 0   |
| 2067 | 0  | 0  | 0  | 0    | 0  | 0  | 0  | 0  | 0  | 0  | 0   | 0  | 0   |
| 2068 | 0  | 0  | 0  | 0    | 0  | 0  | 0  | 0  | 0  | 0  | 0   | 0  | 0   |
| 2069 | 0  | 0  | 0  | 0    | 0  | 0  | 0  | 0  | 0  | 0  | 0   | 0  | 0   |
| 2070 | 0  | 0  | 0  | 0    | 0  | 0  | 0  | 0  | 0  | 0  | 0   | 0  | 0   |
| 2071 | 0  | 0  | 0  | 0    | 0  | 0  | 0  | 0  | 0  | 0  | 0   | 0  | 0   |
| 2072 | 0  | 0  | 0  | 0    | 0  | 0  | 0  | 0  | 0  | 0  | 0   | 0  | 0   |
| 2073 | 0  | 0  | 0  | 0    | 0  | 0  | 0  | 0  | 0  | 0  | 0   | 0  | 0   |
| 2074 | 0  | 0  | 0  | 0    | 0  | 0  | 0  | 0  | 0  | 0  | 0   | 0  | 0   |
| 2075 | 0  | 0  | 0  | 0    | 0  | 0  | 0  | 0  | 0  | 0  | 0   | 0  | 0   |
| 2076 | 0  | 0  | 0  | 0    | 0  | 0  | 0  | 0  | 0  | 0  | 0   | 0  | 0   |
| 2077 | 0  | 0  | 0  | 0    | 0  | 0  | 0  | 0  | 0  | 0  | 0   | 0  | 0   |
| 2078 | 0  | 0  | 0  | 0    | 0  | 0  | 0  | 0  | 0  | 0  | 0   | 0  | 0   |
| 2079 | 0  | 0  | 0  | 0    | 0  | 0  | 0  | 0  | 0  | 0  | 0   | 0  | 0   |
| 2080 | 0  | 0  | 0  | 0    | 0  | 0  | 0  | 0  | 0  | 0  | 0   | 0  | 0   |
| 2081 | 0  | 0  | 0  | 0    | 0  | 0  | 0  | 0  | 0  | 0  | 0   | 0  | 0   |
| 2082 | 0  | 0  | 0  | 0    | 0  | 0  | 0  | 0  | 0  | 0  | 0   | 0  | 0   |
| 2083 | 0  | 0  | 0  | 0    | 0  | 0  | 0  | 0  | 0  | 0  | 0   | 0  | 0   |
| 2084 | 0  | 0  | 0  | 0    | 0  | 0  | 0  | 0  | 0  | 0  | 0   | 0  | 0   |
| 2085 | 0  | 0  | 0  | 0    | 0  | 0  | 0  | 0  | 0  | 0  | 0   | 0  | 0   |
| 2086 | 0  | 0  | 0  | 0    | 0  | 0  | 0  | 0  | 0  | 0  | 0   | 0  | 0   |
| 2087 | 0  | 0  | 0  | 0    | 0  | 0  | 0  | 0  | 0  | 0  | 0   | 0  | 0   |
| 2088 | 0  | 0  | 0  | 0    | 0  | 0  | 0  | 0  | 0  | 0  | 0   | 0  | 0   |
| 2089 | 0  | 0  | 0  | 0    | 0  | 0  | 0  | 0  | 0  | 0  | 0   | 0  | 0   |
| 2090 | 0  | 0  | 0  | 0    | 0  | 0  | 0  | 0  | 0  | 0  | 0   | 0  | 0   |

| 12%  | 40   | 41   | 42   | 43   | 44   | 45   | 46   | 47   | 48   | 49   | 50   | 51   | 52   |
|------|------|------|------|------|------|------|------|------|------|------|------|------|------|
| 2002 | 0    | 0    | 0    | 0    | 0    | 0    | 0    | 0    | 0    | 0    | 0    | 0    | 0    |
| 2003 | 0    | 0    | 0    | 0    | 0    | 0    | 0    | 0    | 0    | 0    | 0    | 0    | 0    |
| 2004 | 0    | 0    | 0    | 0    | 0    | 0    | 0    | 0    | 0    | 0    | 0    | 0    | 0    |
| 2005 | 0    | 0    | 0    | 0    | 0    | 0    | 0    | 0    | 0    | 0    | 0    | 0    | 0    |
| 2006 | 0    | 0    | 0    | 0    | 0    | 0    | 0    | 0    | 0    | 0    | 0    | 0    | 0    |
| 2007 | 0    | 0    | 0    | 0    | 0    | 0    | 0    | 0    | 0    | 0    | 0    | 0    | 0    |
| 2008 | 0    | 0    | 0    | 0    | 0    | 0    | 0    | 0    | 0    | 0    | 0    | 0    | 0    |
| 2009 | 0    | 0    | 0    | 0    | 0    | 0    | 0    | 0    | 0    | 0    | 0    | 0    | 0    |
| 2010 | 0    | 0    | 0    | 0    | 0    | 0    | 0    | 0    | 0    | 0    | 0    | 0    | 0    |
| 2011 | 0    | 0    | 0    | 0    | 0    | 0    | 0    | 0    | 0    | 0    | 0    | 0    | 0    |
| 2012 | 0    | 0    | 0    | 0    | 0    | 0    | 0    | 0    | 0    | 0    | 0    | 0    | 0    |
| 2013 | 0    | 0    | 0    | 0    | 0    | 0    | 0    | 0    | 0    | 0    | 0    | 0    | 0    |
| 2014 | 0    | 0    | 0    | 0    | 0    | 0    | 0    | 0    | 0    | 0    | 0    | 0    | 0    |
| 2015 | 0    | 0    | 0    | 0    | 0    | 0    | 0    | 0    | 0    | 0    | 0    | 0    | 0    |
| 2016 | 0    | 0    | 0    | 0    | 0    | 0    | 0    | 0    | 0    | 0    | 0    | 0    | 0    |
| 2017 | 0    | 0    | 0    | 0    | 0    | 0    | 0    | 0    | 0    | 0    | 0    | 0    | 0    |
| 2018 | 0    | 0    | 0    | 0    | 0    | 0    | 0    | 0    | 0    | 0    | 0    | 0    | 0    |
| 2019 | 0    | 0    | 0    | 0    | 0    | 0    | 0    | 0    | 0    | 0    | 0    | 0    | 0    |
| 2020 | 351  | 0    | 0    | 0    | 0    | 0    | 0    | 0    | 0    | 39   | 0    | 0    | 0    |
| 2021 | 520  | 0    | 0    | 0    | 0    | 0    | 0    | 0    | 0    | 172  | 0    | 0    | 0    |
| 2022 | 413  | 0    | 0    | 0    | 0    | 0    | 0    | 0    | 0    | 141  | 0    | 0    | 0    |
| 2023 | 837  | 0    | 0    | 0    | 0    | 0    | 0    | 0    | 0    | 411  | 0    | 0    | 0    |
| 2024 | 1025 | 0    | 0    | 0    | 0    | 0    | 0    | 0    | 0    | 423  | 0    | 0    | 0    |
| 2025 | 935  | 250  | 679  | 952  | 16   | 277  | 66   | 66   | 0    | 482  | 47   | 246  | 250  |
| 2026 | 1277 | 504  | 1414 | 1219 | 141  | 634  | 392  | 349  | 0    | 843  | 200  | 912  | 614  |
| 2027 | 1186 | 701  | 1351 | 1211 | 200  | 555  | 325  | 231  | 0    | 804  | 149  | 634  | 634  |
| 2028 | 1582 | 653  | 1155 | 1266 | 443  | 782  | 380  | 337  | 0    | 820  | 274  | 1163 | 602  |
| 2029 | 1507 | 999  | 1437 | 1619 | 894  | 1109 | 415  | 430  | 0    | 544  | 412  | 1234 | 614  |
| 2030 | 1983 | 1252 | 1135 | 1474 | 655  | 1053 | 768  | 748  | 39   | 622  | 451  | 1156 | 1045 |
| 2031 | 2187 | 1162 | 1213 | 1474 | 772  | 1233 | 721  | 544  | 305  | 1078 | 266  | 1187 | 931  |
| 2032 | 1872 | 1320 | 934  | 2111 | 1397 | 1830 | 937  | 391  | 344  | 901  | 875  | 1147 | 1005 |
| 2033 | 1657 | 1181 | 1402 | 1784 | 1176 | 1527 | 1039 | 504  | 670  | 1899 | 737  | 920  | 1229 |
| 2034 | 1685 | 1358 | 1162 | 1862 | 1133 | 1492 | 1043 | 606  | 575  | 1086 | 866  | 1068 | 942  |
| 2035 | 1142 | 1275 | 1273 | 1859 | 1141 | 1597 | 1243 | 677  | 827  | 1322 | 898  | 1249 | 1224 |
| 2036 | 1163 | 1736 | 2046 | 2295 | 1757 | 2100 | 1353 | 1211 | 709  | 1247 | 725  | 2129 | 1567 |
| 2037 | 947  | 1634 | 1735 | 1660 | 1133 | 1457 | 1341 | 728  | 1297 | 972  | 1015 | 1324 | 1531 |
| 2038 | 1292 | 896  | 1343 | 1326 | 765  | 1158 | 2008 | 990  | 1077 | 1169 | 1023 | 1250 | 1936 |
| 2039 | 778  | 970  | 1586 | 1271 | 710  | 1115 | 2060 | 892  | 1254 | 1188 | 1271 | 999  | 1625 |
| 2040 | 445  | 719  | 1469 | 1487 | 851  | 1315 | 1298 | 822  | 1179 | 1420 | 556  | 1457 | 1233 |
| 2041 | 577  | 1394 | 935  | 1447 | 862  | 1182 | 1306 | 1031 | 1152 | 732  | 937  | 884  | 1483 |
| 2042 | 768  | 1896 | 1200 | 1271 | 787  | 1123 | 1157 | 492  | 685  | 653  | 804  | 1051 | 1487 |
| 2043 | 1031 | 1300 | 847  | 1094 | 685  | 985  | 1526 | 472  | 1167 | 421  | 855  | 1010 | 1366 |
| 2044 | 733  | 1217 | 558  | 1139 | 834  | 1072 | 1825 | 484  | 1238 | 274  | 745  | 781  | 1362 |
| 2045 | 517  | 942  | 707  | 958  | 704  | 876  | 1117 | 476  | 842  | 2116 | 383  | 1049 | 934  |
| 2046 | 446  | 896  | 900  | 837  | 560  | 727  | 1130 | 516  | 684  | 3972 | 816  | 888  | 896  |
| 2047 | 451  | 568  | 1260 | 899  | 560  | 786  | 2658 | 766  | 254  | 3914 | 1615 | 1254 | 1250 |
| 2048 | 271  | 803  | 1180 | 729  | 565  | 639  | 4146 | 1083 | 1281 | 2858 | 2541 | 2435 | 2337 |
| 2049 | 4176 | 2219 | 2651 | 788  | 788  | 788  | 3989 | 1291 | 1767 | 1535 | 2114 | 2714 | 2427 |
| 2050 | 4111 | 2153 | 2675 | 2400 | 2400 | 2400 | 4033 | 1142 | 2065 | 699  | 1921 | 2750 | 2306 |
| 2051 | 2501 | 2405 | 3037 | 2675 | 2675 | 2675 | 4484 | 1378 | 1933 | 463  | 2726 | 2770 | 2789 |
| 2052 | 946  | 2828 | 2687 | 2852 | 2852 | 2852 | 4987 | 1566 | 1760 | 0    | 2711 | 2597 | 2907 |
| 2053 | 691  | 2919 | 2264 | 2668 | 2668 | 2668 | 3534 | 1406 | 2050 | 236  | 2746 | 1531 | 2390 |
| 2054 | 471  | 2547 | 1338 | 2613 | 2613 | 2613 | 2203 | 882  | 2200 | 0    | 1934 | 1020 | 1645 |
| 2055 | 287  | 1468 | 761  | 1590 | 1590 | 1590 | 1269 | 627  | 2184 | 0    | 1350 | 577  | 836  |
| 2056 | 0    | 836  | 557  | 1028 | 1028 | 1028 | 821  | 302  | 2553 | 0    | 950  | 251  | 577  |
| 2057 | 0    | 577  | 188  | 687  | 687  | 687  | 397  | 365  | 2482 | 0    | 577  | 247  | 306  |
| 2058 | 0    | 314  | 181  | 188  | 188  | 188  | 0    | 137  | 2117 | 0    | 369  | 0    | 0    |
| 2059 | 0    | 0    | 0    | 0    | 0    | 0    | 0    | 0    | 1353 | 0    | 0    | 59   | 185  |

| 12%  | 40 | 41  | 42 | 43 | 44 | 45 | 46 | 47 | 48  | 49 | 50 | 51 | 52 |
|------|----|-----|----|----|----|----|----|----|-----|----|----|----|----|
| 2060 | 0  | 126 | 0  | 0  | 0  | 0  | 0  | 0  | 835 | 0  | 0  | 0  | 0  |
| 2061 | 0  | 0   | 0  | 0  | 0  | 0  | 0  | 0  | 620 | 0  | 0  | 0  | 0  |
| 2062 | 0  | 0   | 0  | 0  | 0  | 0  | 0  | 0  | 498 | 0  | 0  | 0  | 0  |
| 2063 | 0  | 0   | 0  | 0  | 0  | 0  | 0  | 0  | 530 | 0  | 0  | 0  | 0  |
| 2064 | 0  | 0   | 0  | 0  | 0  | 0  | 0  | 0  | 341 | 0  | 0  | 0  | 0  |
| 2065 | 0  | 0   | 0  | 0  | 0  | 0  | 0  | 0  | 122 | 0  | 0  | 0  | 0  |
| 2066 | 0  | 0   | 0  | 0  | 0  | 0  | 0  | 0  | 0   | 0  | 0  | 0  | 0  |
| 2067 | 0  | 0   | 0  | 0  | 0  | 0  | 0  | 0  | 118 | 0  | 0  | 0  | 0  |
| 2068 | 0  | 0   | 0  | 0  | 0  | 0  | 0  | 0  | 0   | 0  | 0  | 0  | 0  |
| 2069 | 0  | 0   | 0  | 0  | 0  | 0  | 0  | 0  | 0   | 0  | 0  | 0  | 0  |
| 2070 | 0  | 0   | 0  | 0  | 0  | 0  | 0  | 0  | 0   | 0  | 0  | 0  | 0  |
| 2071 | 0  | 0   | 0  | 0  | 0  | 0  | 0  | 0  | 0   | 0  | 0  | 0  | 0  |
| 2072 | 0  | 0   | 0  | 0  | 0  | 0  | 0  | 0  | 0   | 0  | 0  | 0  | 0  |
| 2073 | 0  | 0   | 0  | 0  | 0  | 0  | 0  | 0  | 0   | 0  | 0  | 0  | 0  |
| 2074 | 0  | 0   | 0  | 0  | 0  | 0  | 0  | 0  | 0   | 0  | 0  | 0  | 0  |
| 2075 | 0  | 0   | 0  | 0  | 0  | 0  | 0  | 0  | 0   | 0  | 0  | 0  | 0  |
| 2076 | 0  | 0   | 0  | 0  | 0  | 0  | 0  | 0  | 0   | 0  | 0  | 0  | 0  |
| 2077 | 0  | 0   | 0  | 0  | 0  | 0  | 0  | 0  | 0   | 0  | 0  | 0  | 0  |
| 2078 | 0  | 0   | 0  | 0  | 0  | 0  | 0  | 0  | 0   | 0  | 0  | 0  | 0  |
| 2079 | 0  | 0   | 0  | 0  | 0  | 0  | 0  | 0  | 0   | 0  | 0  | 0  | 0  |
| 2080 | 0  | 0   | 0  | 0  | 0  | 0  | 0  | 0  | 0   | 0  | 0  | 0  | 0  |
| 2081 | 0  | 0   | 0  | 0  | 0  | 0  | 0  | 0  | 0   | 0  | 0  | 0  | 0  |
| 2082 | 0  | 0   | 0  | 0  | 0  | 0  | 0  | 0  | 0   | 0  | 0  | 0  | 0  |
| 2083 | 0  | 0   | 0  | 0  | 0  | 0  | 0  | 0  | 0   | 0  | 0  | 0  | 0  |
| 2084 | 0  | 0   | 0  | 0  | 0  | 0  | 0  | 0  | 0   | 0  | 0  | 0  | 0  |
| 2085 | 0  | 0   | 0  | 0  | 0  | 0  | 0  | 0  | 0   | 0  | 0  | 0  | 0  |
| 2086 | 0  | 0   | 0  | 0  | 0  | 0  | 0  | 0  | 0   | 0  | 0  | 0  | 0  |
| 2087 | 0  | 0   | 0  | 0  | 0  | 0  | 0  | 0  | 0   | 0  | 0  | 0  | 0  |
| 2088 | 0  | 0   | 0  | 0  | 0  | 0  | 0  | 0  | 0   | 0  | 0  | 0  | 0  |
| 2089 | 0  | 0   | 0  | 0  | 0  | 0  | 0  | 0  | 0   | 0  | 0  | 0  | 0  |
| 2090 | 0  | 0   | 0  | 0  | 0  | 0  | 0  | 0  | 0   | 0  | 0  | 0  | 0  |

| 12%  | 53   | 54   | 55   | 56   | 57   | 58   | 59   | 60   | 61   | 62   | 63   | 64   | 65   |
|------|------|------|------|------|------|------|------|------|------|------|------|------|------|
| 2002 | 0    | 0    | 0    | 0    | 0    | 0    | 0    | 0    | 0    | 0    | 0    | 0    | 0    |
| 2003 | 0    | 0    | 0    | 0    | 0    | 0    | 0    | 0    | 0    | 0    | 0    | 0    | 0    |
| 2004 | 0    | 0    | 0    | 0    | 0    | 0    | 0    | 0    | 0    | 0    | 0    | 0    | 0    |
| 2005 | 0    | 0    | 0    | 0    | 0    | 0    | 0    | 0    | 0    | 0    | 0    | 0    | 0    |
| 2006 | 0    | 0    | 0    | 0    | 0    | 0    | 0    | 0    | 0    | 0    | 0    | 0    | 0    |
| 2007 | 0    | 0    | 0    | 0    | 0    | 0    | 0    | 0    | 0    | 0    | 0    | 0    | 0    |
| 2008 | 0    | 0    | 0    | 0    | 0    | 0    | 0    | 0    | 0    | 0    | 0    | 0    | 0    |
| 2009 | 0    | 0    | 0    | 0    | 0    | 0    | 0    | 0    | 0    | 0    | 0    | 0    | 0    |
| 2010 | 0    | 0    | 0    | 0    | 0    | 0    | 0    | 0    | 0    | 0    | 0    | 0    | 0    |
| 2011 | 0    | 0    | 0    | 0    | 0    | 0    | 0    | 0    | 0    | 0    | 0    | 0    | 0    |
| 2012 | 0    | 0    | 0    | 0    | 0    | 0    | 0    | 0    | 0    | 0    | 0    | 0    | 0    |
| 2013 | 0    | 0    | 0    | 0    | 0    | 0    | 0    | 0    | 0    | 0    | 0    | 0    | 0    |
| 2014 | 0    | 0    | 0    | 0    | 0    | 0    | 0    | 0    | 0    | 0    | 0    | 0    | 0    |
| 2015 | 0    | 0    | 0    | 0    | 0    | 0    | 0    | 0    | 0    | 0    | 0    | 0    | 0    |
| 2016 | 0    | 0    | 0    | 0    | 0    | 0    | 0    | 0    | 0    | 0    | 0    | 0    | 0    |
| 2017 | 0    | 0    | 0    | 0    | 0    | 0    | 0    | 0    | 0    | 0    | 0    | 0    | 0    |
| 2018 | 0    | 0    | 0    | 0    | 0    | 0    | 0    | 0    | 0    | 0    | 0    | 0    | 0    |
| 2019 | 0    | 0    | 0    | 0    | 0    | 0    | 0    | 0    | 0    | 0    | 0    | 0    | 0    |
| 2020 | 0    | 0    | 0    | 0    | 0    | 991  | 0    | 0    | 0    | 0    | 0    | 0    | 0    |
| 2021 | 0    | 0    | 0    | 0    | 0    | 2055 | 0    | 0    | 0    | 0    | 0    | 0    | 0    |
| 2022 | 0    | 0    | 0    | 0    | 0    | 2922 | 0    | 0    | 0    | 0    | 0    | 0    | 0    |
| 2023 | 0    | 0    | 0    | 0    | 0    | 2044 | 0    | 0    | 0    | 0    | 0    | 0    | 0    |
| 2024 | 0    | 0    | 0    | 0    | 0    | 2597 | 0    | 0    | 0    | 0    | 0    | 0    | 0    |
| 2025 | 4    | 66   | 998  | 998  | 0    | 1682 | 998  | 998  | 998  | 998  | 998  | 277  | 277  |
| 2026 | 110  | 392  | 1698 | 1022 | 0    | 1979 | 1022 | 1022 | 1022 | 1022 | 1022 | 2349 | 831  |
| 2027 | 130  | 333  | 2529 | 1221 | 0    | 2299 | 1531 | 1531 | 1531 | 1531 | 1531 | 3324 | 768  |
| 2028 | 231  | 396  | 2955 | 1300 | 0    | 2779 | 1202 | 1202 | 1202 | 1202 | 1202 | 4078 | 823  |
| 2029 | 282  | 430  | 3517 | 1193 | 0    | 1600 | 2274 | 2274 | 2274 | 2274 | 2274 | 3309 | 1665 |
| 2030 | 608  | 803  | 3521 | 1637 | 998  | 1760 | 2498 | 2498 | 2498 | 2498 | 2498 | 2668 | 1366 |
| 2031 | 451  | 654  | 2818 | 1147 | 1061 | 1646 | 1862 | 1862 | 1862 | 1862 | 1862 | 2502 | 1499 |
| 2032 | 447  | 650  | 3333 | 1740 | 1154 | 1571 | 2566 | 2566 | 2566 | 2566 | 2566 | 1901 | 957  |
| 2033 | 753  | 968  | 3470 | 1728 | 1613 | 1523 | 2802 | 2802 | 2802 | 2798 | 2802 | 2400 | 1063 |
| 2034 | 678  | 673  | 2523 | 2090 | 1657 | 1799 | 2271 | 2271 | 2271 | 2244 | 2271 | 1657 | 1306 |
| 2035 | 749  | 834  | 2138 | 1073 | 1706 | 1438 | 1772 | 1768 | 1772 | 1717 | 1772 | 1358 | 1106 |
| 2036 | 1216 | 1357 | 1740 | 1523 | 1668 | 2402 | 1908 | 2207 | 1908 | 1823 | 1908 | 1673 | 1397 |
| 2037 | 1012 | 1211 | 1983 | 1115 | 2820 | 1082 | 1282 | 1438 | 1286 | 1180 | 1286 | 1469 | 1280 |
| 2038 | 1570 | 1733 | 1564 | 1551 | 2971 | 846  | 1567 | 1778 | 1575 | 1278 | 1575 | 1308 | 1060 |
| 2039 | 1212 | 1360 | 2160 | 1539 | 2546 | 2016 | 1928 | 1587 | 1924 | 1593 | 1924 | 1147 | 730  |
| 2040 | 812  | 948  | 2229 | 1526 | 2299 | 1027 | 1523 | 1437 | 1742 | 1309 | 1742 | 1059 | 741  |
| 2041 | 976  | 1070 | 1977 | 1456 | 2012 | 1231 | 1466 | 1400 | 1470 | 1096 | 1439 | 1218 | 985  |
| 2042 | 832  | 1015 | 1595 | 1096 | 1348 | 517  | 1049 | 1457 | 1484 | 1176 | 1461 | 1331 | 922  |
| 2043 | 933  | 1054 | 1740 | 1564 | 1481 | 804  | 1299 | 1365 | 1724 | 1392 | 1650 | 1257 | 640  |
| 2044 | 871  | 1015 | 1424 | 1127 | 1422 | 2154 | 1092 | 905  | 1200 | 1028 | 1184 | 1151 | 730  |
| 2045 | 423  | 676  | 872  | 94   | 1955 | 3166 | 482  | 156  | 435  | 435  | 435  | 747  | 759  |
| 2046 | 592  | 713  | 3845 | 1109 | 2061 | 2640 | 2457 | 2410 | 2100 | 2100 | 2100 | 520  | 453  |
| 2047 | 1250 | 1250 | 5125 | 1040 | 1223 | 2200 | 2809 | 2907 | 2557 | 2557 | 2557 | 47   | 78   |
| 2048 | 2337 | 2337 | 5279 | 1563 | 383  | 0    | 2165 | 2479 | 2715 | 2715 | 2715 | 287  | 39   |
| 2049 | 2427 | 2427 | 3701 | 775  | 1188 | 220  | 2905 | 2882 | 3220 | 3220 | 3220 | 2319 | 956  |
| 2050 | 2306 | 2306 | 2695 | 1848 | 1176 | 0    | 3032 | 2915 | 2899 | 2899 | 2899 | 5289 | 850  |
| 2051 | 2789 | 2789 | 1595 | 2399 | 3849 | 0    | 2530 | 2530 | 1870 | 1870 | 1870 | 6453 | 1275 |
| 2052 | 2907 | 2907 | 715  | 440  | 1069 | 0    | 715  | 440  | 715  | 715  | 715  | 4015 | 1639 |
| 2053 | 2390 | 2390 | 110  | 220  | 1319 | 0    | 110  | 330  | 110  | 110  | 110  | 1705 | 878  |
| 2054 | 1645 | 1645 | 0    | 275  | 1281 | 0    | 440  | 55   | 110  | 110  | 110  | 1210 | 486  |
| 2055 | 836  | 836  | 0    | 110  | 2410 | 0    | 0    | 220  | 0    | 0    | 0    | 880  | 726  |
| 2056 | 577  | 577  | 0    | 165  | 2462 | 0    | 0    | 0    | 110  | 110  | 110  | 385  | 416  |
| 2057 | 306  | 306  | 0    | 0    | 2436 | 0    | 0    | 0    | 0    | 0    | 0    | 330  | 330  |
| 2058 | 0    | 0    | 0    | 0    | 1705 | 0    | 0    | 0    | 0    | 0    | 0    | 0    | 0    |
| 2059 | 184  | 185  | 0    | 0    | 440  | 0    | 0    | 0    | 0    | 0    | 0    | 0    | 0    |

| 12%  | 53 | 54 | 55 | 56 | 57  | 58 | 59 | 60 | 61 | 62 | 63 | 64 | 65 |
|------|----|----|----|----|-----|----|----|----|----|----|----|----|----|
| 2060 | 0  | 0  | 0  | 0  | 110 | 0  | 0  | 0  | 0  | 0  | 0  | 0  | 0  |
| 2061 | 0  | 0  | 0  | 0  | 330 | 0  | 0  | 0  | 0  | 0  | 0  | 0  | 0  |
| 2062 | 0  | 0  | 0  | 0  | 0   | 0  | 0  | 0  | 0  | 0  | 0  | 0  | 0  |
| 2063 | 0  | 0  | 0  | 0  | 0   | 0  | 0  | 0  | 0  | 0  | 0  | 0  | 0  |
| 2064 | 0  | 0  | 0  | 0  | 0   | 0  | 0  | 0  | 0  | 0  | 0  | 0  | 0  |
| 2065 | 0  | 0  | 0  | 0  | 0   | 0  | 0  | 0  | 0  | 0  | 0  | 0  | 0  |
| 2066 | 0  | 0  | 0  | 0  | 0   | 0  | 0  | 0  | 0  | 0  | 0  | 0  | 0  |
| 2067 | 0  | 0  | 0  | 0  | 0   | 0  | 0  | 0  | 0  | 0  | 0  | 0  | 0  |
| 2068 | 0  | 0  | 0  | 0  | 0   | 0  | 0  | 0  | 0  | 0  | 0  | 0  | 0  |
| 2069 | 0  | 0  | 0  | 0  | 0   | 0  | 0  | 0  | 0  | 0  | 0  | 0  | 0  |
| 2070 | 0  | 0  | 0  | 0  | 0   | 0  | 0  | 0  | 0  | 0  | 0  | 0  | 0  |
| 2071 | 0  | 0  | 0  | 0  | 0   | 0  | 0  | 0  | 0  | 0  | 0  | 0  | 0  |
| 2072 | 0  | 0  | 0  | 0  | 0   | 0  | 0  | 0  | 0  | 0  | 0  | 0  | 0  |
| 2073 | 0  | 0  | 0  | 0  | 0   | 0  | 0  | 0  | 0  | 0  | 0  | 0  | 0  |
| 2074 | 0  | 0  | 0  | 0  | 0   | 0  | 0  | 0  | 0  | 0  | 0  | 0  | 0  |
| 2075 | 0  | 0  | 0  | 0  | 0   | 0  | 0  | 0  | 0  | 0  | 0  | 0  | 0  |
| 2076 | 0  | 0  | 0  | 0  | 0   | 0  | 0  | 0  | 0  | 0  | 0  | 0  | 0  |
| 2077 | 0  | 0  | 0  | 0  | 0   | 0  | 0  | 0  | 0  | 0  | 0  | 0  | 0  |
| 2078 | 0  | 0  | 0  | 0  | 0   | 0  | 0  | 0  | 0  | 0  | 0  | 0  | 0  |
| 2079 | 0  | 0  | 0  | 0  | 0   | 0  | 0  | 0  | 0  | 0  | 0  | 0  | 0  |
| 2080 | 0  | 0  | 0  | 0  | 0   | 0  | 0  | 0  | 0  | 0  | 0  | 0  | 0  |
| 2081 | 0  | 0  | 0  | 0  | 0   | 0  | 0  | 0  | 0  | 0  | 0  | 0  | 0  |
| 2082 | 0  | 0  | 0  | 0  | 0   | 0  | 0  | 0  | 0  | 0  | 0  | 0  | 0  |
| 2083 | 0  | 0  | 0  | 0  | 0   | 0  | 0  | 0  | 0  | 0  | 0  | 0  | 0  |
| 2084 | 0  | 0  | 0  | 0  | 0   | 0  | 0  | 0  | 0  | 0  | 0  | 0  | 0  |
| 2085 | 0  | 0  | 0  | 0  | 0   | 0  | 0  | 0  | 0  | 0  | 0  | 0  | 0  |
| 2086 | 0  | 0  | 0  | 0  | 0   | 0  | 0  | 0  | 0  | 0  | 0  | 0  | 0  |
| 2087 | 0  | 0  | 0  | 0  | 0   | 0  | 0  | 0  | 0  | 0  | 0  | 0  | 0  |
| 2088 | 0  | 0  | 0  | 0  | 0   | 0  | 0  | 0  | 0  | 0  | 0  | 0  | 0  |
| 2089 | 0  | 0  | 0  | 0  | 0   | 0  | 0  | 0  | 0  | 0  | 0  | 0  | 0  |
| 2090 | 0  | 0  | 0  | 0  | 0   | 0  | 0  | 0  | 0  | 0  | 0  | 0  | 0  |

| 12%  | 66   | 67   | 68   | 69   | 70   | 71   | 72   | 73   | 74   | 75   | 76   | 77   | 78   |
|------|------|------|------|------|------|------|------|------|------|------|------|------|------|
| 2002 | 0    | 0    | 0    | 0    | 0    | 0    | 0    | 0    | 0    | 0    | 0    | 0    | 0    |
| 2003 | 0    | 0    | 0    | 0    | 0    | 0    | 0    | 0    | 0    | 0    | 0    | 0    | 0    |
| 2004 | 0    | 0    | 0    | 0    | 0    | 0    | 0    | 0    | 0    | 0    | 0    | 0    | 0    |
| 2005 | 0    | 0    | 0    | 0    | 0    | 0    | 0    | 0    | 0    | 0    | 0    | 0    | 0    |
| 2006 | 0    | 0    | 0    | 0    | 0    | 0    | 0    | 0    | 0    | 0    | 0    | 0    | 0    |
| 2007 | 0    | 0    | 0    | 0    | 0    | 0    | 0    | 0    | 0    | 0    | 0    | 0    | 0    |
| 2008 | 0    | 0    | 0    | 0    | 0    | 0    | 0    | 0    | 0    | 0    | 0    | 0    | 0    |
| 2009 | 0    | 0    | 0    | 0    | 0    | 0    | 0    | 0    | 0    | 0    | 0    | 0    | 0    |
| 2010 | 0    | 0    | 0    | 0    | 0    | 0    | 0    | 0    | 0    | 0    | 0    | 0    | 0    |
| 2011 | 0    | 0    | 0    | 0    | 0    | 0    | 0    | 0    | 0    | 0    | 0    | 0    | 0    |
| 2012 | 0    | 0    | 0    | 0    | 0    | 0    | 0    | 0    | 0    | 0    | 0    | 0    | 0    |
| 2013 | 0    | 0    | 0    | 0    | 0    | 0    | 0    | 0    | 0    | 0    | 0    | 0    | 0    |
| 2014 | 0    | 0    | 0    | 0    | 0    | 0    | 0    | 0    | 0    | 0    | 0    | 0    | 0    |
| 2015 | 0    | 0    | 0    | 0    | 0    | 0    | 0    | 0    | 0    | 0    | 0    | 0    | 0    |
| 2016 | 0    | 0    | 0    | 0    | 0    | 0    | 0    | 0    | 0    | 0    | 0    | 0    | 0    |
| 2017 | 0    | 0    | 0    | 0    | 0    | 0    | 0    | 0    | 0    | 0    | 0    | 0    | 0    |
| 2018 | 0    | 0    | 0    | 0    | 0    | 0    | 0    | 0    | 0    | 0    | 0    | 0    | 0    |
| 2019 | 0    | 0    | 0    | 0    | 0    | 0    | 0    | 0    | 0    | 0    | 0    | 0    | 0    |
| 2020 | 0    | 351  | 0    | 0    | 0    | 0    | 0    | 0    | 0    | 0    | 39   | 0    | 0    |
| 2021 | 0    | 3394 | 0    | 0    | 0    | 0    | 0    | 0    | 0    | 0    | 2408 | 0    | 0    |
| 2022 | 0    | 3009 | 0    | 0    | 0    | 0    | 0    | 0    | 0    | 0    | 2619 | 0    | 0    |
| 2023 | 0    | 2338 | 0    | 0    | 0    | 0    | 0    | 0    | 0    | 0    | 2021 | 0    | 0    |
| 2024 | 0    | 2078 | 0    | 0    | 0    | 0    | 0    | 0    | 0    | 0    | 1806 | 0    | 0    |
| 2025 | 0    | 1030 | 250  | 679  | 952  | 16   | 277  | 66   | 66   | 0    | 761  | 47   | 246  |
| 2026 | 0    | 1190 | 734  | 1124 | 1381 | 43   | 862  | 1732 | 573  | 0    | 1028 | 293  | 886  |
| 2027 | 0    | 1492 | 1575 | 1992 | 2285 | 840  | 1657 | 2804 | 488  | 0    | 965  | 1177 | 1645 |
| 2028 | 0    | 1079 | 1897 | 2287 | 2587 | 1366 | 2045 | 3888 | 476  | 0    | 658  | 1593 | 2221 |
| 2029 | 0    | 1625 | 2754 | 3306 | 3359 | 2195 | 2848 | 3165 | 1415 | 0    | 1149 | 2761 | 3138 |
| 2030 | 257  | 1550 | 2514 | 2305 | 2919 | 2124 | 2436 | 2453 | 1132 | 39   | 1270 | 1825 | 2181 |
| 2031 | 956  | 808  | 1484 | 1390 | 1811 | 1075 | 1503 | 2190 | 1070 | 706  | 430  | 1016 | 1359 |
| 2032 | 924  | 1605 | 1095 | 1382 | 1819 | 1016 | 1468 | 1538 | 641  | 710  | 881  | 933  | 1222 |
| 2033 | 1200 | 1017 | 1923 | 2050 | 2346 | 1648 | 2081 | 1809 | 692  | 919  | 434  | 1428 | 1828 |
| 2034 | 1706 | 1786 | 1578 | 1716 | 2149 | 1279 | 1735 | 1243 | 684  | 1351 | 1116 | 855  | 1583 |
| 2035 | 3393 | 1052 | 1393 | 938  | 1457 | 706  | 1091 | 1047 | 1003 | 3096 | 662  | 894  | 798  |
| 2036 | 2391 | 856  | 1916 | 1747 | 1923 | 1353 | 1696 | 1334 | 1066 | 2142 | 960  | 1134 | 1529 |
| 2037 | 2077 | 569  | 1249 | 1216 | 1302 | 752  | 1142 | 665  | 669  | 1831 | 662  | 591  | 966  |
| 2038 | 1758 | 550  | 895  | 1098 | 1118 | 611  | 911  | 1329 | 1101 | 1461 | 642  | 867  | 856  |
| 2039 | 1743 | 962  | 723  | 1252 | 980  | 380  | 758  | 1007 | 477  | 1396 | 246  | 647  | 660  |
| 2040 | 1048 | 448  | 915  | 1056 | 1293 | 568  | 1071 | 838  | 437  | 755  | 308  | 537  | 985  |
| 2041 | 1561 | 507  | 1343 | 985  | 1526 | 992  | 1253 | 882  | 700  | 1265 | 814  | 584  | 1307 |
| 2042 | 1424 | 1016 | 1192 | 1343 | 1305 | 631  | 1021 | 1419 | 786  | 1089 | 985  | 960  | 1122 |
| 2043 | 2336 | 923  | 730  | 1242 | 851  | 360  | 757  | 497  | 296  | 2118 | 588  | 725  | 1300 |
| 2044 | 1527 | 779  | 1097 | 938  | 1335 | 793  | 1167 | 591  | 367  | 1223 | 781  | 332  | 1021 |
| 2045 | 1257 | 165  | 661  | 850  | 1072 | 643  | 857  | 607  | 489  | 878  | 4203 | 156  | 790  |
| 2046 | 726  | 4038 | 382  | 312  | 844  | 474  | 700  | 667  | 82   | 759  | 3288 | 361  | 117  |
| 2047 | 562  | 2973 | 314  | 230  | 105  | 31   | 66   | 3172 | 975  | 265  | 1650 | 1247 | 1580 |
| 2048 | 517  | 1446 | 0    | 1258 | 20   | 20   | 20   | 5619 | 1211 | 412  | 660  | 1958 | 2941 |
| 2049 | 330  | 990  | 1124 | 3440 | 952  | 952  | 952  | 6312 | 1562 | 1360 | 330  | 4313 | 3383 |
| 2050 | 940  | 660  | 1719 | 3372 | 2037 | 2037 | 2037 | 3740 | 1285 | 846  | 0    | 2414 | 1354 |
| 2051 | 1215 | 330  | 4302 | 1162 | 4058 | 4058 | 4058 | 1595 | 906  | 1459 | 0    | 1374 | 1186 |
| 2052 | 1215 | 220  | 2088 | 1379 | 2226 | 2226 | 2226 | 1210 | 486  | 2717 | 0    | 1222 | 1218 |
| 2053 | 2882 | 0    | 1653 | 1210 | 1374 | 1374 | 1374 | 880  | 726  | 3147 | 0    | 990  | 990  |
| 2054 | 2774 | 0    | 1332 | 990  | 1222 | 1222 | 1222 | 385  | 416  | 2249 | 0    | 660  | 660  |
| 2055 | 2327 | 0    | 990  | 660  | 990  | 990  | 990  | 330  | 330  | 1955 | 0    | 330  | 330  |
| 2056 | 2230 | 0    | 660  | 220  | 660  | 660  | 660  | 0    | 0    | 1096 | 0    | 0    | 165  |
| 2057 | 1096 | 0    | 330  | 0    | 330  | 330  | 330  | 0    | 0    | 994  | 0    | 0    | 0    |
| 2058 | 994  | 0    | 165  | 0    | 165  | 165  | 165  | 0    | 0    | 660  | 0    | 0    | 0    |
| 2059 | 660  | 0    | 0    | 0    | 0    | 0    | 0    | 0    | 0    | 330  | 0    | 0    | 0    |

| 12%  | 66  | 67 | 68 | 69 | 70 | 71 | 72 | 73 | 74 | 75  | 76 | 77 | 78 |
|------|-----|----|----|----|----|----|----|----|----|-----|----|----|----|
| 2060 | 330 | 0  | 0  | 0  | 0  | 0  | 0  | 0  | 0  | 330 | 0  | 0  | 0  |
| 2061 | 330 | 0  | 0  | 0  | 0  | 0  | 0  | 0  | 0  | 165 | 0  | 0  | 0  |
| 2062 | 165 | 0  | 0  | 0  | 0  | 0  | 0  | 0  | 0  | 0   | 0  | 0  | 0  |
| 2063 | 0   | 0  | 0  | 0  | 0  | 0  | 0  | 0  | 0  | 0   | 0  | 0  | 0  |
| 2064 | 0   | 0  | 0  | 0  | 0  | 0  | 0  | 0  | 0  | 0   | 0  | 0  | 0  |
| 2065 | 0   | 0  | 0  | 0  | 0  | 0  | 0  | 0  | 0  | 0   | 0  | 0  | 0  |
| 2066 | 0   | 0  | 0  | 0  | 0  | 0  | 0  | 0  | 0  | 0   | 0  | 0  | 0  |
| 2067 | 0   | 0  | 0  | 0  | 0  | 0  | 0  | 0  | 0  | 0   | 0  | 0  | 0  |
| 2068 | 0   | 0  | 0  | 0  | 0  | 0  | 0  | 0  | 0  | 0   | 0  | 0  | 0  |
| 2069 | 0   | 0  | 0  | 0  | 0  | 0  | 0  | 0  | 0  | 0   | 0  | 0  | 0  |
| 2070 | 0   | 0  | 0  | 0  | 0  | 0  | 0  | 0  | 0  | 0   | 0  | 0  | 0  |
| 2071 | 0   | 0  | 0  | 0  | 0  | 0  | 0  | 0  | 0  | 0   | 0  | 0  | 0  |
| 2072 | 0   | 0  | 0  | 0  | 0  | 0  | 0  | 0  | 0  | 0   | 0  | 0  | 0  |
| 2073 | 0   | 0  | 0  | 0  | 0  | 0  | 0  | 0  | 0  | 0   | 0  | 0  | 0  |
| 2074 | 0   | 0  | 0  | 0  | 0  | 0  | 0  | 0  | 0  | 0   | 0  | 0  | 0  |
| 2075 | 0   | 0  | 0  | 0  | 0  | 0  | 0  | 0  | 0  | 0   | 0  | 0  | 0  |
| 2076 | 0   | 0  | 0  | 0  | 0  | 0  | 0  | 0  | 0  | 0   | 0  | 0  | 0  |
| 2077 | 0   | 0  | 0  | 0  | 0  | 0  | 0  | 0  | 0  | 0   | 0  | 0  | 0  |
| 2078 | 0   | 0  | 0  | 0  | 0  | 0  | 0  | 0  | 0  | 0   | 0  | 0  | 0  |
| 2079 | 0   | 0  | 0  | 0  | 0  | 0  | 0  | 0  | 0  | 0   | 0  | 0  | 0  |
| 2080 | 0   | 0  | 0  | 0  | 0  | 0  | 0  | 0  | 0  | 0   | 0  | 0  | 0  |
| 2081 | 0   | 0  | 0  | 0  | 0  | 0  | 0  | 0  | 0  | 0   | 0  | 0  | 0  |
| 2082 | 0   | 0  | 0  | 0  | 0  | 0  | 0  | 0  | 0  | 0   | 0  | 0  | 0  |
| 2083 | 0   | 0  | 0  | 0  | 0  | 0  | 0  | 0  | 0  | 0   | 0  | 0  | 0  |
| 2084 | 0   | 0  | 0  | 0  | 0  | 0  | 0  | 0  | 0  | 0   | 0  | 0  | 0  |
| 2085 | 0   | 0  | 0  | 0  | 0  | 0  | 0  | 0  | 0  | 0   | 0  | 0  | 0  |
| 2086 | 0   | 0  | 0  | 0  | 0  | 0  | 0  | 0  | 0  | 0   | 0  | 0  | 0  |
| 2087 | 0   | 0  | 0  | 0  | 0  | 0  | 0  | 0  | 0  | 0   | 0  | 0  | 0  |
| 2088 | 0   | 0  | 0  | 0  | 0  | 0  | 0  | 0  | 0  | 0   | 0  | 0  | 0  |
| 2089 | 0   | 0  | 0  | 0  | 0  | 0  | 0  | 0  | 0  | 0   | 0  | 0  | 0  |
| 2090 | 0   | 0  | 0  | 0  | 0  | 0  | 0  | 0  | 0  | 0   | 0  | 0  | 0  |



| 12%  | 79   | 80   | 81   | 82   | 83   | 84   | 85   | 86   | 87   | 88   | 89   | 90   | 91   |
|------|------|------|------|------|------|------|------|------|------|------|------|------|------|
| 2002 | 0    | 0    | 0    | 0    | 0    | 0    | 0    | 0    | 0    | 0    | 0    | 0    | 0    |
| 2003 | 0    | 0    | 0    | 0    | 0    | 0    | 0    | 0    | 0    | 0    | 0    | 0    | 0    |
| 2004 | 0    | 0    | 0    | 0    | 0    | 0    | 0    | 0    | 0    | 0    | 0    | 0    | 0    |
| 2005 | 0    | 0    | 0    | 0    | 0    | 0    | 0    | 0    | 0    | 0    | 0    | 0    | 0    |
| 2006 | 0    | 0    | 0    | 0    | 0    | 0    | 0    | 0    | 0    | 0    | 0    | 0    | 0    |
| 2007 | 0    | 0    | 0    | 0    | 0    | 0    | 0    | 0    | 0    | 0    | 0    | 0    | 0    |
| 2008 | 0    | 0    | 0    | 0    | 0    | 0    | 0    | 0    | 0    | 0    | 0    | 0    | 0    |
| 2009 | 0    | 0    | 0    | 0    | 0    | 0    | 0    | 0    | 0    | 0    | 0    | 0    | 0    |
| 2010 | 0    | 0    | 0    | 0    | 0    | 0    | 0    | 0    | 0    | 0    | 0    | 0    | 0    |
| 2011 | 0    | 0    | 0    | 0    | 0    | 0    | 0    | 0    | 0    | 0    | 0    | 0    | 0    |
| 2012 | 0    | 0    | 0    | 0    | 0    | 0    | 0    | 0    | 0    | 0    | 0    | 0    | 0    |
| 2013 | 0    | 0    | 0    | 0    | 0    | 0    | 0    | 0    | 0    | 0    | 0    | 0    | 0    |
| 2014 | 0    | 0    | 0    | 0    | 0    | 0    | 0    | 0    | 0    | 0    | 0    | 0    | 0    |
| 2015 | 0    | 0    | 0    | 0    | 0    | 0    | 0    | 0    | 0    | 0    | 0    | 0    | 0    |
| 2016 | 0    | 0    | 0    | 0    | 0    | 0    | 0    | 0    | 0    | 0    | 0    | 0    | 0    |
| 2017 | 0    | 0    | 0    | 0    | 0    | 0    | 0    | 0    | 0    | 0    | 0    | 0    | 0    |
| 2018 | 0    | 0    | 0    | 0    | 0    | 0    | 0    | 0    | 0    | 0    | 0    | 0    | 0    |
| 2019 | 0    | 0    | 0    | 0    | 0    | 0    | 0    | 0    | 0    | 0    | 0    | 0    | 0    |
| 2020 | 0    | 0    | 0    | 0    | 0    | 0    | 991  | 0    | 0    | 0    | 0    | 0    | 0    |
| 2021 | 0    | 0    | 0    | 0    | 0    | 0    | 2189 | 0    | 0    | 0    | 0    | 0    | 0    |
| 2022 | 0    | 0    | 0    | 0    | 0    | 0    | 2739 | 0    | 0    | 0    | 0    | 0    | 0    |
| 2023 | 0    | 0    | 0    | 0    | 0    | 0    | 1985 | 0    | 0    | 0    | 0    | 0    | 0    |
| 2024 | 0    | 0    | 0    | 0    | 0    | 0    | 2637 | 0    | 0    | 0    | 0    | 0    | 0    |
| 2025 | 250  | 4    | 66   | 998  | 998  | 0    | 2169 | 998  | 998  | 998  | 998  | 998  | 277  |
| 2026 | 870  | 0    | 523  | 2237 | 1167 | 0    | 2035 | 1509 | 1509 | 1509 | 1509 | 1509 | 3600 |
| 2027 | 1790 | 444  | 1313 | 3211 | 1465 | 0    | 1882 | 1995 | 1995 | 1995 | 1995 | 1995 | 3383 |
| 2028 | 2123 | 895  | 1699 | 2846 | 1399 | 0    | 2142 | 2028 | 2028 | 2028 | 2028 | 2028 | 3045 |
| 2029 | 2895 | 1701 | 2602 | 3376 | 1484 | 0    | 1713 | 2212 | 2212 | 2212 | 2212 | 2212 | 3183 |
| 2030 | 2436 | 1689 | 2268 | 3218 | 1571 | 998  | 1791 | 2294 | 2294 | 2294 | 2294 | 2294 | 2746 |
| 2031 | 1406 | 1803 | 1102 | 2507 | 1390 | 1352 | 1485 | 1827 | 1827 | 1827 | 1827 | 1827 | 2384 |
| 2032 | 1123 | 789  | 834  | 3125 | 1571 | 1784 | 1376 | 2444 | 2444 | 2444 | 2444 | 2444 | 1803 |
| 2033 | 1748 | 1413 | 1490 | 3172 | 1669 | 2038 | 1551 | 2444 | 2444 | 2444 | 2440 | 2444 | 1830 |
| 2034 | 1731 | 1456 | 1447 | 2676 | 1512 | 2015 | 1912 | 2047 | 2047 | 2047 | 2027 | 2047 | 1865 |
| 2035 | 1385 | 981  | 968  | 1957 | 1375 | 2524 | 1473 | 1662 | 1662 | 1662 | 1627 | 1662 | 1440 |
| 2036 | 1744 | 1311 | 1416 | 1846 | 1366 | 2462 | 2064 | 1461 | 1751 | 1461 | 1398 | 1461 | 1547 |
| 2037 | 1083 | 537  | 677  | 1749 | 1265 | 2404 | 1160 | 1501 | 1308 | 1505 | 1376 | 1505 | 1335 |
| 2038 | 1323 | 1051 | 1050 | 1771 | 1335 | 2067 | 870  | 1370 | 1558 | 1378 | 1179 | 1378 | 1363 |
| 2039 | 875  | 392  | 536  | 1885 | 1452 | 2224 | 1631 | 1590 | 1560 | 1696 | 1368 | 1696 | 1288 |
| 2040 | 1040 | 639  | 724  | 2097 | 1472 | 1682 | 1175 | 1617 | 1751 | 1763 | 1306 | 1763 | 1064 |
| 2041 | 1110 | 568  | 661  | 2147 | 1466 | 1626 | 737  | 1609 | 1358 | 1789 | 1328 | 1757 | 1249 |
| 2042 | 1565 | 878  | 1112 | 1148 | 1002 | 1191 | 913  | 1315 | 1527 | 1037 | 690  | 1002 | 1512 |
| 2043 | 816  | 313  | 453  | 1786 | 1346 | 1485 | 298  | 1190 | 1558 | 1526 | 1218 | 1448 | 1155 |
| 2044 | 753  | 179  | 312  | 2136 | 1456 | 1410 | 4418 | 1692 | 1449 | 1887 | 1544 | 1794 | 943  |
| 2045 | 872  | 506  | 658  | 899  | 270  | 1714 | 2887 | 502  | 357  | 565  | 565  | 565  | 720  |
| 2046 | 215  | 215  | 215  | 5077 | 1836 | 1638 | 2215 | 2965 | 3134 | 3189 | 3189 | 3189 | 669  |
| 2047 | 1235 | 1235 | 1235 | 3966 | 1351 | 1645 | 1913 | 2558 | 2574 | 2613 | 2613 | 2613 | 269  |
| 2048 | 2328 | 2328 | 2328 | 4445 | 1787 | 470  | 118  | 2990 | 2971 | 3041 | 3041 | 3041 | 0    |
| 2049 | 4529 | 4529 | 4529 | 3185 | 1348 | 1939 | 346  | 2394 | 2394 | 2269 | 2269 | 2269 | 5088 |
| 2050 | 1813 | 1813 | 1813 | 2415 | 1110 | 2124 | 0    | 1849 | 1900 | 1837 | 1837 | 1837 | 4853 |
| 2051 | 1547 | 1547 | 1547 | 2133 | 1071 | 2136 | 0    | 1649 | 1598 | 1602 | 1602 | 1602 | 4618 |
| 2052 | 1332 | 1332 | 1332 | 1422 | 643  | 2094 | 0    | 1107 | 985  | 981  | 981  | 981  | 3302 |
| 2053 | 990  | 990  | 990  | 342  | 200  | 2373 | 0    | 538  | 306  | 298  | 298  | 298  | 2089 |
| 2054 | 660  | 660  | 660  | 169  | 122  | 2040 | 0    | 122  | 118  | 118  | 118  | 118  | 1052 |
| 2055 | 0    | 0    | 0    | 287  | 137  | 1895 | 0    | 177  | 240  | 185  | 185  | 185  | 868  |
| 2056 | 0    | 0    | 0    | 0    | 0    | 1561 | 0    | 0    | 0    | 0    | 0    | 0    | 518  |
| 2057 | 0    | 0    | 0    | 0    | 0    | 1413 | 0    | 0    | 0    | 0    | 0    | 0    | 287  |
| 2058 | 0    | 0    | 0    | 0    | 0    | 852  | 0    | 0    | 0    | 0    | 0    | 0    | 228  |
| 2059 | 0    | 0    | 0    | 0    | 0    | 805  | 0    | 0    | 0    | 0    | 0    | 0    | 0    |

| 12%  | 79 | 80 | 81 | 82 | 83 | 84  | 85 | 86 | 87 | 88 | 89 | 90 | 91 |
|------|----|----|----|----|----|-----|----|----|----|----|----|----|----|
| 2060 | 0  | 0  | 0  | 0  | 0  | 130 | 0  | 0  | 0  | 0  | 0  | 0  | 0  |
| 2061 | 0  | 0  | 0  | 0  | 0  | 122 | 0  | 0  | 0  | 0  | 0  | 0  | 0  |
| 2062 | 0  | 0  | 0  | 0  | 0  | 0   | 0  | 0  | 0  | 0  | 0  | 0  | 0  |
| 2063 | 0  | 0  | 0  | 0  | 0  | 0   | 0  | 0  | 0  | 0  | 0  | 0  | 0  |
| 2064 | 0  | 0  | 0  | 0  | 0  | 0   | 0  | 0  | 0  | 0  | 0  | 0  | 0  |
| 2065 | 0  | 0  | 0  | 0  | 0  | 0   | 0  | 0  | 0  | 0  | 0  | 0  | 0  |
| 2066 | 0  | 0  | 0  | 0  | 0  | 0   | 0  | 0  | 0  | 0  | 0  | 0  | 0  |
| 2067 | 0  | 0  | 0  | 0  | 0  | 0   | 0  | 0  | 0  | 0  | 0  | 0  | 0  |
| 2068 | 0  | 0  | 0  | 0  | 0  | 0   | 0  | 0  | 0  | 0  | 0  | 0  | 0  |
| 2069 | 0  | 0  | 0  | 0  | 0  | 0   | 0  | 0  | 0  | 0  | 0  | 0  | 0  |
| 2070 | 0  | 0  | 0  | 0  | 0  | 0   | 0  | 0  | 0  | 0  | 0  | 0  | 0  |
| 2071 | 0  | 0  | 0  | 0  | 0  | 0   | 0  | 0  | 0  | 0  | 0  | 0  | 0  |
| 2072 | 0  | 0  | 0  | 0  | 0  | 0   | 0  | 0  | 0  | 0  | 0  | 0  | 0  |
| 2073 | 0  | 0  | 0  | 0  | 0  | 0   | 0  | 0  | 0  | 0  | 0  | 0  | 0  |
| 2074 | 0  | 0  | 0  | 0  | 0  | 0   | 0  | 0  | 0  | 0  | 0  | 0  | 0  |
| 2075 | 0  | 0  | 0  | 0  | 0  | 0   | 0  | 0  | 0  | 0  | 0  | 0  | 0  |
| 2076 | 0  | 0  | 0  | 0  | 0  | 0   | 0  | 0  | 0  | 0  | 0  | 0  | 0  |
| 2077 | 0  | 0  | 0  | 0  | 0  | 0   | 0  | 0  | 0  | 0  | 0  | 0  | 0  |
| 2078 | 0  | 0  | 0  | 0  | 0  | 0   | 0  | 0  | 0  | 0  | 0  | 0  | 0  |
| 2079 | 0  | 0  | 0  | 0  | 0  | 0   | 0  | 0  | 0  | 0  | 0  | 0  | 0  |
| 2080 | 0  | 0  | 0  | 0  | 0  | 0   | 0  | 0  | 0  | 0  | 0  | 0  | 0  |
| 2081 | 0  | 0  | 0  | 0  | 0  | 0   | 0  | 0  | 0  | 0  | 0  | 0  | 0  |
| 2082 | 0  | 0  | 0  | 0  | 0  | 0   | 0  | 0  | 0  | 0  | 0  | 0  | 0  |
| 2083 | 0  | 0  | 0  | 0  | 0  | 0   | 0  | 0  | 0  | 0  | 0  | 0  | 0  |
| 2084 | 0  | 0  | 0  | 0  | 0  | 0   | 0  | 0  | 0  | 0  | 0  | 0  | 0  |
| 2085 | 0  | 0  | 0  | 0  | 0  | 0   | 0  | 0  | 0  | 0  | 0  | 0  | 0  |
| 2086 | 0  | 0  | 0  | 0  | 0  | 0   | 0  | 0  | 0  | 0  | 0  | 0  | 0  |
| 2087 | 0  | 0  | 0  | 0  | 0  | 0   | 0  | 0  | 0  | 0  | 0  | 0  | 0  |
| 2088 | 0  | 0  | 0  | 0  | 0  | 0   | 0  | 0  | 0  | 0  | 0  | 0  | 0  |
| 2089 | 0  | 0  | 0  | 0  | 0  | 0   | 0  | 0  | 0  | 0  | 0  | 0  | 0  |
| 2090 | 0  | 0  | 0  | 0  | 0  | 0   | 0  | 0  | 0  | 0  | 0  | 0  | 0  |

| 12%  | 92   | 93   | 94   | 95   | 96   | 97   | 98   | 99   | 100  | 101  | 102  | 103  | 104  |
|------|------|------|------|------|------|------|------|------|------|------|------|------|------|
| 2002 | 0    | 0    | 0    | 0    | 0    | 0    | 0    | 0    | 0    | 0    | 0    | 0    | 0    |
| 2003 | 0    | 0    | 0    | 0    | 0    | 0    | 0    | 0    | 0    | 0    | 0    | 0    | 0    |
| 2004 | 0    | 0    | 0    | 0    | 0    | 0    | 0    | 0    | 0    | 0    | 0    | 0    | 0    |
| 2005 | 0    | 0    | 0    | 0    | 0    | 0    | 0    | 0    | 0    | 0    | 0    | 0    | 0    |
| 2006 | 0    | 0    | 0    | 0    | 0    | 0    | 0    | 0    | 0    | 0    | 0    | 0    | 0    |
| 2007 | 0    | 0    | 0    | 0    | 0    | 0    | 0    | 0    | 0    | 0    | 0    | 0    | 0    |
| 2008 | 0    | 0    | 0    | 0    | 0    | 0    | 0    | 0    | 0    | 0    | 0    | 0    | 0    |
| 2009 | 0    | 0    | 0    | 0    | 0    | 0    | 0    | 0    | 0    | 0    | 0    | 0    | 0    |
| 2010 | 0    | 0    | 0    | 0    | 0    | 0    | 0    | 0    | 0    | 0    | 0    | 0    | 0    |
| 2011 | 0    | 0    | 0    | 0    | 0    | 0    | 0    | 0    | 0    | 0    | 0    | 0    | 0    |
| 2012 | 0    | 0    | 0    | 0    | 0    | 0    | 0    | 0    | 0    | 0    | 0    | 0    | 0    |
| 2013 | 0    | 0    | 0    | 0    | 0    | 0    | 0    | 0    | 0    | 0    | 0    | 0    | 0    |
| 2014 | 0    | 0    | 0    | 0    | 0    | 0    | 0    | 0    | 0    | 0    | 0    | 0    | 0    |
| 2015 | 0    | 0    | 0    | 0    | 0    | 0    | 0    | 0    | 0    | 0    | 0    | 0    | 0    |
| 2016 | 0    | 0    | 0    | 0    | 0    | 0    | 0    | 0    | 0    | 0    | 0    | 0    | 0    |
| 2017 | 0    | 0    | 0    | 0    | 0    | 0    | 0    | 0    | 0    | 0    | 0    | 0    | 0    |
| 2018 | 0    | 0    | 0    | 0    | 0    | 0    | 0    | 0    | 0    | 0    | 0    | 0    | 0    |
| 2019 | 0    | 0    | 0    | 0    | 0    | 0    | 0    | 0    | 0    | 0    | 0    | 0    | 0    |
| 2020 | 0    | 0    | 351  | 0    | 0    | 0    | 0    | 0    | 0    | 0    | 0    | 39   | 0    |
| 2021 | 0    | 0    | 3211 | 0    | 0    | 0    | 0    | 0    | 0    | 0    | 0    | 2573 | 0    |
| 2022 | 0    | 0    | 2369 | 0    | 0    | 0    | 0    | 0    | 0    | 0    | 0    | 2065 | 0    |
| 2023 | 0    | 0    | 2770 | 0    | 0    | 0    | 0    | 0    | 0    | 0    | 0    | 2340 | 0    |
| 2024 | 0    | 0    | 2067 | 0    | 0    | 0    | 0    | 0    | 0    | 0    | 0    | 1826 | 0    |
| 2025 | 277  | 0    | 1155 | 250  | 679  | 952  | 16   | 277  | 66   | 66   | 0    | 855  | 47   |
| 2026 | 1369 | 0    | 1222 | 2098 | 2441 | 2683 | 1418 | 2184 | 3236 | 1120 | 0    | 1000 | 1743 |
| 2027 | 1511 | 0    | 1520 | 2314 | 2673 | 2954 | 1807 | 2381 | 2942 | 1246 | 0    | 1059 | 2061 |
| 2028 | 1330 | 0    | 1264 | 1866 | 2174 | 2455 | 1276 | 1955 | 2878 | 995  | 0    | 761  | 1578 |
| 2029 | 1335 | 0    | 1456 | 2094 | 2434 | 2707 | 1590 | 2157 | 2855 | 1109 | 0    | 823  | 1947 |
| 2030 | 1291 | 257  | 1452 | 2184 | 2273 | 2616 | 1943 | 2121 | 2544 | 1100 | 39   | 1341 | 1613 |
| 2031 | 1314 | 1978 | 1005 | 1822 | 1720 | 2169 | 1271 | 1845 | 2006 | 885  | 1728 | 584  | 1295 |
| 2032 | 981  | 2143 | 1499 | 1190 | 1303 | 1686 | 961  | 1319 | 1522 | 692  | 1952 | 701  | 686  |
| 2033 | 1008 | 2277 | 1241 | 1464 | 1500 | 1725 | 1051 | 1440 | 1510 | 681  | 2031 | 666  | 1075 |
| 2034 | 1133 | 2029 | 1573 | 1299 | 1440 | 1826 | 910  | 1424 | 1451 | 821  | 1717 | 936  | 921  |
| 2035 | 1004 | 2277 | 997  | 1177 | 946  | 1461 | 784  | 1149 | 976  | 591  | 2035 | 815  | 599  |
| 2036 | 1067 | 1865 | 912  | 1405 | 1393 | 1549 | 964  | 1311 | 1388 | 759  | 1615 | 850  | 980  |
| 2037 | 946  | 1696 | 605  | 1060 | 1236 | 1334 | 749  | 1142 | 795  | 551  | 1454 | 775  | 725  |
| 2038 | 930  | 1710 | 566  | 1237 | 1197 | 1334 | 791  | 1119 | 1243 | 712  | 1422 | 595  | 843  |
| 2039 | 903  | 1401 | 441  | 1104 | 1319 | 1342 | 761  | 1147 | 1137 | 700  | 1077 | 289  | 678  |
| 2040 | 773  | 1182 | 343  | 1005 | 1154 | 1156 | 474  | 919  | 1007 | 614  | 1015 | 269  | 607  |
| 2041 | 812  | 1644 | 417  | 1071 | 1181 | 1337 | 764  | 1060 | 819  | 477  | 1355 | 371  | 674  |
| 2042 | 934  | 1613 | 747  | 1130 | 1154 | 1522 | 882  | 1276 | 1309 | 680  | 1254 | 1037 | 784  |
| 2043 | 816  | 1433 | 277  | 958  | 852  | 1079 | 556  | 962  | 630  | 484  | 1163 | 635  | 524  |
| 2044 | 703  | 1330 | 211  | 637  | 758  | 931  | 490  | 849  | 548  | 402  | 920  | 797  | 517  |
| 2045 | 476  | 946  | 332  | 461  | 953  | 707  | 391  | 571  | 665  | 477  | 642  | 3867 | 312  |
| 2046 | 523  | 789  | 538  | 374  | 947  | 641  | 321  | 567  | 825  | 294  | 720  | 3290 | 208  |
| 2047 | 269  | 656  | 19   | 70   | 255  | 472  | 98   | 269  | 4900 | 1510 | 685  | 1720 | 2938 |
| 2048 | 0    | 484  | 4059 | 185  | 3008 | 0    | 0    | 0    | 4952 | 1518 | 188  | 770  | 2966 |
| 2049 | 1557 | 200  | 3549 | 2961 | 2808 | 2965 | 2965 | 2965 | 4790 | 1546 | 314  | 640  | 2773 |
| 2050 | 1463 | 2336 | 1948 | 2997 | 2750 | 2871 | 2871 | 2871 | 3295 | 1167 | 2297 | 291  | 2303 |
| 2051 | 1472 | 2395 | 774  | 2883 | 1821 | 2828 | 2828 | 2828 | 2097 | 791  | 2372 | 287  | 1425 |
| 2052 | 1179 | 2364 | 691  | 2338 | 1044 | 2189 | 2189 | 2189 | 1107 | 431  | 2446 | 0    | 718  |
| 2053 | 784  | 2525 | 471  | 1428 | 593  | 1366 | 1366 | 1366 | 868  | 337  | 2666 | 0    | 628  |
| 2054 | 427  | 2294 | 0    | 777  | 628  | 714  | 714  | 714  | 518  | 224  | 2148 | 0    | 373  |
| 2055 | 337  | 1910 | 0    | 628  | 373  | 628  | 628  | 628  | 287  | 141  | 1871 | 0    | 188  |
| 2056 | 223  | 1196 | 0    | 373  | 188  | 373  | 373  | 373  | 228  | 133  | 1106 | 0    | 0    |
| 2057 | 141  | 887  | 0    | 188  | 181  | 188  | 188  | 188  | 0    | 0    | 753  | 0    | 0    |
| 2058 | 133  | 545  | 0    | 181  | 0    | 181  | 181  | 181  | 0    | 0    | 557  | 0    | 0    |
| 2059 | 0    | 326  | 0    | 0    | 0    | 0    | 0    | 0    | 0    | 0    | 326  | 0    | 0    |

| 12%  | 92 | 93  | 94 | 95 | 96 | 97 | 98 | 99 | 100 | 101 | 102 | 103 | 104 |
|------|----|-----|----|----|----|----|----|----|-----|-----|-----|-----|-----|
| 2060 | 0  | 204 | 0  | 0  | 0  | 0  | 0  | 0  | 0   | 0   | 204 | 0   | 0   |
| 2061 | 0  | 188 | 0  | 0  | 0  | 0  | 0  | 0  | 0   | 0   | 188 | 0   | 0   |
| 2062 | 0  | 126 | 0  | 0  | 0  | 0  | 0  | 0  | 0   | 0   | 126 | 0   | 0   |
| 2063 | 0  | 0   | 0  | 0  | 0  | 0  | 0  | 0  | 0   | 0   | 0   | 0   | 0   |
| 2064 | 0  | 0   | 0  | 0  | 0  | 0  | 0  | 0  | 0   | 0   | 0   | 0   | 0   |
| 2065 | 0  | 0   | 0  | 0  | 0  | 0  | 0  | 0  | 0   | 0   | 0   | 0   | 0   |
| 2066 | 0  | 0   | 0  | 0  | 0  | 0  | 0  | 0  | 0   | 0   | 0   | 0   | 0   |
| 2067 | 0  | 0   | 0  | 0  | 0  | 0  | 0  | 0  | 0   | 0   | 0   | 0   | 0   |
| 2068 | 0  | 0   | 0  | 0  | 0  | 0  | 0  | 0  | 0   | 0   | 0   | 0   | 0   |
| 2069 | 0  | 0   | 0  | 0  | 0  | 0  | 0  | 0  | 0   | 0   | 0   | 0   | 0   |
| 2070 | 0  | 0   | 0  | 0  | 0  | 0  | 0  | 0  | 0   | 0   | 0   | 0   | 0   |
| 2071 | 0  | 0   | 0  | 0  | 0  | 0  | 0  | 0  | 0   | 0   | 0   | 0   | 0   |
| 2072 | 0  | 0   | 0  | 0  | 0  | 0  | 0  | 0  | 0   | 0   | 0   | 0   | 0   |
| 2073 | 0  | 0   | 0  | 0  | 0  | 0  | 0  | 0  | 0   | 0   | 0   | 0   | 0   |
| 2074 | 0  | 0   | 0  | 0  | 0  | 0  | 0  | 0  | 0   | 0   | 0   | 0   | 0   |
| 2075 | 0  | 0   | 0  | 0  | 0  | 0  | 0  | 0  | 0   | 0   | 0   | 0   | 0   |
| 2076 | 0  | 0   | 0  | 0  | 0  | 0  | 0  | 0  | 0   | 0   | 0   | 0   | 0   |
| 2077 | 0  | 0   | 0  | 0  | 0  | 0  | 0  | 0  | 0   | 0   | 0   | 0   | 0   |
| 2078 | 0  | 0   | 0  | 0  | 0  | 0  | 0  | 0  | 0   | 0   | 0   | 0   | 0   |
| 2079 | 0  | 0   | 0  | 0  | 0  | 0  | 0  | 0  | 0   | 0   | 0   | 0   | 0   |
| 2080 | 0  | 0   | 0  | 0  | 0  | 0  | 0  | 0  | 0   | 0   | 0   | 0   | 0   |
| 2081 | 0  | 0   | 0  | 0  | 0  | 0  | 0  | 0  | 0   | 0   | 0   | 0   | 0   |
| 2082 | 0  | 0   | 0  | 0  | 0  | 0  | 0  | 0  | 0   | 0   | 0   | 0   | 0   |
| 2083 | 0  | 0   | 0  | 0  | 0  | 0  | 0  | 0  | 0   | 0   | 0   | 0   | 0   |
| 2084 | 0  | 0   | 0  | 0  | 0  | 0  | 0  | 0  | 0   | 0   | 0   | 0   | 0   |
| 2085 | 0  | 0   | 0  | 0  | 0  | 0  | 0  | 0  | 0   | 0   | 0   | 0   | 0   |
| 2086 | 0  | 0   | 0  | 0  | 0  | 0  | 0  | 0  | 0   | 0   | 0   | 0   | 0   |
| 2087 | 0  | 0   | 0  | 0  | 0  | 0  | 0  | 0  | 0   | 0   | 0   | 0   | 0   |
| 2088 | 0  | 0   | 0  | 0  | 0  | 0  | 0  | 0  | 0   | 0   | 0   | 0   | 0   |
| 2089 | 0  | 0   | 0  | 0  | 0  | 0  | 0  | 0  | 0   | 0   | 0   | 0   | 0   |
| 2090 | 0  | 0   | 0  | 0  | 0  | 0  | 0  | 0  | 0   | 0   | 0   | 0   | 0   |

| 12%  | 105  | 106  | 107  | 108  | 109  | 110  | 111  | 112  | 113  | 114  | 115  | 116  | 117  |
|------|------|------|------|------|------|------|------|------|------|------|------|------|------|
| 2002 | 0    | 0    | 0    | 0    | 0    | 0    | 0    | 0    | 0    | 0    | 0    | 0    | 0    |
| 2003 | 0    | 0    | 0    | 0    | 0    | 0    | 0    | 0    | 0    | 0    | 0    | 0    | 0    |
| 2004 | 0    | 0    | 0    | 0    | 0    | 0    | 0    | 0    | 0    | 0    | 0    | 0    | 0    |
| 2005 | 0    | 0    | 0    | 0    | 0    | 0    | 0    | 0    | 0    | 0    | 0    | 0    | 0    |
| 2006 | 0    | 0    | 0    | 0    | 0    | 0    | 0    | 0    | 0    | 0    | 0    | 0    | 0    |
| 2007 | 0    | 0    | 0    | 0    | 0    | 0    | 0    | 0    | 0    | 0    | 0    | 0    | 0    |
| 2008 | 0    | 0    | 0    | 0    | 0    | 0    | 0    | 0    | 0    | 0    | 0    | 0    | 0    |
| 2009 | 0    | 0    | 0    | 0    | 0    | 0    | 0    | 0    | 0    | 0    | 0    | 0    | 0    |
| 2010 | 0    | 0    | 0    | 0    | 0    | 0    | 0    | 0    | 0    | 0    | 0    | 0    | 0    |
| 2011 | 0    | 0    | 0    | 0    | 0    | 0    | 0    | 0    | 0    | 0    | 0    | 0    | 0    |
| 2012 | 0    | 0    | 0    | 0    | 0    | 0    | 0    | 0    | 0    | 0    | 0    | 0    | 0    |
| 2013 | 0    | 0    | 0    | 0    | 0    | 0    | 0    | 0    | 0    | 0    | 0    | 0    | 0    |
| 2014 | 0    | 0    | 0    | 0    | 0    | 0    | 0    | 0    | 0    | 0    | 0    | 0    | 0    |
| 2015 | 0    | 0    | 0    | 0    | 0    | 0    | 0    | 0    | 0    | 0    | 0    | 0    | 0    |
| 2016 | 0    | 0    | 0    | 0    | 0    | 0    | 0    | 0    | 0    | 0    | 0    | 0    | 0    |
| 2017 | 0    | 0    | 0    | 0    | 0    | 0    | 0    | 0    | 0    | 0    | 0    | 0    | 0    |
| 2018 | 0    | 0    | 0    | 0    | 0    | 0    | 0    | 0    | 0    | 0    | 0    | 0    | 0    |
| 2019 | 0    | 0    | 0    | 0    | 0    | 0    | 0    | 0    | 0    | 0    | 0    | 0    | 0    |
| 2020 | 0    | 0    | 0    | 0    | 0    | 0    | 0    | 991  | 0    | 0    | 0    | 0    | 0    |
| 2021 | 0    | 0    | 0    | 0    | 0    | 0    | 0    | 983  | 0    | 0    | 0    | 0    | 0    |
| 2022 | 0    | 0    | 0    | 0    | 0    | 0    | 0    | 991  | 0    | 0    | 0    | 0    | 0    |
| 2023 | 0    | 0    | 0    | 0    | 0    | 0    | 0    | 1002 | 0    | 0    | 0    | 0    | 0    |
| 2024 | 0    | 0    | 0    | 0    | 0    | 0    | 0    | 979  | 0    | 0    | 0    | 0    | 0    |
| 2025 | 246  | 250  | 4    | 66   | 998  | 998  | 0    | 1049 | 998  | 998  | 998  | 998  | 998  |
| 2026 | 2223 | 2187 | 1045 | 1907 | 975  | 975  | 0    | 998  | 975  | 975  | 975  | 975  | 975  |
| 2027 | 2357 | 2447 | 1214 | 2049 | 979  | 979  | 0    | 1002 | 979  | 979  | 979  | 979  | 979  |
| 2028 | 2068 | 2002 | 1056 | 1714 | 991  | 991  | 0    | 1101 | 991  | 991  | 991  | 991  | 991  |
| 2029 | 2293 | 2231 | 1190 | 1923 | 975  | 975  | 0    | 1218 | 975  | 975  | 975  | 975  | 975  |
| 2030 | 2082 | 2133 | 1799 | 1930 | 983  | 983  | 998  | 1532 | 983  | 983  | 983  | 983  | 983  |
| 2031 | 1689 | 1751 | 1905 | 1412 | 1006 | 1006 | 987  | 1336 | 1006 | 1061 | 1006 | 1006 | 1006 |
| 2032 | 1237 | 1331 | 879  | 1031 | 998  | 998  | 975  | 1705 | 998  | 1529 | 998  | 971  | 998  |
| 2033 | 1297 | 1331 | 1028 | 1066 | 1415 | 1034 | 1002 | 1901 | 975  | 1812 | 1065 | 1046 | 1065 |
| 2034 | 1288 | 1393 | 1004 | 1112 | 1081 | 1081 | 994  | 1541 | 1010 | 2036 | 1081 | 929  | 1081 |
| 2035 | 790  | 1130 | 710  | 736  | 1277 | 1167 | 983  | 1413 | 1041 | 1509 | 1277 | 1035 | 1277 |
| 2036 | 1147 | 1350 | 836  | 1050 | 2035 | 1410 | 1041 | 1163 | 1155 | 1238 | 1992 | 1582 | 1988 |
| 2037 | 951  | 1071 | 521  | 646  | 2200 | 1579 | 1022 | 984  | 1073 | 1166 | 1925 | 1628 | 1917 |
| 2038 | 1025 | 1303 | 933  | 1007 | 1669 | 1366 | 1022 | 1176 | 1763 | 1339 | 1546 | 1075 | 1527 |
| 2039 | 842  | 1264 | 784  | 944  | 2130 | 1293 | 1128 | 1396 | 1328 | 1206 | 1808 | 1426 | 1769 |
| 2040 | 946  | 1134 | 655  | 810  | 1885 | 1275 | 1529 | 1341 | 2011 | 1532 | 1818 | 1424 | 1724 |
| 2041 | 1013 | 1126 | 525  | 623  | 1545 | 1101 | 1399 | 1328 | 1270 | 1600 | 1544 | 1045 | 1380 |
| 2042 | 1440 | 1537 | 823  | 1073 | 1885 | 1488 | 2231 | 3735 | 2588 | 1988 | 1702 | 1227 | 1578 |
| 2043 | 895  | 875  | 391  | 532  | 1211 | 555  | 1468 | 4355 | 1025 | 920  | 832  | 785  | 820  |
| 2044 | 915  | 894  | 262  | 449  | 5351 | 1882 | 1994 | 2878 | 3366 | 3605 | 2480 | 2480 | 2480 |
| 2045 | 1029 | 742  | 364  | 524  | 5447 | 2065 | 818  | 3094 | 3304 | 3025 | 3383 | 3383 | 3383 |
| 2046 | 695  | 538  | 538  | 538  | 3475 | 1052 | 3207 | 3043 | 2435 | 2242 | 2739 | 2739 | 2739 |
| 2047 | 2922 | 2918 | 2918 | 2918 | 3714 | 922  | 3430 | 2951 | 1654 | 1721 | 2275 | 2275 | 2275 |
| 2048 | 2757 | 2970 | 2970 | 2970 | 2972 | 989  | 2734 | 1836 | 1803 | 1371 | 1457 | 1457 | 1457 |
| 2049 | 2778 | 2903 | 2903 | 2903 | 2398 | 837  | 1943 | 1375 | 1627 | 1796 | 1721 | 1721 | 1721 |
| 2050 | 1895 | 2182 | 2182 | 2182 | 3353 | 1953 | 1488 | 255  | 2413 | 2716 | 2700 | 2700 | 2700 |
| 2051 | 950  | 1421 | 1421 | 1421 | 3856 | 1477 | 1226 | 70   | 3399 | 2912 | 3270 | 3270 | 3270 |
| 2052 | 593  | 718  | 718  | 718  | 4831 | 2160 | 1747 | 0    | 3156 | 3050 | 2920 | 2920 | 2920 |
| 2053 | 628  | 628  | 628  | 628  | 3577 | 1489 | 1217 | 39   | 2459 | 2020 | 2231 | 2231 | 2231 |
| 2054 | 373  | 373  | 373  | 373  | 2304 | 495  | 1473 | 0    | 1579 | 1384 | 1458 | 1458 | 1458 |
| 2055 | 188  | 188  | 188  | 188  | 1461 | 328  | 3144 | 0    | 709  | 442  | 446  | 446  | 446  |
| 2056 | 181  | 181  | 181  | 181  | 478  | 269  | 3101 | 0    | 246  | 246  | 246  | 246  | 246  |
| 2057 | 0    | 0    | 0    | 0    | 191  | 0    | 2682 | 0    | 195  | 117  | 109  | 109  | 109  |
| 2058 | 0    | 0    | 0    | 0    | 4    | 105  | 1999 | 0    | 19   | 31   | 31   | 31   | 31   |
| 2059 | 0    | 0    | 0    | 0    | 51   | 0    | 1547 | 0    | 35   | 12   | 20   | 20   | 20   |

| 12%  | 105 | 106 | 107 | 108 | 109 | 110 | 111 | 112 | 113 | 114 | 115 | 116 | 117 |
|------|-----|-----|-----|-----|-----|-----|-----|-----|-----|-----|-----|-----|-----|
| 2060 | 0   | 0   | 0   | 0   | 0   | 0   | 590 | 0   | 0   | 31  | 31  | 31  | 31  |
| 2061 | 0   | 0   | 0   | 0   | 0   | 0   | 374 | 0   | 0   | 0   | 0   | 0   | 0   |
| 2062 | 0   | 0   | 0   | 0   | 0   | 0   | 254 | 0   | 0   | 0   | 0   | 0   | 0   |
| 2063 | 0   | 0   | 0   | 0   | 0   | 0   | 191 | 0   | 0   | 0   | 0   | 0   | 0   |
| 2064 | 0   | 0   | 0   | 0   | 0   | 0   | 39  | 0   | 0   | 0   | 0   | 0   | 0   |
| 2065 | 0   | 0   | 0   | 0   | 0   | 0   | 20  | 0   | 0   | 0   | 0   | 0   | 0   |
| 2066 | 0   | 0   | 0   | 0   | 0   | 0   | 0   | 0   | 0   | 0   | 0   | 0   | 0   |
| 2067 | 0   | 0   | 0   | 0   | 0   | 0   | 0   | 0   | 0   | 0   | 0   | 0   | 0   |
| 2068 | 0   | 0   | 0   | 0   | 0   | 0   | 0   | 0   | 0   | 0   | 0   | 0   | 0   |
| 2069 | 0   | 0   | 0   | 0   | 0   | 0   | 0   | 0   | 0   | 0   | 0   | 0   | 0   |
| 2070 | 0   | 0   | 0   | 0   | 0   | 0   | 0   | 0   | 0   | 0   | 0   | 0   | 0   |
| 2071 | 0   | 0   | 0   | 0   | 0   | 0   | 0   | 0   | 0   | 0   | 0   | 0   | 0   |
| 2072 | 0   | 0   | 0   | 0   | 0   | 0   | 0   | 0   | 0   | 0   | 0   | 0   | 0   |
| 2073 | 0   | 0   | 0   | 0   | 0   | 0   | 0   | 0   | 0   | 0   | 0   | 0   | 0   |
| 2074 | 0   | 0   | 0   | 0   | 0   | 0   | 0   | 0   | 0   | 0   | 0   | 0   | 0   |
| 2075 | 0   | 0   | 0   | 0   | 0   | 0   | 0   | 0   | 0   | 0   | 0   | 0   | 0   |
| 2076 | 0   | 0   | 0   | 0   | 0   | 0   | 0   | 0   | 0   | 0   | 0   | 0   | 0   |
| 2077 | 0   | 0   | 0   | 0   | 0   | 0   | 0   | 0   | 0   | 0   | 0   | 0   | 0   |
| 2078 | 0   | 0   | 0   | 0   | 0   | 0   | 0   | 0   | 0   | 0   | 0   | 0   | 0   |
| 2079 | 0   | 0   | 0   | 0   | 0   | 0   | 0   | 0   | 0   | 0   | 0   | 0   | 0   |
| 2080 | 0   | 0   | 0   | 0   | 0   | 0   | 0   | 0   | 0   | 0   | 0   | 0   | 0   |
| 2081 | 0   | 0   | 0   | 0   | 0   | 0   | 0   | 0   | 0   | 0   | 0   | 0   | 0   |
| 2082 | 0   | 0   | 0   | 0   | 0   | 0   | 0   | 0   | 0   | 0   | 0   | 0   | 0   |
| 2083 | 0   | 0   | 0   | 0   | 0   | 0   | 0   | 0   | 0   | 0   | 0   | 0   | 0   |
| 2084 | 0   | 0   | 0   | 0   | 0   | 0   | 0   | 0   | 0   | 0   | 0   | 0   | 0   |
| 2085 | 0   | 0   | 0   | 0   | 0   | 0   | 0   | 0   | 0   | 0   | 0   | 0   | 0   |
| 2086 | 0   | 0   | 0   | 0   | 0   | 0   | 0   | 0   | 0   | 0   | 0   | 0   | 0   |
| 2087 | 0   | 0   | 0   | 0   | 0   | 0   | 0   | 0   | 0   | 0   | 0   | 0   | 0   |
| 2088 | 0   | 0   | 0   | 0   | 0   | 0   | 0   | 0   | 0   | 0   | 0   | 0   | 0   |
| 2089 | 0   | 0   | 0   | 0   | 0   | 0   | 0   | 0   | 0   | 0   | 0   | 0   | 0   |
| 2090 | 0   | 0   | 0   | 0   | 0   | 0   | 0   | 0   | 0   | 0   | 0   | 0   | 0   |

| 12%  | 118  | 119  | 120  | 121  | 122  | 123  | 124  | 125  | 126  | 127  | 128  | 129  | 130  |
|------|------|------|------|------|------|------|------|------|------|------|------|------|------|
| 2002 | 0    | 0    | 0    | 0    | 0    | 0    | 0    | 0    | 0    | 0    | 0    | 0    | 0    |
| 2003 | 0    | 0    | 0    | 0    | 0    | 0    | 0    | 0    | 0    | 0    | 0    | 0    | 0    |
| 2004 | 0    | 0    | 0    | 0    | 0    | 0    | 0    | 0    | 0    | 0    | 0    | 0    | 0    |
| 2005 | 0    | 0    | 0    | 0    | 0    | 0    | 0    | 0    | 0    | 0    | 0    | 0    | 0    |
| 2006 | 0    | 0    | 0    | 0    | 0    | 0    | 0    | 0    | 0    | 0    | 0    | 0    | 0    |
| 2007 | 0    | 0    | 0    | 0    | 0    | 0    | 0    | 0    | 0    | 0    | 0    | 0    | 0    |
| 2008 | 0    | 0    | 0    | 0    | 0    | 0    | 0    | 0    | 0    | 0    | 0    | 0    | 0    |
| 2009 | 0    | 0    | 0    | 0    | 0    | 0    | 0    | 0    | 0    | 0    | 0    | 0    | 0    |
| 2010 | 0    | 0    | 0    | 0    | 0    | 0    | 0    | 0    | 0    | 0    | 0    | 0    | 0    |
| 2011 | 0    | 0    | 0    | 0    | 0    | 0    | 0    | 0    | 0    | 0    | 0    | 0    | 0    |
| 2012 | 0    | 0    | 0    | 0    | 0    | 0    | 0    | 0    | 0    | 0    | 0    | 0    | 0    |
| 2013 | 0    | 0    | 0    | 0    | 0    | 0    | 0    | 0    | 0    | 0    | 0    | 0    | 0    |
| 2014 | 0    | 0    | 0    | 0    | 0    | 0    | 0    | 0    | 0    | 0    | 0    | 0    | 0    |
| 2015 | 0    | 0    | 0    | 0    | 0    | 0    | 0    | 0    | 0    | 0    | 0    | 0    | 0    |
| 2016 | 0    | 0    | 0    | 0    | 0    | 0    | 0    | 0    | 0    | 0    | 0    | 0    | 0    |
| 2017 | 0    | 0    | 0    | 0    | 0    | 0    | 0    | 0    | 0    | 0    | 0    | 0    | 0    |
| 2018 | 0    | 0    | 0    | 0    | 0    | 0    | 0    | 0    | 0    | 0    | 0    | 0    | 0    |
| 2019 | 0    | 0    | 0    | 0    | 0    | 0    | 0    | 0    | 0    | 0    | 0    | 0    | 0    |
| 2020 | 0    | 0    | 0    | 351  | 0    | 0    | 0    | 0    | 0    | 0    | 0    | 0    | 39   |
| 2021 | 0    | 0    | 0    | 520  | 0    | 0    | 0    | 0    | 0    | 0    | 0    | 0    | 172  |
| 2022 | 0    | 0    | 0    | 413  | 0    | 0    | 0    | 0    | 0    | 0    | 0    | 0    | 196  |
| 2023 | 0    | 0    | 0    | 818  | 0    | 0    | 0    | 0    | 0    | 0    | 0    | 0    | 458  |
| 2024 | 0    | 0    | 0    | 1159 | 0    | 0    | 0    | 0    | 0    | 0    | 0    | 0    | 478  |
| 2025 | 277  | 277  | 0    | 1061 | 250  | 679  | 952  | 16   | 277  | 66   | 66   | 0    | 584  |
| 2026 | 622  | 512  | 0    | 1513 | 489  | 1367 | 1199 | 145  | 622  | 404  | 349  | 0    | 663  |
| 2027 | 713  | 477  | 0    | 903  | 807  | 1398 | 1183 | 200  | 548  | 376  | 286  | 0    | 898  |
| 2028 | 743  | 743  | 0    | 1217 | 751  | 1293 | 1215 | 439  | 743  | 415  | 360  | 0    | 670  |
| 2029 | 1203 | 1105 | 0    | 1413 | 1050 | 1257 | 1730 | 1040 | 1223 | 525  | 470  | 0    | 422  |
| 2030 | 1324 | 860  | 257  | 1877 | 1080 | 1123 | 1651 | 844  | 1214 | 855  | 525  | 39   | 701  |
| 2031 | 1331 | 840  | 504  | 1944 | 723  | 1186 | 1569 | 875  | 1335 | 831  | 536  | 286  | 1019 |
| 2032 | 2039 | 1307 | 893  | 1676 | 1446 | 1055 | 1745 | 1024 | 1457 | 918  | 399  | 458  | 960  |
| 2033 | 1854 | 1389 | 1081 | 1406 | 1480 | 1100 | 1820 | 1263 | 1551 | 1169 | 524  | 698  | 1829 |
| 2034 | 1571 | 1072 | 1151 | 1882 | 1084 | 1237 | 1565 | 898  | 1253 | 650  | 649  | 595  | 1255 |
| 2035 | 1752 | 1378 | 1481 | 1053 | 1045 | 1312 | 1914 | 1248 | 1637 | 1137 | 783  | 579  | 1483 |
| 2036 | 2809 | 1347 | 1540 | 1422 | 1784 | 2098 | 2600 | 2147 | 2413 | 1471 | 1004 | 729  | 1117 |
| 2037 | 2083 | 805  | 1623 | 539  | 1615 | 1728 | 1648 | 1180 | 1465 | 1691 | 669  | 811  | 760  |
| 2038 | 1167 | 546  | 1771 | 1155 | 1022 | 1174 | 883  | 368  | 692  | 1915 | 944  | 917  | 1000 |
| 2039 | 986  | 554  | 1591 | 924  | 1112 | 1595 | 1075 | 517  | 849  | 1971 | 983  | 1329 | 1082 |
| 2040 | 1311 | 772  | 1269 | 732  | 782  | 1237 | 1318 | 635  | 1150 | 1239 | 830  | 1254 | 1027 |
| 2041 | 1579 | 804  | 1626 | 491  | 1469 | 835  | 1204 | 635  | 997  | 1051 | 666  | 1439 | 607  |
| 2042 | 1740 | 866  | 1322 | 394  | 1355 | 1325 | 1329 | 842  | 1201 | 1043 | 543  | 948  | 837  |
| 2043 | 1826 | 922  | 1142 | 642  | 1229 | 1071 | 1283 | 882  | 1162 | 1451 | 456  | 1085 | 469  |
| 2044 | 1516 | 667  | 981  | 756  | 1221 | 621  | 941  | 614  | 883  | 1196 | 515  | 960  | 426  |
| 2045 | 1204 | 644  | 741  | 792  | 915  | 782  | 896  | 665  | 794  | 1286 | 456  | 555  | 532  |
| 2046 | 952  | 578  | 738  | 627  | 692  | 935  | 794  | 478  | 692  | 1227 | 520  | 499  | 2514 |
| 2047 | 595  | 398  | 791  | 749  | 536  | 1006 | 645  | 392  | 575  | 3511 | 1167 | 242  | 5255 |
| 2048 | 509  | 340  | 2422 | 235  | 1745 | 426  | 344  | 239  | 301  | 3884 | 1283 | 2763 | 3766 |
| 2049 | 1467 | 733  | 1794 | 74   | 1481 | 1498 | 1349 | 1349 | 1349 | 2373 | 1320 | 2117 | 2558 |
| 2050 | 3491 | 1554 | 1094 | 5440 | 1709 | 3926 | 2188 | 2188 | 2188 | 2748 | 1135 | 1712 | 1008 |
| 2051 | 2456 | 974  | 1260 | 4155 | 1918 | 3714 | 1835 | 1835 | 1835 | 5393 | 1835 | 1747 | 372  |
| 2052 | 3578 | 1626 | 1682 | 2429 | 3321 | 2880 | 2834 | 2834 | 2834 | 5354 | 1676 | 1371 | 82   |
| 2053 | 5920 | 1917 | 1768 | 937  | 3894 | 2180 | 3773 | 3773 | 3773 | 4123 | 945  | 1933 | 157  |
| 2054 | 5099 | 1291 | 2365 | 325  | 2585 | 1897 | 2932 | 2932 | 2932 | 2723 | 887  | 2341 | 16   |
| 2055 | 3422 | 776  | 2896 | 188  | 1747 | 574  | 2266 | 2266 | 2266 | 1755 | 441  | 2782 | 12   |
| 2056 | 2413 | 754  | 2696 | 55   | 885  | 277  | 990  | 990  | 990  | 1150 | 265  | 2523 | 0    |
| 2057 | 1417 | 312  | 2647 | 16   | 316  | 172  | 339  | 339  | 339  | 227  | 148  | 2031 | 0    |
| 2058 | 793  | 199  | 2230 | 0    | 172  | 70   | 175  | 176  | 176  | 117  | 82   | 2215 | 0    |
| 2059 | 199  | 125  | 970  | 16   | 82   | 59   | 152  | 152  | 152  | 66   | 58   | 1747 | 0    |

| 12%  | 118 | 119 | 120 | 121 | 122 | 123 | 124 | 125 | 126 | 127 | 128 | 129  | 130 |
|------|-----|-----|-----|-----|-----|-----|-----|-----|-----|-----|-----|------|-----|
| 2060 | 90  | 82  | 484 | 0   | 47  | 8   | 82  | 82  | 82  | 0   | 0   | 1073 | 0   |
| 2061 | 66  | 39  | 257 | 0   | 39  | 0   | 47  | 47  | 47  | 0   | 0   | 324  | 0   |
| 2062 | 0   | 27  | 172 | 0   | 0   | 0   | 8   | 8   | 8   | 0   | 0   | 230  | 0   |
| 2063 | 0   | 0   | 156 | 0   | 0   | 0   | 0   | 0   | 0   | 0   | 0   | 172  | 0   |
| 2064 | 0   | 0   | 156 | 0   | 0   | 0   | 0   | 0   | 0   | 0   | 0   | 156  | 0   |
| 2065 | 0   | 0   | 121 | 0   | 0   | 0   | 0   | 0   | 0   | 0   | 0   | 152  | 0   |
| 2066 | 0   | 0   | 58  | 0   | 0   | 0   | 0   | 0   | 0   | 0   | 0   | 23   | 0   |
| 2067 | 0   | 0   | 0   | 0   | 0   | 0   | 0   | 0   | 0   | 0   | 0   | 0    | 0   |
| 2068 | 0   | 0   | 0   | 0   | 0   | 0   | 0   | 0   | 0   | 0   | 0   | 0    | 0   |
| 2069 | 0   | 0   | 0   | 0   | 0   | 0   | 0   | 0   | 0   | 0   | 0   | 0    | 0   |
| 2070 | 0   | 0   | 0   | 0   | 0   | 0   | 0   | 0   | 0   | 0   | 0   | 0    | 0   |
| 2071 | 0   | 0   | 0   | 0   | 0   | 0   | 0   | 0   | 0   | 0   | 0   | 0    | 0   |
| 2072 | 0   | 0   | 0   | 0   | 0   | 0   | 0   | 0   | 0   | 0   | 0   | 0    | 0   |
| 2073 | 0   | 0   | 0   | 0   | 0   | 0   | 0   | 0   | 0   | 0   | 0   | 0    | 0   |
| 2074 | 0   | 0   | 0   | 0   | 0   | 0   | 0   | 0   | 0   | 0   | 0   | 0    | 0   |
| 2075 | 0   | 0   | 0   | 0   | 0   | 0   | 0   | 0   | 0   | 0   | 0   | 0    | 0   |
| 2076 | 0   | 0   | 0   | 0   | 0   | 0   | 0   | 0   | 0   | 0   | 0   | 0    | 0   |
| 2077 | 0   | 0   | 0   | 0   | 0   | 0   | 0   | 0   | 0   | 0   | 0   | 0    | 0   |
| 2078 | 0   | 0   | 0   | 0   | 0   | 0   | 0   | 0   | 0   | 0   | 0   | 0    | 0   |
| 2079 | 0   | 0   | 0   | 0   | 0   | 0   | 0   | 0   | 0   | 0   | 0   | 0    | 0   |
| 2080 | 0   | 0   | 0   | 0   | 0   | 0   | 0   | 0   | 0   | 0   | 0   | 0    | 0   |
| 2081 | 0   | 0   | 0   | 0   | 0   | 0   | 0   | 0   | 0   | 0   | 0   | 0    | 0   |
| 2082 | 0   | 0   | 0   | 0   | 0   | 0   | 0   | 0   | 0   | 0   | 0   | 0    | 0   |
| 2083 | 0   | 0   | 0   | 0   | 0   | 0   | 0   | 0   | 0   | 0   | 0   | 0    | 0   |
| 2084 | 0   | 0   | 0   | 0   | 0   | 0   | 0   | 0   | 0   | 0   | 0   | 0    | 0   |
| 2085 | 0   | 0   | 0   | 0   | 0   | 0   | 0   | 0   | 0   | 0   | 0   | 0    | 0   |
| 2086 | 0   | 0   | 0   | 0   | 0   | 0   | 0   | 0   | 0   | 0   | 0   | 0    | 0   |
| 2087 | 0   | 0   | 0   | 0   | 0   | 0   | 0   | 0   | 0   | 0   | 0   | 0    | 0   |
| 2088 | 0   | 0   | 0   | 0   | 0   | 0   | 0   | 0   | 0   | 0   | 0   | 0    | 0   |
| 2089 | 0   | 0   | 0   | 0   | 0   | 0   | 0   | 0   | 0   | 0   | 0   | 0    | 0   |
| 2090 | 0   | 0   | 0   | 0   | 0   | 0   | 0   | 0   | 0   | 0   | 0   | 0    | 0   |



| 12%  | 131  | 132  | 133  | 134  | 135  | 136  | 137  | 138  | 139  | 140  | 141  | 142  | 143  |
|------|------|------|------|------|------|------|------|------|------|------|------|------|------|
| 2002 | 0    | 0    | 0    | 0    | 0    | 0    | 0    | 0    | 0    | 0    | 0    | 0    | 0    |
| 2003 | 0    | 0    | 0    | 0    | 0    | 0    | 0    | 0    | 0    | 0    | 0    | 0    | 0    |
| 2004 | 0    | 0    | 0    | 0    | 0    | 0    | 0    | 0    | 0    | 0    | 0    | 0    | 0    |
| 2005 | 0    | 0    | 0    | 0    | 0    | 0    | 0    | 0    | 0    | 0    | 0    | 0    | 0    |
| 2006 | 0    | 0    | 0    | 0    | 0    | 0    | 0    | 0    | 0    | 0    | 0    | 0    | 0    |
| 2007 | 0    | 0    | 0    | 0    | 0    | 0    | 0    | 0    | 0    | 0    | 0    | 0    | 0    |
| 2008 | 0    | 0    | 0    | 0    | 0    | 0    | 0    | 0    | 0    | 0    | 0    | 0    | 0    |
| 2009 | 0    | 0    | 0    | 0    | 0    | 0    | 0    | 0    | 0    | 0    | 0    | 0    | 0    |
| 2010 | 0    | 0    | 0    | 0    | 0    | 0    | 0    | 0    | 0    | 0    | 0    | 0    | 0    |
| 2011 | 0    | 0    | 0    | 0    | 0    | 0    | 0    | 0    | 0    | 0    | 0    | 0    | 0    |
| 2012 | 0    | 0    | 0    | 0    | 0    | 0    | 0    | 0    | 0    | 0    | 0    | 0    | 0    |
| 2013 | 0    | 0    | 0    | 0    | 0    | 0    | 0    | 0    | 0    | 0    | 0    | 0    | 0    |
| 2014 | 0    | 0    | 0    | 0    | 0    | 0    | 0    | 0    | 0    | 0    | 0    | 0    | 0    |
| 2015 | 0    | 0    | 0    | 0    | 0    | 0    | 0    | 0    | 0    | 0    | 0    | 0    | 0    |
| 2016 | 0    | 0    | 0    | 0    | 0    | 0    | 0    | 0    | 0    | 0    | 0    | 0    | 0    |
| 2017 | 0    | 0    | 0    | 0    | 0    | 0    | 0    | 0    | 0    | 0    | 0    | 0    | 0    |
| 2018 | 0    | 0    | 0    | 0    | 0    | 0    | 0    | 0    | 0    | 0    | 0    | 0    | 0    |
| 2019 | 0    | 0    | 0    | 0    | 0    | 0    | 0    | 0    | 0    | 0    | 0    | 0    | 0    |
| 2020 | 0    | 0    | 0    | 0    | 0    | 0    | 0    | 0    | 991  | 0    | 0    | 0    | 0    |
| 2021 | 0    | 0    | 0    | 0    | 0    | 0    | 0    | 0    | 3011 | 0    | 0    | 0    | 0    |
| 2022 | 0    | 0    | 0    | 0    | 0    | 0    | 0    | 0    | 3238 | 0    | 0    | 0    | 0    |
| 2023 | 0    | 0    | 0    | 0    | 0    | 0    | 0    | 0    | 2075 | 0    | 0    | 0    | 0    |
| 2024 | 0    | 0    | 0    | 0    | 0    | 0    | 0    | 0    | 2279 | 0    | 0    | 0    | 0    |
| 2025 | 47   | 246  | 250  | 4    | 66   | 998  | 998  | 0    | 1969 | 998  | 998  | 998  | 998  |
| 2026 | 216  | 905  | 614  | 130  | 404  | 2909 | 1694 | 0    | 2365 | 2186 | 2186 | 2186 | 2186 |
| 2027 | 204  | 736  | 681  | 185  | 376  | 3856 | 1705 | 0    | 1882 | 2948 | 2948 | 2948 | 2948 |
| 2028 | 251  | 1250 | 626  | 271  | 415  | 3428 | 1521 | 0    | 2040 | 2311 | 2311 | 2311 | 2311 |
| 2029 | 337  | 1261 | 743  | 447  | 525  | 3522 | 1956 | 0    | 1415 | 2609 | 2609 | 2609 | 2609 |
| 2030 | 474  | 1003 | 1112 | 718  | 855  | 2947 | 1288 | 998  | 1354 | 2090 | 2090 | 2090 | 2090 |
| 2031 | 419  | 1080 | 864  | 341  | 556  | 2334 | 1414 | 2032 | 1390 | 1886 | 1886 | 1886 | 1886 |
| 2032 | 934  | 1163 | 1092 | 553  | 725  | 3140 | 1717 | 2929 | 1190 | 2318 | 2318 | 2318 | 2318 |
| 2033 | 607  | 1062 | 942  | 467  | 654  | 3010 | 1257 | 2585 | 1241 | 2251 | 2251 | 2251 | 2247 |
| 2034 | 686  | 959  | 950  | 616  | 701  | 2130 | 1186 | 2499 | 2281 | 1635 | 1635 | 1635 | 1611 |
| 2035 | 600  | 1328 | 1342 | 828  | 956  | 1901 | 1096 | 3150 | 1360 | 1269 | 1269 | 1269 | 1246 |
| 2036 | 847  | 1773 | 1697 | 1343 | 1432 | 1486 | 1229 | 2581 | 2245 | 1209 | 1315 | 1209 | 1158 |
| 2037 | 1075 | 1380 | 1650 | 1205 | 1357 | 2203 | 1115 | 1920 | 1132 | 1248 | 1147 | 1248 | 1120 |
| 2038 | 875  | 979  | 1575 | 1354 | 1396 | 1422 | 1232 | 1764 | 788  | 1124 | 1248 | 1131 | 905  |
| 2039 | 1107 | 1262 | 1579 | 1189 | 1286 | 1594 | 1315 | 1673 | 2366 | 1531 | 1575 | 1606 | 1333 |
| 2040 | 561  | 1213 | 1304 | 907  | 1054 | 1767 | 1315 | 1139 | 1144 | 1594 | 1876 | 1696 | 1217 |
| 2041 | 914  | 1072 | 1429 | 891  | 1000 | 2112 | 1346 | 1139 | 753  | 1881 | 1527 | 1915 | 1545 |
| 2042 | 643  | 992  | 1291 | 655  | 834  | 1740 | 1381 | 1045 | 1313 | 1499 | 1483 | 1390 | 1035 |
| 2043 | 768  | 1104 | 1220 | 749  | 862  | 2669 | 1408 | 1159 | 255  | 1092 | 1354 | 1553 | 1245 |
| 2044 | 1078 | 805  | 1150 | 733  | 850  | 2093 | 1550 | 1426 | 4626 | 2524 | 2238 | 2390 | 2012 |
| 2045 | 690  | 950  | 1119 | 694  | 885  | 687  | 388  | 1385 | 3252 | 554  | 648  | 919  | 919  |
| 2046 | 396  | 1017 | 1068 | 674  | 811  | 6053 | 3383 | 1763 | 2270 | 4086 | 762  | 4047 | 4047 |
| 2047 | 3011 | 904  | 2111 | 2111 | 2111 | 3589 | 1146 | 1213 | 474  | 2445 | 4562 | 2484 | 2484 |
| 2048 | 2428 | 1573 | 1862 | 1862 | 1862 | 3667 | 1511 | 772  | 136  | 2684 | 2283 | 2684 | 2684 |
| 2049 | 1409 | 3600 | 2113 | 2113 | 2113 | 3577 | 1760 | 1402 | 20   | 2213 | 2880 | 2174 | 2174 |
| 2050 | 853  | 3753 | 2009 | 2009 | 2009 | 2493 | 681  | 3450 | 62   | 1644 | 2104 | 1644 | 1644 |
| 2051 | 2001 | 2944 | 3479 | 3479 | 3479 | 1559 | 347  | 1791 | 0    | 1189 | 1279 | 953  | 953  |
| 2052 | 4060 | 2608 | 3493 | 3493 | 3493 | 969  | 296  | 1673 | 0    | 348  | 454  | 332  | 332  |
| 2053 | 3042 | 1575 | 2459 | 2459 | 2459 | 172  | 117  | 2193 | 0    | 199  | 242  | 179  | 179  |
| 2054 | 2467 | 810  | 1500 | 1500 | 1500 | 23   | 0    | 2622 | 0    | 66   | 140  | 8    | 8    |
| 2055 | 1740 | 379  | 524  | 524  | 524  | 47   | 86   | 2114 | 0    | 47   | 8    | 55   | 55   |
| 2056 | 527  | 199  | 242  | 242  | 242  | 0    | 4    | 1769 | 0    | 8    | 47   | 20   | 19   |
| 2057 | 269  | 82   | 172  | 172  | 172  | 23   | 0    | 913  | 0    | 12   | 0    | 0    | 0    |
| 2058 | 172  | 47   | 82   | 82   | 82   | 0    | 0    | 324  | 0    | 8    | 0    | 0    | 0    |
| 2059 | 82   | 12   | 47   | 47   | 47   | 0    | 0    | 250  | 0    | 0    | 0    | 0    | 0    |

| 12%  | 131 | 132 | 133 | 134 | 135 | 136 | 137 | 138 | 139 | 140 | 141 | 142 | 143 |
|------|-----|-----|-----|-----|-----|-----|-----|-----|-----|-----|-----|-----|-----|
| 2060 | 47  | 4   | 0   | 0   | 0   | 0   | 0   | 187 | 0   | 0   | 0   | 0   | 0   |
| 2061 | 8   | 12  | 0   | 0   | 0   | 0   | 0   | 129 | 0   | 0   | 0   | 0   | 0   |
| 2062 | 0   | 0   | 0   | 0   | 0   | 0   | 0   | 39  | 0   | 0   | 0   | 0   | 0   |
| 2063 | 0   | 0   | 0   | 0   | 0   | 0   | 0   | 0   | 0   | 0   | 0   | 0   | 0   |
| 2064 | 0   | 0   | 0   | 0   | 0   | 0   | 0   | 0   | 0   | 0   | 0   | 0   | 0   |
| 2065 | 0   | 0   | 0   | 0   | 0   | 0   | 0   | 0   | 0   | 0   | 0   | 0   | 0   |
| 2066 | 0   | 0   | 0   | 0   | 0   | 0   | 0   | 0   | 0   | 0   | 0   | 0   | 0   |
| 2067 | 0   | 0   | 0   | 0   | 0   | 0   | 0   | 0   | 0   | 0   | 0   | 0   | 0   |
| 2068 | 0   | 0   | 0   | 0   | 0   | 0   | 0   | 0   | 0   | 0   | 0   | 0   | 0   |
| 2069 | 0   | 0   | 0   | 0   | 0   | 0   | 0   | 0   | 0   | 0   | 0   | 0   | 0   |
| 2070 | 0   | 0   | 0   | 0   | 0   | 0   | 0   | 0   | 0   | 0   | 0   | 0   | 0   |
| 2071 | 0   | 0   | 0   | 0   | 0   | 0   | 0   | 0   | 0   | 0   | 0   | 0   | 0   |
| 2072 | 0   | 0   | 0   | 0   | 0   | 0   | 0   | 0   | 0   | 0   | 0   | 0   | 0   |
| 2073 | 0   | 0   | 0   | 0   | 0   | 0   | 0   | 0   | 0   | 0   | 0   | 0   | 0   |
| 2074 | 0   | 0   | 0   | 0   | 0   | 0   | 0   | 0   | 0   | 0   | 0   | 0   | 0   |
| 2075 | 0   | 0   | 0   | 0   | 0   | 0   | 0   | 0   | 0   | 0   | 0   | 0   | 0   |
| 2076 | 0   | 0   | 0   | 0   | 0   | 0   | 0   | 0   | 0   | 0   | 0   | 0   | 0   |
| 2077 | 0   | 0   | 0   | 0   | 0   | 0   | 0   | 0   | 0   | 0   | 0   | 0   | 0   |
| 2078 | 0   | 0   | 0   | 0   | 0   | 0   | 0   | 0   | 0   | 0   | 0   | 0   | 0   |
| 2079 | 0   | 0   | 0   | 0   | 0   | 0   | 0   | 0   | 0   | 0   | 0   | 0   | 0   |
| 2080 | 0   | 0   | 0   | 0   | 0   | 0   | 0   | 0   | 0   | 0   | 0   | 0   | 0   |
| 2081 | 0   | 0   | 0   | 0   | 0   | 0   | 0   | 0   | 0   | 0   | 0   | 0   | 0   |
| 2082 | 0   | 0   | 0   | 0   | 0   | 0   | 0   | 0   | 0   | 0   | 0   | 0   | 0   |
| 2083 | 0   | 0   | 0   | 0   | 0   | 0   | 0   | 0   | 0   | 0   | 0   | 0   | 0   |
| 2084 | 0   | 0   | 0   | 0   | 0   | 0   | 0   | 0   | 0   | 0   | 0   | 0   | 0   |
| 2085 | 0   | 0   | 0   | 0   | 0   | 0   | 0   | 0   | 0   | 0   | 0   | 0   | 0   |
| 2086 | 0   | 0   | 0   | 0   | 0   | 0   | 0   | 0   | 0   | 0   | 0   | 0   | 0   |
| 2087 | 0   | 0   | 0   | 0   | 0   | 0   | 0   | 0   | 0   | 0   | 0   | 0   | 0   |
| 2088 | 0   | 0   | 0   | 0   | 0   | 0   | 0   | 0   | 0   | 0   | 0   | 0   | 0   |
| 2089 | 0   | 0   | 0   | 0   | 0   | 0   | 0   | 0   | 0   | 0   | 0   | 0   | 0   |
| 2090 | 0   | 0   | 0   | 0   | 0   | 0   | 0   | 0   | 0   | 0   | 0   | 0   | 0   |

| 12%  | 144  | 145  | 146  | 147  | 148  | 149  | 150  | 151  | 152  | 153  | 154  | 155  | 156  |
|------|------|------|------|------|------|------|------|------|------|------|------|------|------|
| 2002 | 0    | 0    | 0    | 0    | 0    | 0    | 0    | 0    | 0    | 0    | 0    | 0    | 0    |
| 2003 | 0    | 0    | 0    | 0    | 0    | 0    | 0    | 0    | 0    | 0    | 0    | 0    | 0    |
| 2004 | 0    | 0    | 0    | 0    | 0    | 0    | 0    | 0    | 0    | 0    | 0    | 0    | 0    |
| 2005 | 0    | 0    | 0    | 0    | 0    | 0    | 0    | 0    | 0    | 0    | 0    | 0    | 0    |
| 2006 | 0    | 0    | 0    | 0    | 0    | 0    | 0    | 0    | 0    | 0    | 0    | 0    | 0    |
| 2007 | 0    | 0    | 0    | 0    | 0    | 0    | 0    | 0    | 0    | 0    | 0    | 0    | 0    |
| 2008 | 0    | 0    | 0    | 0    | 0    | 0    | 0    | 0    | 0    | 0    | 0    | 0    | 0    |
| 2009 | 0    | 0    | 0    | 0    | 0    | 0    | 0    | 0    | 0    | 0    | 0    | 0    | 0    |
| 2010 | 0    | 0    | 0    | 0    | 0    | 0    | 0    | 0    | 0    | 0    | 0    | 0    | 0    |
| 2011 | 0    | 0    | 0    | 0    | 0    | 0    | 0    | 0    | 0    | 0    | 0    | 0    | 0    |
| 2012 | 0    | 0    | 0    | 0    | 0    | 0    | 0    | 0    | 0    | 0    | 0    | 0    | 0    |
| 2013 | 0    | 0    | 0    | 0    | 0    | 0    | 0    | 0    | 0    | 0    | 0    | 0    | 0    |
| 2014 | 0    | 0    | 0    | 0    | 0    | 0    | 0    | 0    | 0    | 0    | 0    | 0    | 0    |
| 2015 | 0    | 0    | 0    | 0    | 0    | 0    | 0    | 0    | 0    | 0    | 0    | 0    | 0    |
| 2016 | 0    | 0    | 0    | 0    | 0    | 0    | 0    | 0    | 0    | 0    | 0    | 0    | 0    |
| 2017 | 0    | 0    | 0    | 0    | 0    | 0    | 0    | 0    | 0    | 0    | 0    | 0    | 0    |
| 2018 | 0    | 0    | 0    | 0    | 0    | 0    | 0    | 0    | 0    | 0    | 0    | 0    | 0    |
| 2019 | 0    | 0    | 0    | 0    | 0    | 0    | 0    | 0    | 0    | 0    | 0    | 0    | 0    |
| 2020 | 0    | 0    | 0    | 0    | 351  | 0    | 0    | 0    | 0    | 0    | 0    | 0    | 0    |
| 2021 | 0    | 0    | 0    | 0    | 4492 | 0    | 0    | 0    | 0    | 0    | 0    | 0    | 0    |
| 2022 | 0    | 0    | 0    | 0    | 2971 | 0    | 0    | 0    | 0    | 0    | 0    | 0    | 0    |
| 2023 | 0    | 0    | 0    | 0    | 2314 | 0    | 0    | 0    | 0    | 0    | 0    | 0    | 0    |
| 2024 | 0    | 0    | 0    | 0    | 1772 | 0    | 0    | 0    | 0    | 0    | 0    | 0    | 0    |
| 2025 | 998  | 277  | 277  | 0    | 1127 | 250  | 679  | 952  | 16   | 277  | 66   | 66   | 0    |
| 2026 | 2186 | 5232 | 2240 | 0    | 1048 | 3825 | 4156 | 4414 | 2663 | 3903 | 4742 | 2033 | 0    |
| 2027 | 2948 | 4355 | 2279 | 0    | 1374 | 3400 | 3739 | 3993 | 3048 | 3451 | 3873 | 2030 | 0    |
| 2028 | 2311 | 3521 | 1373 | 0    | 1385 | 2271 | 2512 | 2805 | 1748 | 2317 | 3625 | 987  | 0    |
| 2029 | 2609 | 2601 | 1142 | 0    | 1417 | 1335 | 1589 | 1908 | 1067 | 1378 | 2418 | 963  | 0    |
| 2030 | 2090 | 2448 | 1232 | 257  | 1287 | 1787 | 1904 | 2243 | 1790 | 1752 | 2159 | 990  | 39   |
| 2031 | 1886 | 1895 | 1208 | 3497 | 1044 | 1483 | 1370 | 1827 | 1047 | 1518 | 1517 | 775  | 3247 |
| 2032 | 2318 | 1657 | 799  | 4216 | 1263 | 1150 | 1378 | 1697 | 875  | 1307 | 1380 | 534  | 4037 |
| 2033 | 2251 | 1991 | 831  | 2624 | 1095 | 1417 | 1508 | 1619 | 886  | 1315 | 1691 | 476  | 2402 |
| 2034 | 1635 | 1444 | 1169 | 1880 | 1452 | 1401 | 1193 | 1834 | 980  | 1460 | 1141 | 814  | 1607 |
| 2035 | 1269 | 1291 | 835  | 1604 | 1000 | 807  | 651  | 1119 | 438  | 800  | 850  | 429  | 1327 |
| 2036 | 1209 | 1539 | 799  | 1455 | 628  | 1012 | 937  | 1226 | 598  | 965  | 1266 | 503  | 1217 |
| 2037 | 1248 | 1256 | 844  | 1432 | 616  | 1016 | 1044 | 1247 | 626  | 1020 | 834  | 485  | 1198 |
| 2038 | 1131 | 1087 | 698  | 1832 | 550  | 985  | 1016 | 1161 | 626  | 958  | 944  | 503  | 1544 |
| 2039 | 1606 | 985  | 655  | 1515 | 578  | 726  | 1165 | 999  | 387  | 804  | 779  | 429  | 1242 |
| 2040 | 1696 | 1323 | 793  | 1013 | 374  | 954  | 1016 | 1204 | 564  | 1001 | 1042 | 567  | 869  |
| 2041 | 1904 | 1261 | 938  | 1298 | 511  | 1087 | 1409 | 1282 | 670  | 997  | 729  | 634  | 1029 |
| 2042 | 1358 | 1331 | 820  | 960  | 1179 | 1177 | 1083 | 1580 | 937  | 1339 | 1407 | 614  | 578  |
| 2043 | 1487 | 1241 | 667  | 850  | 967  | 1037 | 523  | 1055 | 584  | 919  | 421  | 425  | 589  |
| 2044 | 2300 | 825  | 565  | 871  | 547  | 519  | 550  | 620  | 215  | 558  | 634  | 347  | 503  |
| 2045 | 919  | 508  | 476  | 655  | 192  | 515  | 581  | 597  | 269  | 488  | 638  | 495  | 520  |
| 2046 | 4047 | 456  | 378  | 915  | 825  | 421  | 836  | 503  | 179  | 386  | 381  | 160  | 731  |
| 2047 | 2484 | 293  | 406  | 589  | 4886 | 215  | 497  | 546  | 125  | 343  | 6930 | 55   | 456  |
| 2048 | 2684 | 0    | 16   | 449  | 2768 | 0    | 1595 | 8    | 8    | 8    | 6305 | 3340 | 86   |
| 2049 | 2174 | 7067 | 3241 | 125  | 1325 | 5471 | 5274 | 5652 | 5652 | 5652 | 4339 | 1483 | 133  |
| 2050 | 1644 | 6269 | 1550 | 12   | 742  | 3985 | 2880 | 3914 | 3914 | 3914 | 2386 | 953  | 5262 |
| 2051 | 953  | 4214 | 973  | 5250 | 290  | 1873 | 1936 | 1763 | 1763 | 1763 | 1530 | 738  | 3568 |
| 2052 | 332  | 2338 | 754  | 3662 | 78   | 1610 | 1187 | 1548 | 1548 | 1548 | 863  | 413  | 2565 |
| 2053 | 179  | 1503 | 452  | 2302 | 47   | 708  | 304  | 642  | 642  | 642  | 490  | 218  | 1813 |
| 2054 | 8    | 852  | 218  | 1617 | 16   | 273  | 176  | 273  | 273  | 273  | 90   | 148  | 1078 |
| 2055 | 55   | 490  | 148  | 1633 | 0    | 172  | 152  | 172  | 172  | 172  | 78   | 82   | 989  |
| 2056 | 20   | 90   | 82   | 970  | 0    | 82   | 82   | 82   | 82   | 82   | 31   | 78   | 516  |
| 2057 | 0    | 78   | 78   | 480  | 0    | 47   | 47   | 47   | 47   | 47   | 0    | 0    | 261  |
| 2058 | 0    | 31   | 39   | 300  | 0    | 39   | 0    | 39   | 39   | 39   | 0    | 0    | 199  |
| 2059 | 0    | 0    | 27   | 207  | 0    | 0    | 0    | 8    | 8    | 8    | 0    | 0    | 101  |

| 12%  | 144 | 145 | 146 | 147 | 148 | 149 | 150 | 151 | 152 | 153 | 154 | 155 | 156 |
|------|-----|-----|-----|-----|-----|-----|-----|-----|-----|-----|-----|-----|-----|
| 2060 | 0   | 0   | 0   | 86  | 0   | 0   | 0   | 0   | 0   | 0   | 0   | 0   | 59  |
| 2061 | 0   | 0   | 0   | 59  | 0   | 0   | 0   | 0   | 0   | 0   | 0   | 0   | 39  |
| 2062 | 0   | 0   | 0   | 39  | 0   | 0   | 0   | 0   | 0   | 0   | 0   | 0   | 39  |
| 2063 | 0   | 0   | 0   | 39  | 0   | 0   | 0   | 0   | 0   | 0   | 0   | 0   | 0   |
| 2064 | 0   | 0   | 0   | 0   | 0   | 0   | 0   | 0   | 0   | 0   | 0   | 0   | 0   |
| 2065 | 0   | 0   | 0   | 0   | 0   | 0   | 0   | 0   | 0   | 0   | 0   | 0   | 0   |
| 2066 | 0   | 0   | 0   | 0   | 0   | 0   | 0   | 0   | 0   | 0   | 0   | 0   | 0   |
| 2067 | 0   | 0   | 0   | 0   | 0   | 0   | 0   | 0   | 0   | 0   | 0   | 0   | 0   |
| 2068 | 0   | 0   | 0   | 0   | 0   | 0   | 0   | 0   | 0   | 0   | 0   | 0   | 0   |
| 2069 | 0   | 0   | 0   | 0   | 0   | 0   | 0   | 0   | 0   | 0   | 0   | 0   | 0   |
| 2070 | 0   | 0   | 0   | 0   | 0   | 0   | 0   | 0   | 0   | 0   | 0   | 0   | 0   |
| 2071 | 0   | 0   | 0   | 0   | 0   | 0   | 0   | 0   | 0   | 0   | 0   | 0   | 0   |
| 2072 | 0   | 0   | 0   | 0   | 0   | 0   | 0   | 0   | 0   | 0   | 0   | 0   | 0   |
| 2073 | 0   | 0   | 0   | 0   | 0   | 0   | 0   | 0   | 0   | 0   | 0   | 0   | 0   |
| 2074 | 0   | 0   | 0   | 0   | 0   | 0   | 0   | 0   | 0   | 0   | 0   | 0   | 0   |
| 2075 | 0   | 0   | 0   | 0   | 0   | 0   | 0   | 0   | 0   | 0   | 0   | 0   | 0   |
| 2076 | 0   | 0   | 0   | 0   | 0   | 0   | 0   | 0   | 0   | 0   | 0   | 0   | 0   |
| 2077 | 0   | 0   | 0   | 0   | 0   | 0   | 0   | 0   | 0   | 0   | 0   | 0   | 0   |
| 2078 | 0   | 0   | 0   | 0   | 0   | 0   | 0   | 0   | 0   | 0   | 0   | 0   | 0   |
| 2079 | 0   | 0   | 0   | 0   | 0   | 0   | 0   | 0   | 0   | 0   | 0   | 0   | 0   |
| 2080 | 0   | 0   | 0   | 0   | 0   | 0   | 0   | 0   | 0   | 0   | 0   | 0   | 0   |
| 2081 | 0   | 0   | 0   | 0   | 0   | 0   | 0   | 0   | 0   | 0   | 0   | 0   | 0   |
| 2082 | 0   | 0   | 0   | 0   | 0   | 0   | 0   | 0   | 0   | 0   | 0   | 0   | 0   |
| 2083 | 0   | 0   | 0   | 0   | 0   | 0   | 0   | 0   | 0   | 0   | 0   | 0   | 0   |
| 2084 | 0   | 0   | 0   | 0   | 0   | 0   | 0   | 0   | 0   | 0   | 0   | 0   | 0   |
| 2085 | 0   | 0   | 0   | 0   | 0   | 0   | 0   | 0   | 0   | 0   | 0   | 0   | 0   |
| 2086 | 0   | 0   | 0   | 0   | 0   | 0   | 0   | 0   | 0   | 0   | 0   | 0   | 0   |
| 2087 | 0   | 0   | 0   | 0   | 0   | 0   | 0   | 0   | 0   | 0   | 0   | 0   | 0   |
| 2088 | 0   | 0   | 0   | 0   | 0   | 0   | 0   | 0   | 0   | 0   | 0   | 0   | 0   |
| 2089 | 0   | 0   | 0   | 0   | 0   | 0   | 0   | 0   | 0   | 0   | 0   | 0   | 0   |
| 2090 | 0   | 0   | 0   | 0   | 0   | 0   | 0   | 0   | 0   | 0   | 0   | 0   | 0   |

| 12%  | 157  | 158  | 159  | 160  | 161  | 162  |
|------|------|------|------|------|------|------|
| 2002 | 0    | 0    | 0    | 0    | 0    | 0    |
| 2003 | 0    | 0    | 0    | 0    | 0    | 0    |
| 2004 | 0    | 0    | 0    | 0    | 0    | 0    |
| 2005 | 0    | 0    | 0    | 0    | 0    | 0    |
| 2006 | 0    | 0    | 0    | 0    | 0    | 0    |
| 2007 | 0    | 0    | 0    | 0    | 0    | 0    |
| 2008 | 0    | 0    | 0    | 0    | 0    | 0    |
| 2009 | 0    | 0    | 0    | 0    | 0    | 0    |
| 2010 | 0    | 0    | 0    | 0    | 0    | 0    |
| 2011 | 0    | 0    | 0    | 0    | 0    | 0    |
| 2012 | 0    | 0    | 0    | 0    | 0    | 0    |
| 2013 | 0    | 0    | 0    | 0    | 0    | 0    |
| 2014 | 0    | 0    | 0    | 0    | 0    | 0    |
| 2015 | 0    | 0    | 0    | 0    | 0    | 0    |
| 2016 | 0    | 0    | 0    | 0    | 0    | 0    |
| 2017 | 0    | 0    | 0    | 0    | 0    | 0    |
| 2018 | 0    | 0    | 0    | 0    | 0    | 0    |
| 2019 | 0    | 0    | 0    | 0    | 0    | 0    |
| 2020 | 39   | 0    | 0    | 0    | 0    | 0    |
| 2021 | 3724 | 0    | 0    | 0    | 0    | 0    |
| 2022 | 2899 | 0    | 0    | 0    | 0    | 0    |
| 2023 | 1963 | 0    | 0    | 0    | 0    | 0    |
| 2024 | 1519 | 0    | 0    | 0    | 0    | 0    |
| 2025 | 831  | 47   | 246  | 250  | 4    | 66   |
| 2026 | 823  | 3551 | 3969 | 3903 | 1760 | 3625 |
| 2027 | 886  | 3414 | 3388 | 3517 | 1929 | 3220 |
| 2028 | 839  | 1983 | 2493 | 2360 | 1340 | 2056 |
| 2029 | 937  | 1063 | 1487 | 1444 | 1363 | 1156 |
| 2030 | 1003 | 1330 | 1705 | 1763 | 1854 | 1522 |
| 2031 | 630  | 953  | 1320 | 1417 | 1838 | 1086 |
| 2032 | 523  | 690  | 1241 | 1343 | 978  | 1034 |
| 2033 | 481  | 1189 | 1215 | 1213 | 946  | 964  |
| 2034 | 1038 | 933  | 1100 | 1401 | 1146 | 1101 |
| 2035 | 733  | 296  | 499  | 784  | 372  | 406  |
| 2036 | 763  | 567  | 781  | 965  | 513  | 672  |
| 2037 | 599  | 654  | 845  | 1079 | 521  | 662  |
| 2038 | 355  | 607  | 868  | 1087 | 772  | 786  |
| 2039 | 238  | 352  | 531  | 890  | 336  | 562  |
| 2040 | 281  | 560  | 993  | 1087 | 643  | 736  |
| 2041 | 367  | 705  | 904  | 1106 | 541  | 630  |
| 2042 | 1167 | 623  | 1483 | 1655 | 891  | 1179 |
| 2043 | 874  | 378  | 864  | 749  | 277  | 429  |
| 2044 | 1045 | 525  | 632  | 874  | 297  | 441  |
| 2045 | 5145 | 285  | 1072 | 729  | 215  | 429  |
| 2046 | 2748 | 78   | 1099 | 569  | 569  | 569  |
| 2047 | 1302 | 39   | 750  | 5106 | 5106 | 5106 |
| 2048 | 459  | 5750 | 5065 | 3863 | 3863 | 3863 |
| 2049 | 290  | 3769 | 2943 | 2050 | 2050 | 2050 |
| 2050 | 47   | 2042 | 1905 | 1575 | 1575 | 1575 |
| 2051 | 39   | 1379 | 1128 | 716  | 716  | 716  |
| 2052 | 0    | 571  | 312  | 265  | 265  | 265  |
| 2053 | 0    | 254  | 176  | 172  | 172  | 172  |
| 2054 | 0    | 152  | 152  | 82   | 82   | 82   |
| 2055 | 0    | 82   | 82   | 47   | 47   | 47   |
| 2056 | 0    | 47   | 47   | 39   | 39   | 39   |
| 2057 | 0    | 39   | 39   | 8    | 8    | 8    |
| 2058 | 0    | 8    | 0    | 0    | 0    | 0    |
| 2059 | 0    | 0    | 0    | 0    | 0    | 0    |

| 12%  | 157 | 158 | 159 | 160 | 161 | 162 |
|------|-----|-----|-----|-----|-----|-----|
| 2060 | 0   | 0   | 0   | 0   | 0   | 0   |
| 2061 | 0   | 0   | 0   | 0   | 0   | 0   |
| 2062 | 0   | 0   | 0   | 0   | 0   | 0   |
| 2063 | 0   | 0   | 0   | 0   | 0   | 0   |
| 2064 | 0   | 0   | 0   | 0   | 0   | 0   |
| 2065 | 0   | 0   | 0   | 0   | 0   | 0   |
| 2066 | 0   | 0   | 0   | 0   | 0   | 0   |
| 2067 | 0   | 0   | 0   | 0   | 0   | 0   |
| 2068 | 0   | 0   | 0   | 0   | 0   | 0   |
| 2069 | 0   | 0   | 0   | 0   | 0   | 0   |
| 2070 | 0   | 0   | 0   | 0   | 0   | 0   |
| 2071 | 0   | 0   | 0   | 0   | 0   | 0   |
| 2072 | 0   | 0   | 0   | 0   | 0   | 0   |
| 2073 | 0   | 0   | 0   | 0   | 0   | 0   |
| 2074 | 0   | 0   | 0   | 0   | 0   | 0   |
| 2075 | 0   | 0   | 0   | 0   | 0   | 0   |
| 2076 | 0   | 0   | 0   | 0   | 0   | 0   |
| 2077 | 0   | 0   | 0   | 0   | 0   | 0   |
| 2078 | 0   | 0   | 0   | 0   | 0   | 0   |
| 2079 | 0   | 0   | 0   | 0   | 0   | 0   |
| 2080 | 0   | 0   | 0   | 0   | 0   | 0   |
| 2081 | 0   | 0   | 0   | 0   | 0   | 0   |
| 2082 | 0   | 0   | 0   | 0   | 0   | 0   |
| 2083 | 0   | 0   | 0   | 0   | 0   | 0   |
| 2084 | 0   | 0   | 0   | 0   | 0   | 0   |
| 2085 | 0   | 0   | 0   | 0   | 0   | 0   |
| 2086 | 0   | 0   | 0   | 0   | 0   | 0   |
| 2087 | 0   | 0   | 0   | 0   | 0   | 0   |
| 2088 | 0   | 0   | 0   | 0   | 0   | 0   |
| 2089 | 0   | 0   | 0   | 0   | 0   | 0   |
| 2090 | 0   | 0   | 0   | 0   | 0   | 0   |

| 12%  | 1    | 2    | 3    | 4    | 5    | 6    | 7    | 8    | 9    | 10  | 11  | 12  | 13  |
|------|------|------|------|------|------|------|------|------|------|-----|-----|-----|-----|
| 2002 |      | 0    | 0    | 0    | 0    | 0    | 0    | 0    | 0    | 0   | 0   | 0   | 0   |
| 2003 | 0    | 0    | 0    | 0    | 0    | 0    | 0    | 0    | 0    | 0   | 0   | 0   | 0   |
| 2004 | 0    | 0    | 0    | 0    | 0    | 0    | 0    | 0    | 0    | 0   | 0   | 0   | 0   |
| 2005 | 0    | 0    | 0    | 0    | 0    | 0    | 0    | 0    | 0    | 0   | 0   | 0   | 0   |
| 2006 | 0    | 0    | 0    | 0    | 0    | 0    | 0    | 0    | 0    | 0   | 0   | 0   | 0   |
| 2007 | 0    | 0    | 0    | 0    | 0    | 0    | 0    | 0    | 0    | 0   | 0   | 0   | 0   |
| 2008 | 0    | 0    | 0    | 0    | 0    | 0    | 0    | 0    | 0    | 0   | 0   | 0   | 0   |
| 2009 | 0    | 0    | 0    | 0    | 0    | 0    | 0    | 0    | 0    | 0   | 0   | 0   | 0   |
| 2010 | 0    | 0    | 0    | 0    | 0    | 0    | 0    | 0    | 0    | 0   | 0   | 0   | 0   |
| 2011 | 0    | 0    | 0    | 0    | 0    | 0    | 0    | 0    | 0    | 0   | 0   | 0   | 0   |
| 2012 | 0    | 0    | 0    | 0    | 0    | 0    | 0    | 0    | 0    | 0   | 0   | 0   | 0   |
| 2013 | 0    | 0    | 0    | 0    | 0    | 0    | 0    | 0    | 0    | 0   | 0   | 0   | 0   |
| 2014 | 0    | 0    | 0    | 0    | 0    | 0    | 0    | 0    | 0    | 0   | 0   | 0   | 0   |
| 2015 | 0    | 0    | 0    | 0    | 0    | 0    | 0    | 0    | 0    | 0   | 0   | 0   | 0   |
| 2016 | 0    | 0    | 0    | 0    | 0    | 0    | 0    | 0    | 0    | 0   | 0   | 0   | 0   |
| 2017 | 0    | 0    | 0    | 0    | 0    | 0    | 0    | 0    | 0    | 0   | 0   | 0   | 0   |
| 2018 | 0    | 0    | 0    | 0    | 0    | 0    | 0    | 0    | 0    | 0   | 0   | 0   | 0   |
| 2019 | 0    | 0    | 0    | 0    | 0    | 0    | 0    | 0    | 0    | 0   | 0   | 0   | 0   |
| 2020 | 0    | 0    | 0    | 991  | 0    | 0    | 0    | 0    | 0    | 0   | 0   | 0   | 351 |
| 2021 | 0    | 0    | 0    | 983  | 0    | 0    | 0    | 0    | 0    | 0   | 0   | 0   | 355 |
| 2022 | 0    | 0    | 0    | 991  | 0    | 0    | 0    | 0    | 0    | 0   | 0   | 0   | 413 |
| 2023 | 0    | 0    | 0    | 1002 | 0    | 0    | 0    | 0    | 0    | 0   | 0   | 0   | 452 |
| 2024 | 0    | 0    | 0    | 979  | 0    | 0    | 0    | 0    | 0    | 0   | 0   | 0   | 620 |
| 2025 | 998  | 998  | 0    | 1049 | 998  | 998  | 998  | 998  | 998  | 277 | 277 | 0   | 495 |
| 2026 | 975  | 975  | 0    | 998  | 975  | 975  | 975  | 975  | 975  | 347 | 374 | 0   | 550 |
| 2027 | 979  | 979  | 0    | 1002 | 979  | 979  | 979  | 979  | 979  | 335 | 355 | 0   | 632 |
| 2028 | 991  | 991  | 0    | 998  | 991  | 991  | 991  | 991  | 991  | 433 | 449 | 0   | 761 |
| 2029 | 975  | 975  | 0    | 1115 | 975  | 975  | 975  | 975  | 975  | 445 | 464 | 0   | 784 |
| 2030 | 983  | 983  | 998  | 1100 | 983  | 983  | 983  | 983  | 983  | 542 | 593 | 257 | 686 |
| 2031 | 1006 | 1006 | 987  | 1045 | 1006 | 1022 | 1006 | 1006 | 1006 | 640 | 702 | 402 | 690 |
| 2032 | 998  | 998  | 975  | 1170 | 998  | 1088 | 998  | 971  | 998  | 651 | 741 | 452 | 803 |
| 2033 | 1022 | 1034 | 1002 | 1236 | 975  | 1088 | 1034 | 1014 | 1034 | 694 | 733 | 546 | 577 |
| 2034 | 1030 | 1030 | 994  | 1002 | 1010 | 1065 | 1030 | 878  | 1030 | 655 | 663 | 566 | 628 |
| 2035 | 1080 | 1080 | 983  | 1248 | 1041 | 1069 | 1080 | 839  | 1080 | 663 | 737 | 663 | 616 |
| 2036 | 1213 | 1217 | 1041 | 998  | 1104 | 1041 | 1221 | 811  | 1217 | 585 | 737 | 640 | 503 |
| 2037 | 1162 | 1190 | 1022 | 764  | 1073 | 1151 | 1197 | 901  | 1190 | 503 | 702 | 667 | 573 |
| 2038 | 1264 | 1283 | 1022 | 889  | 1326 | 1197 | 1303 | 846  | 1283 | 507 | 597 | 784 | 577 |
| 2039 | 952  | 1049 | 1026 | 944  | 1084 | 1037 | 1092 | 690  | 1030 | 468 | 515 | 729 | 534 |
| 2040 | 1213 | 1275 | 1096 | 932  | 1275 | 1225 | 1303 | 944  | 1252 | 686 | 757 | 624 | 433 |
| 2041 | 913  | 952  | 1104 | 605  | 975  | 920  | 1061 | 585  | 905  | 608 | 675 | 663 | 445 |
| 2042 | 1002 | 1244 | 1260 | 386  | 1338 | 1221 | 1338 | 874  | 1217 | 698 | 722 | 823 | 429 |
| 2043 | 593  | 468  | 1232 | 526  | 156  | 569  | 511  | 425  | 503  | 628 | 694 | 772 | 351 |
| 2044 | 515  | 702  | 1014 | 332  | 655  | 624  | 632  | 632  | 632  | 562 | 636 | 721 | 359 |
| 2045 | 554  | 862  | 456  | 273  | 749  | 807  | 772  | 772  | 772  | 394 | 550 | 698 | 218 |
| 2046 | 413  | 737  | 792  | 230  | 722  | 589  | 714  | 714  | 714  | 398 | 491 | 608 | 156 |
| 2047 | 281  | 796  | 928  | 35   | 608  | 616  | 686  | 686  | 686  | 332 | 409 | 410 | 82  |
| 2048 | 179  | 659  | 796  | 0    | 484  | 452  | 425  | 425  | 425  | 140 | 242 | 577 | 39  |
| 2049 | 328  | 538  | 729  | 0    | 394  | 308  | 371  | 371  | 370  | 183 | 242 | 792 | 885 |
| 2050 | 452  | 644  | 690  | 0    | 527  | 562  | 530  | 530  | 530  | 640 | 823 | 718 | 308 |
| 2051 | 140  | 659  | 710  | 0    | 620  | 632  | 577  | 577  | 577  | 437 | 679 | 491 | 27  |
| 2052 | 0    | 597  | 558  | 0    | 449  | 289  | 257  | 257  | 257  | 382 | 663 | 632 | 0   |
| 2053 | 0    | 394  | 441  | 0    | 74   | 66   | 66   | 66   | 66   | 285 | 846 | 753 | 0   |
| 2054 | 0    | 250  | 632  | 0    | 0    | 0    | 0    | 0    | 0    | 160 | 764 | 616 | 0   |
| 2055 | 0    | 47   | 632  | 0    | 0    | 0    | 0    | 0    | 0    | 0   | 452 | 733 | 0   |
| 2056 | 0    | 0    | 776  | 0    | 0    | 0    | 0    | 0    | 0    | 0   | 246 | 679 | 0   |
| 2057 | 0    | 0    | 523  | 0    | 0    | 0    | 0    | 0    | 0    | 0   | 164 | 542 | 0   |
| 2058 | 0    | 0    | 296  | 0    | 0    | 0    | 0    | 0    | 0    | 0   | 78  | 378 | 0   |
| 2059 | 0    | 0    | 179  | 0    | 0    | 0    | 0    | 0    | 0    | 0   | 0   | 218 | 0   |

| 12%  | 1 | 2 | 3  | 4 | 5 | 6 | 7 | 8 | 9 | 10 | 11 | 12  | 13 |
|------|---|---|----|---|---|---|---|---|---|----|----|-----|----|
| 2060 | 0 | 0 | 66 | 0 | 0 | 0 | 0 | 0 | 0 | 0  | 0  | 160 | 0  |
| 2061 | 0 | 0 | 0  | 0 | 0 | 0 | 0 | 0 | 0 | 0  | 0  | 70  | 0  |
| 2062 | 0 | 0 | 0  | 0 | 0 | 0 | 0 | 0 | 0 | 0  | 0  | 35  | 0  |
| 2063 | 0 | 0 | 0  | 0 | 0 | 0 | 0 | 0 | 0 | 0  | 0  | 0   | 0  |
| 2064 | 0 | 0 | 0  | 0 | 0 | 0 | 0 | 0 | 0 | 0  | 0  | 0   | 0  |
| 2065 | 0 | 0 | 0  | 0 | 0 | 0 | 0 | 0 | 0 | 0  | 0  | 0   | 0  |
| 2066 | 0 | 0 | 0  | 0 | 0 | 0 | 0 | 0 | 0 | 0  | 0  | 0   | 0  |
| 2067 | 0 | 0 | 0  | 0 | 0 | 0 | 0 | 0 | 0 | 0  | 0  | 0   | 0  |
| 2068 | 0 | 0 | 0  | 0 | 0 | 0 | 0 | 0 | 0 | 0  | 0  | 0   | 0  |
| 2069 | 0 | 0 | 0  | 0 | 0 | 0 | 0 | 0 | 0 | 0  | 0  | 0   | 0  |
| 2070 | 0 | 0 | 0  | 0 | 0 | 0 | 0 | 0 | 0 | 0  | 0  | 0   | 0  |
| 2071 | 0 | 0 | 0  | 0 | 0 | 0 | 0 | 0 | 0 | 0  | 0  | 0   | 0  |
| 2072 | 0 | 0 | 0  | 0 | 0 | 0 | 0 | 0 | 0 | 0  | 0  | 0   | 0  |
| 2073 | 0 | 0 | 0  | 0 | 0 | 0 | 0 | 0 | 0 | 0  | 0  | 0   | 0  |
| 2074 | 0 | 0 | 0  | 0 | 0 | 0 | 0 | 0 | 0 | 0  | 0  | 0   | 0  |
| 2075 | 0 | 0 | 0  | 0 | 0 | 0 | 0 | 0 | 0 | 0  | 0  | 0   | 0  |
| 2076 | 0 | 0 | 0  | 0 | 0 | 0 | 0 | 0 | 0 | 0  | 0  | 0   | 0  |
| 2077 | 0 | 0 | 0  | 0 | 0 | 0 | 0 | 0 | 0 | 0  | 0  | 0   | 0  |
| 2078 | 0 | 0 | 0  | 0 | 0 | 0 | 0 | 0 | 0 | 0  | 0  | 0   | 0  |
| 2079 | 0 | 0 | 0  | 0 | 0 | 0 | 0 | 0 | 0 | 0  | 0  | 0   | 0  |
| 2080 | 0 | 0 | 0  | 0 | 0 | 0 | 0 | 0 | 0 | 0  | 0  | 0   | 0  |
| 2081 | 0 | 0 | 0  | 0 | 0 | 0 | 0 | 0 | 0 | 0  | 0  | 0   | 0  |
| 2082 | 0 | 0 | 0  | 0 | 0 | 0 | 0 | 0 | 0 | 0  | 0  | 0   | 0  |
| 2083 | 0 | 0 | 0  | 0 | 0 | 0 | 0 | 0 | 0 | 0  | 0  | 0   | 0  |
| 2084 | 0 | 0 | 0  | 0 | 0 | 0 | 0 | 0 | 0 | 0  | 0  | 0   | 0  |
| 2085 | 0 | 0 | 0  | 0 | 0 | 0 | 0 | 0 | 0 | 0  | 0  | 0   | 0  |
| 2086 | 0 | 0 | 0  | 0 | 0 | 0 | 0 | 0 | 0 | 0  | 0  | 0   | 0  |
| 2087 | 0 | 0 | 0  | 0 | 0 | 0 | 0 | 0 | 0 | 0  | 0  | 0   | 0  |
| 2088 | 0 | 0 | 0  | 0 | 0 | 0 | 0 | 0 | 0 | 0  | 0  | 0   | 0  |
| 2089 | 0 | 0 | 0  | 0 | 0 | 0 | 0 | 0 | 0 | 0  | 0  | 0   | 0  |
| 2090 | 0 | 0 | 0  | 0 | 0 | 0 | 0 | 0 | 0 | 0  | 0  | 0   | 0  |



| 12%  | 14  | 15  | 16   | 17  | 18  | 19  | 20  | 21  | 22  | 23  | 24  | 25  | 26  |
|------|-----|-----|------|-----|-----|-----|-----|-----|-----|-----|-----|-----|-----|
| 2002 | 0   | 0   | 0    | 0   | 0   | 0   | 0   | 0   | 0   | 0   | 0   | 0   | 0   |
| 2003 | 0   | 0   | 0    | 0   | 0   | 0   | 0   | 0   | 0   | 0   | 0   | 0   | 0   |
| 2004 | 0   | 0   | 0    | 0   | 0   | 0   | 0   | 0   | 0   | 0   | 0   | 0   | 0   |
| 2005 | 0   | 0   | 0    | 0   | 0   | 0   | 0   | 0   | 0   | 0   | 0   | 0   | 0   |
| 2006 | 0   | 0   | 0    | 0   | 0   | 0   | 0   | 0   | 0   | 0   | 0   | 0   | 0   |
| 2007 | 0   | 0   | 0    | 0   | 0   | 0   | 0   | 0   | 0   | 0   | 0   | 0   | 0   |
| 2008 | 0   | 0   | 0    | 0   | 0   | 0   | 0   | 0   | 0   | 0   | 0   | 0   | 0   |
| 2009 | 0   | 0   | 0    | 0   | 0   | 0   | 0   | 0   | 0   | 0   | 0   | 0   | 0   |
| 2010 | 0   | 0   | 0    | 0   | 0   | 0   | 0   | 0   | 0   | 0   | 0   | 0   | 0   |
| 2011 | 0   | 0   | 0    | 0   | 0   | 0   | 0   | 0   | 0   | 0   | 0   | 0   | 0   |
| 2012 | 0   | 0   | 0    | 0   | 0   | 0   | 0   | 0   | 0   | 0   | 0   | 0   | 0   |
| 2013 | 0   | 0   | 0    | 0   | 0   | 0   | 0   | 0   | 0   | 0   | 0   | 0   | 0   |
| 2014 | 0   | 0   | 0    | 0   | 0   | 0   | 0   | 0   | 0   | 0   | 0   | 0   | 0   |
| 2015 | 0   | 0   | 0    | 0   | 0   | 0   | 0   | 0   | 0   | 0   | 0   | 0   | 0   |
| 2016 | 0   | 0   | 0    | 0   | 0   | 0   | 0   | 0   | 0   | 0   | 0   | 0   | 0   |
| 2017 | 0   | 0   | 0    | 0   | 0   | 0   | 0   | 0   | 0   | 0   | 0   | 0   | 0   |
| 2018 | 0   | 0   | 0    | 0   | 0   | 0   | 0   | 0   | 0   | 0   | 0   | 0   | 0   |
| 2019 | 0   | 0   | 0    | 0   | 0   | 0   | 0   | 0   | 0   | 0   | 0   | 0   | 0   |
| 2020 | 0   | 0   | 0    | 0   | 0   | 0   | 0   | 0   | 39  | 0   | 0   | 0   | 0   |
| 2021 | 0   | 0   | 0    | 0   | 0   | 0   | 0   | 0   | 62  | 0   | 0   | 0   | 0   |
| 2022 | 0   | 0   | 0    | 0   | 0   | 0   | 0   | 0   | 86  | 0   | 0   | 0   | 0   |
| 2023 | 0   | 0   | 0    | 0   | 0   | 0   | 0   | 0   | 183 | 0   | 0   | 0   | 0   |
| 2024 | 0   | 0   | 0    | 0   | 0   | 0   | 0   | 0   | 152 | 0   | 0   | 0   | 0   |
| 2025 | 250 | 679 | 952  | 16  | 277 | 66  | 66  | 0   | 199 | 47  | 246 | 250 | 4   |
| 2026 | 339 | 667 | 952  | 90  | 367 | 137 | 144 | 0   | 195 | 51  | 445 | 367 | 20  |
| 2027 | 390 | 667 | 991  | 35  | 335 | 105 | 125 | 0   | 199 | 39  | 328 | 367 | 20  |
| 2028 | 507 | 640 | 944  | 109 | 464 | 140 | 164 | 0   | 211 | 98  | 515 | 441 | 51  |
| 2029 | 484 | 616 | 995  | 207 | 484 | 261 | 281 | 0   | 281 | 140 | 554 | 491 | 148 |
| 2030 | 651 | 667 | 1034 | 164 | 601 | 273 | 320 | 39  | 355 | 183 | 437 | 573 | 113 |
| 2031 | 585 | 620 | 944  | 187 | 675 | 226 | 289 | 140 | 355 | 164 | 534 | 554 | 66  |
| 2032 | 647 | 655 | 956  | 250 | 694 | 226 | 281 | 207 | 413 | 211 | 515 | 620 | 105 |
| 2033 | 718 | 573 | 944  | 316 | 694 | 293 | 343 | 238 | 343 | 230 | 398 | 573 | 148 |
| 2034 | 675 | 671 | 1006 | 312 | 655 | 332 | 363 | 304 | 374 | 246 | 573 | 608 | 187 |
| 2035 | 644 | 601 | 1010 | 277 | 737 | 339 | 374 | 316 | 324 | 207 | 605 | 741 | 211 |
| 2036 | 675 | 632 | 885  | 367 | 690 | 363 | 413 | 289 | 351 | 250 | 550 | 683 | 234 |
| 2037 | 573 | 690 | 788  | 316 | 608 | 355 | 449 | 421 | 304 | 320 | 511 | 722 | 195 |
| 2038 | 515 | 593 | 686  | 176 | 534 | 413 | 530 | 382 | 273 | 316 | 390 | 593 | 195 |
| 2039 | 511 | 679 | 706  | 179 | 515 | 312 | 456 | 445 | 308 | 296 | 394 | 706 | 215 |
| 2040 | 534 | 589 | 874  | 195 | 702 | 273 | 370 | 507 | 308 | 207 | 538 | 636 | 160 |
| 2041 | 667 | 612 | 819  | 269 | 616 | 269 | 351 | 441 | 374 | 238 | 546 | 749 | 246 |
| 2042 | 651 | 807 | 846  | 382 | 718 | 320 | 382 | 398 | 468 | 179 | 796 | 846 | 168 |
| 2043 | 608 | 616 | 761  | 371 | 651 | 320 | 433 | 480 | 406 | 265 | 562 | 671 | 242 |
| 2044 | 608 | 476 | 663  | 335 | 593 | 312 | 359 | 441 | 168 | 246 | 620 | 640 | 226 |
| 2045 | 581 | 534 | 608  | 371 | 507 | 394 | 429 | 382 | 417 | 215 | 612 | 640 | 176 |
| 2046 | 523 | 511 | 519  | 238 | 449 | 257 | 339 | 410 | 655 | 156 | 577 | 515 | 226 |
| 2047 | 328 | 675 | 530  | 187 | 406 | 445 | 550 | 90  | 331 | 585 | 503 | 527 | 527 |
| 2048 | 406 | 175 | 281  | 152 | 195 | 448 | 714 | 569 | 43  | 690 | 784 | 702 | 702 |
| 2049 | 515 | 445 | 203  | 203 | 203 | 445 | 686 | 835 | 0   | 371 | 737 | 616 | 616 |
| 2050 | 370 | 858 | 745  | 745 | 745 | 367 | 659 | 714 | 0   | 612 | 729 | 651 | 651 |
| 2051 | 718 | 764 | 675  | 675 | 675 | 367 | 815 | 398 | 0   | 686 | 523 | 647 | 647 |
| 2052 | 741 | 585 | 706  | 706 | 706 | 230 | 862 | 690 | 0   | 643 | 265 | 589 | 589 |
| 2053 | 651 | 491 | 585  | 585 | 585 | 62  | 597 | 690 | 0   | 499 | 105 | 316 | 316 |
| 2054 | 398 | 199 | 488  | 488 | 487 | 0   | 328 | 651 | 0   | 378 | 4   | 101 | 101 |
| 2055 | 183 | 23  | 172  | 172 | 172 | 0   | 222 | 757 | 0   | 78  | 0   | 0   | 0   |
| 2056 | 35  | 0   | 39   | 39  | 39  | 0   | 144 | 737 | 0   | 0   | 0   | 0   | 0   |
| 2057 | 0   | 0   | 0    | 0   | 0   | 0   | 27  | 667 | 0   | 0   | 0   | 0   | 0   |
| 2058 | 0   | 0   | 0    | 0   | 0   | 0   | 0   | 530 | 0   | 0   | 0   | 0   | 0   |
| 2059 | 0   | 0   | 0    | 0   | 0   | 0   | 0   | 261 | 0   | 0   | 0   | 0   | 0   |

| 12%  | 14 | 15 | 16 | 17 | 18 | 19 | 20 | 21  | 22 | 23 | 24 | 25 | 26 |
|------|----|----|----|----|----|----|----|-----|----|----|----|----|----|
| 2060 | 0  | 0  | 0  | 0  | 0  | 0  | 0  | 160 | 0  | 0  | 0  | 0  | 0  |
| 2061 | 0  | 0  | 0  | 0  | 0  | 0  | 0  | 94  | 0  | 0  | 0  | 0  | 0  |
| 2062 | 0  | 0  | 0  | 0  | 0  | 0  | 0  | 20  | 0  | 0  | 0  | 0  | 0  |
| 2063 | 0  | 0  | 0  | 0  | 0  | 0  | 0  | 0   | 0  | 0  | 0  | 0  | 0  |
| 2064 | 0  | 0  | 0  | 0  | 0  | 0  | 0  | 0   | 0  | 0  | 0  | 0  | 0  |
| 2065 | 0  | 0  | 0  | 0  | 0  | 0  | 0  | 0   | 0  | 0  | 0  | 0  | 0  |
| 2066 | 0  | 0  | 0  | 0  | 0  | 0  | 0  | 0   | 0  | 0  | 0  | 0  | 0  |
| 2067 | 0  | 0  | 0  | 0  | 0  | 0  | 0  | 0   | 0  | 0  | 0  | 0  | 0  |
| 2068 | 0  | 0  | 0  | 0  | 0  | 0  | 0  | 0   | 0  | 0  | 0  | 0  | 0  |
| 2069 | 0  | 0  | 0  | 0  | 0  | 0  | 0  | 0   | 0  | 0  | 0  | 0  | 0  |
| 2070 | 0  | 0  | 0  | 0  | 0  | 0  | 0  | 0   | 0  | 0  | 0  | 0  | 0  |
| 2071 | 0  | 0  | 0  | 0  | 0  | 0  | 0  | 0   | 0  | 0  | 0  | 0  | 0  |
| 2072 | 0  | 0  | 0  | 0  | 0  | 0  | 0  | 0   | 0  | 0  | 0  | 0  | 0  |
| 2073 | 0  | 0  | 0  | 0  | 0  | 0  | 0  | 0   | 0  | 0  | 0  | 0  | 0  |
| 2074 | 0  | 0  | 0  | 0  | 0  | 0  | 0  | 0   | 0  | 0  | 0  | 0  | 0  |
| 2075 | 0  | 0  | 0  | 0  | 0  | 0  | 0  | 0   | 0  | 0  | 0  | 0  | 0  |
| 2076 | 0  | 0  | 0  | 0  | 0  | 0  | 0  | 0   | 0  | 0  | 0  | 0  | 0  |
| 2077 | 0  | 0  | 0  | 0  | 0  | 0  | 0  | 0   | 0  | 0  | 0  | 0  | 0  |
| 2078 | 0  | 0  | 0  | 0  | 0  | 0  | 0  | 0   | 0  | 0  | 0  | 0  | 0  |
| 2079 | 0  | 0  | 0  | 0  | 0  | 0  | 0  | 0   | 0  | 0  | 0  | 0  | 0  |
| 2080 | 0  | 0  | 0  | 0  | 0  | 0  | 0  | 0   | 0  | 0  | 0  | 0  | 0  |
| 2081 | 0  | 0  | 0  | 0  | 0  | 0  | 0  | 0   | 0  | 0  | 0  | 0  | 0  |
| 2082 | 0  | 0  | 0  | 0  | 0  | 0  | 0  | 0   | 0  | 0  | 0  | 0  | 0  |
| 2083 | 0  | 0  | 0  | 0  | 0  | 0  | 0  | 0   | 0  | 0  | 0  | 0  | 0  |
| 2084 | 0  | 0  | 0  | 0  | 0  | 0  | 0  | 0   | 0  | 0  | 0  | 0  | 0  |
| 2085 | 0  | 0  | 0  | 0  | 0  | 0  | 0  | 0   | 0  | 0  | 0  | 0  | 0  |
| 2086 | 0  | 0  | 0  | 0  | 0  | 0  | 0  | 0   | 0  | 0  | 0  | 0  | 0  |
| 2087 | 0  | 0  | 0  | 0  | 0  | 0  | 0  | 0   | 0  | 0  | 0  | 0  | 0  |
| 2088 | 0  | 0  | 0  | 0  | 0  | 0  | 0  | 0   | 0  | 0  | 0  | 0  | 0  |
| 2089 | 0  | 0  | 0  | 0  | 0  | 0  | 0  | 0   | 0  | 0  | 0  | 0  | 0  |
| 2090 | 0  | 0  | 0  | 0  | 0  | 0  | 0  | 0   | 0  | 0  | 0  | 0  | 0  |

| 12%  | 27  | 28   | 29   | 30   | 31   | 32   | 33   | 34   | 35   | 36   | 37  | 38  | 39  |
|------|-----|------|------|------|------|------|------|------|------|------|-----|-----|-----|
| 2002 | 0   | 0    | 0    | 0    | 0    | 0    | 0    | 0    | 0    | 0    | 0   | 0   | 0   |
| 2003 | 0   | 0    | 0    | 0    | 0    | 0    | 0    | 0    | 0    | 0    | 0   | 0   | 0   |
| 2004 | 0   | 0    | 0    | 0    | 0    | 0    | 0    | 0    | 0    | 0    | 0   | 0   | 0   |
| 2005 | 0   | 0    | 0    | 0    | 0    | 0    | 0    | 0    | 0    | 0    | 0   | 0   | 0   |
| 2006 | 0   | 0    | 0    | 0    | 0    | 0    | 0    | 0    | 0    | 0    | 0   | 0   | 0   |
| 2007 | 0   | 0    | 0    | 0    | 0    | 0    | 0    | 0    | 0    | 0    | 0   | 0   | 0   |
| 2008 | 0   | 0    | 0    | 0    | 0    | 0    | 0    | 0    | 0    | 0    | 0   | 0   | 0   |
| 2009 | 0   | 0    | 0    | 0    | 0    | 0    | 0    | 0    | 0    | 0    | 0   | 0   | 0   |
| 2010 | 0   | 0    | 0    | 0    | 0    | 0    | 0    | 0    | 0    | 0    | 0   | 0   | 0   |
| 2011 | 0   | 0    | 0    | 0    | 0    | 0    | 0    | 0    | 0    | 0    | 0   | 0   | 0   |
| 2012 | 0   | 0    | 0    | 0    | 0    | 0    | 0    | 0    | 0    | 0    | 0   | 0   | 0   |
| 2013 | 0   | 0    | 0    | 0    | 0    | 0    | 0    | 0    | 0    | 0    | 0   | 0   | 0   |
| 2014 | 0   | 0    | 0    | 0    | 0    | 0    | 0    | 0    | 0    | 0    | 0   | 0   | 0   |
| 2015 | 0   | 0    | 0    | 0    | 0    | 0    | 0    | 0    | 0    | 0    | 0   | 0   | 0   |
| 2016 | 0   | 0    | 0    | 0    | 0    | 0    | 0    | 0    | 0    | 0    | 0   | 0   | 0   |
| 2017 | 0   | 0    | 0    | 0    | 0    | 0    | 0    | 0    | 0    | 0    | 0   | 0   | 0   |
| 2018 | 0   | 0    | 0    | 0    | 0    | 0    | 0    | 0    | 0    | 0    | 0   | 0   | 0   |
| 2019 | 0   | 0    | 0    | 0    | 0    | 0    | 0    | 0    | 0    | 0    | 0   | 0   | 0   |
| 2020 | 0   | 0    | 0    | 0    | 991  | 0    | 0    | 0    | 0    | 0    | 0   | 0   | 0   |
| 2021 | 0   | 0    | 0    | 0    | 983  | 0    | 0    | 0    | 0    | 0    | 0   | 0   | 0   |
| 2022 | 0   | 0    | 0    | 0    | 991  | 0    | 0    | 0    | 0    | 0    | 0   | 0   | 0   |
| 2023 | 0   | 0    | 0    | 0    | 1002 | 0    | 0    | 0    | 0    | 0    | 0   | 0   | 0   |
| 2024 | 0   | 0    | 0    | 0    | 979  | 0    | 0    | 0    | 0    | 0    | 0   | 0   | 0   |
| 2025 | 66  | 998  | 998  | 0    | 1049 | 998  | 998  | 998  | 998  | 998  | 277 | 277 | 0   |
| 2026 | 137 | 975  | 975  | 0    | 998  | 975  | 975  | 975  | 975  | 975  | 339 | 367 | 0   |
| 2027 | 117 | 979  | 979  | 0    | 1002 | 979  | 979  | 979  | 979  | 979  | 335 | 355 | 0   |
| 2028 | 172 | 991  | 991  | 0    | 998  | 991  | 991  | 991  | 991  | 991  | 429 | 445 | 0   |
| 2029 | 289 | 975  | 975  | 0    | 1115 | 975  | 975  | 975  | 975  | 975  | 425 | 425 | 0   |
| 2030 | 293 | 983  | 983  | 998  | 1088 | 983  | 983  | 983  | 983  | 983  | 534 | 550 | 257 |
| 2031 | 257 | 1006 | 1006 | 987  | 1034 | 1006 | 1022 | 1006 | 1006 | 1006 | 659 | 694 | 402 |
| 2032 | 273 | 998  | 998  | 975  | 1166 | 998  | 1084 | 998  | 971  | 998  | 632 | 706 | 429 |
| 2033 | 312 | 1022 | 1034 | 1002 | 1232 | 975  | 1069 | 1034 | 1014 | 1034 | 679 | 749 | 519 |
| 2034 | 328 | 1030 | 1030 | 994  | 1057 | 1010 | 1030 | 1030 | 878  | 1030 | 651 | 702 | 542 |
| 2035 | 359 | 1080 | 1080 | 983  | 1252 | 1041 | 1065 | 1080 | 839  | 1080 | 663 | 745 | 612 |
| 2036 | 413 | 1213 | 1217 | 1041 | 998  | 1104 | 991  | 1221 | 811  | 1217 | 597 | 698 | 589 |
| 2037 | 433 | 1135 | 1178 | 1022 | 753  | 1073 | 1123 | 1170 | 901  | 1162 | 581 | 686 | 628 |
| 2038 | 413 | 1268 | 1268 | 1022 | 932  | 1326 | 1053 | 1279 | 815  | 1260 | 550 | 612 | 788 |
| 2039 | 413 | 975  | 1030 | 1026 | 905  | 1084 | 1112 | 1076 | 725  | 1037 | 499 | 597 | 722 |
| 2040 | 367 | 1221 | 1310 | 1096 | 928  | 1275 | 1190 | 1310 | 948  | 1279 | 671 | 776 | 593 |
| 2041 | 335 | 917  | 901  | 1104 | 562  | 963  | 1084 | 1053 | 538  | 885  | 585 | 679 | 663 |
| 2042 | 339 | 983  | 1151 | 1232 | 296  | 1400 | 1123 | 1357 | 917  | 1252 | 647 | 714 | 803 |
| 2043 | 351 | 706  | 644  | 1248 | 335  | 281  | 1182 | 565  | 445  | 554  | 569 | 706 | 788 |
| 2044 | 339 | 234  | 632  | 959  | 355  | 550  | 491  | 503  | 503  | 503  | 534 | 690 | 854 |
| 2045 | 421 | 320  | 776  | 601  | 293  | 608  | 667  | 643  | 644  | 643  | 433 | 558 | 757 |
| 2046 | 312 | 386  | 722  | 714  | 273  | 647  | 698  | 608  | 608  | 608  | 425 | 507 | 663 |
| 2047 | 527 | 374  | 733  | 741  | 137  | 546  | 542  | 620  | 620  | 620  | 347 | 437 | 410 |
| 2048 | 702 | 285  | 679  | 694  | 43   | 507  | 456  | 476  | 476  | 476  | 179 | 285 | 480 |
| 2049 | 616 | 246  | 550  | 690  | 51   | 429  | 402  | 437  | 437  | 437  | 113 | 238 | 807 |
| 2050 | 651 | 269  | 647  | 612  | 8    | 460  | 433  | 390  | 390  | 390  | 390 | 819 | 683 |
| 2051 | 647 | 250  | 620  | 659  | 4    | 456  | 351  | 441  | 441  | 441  | 328 | 628 | 558 |
| 2052 | 589 | 176  | 546  | 589  | 8    | 425  | 261  | 335  | 335  | 335  | 316 | 729 | 632 |
| 2053 | 316 | 129  | 394  | 472  | 4    | 242  | 172  | 246  | 246  | 246  | 289 | 764 | 647 |
| 2054 | 101 | 70   | 242  | 569  | 0    | 152  | 121  | 156  | 156  | 156  | 296 | 722 | 573 |
| 2055 | 0   | 55   | 218  | 585  | 0    | 109  | 51   | 125  | 125  | 125  | 144 | 421 | 640 |
| 2056 | 0   | 8    | 74   | 566  | 0    | 35   | 16   | 20   | 20   | 20   | 78  | 246 | 690 |
| 2057 | 0   | 8    | 27   | 534  | 0    | 8    | 19   | 23   | 23   | 23   | 58  | 168 | 589 |
| 2058 | 0   | 0    | 27   | 390  | 0    | 23   | 0    | 0    | 0    | 0    | 31  | 109 | 402 |
| 2059 | 0   | 4    | 12   | 316  | 0    | 4    | 0    | 0    | 0    | 0    | 8   | 27  | 230 |

| 12%  | 27 | 28 | 29 | 30  | 31 | 32 | 33 | 34 | 35 | 36 | 37 | 38 | 39  |
|------|----|----|----|-----|----|----|----|----|----|----|----|----|-----|
| 2060 | 0  | 0  | 0  | 250 | 0  | 0  | 0  | 0  | 0  | 0  | 0  | 0  | 140 |
| 2061 | 0  | 0  | 0  | 175 | 0  | 0  | 0  | 0  | 0  | 0  | 4  | 0  | 105 |
| 2062 | 0  | 0  | 0  | 86  | 0  | 0  | 0  | 0  | 0  | 0  | 0  | 0  | 109 |
| 2063 | 0  | 0  | 0  | 20  | 0  | 0  | 0  | 0  | 0  | 0  | 0  | 0  | 105 |
| 2064 | 0  | 0  | 0  | 8   | 0  | 0  | 0  | 0  | 0  | 0  | 0  | 0  | 39  |
| 2065 | 0  | 0  | 0  | 12  | 0  | 0  | 0  | 0  | 0  | 0  | 0  | 0  | 0   |
| 2066 | 0  | 0  | 0  | 4   | 0  | 0  | 0  | 0  | 0  | 0  | 0  | 0  | 0   |
| 2067 | 0  | 0  | 0  | 0   | 0  | 0  | 0  | 0  | 0  | 0  | 0  | 0  | 0   |
| 2068 | 0  | 0  | 0  | 0   | 0  | 0  | 0  | 0  | 0  | 0  | 0  | 0  | 0   |
| 2069 | 0  | 0  | 0  | 0   | 0  | 0  | 0  | 0  | 0  | 0  | 0  | 0  | 0   |
| 2070 | 0  | 0  | 0  | 0   | 0  | 0  | 0  | 0  | 0  | 0  | 0  | 0  | 0   |
| 2071 | 0  | 0  | 0  | 0   | 0  | 0  | 0  | 0  | 0  | 0  | 0  | 0  | 0   |
| 2072 | 0  | 0  | 0  | 0   | 0  | 0  | 0  | 0  | 0  | 0  | 0  | 0  | 0   |
| 2073 | 0  | 0  | 0  | 0   | 0  | 0  | 0  | 0  | 0  | 0  | 0  | 0  | 0   |
| 2074 | 0  | 0  | 0  | 0   | 0  | 0  | 0  | 0  | 0  | 0  | 0  | 0  | 0   |
| 2075 | 0  | 0  | 0  | 0   | 0  | 0  | 0  | 0  | 0  | 0  | 0  | 0  | 0   |
| 2076 | 0  | 0  | 0  | 0   | 0  | 0  | 0  | 0  | 0  | 0  | 0  | 0  | 0   |
| 2077 | 0  | 0  | 0  | 0   | 0  | 0  | 0  | 0  | 0  | 0  | 0  | 0  | 0   |
| 2078 | 0  | 0  | 0  | 0   | 0  | 0  | 0  | 0  | 0  | 0  | 0  | 0  | 0   |
| 2079 | 0  | 0  | 0  | 0   | 0  | 0  | 0  | 0  | 0  | 0  | 0  | 0  | 0   |
| 2080 | 0  | 0  | 0  | 0   | 0  | 0  | 0  | 0  | 0  | 0  | 0  | 0  | 0   |
| 2081 | 0  | 0  | 0  | 0   | 0  | 0  | 0  | 0  | 0  | 0  | 0  | 0  | 0   |
| 2082 | 0  | 0  | 0  | 0   | 0  | 0  | 0  | 0  | 0  | 0  | 0  | 0  | 0   |
| 2083 | 0  | 0  | 0  | 0   | 0  | 0  | 0  | 0  | 0  | 0  | 0  | 0  | 0   |
| 2084 | 0  | 0  | 0  | 0   | 0  | 0  | 0  | 0  | 0  | 0  | 0  | 0  | 0   |
| 2085 | 0  | 0  | 0  | 0   | 0  | 0  | 0  | 0  | 0  | 0  | 0  | 0  | 0   |
| 2086 | 0  | 0  | 0  | 0   | 0  | 0  | 0  | 0  | 0  | 0  | 0  | 0  | 0   |
| 2087 | 0  | 0  | 0  | 0   | 0  | 0  | 0  | 0  | 0  | 0  | 0  | 0  | 0   |
| 2088 | 0  | 0  | 0  | 0   | 0  | 0  | 0  | 0  | 0  | 0  | 0  | 0  | 0   |
| 2089 | 0  | 0  | 0  | 0   | 0  | 0  | 0  | 0  | 0  | 0  | 0  | 0  | 0   |
| 2090 | 0  | 0  | 0  | 0   | 0  | 0  | 0  | 0  | 0  | 0  | 0  | 0  | 0   |

| 12%  | 40  | 41  | 42  | 43   | 44  | 45  | 46  | 47  | 48  | 49  | 50  | 51  | 52  |
|------|-----|-----|-----|------|-----|-----|-----|-----|-----|-----|-----|-----|-----|
| 2002 | 0   | 0   | 0   | 0    | 0   | 0   | 0   | 0   | 0   | 0   | 0   | 0   | 0   |
| 2003 | 0   | 0   | 0   | 0    | 0   | 0   | 0   | 0   | 0   | 0   | 0   | 0   | 0   |
| 2004 | 0   | 0   | 0   | 0    | 0   | 0   | 0   | 0   | 0   | 0   | 0   | 0   | 0   |
| 2005 | 0   | 0   | 0   | 0    | 0   | 0   | 0   | 0   | 0   | 0   | 0   | 0   | 0   |
| 2006 | 0   | 0   | 0   | 0    | 0   | 0   | 0   | 0   | 0   | 0   | 0   | 0   | 0   |
| 2007 | 0   | 0   | 0   | 0    | 0   | 0   | 0   | 0   | 0   | 0   | 0   | 0   | 0   |
| 2008 | 0   | 0   | 0   | 0    | 0   | 0   | 0   | 0   | 0   | 0   | 0   | 0   | 0   |
| 2009 | 0   | 0   | 0   | 0    | 0   | 0   | 0   | 0   | 0   | 0   | 0   | 0   | 0   |
| 2010 | 0   | 0   | 0   | 0    | 0   | 0   | 0   | 0   | 0   | 0   | 0   | 0   | 0   |
| 2011 | 0   | 0   | 0   | 0    | 0   | 0   | 0   | 0   | 0   | 0   | 0   | 0   | 0   |
| 2012 | 0   | 0   | 0   | 0    | 0   | 0   | 0   | 0   | 0   | 0   | 0   | 0   | 0   |
| 2013 | 0   | 0   | 0   | 0    | 0   | 0   | 0   | 0   | 0   | 0   | 0   | 0   | 0   |
| 2014 | 0   | 0   | 0   | 0    | 0   | 0   | 0   | 0   | 0   | 0   | 0   | 0   | 0   |
| 2015 | 0   | 0   | 0   | 0    | 0   | 0   | 0   | 0   | 0   | 0   | 0   | 0   | 0   |
| 2016 | 0   | 0   | 0   | 0    | 0   | 0   | 0   | 0   | 0   | 0   | 0   | 0   | 0   |
| 2017 | 0   | 0   | 0   | 0    | 0   | 0   | 0   | 0   | 0   | 0   | 0   | 0   | 0   |
| 2018 | 0   | 0   | 0   | 0    | 0   | 0   | 0   | 0   | 0   | 0   | 0   | 0   | 0   |
| 2019 | 0   | 0   | 0   | 0    | 0   | 0   | 0   | 0   | 0   | 0   | 0   | 0   | 0   |
| 2020 | 351 | 0   | 0   | 0    | 0   | 0   | 0   | 0   | 0   | 39  | 0   | 0   | 0   |
| 2021 | 355 | 0   | 0   | 0    | 0   | 0   | 0   | 0   | 0   | 62  | 0   | 0   | 0   |
| 2022 | 413 | 0   | 0   | 0    | 0   | 0   | 0   | 0   | 0   | 86  | 0   | 0   | 0   |
| 2023 | 452 | 0   | 0   | 0    | 0   | 0   | 0   | 0   | 0   | 191 | 0   | 0   | 0   |
| 2024 | 585 | 0   | 0   | 0    | 0   | 0   | 0   | 0   | 0   | 148 | 0   | 0   | 0   |
| 2025 | 495 | 250 | 679 | 952  | 16  | 277 | 66  | 66  | 0   | 207 | 47  | 246 | 250 |
| 2026 | 562 | 339 | 644 | 944  | 86  | 359 | 117 | 129 | 0   | 183 | 35  | 417 | 339 |
| 2027 | 636 | 371 | 636 | 991  | 35  | 335 | 105 | 121 | 0   | 199 | 39  | 304 | 359 |
| 2028 | 757 | 488 | 605 | 936  | 113 | 452 | 160 | 172 | 0   | 215 | 109 | 503 | 437 |
| 2029 | 792 | 449 | 612 | 959  | 179 | 449 | 250 | 265 | 0   | 269 | 137 | 519 | 449 |
| 2030 | 663 | 647 | 640 | 979  | 160 | 558 | 273 | 308 | 39  | 347 | 176 | 441 | 550 |
| 2031 | 702 | 612 | 608 | 924  | 222 | 683 | 226 | 269 | 140 | 363 | 156 | 527 | 546 |
| 2032 | 827 | 605 | 659 | 956  | 242 | 675 | 222 | 281 | 179 | 406 | 215 | 542 | 620 |
| 2033 | 612 | 686 | 577 | 959  | 296 | 702 | 269 | 339 | 230 | 304 | 242 | 370 | 569 |
| 2034 | 640 | 698 | 667 | 1037 | 308 | 667 | 328 | 386 | 300 | 371 | 261 | 573 | 612 |
| 2035 | 647 | 725 | 558 | 1034 | 261 | 772 | 308 | 347 | 332 | 332 | 238 | 534 | 729 |
| 2036 | 558 | 636 | 671 | 920  | 382 | 725 | 363 | 386 | 269 | 367 | 230 | 534 | 577 |
| 2037 | 562 | 644 | 690 | 835  | 308 | 632 | 351 | 398 | 417 | 312 | 300 | 499 | 706 |
| 2038 | 577 | 456 | 628 | 776  | 215 | 608 | 413 | 495 | 417 | 289 | 308 | 480 | 671 |
| 2039 | 503 | 530 | 651 | 776  | 215 | 620 | 300 | 452 | 429 | 308 | 281 | 394 | 690 |
| 2040 | 445 | 554 | 644 | 827  | 191 | 655 | 308 | 382 | 464 | 320 | 226 | 577 | 628 |
| 2041 | 577 | 679 | 605 | 842  | 257 | 577 | 316 | 371 | 382 | 402 | 222 | 554 | 768 |
| 2042 | 328 | 741 | 815 | 831  | 347 | 683 | 332 | 382 | 355 | 488 | 199 | 776 | 827 |
| 2043 | 316 | 585 | 682 | 764  | 355 | 655 | 316 | 472 | 452 | 421 | 250 | 515 | 651 |
| 2044 | 293 | 612 | 503 | 644  | 339 | 577 | 285 | 429 | 413 | 164 | 195 | 671 | 702 |
| 2045 | 242 | 612 | 542 | 628  | 374 | 546 | 402 | 476 | 402 | 246 | 218 | 554 | 714 |
| 2046 | 281 | 566 | 460 | 562  | 285 | 452 | 250 | 351 | 519 | 452 | 156 | 558 | 511 |
| 2047 | 66  | 238 | 710 | 569  | 230 | 456 | 293 | 601 | 199 | 339 | 460 | 484 | 425 |
| 2048 | 51  | 363 | 355 | 289  | 125 | 199 | 351 | 698 | 511 | 218 | 671 | 620 | 632 |
| 2049 | 491 | 624 | 671 | 238  | 238 | 238 | 359 | 741 | 721 | 105 | 464 | 569 | 612 |
| 2050 | 370 | 558 | 585 | 640  | 640 | 640 | 293 | 647 | 690 | 39  | 491 | 550 | 491 |
| 2051 | 191 | 480 | 562 | 585  | 585 | 585 | 304 | 718 | 558 | 23  | 581 | 515 | 534 |
| 2052 | 66  | 573 | 542 | 597  | 597 | 597 | 312 | 796 | 605 | 0   | 566 | 452 | 597 |
| 2053 | 31  | 554 | 394 | 523  | 523 | 523 | 234 | 636 | 675 | 16  | 546 | 211 | 410 |
| 2054 | 31  | 402 | 183 | 468  | 468 | 468 | 113 | 332 | 605 | 0   | 339 | 140 | 215 |
| 2055 | 12  | 203 | 101 | 215  | 215 | 215 | 58  | 187 | 644 | 0   | 195 | 82  | 121 |
| 2056 | 0   | 121 | 62  | 148  | 148 | 148 | 51  | 137 | 628 | 0   | 125 | 31  | 82  |
| 2057 | 0   | 82  | 23  | 82   | 82  | 82  | 12  | 90  | 667 | 0   | 82  | 27  | 31  |
| 2058 | 0   | 39  | 16  | 23   | 23  | 23  | 0   | 27  | 577 | 0   | 39  | 0   | 0   |
| 2059 | 0   | 0   | 0   | 0    | 0   | 0   | 0   | 0   | 308 | 0   | 0   | 4   | 20  |

| 12%  | 40 | 41 | 42 | 43 | 44 | 45 | 46 | 47 | 48  | 49 | 50 | 51 | 52 |
|------|----|----|----|----|----|----|----|----|-----|----|----|----|----|
| 2060 | 0  | 16 | 0  | 0  | 0  | 0  | 0  | 0  | 175 | 0  | 0  | 0  | 0  |
| 2061 | 0  | 0  | 0  | 0  | 0  | 0  | 0  | 0  | 125 | 0  | 0  | 0  | 0  |
| 2062 | 0  | 0  | 0  | 0  | 0  | 0  | 0  | 0  | 113 | 0  | 0  | 0  | 0  |
| 2063 | 0  | 0  | 0  | 0  | 0  | 0  | 0  | 0  | 90  | 0  | 0  | 0  | 0  |
| 2064 | 0  | 0  | 0  | 0  | 0  | 0  | 0  | 0  | 66  | 0  | 0  | 0  | 0  |
| 2065 | 0  | 0  | 0  | 0  | 0  | 0  | 0  | 0  | 12  | 0  | 0  | 0  | 0  |
| 2066 | 0  | 0  | 0  | 0  | 0  | 0  | 0  | 0  | 0   | 0  | 0  | 0  | 0  |
| 2067 | 0  | 0  | 0  | 0  | 0  | 0  | 0  | 0  | 8   | 0  | 0  | 0  | 0  |
| 2068 | 0  | 0  | 0  | 0  | 0  | 0  | 0  | 0  | 0   | 0  | 0  | 0  | 0  |
| 2069 | 0  | 0  | 0  | 0  | 0  | 0  | 0  | 0  | 0   | 0  | 0  | 0  | 0  |
| 2070 | 0  | 0  | 0  | 0  | 0  | 0  | 0  | 0  | 0   | 0  | 0  | 0  | 0  |
| 2071 | 0  | 0  | 0  | 0  | 0  | 0  | 0  | 0  | 0   | 0  | 0  | 0  | 0  |
| 2072 | 0  | 0  | 0  | 0  | 0  | 0  | 0  | 0  | 0   | 0  | 0  | 0  | 0  |
| 2073 | 0  | 0  | 0  | 0  | 0  | 0  | 0  | 0  | 0   | 0  | 0  | 0  | 0  |
| 2074 | 0  | 0  | 0  | 0  | 0  | 0  | 0  | 0  | 0   | 0  | 0  | 0  | 0  |
| 2075 | 0  | 0  | 0  | 0  | 0  | 0  | 0  | 0  | 0   | 0  | 0  | 0  | 0  |
| 2076 | 0  | 0  | 0  | 0  | 0  | 0  | 0  | 0  | 0   | 0  | 0  | 0  | 0  |
| 2077 | 0  | 0  | 0  | 0  | 0  | 0  | 0  | 0  | 0   | 0  | 0  | 0  | 0  |
| 2078 | 0  | 0  | 0  | 0  | 0  | 0  | 0  | 0  | 0   | 0  | 0  | 0  | 0  |
| 2079 | 0  | 0  | 0  | 0  | 0  | 0  | 0  | 0  | 0   | 0  | 0  | 0  | 0  |
| 2080 | 0  | 0  | 0  | 0  | 0  | 0  | 0  | 0  | 0   | 0  | 0  | 0  | 0  |
| 2081 | 0  | 0  | 0  | 0  | 0  | 0  | 0  | 0  | 0   | 0  | 0  | 0  | 0  |
| 2082 | 0  | 0  | 0  | 0  | 0  | 0  | 0  | 0  | 0   | 0  | 0  | 0  | 0  |
| 2083 | 0  | 0  | 0  | 0  | 0  | 0  | 0  | 0  | 0   | 0  | 0  | 0  | 0  |
| 2084 | 0  | 0  | 0  | 0  | 0  | 0  | 0  | 0  | 0   | 0  | 0  | 0  | 0  |
| 2085 | 0  | 0  | 0  | 0  | 0  | 0  | 0  | 0  | 0   | 0  | 0  | 0  | 0  |
| 2086 | 0  | 0  | 0  | 0  | 0  | 0  | 0  | 0  | 0   | 0  | 0  | 0  | 0  |
| 2087 | 0  | 0  | 0  | 0  | 0  | 0  | 0  | 0  | 0   | 0  | 0  | 0  | 0  |
| 2088 | 0  | 0  | 0  | 0  | 0  | 0  | 0  | 0  | 0   | 0  | 0  | 0  | 0  |
| 2089 | 0  | 0  | 0  | 0  | 0  | 0  | 0  | 0  | 0   | 0  | 0  | 0  | 0  |
| 2090 | 0  | 0  | 0  | 0  | 0  | 0  | 0  | 0  | 0   | 0  | 0  | 0  | 0  |

| 12%  | 53  | 54  | 55   | 56   | 57   | 58   | 59   | 60   | 61   | 62   | 63   | 64  | 65  |
|------|-----|-----|------|------|------|------|------|------|------|------|------|-----|-----|
| 2002 | 0   | 0   | 0    | 0    | 0    | 0    | 0    | 0    | 0    | 0    | 0    | 0   | 0   |
| 2003 | 0   | 0   | 0    | 0    | 0    | 0    | 0    | 0    | 0    | 0    | 0    | 0   | 0   |
| 2004 | 0   | 0   | 0    | 0    | 0    | 0    | 0    | 0    | 0    | 0    | 0    | 0   | 0   |
| 2005 | 0   | 0   | 0    | 0    | 0    | 0    | 0    | 0    | 0    | 0    | 0    | 0   | 0   |
| 2006 | 0   | 0   | 0    | 0    | 0    | 0    | 0    | 0    | 0    | 0    | 0    | 0   | 0   |
| 2007 | 0   | 0   | 0    | 0    | 0    | 0    | 0    | 0    | 0    | 0    | 0    | 0   | 0   |
| 2008 | 0   | 0   | 0    | 0    | 0    | 0    | 0    | 0    | 0    | 0    | 0    | 0   | 0   |
| 2009 | 0   | 0   | 0    | 0    | 0    | 0    | 0    | 0    | 0    | 0    | 0    | 0   | 0   |
| 2010 | 0   | 0   | 0    | 0    | 0    | 0    | 0    | 0    | 0    | 0    | 0    | 0   | 0   |
| 2011 | 0   | 0   | 0    | 0    | 0    | 0    | 0    | 0    | 0    | 0    | 0    | 0   | 0   |
| 2012 | 0   | 0   | 0    | 0    | 0    | 0    | 0    | 0    | 0    | 0    | 0    | 0   | 0   |
| 2013 | 0   | 0   | 0    | 0    | 0    | 0    | 0    | 0    | 0    | 0    | 0    | 0   | 0   |
| 2014 | 0   | 0   | 0    | 0    | 0    | 0    | 0    | 0    | 0    | 0    | 0    | 0   | 0   |
| 2015 | 0   | 0   | 0    | 0    | 0    | 0    | 0    | 0    | 0    | 0    | 0    | 0   | 0   |
| 2016 | 0   | 0   | 0    | 0    | 0    | 0    | 0    | 0    | 0    | 0    | 0    | 0   | 0   |
| 2017 | 0   | 0   | 0    | 0    | 0    | 0    | 0    | 0    | 0    | 0    | 0    | 0   | 0   |
| 2018 | 0   | 0   | 0    | 0    | 0    | 0    | 0    | 0    | 0    | 0    | 0    | 0   | 0   |
| 2019 | 0   | 0   | 0    | 0    | 0    | 0    | 0    | 0    | 0    | 0    | 0    | 0   | 0   |
| 2020 | 0   | 0   | 0    | 0    | 0    | 991  | 0    | 0    | 0    | 0    | 0    | 0   | 0   |
| 2021 | 0   | 0   | 0    | 0    | 0    | 1065 | 0    | 0    | 0    | 0    | 0    | 0   | 0   |
| 2022 | 0   | 0   | 0    | 0    | 0    | 1162 | 0    | 0    | 0    | 0    | 0    | 0   | 0   |
| 2023 | 0   | 0   | 0    | 0    | 0    | 944  | 0    | 0    | 0    | 0    | 0    | 0   | 0   |
| 2024 | 0   | 0   | 0    | 0    | 0    | 1002 | 0    | 0    | 0    | 0    | 0    | 0   | 0   |
| 2025 | 4   | 66  | 998  | 998  | 0    | 1022 | 998  | 998  | 998  | 998  | 998  | 277 | 277 |
| 2026 | 0   | 117 | 983  | 1022 | 0    | 1154 | 1022 | 1022 | 1022 | 1022 | 1022 | 589 | 831 |
| 2027 | 20  | 113 | 1154 | 1221 | 0    | 1034 | 1201 | 1201 | 1201 | 1201 | 1201 | 519 | 768 |
| 2028 | 66  | 176 | 975  | 1080 | 0    | 909  | 1092 | 1092 | 1092 | 1092 | 1092 | 558 | 823 |
| 2029 | 117 | 265 | 932  | 1193 | 0    | 995  | 1119 | 1119 | 1119 | 1119 | 1119 | 394 | 675 |
| 2030 | 113 | 308 | 881  | 1197 | 998  | 1100 | 1123 | 1123 | 1123 | 1123 | 1123 | 523 | 706 |
| 2031 | 66  | 269 | 893  | 1147 | 1061 | 1096 | 1037 | 1037 | 1037 | 1037 | 1037 | 632 | 784 |
| 2032 | 117 | 265 | 858  | 1080 | 1154 | 1186 | 971  | 971  | 971  | 971  | 971  | 581 | 737 |
| 2033 | 148 | 308 | 940  | 1178 | 1283 | 1193 | 987  | 987  | 987  | 983  | 987  | 640 | 788 |
| 2034 | 183 | 343 | 928  | 1100 | 1217 | 1139 | 1006 | 1006 | 1006 | 979  | 1006 | 667 | 811 |
| 2035 | 199 | 339 | 983  | 1018 | 1431 | 1108 | 1057 | 1053 | 1057 | 1002 | 1057 | 753 | 776 |
| 2036 | 226 | 367 | 1135 | 1193 | 1338 | 1412 | 1193 | 1162 | 1193 | 1108 | 1193 | 628 | 737 |
| 2037 | 187 | 386 | 1158 | 1115 | 1170 | 917  | 952  | 1108 | 955  | 850  | 955  | 643 | 620 |
| 2038 | 195 | 468 | 1014 | 1221 | 991  | 846  | 1182 | 1338 | 1190 | 893  | 1190 | 538 | 620 |
| 2039 | 222 | 425 | 1170 | 1209 | 1006 | 1026 | 1213 | 1092 | 1209 | 878  | 1209 | 542 | 620 |
| 2040 | 152 | 343 | 1349 | 1416 | 924  | 917  | 1193 | 1217 | 1412 | 979  | 1412 | 729 | 741 |
| 2041 | 261 | 355 | 1427 | 1346 | 1022 | 901  | 1466 | 1400 | 1470 | 1096 | 1439 | 558 | 655 |
| 2042 | 172 | 355 | 1100 | 1096 | 1018 | 242  | 1049 | 1127 | 1154 | 846  | 1131 | 616 | 647 |
| 2043 | 218 | 339 | 1630 | 1564 | 1041 | 144  | 1299 | 1365 | 1724 | 1392 | 1650 | 597 | 640 |
| 2044 | 211 | 355 | 764  | 1127 | 1092 | 339  | 1092 | 905  | 870  | 698  | 854  | 491 | 565 |
| 2045 | 203 | 456 | 47   | 94   | 1295 | 86   | 152  | 156  | 105  | 105  | 105  | 417 | 429 |
| 2046 | 207 | 328 | 710  | 944  | 1346 | 0    | 862  | 870  | 835  | 835  | 835  | 410 | 398 |
| 2047 | 425 | 425 | 285  | 710  | 948  | 0    | 554  | 542  | 632  | 632  | 632  | 47  | 78  |
| 2048 | 632 | 632 | 109  | 683  | 218  | 0    | 515  | 499  | 460  | 460  | 460  | 12  | 39  |
| 2049 | 612 | 612 | 16   | 445  | 858  | 0    | 265  | 242  | 195  | 195  | 195  | 889 | 956 |
| 2050 | 491 | 491 | 0    | 308  | 846  | 0    | 62   | 55   | 39   | 39   | 39   | 449 | 850 |
| 2051 | 534 | 534 | 0    | 144  | 659  | 0    | 0    | 0    | 0    | 0    | 0    | 183 | 835 |
| 2052 | 597 | 597 | 0    | 0    | 464  | 0    | 0    | 0    | 0    | 0    | 0    | 0   | 484 |
| 2053 | 410 | 410 | 0    | 0    | 659  | 0    | 0    | 0    | 0    | 0    | 0    | 0   | 218 |
| 2054 | 214 | 215 | 0    | 0    | 566  | 0    | 0    | 0    | 0    | 0    | 0    | 0   | 156 |
| 2055 | 121 | 121 | 0    | 0    | 320  | 0    | 0    | 0    | 0    | 0    | 0    | 0   | 66  |
| 2056 | 82  | 82  | 0    | 0    | 152  | 0    | 0    | 0    | 0    | 0    | 0    | 0   | 31  |
| 2057 | 31  | 31  | 0    | 0    | 16   | 0    | 0    | 0    | 0    | 0    | 0    | 0   | 0   |
| 2058 | 0   | 0   | 0    | 0    | 0    | 0    | 0    | 0    | 0    | 0    | 0    | 0   | 0   |
| 2059 | 19  | 20  | 0    | 0    | 0    | 0    | 0    | 0    | 0    | 0    | 0    | 0   | 0   |

| 12%  | 53 | 54 | 55 | 56 | 57 | 58 | 59 | 60 | 61 | 62 | 63 | 64 | 65 |
|------|----|----|----|----|----|----|----|----|----|----|----|----|----|
| 2060 | 0  | 0  | 0  | 0  | 0  | 0  | 0  | 0  | 0  | 0  | 0  | 0  | 0  |
| 2061 | 0  | 0  | 0  | 0  | 0  | 0  | 0  | 0  | 0  | 0  | 0  | 0  | 0  |
| 2062 | 0  | 0  | 0  | 0  | 0  | 0  | 0  | 0  | 0  | 0  | 0  | 0  | 0  |
| 2063 | 0  | 0  | 0  | 0  | 0  | 0  | 0  | 0  | 0  | 0  | 0  | 0  | 0  |
| 2064 | 0  | 0  | 0  | 0  | 0  | 0  | 0  | 0  | 0  | 0  | 0  | 0  | 0  |
| 2065 | 0  | 0  | 0  | 0  | 0  | 0  | 0  | 0  | 0  | 0  | 0  | 0  | 0  |
| 2066 | 0  | 0  | 0  | 0  | 0  | 0  | 0  | 0  | 0  | 0  | 0  | 0  | 0  |
| 2067 | 0  | 0  | 0  | 0  | 0  | 0  | 0  | 0  | 0  | 0  | 0  | 0  | 0  |
| 2068 | 0  | 0  | 0  | 0  | 0  | 0  | 0  | 0  | 0  | 0  | 0  | 0  | 0  |
| 2069 | 0  | 0  | 0  | 0  | 0  | 0  | 0  | 0  | 0  | 0  | 0  | 0  | 0  |
| 2070 | 0  | 0  | 0  | 0  | 0  | 0  | 0  | 0  | 0  | 0  | 0  | 0  | 0  |
| 2071 | 0  | 0  | 0  | 0  | 0  | 0  | 0  | 0  | 0  | 0  | 0  | 0  | 0  |
| 2072 | 0  | 0  | 0  | 0  | 0  | 0  | 0  | 0  | 0  | 0  | 0  | 0  | 0  |
| 2073 | 0  | 0  | 0  | 0  | 0  | 0  | 0  | 0  | 0  | 0  | 0  | 0  | 0  |
| 2074 | 0  | 0  | 0  | 0  | 0  | 0  | 0  | 0  | 0  | 0  | 0  | 0  | 0  |
| 2075 | 0  | 0  | 0  | 0  | 0  | 0  | 0  | 0  | 0  | 0  | 0  | 0  | 0  |
| 2076 | 0  | 0  | 0  | 0  | 0  | 0  | 0  | 0  | 0  | 0  | 0  | 0  | 0  |
| 2077 | 0  | 0  | 0  | 0  | 0  | 0  | 0  | 0  | 0  | 0  | 0  | 0  | 0  |
| 2078 | 0  | 0  | 0  | 0  | 0  | 0  | 0  | 0  | 0  | 0  | 0  | 0  | 0  |
| 2079 | 0  | 0  | 0  | 0  | 0  | 0  | 0  | 0  | 0  | 0  | 0  | 0  | 0  |
| 2080 | 0  | 0  | 0  | 0  | 0  | 0  | 0  | 0  | 0  | 0  | 0  | 0  | 0  |
| 2081 | 0  | 0  | 0  | 0  | 0  | 0  | 0  | 0  | 0  | 0  | 0  | 0  | 0  |
| 2082 | 0  | 0  | 0  | 0  | 0  | 0  | 0  | 0  | 0  | 0  | 0  | 0  | 0  |
| 2083 | 0  | 0  | 0  | 0  | 0  | 0  | 0  | 0  | 0  | 0  | 0  | 0  | 0  |
| 2084 | 0  | 0  | 0  | 0  | 0  | 0  | 0  | 0  | 0  | 0  | 0  | 0  | 0  |
| 2085 | 0  | 0  | 0  | 0  | 0  | 0  | 0  | 0  | 0  | 0  | 0  | 0  | 0  |
| 2086 | 0  | 0  | 0  | 0  | 0  | 0  | 0  | 0  | 0  | 0  | 0  | 0  | 0  |
| 2087 | 0  | 0  | 0  | 0  | 0  | 0  | 0  | 0  | 0  | 0  | 0  | 0  | 0  |
| 2088 | 0  | 0  | 0  | 0  | 0  | 0  | 0  | 0  | 0  | 0  | 0  | 0  | 0  |
| 2089 | 0  | 0  | 0  | 0  | 0  | 0  | 0  | 0  | 0  | 0  | 0  | 0  | 0  |
| 2090 | 0  | 0  | 0  | 0  | 0  | 0  | 0  | 0  | 0  | 0  | 0  | 0  | 0  |



| 12%  | 66  | 67  | 68  | 69   | 70   | 71  | 72  | 73  | 74  | 75  | 76  | 77  | 78  |
|------|-----|-----|-----|------|------|-----|-----|-----|-----|-----|-----|-----|-----|
| 2002 | 0   | 0   | 0   | 0    | 0    | 0   | 0   | 0   | 0   | 0   | 0   | 0   | 0   |
| 2003 | 0   | 0   | 0   | 0    | 0    | 0   | 0   | 0   | 0   | 0   | 0   | 0   | 0   |
| 2004 | 0   | 0   | 0   | 0    | 0    | 0   | 0   | 0   | 0   | 0   | 0   | 0   | 0   |
| 2005 | 0   | 0   | 0   | 0    | 0    | 0   | 0   | 0   | 0   | 0   | 0   | 0   | 0   |
| 2006 | 0   | 0   | 0   | 0    | 0    | 0   | 0   | 0   | 0   | 0   | 0   | 0   | 0   |
| 2007 | 0   | 0   | 0   | 0    | 0    | 0   | 0   | 0   | 0   | 0   | 0   | 0   | 0   |
| 2008 | 0   | 0   | 0   | 0    | 0    | 0   | 0   | 0   | 0   | 0   | 0   | 0   | 0   |
| 2009 | 0   | 0   | 0   | 0    | 0    | 0   | 0   | 0   | 0   | 0   | 0   | 0   | 0   |
| 2010 | 0   | 0   | 0   | 0    | 0    | 0   | 0   | 0   | 0   | 0   | 0   | 0   | 0   |
| 2011 | 0   | 0   | 0   | 0    | 0    | 0   | 0   | 0   | 0   | 0   | 0   | 0   | 0   |
| 2012 | 0   | 0   | 0   | 0    | 0    | 0   | 0   | 0   | 0   | 0   | 0   | 0   | 0   |
| 2013 | 0   | 0   | 0   | 0    | 0    | 0   | 0   | 0   | 0   | 0   | 0   | 0   | 0   |
| 2014 | 0   | 0   | 0   | 0    | 0    | 0   | 0   | 0   | 0   | 0   | 0   | 0   | 0   |
| 2015 | 0   | 0   | 0   | 0    | 0    | 0   | 0   | 0   | 0   | 0   | 0   | 0   | 0   |
| 2016 | 0   | 0   | 0   | 0    | 0    | 0   | 0   | 0   | 0   | 0   | 0   | 0   | 0   |
| 2017 | 0   | 0   | 0   | 0    | 0    | 0   | 0   | 0   | 0   | 0   | 0   | 0   | 0   |
| 2018 | 0   | 0   | 0   | 0    | 0    | 0   | 0   | 0   | 0   | 0   | 0   | 0   | 0   |
| 2019 | 0   | 0   | 0   | 0    | 0    | 0   | 0   | 0   | 0   | 0   | 0   | 0   | 0   |
| 2020 | 0   | 351 | 0   | 0    | 0    | 0   | 0   | 0   | 0   | 0   | 39  | 0   | 0   |
| 2021 | 0   | 589 | 0   | 0    | 0    | 0   | 0   | 0   | 0   | 0   | 43  | 0   | 0   |
| 2022 | 0   | 644 | 0   | 0    | 0    | 0   | 0   | 0   | 0   | 0   | 144 | 0   | 0   |
| 2023 | 0   | 523 | 0   | 0    | 0    | 0   | 0   | 0   | 0   | 0   | 261 | 0   | 0   |
| 2024 | 0   | 538 | 0   | 0    | 0    | 0   | 0   | 0   | 0   | 0   | 156 | 0   | 0   |
| 2025 | 0   | 480 | 250 | 679  | 952  | 16  | 277 | 66  | 66  | 0   | 211 | 47  | 246 |
| 2026 | 0   | 530 | 679 | 1069 | 1326 | 43  | 807 | 137 | 573 | 0   | 203 | 238 | 831 |
| 2027 | 0   | 612 | 585 | 1002 | 1295 | 70  | 667 | 164 | 488 | 0   | 195 | 242 | 655 |
| 2028 | 0   | 749 | 632 | 1022 | 1322 | 101 | 780 | 203 | 476 | 0   | 218 | 218 | 901 |
| 2029 | 0   | 745 | 499 | 776  | 1104 | 160 | 593 | 250 | 425 | 0   | 269 | 176 | 663 |
| 2030 | 257 | 725 | 644 | 710  | 1049 | 144 | 566 | 308 | 472 | 39  | 335 | 230 | 476 |
| 2031 | 956 | 698 | 714 | 620  | 1041 | 195 | 733 | 265 | 355 | 706 | 320 | 246 | 589 |
| 2032 | 924 | 835 | 655 | 667  | 1049 | 191 | 698 | 273 | 421 | 710 | 386 | 218 | 507 |
| 2033 | 870 | 632 | 768 | 620  | 971  | 218 | 706 | 269 | 417 | 589 | 269 | 273 | 398 |
| 2034 | 936 | 796 | 698 | 671  | 1104 | 234 | 690 | 363 | 519 | 581 | 456 | 250 | 538 |
| 2035 | 753 | 612 | 733 | 608  | 1127 | 211 | 761 | 277 | 343 | 456 | 332 | 234 | 468 |
| 2036 | 686 | 581 | 651 | 702  | 878  | 308 | 651 | 289 | 406 | 437 | 355 | 254 | 484 |
| 2037 | 702 | 569 | 589 | 776  | 807  | 257 | 647 | 335 | 339 | 456 | 277 | 261 | 526 |
| 2038 | 878 | 550 | 565 | 768  | 788  | 281 | 581 | 339 | 386 | 581 | 367 | 207 | 526 |
| 2039 | 753 | 632 | 503 | 757  | 815  | 215 | 593 | 347 | 367 | 406 | 246 | 152 | 495 |
| 2040 | 608 | 448 | 585 | 671  | 963  | 238 | 741 | 398 | 437 | 425 | 308 | 207 | 655 |
| 2041 | 846 | 507 | 683 | 655  | 866  | 332 | 593 | 277 | 370 | 550 | 484 | 199 | 647 |
| 2042 | 764 | 686 | 807 | 683  | 920  | 246 | 636 | 429 | 511 | 374 | 655 | 300 | 737 |
| 2043 | 686 | 593 | 620 | 527  | 741  | 250 | 647 | 332 | 296 | 468 | 148 | 285 | 585 |
| 2044 | 702 | 339 | 437 | 608  | 675  | 133 | 507 | 261 | 367 | 398 | 121 | 222 | 581 |
| 2045 | 597 | 0   | 386 | 850  | 632  | 203 | 417 | 277 | 324 | 218 | 573 | 156 | 515 |
| 2046 | 616 | 628 | 382 | 312  | 569  | 199 | 425 | 62  | 82  | 429 | 98  | 31  | 117 |
| 2047 | 562 | 113 | 39  | 230  | 105  | 31  | 66  | 807 | 975 | 265 | 0   | 917 | 920 |
| 2048 | 187 | 16  | 0   | 928  | 20   | 20  | 20  | 448 | 881 | 82  | 0   | 803 | 741 |
| 2049 | 0   | 0   | 959 | 745  | 952  | 952 | 952 | 207 | 792 | 920 | 0   | 573 | 413 |
| 2050 | 940 | 0   | 838 | 347  | 827  | 827 | 827 | 0   | 460 | 846 | 0   | 269 | 199 |
| 2051 | 885 | 0   | 562 | 172  | 538  | 538 | 538 | 0   | 246 | 909 | 0   | 109 | 86  |
| 2052 | 885 | 0   | 273 | 59   | 246  | 246 | 246 | 0   | 156 | 737 | 0   | 12  | 8   |
| 2053 | 737 | 0   | 113 | 0    | 109  | 109 | 109 | 0   | 66  | 507 | 0   | 0   | 0   |
| 2054 | 464 | 0   | 12  | 0    | 12   | 12  | 12  | 0   | 31  | 324 | 0   | 0   | 0   |
| 2055 | 402 | 0   | 0   | 0    | 0    | 0   | 0   | 0   | 0   | 195 | 0   | 0   | 0   |
| 2056 | 195 | 0   | 0   | 0    | 0    | 0   | 0   | 0   | 0   | 51  | 0   | 0   | 0   |
| 2057 | 51  | 0   | 0   | 0    | 0    | 0   | 0   | 0   | 0   | 4   | 0   | 0   | 0   |
| 2058 | 4   | 0   | 0   | 0    | 0    | 0   | 0   | 0   | 0   | 0   | 0   | 0   | 0   |
| 2059 | 0   | 0   | 0   | 0    | 0    | 0   | 0   | 0   | 0   | 0   | 0   | 0   | 0   |

| 12%  | 66 | 67 | 68 | 69 | 70 | 71 | 72 | 73 | 74 | 75 | 76 | 77 | 78 |
|------|----|----|----|----|----|----|----|----|----|----|----|----|----|
| 2060 | 0  | 0  | 0  | 0  | 0  | 0  | 0  | 0  | 0  | 0  | 0  | 0  | 0  |
| 2061 | 0  | 0  | 0  | 0  | 0  | 0  | 0  | 0  | 0  | 0  | 0  | 0  | 0  |
| 2062 | 0  | 0  | 0  | 0  | 0  | 0  | 0  | 0  | 0  | 0  | 0  | 0  | 0  |
| 2063 | 0  | 0  | 0  | 0  | 0  | 0  | 0  | 0  | 0  | 0  | 0  | 0  | 0  |
| 2064 | 0  | 0  | 0  | 0  | 0  | 0  | 0  | 0  | 0  | 0  | 0  | 0  | 0  |
| 2065 | 0  | 0  | 0  | 0  | 0  | 0  | 0  | 0  | 0  | 0  | 0  | 0  | 0  |
| 2066 | 0  | 0  | 0  | 0  | 0  | 0  | 0  | 0  | 0  | 0  | 0  | 0  | 0  |
| 2067 | 0  | 0  | 0  | 0  | 0  | 0  | 0  | 0  | 0  | 0  | 0  | 0  | 0  |
| 2068 | 0  | 0  | 0  | 0  | 0  | 0  | 0  | 0  | 0  | 0  | 0  | 0  | 0  |
| 2069 | 0  | 0  | 0  | 0  | 0  | 0  | 0  | 0  | 0  | 0  | 0  | 0  | 0  |
| 2070 | 0  | 0  | 0  | 0  | 0  | 0  | 0  | 0  | 0  | 0  | 0  | 0  | 0  |
| 2071 | 0  | 0  | 0  | 0  | 0  | 0  | 0  | 0  | 0  | 0  | 0  | 0  | 0  |
| 2072 | 0  | 0  | 0  | 0  | 0  | 0  | 0  | 0  | 0  | 0  | 0  | 0  | 0  |
| 2073 | 0  | 0  | 0  | 0  | 0  | 0  | 0  | 0  | 0  | 0  | 0  | 0  | 0  |
| 2074 | 0  | 0  | 0  | 0  | 0  | 0  | 0  | 0  | 0  | 0  | 0  | 0  | 0  |
| 2075 | 0  | 0  | 0  | 0  | 0  | 0  | 0  | 0  | 0  | 0  | 0  | 0  | 0  |
| 2076 | 0  | 0  | 0  | 0  | 0  | 0  | 0  | 0  | 0  | 0  | 0  | 0  | 0  |
| 2077 | 0  | 0  | 0  | 0  | 0  | 0  | 0  | 0  | 0  | 0  | 0  | 0  | 0  |
| 2078 | 0  | 0  | 0  | 0  | 0  | 0  | 0  | 0  | 0  | 0  | 0  | 0  | 0  |
| 2079 | 0  | 0  | 0  | 0  | 0  | 0  | 0  | 0  | 0  | 0  | 0  | 0  | 0  |
| 2080 | 0  | 0  | 0  | 0  | 0  | 0  | 0  | 0  | 0  | 0  | 0  | 0  | 0  |
| 2081 | 0  | 0  | 0  | 0  | 0  | 0  | 0  | 0  | 0  | 0  | 0  | 0  | 0  |
| 2082 | 0  | 0  | 0  | 0  | 0  | 0  | 0  | 0  | 0  | 0  | 0  | 0  | 0  |
| 2083 | 0  | 0  | 0  | 0  | 0  | 0  | 0  | 0  | 0  | 0  | 0  | 0  | 0  |
| 2084 | 0  | 0  | 0  | 0  | 0  | 0  | 0  | 0  | 0  | 0  | 0  | 0  | 0  |
| 2085 | 0  | 0  | 0  | 0  | 0  | 0  | 0  | 0  | 0  | 0  | 0  | 0  | 0  |
| 2086 | 0  | 0  | 0  | 0  | 0  | 0  | 0  | 0  | 0  | 0  | 0  | 0  | 0  |
| 2087 | 0  | 0  | 0  | 0  | 0  | 0  | 0  | 0  | 0  | 0  | 0  | 0  | 0  |
| 2088 | 0  | 0  | 0  | 0  | 0  | 0  | 0  | 0  | 0  | 0  | 0  | 0  | 0  |
| 2089 | 0  | 0  | 0  | 0  | 0  | 0  | 0  | 0  | 0  | 0  | 0  | 0  | 0  |
| 2090 | 0  | 0  | 0  | 0  | 0  | 0  | 0  | 0  | 0  | 0  | 0  | 0  | 0  |

| 12%  | 79  | 80  | 81  | 82   | 83   | 84   | 85   | 86   | 87   | 88   | 89   | 90   | 91  |
|------|-----|-----|-----|------|------|------|------|------|------|------|------|------|-----|
| 2002 | 0   | 0   | 0   | 0    | 0    | 0    | 0    | 0    | 0    | 0    | 0    | 0    | 0   |
| 2003 | 0   | 0   | 0   | 0    | 0    | 0    | 0    | 0    | 0    | 0    | 0    | 0    | 0   |
| 2004 | 0   | 0   | 0   | 0    | 0    | 0    | 0    | 0    | 0    | 0    | 0    | 0    | 0   |
| 2005 | 0   | 0   | 0   | 0    | 0    | 0    | 0    | 0    | 0    | 0    | 0    | 0    | 0   |
| 2006 | 0   | 0   | 0   | 0    | 0    | 0    | 0    | 0    | 0    | 0    | 0    | 0    | 0   |
| 2007 | 0   | 0   | 0   | 0    | 0    | 0    | 0    | 0    | 0    | 0    | 0    | 0    | 0   |
| 2008 | 0   | 0   | 0   | 0    | 0    | 0    | 0    | 0    | 0    | 0    | 0    | 0    | 0   |
| 2009 | 0   | 0   | 0   | 0    | 0    | 0    | 0    | 0    | 0    | 0    | 0    | 0    | 0   |
| 2010 | 0   | 0   | 0   | 0    | 0    | 0    | 0    | 0    | 0    | 0    | 0    | 0    | 0   |
| 2011 | 0   | 0   | 0   | 0    | 0    | 0    | 0    | 0    | 0    | 0    | 0    | 0    | 0   |
| 2012 | 0   | 0   | 0   | 0    | 0    | 0    | 0    | 0    | 0    | 0    | 0    | 0    | 0   |
| 2013 | 0   | 0   | 0   | 0    | 0    | 0    | 0    | 0    | 0    | 0    | 0    | 0    | 0   |
| 2014 | 0   | 0   | 0   | 0    | 0    | 0    | 0    | 0    | 0    | 0    | 0    | 0    | 0   |
| 2015 | 0   | 0   | 0   | 0    | 0    | 0    | 0    | 0    | 0    | 0    | 0    | 0    | 0   |
| 2016 | 0   | 0   | 0   | 0    | 0    | 0    | 0    | 0    | 0    | 0    | 0    | 0    | 0   |
| 2017 | 0   | 0   | 0   | 0    | 0    | 0    | 0    | 0    | 0    | 0    | 0    | 0    | 0   |
| 2018 | 0   | 0   | 0   | 0    | 0    | 0    | 0    | 0    | 0    | 0    | 0    | 0    | 0   |
| 2019 | 0   | 0   | 0   | 0    | 0    | 0    | 0    | 0    | 0    | 0    | 0    | 0    | 0   |
| 2020 | 0   | 0   | 0   | 0    | 0    | 0    | 991  | 0    | 0    | 0    | 0    | 0    | 0   |
| 2021 | 0   | 0   | 0   | 0    | 0    | 0    | 924  | 0    | 0    | 0    | 0    | 0    | 0   |
| 2022 | 0   | 0   | 0   | 0    | 0    | 0    | 1034 | 0    | 0    | 0    | 0    | 0    | 0   |
| 2023 | 0   | 0   | 0   | 0    | 0    | 0    | 995  | 0    | 0    | 0    | 0    | 0    | 0   |
| 2024 | 0   | 0   | 0   | 0    | 0    | 0    | 987  | 0    | 0    | 0    | 0    | 0    | 0   |
| 2025 | 250 | 4   | 66  | 998  | 998  | 0    | 1014 | 998  | 998  | 998  | 998  | 998  | 277 |
| 2026 | 815 | 0   | 468 | 862  | 1002 | 0    | 1100 | 959  | 959  | 959  | 959  | 959  | 410 |
| 2027 | 800 | 4   | 378 | 956  | 1190 | 0    | 1002 | 1115 | 1115 | 1115 | 1115 | 1115 | 413 |
| 2028 | 858 | 70  | 324 | 866  | 1069 | 0    | 987  | 983  | 983  | 983  | 983  | 983  | 515 |
| 2029 | 640 | 51  | 347 | 901  | 1154 | 0    | 998  | 1057 | 1057 | 1057 | 1057 | 1057 | 433 |
| 2030 | 566 | 94  | 398 | 963  | 1186 | 998  | 1186 | 1084 | 1084 | 1084 | 1084 | 1084 | 491 |
| 2031 | 636 | 98  | 332 | 967  | 1115 | 1022 | 1100 | 1057 | 1057 | 1057 | 1057 | 1057 | 679 |
| 2032 | 683 | 129 | 394 | 870  | 1076 | 1069 | 991  | 959  | 959  | 959  | 959  | 959  | 593 |
| 2033 | 593 | 148 | 335 | 917  | 1119 | 1213 | 1221 | 1014 | 1014 | 1014 | 1010 | 1014 | 675 |
| 2034 | 686 | 191 | 402 | 971  | 1127 | 1135 | 1307 | 1057 | 1057 | 1057 | 1037 | 1057 | 710 |
| 2035 | 725 | 156 | 308 | 967  | 1045 | 1314 | 1088 | 1002 | 1002 | 1002 | 967  | 1002 | 725 |
| 2036 | 644 | 156 | 316 | 1131 | 1201 | 1197 | 1459 | 1186 | 1256 | 1186 | 1123 | 1186 | 667 |
| 2037 | 753 | 207 | 347 | 1034 | 1100 | 1139 | 995  | 1061 | 1088 | 1065 | 936  | 1065 | 620 |
| 2038 | 663 | 226 | 390 | 1166 | 1225 | 1022 | 815  | 1205 | 1283 | 1213 | 1014 | 1213 | 593 |
| 2039 | 655 | 117 | 316 | 1225 | 1287 | 1069 | 1026 | 1260 | 1065 | 1256 | 928  | 1256 | 573 |
| 2040 | 710 | 199 | 394 | 1217 | 1307 | 1022 | 1010 | 1232 | 1256 | 1268 | 811  | 1268 | 624 |
| 2041 | 780 | 238 | 331 | 1377 | 1466 | 1076 | 737  | 1279 | 1193 | 1459 | 998  | 1427 | 589 |
| 2042 | 905 | 218 | 452 | 983  | 1002 | 1026 | 308  | 1205 | 1307 | 1037 | 690  | 1002 | 632 |
| 2043 | 706 | 203 | 343 | 1291 | 1346 | 1100 | 23   | 1190 | 1283 | 1416 | 1108 | 1338 | 605 |
| 2044 | 753 | 179 | 312 | 1256 | 1346 | 1080 | 293  | 1252 | 1174 | 1392 | 1049 | 1299 | 503 |
| 2045 | 542 | 176 | 328 | 74   | 160  | 1439 | 137  | 117  | 82   | 125  | 125  | 125  | 390 |
| 2046 | 105 | 105 | 105 | 402  | 846  | 1143 | 125  | 655  | 659  | 659  | 659  | 659  | 394 |
| 2047 | 905 | 905 | 905 | 281  | 636  | 1205 | 98   | 468  | 484  | 468  | 468  | 468  | 269 |
| 2048 | 788 | 788 | 788 | 265  | 632  | 195  | 8    | 460  | 441  | 456  | 456  | 456  | 0   |
| 2049 | 569 | 569 | 569 | 160  | 413  | 729  | 16   | 304  | 304  | 289  | 289  | 289  | 413 |
| 2050 | 273 | 273 | 273 | 105  | 285  | 694  | 0    | 199  | 195  | 187  | 187  | 187  | 343 |
| 2051 | 117 | 117 | 117 | 98   | 246  | 651  | 0    | 164  | 168  | 172  | 172  | 172  | 328 |
| 2052 | 12  | 12  | 12  | 47   | 148  | 499  | 0    | 117  | 105  | 101  | 101  | 101  | 222 |
| 2053 | 0   | 0   | 0   | 12   | 35   | 503  | 0    | 43   | 31   | 23   | 23   | 23   | 109 |
| 2054 | 0   | 0   | 0   | 4    | 12   | 445  | 0    | 12   | 8    | 8    | 8    | 8    | 62  |
| 2055 | 0   | 0   | 0   | 12   | 27   | 355  | 0    | 12   | 20   | 20   | 20   | 20   | 43  |
| 2056 | 0   | 0   | 0   | 0    | 0    | 296  | 0    | 0    | 0    | 0    | 0    | 0    | 23  |
| 2057 | 0   | 0   | 0   | 0    | 0    | 203  | 0    | 0    | 0    | 0    | 0    | 0    | 12  |
| 2058 | 0   | 0   | 0   | 0    | 0    | 137  | 0    | 0    | 0    | 0    | 0    | 0    | 8   |
| 2059 | 0   | 0   | 0   | 0    | 0    | 90   | 0    | 0    | 0    | 0    | 0    | 0    | 0   |

| 12%  | 79 | 80 | 81 | 82 | 83 | 84 | 85 | 86 | 87 | 88 | 89 | 90 | 91 |
|------|----|----|----|----|----|----|----|----|----|----|----|----|----|
| 2060 | 0  | 0  | 0  | 0  | 0  | 20 | 0  | 0  | 0  | 0  | 0  | 0  | 0  |
| 2061 | 0  | 0  | 0  | 0  | 0  | 12 | 0  | 0  | 0  | 0  | 0  | 0  | 0  |
| 2062 | 0  | 0  | 0  | 0  | 0  | 0  | 0  | 0  | 0  | 0  | 0  | 0  | 0  |
| 2063 | 0  | 0  | 0  | 0  | 0  | 0  | 0  | 0  | 0  | 0  | 0  | 0  | 0  |
| 2064 | 0  | 0  | 0  | 0  | 0  | 0  | 0  | 0  | 0  | 0  | 0  | 0  | 0  |
| 2065 | 0  | 0  | 0  | 0  | 0  | 0  | 0  | 0  | 0  | 0  | 0  | 0  | 0  |
| 2066 | 0  | 0  | 0  | 0  | 0  | 0  | 0  | 0  | 0  | 0  | 0  | 0  | 0  |
| 2067 | 0  | 0  | 0  | 0  | 0  | 0  | 0  | 0  | 0  | 0  | 0  | 0  | 0  |
| 2068 | 0  | 0  | 0  | 0  | 0  | 0  | 0  | 0  | 0  | 0  | 0  | 0  | 0  |
| 2069 | 0  | 0  | 0  | 0  | 0  | 0  | 0  | 0  | 0  | 0  | 0  | 0  | 0  |
| 2070 | 0  | 0  | 0  | 0  | 0  | 0  | 0  | 0  | 0  | 0  | 0  | 0  | 0  |
| 2071 | 0  | 0  | 0  | 0  | 0  | 0  | 0  | 0  | 0  | 0  | 0  | 0  | 0  |
| 2072 | 0  | 0  | 0  | 0  | 0  | 0  | 0  | 0  | 0  | 0  | 0  | 0  | 0  |
| 2073 | 0  | 0  | 0  | 0  | 0  | 0  | 0  | 0  | 0  | 0  | 0  | 0  | 0  |
| 2074 | 0  | 0  | 0  | 0  | 0  | 0  | 0  | 0  | 0  | 0  | 0  | 0  | 0  |
| 2075 | 0  | 0  | 0  | 0  | 0  | 0  | 0  | 0  | 0  | 0  | 0  | 0  | 0  |
| 2076 | 0  | 0  | 0  | 0  | 0  | 0  | 0  | 0  | 0  | 0  | 0  | 0  | 0  |
| 2077 | 0  | 0  | 0  | 0  | 0  | 0  | 0  | 0  | 0  | 0  | 0  | 0  | 0  |
| 2078 | 0  | 0  | 0  | 0  | 0  | 0  | 0  | 0  | 0  | 0  | 0  | 0  | 0  |
| 2079 | 0  | 0  | 0  | 0  | 0  | 0  | 0  | 0  | 0  | 0  | 0  | 0  | 0  |
| 2080 | 0  | 0  | 0  | 0  | 0  | 0  | 0  | 0  | 0  | 0  | 0  | 0  | 0  |
| 2081 | 0  | 0  | 0  | 0  | 0  | 0  | 0  | 0  | 0  | 0  | 0  | 0  | 0  |
| 2082 | 0  | 0  | 0  | 0  | 0  | 0  | 0  | 0  | 0  | 0  | 0  | 0  | 0  |
| 2083 | 0  | 0  | 0  | 0  | 0  | 0  | 0  | 0  | 0  | 0  | 0  | 0  | 0  |
| 2084 | 0  | 0  | 0  | 0  | 0  | 0  | 0  | 0  | 0  | 0  | 0  | 0  | 0  |
| 2085 | 0  | 0  | 0  | 0  | 0  | 0  | 0  | 0  | 0  | 0  | 0  | 0  | 0  |
| 2086 | 0  | 0  | 0  | 0  | 0  | 0  | 0  | 0  | 0  | 0  | 0  | 0  | 0  |
| 2087 | 0  | 0  | 0  | 0  | 0  | 0  | 0  | 0  | 0  | 0  | 0  | 0  | 0  |
| 2088 | 0  | 0  | 0  | 0  | 0  | 0  | 0  | 0  | 0  | 0  | 0  | 0  | 0  |
| 2089 | 0  | 0  | 0  | 0  | 0  | 0  | 0  | 0  | 0  | 0  | 0  | 0  | 0  |
| 2090 | 0  | 0  | 0  | 0  | 0  | 0  | 0  | 0  | 0  | 0  | 0  | 0  | 0  |

| 12%  | 92  | 93  | 94  | 95  | 96  | 97   | 98  | 99  | 100 | 101 | 102 | 103 | 104 |
|------|-----|-----|-----|-----|-----|------|-----|-----|-----|-----|-----|-----|-----|
| 2002 | 0   | 0   | 0   | 0   | 0   | 0    | 0   | 0   | 0   | 0   | 0   | 0   | 0   |
| 2003 | 0   | 0   | 0   | 0   | 0   | 0    | 0   | 0   | 0   | 0   | 0   | 0   | 0   |
| 2004 | 0   | 0   | 0   | 0   | 0   | 0    | 0   | 0   | 0   | 0   | 0   | 0   | 0   |
| 2005 | 0   | 0   | 0   | 0   | 0   | 0    | 0   | 0   | 0   | 0   | 0   | 0   | 0   |
| 2006 | 0   | 0   | 0   | 0   | 0   | 0    | 0   | 0   | 0   | 0   | 0   | 0   | 0   |
| 2007 | 0   | 0   | 0   | 0   | 0   | 0    | 0   | 0   | 0   | 0   | 0   | 0   | 0   |
| 2008 | 0   | 0   | 0   | 0   | 0   | 0    | 0   | 0   | 0   | 0   | 0   | 0   | 0   |
| 2009 | 0   | 0   | 0   | 0   | 0   | 0    | 0   | 0   | 0   | 0   | 0   | 0   | 0   |
| 2010 | 0   | 0   | 0   | 0   | 0   | 0    | 0   | 0   | 0   | 0   | 0   | 0   | 0   |
| 2011 | 0   | 0   | 0   | 0   | 0   | 0    | 0   | 0   | 0   | 0   | 0   | 0   | 0   |
| 2012 | 0   | 0   | 0   | 0   | 0   | 0    | 0   | 0   | 0   | 0   | 0   | 0   | 0   |
| 2013 | 0   | 0   | 0   | 0   | 0   | 0    | 0   | 0   | 0   | 0   | 0   | 0   | 0   |
| 2014 | 0   | 0   | 0   | 0   | 0   | 0    | 0   | 0   | 0   | 0   | 0   | 0   | 0   |
| 2015 | 0   | 0   | 0   | 0   | 0   | 0    | 0   | 0   | 0   | 0   | 0   | 0   | 0   |
| 2016 | 0   | 0   | 0   | 0   | 0   | 0    | 0   | 0   | 0   | 0   | 0   | 0   | 0   |
| 2017 | 0   | 0   | 0   | 0   | 0   | 0    | 0   | 0   | 0   | 0   | 0   | 0   | 0   |
| 2018 | 0   | 0   | 0   | 0   | 0   | 0    | 0   | 0   | 0   | 0   | 0   | 0   | 0   |
| 2019 | 0   | 0   | 0   | 0   | 0   | 0    | 0   | 0   | 0   | 0   | 0   | 0   | 0   |
| 2020 | 0   | 0   | 351 | 0   | 0   | 0    | 0   | 0   | 0   | 0   | 0   | 39  | 0   |
| 2021 | 0   | 0   | 406 | 0   | 0   | 0    | 0   | 0   | 0   | 0   | 0   | 43  | 0   |
| 2022 | 0   | 0   | 554 | 0   | 0   | 0    | 0   | 0   | 0   | 0   | 0   | 140 | 0   |
| 2023 | 0   | 0   | 515 | 0   | 0   | 0    | 0   | 0   | 0   | 0   | 0   | 250 | 0   |
| 2024 | 0   | 0   | 527 | 0   | 0   | 0    | 0   | 0   | 0   | 0   | 0   | 176 | 0   |
| 2025 | 277 | 0   | 495 | 250 | 679 | 952  | 16  | 277 | 66  | 66  | 0   | 195 | 47  |
| 2026 | 764 | 0   | 562 | 558 | 901 | 1143 | 43  | 644 | 101 | 515 | 0   | 230 | 203 |
| 2027 | 686 | 0   | 640 | 499 | 858 | 1139 | 47  | 566 | 137 | 421 | 0   | 234 | 191 |
| 2028 | 780 | 0   | 714 | 601 | 909 | 1190 | 121 | 690 | 183 | 445 | 0   | 211 | 203 |
| 2029 | 675 | 0   | 741 | 499 | 784 | 1112 | 160 | 562 | 215 | 449 | 0   | 273 | 187 |
| 2030 | 686 | 257 | 737 | 644 | 733 | 1076 | 183 | 581 | 289 | 495 | 39  | 351 | 183 |
| 2031 | 819 | 823 | 675 | 721 | 620 | 1069 | 226 | 745 | 246 | 390 | 573 | 254 | 195 |
| 2032 | 706 | 768 | 839 | 640 | 698 | 1026 | 246 | 659 | 312 | 417 | 577 | 371 | 246 |
| 2033 | 788 | 737 | 636 | 749 | 620 | 1010 | 226 | 725 | 300 | 406 | 491 | 281 | 250 |
| 2034 | 803 | 874 | 858 | 694 | 725 | 1166 | 250 | 764 | 406 | 491 | 562 | 441 | 316 |
| 2035 | 784 | 792 | 667 | 792 | 616 | 1076 | 234 | 764 | 316 | 371 | 550 | 320 | 269 |
| 2036 | 737 | 710 | 527 | 745 | 788 | 944  | 359 | 706 | 343 | 429 | 460 | 410 | 320 |
| 2037 | 671 | 706 | 550 | 620 | 741 | 839  | 254 | 647 | 300 | 331 | 464 | 335 | 285 |
| 2038 | 655 | 885 | 566 | 632 | 647 | 839  | 296 | 624 | 363 | 437 | 597 | 320 | 238 |
| 2039 | 628 | 796 | 441 | 554 | 714 | 792  | 211 | 597 | 367 | 425 | 472 | 234 | 183 |
| 2040 | 663 | 577 | 343 | 620 | 714 | 881  | 199 | 644 | 402 | 449 | 410 | 269 | 222 |
| 2041 | 647 | 819 | 417 | 686 | 686 | 897  | 324 | 620 | 269 | 312 | 530 | 371 | 234 |
| 2042 | 714 | 788 | 417 | 690 | 714 | 917  | 277 | 671 | 429 | 515 | 429 | 542 | 289 |
| 2043 | 651 | 718 | 277 | 628 | 577 | 749  | 226 | 632 | 355 | 374 | 503 | 250 | 304 |
| 2044 | 538 | 725 | 211 | 472 | 538 | 601  | 160 | 519 | 328 | 347 | 425 | 82  | 242 |
| 2045 | 421 | 616 | 332 | 406 | 733 | 542  | 226 | 406 | 335 | 367 | 312 | 402 | 257 |
| 2046 | 413 | 624 | 98  | 374 | 562 | 476  | 156 | 402 | 55  | 129 | 445 | 265 | 43  |
| 2047 | 269 | 546 | 19  | 70  | 90  | 472  | 98  | 269 | 390 | 850 | 410 | 125 | 682 |
| 2048 | 0   | 374 | 484 | 20  | 698 | 0    | 0   | 0   | 332 | 803 | 78  | 55  | 601 |
| 2049 | 897 | 35  | 304 | 706 | 608 | 710  | 710 | 710 | 335 | 776 | 94  | 35  | 573 |
| 2050 | 803 | 741 | 133 | 632 | 495 | 616  | 616 | 616 | 215 | 507 | 757 | 16  | 378 |
| 2051 | 757 | 690 | 59  | 573 | 281 | 573  | 573 | 573 | 117 | 296 | 667 | 12  | 215 |
| 2052 | 519 | 714 | 31  | 413 | 164 | 374  | 374 | 374 | 62  | 156 | 686 | 0   | 113 |
| 2053 | 289 | 655 | 31  | 218 | 98  | 211  | 211 | 211 | 43  | 117 | 686 | 0   | 78  |
| 2054 | 152 | 589 | 0   | 117 | 78  | 109  | 109 | 109 | 23  | 59  | 608 | 0   | 43  |
| 2055 | 117 | 480 | 0   | 78  | 43  | 78   | 78  | 78  | 12  | 31  | 441 | 0   | 23  |
| 2056 | 58  | 316 | 0   | 43  | 23  | 43   | 43  | 43  | 8   | 23  | 281 | 0   | 0   |
| 2057 | 31  | 172 | 0   | 23  | 16  | 23   | 23  | 23  | 0   | 0   | 148 | 0   | 0   |
| 2058 | 23  | 105 | 0   | 16  | 0   | 16   | 16  | 16  | 0   | 0   | 117 | 0   | 0   |
| 2059 | 0   | 51  | 0   | 0   | 0   | 0    | 0   | 0   | 0   | 0   | 51  | 0   | 0   |

| 12%  | 92 | 93 | 94 | 95 | 96 | 97 | 98 | 99 | 100 | 101 | 102 | 103 | 104 |
|------|----|----|----|----|----|----|----|----|-----|-----|-----|-----|-----|
| 2060 | 0  | 39 | 0  | 0  | 0  | 0  | 0  | 0  | 0   | 0   | 39  | 0   | 0   |
| 2061 | 0  | 23 | 0  | 0  | 0  | 0  | 0  | 0  | 0   | 0   | 23  | 0   | 0   |
| 2062 | 0  | 16 | 0  | 0  | 0  | 0  | 0  | 0  | 0   | 0   | 16  | 0   | 0   |
| 2063 | 0  | 0  | 0  | 0  | 0  | 0  | 0  | 0  | 0   | 0   | 0   | 0   | 0   |
| 2064 | 0  | 0  | 0  | 0  | 0  | 0  | 0  | 0  | 0   | 0   | 0   | 0   | 0   |
| 2065 | 0  | 0  | 0  | 0  | 0  | 0  | 0  | 0  | 0   | 0   | 0   | 0   | 0   |
| 2066 | 0  | 0  | 0  | 0  | 0  | 0  | 0  | 0  | 0   | 0   | 0   | 0   | 0   |
| 2067 | 0  | 0  | 0  | 0  | 0  | 0  | 0  | 0  | 0   | 0   | 0   | 0   | 0   |
| 2068 | 0  | 0  | 0  | 0  | 0  | 0  | 0  | 0  | 0   | 0   | 0   | 0   | 0   |
| 2069 | 0  | 0  | 0  | 0  | 0  | 0  | 0  | 0  | 0   | 0   | 0   | 0   | 0   |
| 2070 | 0  | 0  | 0  | 0  | 0  | 0  | 0  | 0  | 0   | 0   | 0   | 0   | 0   |
| 2071 | 0  | 0  | 0  | 0  | 0  | 0  | 0  | 0  | 0   | 0   | 0   | 0   | 0   |
| 2072 | 0  | 0  | 0  | 0  | 0  | 0  | 0  | 0  | 0   | 0   | 0   | 0   | 0   |
| 2073 | 0  | 0  | 0  | 0  | 0  | 0  | 0  | 0  | 0   | 0   | 0   | 0   | 0   |
| 2074 | 0  | 0  | 0  | 0  | 0  | 0  | 0  | 0  | 0   | 0   | 0   | 0   | 0   |
| 2075 | 0  | 0  | 0  | 0  | 0  | 0  | 0  | 0  | 0   | 0   | 0   | 0   | 0   |
| 2076 | 0  | 0  | 0  | 0  | 0  | 0  | 0  | 0  | 0   | 0   | 0   | 0   | 0   |
| 2077 | 0  | 0  | 0  | 0  | 0  | 0  | 0  | 0  | 0   | 0   | 0   | 0   | 0   |
| 2078 | 0  | 0  | 0  | 0  | 0  | 0  | 0  | 0  | 0   | 0   | 0   | 0   | 0   |
| 2079 | 0  | 0  | 0  | 0  | 0  | 0  | 0  | 0  | 0   | 0   | 0   | 0   | 0   |
| 2080 | 0  | 0  | 0  | 0  | 0  | 0  | 0  | 0  | 0   | 0   | 0   | 0   | 0   |
| 2081 | 0  | 0  | 0  | 0  | 0  | 0  | 0  | 0  | 0   | 0   | 0   | 0   | 0   |
| 2082 | 0  | 0  | 0  | 0  | 0  | 0  | 0  | 0  | 0   | 0   | 0   | 0   | 0   |
| 2083 | 0  | 0  | 0  | 0  | 0  | 0  | 0  | 0  | 0   | 0   | 0   | 0   | 0   |
| 2084 | 0  | 0  | 0  | 0  | 0  | 0  | 0  | 0  | 0   | 0   | 0   | 0   | 0   |
| 2085 | 0  | 0  | 0  | 0  | 0  | 0  | 0  | 0  | 0   | 0   | 0   | 0   | 0   |
| 2086 | 0  | 0  | 0  | 0  | 0  | 0  | 0  | 0  | 0   | 0   | 0   | 0   | 0   |
| 2087 | 0  | 0  | 0  | 0  | 0  | 0  | 0  | 0  | 0   | 0   | 0   | 0   | 0   |
| 2088 | 0  | 0  | 0  | 0  | 0  | 0  | 0  | 0  | 0   | 0   | 0   | 0   | 0   |
| 2089 | 0  | 0  | 0  | 0  | 0  | 0  | 0  | 0  | 0   | 0   | 0   | 0   | 0   |
| 2090 | 0  | 0  | 0  | 0  | 0  | 0  | 0  | 0  | 0   | 0   | 0   | 0   | 0   |

| 12%  | 105 | 106 | 107 | 108 | 109  | 110  | 111  | 112  | 113  | 114  | 115  | 116  | 117  |
|------|-----|-----|-----|-----|------|------|------|------|------|------|------|------|------|
| 2002 | 0   | 0   | 0   | 0   | 0    | 0    | 0    | 0    | 0    | 0    | 0    | 0    | 0    |
| 2003 | 0   | 0   | 0   | 0   | 0    | 0    | 0    | 0    | 0    | 0    | 0    | 0    | 0    |
| 2004 | 0   | 0   | 0   | 0   | 0    | 0    | 0    | 0    | 0    | 0    | 0    | 0    | 0    |
| 2005 | 0   | 0   | 0   | 0   | 0    | 0    | 0    | 0    | 0    | 0    | 0    | 0    | 0    |
| 2006 | 0   | 0   | 0   | 0   | 0    | 0    | 0    | 0    | 0    | 0    | 0    | 0    | 0    |
| 2007 | 0   | 0   | 0   | 0   | 0    | 0    | 0    | 0    | 0    | 0    | 0    | 0    | 0    |
| 2008 | 0   | 0   | 0   | 0   | 0    | 0    | 0    | 0    | 0    | 0    | 0    | 0    | 0    |
| 2009 | 0   | 0   | 0   | 0   | 0    | 0    | 0    | 0    | 0    | 0    | 0    | 0    | 0    |
| 2010 | 0   | 0   | 0   | 0   | 0    | 0    | 0    | 0    | 0    | 0    | 0    | 0    | 0    |
| 2011 | 0   | 0   | 0   | 0   | 0    | 0    | 0    | 0    | 0    | 0    | 0    | 0    | 0    |
| 2012 | 0   | 0   | 0   | 0   | 0    | 0    | 0    | 0    | 0    | 0    | 0    | 0    | 0    |
| 2013 | 0   | 0   | 0   | 0   | 0    | 0    | 0    | 0    | 0    | 0    | 0    | 0    | 0    |
| 2014 | 0   | 0   | 0   | 0   | 0    | 0    | 0    | 0    | 0    | 0    | 0    | 0    | 0    |
| 2015 | 0   | 0   | 0   | 0   | 0    | 0    | 0    | 0    | 0    | 0    | 0    | 0    | 0    |
| 2016 | 0   | 0   | 0   | 0   | 0    | 0    | 0    | 0    | 0    | 0    | 0    | 0    | 0    |
| 2017 | 0   | 0   | 0   | 0   | 0    | 0    | 0    | 0    | 0    | 0    | 0    | 0    | 0    |
| 2018 | 0   | 0   | 0   | 0   | 0    | 0    | 0    | 0    | 0    | 0    | 0    | 0    | 0    |
| 2019 | 0   | 0   | 0   | 0   | 0    | 0    | 0    | 0    | 0    | 0    | 0    | 0    | 0    |
| 2020 | 0   | 0   | 0   | 0   | 0    | 0    | 0    | 991  | 0    | 0    | 0    | 0    | 0    |
| 2021 | 0   | 0   | 0   | 0   | 0    | 0    | 0    | 983  | 0    | 0    | 0    | 0    | 0    |
| 2022 | 0   | 0   | 0   | 0   | 0    | 0    | 0    | 991  | 0    | 0    | 0    | 0    | 0    |
| 2023 | 0   | 0   | 0   | 0   | 0    | 0    | 0    | 1002 | 0    | 0    | 0    | 0    | 0    |
| 2024 | 0   | 0   | 0   | 0   | 0    | 0    | 0    | 979  | 0    | 0    | 0    | 0    | 0    |
| 2025 | 246 | 250 | 4   | 66  | 998  | 998  | 0    | 1049 | 998  | 998  | 998  | 998  | 998  |
| 2026 | 683 | 647 | 0   | 367 | 975  | 975  | 0    | 998  | 975  | 975  | 975  | 975  | 975  |
| 2027 | 542 | 632 | 4   | 289 | 979  | 979  | 0    | 1002 | 979  | 979  | 979  | 979  | 979  |
| 2028 | 803 | 737 | 66  | 339 | 991  | 991  | 0    | 991  | 991  | 991  | 991  | 991  | 991  |
| 2029 | 698 | 636 | 35  | 328 | 975  | 975  | 0    | 1108 | 975  | 975  | 975  | 975  | 975  |
| 2030 | 542 | 593 | 94  | 390 | 983  | 983  | 998  | 1037 | 983  | 983  | 983  | 983  | 983  |
| 2031 | 589 | 651 | 90  | 312 | 1006 | 1006 | 987  | 1006 | 1006 | 1006 | 1006 | 1006 | 1006 |
| 2032 | 577 | 671 | 109 | 371 | 998  | 998  | 975  | 1100 | 998  | 1034 | 998  | 971  | 998  |
| 2033 | 417 | 616 | 148 | 351 | 975  | 1034 | 1002 | 1131 | 975  | 987  | 1010 | 991  | 1010 |
| 2034 | 573 | 733 | 179 | 452 | 1026 | 1026 | 994  | 936  | 1010 | 936  | 1026 | 874  | 1026 |
| 2035 | 460 | 745 | 160 | 351 | 1057 | 1057 | 983  | 1248 | 1041 | 1014 | 1057 | 815  | 1057 |
| 2036 | 542 | 690 | 176 | 390 | 1100 | 1135 | 1041 | 998  | 1100 | 1018 | 1112 | 702  | 1108 |
| 2037 | 511 | 741 | 191 | 316 | 1045 | 1139 | 1022 | 764  | 1073 | 1166 | 1100 | 803  | 1092 |
| 2038 | 530 | 698 | 218 | 402 | 1229 | 1256 | 1022 | 901  | 1268 | 1174 | 1271 | 800  | 1252 |
| 2039 | 402 | 714 | 179 | 394 | 920  | 1018 | 1018 | 901  | 1053 | 1041 | 983  | 601  | 944  |
| 2040 | 671 | 749 | 215 | 425 | 1170 | 1275 | 1034 | 901  | 1186 | 1147 | 1268 | 874  | 1174 |
| 2041 | 573 | 796 | 195 | 293 | 885  | 936  | 1069 | 503  | 940  | 940  | 1104 | 605  | 940  |
| 2042 | 835 | 932 | 218 | 468 | 1170 | 1268 | 1131 | 215  | 1158 | 1108 | 1427 | 952  | 1303 |
| 2043 | 565 | 710 | 226 | 367 | 386  | 445  | 1193 | 285  | 35   | 425  | 172  | 125  | 160  |
| 2044 | 640 | 784 | 152 | 339 | 16   | 452  | 839  | 293  | 176  | 195  | 335  | 335  | 335  |
| 2045 | 589 | 577 | 199 | 359 | 222  | 690  | 378  | 289  | 499  | 550  | 468  | 468  | 468  |
| 2046 | 90  | 98  | 98  | 98  | 285  | 612  | 347  | 183  | 620  | 647  | 484  | 484  | 484  |
| 2047 | 667 | 663 | 663 | 663 | 359  | 647  | 460  | 476  | 554  | 511  | 515  | 515  | 515  |
| 2048 | 612 | 605 | 605 | 605 | 332  | 714  | 534  | 296  | 538  | 601  | 577  | 577  | 577  |
| 2049 | 523 | 593 | 593 | 593 | 308  | 562  | 733  | 55   | 472  | 421  | 456  | 456  | 456  |
| 2050 | 300 | 367 | 367 | 367 | 328  | 523  | 718  | 90   | 433  | 406  | 445  | 445  | 445  |
| 2051 | 125 | 211 | 211 | 211 | 226  | 597  | 566  | 70   | 374  | 382  | 300  | 300  | 300  |
| 2052 | 98  | 113 | 113 | 113 | 211  | 620  | 702  | 0    | 296  | 410  | 335  | 335  | 335  |
| 2053 | 78  | 78  | 78  | 78  | 277  | 499  | 667  | 39   | 534  | 480  | 581  | 581  | 581  |
| 2054 | 43  | 43  | 43  | 43  | 269  | 495  | 538  | 0    | 534  | 339  | 413  | 413  | 413  |
| 2055 | 23  | 23  | 23  | 23  | 86   | 328  | 448  | 0    | 269  | 277  | 281  | 281  | 281  |
| 2056 | 16  | 16  | 16  | 16  | 148  | 269  | 296  | 0    | 246  | 246  | 246  | 246  | 246  |
| 2057 | 0   | 0   | 0   | 0   | 191  | 0    | 647  | 0    | 195  | 117  | 109  | 109  | 109  |
| 2058 | 0   | 0   | 0   | 0   | 4    | 105  | 624  | 0    | 19   | 31   | 31   | 31   | 31   |
| 2059 | 0   | 0   | 0   | 0   | 51   | 0    | 612  | 0    | 35   | 12   | 20   | 20   | 20   |

| 12%  | 105 | 106 | 107 | 108 | 109 | 110 | 111 | 112 | 113 | 114 | 115 | 116 | 117 |
|------|-----|-----|-----|-----|-----|-----|-----|-----|-----|-----|-----|-----|-----|
| 2060 | 0   | 0   | 0   | 0   | 0   | 0   | 480 | 0   | 0   | 31  | 31  | 31  | 31  |
| 2061 | 0   | 0   | 0   | 0   | 0   | 0   | 374 | 0   | 0   | 0   | 0   | 0   | 0   |
| 2062 | 0   | 0   | 0   | 0   | 0   | 0   | 254 | 0   | 0   | 0   | 0   | 0   | 0   |
| 2063 | 0   | 0   | 0   | 0   | 0   | 0   | 191 | 0   | 0   | 0   | 0   | 0   | 0   |
| 2064 | 0   | 0   | 0   | 0   | 0   | 0   | 39  | 0   | 0   | 0   | 0   | 0   | 0   |
| 2065 | 0   | 0   | 0   | 0   | 0   | 0   | 20  | 0   | 0   | 0   | 0   | 0   | 0   |
| 2066 | 0   | 0   | 0   | 0   | 0   | 0   | 0   | 0   | 0   | 0   | 0   | 0   | 0   |
| 2067 | 0   | 0   | 0   | 0   | 0   | 0   | 0   | 0   | 0   | 0   | 0   | 0   | 0   |
| 2068 | 0   | 0   | 0   | 0   | 0   | 0   | 0   | 0   | 0   | 0   | 0   | 0   | 0   |
| 2069 | 0   | 0   | 0   | 0   | 0   | 0   | 0   | 0   | 0   | 0   | 0   | 0   | 0   |
| 2070 | 0   | 0   | 0   | 0   | 0   | 0   | 0   | 0   | 0   | 0   | 0   | 0   | 0   |
| 2071 | 0   | 0   | 0   | 0   | 0   | 0   | 0   | 0   | 0   | 0   | 0   | 0   | 0   |
| 2072 | 0   | 0   | 0   | 0   | 0   | 0   | 0   | 0   | 0   | 0   | 0   | 0   | 0   |
| 2073 | 0   | 0   | 0   | 0   | 0   | 0   | 0   | 0   | 0   | 0   | 0   | 0   | 0   |
| 2074 | 0   | 0   | 0   | 0   | 0   | 0   | 0   | 0   | 0   | 0   | 0   | 0   | 0   |
| 2075 | 0   | 0   | 0   | 0   | 0   | 0   | 0   | 0   | 0   | 0   | 0   | 0   | 0   |
| 2076 | 0   | 0   | 0   | 0   | 0   | 0   | 0   | 0   | 0   | 0   | 0   | 0   | 0   |
| 2077 | 0   | 0   | 0   | 0   | 0   | 0   | 0   | 0   | 0   | 0   | 0   | 0   | 0   |
| 2078 | 0   | 0   | 0   | 0   | 0   | 0   | 0   | 0   | 0   | 0   | 0   | 0   | 0   |
| 2079 | 0   | 0   | 0   | 0   | 0   | 0   | 0   | 0   | 0   | 0   | 0   | 0   | 0   |
| 2080 | 0   | 0   | 0   | 0   | 0   | 0   | 0   | 0   | 0   | 0   | 0   | 0   | 0   |
| 2081 | 0   | 0   | 0   | 0   | 0   | 0   | 0   | 0   | 0   | 0   | 0   | 0   | 0   |
| 2082 | 0   | 0   | 0   | 0   | 0   | 0   | 0   | 0   | 0   | 0   | 0   | 0   | 0   |
| 2083 | 0   | 0   | 0   | 0   | 0   | 0   | 0   | 0   | 0   | 0   | 0   | 0   | 0   |
| 2084 | 0   | 0   | 0   | 0   | 0   | 0   | 0   | 0   | 0   | 0   | 0   | 0   | 0   |
| 2085 | 0   | 0   | 0   | 0   | 0   | 0   | 0   | 0   | 0   | 0   | 0   | 0   | 0   |
| 2086 | 0   | 0   | 0   | 0   | 0   | 0   | 0   | 0   | 0   | 0   | 0   | 0   | 0   |
| 2087 | 0   | 0   | 0   | 0   | 0   | 0   | 0   | 0   | 0   | 0   | 0   | 0   | 0   |
| 2088 | 0   | 0   | 0   | 0   | 0   | 0   | 0   | 0   | 0   | 0   | 0   | 0   | 0   |
| 2089 | 0   | 0   | 0   | 0   | 0   | 0   | 0   | 0   | 0   | 0   | 0   | 0   | 0   |
| 2090 | 0   | 0   | 0   | 0   | 0   | 0   | 0   | 0   | 0   | 0   | 0   | 0   | 0   |



| 12%  | 118 | 119 | 120 | 121 | 122 | 123 | 124 | 125 | 126 | 127 | 128 | 129 | 130 |
|------|-----|-----|-----|-----|-----|-----|-----|-----|-----|-----|-----|-----|-----|
| 2002 | 0   | 0   | 0   | 0   | 0   | 0   | 0   | 0   | 0   | 0   | 0   | 0   | 0   |
| 2003 | 0   | 0   | 0   | 0   | 0   | 0   | 0   | 0   | 0   | 0   | 0   | 0   | 0   |
| 2004 | 0   | 0   | 0   | 0   | 0   | 0   | 0   | 0   | 0   | 0   | 0   | 0   | 0   |
| 2005 | 0   | 0   | 0   | 0   | 0   | 0   | 0   | 0   | 0   | 0   | 0   | 0   | 0   |
| 2006 | 0   | 0   | 0   | 0   | 0   | 0   | 0   | 0   | 0   | 0   | 0   | 0   | 0   |
| 2007 | 0   | 0   | 0   | 0   | 0   | 0   | 0   | 0   | 0   | 0   | 0   | 0   | 0   |
| 2008 | 0   | 0   | 0   | 0   | 0   | 0   | 0   | 0   | 0   | 0   | 0   | 0   | 0   |
| 2009 | 0   | 0   | 0   | 0   | 0   | 0   | 0   | 0   | 0   | 0   | 0   | 0   | 0   |
| 2010 | 0   | 0   | 0   | 0   | 0   | 0   | 0   | 0   | 0   | 0   | 0   | 0   | 0   |
| 2011 | 0   | 0   | 0   | 0   | 0   | 0   | 0   | 0   | 0   | 0   | 0   | 0   | 0   |
| 2012 | 0   | 0   | 0   | 0   | 0   | 0   | 0   | 0   | 0   | 0   | 0   | 0   | 0   |
| 2013 | 0   | 0   | 0   | 0   | 0   | 0   | 0   | 0   | 0   | 0   | 0   | 0   | 0   |
| 2014 | 0   | 0   | 0   | 0   | 0   | 0   | 0   | 0   | 0   | 0   | 0   | 0   | 0   |
| 2015 | 0   | 0   | 0   | 0   | 0   | 0   | 0   | 0   | 0   | 0   | 0   | 0   | 0   |
| 2016 | 0   | 0   | 0   | 0   | 0   | 0   | 0   | 0   | 0   | 0   | 0   | 0   | 0   |
| 2017 | 0   | 0   | 0   | 0   | 0   | 0   | 0   | 0   | 0   | 0   | 0   | 0   | 0   |
| 2018 | 0   | 0   | 0   | 0   | 0   | 0   | 0   | 0   | 0   | 0   | 0   | 0   | 0   |
| 2019 | 0   | 0   | 0   | 0   | 0   | 0   | 0   | 0   | 0   | 0   | 0   | 0   | 0   |
| 2020 | 0   | 0   | 0   | 351 | 0   | 0   | 0   | 0   | 0   | 0   | 0   | 0   | 39  |
| 2021 | 0   | 0   | 0   | 355 | 0   | 0   | 0   | 0   | 0   | 0   | 0   | 0   | 62  |
| 2022 | 0   | 0   | 0   | 413 | 0   | 0   | 0   | 0   | 0   | 0   | 0   | 0   | 86  |
| 2023 | 0   | 0   | 0   | 433 | 0   | 0   | 0   | 0   | 0   | 0   | 0   | 0   | 183 |
| 2024 | 0   | 0   | 0   | 554 | 0   | 0   | 0   | 0   | 0   | 0   | 0   | 0   | 148 |
| 2025 | 277 | 277 | 0   | 456 | 250 | 679 | 952 | 16  | 277 | 66  | 66  | 0   | 199 |
| 2026 | 347 | 347 | 0   | 523 | 324 | 597 | 924 | 90  | 347 | 129 | 129 | 0   | 168 |
| 2027 | 328 | 367 | 0   | 628 | 367 | 573 | 963 | 35  | 328 | 101 | 121 | 0   | 183 |
| 2028 | 413 | 413 | 0   | 722 | 476 | 523 | 885 | 109 | 413 | 140 | 140 | 0   | 230 |
| 2029 | 378 | 390 | 0   | 753 | 445 | 542 | 905 | 160 | 398 | 250 | 250 | 0   | 312 |
| 2030 | 499 | 530 | 257 | 612 | 585 | 628 | 936 | 129 | 499 | 250 | 250 | 39  | 371 |
| 2031 | 616 | 675 | 394 | 679 | 558 | 581 | 854 | 160 | 620 | 226 | 261 | 121 | 304 |
| 2032 | 554 | 647 | 398 | 686 | 566 | 725 | 920 | 199 | 632 | 203 | 289 | 183 | 355 |
| 2033 | 644 | 729 | 476 | 636 | 655 | 605 | 940 | 273 | 671 | 289 | 359 | 203 | 234 |
| 2034 | 581 | 632 | 491 | 562 | 589 | 577 | 905 | 238 | 593 | 320 | 374 | 265 | 320 |
| 2035 | 597 | 663 | 601 | 558 | 605 | 597 | 924 | 203 | 647 | 312 | 343 | 304 | 218 |
| 2036 | 499 | 632 | 495 | 597 | 519 | 503 | 675 | 222 | 488 | 261 | 289 | 234 | 402 |
| 2037 | 488 | 585 | 523 | 484 | 460 | 628 | 768 | 300 | 585 | 316 | 394 | 316 | 320 |
| 2038 | 507 | 546 | 616 | 495 | 472 | 624 | 718 | 203 | 527 | 320 | 449 | 312 | 230 |
| 2039 | 491 | 554 | 601 | 429 | 452 | 605 | 745 | 187 | 519 | 211 | 378 | 339 | 257 |
| 2040 | 706 | 772 | 554 | 402 | 507 | 577 | 878 | 195 | 710 | 359 | 335 | 374 | 312 |
| 2041 | 589 | 694 | 581 | 491 | 589 | 725 | 819 | 250 | 612 | 226 | 281 | 339 | 332 |
| 2042 | 640 | 811 | 827 | 394 | 585 | 885 | 889 | 402 | 761 | 328 | 433 | 343 | 562 |
| 2043 | 616 | 757 | 757 | 367 | 569 | 686 | 733 | 332 | 612 | 296 | 456 | 425 | 304 |
| 2044 | 581 | 667 | 761 | 316 | 671 | 511 | 721 | 394 | 663 | 316 | 460 | 355 | 371 |
| 2045 | 324 | 534 | 741 | 242 | 640 | 562 | 566 | 335 | 464 | 351 | 456 | 390 | 312 |
| 2046 | 347 | 468 | 628 | 187 | 527 | 495 | 519 | 203 | 417 | 347 | 355 | 499 | 39  |
| 2047 | 320 | 343 | 406 | 199 | 261 | 511 | 370 | 117 | 300 | 211 | 452 | 187 | 195 |
| 2048 | 179 | 230 | 332 | 125 | 425 | 261 | 234 | 129 | 191 | 144 | 733 | 343 | 246 |
| 2049 | 312 | 238 | 749 | 74  | 601 | 343 | 304 | 304 | 304 | 558 | 605 | 577 | 413 |
| 2050 | 246 | 729 | 764 | 215 | 554 | 351 | 593 | 593 | 593 | 273 | 640 | 667 | 238 |
| 2051 | 476 | 589 | 655 | 250 | 378 | 304 | 515 | 515 | 515 | 113 | 515 | 647 | 152 |
| 2052 | 168 | 581 | 527 | 339 | 351 | 460 | 359 | 359 | 359 | 129 | 686 | 601 | 82  |
| 2053 | 90  | 542 | 558 | 277 | 374 | 585 | 308 | 308 | 308 | 273 | 725 | 503 | 47  |
| 2054 | 94  | 741 | 550 | 105 | 495 | 577 | 402 | 402 | 402 | 523 | 667 | 581 | 16  |
| 2055 | 452 | 721 | 421 | 78  | 647 | 464 | 671 | 671 | 671 | 214 | 441 | 526 | 12  |
| 2056 | 378 | 534 | 441 | 55  | 445 | 277 | 495 | 495 | 495 | 160 | 265 | 488 | 0   |
| 2057 | 207 | 312 | 667 | 16  | 316 | 172 | 339 | 339 | 339 | 117 | 148 | 546 | 0   |
| 2058 | 78  | 199 | 690 | 0   | 172 | 70  | 175 | 176 | 176 | 117 | 82  | 675 | 0   |
| 2059 | 144 | 125 | 640 | 16  | 82  | 59  | 152 | 152 | 152 | 66  | 58  | 757 | 0   |

| 12%  | 118 | 119 | 120 | 121 | 122 | 123 | 124 | 125 | 126 | 127 | 128 | 129 | 130 |
|------|-----|-----|-----|-----|-----|-----|-----|-----|-----|-----|-----|-----|-----|
| 2060 | 90  | 82  | 484 | 0   | 47  | 8   | 82  | 82  | 82  | 0   | 0   | 468 | 0   |
| 2061 | 66  | 39  | 257 | 0   | 39  | 0   | 47  | 47  | 47  | 0   | 0   | 324 | 0   |
| 2062 | 0   | 27  | 172 | 0   | 0   | 0   | 8   | 8   | 8   | 0   | 0   | 230 | 0   |
| 2063 | 0   | 0   | 156 | 0   | 0   | 0   | 0   | 0   | 0   | 0   | 0   | 172 | 0   |
| 2064 | 0   | 0   | 156 | 0   | 0   | 0   | 0   | 0   | 0   | 0   | 0   | 156 | 0   |
| 2065 | 0   | 0   | 121 | 0   | 0   | 0   | 0   | 0   | 0   | 0   | 0   | 152 | 0   |
| 2066 | 0   | 0   | 58  | 0   | 0   | 0   | 0   | 0   | 0   | 0   | 0   | 23  | 0   |
| 2067 | 0   | 0   | 0   | 0   | 0   | 0   | 0   | 0   | 0   | 0   | 0   | 0   | 0   |
| 2068 | 0   | 0   | 0   | 0   | 0   | 0   | 0   | 0   | 0   | 0   | 0   | 0   | 0   |
| 2069 | 0   | 0   | 0   | 0   | 0   | 0   | 0   | 0   | 0   | 0   | 0   | 0   | 0   |
| 2070 | 0   | 0   | 0   | 0   | 0   | 0   | 0   | 0   | 0   | 0   | 0   | 0   | 0   |
| 2071 | 0   | 0   | 0   | 0   | 0   | 0   | 0   | 0   | 0   | 0   | 0   | 0   | 0   |
| 2072 | 0   | 0   | 0   | 0   | 0   | 0   | 0   | 0   | 0   | 0   | 0   | 0   | 0   |
| 2073 | 0   | 0   | 0   | 0   | 0   | 0   | 0   | 0   | 0   | 0   | 0   | 0   | 0   |
| 2074 | 0   | 0   | 0   | 0   | 0   | 0   | 0   | 0   | 0   | 0   | 0   | 0   | 0   |
| 2075 | 0   | 0   | 0   | 0   | 0   | 0   | 0   | 0   | 0   | 0   | 0   | 0   | 0   |
| 2076 | 0   | 0   | 0   | 0   | 0   | 0   | 0   | 0   | 0   | 0   | 0   | 0   | 0   |
| 2077 | 0   | 0   | 0   | 0   | 0   | 0   | 0   | 0   | 0   | 0   | 0   | 0   | 0   |
| 2078 | 0   | 0   | 0   | 0   | 0   | 0   | 0   | 0   | 0   | 0   | 0   | 0   | 0   |
| 2079 | 0   | 0   | 0   | 0   | 0   | 0   | 0   | 0   | 0   | 0   | 0   | 0   | 0   |
| 2080 | 0   | 0   | 0   | 0   | 0   | 0   | 0   | 0   | 0   | 0   | 0   | 0   | 0   |
| 2081 | 0   | 0   | 0   | 0   | 0   | 0   | 0   | 0   | 0   | 0   | 0   | 0   | 0   |
| 2082 | 0   | 0   | 0   | 0   | 0   | 0   | 0   | 0   | 0   | 0   | 0   | 0   | 0   |
| 2083 | 0   | 0   | 0   | 0   | 0   | 0   | 0   | 0   | 0   | 0   | 0   | 0   | 0   |
| 2084 | 0   | 0   | 0   | 0   | 0   | 0   | 0   | 0   | 0   | 0   | 0   | 0   | 0   |
| 2085 | 0   | 0   | 0   | 0   | 0   | 0   | 0   | 0   | 0   | 0   | 0   | 0   | 0   |
| 2086 | 0   | 0   | 0   | 0   | 0   | 0   | 0   | 0   | 0   | 0   | 0   | 0   | 0   |
| 2087 | 0   | 0   | 0   | 0   | 0   | 0   | 0   | 0   | 0   | 0   | 0   | 0   | 0   |
| 2088 | 0   | 0   | 0   | 0   | 0   | 0   | 0   | 0   | 0   | 0   | 0   | 0   | 0   |
| 2089 | 0   | 0   | 0   | 0   | 0   | 0   | 0   | 0   | 0   | 0   | 0   | 0   | 0   |
| 2090 | 0   | 0   | 0   | 0   | 0   | 0   | 0   | 0   | 0   | 0   | 0   | 0   | 0   |

| 12%  | 131 | 132 | 133 | 134 | 135 | 136  | 137  | 138  | 139  | 140  | 141  | 142  | 143  |
|------|-----|-----|-----|-----|-----|------|------|------|------|------|------|------|------|
| 2002 | 0   | 0   | 0   | 0   | 0   | 0    | 0    | 0    | 0    | 0    | 0    | 0    | 0    |
| 2003 | 0   | 0   | 0   | 0   | 0   | 0    | 0    | 0    | 0    | 0    | 0    | 0    | 0    |
| 2004 | 0   | 0   | 0   | 0   | 0   | 0    | 0    | 0    | 0    | 0    | 0    | 0    | 0    |
| 2005 | 0   | 0   | 0   | 0   | 0   | 0    | 0    | 0    | 0    | 0    | 0    | 0    | 0    |
| 2006 | 0   | 0   | 0   | 0   | 0   | 0    | 0    | 0    | 0    | 0    | 0    | 0    | 0    |
| 2007 | 0   | 0   | 0   | 0   | 0   | 0    | 0    | 0    | 0    | 0    | 0    | 0    | 0    |
| 2008 | 0   | 0   | 0   | 0   | 0   | 0    | 0    | 0    | 0    | 0    | 0    | 0    | 0    |
| 2009 | 0   | 0   | 0   | 0   | 0   | 0    | 0    | 0    | 0    | 0    | 0    | 0    | 0    |
| 2010 | 0   | 0   | 0   | 0   | 0   | 0    | 0    | 0    | 0    | 0    | 0    | 0    | 0    |
| 2011 | 0   | 0   | 0   | 0   | 0   | 0    | 0    | 0    | 0    | 0    | 0    | 0    | 0    |
| 2012 | 0   | 0   | 0   | 0   | 0   | 0    | 0    | 0    | 0    | 0    | 0    | 0    | 0    |
| 2013 | 0   | 0   | 0   | 0   | 0   | 0    | 0    | 0    | 0    | 0    | 0    | 0    | 0    |
| 2014 | 0   | 0   | 0   | 0   | 0   | 0    | 0    | 0    | 0    | 0    | 0    | 0    | 0    |
| 2015 | 0   | 0   | 0   | 0   | 0   | 0    | 0    | 0    | 0    | 0    | 0    | 0    | 0    |
| 2016 | 0   | 0   | 0   | 0   | 0   | 0    | 0    | 0    | 0    | 0    | 0    | 0    | 0    |
| 2017 | 0   | 0   | 0   | 0   | 0   | 0    | 0    | 0    | 0    | 0    | 0    | 0    | 0    |
| 2018 | 0   | 0   | 0   | 0   | 0   | 0    | 0    | 0    | 0    | 0    | 0    | 0    | 0    |
| 2019 | 0   | 0   | 0   | 0   | 0   | 0    | 0    | 0    | 0    | 0    | 0    | 0    | 0    |
| 2020 | 0   | 0   | 0   | 0   | 0   | 0    | 0    | 0    | 991  | 0    | 0    | 0    | 0    |
| 2021 | 0   | 0   | 0   | 0   | 0   | 0    | 0    | 0    | 811  | 0    | 0    | 0    | 0    |
| 2022 | 0   | 0   | 0   | 0   | 0   | 0    | 0    | 0    | 928  | 0    | 0    | 0    | 0    |
| 2023 | 0   | 0   | 0   | 0   | 0   | 0    | 0    | 0    | 975  | 0    | 0    | 0    | 0    |
| 2024 | 0   | 0   | 0   | 0   | 0   | 0    | 0    | 0    | 1014 | 0    | 0    | 0    | 0    |
| 2025 | 47  | 246 | 250 | 4   | 66  | 998  | 998  | 0    | 979  | 998  | 998  | 998  | 998  |
| 2026 | 51  | 410 | 339 | 20  | 129 | 764  | 924  | 0    | 1100 | 866  | 866  | 866  | 866  |
| 2027 | 39  | 296 | 351 | 20  | 101 | 831  | 1100 | 0    | 1002 | 913  | 913  | 913  | 913  |
| 2028 | 86  | 425 | 406 | 51  | 140 | 788  | 1026 | 0    | 994  | 936  | 936  | 936  | 936  |
| 2029 | 117 | 491 | 468 | 117 | 250 | 827  | 1076 | 0    | 1030 | 1014 | 1014 | 1014 | 1014 |
| 2030 | 144 | 398 | 507 | 113 | 250 | 967  | 1178 | 998  | 1244 | 1100 | 1100 | 1100 | 1100 |
| 2031 | 144 | 530 | 534 | 66  | 226 | 1014 | 1084 | 932  | 1115 | 1061 | 1061 | 1061 | 1061 |
| 2032 | 164 | 503 | 597 | 113 | 230 | 885  | 1057 | 839  | 1080 | 1053 | 1053 | 1053 | 1053 |
| 2033 | 222 | 347 | 612 | 137 | 324 | 920  | 1092 | 1045 | 1076 | 1041 | 1041 | 1041 | 1037 |
| 2034 | 191 | 519 | 620 | 176 | 371 | 975  | 1186 | 1069 | 1291 | 1030 | 1030 | 1030 | 1006 |
| 2035 | 160 | 503 | 737 | 168 | 351 | 1076 | 1096 | 1225 | 1030 | 1049 | 1049 | 1049 | 1026 |
| 2036 | 187 | 398 | 542 | 133 | 277 | 991  | 1229 | 1151 | 1420 | 1209 | 1260 | 1209 | 1158 |
| 2037 | 195 | 445 | 604 | 160 | 312 | 1158 | 1115 | 1205 | 967  | 1193 | 1147 | 1193 | 1065 |
| 2038 | 215 | 429 | 530 | 144 | 351 | 1037 | 1232 | 1104 | 788  | 1069 | 1193 | 1076 | 850  |
| 2039 | 172 | 437 | 589 | 144 | 296 | 1264 | 1205 | 1123 | 991  | 1201 | 1080 | 1221 | 948  |
| 2040 | 176 | 608 | 589 | 137 | 339 | 1162 | 1205 | 1139 | 1034 | 1154 | 1271 | 1201 | 722  |
| 2041 | 144 | 577 | 714 | 176 | 285 | 1287 | 1236 | 1139 | 753  | 1221 | 1197 | 1310 | 940  |
| 2042 | 148 | 827 | 796 | 160 | 339 | 1135 | 1381 | 1045 | 433  | 1334 | 1318 | 1225 | 870  |
| 2043 | 273 | 554 | 725 | 254 | 367 | 1404 | 1408 | 1104 | 35   | 1092 | 1189 | 1388 | 1080 |
| 2044 | 363 | 530 | 710 | 293 | 410 | 1213 | 1275 | 1041 | 281  | 1369 | 1248 | 1400 | 1022 |
| 2045 | 195 | 620 | 679 | 254 | 445 | 27   | 113  | 1385 | 117  | 4    | 98   | 39   | 39   |
| 2046 | 121 | 632 | 628 | 234 | 371 | 168  | 523  | 1268 | 125  | 456  | 47   | 417  | 417  |
| 2047 | 316 | 409 | 351 | 351 | 351 | 289  | 651  | 1213 | 199  | 410  | 382  | 448  | 449  |
| 2048 | 503 | 363 | 597 | 597 | 597 | 257  | 686  | 277  | 136  | 429  | 468  | 429  | 429  |
| 2049 | 694 | 355 | 573 | 573 | 573 | 222  | 495  | 82   | 20   | 398  | 460  | 359  | 359  |
| 2050 | 523 | 343 | 359 | 359 | 359 | 238  | 406  | 425  | 62   | 324  | 289  | 324  | 324  |
| 2051 | 406 | 304 | 289 | 289 | 289 | 129  | 347  | 636  | 0    | 254  | 289  | 293  | 293  |
| 2052 | 320 | 628 | 413 | 413 | 413 | 144  | 296  | 683  | 0    | 183  | 289  | 222  | 222  |
| 2053 | 347 | 640 | 644 | 644 | 644 | 172  | 117  | 488  | 0    | 199  | 242  | 179  | 179  |
| 2054 | 597 | 480 | 620 | 620 | 620 | 23   | 0    | 312  | 0    | 66   | 140  | 8    | 8    |
| 2055 | 585 | 269 | 359 | 359 | 359 | 47   | 86   | 464  | 0    | 47   | 8    | 55   | 55   |
| 2056 | 417 | 199 | 242 | 242 | 242 | 0    | 4    | 448  | 0    | 8    | 47   | 20   | 19   |
| 2057 | 269 | 82  | 172 | 172 | 172 | 23   | 0    | 308  | 0    | 12   | 0    | 0    | 0    |
| 2058 | 172 | 47  | 82  | 82  | 82  | 0    | 0    | 324  | 0    | 8    | 0    | 0    | 0    |
| 2059 | 82  | 12  | 47  | 47  | 47  | 0    | 0    | 250  | 0    | 0    | 0    | 0    | 0    |

| 12%  | 131 | 132 | 133 | 134 | 135 | 136 | 137 | 138 | 139 | 140 | 141 | 142 | 143 |
|------|-----|-----|-----|-----|-----|-----|-----|-----|-----|-----|-----|-----|-----|
| 2060 | 47  | 4   | 0   | 0   | 0   | 0   | 0   | 187 | 0   | 0   | 0   | 0   | 0   |
| 2061 | 8   | 12  | 0   | 0   | 0   | 0   | 0   | 129 | 0   | 0   | 0   | 0   | 0   |
| 2062 | 0   | 0   | 0   | 0   | 0   | 0   | 0   | 39  | 0   | 0   | 0   | 0   | 0   |
| 2063 | 0   | 0   | 0   | 0   | 0   | 0   | 0   | 0   | 0   | 0   | 0   | 0   | 0   |
| 2064 | 0   | 0   | 0   | 0   | 0   | 0   | 0   | 0   | 0   | 0   | 0   | 0   | 0   |
| 2065 | 0   | 0   | 0   | 0   | 0   | 0   | 0   | 0   | 0   | 0   | 0   | 0   | 0   |
| 2066 | 0   | 0   | 0   | 0   | 0   | 0   | 0   | 0   | 0   | 0   | 0   | 0   | 0   |
| 2067 | 0   | 0   | 0   | 0   | 0   | 0   | 0   | 0   | 0   | 0   | 0   | 0   | 0   |
| 2068 | 0   | 0   | 0   | 0   | 0   | 0   | 0   | 0   | 0   | 0   | 0   | 0   | 0   |
| 2069 | 0   | 0   | 0   | 0   | 0   | 0   | 0   | 0   | 0   | 0   | 0   | 0   | 0   |
| 2070 | 0   | 0   | 0   | 0   | 0   | 0   | 0   | 0   | 0   | 0   | 0   | 0   | 0   |
| 2071 | 0   | 0   | 0   | 0   | 0   | 0   | 0   | 0   | 0   | 0   | 0   | 0   | 0   |
| 2072 | 0   | 0   | 0   | 0   | 0   | 0   | 0   | 0   | 0   | 0   | 0   | 0   | 0   |
| 2073 | 0   | 0   | 0   | 0   | 0   | 0   | 0   | 0   | 0   | 0   | 0   | 0   | 0   |
| 2074 | 0   | 0   | 0   | 0   | 0   | 0   | 0   | 0   | 0   | 0   | 0   | 0   | 0   |
| 2075 | 0   | 0   | 0   | 0   | 0   | 0   | 0   | 0   | 0   | 0   | 0   | 0   | 0   |
| 2076 | 0   | 0   | 0   | 0   | 0   | 0   | 0   | 0   | 0   | 0   | 0   | 0   | 0   |
| 2077 | 0   | 0   | 0   | 0   | 0   | 0   | 0   | 0   | 0   | 0   | 0   | 0   | 0   |
| 2078 | 0   | 0   | 0   | 0   | 0   | 0   | 0   | 0   | 0   | 0   | 0   | 0   | 0   |
| 2079 | 0   | 0   | 0   | 0   | 0   | 0   | 0   | 0   | 0   | 0   | 0   | 0   | 0   |
| 2080 | 0   | 0   | 0   | 0   | 0   | 0   | 0   | 0   | 0   | 0   | 0   | 0   | 0   |
| 2081 | 0   | 0   | 0   | 0   | 0   | 0   | 0   | 0   | 0   | 0   | 0   | 0   | 0   |
| 2082 | 0   | 0   | 0   | 0   | 0   | 0   | 0   | 0   | 0   | 0   | 0   | 0   | 0   |
| 2083 | 0   | 0   | 0   | 0   | 0   | 0   | 0   | 0   | 0   | 0   | 0   | 0   | 0   |
| 2084 | 0   | 0   | 0   | 0   | 0   | 0   | 0   | 0   | 0   | 0   | 0   | 0   | 0   |
| 2085 | 0   | 0   | 0   | 0   | 0   | 0   | 0   | 0   | 0   | 0   | 0   | 0   | 0   |
| 2086 | 0   | 0   | 0   | 0   | 0   | 0   | 0   | 0   | 0   | 0   | 0   | 0   | 0   |
| 2087 | 0   | 0   | 0   | 0   | 0   | 0   | 0   | 0   | 0   | 0   | 0   | 0   | 0   |
| 2088 | 0   | 0   | 0   | 0   | 0   | 0   | 0   | 0   | 0   | 0   | 0   | 0   | 0   |
| 2089 | 0   | 0   | 0   | 0   | 0   | 0   | 0   | 0   | 0   | 0   | 0   | 0   | 0   |
| 2090 | 0   | 0   | 0   | 0   | 0   | 0   | 0   | 0   | 0   | 0   | 0   | 0   | 0   |

| 12%  | 144  | 145 | 146 | 147 | 148 | 149 | 150 | 151  | 152 | 153 | 154 | 155 | 156 |
|------|------|-----|-----|-----|-----|-----|-----|------|-----|-----|-----|-----|-----|
| 2002 | 0    | 0   | 0   | 0   | 0   | 0   | 0   | 0    | 0   | 0   | 0   | 0   | 0   |
| 2003 | 0    | 0   | 0   | 0   | 0   | 0   | 0   | 0    | 0   | 0   | 0   | 0   | 0   |
| 2004 | 0    | 0   | 0   | 0   | 0   | 0   | 0   | 0    | 0   | 0   | 0   | 0   | 0   |
| 2005 | 0    | 0   | 0   | 0   | 0   | 0   | 0   | 0    | 0   | 0   | 0   | 0   | 0   |
| 2006 | 0    | 0   | 0   | 0   | 0   | 0   | 0   | 0    | 0   | 0   | 0   | 0   | 0   |
| 2007 | 0    | 0   | 0   | 0   | 0   | 0   | 0   | 0    | 0   | 0   | 0   | 0   | 0   |
| 2008 | 0    | 0   | 0   | 0   | 0   | 0   | 0   | 0    | 0   | 0   | 0   | 0   | 0   |
| 2009 | 0    | 0   | 0   | 0   | 0   | 0   | 0   | 0    | 0   | 0   | 0   | 0   | 0   |
| 2010 | 0    | 0   | 0   | 0   | 0   | 0   | 0   | 0    | 0   | 0   | 0   | 0   | 0   |
| 2011 | 0    | 0   | 0   | 0   | 0   | 0   | 0   | 0    | 0   | 0   | 0   | 0   | 0   |
| 2012 | 0    | 0   | 0   | 0   | 0   | 0   | 0   | 0    | 0   | 0   | 0   | 0   | 0   |
| 2013 | 0    | 0   | 0   | 0   | 0   | 0   | 0   | 0    | 0   | 0   | 0   | 0   | 0   |
| 2014 | 0    | 0   | 0   | 0   | 0   | 0   | 0   | 0    | 0   | 0   | 0   | 0   | 0   |
| 2015 | 0    | 0   | 0   | 0   | 0   | 0   | 0   | 0    | 0   | 0   | 0   | 0   | 0   |
| 2016 | 0    | 0   | 0   | 0   | 0   | 0   | 0   | 0    | 0   | 0   | 0   | 0   | 0   |
| 2017 | 0    | 0   | 0   | 0   | 0   | 0   | 0   | 0    | 0   | 0   | 0   | 0   | 0   |
| 2018 | 0    | 0   | 0   | 0   | 0   | 0   | 0   | 0    | 0   | 0   | 0   | 0   | 0   |
| 2019 | 0    | 0   | 0   | 0   | 0   | 0   | 0   | 0    | 0   | 0   | 0   | 0   | 0   |
| 2020 | 0    | 0   | 0   | 0   | 351 | 0   | 0   | 0    | 0   | 0   | 0   | 0   | 0   |
| 2021 | 0    | 0   | 0   | 0   | 257 | 0   | 0   | 0    | 0   | 0   | 0   | 0   | 0   |
| 2022 | 0    | 0   | 0   | 0   | 441 | 0   | 0   | 0    | 0   | 0   | 0   | 0   | 0   |
| 2023 | 0    | 0   | 0   | 0   | 499 | 0   | 0   | 0    | 0   | 0   | 0   | 0   | 0   |
| 2024 | 0    | 0   | 0   | 0   | 562 | 0   | 0   | 0    | 0   | 0   | 0   | 0   | 0   |
| 2025 | 998  | 277 | 277 | 0   | 577 | 250 | 679 | 952  | 16  | 277 | 66  | 66  | 0   |
| 2026 | 866  | 172 | 480 | 0   | 608 | 250 | 581 | 839  | 23  | 328 | 12  | 273 | 0   |
| 2027 | 913  | 285 | 464 | 0   | 659 | 320 | 659 | 913  | 23  | 371 | 78  | 215 | 0   |
| 2028 | 936  | 386 | 768 | 0   | 725 | 566 | 807 | 1100 | 43  | 612 | 105 | 382 | 0   |
| 2029 | 1014 | 456 | 702 | 0   | 757 | 620 | 874 | 1193 | 187 | 663 | 273 | 523 | 0   |
| 2030 | 1100 | 523 | 737 | 257 | 737 | 632 | 749 | 1088 | 195 | 597 | 234 | 495 | 39  |
| 2031 | 1061 | 850 | 878 | 527 | 714 | 768 | 655 | 1112 | 222 | 803 | 417 | 445 | 277 |
| 2032 | 1053 | 667 | 799 | 421 | 823 | 655 | 718 | 1037 | 215 | 647 | 390 | 534 | 242 |
| 2033 | 1041 | 616 | 831 | 534 | 655 | 702 | 573 | 1014 | 226 | 710 | 261 | 476 | 312 |
| 2034 | 1030 | 729 | 839 | 780 | 792 | 741 | 753 | 1174 | 320 | 800 | 371 | 484 | 507 |
| 2035 | 1049 | 741 | 835 | 944 | 725 | 807 | 651 | 1119 | 273 | 800 | 300 | 429 | 667 |
| 2036 | 1209 | 714 | 799 | 850 | 573 | 792 | 772 | 1006 | 378 | 745 | 441 | 503 | 612 |
| 2037 | 1193 | 651 | 679 | 772 | 616 | 686 | 714 | 917  | 296 | 690 | 339 | 320 | 538 |
| 2038 | 1076 | 647 | 698 | 842 | 550 | 655 | 686 | 831  | 296 | 628 | 394 | 503 | 554 |
| 2039 | 1221 | 655 | 655 | 800 | 468 | 616 | 725 | 889  | 277 | 694 | 449 | 429 | 527 |
| 2040 | 1201 | 663 | 628 | 573 | 374 | 624 | 686 | 874  | 234 | 671 | 382 | 402 | 429 |
| 2041 | 1299 | 546 | 608 | 858 | 511 | 702 | 749 | 897  | 285 | 612 | 289 | 304 | 589 |
| 2042 | 1193 | 671 | 655 | 850 | 464 | 737 | 698 | 920  | 277 | 679 | 472 | 449 | 468 |
| 2043 | 1322 | 581 | 667 | 850 | 472 | 597 | 523 | 725  | 254 | 589 | 421 | 425 | 589 |
| 2044 | 1310 | 495 | 565 | 706 | 382 | 519 | 550 | 620  | 215 | 558 | 304 | 347 | 503 |
| 2045 | 39   | 398 | 476 | 655 | 82  | 460 | 581 | 597  | 269 | 488 | 363 | 495 | 355 |
| 2046 | 417  | 456 | 378 | 640 | 0   | 421 | 671 | 503  | 179 | 386 | 51  | 160 | 456 |
| 2047 | 449  | 293 | 406 | 589 | 156 | 105 | 277 | 546  | 125 | 343 | 55  | 55  | 456 |
| 2048 | 429  | 0   | 16  | 449 | 293 | 0   | 0   | 8    | 8   | 8   | 90  | 480 | 86  |
| 2049 | 359  | 82  | 491 | 125 | 335 | 246 | 269 | 207  | 207 | 207 | 269 | 768 | 133 |
| 2050 | 324  | 109 | 725 | 12  | 82  | 410 | 460 | 394  | 394 | 394 | 406 | 788 | 312 |
| 2051 | 293  | 254 | 753 | 300 | 70  | 608 | 671 | 663  | 663 | 663 | 320 | 628 | 378 |
| 2052 | 222  | 413 | 644 | 417 | 78  | 620 | 472 | 558  | 558 | 558 | 148 | 413 | 530 |
| 2053 | 179  | 293 | 452 | 597 | 47  | 378 | 304 | 312  | 312 | 312 | 105 | 218 | 768 |
| 2054 | 8    | 137 | 218 | 737 | 16  | 273 | 176 | 273  | 273 | 273 | 90  | 148 | 858 |
| 2055 | 55   | 105 | 148 | 753 | 0   | 172 | 152 | 172  | 172 | 172 | 78  | 82  | 659 |
| 2056 | 20   | 90  | 82  | 640 | 0   | 82  | 82  | 82   | 82  | 82  | 31  | 78  | 406 |
| 2057 | 0    | 78  | 78  | 480 | 0   | 47  | 47  | 47   | 47  | 47  | 0   | 0   | 261 |
| 2058 | 0    | 31  | 39  | 300 | 0   | 39  | 0   | 39   | 39  | 39  | 0   | 0   | 199 |
| 2059 | 0    | 0   | 27  | 207 | 0   | 0   | 0   | 8    | 8   | 8   | 0   | 0   | 101 |

| 12%  | 144 | 145 | 146 | 147 | 148 | 149 | 150 | 151 | 152 | 153 | 154 | 155 | 156 |
|------|-----|-----|-----|-----|-----|-----|-----|-----|-----|-----|-----|-----|-----|
| 2060 | 0   | 0   | 0   | 86  | 0   | 0   | 0   | 0   | 0   | 0   | 0   | 0   | 59  |
| 2061 | 0   | 0   | 0   | 59  | 0   | 0   | 0   | 0   | 0   | 0   | 0   | 0   | 39  |
| 2062 | 0   | 0   | 0   | 39  | 0   | 0   | 0   | 0   | 0   | 0   | 0   | 0   | 39  |
| 2063 | 0   | 0   | 0   | 39  | 0   | 0   | 0   | 0   | 0   | 0   | 0   | 0   | 0   |
| 2064 | 0   | 0   | 0   | 0   | 0   | 0   | 0   | 0   | 0   | 0   | 0   | 0   | 0   |
| 2065 | 0   | 0   | 0   | 0   | 0   | 0   | 0   | 0   | 0   | 0   | 0   | 0   | 0   |
| 2066 | 0   | 0   | 0   | 0   | 0   | 0   | 0   | 0   | 0   | 0   | 0   | 0   | 0   |
| 2067 | 0   | 0   | 0   | 0   | 0   | 0   | 0   | 0   | 0   | 0   | 0   | 0   | 0   |
| 2068 | 0   | 0   | 0   | 0   | 0   | 0   | 0   | 0   | 0   | 0   | 0   | 0   | 0   |
| 2069 | 0   | 0   | 0   | 0   | 0   | 0   | 0   | 0   | 0   | 0   | 0   | 0   | 0   |
| 2070 | 0   | 0   | 0   | 0   | 0   | 0   | 0   | 0   | 0   | 0   | 0   | 0   | 0   |
| 2071 | 0   | 0   | 0   | 0   | 0   | 0   | 0   | 0   | 0   | 0   | 0   | 0   | 0   |
| 2072 | 0   | 0   | 0   | 0   | 0   | 0   | 0   | 0   | 0   | 0   | 0   | 0   | 0   |
| 2073 | 0   | 0   | 0   | 0   | 0   | 0   | 0   | 0   | 0   | 0   | 0   | 0   | 0   |
| 2074 | 0   | 0   | 0   | 0   | 0   | 0   | 0   | 0   | 0   | 0   | 0   | 0   | 0   |
| 2075 | 0   | 0   | 0   | 0   | 0   | 0   | 0   | 0   | 0   | 0   | 0   | 0   | 0   |
| 2076 | 0   | 0   | 0   | 0   | 0   | 0   | 0   | 0   | 0   | 0   | 0   | 0   | 0   |
| 2077 | 0   | 0   | 0   | 0   | 0   | 0   | 0   | 0   | 0   | 0   | 0   | 0   | 0   |
| 2078 | 0   | 0   | 0   | 0   | 0   | 0   | 0   | 0   | 0   | 0   | 0   | 0   | 0   |
| 2079 | 0   | 0   | 0   | 0   | 0   | 0   | 0   | 0   | 0   | 0   | 0   | 0   | 0   |
| 2080 | 0   | 0   | 0   | 0   | 0   | 0   | 0   | 0   | 0   | 0   | 0   | 0   | 0   |
| 2081 | 0   | 0   | 0   | 0   | 0   | 0   | 0   | 0   | 0   | 0   | 0   | 0   | 0   |
| 2082 | 0   | 0   | 0   | 0   | 0   | 0   | 0   | 0   | 0   | 0   | 0   | 0   | 0   |
| 2083 | 0   | 0   | 0   | 0   | 0   | 0   | 0   | 0   | 0   | 0   | 0   | 0   | 0   |
| 2084 | 0   | 0   | 0   | 0   | 0   | 0   | 0   | 0   | 0   | 0   | 0   | 0   | 0   |
| 2085 | 0   | 0   | 0   | 0   | 0   | 0   | 0   | 0   | 0   | 0   | 0   | 0   | 0   |
| 2086 | 0   | 0   | 0   | 0   | 0   | 0   | 0   | 0   | 0   | 0   | 0   | 0   | 0   |
| 2087 | 0   | 0   | 0   | 0   | 0   | 0   | 0   | 0   | 0   | 0   | 0   | 0   | 0   |
| 2088 | 0   | 0   | 0   | 0   | 0   | 0   | 0   | 0   | 0   | 0   | 0   | 0   | 0   |
| 2089 | 0   | 0   | 0   | 0   | 0   | 0   | 0   | 0   | 0   | 0   | 0   | 0   | 0   |
| 2090 | 0   | 0   | 0   | 0   | 0   | 0   | 0   | 0   | 0   | 0   | 0   | 0   | 0   |

| 12%  | 157 | 158 | 159 | 160 | 161 | 162 |
|------|-----|-----|-----|-----|-----|-----|
| 2002 | 0   | 0   | 0   | 0   | 0   | 0   |
| 2003 | 0   | 0   | 0   | 0   | 0   | 0   |
| 2004 | 0   | 0   | 0   | 0   | 0   | 0   |
| 2005 | 0   | 0   | 0   | 0   | 0   | 0   |
| 2006 | 0   | 0   | 0   | 0   | 0   | 0   |
| 2007 | 0   | 0   | 0   | 0   | 0   | 0   |
| 2008 | 0   | 0   | 0   | 0   | 0   | 0   |
| 2009 | 0   | 0   | 0   | 0   | 0   | 0   |
| 2010 | 0   | 0   | 0   | 0   | 0   | 0   |
| 2011 | 0   | 0   | 0   | 0   | 0   | 0   |
| 2012 | 0   | 0   | 0   | 0   | 0   | 0   |
| 2013 | 0   | 0   | 0   | 0   | 0   | 0   |
| 2014 | 0   | 0   | 0   | 0   | 0   | 0   |
| 2015 | 0   | 0   | 0   | 0   | 0   | 0   |
| 2016 | 0   | 0   | 0   | 0   | 0   | 0   |
| 2017 | 0   | 0   | 0   | 0   | 0   | 0   |
| 2018 | 0   | 0   | 0   | 0   | 0   | 0   |
| 2019 | 0   | 0   | 0   | 0   | 0   | 0   |
| 2020 | 39  | 0   | 0   | 0   | 0   | 0   |
| 2021 | 39  | 0   | 0   | 0   | 0   | 0   |
| 2022 | 94  | 0   | 0   | 0   | 0   | 0   |
| 2023 | 203 | 0   | 0   | 0   | 0   | 0   |
| 2024 | 199 | 0   | 0   | 0   | 0   | 0   |
| 2025 | 281 | 47  | 246 | 250 | 4   | 66  |
| 2026 | 273 | 31  | 394 | 328 | 0   | 105 |
| 2027 | 281 | 59  | 363 | 437 | 4   | 140 |
| 2028 | 234 | 168 | 733 | 655 | 20  | 296 |
| 2029 | 277 | 293 | 772 | 729 | 43  | 441 |
| 2030 | 343 | 230 | 550 | 608 | 94  | 367 |
| 2031 | 300 | 238 | 605 | 702 | 78  | 371 |
| 2032 | 413 | 250 | 581 | 683 | 98  | 374 |
| 2033 | 316 | 199 | 390 | 608 | 176 | 359 |
| 2034 | 378 | 328 | 604 | 741 | 211 | 441 |
| 2035 | 293 | 296 | 499 | 784 | 207 | 406 |
| 2036 | 433 | 402 | 616 | 745 | 238 | 452 |
| 2037 | 324 | 324 | 515 | 749 | 191 | 332 |
| 2038 | 355 | 277 | 538 | 757 | 277 | 456 |
| 2039 | 238 | 242 | 421 | 780 | 226 | 452 |
| 2040 | 281 | 230 | 663 | 757 | 203 | 406 |
| 2041 | 367 | 265 | 519 | 776 | 211 | 300 |
| 2042 | 452 | 238 | 823 | 940 | 176 | 464 |
| 2043 | 214 | 378 | 534 | 749 | 277 | 429 |
| 2044 | 55  | 250 | 632 | 764 | 187 | 331 |
| 2045 | 140 | 285 | 632 | 729 | 215 | 429 |
| 2046 | 218 | 78  | 109 | 74  | 74  | 74  |
| 2047 | 367 | 39  | 90  | 211 | 211 | 211 |
| 2048 | 129 | 195 | 335 | 398 | 398 | 398 |
| 2049 | 70  | 359 | 413 | 620 | 620 | 620 |
| 2050 | 47  | 667 | 640 | 585 | 585 | 585 |
| 2051 | 39  | 554 | 413 | 386 | 386 | 386 |
| 2052 | 0   | 351 | 257 | 265 | 265 | 265 |
| 2053 | 0   | 254 | 176 | 172 | 172 | 172 |
| 2054 | 0   | 152 | 152 | 82  | 82  | 82  |
| 2055 | 0   | 82  | 82  | 47  | 47  | 47  |
| 2056 | 0   | 47  | 47  | 39  | 39  | 39  |
| 2057 | 0   | 39  | 39  | 8   | 8   | 8   |
| 2058 | 0   | 8   | 0   | 0   | 0   | 0   |
| 2059 | 0   | 0   | 0   | 0   | 0   | 0   |

| 12%  | 157 | 158 | 159 | 160 | 161 | 162 |
|------|-----|-----|-----|-----|-----|-----|
| 2060 | 0   | 0   | 0   | 0   | 0   | 0   |
| 2061 | 0   | 0   | 0   | 0   | 0   | 0   |
| 2062 | 0   | 0   | 0   | 0   | 0   | 0   |
| 2063 | 0   | 0   | 0   | 0   | 0   | 0   |
| 2064 | 0   | 0   | 0   | 0   | 0   | 0   |
| 2065 | 0   | 0   | 0   | 0   | 0   | 0   |
| 2066 | 0   | 0   | 0   | 0   | 0   | 0   |
| 2067 | 0   | 0   | 0   | 0   | 0   | 0   |
| 2068 | 0   | 0   | 0   | 0   | 0   | 0   |
| 2069 | 0   | 0   | 0   | 0   | 0   | 0   |
| 2070 | 0   | 0   | 0   | 0   | 0   | 0   |
| 2071 | 0   | 0   | 0   | 0   | 0   | 0   |
| 2072 | 0   | 0   | 0   | 0   | 0   | 0   |
| 2073 | 0   | 0   | 0   | 0   | 0   | 0   |
| 2074 | 0   | 0   | 0   | 0   | 0   | 0   |
| 2075 | 0   | 0   | 0   | 0   | 0   | 0   |
| 2076 | 0   | 0   | 0   | 0   | 0   | 0   |
| 2077 | 0   | 0   | 0   | 0   | 0   | 0   |
| 2078 | 0   | 0   | 0   | 0   | 0   | 0   |
| 2079 | 0   | 0   | 0   | 0   | 0   | 0   |
| 2080 | 0   | 0   | 0   | 0   | 0   | 0   |
| 2081 | 0   | 0   | 0   | 0   | 0   | 0   |
| 2082 | 0   | 0   | 0   | 0   | 0   | 0   |
| 2083 | 0   | 0   | 0   | 0   | 0   | 0   |
| 2084 | 0   | 0   | 0   | 0   | 0   | 0   |
| 2085 | 0   | 0   | 0   | 0   | 0   | 0   |
| 2086 | 0   | 0   | 0   | 0   | 0   | 0   |
| 2087 | 0   | 0   | 0   | 0   | 0   | 0   |
| 2088 | 0   | 0   | 0   | 0   | 0   | 0   |
| 2089 | 0   | 0   | 0   | 0   | 0   | 0   |
| 2090 | 0   | 0   | 0   | 0   | 0   | 0   |